

BHEL SKILL TEST – 2026

Trade – Turner

08\04\2026

Time: 1hrs

Marks: 100

Q. Prepare the job as per drawing below:

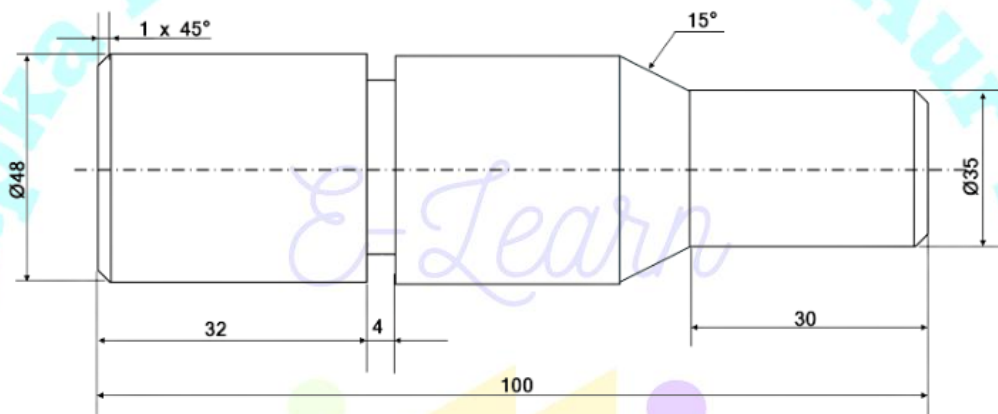

Raw Material = $\varnothing 50 \times 105$ mm

Tolerance: ± 0.02 mm

Note Dimensions are in mm.

Solution and Explanation on
You Tube Channel

