

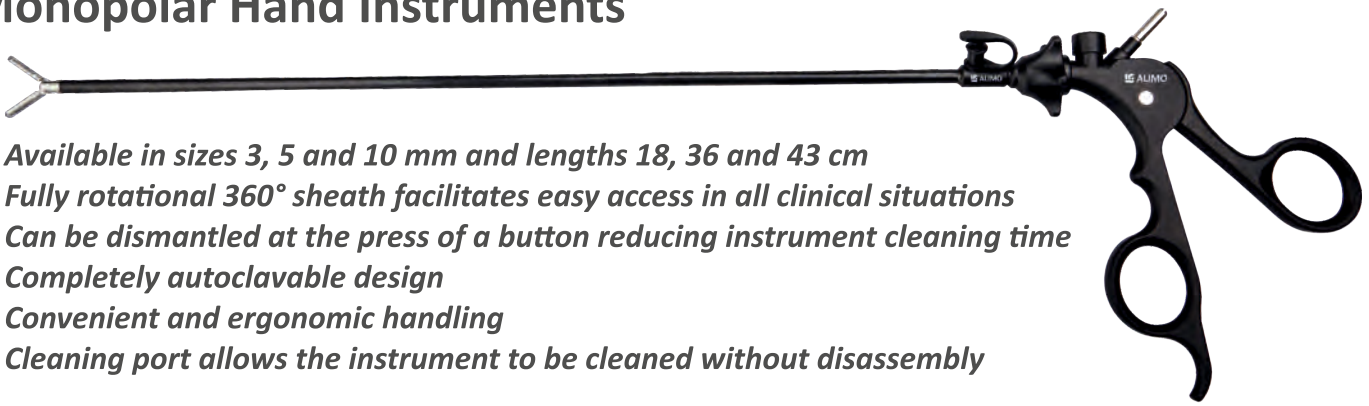

REUSABLE |
LAPAROSCOPIC |
INSTRUMENTS |

Monopolar Hand Instruments



- Available in sizes 3, 5 and 10 mm and lengths 18, 36 and 43 cm
- Fully rotational 360° sheath facilitates easy access in all clinical situations
- Can be dismantled at the press of a button reducing instrument cleaning time
- Completely autoclavable design
- Convenient and ergonomic handling
- Cleaning port allows the instrument to be cleaned without disassembly

Insert



Shaft



Product Code

Description

A172-5SH003

Shaft - 5mm

A172-0SH004

Shaft - 10 mm

Handles



Product Code

Description

A172-5HP004

Monopolar Plastic Handle without Ratchet



Product Code

Description

A172-5HP005

Monopolar Plastic Handle with Ratchet



Product Code

Description

A172-5HM006

Monopolar Metal Handle without Ratchet























Product Code

Description



A172-5HM007

Monopolar Metal Handle with Ratchet

Dissecting and Grasping Forceps

	Description	Specs	Product Code
	KELLY Dissecting and Grasping Forceps, Maryland	φ5X360	A112-5MC014
	KELLY Dissecting and Grasping Forceps, Medium, Maryland	φ5X360	A112-5MC017
	KELLY Dissecting and Grasping Forceps, Long, Maryland	φ5X360	A112-5MC020
	Dissecting and Grasping Forceps, Right-Angled	φ5X360	A112-5RA014
	Straight Dissecting and Grasping Forceps	φ5X360	A112-5SD017
	Bowel Grasper, Fenestrated, Short	φ5X360	A112-5BG018
	Bowel Grasper, Fenestrated	φ5X360	A112-5BG035
	CROCE-OLMI Grasping Forceps, Atraumatic, Curved	φ5X360	A112-5CB023
	Atraumatic Grasping Forceps	φ5X360	A112-5AG022
	BABCOCK Grasping Forceps	φ5X360	A112-5BC015
	Grasping Forceps 2X4 Teeth Double Action	φ5X360	A112-5TG015
	Grasping Forceps 2X4 Teeth Single Action	φ5X360	A112-5TS015
	Tenaculum Forceps	φ5X360	A112-5TC015
	Dissecting and Grasping Forceps Reddick-Olsen	φ5X360	A112-ROC015
	Dissecting and Grasping Forceps Alligator Jaws	φ5X360	A112-5AJ016
	DeBAKEY Grasping Forceps Curved and Slender Jaws	φ5X360	A112-5DK025
	Dissecting and Grasping Forceps Duckbill	φ5X360	A112-5DB014
	Grasping Forceps, Atraumatic	φ5X360	A112-5AG028
	Biopsy Forceps	φ5X360	A112-5BF015
	Grasping Forceps Atraumatic Spoon-Shaped	φ5X360	A112-5GS018

Monopolar Scissors

	Description	Specs	Product Code
	METZENBAUM Scissors Curved	φ5X360	A112-5SC014
	Hook Scissors	φ5X360	A112-5SH019
	Scissors Straight	φ5X360	A112-5SS015

Bipolar Forceps

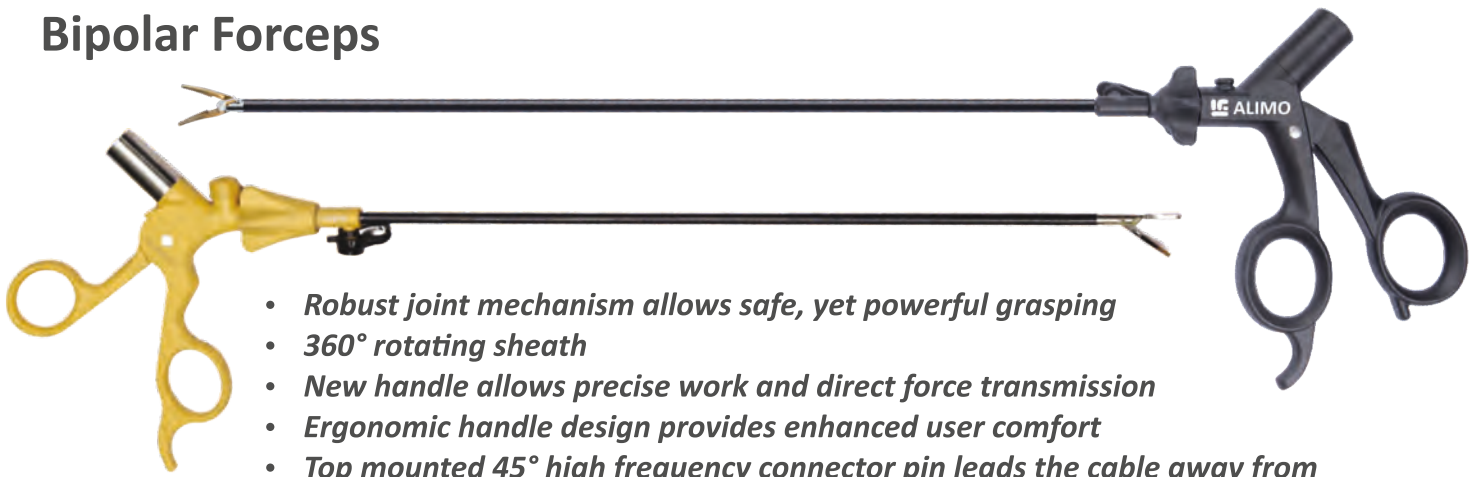

- Robust joint mechanism allows safe, yet powerful grasping
- 360° rotating sheath
- New handle allows precise work and direct force transmission
- Ergonomic handle design provides enhanced user comfort
- Top mounted 45° high frequency connector pin leads the cable away from the operative field
- The instruments in sizes 3 mm and 5 mm can be disassembled into a handle and working insert with outer sheath

Insert



Shaft



Product Code

Description

A172-5BI005

Bipolar Shaft - 5mm

Handle



Product Code

Description

A172-5BI006

Bipolar Handle



Product Code

Description

A172-5BI007



Sealer Handle

Bipolar Forceps

	Description	Specs	Product Code
	Bipolar Forceps - Straight	Φ5 X 330mm	A112-5BI501
	Bipolar Forceps - Curved	Φ5 X 330mm	A112-5BI502
	Vessel Sealer Cutter - Blunt	Φ5 X 330mm	A112-5BI503
	Vessel Sealer Cutter - Round	Φ5 X 330mm	A112-5BI504

Monopolar Electrodes



Description	Specs	Product Code
 L Hook Electrode	Φ5 X 330mm	A114-5EL421
 Spatula Electrode	Φ5 X 330mm	A114-5ES422
 Rod Tip Electrode	Φ5 X 330mm	A114-5ER423

Trocars



Description	Specs	Product Code
Trocar with Cannula - Metal Flip Cap - 12.5mm	Φ12.5 X 95mm	A114-2TM951
Trocar with Cannula - Metal Flip Cap - 10.5mm	Φ10.5 X 95mm	A114-0TM952
Trocar with Cannula - Metal Flip Cap - 5.5mm	Φ5.5 X 95mm	A114-5TM953
Trocar with Cannula - Multifunctional Valve - 10mm - Bariatric	Φ10 X 150mm	A114-0TB851
Trocar with Cannula - Multifunctional Valve - 10mm - Threaded	Φ10 X 95mm	A114-0TB852
Trocar with Cannula - Multifunctional Valve - 10mm	Φ10 X 95mm	A114-0TB853
Trocar with Cannula - Multifunctional Valve - 7mm	Φ7 X 95mm	A114-7TB861
Trocar with Cannula - Multifunctional Valve - 5mm - Bariatric	Φ5 X 150mm	A114-5TB871
Trocar with Cannula - Multifunctional Valve - 5mm - Threaded	Φ5 X 95mm	A114-5TB872
Trocar with Cannula - Multifunctional Valve - 5mm	Φ5 X 95mm	A114-5TB873
Trocar with Cannula - Multifunctional Valve - 5mm Short	Φ5 X 70mm	A114-5TB874
Trocar with Cannula - Multifunctional Valve - 3mm	Φ3 X 70mm	A114-3TB881
Trocar with Cannula - Multifunctional Valve - 3mm Micro	Φ3 X 50mm	A114-3TB882

Needle Holders

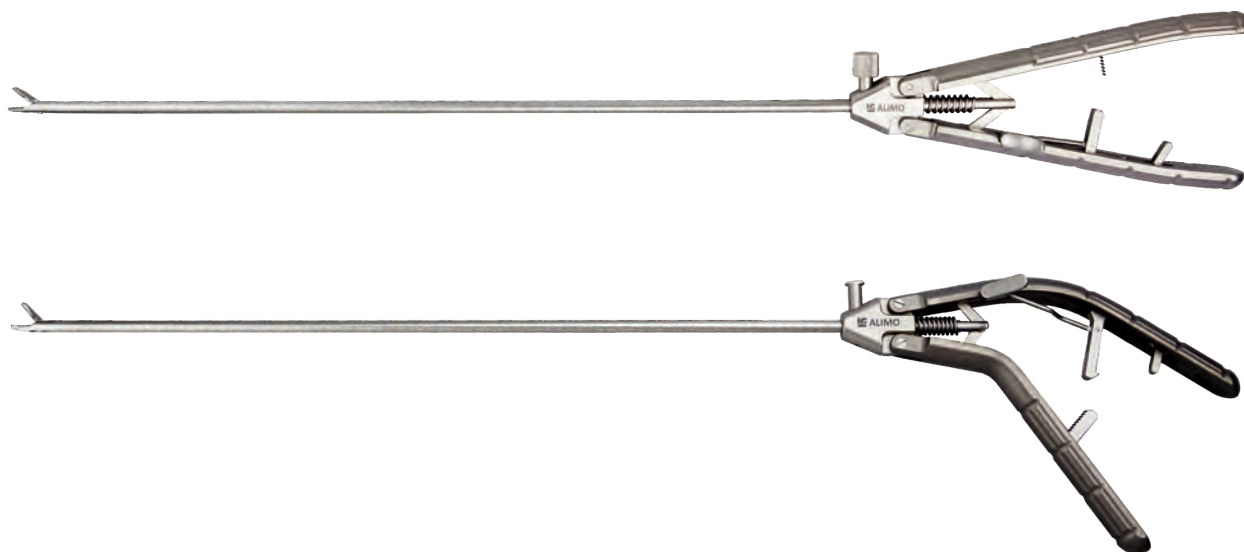

Description	Specs	Product Code
A Handle Needle Holder - Straight	Φ5 X 330mm	A114-5AN801
A Handle Needle Holder - Left Curved	Φ5 X 330mm	A114-5AN802
Pistol Handle Needle Holder - Straight	Φ5 X 330mm	A114-5PN803
Pistol Handle Needle Holder - Left Curved	Φ5 X 330mm	A114-5PN804
Pistol Handle Needle Holder - Reposition	Φ5 X 330mm	A114-5PN805
V Handle Needle Holder - Straight	Φ5 X 330mm	A114-5VN806
V Handle Needle Holder - Left Curved	Φ5 X 330mm	A114-5VN807
V Handle Needle Holder - Reposition	Φ5 X 330mm	A114-5VN808

Veress Needle



Description	Specs	Product Code
Veress Needle	Φ2.2 X 110mm	A114-2VN110
Veress Needle	Φ2.2 X 120mm	A114-2VN120
Veress Needle	Φ2.2 X 150mm	A114-2VN150

Clip Appliers



Description	Specs	Product Code
Hemolock Clip Appliers - Medium	Φ5 X 330mm	A114-5HL701
Hemolock Clip Appliers - Large	Φ10 X 330mm	A114-0HL702
Hemolock Clip Appliers - Extra Large	Φ10 X 330mm	A114-0HL703
Titanium Clip Applier - Small	Φ5 X 330mm	A114-5TC704
Titanium Clip Applier - Medium	Φ10 X 330mm	A114-0TC705
Titanium Clip Applier - Medium Large	Φ10 X 330mm	A114-0TC706
Titanium Clip Applier - Large	Φ10 X 330mm	A114-0TC707

Suction and Irrigation

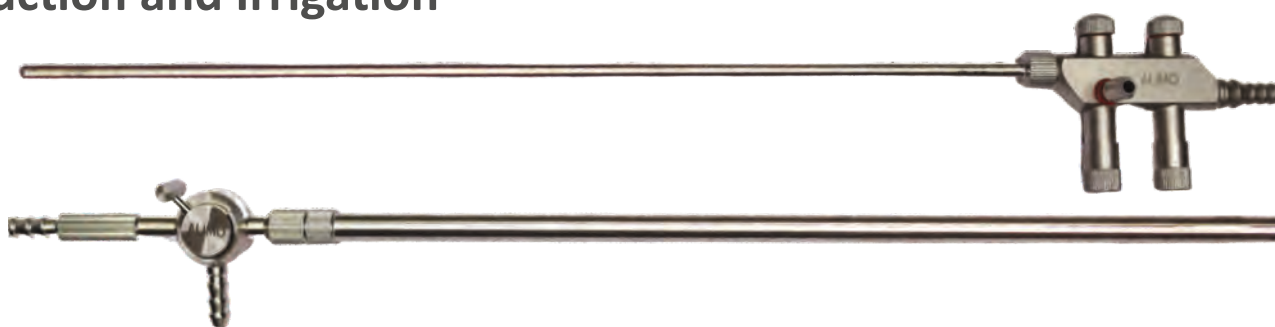

Description	Specs	Product Code
Suction & Irrigation - Valve	Φ5 X 330mm	A114-5SP401
Suction & Irrigation - Valve	Φ10 X 330mm	A114-0SP402
Suction & Irrigation - Trumpet	Φ5 X 330mm	A114-5ST403
Suction & Irrigation - Trumpet	Φ10 X 330mm	A114-0ST404

Integrated Hysteroscopy



2.9mm & 4mm Hysteroscopy



- High Magnification HD optics
- Laser welded joints
- Sapphire tip for long life
- Medical grade stainless steel tube & body

- Continuous flow for better vision
- Tear drop shape sheath- less dilatation
- Working Channel - 5 FR
- Quick lock mechanism



Description	Specs	Product Code
Integrated Hysteroscope	φ5*205mm, 30°	A105-5HS301
2.9mm 30 Degree Hysteroscope	φ5*205mm, 30°	A105-2HS302
Outer Sheath with Obturator	φ6.2*185mm	A114-2HS303
Inner Sheath	φ5.4*200mm	A114-2HS304
4mm 30 Degree Hysteroscope	φ5*205mm, 30°	A105-4HS305
Outer Sheath with Obturator	φ7.5*185mm	A114-4HS306
Inner Sheath	φ6.3*200mm	A114-4HS307
Grasping Forceps	5Fr, φ1.6x400mm	A114-5HS351
Scissors Straight Single Action	5Fr, φ1.6x400mm	A114-5HS352
Biopsy Forceps	5Fr, φ1.6x400mm	A114-5HS353
Tenaculum Forceps	5Fr, φ1.6x400mm	A114-5HS354

Bipolar Resectoscope

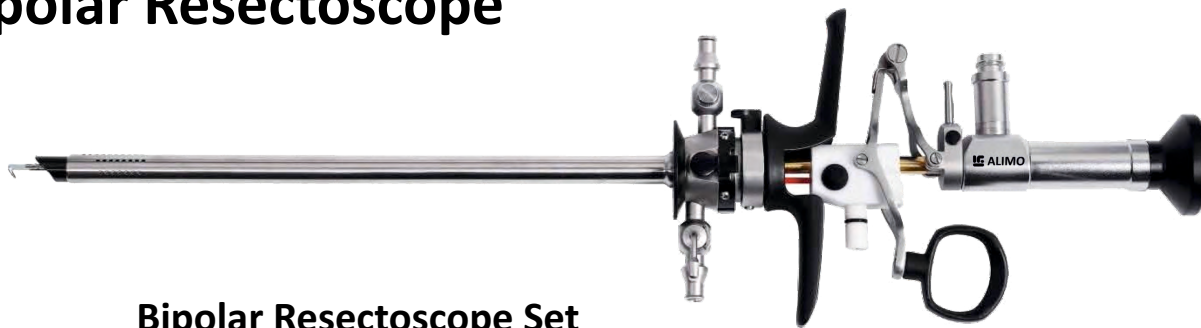

Bipolar Resectoscope Set

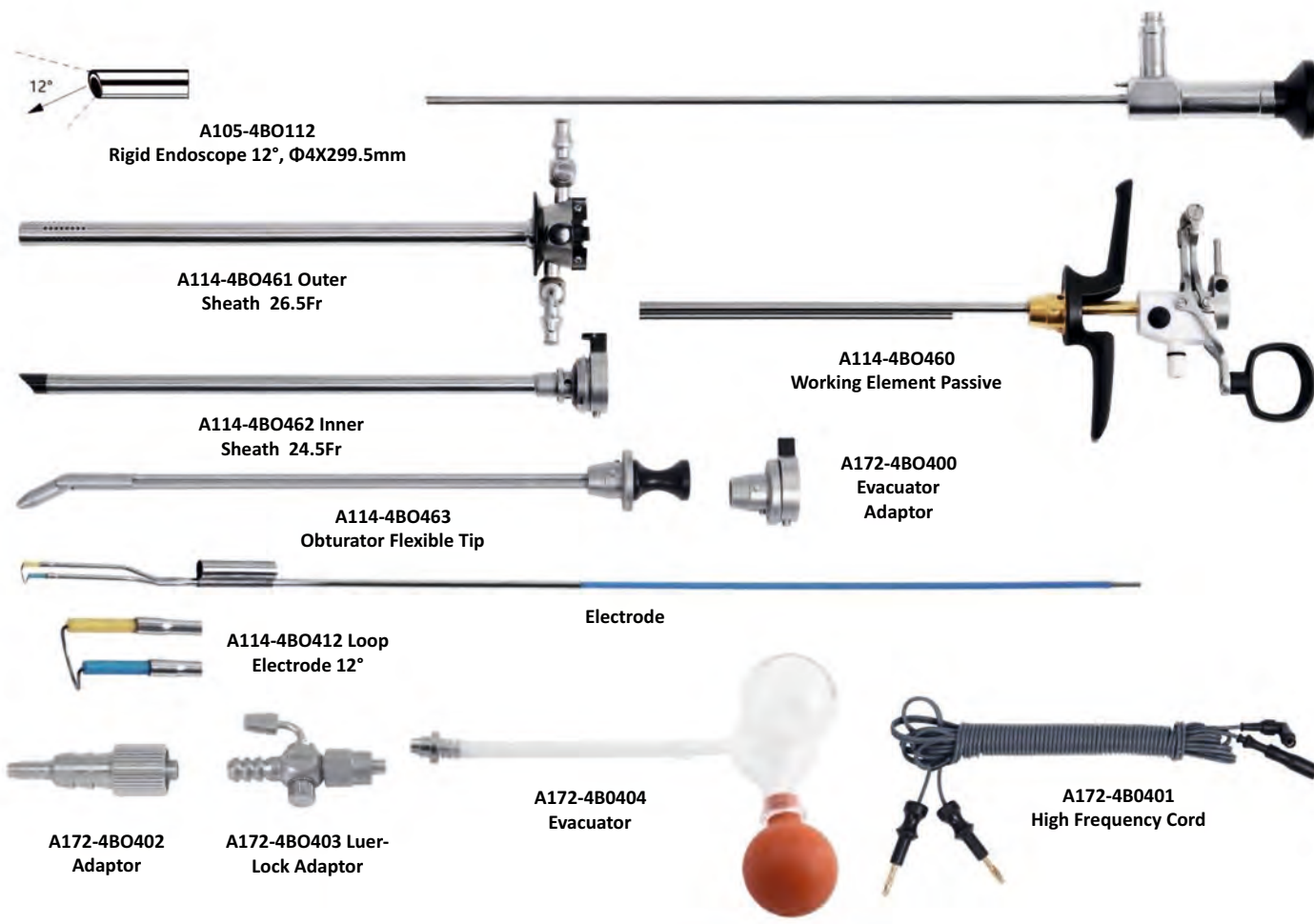

Bipolar Resectoscope V2

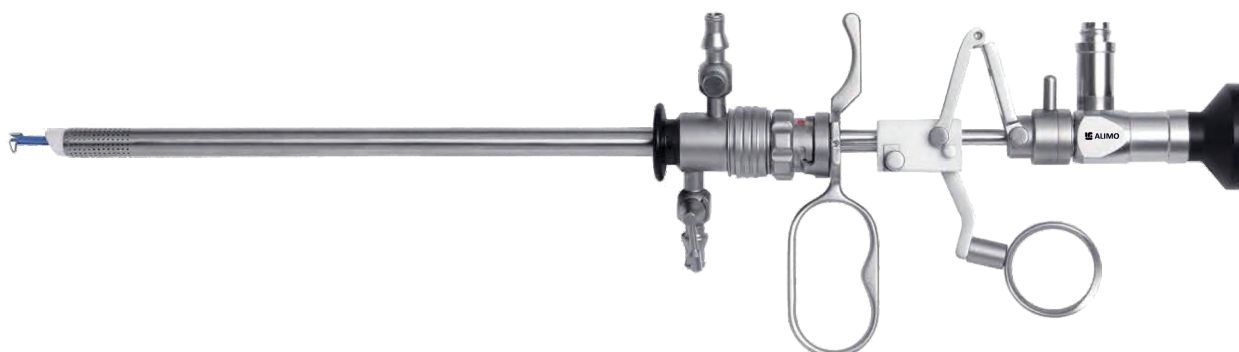

Monopolar Resectoscope



Monopolar Resectoscope Set



A105-4RS130
Rigid Endoscope 30°, Φ 4X302mm

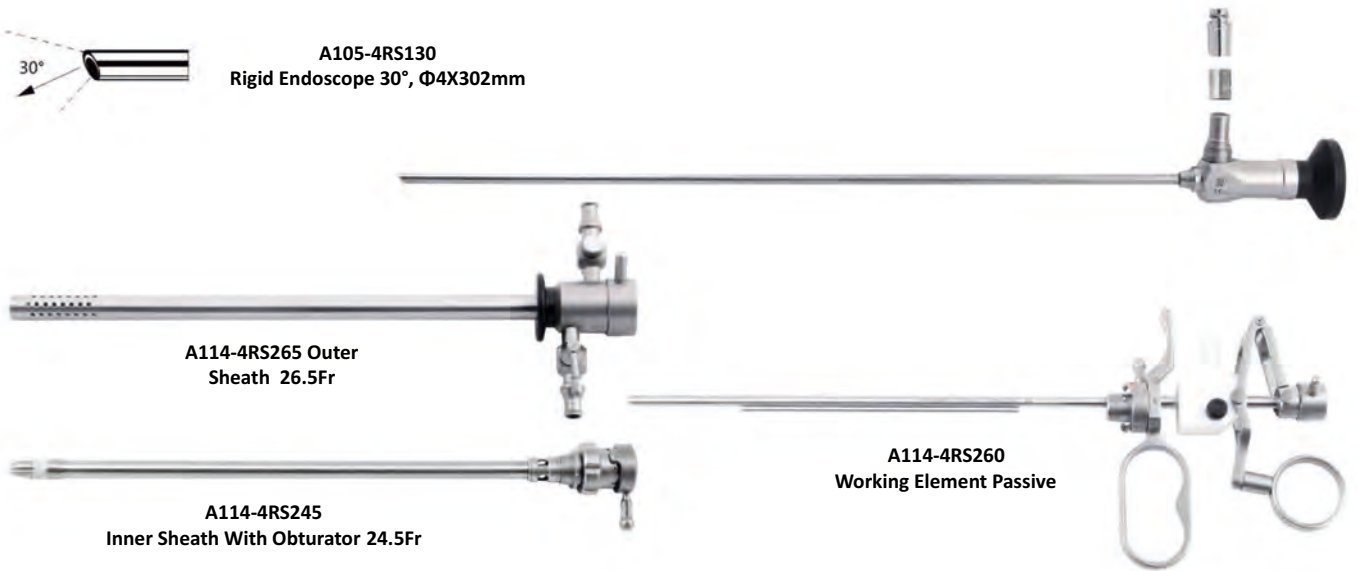

A114-4RS265 Outer
Sheath 26.5Fr

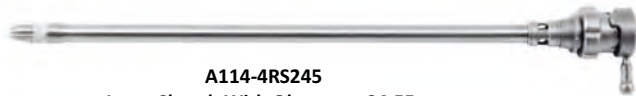

A114-4RS245
Inner Sheath With Obturator 24.5Fr



A114-4RS260
Working Element Passive



Electrode



A114-4RS130 Loop
Electrode 30°



A114-4RS131
Roller Electrode



A114-4RS132
Spike Electrode



A114-4RS133 Spud
Electrode 30°



A172-4RS101
High Frequency Cord



A172-4RS102
Evacuator

Urethro-Cystoscope

Cysto-Urethroscope Set

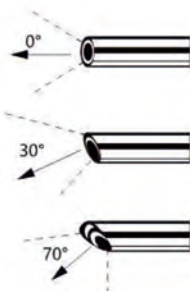

A105-4CS100
Rigid Endoscope 0°, Φ4X302mm

A105-4CS130
Rigid Endoscope 30°, Φ4X302mm

A105-4CS170
Rigid Endoscope 70°, Φ4X302mm



A172-4CS108
Adaptor



A172-4CS109
Luer-lock adaptor



A172-4CS145 Sealing Cap



Light Guide Cable



A114-4CS165 Cystoscopy Sheath 16.5Fr

A114-4CS185 Cystoscopy Sheath 18.5Fr

A114-4CS215 Cystoscopy Sheath 21.5Fr

A114-4CS235 Cystoscopy Sheath 23.5Fr

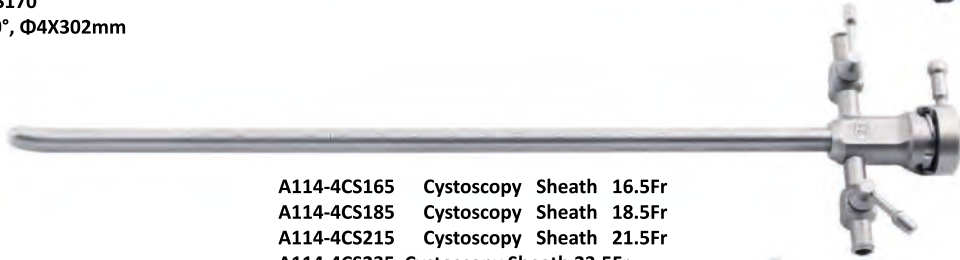

A114-4CS195
Catheter Deflecting Mechanism
With Two Channels



A172-3CS001
Cleaning Brush



A114-4CS101
Telescope Bridge with Single Channel



A114-4CS102
Telescope Bridge with Two Channel



A114-4CS100
Telescope Bridge



Endoscopy Flexible Forceps 7FrX395mm



A114-7CS301
Biopsy Forceps



A114-7CS302 Foreign
Body Forceps



A114-7CS303
Serrated Forceps



A114-7CS304
Scissors

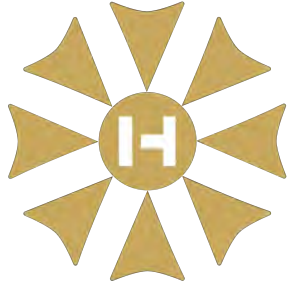

HALSTED HEALTHCARE
TRADITION & INNOVATION



ALIMO



TAMILNADU:

7/249, 5th Cross St, Rajagopalapuram, Moulivakkam, Chennai, Tamil Nadu -600125

KERALA:

No:KP XIX/10 G,H, Appanchira centre, Kadathuruthy, Kottayam, Kerala- 686604

KARNATAKA | KERALA | MADHYA PRADESH | MAHARASHTRA | TAMILNADU | TELANGANA