



www.grupocevik.es

#sacatuladopro

Profesionales trabajando
para Profesionales



#SACATULADOPRO #sacatuladopro



Compresores para todas las Soluciones



#profesionalestrabajandoparaprofesionales

COMPRESORES SILENCIOSOS

ECO-TECHNOLOGY



- ✦ Libre de aceites
- ✦ Sin residuos
- ✦ Ahorro energético
- ✦ Bajo nivel sonoro



CA-PRO6XS

1 HP - 8 bar
156 L/min
2.800 r.p.m.
Sin aceite
6 L

68 dB
Silencioso

109€



CA-PRO27XS

2 HP - 8 bar
230 L/min - 72 dB
2.850 r.p.m.
Sin aceite
24 L

Silencioso
Gran caudal



149€



CA-PRO52XS

2 HP - 8 bar
230 L/min - 72 dB
2.850 r.p.m.
Sin aceite
50 L

Silencioso
Gran caudal



189€



CA-PRO53XS

4 HP - 8 bar
420 L/min - 72 dB
2.850 r.p.m.
Sin aceite
50 L

Motor de inducción

269€

DISPONIBLE FEB 26



COMPRESORES SILENCIOSOS

CA-CS6

0,75 HP - 8 bar
106 L/min
1.700 r.p.m.
Sin aceite
6 L

99€

59 dB
S'per
silencioso



CA-PROGSILENT

1 HP - 8 bar
110 L/min
1.400 r.p.m.
Sin aceite
6 L

119€

62 dB
S'per
silencioso



CA-PRO12SILENT

1 HP - 8 bar
115 L/min
1.400 r.p.m.
Sin aceite
12 L

125€

62 dB
S'per
silencioso



CA-PRO25SILENC

1,5 HP - 8 bar
150 L/min
1.400 r.p.m.
Sin aceite
25 L

149€

59 dB
S'per
silencioso



CA-PRO50SILENC

1,5 HP - 8 bar
150 L/min
1.400 r.p.m.
Sin aceite
50 L

179€

59 dB
S'per
silencioso



CA-PRO50SVT

1,5 HP - 8 bar
150 L/min
1.400 r.p.m.
Sin aceite
50 L

189€

59 dB
S'per
silencioso



COMPRESORES SILENCIOSOS

CA-PRO50S2

2,8 HP - 8 bar
300 L/min
1.400 r.p.m.
Sin aceite
50 L

299€

65 dB
Sper
silencioso



DOS CABEZALES
BI-CILINDRICOS



CA-PRO80SILENC

3 HP - 8 bar
350 L/min
1.200 r.p.m.
Sin aceite
80 L

399€

59 dB
Sper
silencioso



DOS CABEZALES
BI-CILINDRICOS



CA-PRO103SILENT

3 HP - 9 bar
390 L/min
1.400 r.p.m.
Sin aceite
100 L

499€

68 dB
Sper
silencioso



DOS CABEZALES
BI-CILINDRICOS



CA-PRO104SILENT

4 HP - 9 bar
493 L/min
1.400 r.p.m.
Sin aceite
100 L

569€

68 dB
Sper
silencioso



DOS CABEZALES
BI-CILINDRICOS



CA-PRO204SILENT

4 HP - 8 bar
493 L/min
1.400 r.p.m.
Sin aceite
180 L

799€

68 dB
Sper
silencioso



DOS CABEZALES
BI-CILINDRICOS



COMPRESORES MONOBLOCK

CA-AIR230/12 ■ ■ Port-til

230 V / 12 V
7 bar - 20 L/min
98 W
Manguera 60 cm
Cable 1,3 m + 2 boquillas

29€

CONECTABLE A RED Y
MECHERO DE VEHICULO



CA-PRO7FN ■ ■ Asa de transporte

230 V - 1,5 HP
8 bar - 180 L/min
2.450 r.p.m.
Sin aceite
6 L

99€



CA-PRO25 ■ ■ ProtecciÛn tÈrmica

Dos salidas
230 V - 2 HP
8 bar - 195 L/min
2.850 r.p.m.
25 L

119€



CA-PRO55 ■ ■ ProtecciÛn tÈrmica

Dos salidas
230 V - 2 HP
8 bar - 195 L/min
2.850 r.p.m.
50 L

149€



CA-PRO24XT ■ ■ ProtecciÛn tÈrmica

Dos salidas
230 V - 2,5 HP
8 bar - 205 L/min
2.850 r.p.m.
24 L

129€



CA-PRO50 ■ ■ ProtecciÛn tÈrmica

Dos salidas
230 V - 2,5 HP
8 bar - 205 L/min
2.850 r.p.m.
50 L

169€



CA-PRO26NG ■ ■ ProtecciÛn tÈrmica

Sin mantenimiento
230 V - 2,5 HP
9 bar - 246 L/min
2.500 r.p.m.
Sin aceite
24 L

135€



COMPRESORES MONOBLOCK

CA-PRO51NG

230 V - 2,5 HP
9 bar - 246 L/min
2.500 r.p.m.

Sin aceite
50 L

175€

Protección térmica
Sin mantenimiento



CA-PRO25VX

230 V - 3 HP
8 bar - 357 L/min
2.950 r.p.m.
25 L

225€

Semiprofesional
Cabezal en iVi



CA-PRO50VXR

230 V - 3 HP
9 bar - 358 L/min
2.850 r.p.m.
50 L

239€

Semiprofesional
Cabezal en iVi



CA-PRO100VX

230 V - 3 HP
8 bar - 357 L/min
2.950 r.p.m.
100 L

329€

Semiprofesional
Cabezal en iVi



CA-C330/03PRO

230 V - 3 HP
10 bar - 330 L/min
1.400 r.p.m.
3 L

999€

Trabajo continuo 2h



CA-PRO590M

230 V - 4 HP
10 bar - 590 L/min
1.420 r.p.m.
20 L

2.699€

Trabajo continuo 2h



COMPRESORES CORREAS



CA-PRO25-3MF

230 V - 3 HP
10 bar - 365 L/min
1.375 r.p.m.
25 L

599€



CA-PRO25-3MFGT

■ ■ ■ **Marcha en vacío**

230 V - 3 HP
10 bar - 365 L/min
1.375 r.p.m.
24 L

769€

**ESPECIAL
GOTELE**



CA-PRO100VC-3M

■ ■ ■ **Cabezal en iVi**

230 V - 3 HP
8 bar - 336 L/min
1.100 r.p.m.
100 L

429€



CA-PRO50-3MC

230 V - 3 HP
10 bar - 320 L/min
1.420 r.p.m.
50 L

499€



COMPRESORES CORREAS

CA-PRO100-3MC

230 V - 3 HP
10 bar - 320 L/min
1.420 r.p.m.
100 L

539€



CA-PRO100-3MF

230 V - 3 HP
10 bar - 365 L/min
1.375 r.p.m.
100 L

649€



CA-PRO100-3TF

400 V - 3 HP
10 bar - 365 L/min
1.375 r.p.m.
100 L

750€



CA-PRO150-3MF

230 V - 3 HP
10 bar - 365 L/min
1.375 r.p.m.
150 L

750€



CA-PRO150-3TF

400 V - 3 HP
10 bar - 365 L/min
1.375 r.p.m.
150 L

839€



CA-PRO200-3MF

230 V - 3 HP
10 bar - 365 L/min
1.375 r.p.m.
200 L

871€



COMPRESORES CORREAS

CA-PRO200-3TF

Trifásico

400 V - 3 HP
10 bar - 365 L/min
1.375 r.p.m.
200 L

960€



CA-PRO200-4MF

Cabezal alto rendimiento

230 V - 4 HP
10 bar - 539 L/min
1.400 r.p.m.
200 L

1.249€



CA-PRO200-4TF

Trifásico

400 V - 4 HP
10 bar - 539 L/min
1.400 r.p.m.
200 L

1.249€



CA-PRO300-5.5TF

Trifásico

400 V - 5,5 HP
11 bar - 550 L/min
1.510 r.p.m.
270 L

1.279€

DOBLE ETAPA



CA-PRO300-K28TF

Cabezal alto rendimiento
Trifásico

400 V - 5,5 HP
11 bar - 662 L/min
1.000 r.p.m.
270 L

1.699€

DOBLE ETAPA



CA-PRO300-K30TF

Cabezal alto rendimiento
Trifásico

400 V - 5,5 HP
11 bar - 727 L/min
1.000 r.p.m.
270 L

1.799€

DOBLE ETAPA



COMPRESORES CORREAS

CA-PRO300-7.5TF

400 V - 7,5 HP
11 bar
875 L/min
1.200 r.p.m.
270 L

Cabezal alto rendimiento
Trifsico



1.999€

DOBLE
ETAPA



CA-PRO500-7.5TF

400 V - 7,5 HP
11 bar
875 L/min
1.200 r.p.m.
500 L

Cabezal alto rendimiento
Trifsico



2.099€

DOBLE
ETAPA



CA-PRO500-10TF

400 V - 10 HP
11 bar
1.074 L/min
1.000 r.p.m.
500 L

Cabezal alto rendimiento
Trifsico



2.850€

DOBLE
ETAPA



CA-PRO500-10TSD

400 V - 10 HP
11 bar
1074 L/min
1.000 r.p.m.
500 L

Cabezal alto rendimiento
Trifsico



3.299€

DOBLE
ETAPA

ESTRELLA
TRIANGULO



CA-PRO314-5.5TF

400V - 5.5 HP
472 L/min
650 r.p.m.
270 L

Cabezal alto rendimiento
Trifsico



2.099€

14 BAR
DOBLE ETAPA



COMPRESORES CORREAS

CA-PRO514-7.5TF

400 V - 7,5 HP
582 L/min
800 r.p.m.
500 L

2.699€

DOBLE
ETAPA



Cabezal alto
rendimiento
14 bar



CA-PRO514-10TET

400 V - 10 HP
857 L/min
800 r.p.m.
500 L

3.799€

14 BAR
ESTRELLA
TRIANGULO



Cabezal alto
rendimiento



CA-PRO900-2K50

400 V - 10+10 HP
11 bar
2.148 L/min
1.000 r.p.m.
900 L

CONSULTAR PRECIO

Cabezal alto
rendimiento
Trifsico

20 HP

TANDEM
2 cabezales



CA-PRO90-5.5TF

400V
5,5 HP
11 bar
582 L/min
1.370 r.p.m.
90 L

1.300€

DOBLE
ETAPA



Cabezal alto
rendimiento
Trifsico



CA-PRO90-5.514B

400V
5,5 HP
497 L/min
1.170 r.p.m.
90 L

1.450€

14 BAR
DOBLE ETAPA



Cabezal alto
rendimiento
Trifsico





CA-PRO3PETROL

5 HP - 7 bar
235 L/min
3,2 L

Motor
HONDA
GP160

899€



CA-PRO10PETROL

4 HP - 10 bar
235 L/min
20 L

Motor
HONDA
GP160

1.389€



CA-PRO105PETROL

5,5 HP - 10 bar
365 L/min
100 L

Motor
HONDA
GP160

1.850€



CA-PRO109PETROL

9 HP - 14 bar
642 L/min
100 L

Motor
HONDA
GX270

2.899€



COMPRESORES GASOLINA CON GENERADOR



CA-PRO27011PET

11 HP
10 bar
945 L/min
270 L
1.400 r.p.m.
BK119

Motor
HONDA
GX340



3.299€



CA-PRO20PETROL

5,5 HP
10 bar
380 L/min
10+10 L
985 r.p.m.
MK113

Motor
HONDA
GX160



1.999€



CA-CD11-270

11 HP
10 bar
945 L/min
270 L
1.400 r.p.m.
BK119

Motor
Lombardini

4.571€



DIÉSEL

COMPRESORES INSONORIZADOS DE PISTÓN

Potencia-Eficiencia



Compresores silenciosos diseñados prestando especial atención al nivel de ruido y a los costes de funcionamiento, sin olvidar el diseño externo. Fácil mantenimiento con acceso rápido a todos los componentes internos, minimizando el tiempo de inactividad. Construcción ligera diseñada para reducir las vibraciones con una cubierta de plástico robusta, diseñada para minimizar el ruido, en base a análisis vibro-acústicos.



40
dB (A)



62
dB (A)



63
dB (A)



64
dB (A)



65
dB (A)



65
dB (A)



74/77
dB (A)



100
dB (A)



120
dB (A)

CA-SILENT55

400 V
5,5 HP
11 bar
727 L/min
1.000 r.p.m.
3 L
65 dB

2.899€



CA-SILENT55-270

400 V
5,5 HP
10 bar
727 L/min
1.000 r.p.m.
270 L
65 dB

2.999€



CA-SILENT10-500

400 V
10 HP
10 bar
1.074 L/min
1.000 r.p.m.
500 L
63 dB

4.999€



CA-SILENT75-270

400 V
7,5 HP
10 bar
872 L/min
1.200 r.p.m.
270 L
64 dB

3.199€



COMPRESORES TORNILLO

Velocidad fija

Tecnología diseñada para ofrecer a la industria soluciones eficientes y sostenibles.

Diseño innovador y alto rendimiento con un menor consumo energético.

- Mantenimiento sencillo
- Innovador sistema vertical de separación de aceite de 3 etapas
- Secador frigorífico mejorado
- Refrigerante
- Punto de rocío de 3 °C
- Drenaje automático inteligente

Sistema 3 en 1 "ALL IN ONE" (secador incorporado para la gama CTD)



GAMA CT

GAMA CTD



COMPRESOR SOBRE BASE



Para uso continuo



Silencioso



Controlador electrónico ETMI

REF.	POTENCIA (HP)	PRES. MAX (bar/PSI)	CAUDAL (L/min)	CONEXIÓN	V/Hz	PRECIO
CA-CT5,5	5,5	10/145	460	1/2"	400/50	3.900 €
CA-CT7,5	7,5	10/145	705	1/2"	400/50	4.000 €



Para uso continuo



Silencioso



Controlador electrónico ETMI

REF.	POTENCIA (HP)	PRES. MAX (bar/PSI)	CAUDAL (L/min)	CONEXIÓN	V/Hz	PRECIO
CA-CT10	10	10/145	1050	1/2"	400/50	4.200 €
CA-CT15	15	10/145	1500	1"	400/50	5.600 €
CA-CT20	20	10/145	1850	3/4"	400/50	6.000 €
CA-CT25	25	10/145	2500	1"	400/50	9.000 €
CA-CT30	30	10/145	3000	1"	400/50	9.900 €



COMPRESOR CON DEPÓSITO



Para uso continuo



Silencioso

REF.	CA-CT3-90
POTENCIA (HP)	3
TANQUE (L)	90
PRES. MAX (bar/PSI)	10
CAUDAL (L/min)	261
CONEXIÓN	1/2"
V/Hz	230/50
PRECIO	3.400 €

COMPRESOR CON DEPÓSITO Y SECADOR



Para uso continuo



Silencioso



Controlador electrónico ETMII



REF.	POTENCIA (HP)	TANQUE (L)	PRES. MAX (bar/PSI)	CAUDAL (L/min)	CONEXIÓN	V/Hz	PRECIO
CA-CT5,5D-270	5,5	270	10/145	460	3/4"	400/50	5.700 €
CA-CT7,5D-270	7,5	270	10/145	705	1/2"	400/50	5.950 €
CA-CT10D-270	10	270	10/145	1050	1/2"	400/50	6.200 €
CA-CT10D-500	10	500	10/145	1050	1/2"	400/50	6.500 €
CA-CT15D-500	15	500	10/145	1500	1"	400/50	7.600 €
CA-CT20D-500	20	500	10/145	1850	1"	400/50	7.999 €



COMPRESORES TORNILLO



Velocidad variable con Inverter

- Máximo rendimiento con eficiencia energética inteligente.
- Producción de aire comprimido según la demanda del sistema.
- Mayor vida útil y menor mantenimiento.
- Menor impacto ambiental.
- Eficiencia operativa constante.
- Ahorro energético

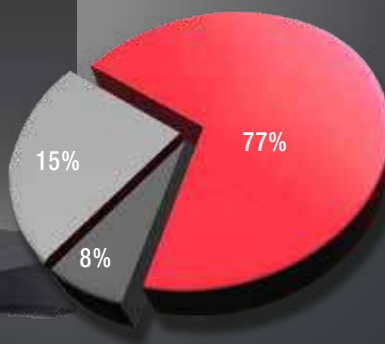

Optimización del consumo eléctrico

Inversión inteligente

REF.	POTENCIA (HP)	POTENCIA (KW)	PRES. MAX (bar/PSI)	CAUDAL (L/min)	CONEXIÓN	V/Hz
CA-CTV10	10	7,5	10/145	500-1100	1/2"	400/50
CA-CTV15	15	11	10/145	620-1580	3/4"	400/50
CA-CTV20	20	15	10/145	840-2100	3/4"	400/50
CA-CTV25	25	18,5	10/145	633-3050	1 1/4"	400/50

Transmisión directa
Motores IE3/IE4



REF.	POTENCIA (HP)	POTENCIA (KW)	PRES. MAX (bar/PSI)	CAUDAL (L/min)	CONEXIÓN	V/Hz
CA-CTV30*	30	22	10/145	572-3300	1-1/4"	400/50
CA-CTV40*	40	30	10/145	850-5050	1-1/2"	400/50
CA-CTV50*	50	37	10/145	950-5500	1-1/2"	400/50
CA-CTV60*	60	45	10/145	1570-7350	2"	400/50



* MOTOR IE4 - CONTROLADOR TÁCTIL

Transmisión directa
Motores IE3



REF.	POTENCIA (HP)	POTENCIA (KW)	TANQUE (L)	PRES. MAX (bar/PSI)	CAUDAL (L/min)	CONEXIÓN	V/Hz
CA-CTV10D-270	10	7,5	270	10/145	500-1100	1/2"	400/50
CA-CTV15D-500	15	11	500	10/145	620-1580	3/4"	400/50
CA-CTV20D-500	20	7,5	500	10/145	840-2100	3/4"	400/50

CONSULTAR PRECIOS

SECADORES FRIGORÍFICOS

Desde la pequeña hasta la mediana industria

- Gestión electrónica con doble sonda de temperatura que regula el punto de rocío y la presión de condensación
- Intercambiador de calor patentado
- Máximo rendimiento y mínima caída de presión
- Temperatura ambiente 25°C
- Presión de aire de entrada: 7 bar
- Fabricados con total respeto por el medio ambiente el uso de gases eco-compatibles y materiales reciclables

PANTALLA DIGITAL

REFERENCIA	V/Hz	L/min	m ³ /h	COEFICIENTE DE EFICIENCIA W-W	CONEXIÓN	PRECIO
CA-DRY700PRO	230/50	700	42	1,83	3/4"	849 €
CA-DRY1000PRO	230/50	1000	60	2,23	3/4"	949 €
CA-DRY1500PRO	230/50	1500	90	2,43	3/4"	979 €
CA-DRY2000PRO	230/50	2000	120	2,80	3/4"	1099 €
CA-DRY2500PRO	230/50	2500	150	2,70	1"	1200 €
CA-DRY3200PRO	230/50	3200	192	2,09	1"	1660 €
CA-DRY4000PRO	230/50	4000	240	3,55	1"	1775 €
CA-DRY5500PRO	230/50	5500	330	3,44	1-1/2"	2499 €
CA-DRY6100PRO	230/50	6100	336	3,47	1-1/2"	3184 €
CA-DRY7500PRO	230/50	7333	439	3,47	1-1/2"	3600 €
CA-DRY9500PRO	230/50	9333	559	3,50	1-1/2"	4400 €
CA-DRY12400PRO	230/50	12333	739	3,44	2"	5100 €

CONDICIONES DE REFERENCIA ESTÁNDAR ISO 7183

4	5	6	7	8	10	12	14
0,77	0,86	0,93	1,00	1,05	1,05	1,21	1,27



CALDERAS VERTICALES

Testadas y pintadas a 200°C con polvos epoxi.

Depósito vertical compuesto por:

- Depósito
- Válvula de seguridad
- Manómetro
- Llave de salida de aire
- Llave de purga de la condensación

REFERENCIA	CÓDIGO	MEDIDAS Ø (cm)	LITROS (L)	CONEXIÓN	PRECIO
CA-LT270CE	2236100972	50x164,8	270	1"	549 €
CA-LT500CE	2236100973	60x203,5	500	1"	850 €
CA-LT720CE	2236100974	80x174,5	720	1" 1/2"	1.120 €
CA-LT900CE	2236100975	80x212	900	2"	1.399 €



11 BAR

OPCIONAL:
VÁLVULA AUTOMÁTICA DE
DESCARGA DE CONDENSACIÓN.

Tecnología diseñada para la industria

Separadores de agua-aceite que separan en los condensados procedentes de sistemas de aire comprimido, aceites minerales y sintéticos derivados del uso de cualquier tipo de compresor.

Configuración multifásica de dos torres: elemento de fibra de polipropileno y elemento de carbón activado, para maximizar las propiedades absorbentes.

A la entrada del separador se puede conectar cualquier tipo de drenaje de condensado (flotador, temporizador, capacitativo, etc.)

Fácil control y mantenimiento.

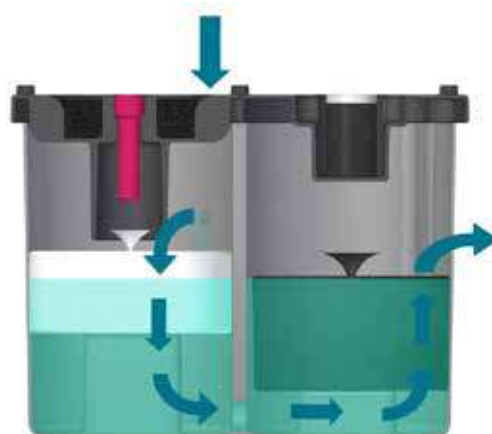

SEPARADORES

MODELO	REFERENCIA	L/min	m ³ /h	CFM	G	PRECIO
EW 20	CA-8193412	2.000	120	70	1/2"	265 €
EW 30	CA-8193409	3.000	180	105	1/2"	450 €
EW 70	CA-8193410	7.000	420	245	1/2"	736 €
EW 150	CA-8193411	15.000	900	525	1/2"	1.350 €

* NO REUTILIZABLES



EW20



EW30

KIT RECAMBIOS

REFERENCIA	PARA	PRECIO
CA-8193443	EW 20	130 €
CA-8193440	EW 30	207 €
CA-8193441	EW 70	289 €
CA-8193442	EW 150	469 €



FILTROS INDUSTRIALES

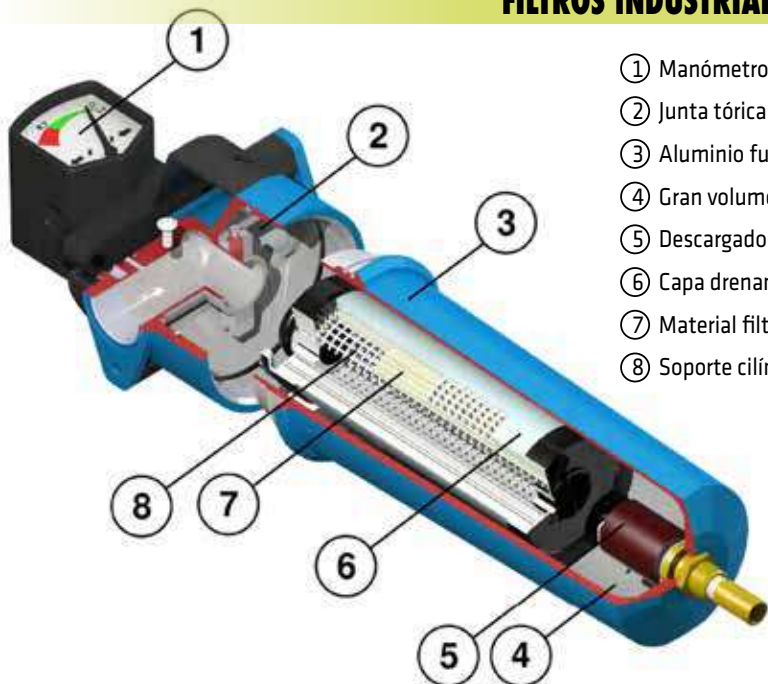

- ① Manómetro
- ② Junta tórica
- ③ Aluminio fundido a presión con recubrimiento externo en polvo
- ④ Gran volumen de condensación
- ⑤ Descargador
- ⑥ Capa drenante
- ⑦ Material filtrante de alta resistencia
- ⑧ Soporte cilíndrico.



CARTUCHO



FILTRO

FILTROS INDUSTRIALES

FILTRO	LXH (mm)	MICRON	L/min	CFM	bar	PRECIO	CARTUCHO	PRECIO
CA-PKF570	95X285	3	570	20	15	130,00 €	CA-PKC570	39,00 €
CA-PKF1300	95X285	3	1300	46	15	150,00 €	CA-PKC1300	45,00 €
CA-PKF2000	95X350	3	2000	71	15	170,00 €	CA-PKC2000	55,00 €
CA-PKF3500	125X380	3	3500	124	15	210,00 €	CA-PKC3500	65,00 €
CA-QKF570	95X285	0,1	570	20	15	130,00 €	CA-QKC570	39,00 €
CA-QKF1300	95X285	0,1	1300	46	15	150,00 €	CA-QKC1300	45,00 €
CA-QKF2000	95X350	0,1	2000	71	15	170,00 €	CA-QKC2000	55,00 €
CA-QKF3500	125X380	0,1	3500	124	15	210,00 €	CA-QKC3500	65,00 €
CA-DKF570	95X285	0,01	570	20	15	130,00 €	CA-DKC570	39,00 €
CA-DKF1300	95X285	0,01	1300	46	15	150,00 €	CA-DKC1300	45,00 €
CA-DKF2000	95X350	0,01	2000	71	15	170,00 €	CA-DKC2000	55,00 €
CA-DKF3500	125X380	0,01	3500	124	15	210,00 €	CA-DKC3500	65,00 €
CA-VKF570	95X285	0,003	570	20	15	130,00 €	CA-VKC570	39,00 €
CA-VKF1300	95X285	0,003	1300	46	15	150,00 €	CA-VKC1300	45,00 €
CA-VKF2000	95X350	0,003	2000	71	15	170,00 €	CA-VKC2000	55,00 €
CA-VKF3500	125X380	0,003	3500	124	15	210,00 €	CA-VKC3500	65,00 €

Grados de filtración:
 - Filtración por intercepción:
 - Para partículas de hasta 3 micras.
 Aplicaciones:
 PK está diseñado específicamente para la filtración de polvo antes del secador.
 - Eliminación de partículas líquidas y sólidas, protección de bombas de vacío, sopladores, secadores frigoríficos y herramientas neumáticas.

Grados de filtración:
 - Filtración por coalescencia
 - Para partículas de hasta 1 micrón
 - Para concentraciones de aceite de hasta 0,1 mg/m³
 Aplicaciones:
 - Herramientas y actuadores neumáticos;
 Transportadores de aire;
 Motores de aire comprimido;
 Arenado;
 Almacenamiento y transporte naval;
 Filtración después de bombas de vacío;
 Automoción; Refinerías;
 Metalurgia;
 Prefiltración de secadores de adsorción (sin aceite)

Grados de filtración:
 - Filtración por coalescencia
 - Para partículas de hasta 0,01 micras
 - Para concentraciones de aceite de hasta 0,01 mg/m³
 Aplicaciones:
 - Pintura, transporte con sopladores, instrumentación, manómetros, instrumentos neumáticos de precisión, instrumentos electrónicos, prefiltros para secadores desecantes.

Grados de filtración:
 - Filtración por absorción
 - Máxima concentración de aceite: 0,003 mg/m³
 Aplicaciones:
 - Producción médica y farmacéutica, instrumentación de precisión crítica, eliminación de olores y sabores, producción y envasado de alimentos y bebidas, lácteos.

TRATAMIENTO DE AIRE

CABEZAL PARA COMPRESORES CORREAS

Cabezas de doble pistón. Bloque de cilindro en hierro fundido.

REFERENCIA	PARA MODELOS	MODELO	HP	L/min	PRECIO
CA41P0017SGLF	PRO50-3MC / PRO90-3MF / PRO100-3MC	MK102	2	265/321	175,00 €
CA-PRO100VC-100	PRO100VC-3M	PRO100VC-100	3	-	150,00 €
CA41P0019SGLF	PRO25-3MF / PRO25-3MFGT PRO100-3MF / PRO100-3TF PRO150-3MF / PRO150-3TF PRO200-3MF / PRO200-3TF	MK103	3	365	195,00 €
CASD0000B	-	K17	3	465	360,00 €
CASE0000B	PRO200-4MF / PRO200-4TF	K18	4	539	450,00 €
CABU0000AF	PRO300-5,5TF	BK113	4/5,5	550	466,00 €
CA-BZ0000M	PRO90-5,5TF / PRO90-5,5TF14B	BK114	5,5	582	525,00 €
CASH0000A	PRO300-K28TF	K28	5,5	662	569,00 €
CA-BR0001R	-	BK119	7,5	840	659,00 €
CA-SL0000A	PRO300-K30TF / PRO300-7,5TF PRO500-7,5TF PRO314-5,5TF / PRO514-7,5TF	K30	5,5/7,5	727/872	869,00 €
CA-SM0000A	PRO500-10TF / PRO500-10TSD PRO514-10TF / PRO514-10TET	K50	10	1080	1.150,00 €



CABEZAL PARA COMPRESORES SILENCIOSOS

REFERENCIA	PARA MODELOS	MODELO	HP	L/min	PRECIO
CA-AP400T	PRO6XS	AP400T	1	156	89,00 €
CA-AP1500T	PRO27XS- PRO52XS	AP1100T	2	230	109,00 €
CA-AP400	PRO6SILENT / PRO12SILENT	AP400	1	106	99,00 €
CA-AP750	PRO25SILENT PRO50SILENT / PRO50SVT	AP750	1,5	150	112,00 €
CA-AP750B	PRO80SILENC / PRO24SILENC	AP750B	1,5	150	120,00 €
CA-AP1100	PRO40SILENT - PRO103SILENT	AP1100	1,5	195	165,00 €
CA-AP1500	PRO104SILENT / PRO204SILENT	AP1500	2	245	179,00 €



MOTOR ELÉCTRICO

Motor para compresores de aire con polea.

REFERENCIA	PARA MODELOS	VOLTAJE (V)	HP	PRECIO
CA845G004	MEC80	230	3	175,00 €
CA84506CA	MEC90	230	3	222,00 €
CA845S0CA	MEC90	400	3	325,00 €
CA846G5CO	MEC80	230	4	319,00 €
CA846S00A	MEC112	400	5,5	260,00 €
CA848S00A	MEC112	400	7,5	550,00 €
CA849T00A	MEC112	400	10	740,00 €



CA-ACEITE1LT Pistón

Aceite especial para compresores de pistón.
1 L

12€



PEDIDO MÍNIMO: 6 UDS.

CA-ACEITE5LT Pistón SAE 30/40

Aceite especial para compresores de pistón.
5 L

38€



CA-7197720-HAL Atóxico

Aceite 100 % sintético. Multifuncional. PAO.
20 L

550€

APTO PARA COMPRESORES DE USO ALIMENTARIO



CA-ACEITE5LCP46 Mineral SAE 10/20

Aceite especial para compresores de tornillo.
5 L

36€



CA-ACEITEFLOW46 Sintético SAE 10/20

Aceite especial para compresores de tornillo.
5 L

130€



CA-7110101

Aceite para motor de gasolina.
2 tiempos.
1 L

8,99€



PEDIDO MÍNIMO: 12 UDS.

CA-710340101

Aceite para motor de gasolina.
4 tiempos.
1 L

9,99€



PEDIDO MÍNIMO: 12 UDS.

PURGADORES COMPRESOR

CA-PA1-2 ConexiUn 1/2i

Programable y automático
16 bar

49€



CA-PA1-4 ConexiUn 1/4i

Programable y automático

49€



TAPONES ACEITE

REFERENCIA	VÁLIDO PARA	PRECIO
CA-901	COMPRESOR MONOBLOCK (2 uds.)	10,00 €
CA-PRO25VX-09	VX 25-50-100	6,00 €
CA4105289F	PRO300-5,5TF PRO90-5,5TF MK102-MK103	7,00 €
CA41505680F	PRO300-K30 PRO500-7,5TF	7,00 €
CA36531140F	PRO500-10	7,00 €



CA-901



CA-PRO25VX-09

COMPRESORES

CA-MX10-1

1 HP - 230 V
130 L/min
8 bar
59 dB
1.450 r.p.m.
10 L

199€

||| S per
silencioso



CA-MX50-2

2 HP - 230 V
260 L/min
8 bar
58 dB
1.450 r.p.m.
50 L

369€

||| S per
silencioso



CA-MVX50-1

1 HP - 230 V
130 L/min
8 bar
59 dB
1.450 r.p.m.
50 L

215€

||| S per
silencioso



CA-MB24

2 HP - 230 V
140 L/min
8 bar
72 dB
2.850 r.p.m.
24 L

149€

CA-MB50

2 HP - 230 V
140 L/min
8 bar
74 dB
2.850 r.p.m.
50 L

199€



CA-MB50-3M

3 HP - 230 V
350 L/min
10 bar
74 dB
1.500 r.p.m.
50 L

529€



CA-MB100-3M

3 HP - 230 V
350 L/min
10 bar
74 dB
1.500 r.p.m.
100 L

549€



HERRAMIENTA NEUMÁTICA Y ACCESORIOS

CAKITMICHELIN8 ■ 8 piezas

Kit aerográfico para compresor:

- Pistola de soplar.
- Pistola de petrolear (0,9 L)
- Pistola de pintar (0,6 L)
- Hinchador (1-10 bar)
- Espiral (5 m) y 3 boquillas.

39€



CA-1126001381

Pistola de impacto

- Llaves: 11-12-13-14-17-19-22-24-27mm
- Par de apriete máximo: 350N
- Consumo: 220L/min 6 bar.

49€

■ Usar con lubricador 037



CA-1126001384

Pistola de impacto

- Llaves: 9-10-11-13-14-17-19-22-24-27mm
- Par de apriete máximo: 650 N
- Consumo: 250 L/min 6 bar

109€

■ Usar con lubricador 037



CA-1126000428

Kit herramientas neumáticas (66 piezas)

- Contiene: Llave criquet, pistola de impacto, martillo y accesorios

157€

■ Usar con lubricador 037



CA-2809914252

Lijadora roto orbital

- 180 L/min
- 6,3 bar
- Disco Ø125 mm
- 10.500 osc/min
- 87 PSI

99€

■ Usar con lubricador 037
Disco de velcro



HERRAMIENTA NEUMÁTICA Y ACCESORIOS



MCCF15PK

Grapadora 4,5-8 bar
Chapa corrugada de 9 a 15 mm

309€



R64KC

Clavadora 8 bar
Clavo "T" hierro y acero de 18 a 64 mm

99€



R6/35

Clavadora 4 - 7 bar
Pin y Minibrad 0,6 de 12 a 35 mm

129€



R8/40

Clavadora 4 - 7 bar
Pin y Minibrad 0,8 de 12 a 40 mm

149€



R18/51

Clavadora 4 - 7 bar.
Clavo de 12 de 15 a 50 mm

79€



R80/16

Grapadora 4 - 7 bar
Grapa 80 de 6 a 16 mm

35€



SF50/40

Grapadora / Clavadora 4 - 7 bar
Brad 12 de 12 a 50 mm
Grapa 90 de 16 a 40 mm

39€



R12/51D

Clavadora 4 - 7 bar
Brad 12 de 15 a 50 mm

39€



HERRAMIENTA NEUMÁTICA Y ACCESORIOS

SUMINISTRADOS EN BLÍSTER

PIN 0,8 SIN CABEZA

REFERENCIA	LARGO (mm)	PRECIO BLÍSTER
MCPINO.8-20BLIS	20	4,00 €
MCPINO.8-30BLIS	30	4,76 €

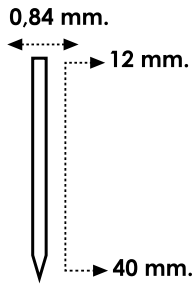

2.000 uds.

PIN 0,8 CON CABEZA

REFERENCIA	LARGO (mm)	PRECIO BLÍSTER
MINIBRAD820BLIS	20	4,00 €
MINIBRAD830BLIS	30	4,76 €

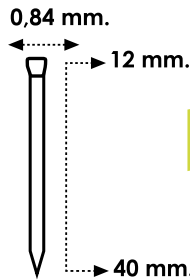

2.000 uds.

BRAD 12

REFERENCIA	LARGO (mm)	PRECIO BLÍSTER
MCBRAD12-20BLIS	20	2,67 €
MCBRAD12-30BLIS	30	3,68 €
MCBRAD12-40BLIS	40	4,76 €
MCBRAD12-50BLIS	50	4,76 €

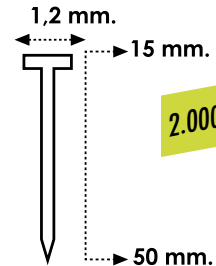

2.000 uds.

BRAD 14

REFERENCIA	LARGO (mm)	PRECIO BLÍSTER
MCBRAD14-30BLIS	30	4,00 €
MCBRAD14-40BLIS	40	4,76 €

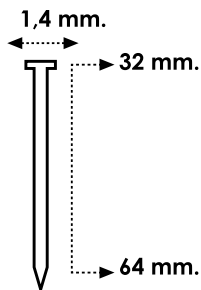

1.000 uds.

CLAVO MINI T ACERO

REFERENCIA	LARGO (mm)	PRECIO BLÍSTER
MCMINIT-18BLIS	18	8,40 €
MCMINIT-30BLIS	30	8,89 €
MCMINIT-40BLIS	40	10,49 €

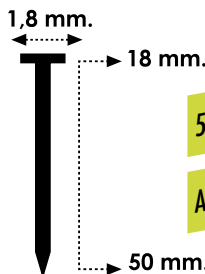

500 uds.

ACERO

GRAPA 80

REFERENCIA	LARGO (mm)	PRECIO BLÍSTER
MCGRAPA80-8BLIS	8	2,67 €
MCGRAPA80-12BLI	12	2,67 €
MCGRAPA80-16BLI	16	3,49 €

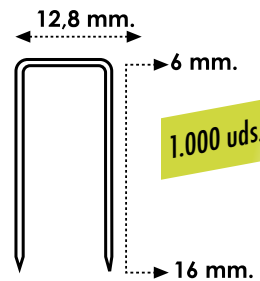

1.000 uds.

GRAPA 90

REFERENCIA	LARGO (mm)	PRECIO BLÍSTER
MCGR90-20BLIS	20	4,19 €
MCGR90-25BLIS	25	4,19 €
MCGR90-30BLIS	30	4,19 €

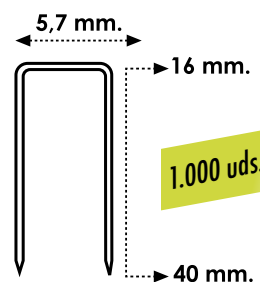

1.000 uds.



HERRAMIENTA NEUMÁTICA Y ACCESORIOS

SUMINISTRADOS EN CAJA

PIN 0.6 SIN CABEZA

	REFERENCIA	LARGO (mm)	MILLARES CAJA	PRECIO MILLAR
De 12 a 50 mm	MCPINO.6-12S	12	20	1,05 €
Para modelos: PO-06/30K	MCPINO.6-15	15	13	1,12 €
PO-06/50K	MCPINO.6-18	18	14	1,22 €
R-6/35	MCPINO.6-25	25	9	1,22 €
	MCPINO.6-30	30	6,5	1,96€
	MCPINO.6-40S	40	6,5	2,75 €

PIN 0.6 CON CABEZA (MINIBRAD)

	REFERENCIA	LARGO (mm)	MILLARES CAJA	PRECIO MILLAR
De 12 a 50 mm	MCMINIBRAD618P	18	10,8	0,53 €
Para modelos: PO-06/30K	MCMINIBRAD620S	20	9	1,71 €
PO-06/50K	MCMINIBRAD621	21	9,6	1,71 €
R-6/35	MCMINIBRAD625S	25	9	1,84 €
	MCMINIBRAD630P	30	10,08	1,84 €
	MCMINIBRAD640S	40	6,5	2,63 €
	MCMINIBRAD650S	50	9,6	2,63 €

PIN 0.8 SIN CABEZA

	REFERENCIA	LARGO (mm)	MILLARES CAJA	PRECIO MILLAR
De 12 a 40 mm	MCPINO.8-18	18	27,5	1,18 €
Para modelo: PO-08/40K	MCPINO.8-20	20	27,5	1,24 €
	MCPINO.8-25	25	13,75	1,63 €

PIN 0.8 CON CABEZA (MINIBRAD)

	REFERENCIA	LARGO (mm)	MILLARES CAJA	OFERTA MILLAR
De 12 a 40 mm	MCMINIBRAD815	15	21	1,10 €
Para modelo: PO-08/40K	MCMINIBRAD820S	20	10	1,25 €
	MCMINIBRAD830	30	8	2,06 €
	MCMINIBRAD835S	35	5	2,21 €
	MCMINIBRAD840S	40	5	2,28 €

CLAVO DE 12 (BRAD)

	REFERENCIA	LARGO (mm)	MILLARES CAJA	PRECIO MILLAR
De 10 a 50mm	MCBRAD12-15	15	12	1,16 €
Para modelos: R18/30	MCBRAD12-20	20	10	1,39 €
R18/50	MCBRAD12-25	25	8	1,64 €
R18/51	MCBRAD12-30	30	5	1,84 €
R90/40 MIXTA	MCBRAD12-35	35	5	2,01 €
R12/50B	MCBRAD12-40	40	5	2,86 €
SF3232	MCBRAD12-45	45	4	2,86 €
SF50/40	MCBRAD12-50	50	2,5	3,67 €
R12/51D				

CLAVO DE 14 (BRAD)

	REFERENCIA	LARGO (mm)	MILLARES CAJA	PRECIO MILLAR
De 20 a 64 mm	MCBRAD14-20	20	6	2,27 €
Para modelos: R16/50KOMBI	MCBRAD14-25	25	4	2,79 €
R16/64K	MCBRAD14-30	30	4	3,09 €
	MCBRAD14-35	35	2,4	3,97 €
	MCBRAD14-40S	40	2,4	4,34 €
	MCBRAD14-50	50	2	4,71 €
	MCBRAD14-55	55	2	5,60 €
	MCBRAD14-60	60	2	6,05 €
	MCBRAD14-63S	63	2	7,35 €



HERRAMIENTA NEUMÁTICA Y ACCESORIOS

SUMINISTRADOS EN CAJA

CLAVO MINI "T" ACERO

	REFERENCIA	LARGO (mm)	MILLARES CAJA	PRECIO MILLAR
 De 15 a 50 mm Para modelo: R16/50 KOMBI	MCMINIT-18	18	3	7,11 €
	MCMINIT-20	20	3	7,11 €
	MCMINIT-25	25	3	7,33 €
	MCMINIT-30	30	3	9,27 €
	MCMINIT-35	35	1,5	12,36 €
	MCMINIT-45	45	1,5	14,55 €
	MCMINIT-50	50	1,5	14,67 €

CLAVO "T" HIERRO

	REFERENCIA	LARGO (mm)	MILLARES CAJA	PRECIO MILLAR
 De 18 a 64 mm Para modelos: R64KC R64K	MCCLAVOT-25	25	2	8,65 €
	MCCLAVOT-32	32	2	9,19 €
	MCCLAVOT-38	38	1	10,50 €
	MCCLAVOT-45	45	1	10,50 €
	MCCLAVOT-50	50	1	10,73 €
	MCCLAVOT-55	55	1	12,60 €
	MCCLAVOT-60	60	1	14,70 €
	MCCLAVOT-64	64	1	15,75 €

GRAPA 80

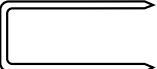
	REFERENCIA	LARGO (mm)	MILLARES CAJA	PRECIO MILLAR
 De 6 a 16 mm Para modelos: R80/16 R80/16B R80/16C	MCGRAPA80-6P	6	6,2	1,01 €
	MCGRAPA80-8P	8	4,5	1,21 €
	MCGRAPA80-10P	10	4,5	1,39 €
	MCGRAPA80-12P	12	3,5	1,63 €
	MCGRAPA80-14P	14	3	2,10 €
	MCGRAPA80-16P	16	3	2,41 €

GRAPA 90

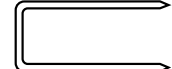
	REFERENCIA	LARGO (mm)	MILLARES CAJA	PRECIO MILLAR
 De 10 a 40 mm Para modelos: R90/40 R90/40 MIXTA SF3232 SF50/40	MCGR90-10P	10	5,6	3,09 €
	MCGR90-15P	15	4,2	3,24 €
	MCGR90-20P	20	4	4,01 €
	MCGR90-25P	25	2,6	4,48 €
	MCGR90-30P	30	2,6	4,84 €
	MCGR90-35P	35	1,8	6,03 €
	MCGR90-40P	40	1,6	6,56 €

GRAPA 10

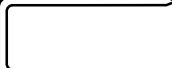
	REFERENCIA	LARGO (mm)	MILLARES CAJA	PRECIO MILLAR
 De 8 a 25 mm Para modelo: 1025/J	MCGR-1008	8	5	1,86 €
	MCGR-1010	10	5	2,16 €
	MCGR-1013	13	5	2,32 €
	MCGR-1016	16	2,8	2,91 €
	MCGR-1019	19	5	3,27 €
	MCGR-1022	22	5	3,40 €

GRAPAS (Para grapadoras manuales)

	REFERENCIA	LARGO (mm)	MILLARES CAJA	PRECIO MILLAR
GRAPA M-486 Para modelo: M483	CE-486-06	6	1	2,10 €
	CE-486-08	8	1	2,10 €
GRAPA M-487 Para modelo: M484	CE-487-10	10	1	2,10 €
	CE-487-12	12	1	2,10 €
	CE-487-14	14	1	2,10 €

CE-M484

Grapadora manual
 Grapa de 4 a 14 mm

13€



HERRAMIENTA NEUMÁTICA Y ACCESORIOS

NE-RP7225

Atornillador recto
11.000 r.p.m.
2 HP (*)
74 L/min
45 N

Portapuntas:
3-5 mm

29€



NE-RP17113

Taladro recto
2.300 r.p.m.
2 HP (*)
128 L/min
Entrada aire 1/4"

10 mm

35€



NE-RP17102

Taladro
1.800 r.p.m.
2 HP (*)
114 L/min
Entrada aire 1/4"

10 mm

49€



NE-RP17108

Taladro
700 r.p.m.
2 HP (*)
114 L/min

13 mm

74€



NE-RP17407

Llave impacto
7.500 r.p.m.
3 HP (*)
183,9 L/min
610 N

1/2i

69€



NE-RP7462

Llave impacto
4.600 r.p.m.
3 HP (*)
183,9 L/min
1800 N

3/4i

199€



NE-RP17411

Llave de carraca
160 r.p.m.
2 HP (*)
114 L/min
67,5 N

1/2i

49€



NE-RP17610

Cizalla
1.800 r.p.m.
2 HP (*)
114 L/min

Corte m.x.:
1.6 mm

49€



NE-RP7636

Multifunción
128 L/min
6,3 bar
2 HP (*)
16.000 osc/min

49€



*SE RECOMIENDA USAR COMPRESOR CON LOS HP INDICADOS COMO MÍNIMO.

HERRAMIENTA NEUMÁTICA Y ACCESORIOS

NE-RP8043

Pistola de grasa. 90 PSI - 4 bar
199 - 170 L/min - 400 cc
Entrada aire 1/4"

39€



NE-KN10BLIS

Taladro neumático. Cuerpo aluminio fundido.
6 bar. Portabrocas automático reversible: 6 mm

45€



NE-KN6615K

Remachadora
6.3 bar - 7.063 N
Carrera pistón 14 mm
Capacidad remachadora Ø:
2,4 - 3,2 - 4,0 - 4,8
Entrada aire 1/4"

120€



NE-RP7336S-2

Disco lijadora GR80

Pack
10 uds.

NE-RP7336S-3

Disco lijadora GR120

NE-RP7336S-4

Disco lijadora GR180

5,50€

PARA MODELO:
NE-RP7336



NE-KN6B

Kit 4 cinceles.

8€



NE-RP7336S-1BIS

Plato goma Ø150 mm
Para modelo:
NE-RP7336

35€



NE-RP7636-1

Kit multiusos
Para modelo:
NE-RP7636

19€



NE-KN6A

Muelle
Para modelo:
NE-RP17621

5€



NE-RP7006

Juego de llaves de vaso
11-12-13-14-16-17-19-21-22-24 mm
Para modelos:
NE-RP17407 - NE-RP7426

19€



HERRAMIENTA NEUMÁTICA Y ACCESORIOS

BT-S71PRONA1.3M ■ ■ Esmaltes

Pistola baja presión 1/3"
Consumo de aire:
200-250 L/min
Conexión: 1/4"

120€



BT-S71PRONA ■ ■ Imprimaciones sintéticas

Pistola baja presión 1/5"
Consumo de aire:
200-250 L/min
Conexión: 1/4"

120€



BT-S71PRONA1.8M ■ ■ Esmaltes

Pistola baja presión 1/8"
Consumo de aire:
200-250 L/min
Conexión: 1/4"

120€



CA-1857

Pistola de pintar
3,5 bar
250 - 300 L/min
Apta para boquillas desde Ø 1.1 - 2.5 mm

■ ■ Juntas de teflón
Depósito anti-goteo

Modelos disponibles:

CA-1857-1.3

Boquilla de serie de Ø 1.3 mm

CA-1857-1.4

Boquilla de serie de Ø 1.4 mm

CA-1857-1.7

Boquilla de serie de Ø 1.7 mm

CA-1857-2.0

Boquilla de serie de Ø 2.0 mm

CA-1857-2.5

Boquilla de serie de Ø 2.5 mm

99€

Estopa autoajustable de fácil acceso

Boquilla de latón niquelado fácil de posicionar: "gira" suave con la mano

Regulación de abanico con la misma mano

Regulador de aire integrado

Muelle de producto con taco de PTFE. Regulación de producto suave

Válvula de aire y aguja de producto en ejes independientes. Fácil de desmontar

Ergonómica y muy ligera



*Todas las partes en contacto con la pintura son de acero inoxidable: pico de fluido, aguja, racor y gatillo.

HERRAMIENTA NEUMÁTICA Y ACCESORIOS

CA-1852

■ ■ ■ Semi-profesional
600 cc

Pistola de pintar
Cuerpo de aluminio
Conexión rápida
Abanico:
110 - 220 mm
Apta para boquillas
de Ø 1,5 mm

19€



CA-1850

■ ■ ■ Semi-profesional
750 cc

Pistola de pintar
Cuerpo de aluminio
Conexión rápida
Abanico:
119 - 220 mm
Apta para boquillas
de Ø 1,5 mm

19€



CA-1851

■ ■ ■ 125 cc

Pistola de pintar Mini
90-150 L/min. 3-4 bar
Apta para boquillas
de Ø 0,5 - 1,8 mm

25€



CA-1855/3L

■ ■ ■ 1.000 cc

Pistola de pintar
3-6 bar
110-180 L/min
Apta para boquillas
de Ø 1.4 - 2.0 mm
Boquilla de serie
de Ø 1.7 mm

36€



CA-1856/3-1.4

■ ■ ■ Semi-profesional
600 cc

Pistola de pintar
3-6 bar
170-320 L/min
Apta para boquillas
de Ø 1.4, 1.7, 2.0 mm
Boquilla de serie
de Ø 1.4 mm

36€



JUEGO DE BOQUILLAS Y AGUJAS

Ref.: CA-KIT1.4/1855 (1,4 mm)
Ref.: CA-KIT2.0/1855 (2.0 mm)

19€



JUEGO DE BOQUILLAS Y AGUJAS

Ref.: CA-KIT2.0/1856 (2.0 mm)

19€



CA-1856/3

■ ■ ■ Esmaltes
600 cc

Pistola de pintar
3-6 bar
170-320 L/min
Apta para boquillas
de Ø 1.4, 1.7, 2.0 mm
Boquilla de serie
de Ø 1.7 mm

36€



CA-1856/3-2.0

■ ■ ■ Aparejo e
imprimaciones
600 cc

Pistola de pintar
3-6 bar
170-320 L/min
Apta para boquillas
de Ø 1.4, 1.7, 2.0 mm
Boquilla de serie
de Ø 2.0 mm

36€



JUEGO DE BOQUILLAS Y AGUJAS

Ref.: CA-KIT1.4/1856 (1,4 mm)
Ref.: CA-KIT2.0/1856 (2,0 mm)

19€



JUEGO DE BOQUILLAS Y AGUJAS

Ref.: CA-KIT1.4/1856 (1,4 mm)

19€



HERRAMIENTA NEUMÁTICA Y ACCESORIOS

CA-1805

Pistola de pintar
1,75 bar
200 L/min
3 boquillas incluidas

27€

 Gotel
6.000 cc



CA-1807L

Pistola de pintar
3-6 bar
275 L/min
Boquilla de serie
Ø 2,5 mm

105€

 Lisos
5.000 cc



JUEGO DE BOQUILLAS

Ref.: CA-1805-BOQUILL
(0.4-0.6-0.8 mm)

11€



JUEGO DE BOQUILLAS Y AGUJAS

Ref.: CA-KIT1.75-1807L (1.75 mm)
Ref.: CA-KIT2.5-1807L (2.5 mm)

62€



CA-1400/1

Pistola de
petroleo
750 cc
Presión: 4-7 bar
Conexión rápida

12€

 Boquilla
2.0 mm



CA-1150

Pistola de soplar
Presión máx. 10 bar

4,75€



CA-1160

Pistola de soplar caña larga
Largo 15 cm
Presión máx. 10 bar

8,50€



CA-1180/1

Hinchador de
neumáticos
0-12 bar
Latiguillo 30 cm
Ø 63 mm

15€



CA-60G-T

Hinchador de
neumáticos
0-12 bar
Latiguillo 1m
Ø 80 mm

59€



* Homologado Norma
EN12645:2014

HERRAMIENTA NEUMÁTICA Y ACCESORIOS

CA-1161/2

Pistola de soplar
caña larga y
boquilla curva
Presión máx.
10 bar

ConexiÓn
r-pida

14,50€



30 cm.

CA-1161/3

Pistola de soplar
caña larga y
boquilla curva
Presión máx.
10 bar

ConexiÓn
r-pida

18€



50 cm.

CA-1161/4

Pistola de soplar
caña larga y
boquilla curva
Presión máx.
10 bar

ConexiÓn
r-pida

26€



80 cm.

NE-KN8041

Pistola de arenar-chorrear
110 L/min
2 boquillas:
Ø 0,6 mm
Presión máx. 10 bar.

36€



PRECISA
COMPRESOR
DE 250 L/MIN

CA-1151

Pistola de soplar
Boquilla curva
Entrada aire 1/4"
Presión máx. 10 bar

6,50€

ConexiÓn
r-pida



CA-SPR4-6.5

Tubo espiral
"Poliuretano"
Ø 6,5 - 10 mm

12€

5 m



CA-SPR10-812

Tubo espiral
"Poliuretano"
Ø 8 - 12 mm

25€

10 m



CA-SRU5-8

Tubo espiral
"Rilsan"
Ø 6 - 8 mm

8€

5 m



CA-SRU10-8

Tubo espiral
"Rilsan"
Ø 6 - 8 mm

12€

10 m



HERRAMIENTA NEUMÁTICA Y ACCESORIOS

CA-AM80-8 Aire

Enrollador automático manguera
Longitud 10 m
Presión máx. 15 bar
Racor salida 1/4"

129€

Ø INTERIOR 8 MM



CA-AM85-10 Aire

Enrollador automático manguera
Longitud 16 m
Presión máx. 15 bar
Racor salida 3/8"

179€

Ø INTERIOR 10 MM



CA-AM86-13 Aire/Agua

Enrollador automático manguera
Longitud 16 m
Presión máx. 15 bar
Racor salida 1/2"

335€

Ø INTERIOR 12,5 MM



CA-1815PRO Aire/Agua

Enrollador automático manguera
Metálico
Longitud 15 m
Conexión 3/8"
40 bar

119€

Ø EXTERIOR 15,5 MM
Ø INTERIOR 9,5 MM



CA-1810 Aire

Enrollador automático manguera
Plástico
Longitud 10 m
Conexión 1/4"
10 bar

49€

Ø EXTERIOR 10 MM
Ø INTERIOR 6,5 MM



CA-4315-GS Eléctrico

Enrollador automático
1,5 H 05 VVF
Longitud 15 m
Incluye enchufe térmico de protección



229€

CABLE 3G



EQUILIBRADORES DE CARGA

Para manejar herramientas u objetos según peso.

 Cable de acero
 Carcasa de aluminio



REFERENCIA	CARGA (Kg)	LONGITUD CABLE (m)	Ø CABLE (mm)	PRECIO
CA-630	0,4-1,0	1,6	2	30,00 €
CA-631	1,0-2,0	1,6	2	38,00 €
CA-633	2,0-4,0	2,5	2,5	83,00 €
CA-634	4,0-6,0	2,5	2,5	104,00 €
CA-637	10,0-14,0	2,5	2,5	109,00 €



HERRAMIENTA NEUMÁTICA Y ACCESORIOS

CAKIT8PRO

Kit aerográfico 8 piezas para compresor
Pistola de pintar, de petroleo, soplador, inflador, espiral 5 m, 3 boquillas

39€

Conexión rápida



CA-CK3300

Kit aerográfico 5 piezas para compresor
Pistola de soplar, petroleo, soplador, inflador, espiral 5 m

25€

Conexión rápida



CA-CK220

Kit aerográfico 6 piezas para compresor
Pistola de soplar, hinchador, espiral 5 m, 3 boquillas.

17€

Conexión rápida



RACORES

REFERENCIA	DESCRIPCIÓN	PRECIO
CA-RM6033-7	MACHO - RECTO - Ø 8-1/8	2,50 €
CA-RM6033-8	MACHO - RECTO - Ø 8-1/4	2,50 €
CA-RM6039-5	EN " L" - Ø 8-1/8	4,90 €
CA-RM6039-6	EN " L" - Ø 8-1/4	5,50 €
CA-RT6115-3	ANGULAR - Ø 8 INTERMEDIO	2,50 €
CA-RT6116-3	EN " T" - Ø 8 INTERMEDIO	2,80 €
CA-RT6117-3	EN " Y" - Ø 8 INTERMEDIO	2,80 €
CA-RT6101-8	MACHO EN " L" - Ø 8-1/4 TECNO POLÍMERO	2,50 €



CA-MANGUERA10

Manguera de goma
20 bar
En blíster

19€

10 m



CA-MANGUERA20

Manguera de goma
20 bar
En blíster

33€

20 m



CA-MANGUERA50

Manguera de poliuretano
20 bar

55€

50 m



HERRAMIENTA NEUMÁTICA Y ACCESORIOS

CA-270

Reductor macho-hembra

REF.	CONEXIÓN	PRECIO
CA-270/1	1/8" - 1/4"	2,85 €
CA-270/3	1/4" - 3/8"	3,04 €
CA-270/6	3/8" - 1/2"	4,03 €
CA-270/9	1/2" - 3/4"	4,43 €



CA-280

Conexión hembra

REF.	CONEXIÓN	PRECIO
CA-280/5	1/4" - 1/4"	4,46 €
CA-280/8	3/8" - 3/8"	4,17 €
CA-280/10	1/2" - 1/2"	6,08 €



CA-290

Reductor macho-macho

REF.	CONEXIÓN	PRECIO
CA-290/2	1/8" - 1/4"	2,99 €
CA-290/5	1/4" - 1/4"	2,99 €
CA-290/6	1/4" - 3/8"	3,23 €
CA-290/8	3/8" - 3/8"	3,23 €
CA-290/9	3/8" - 1/2"	3,89 €
CA-290/10	1/2" - 1/2"	3,89 €



CA-495

Llave de paso

REF.	CONEXIÓN	PRECIO
CA-495/1	1/4" H-H	10,92 €
CA-495/2	3/8" H-H	10,92 €
CA-495/3	1/2" H-H	17,02 €



CA-1110

Boquilla válida para neumáticos
Ø 6 mm

2,32 €



CA-1110/5

Kit de accesorios universales
para inflado

4,05 €



CA-495/5P

Llave de paso
De 1/4" M-M

6,69 €



CA-445

Conexión rápida para manguera

REF.	Ø CONEXIÓN (mm)	PRECIO
CA-445/3	6	2,13 €
CA-445/4	8	1,83 €



CA-449

Conexión rápida

Rosca hembra

REF.	CONEXIÓN	PRECIO
CA-449/2	1/4"	1,83 €
CA-449/7	3/8"	3,16 €

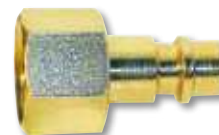

CA-450

Conexión rápida

Rosca macho

REF.	CONEXIÓN	PRECIO
CA-450/2	1/4"	1,83 €
CA-450/7	3/8"	2,92 €



CA-490

Grifo purgador

REF.	CONEXIÓN	PRECIO
CA-490/1	1/4"	3,77 €
CA-490/2	3/8"	4,26 €



CA-565

Válvula de seguridad

REF.	bar	CONEXIÓN	PRECIO
CA-565/4	11	3/8"	8,51 €
CA-565/1	8,8	1/4"	4,86 €
CA-565/2	10,5	1/4"	14,00 €



HERRAMIENTA NEUMÁTICA Y ACCESORIOS

CA-466/2

Enchufe rápido universal de seguridad para manguera Ø 8 mm

18€



CA-469

Enchufe rápido universal de seguridad.

Rosca hembra

REF.	CONEXIÓN	PRECIO
CA-469/1	1/4"	18,00 €
CA-469/2	3/8"	18,00 €



CA-470

Enchufe rápido universal de seguridad.

Rosca hembra

REF.	CONEXIÓN	PRECIO
CA-470/1	1/4"	18,00 €
CA-470/2	3/8"	18,00 €
CA-470/3	1/2"	18,00 €



CA-456

Enchufe rápido universal con racor para manguera

REF.	Ø CONEXIÓN (mm)	PRECIO
CA-456/1	6	7,29 €
CA-456/2	8	4,86 €
CA-456/3	10	5,96 €



CA-459

Enchufe rápido universal

Rosca hembra

REF.	CONEXIÓN	PRECIO
CA-459/1	1/4"	4,86 €
CA-459/2	3/8"	5,56 €
CA-459/3	1/2"	7,76 €



CA-460

Enchufe rápido universal

Rosca macho

REF.	CONEXIÓN	PRECIO
CA-460/1	1/4"	4,86 €
CA-460/2	3/8"	5,83 €
CA-460/3	1/2"	6,08 €



CA-260

Racor en "L"

REF.	CONEXIÓN	PRECIO
CA-260/1	1/8" - 1/8"	3,83 €
CA-260/2	1/4" - 1/4"	4,02 €
CA-260/3	3/8" - 3/8"	4,13 €



PURGADOR

Grifo purgador con llave

REF.	CONEXIÓN	PRECIO
CA-PRO80SILEN68	1/4"	4,99 €
CA-9047079F	3/8"	5,99 €



CA-485

Racor 3 vías, 2 hembras y 1 macho. 1/4" - 1/4"

4,62€



CA-49A

Doble tuerca fresada 1/4" - 1/4"

3,65€



NE-KN8055

Mini lubricador 1/4"

5,48€





VÁLVULA ANTI-RETORNO

REFERENCIA	PARA COMPRESOR	PRECIO
CA-PRO25VX-57	VX	9,84 €
CA-PRO24R1063	Directo (excepto VX)	7,52 €
CA-PRO6SILENT43	Silencioso	7,52 €
CA1127190009	Correas (3HP)	36,75 €



CODO

REFERENCIA	PARA COMPRESOR	PRECIO
CA-PRO24R1043	Directo	2,03 €
CA-PRO6SILENT47	Silencioso	1,74€
CA1127080016	Correas (3HP)	13,02 €



CA-740

Manómetro
Rosca inferior
Ø 63 mm
1/4 "

10,42€

■ || 12 bar



CA-760

Manómetro
Rosca trasera
Ø 63 mm
1/4 "

10,42€

■ || 16 bar



CA-780

Manómetro
Rosca trasera
Ø 50 mm
1/4 "

8,10€

■ || 12 bar



CA-790

Manómetro
Rosca trasera
Ø 40 mm
1/8 "

8,10€

■ || 12 bar



HERRAMIENTA NEUMÁTICA Y ACCESORIOS

CA-PRO25VX-27 ■|| 3/8i

Filtro de plástico profesional para compresores

9€



CA-PRO100VC-16 ■|| 3/8i

Filtro de plástico profesional para compresores

9€

CON CARTUCHO FILTRANTE



CA-875/5 ■|| 3/8i - 1/2i

Filtro plástico profesional para compresores

6€



CA-875/6 ■|| 1/2i

Filtro metálico profesional para compresores

9€

CON SILENCIADOR



CA-875/8 ■|| 1/2i

Filtro metálico profesional para compresores

9€



CA-970PRO

Regulador de presión con manómetro

14€



CA-950/1 ■|| 3/8i

Regulador de presión con manómetro y 2 enchufes rápidos
180 L/min
0 - 12 bar
Conexión macho

32,82€



CA-950/2 ■|| 1/2i

Regulador de presión con manómetro y 2 enchufes rápidos
180 L/min
0 - 16 bar
Conexión macho

43,76€



CA-924 ■|| 1/4i

Grupo filtro reductor lubricador
240 L/min
0-12 bar
8,4 C.M.F.
14,4 m³/h

65,54€



CA-930/12 ■|| 3/8i - 1/2i

Grupo filtro reductor lubricador
450 L/min
0-12 bar
15,8 C.M.F.
27 m³/h

90,41€



HERRAMIENTA NEUMÁTICA Y ACCESORIOS

CA-922

Regulador de presión con manómetro y filtro
240 L/min
1/4"
0-12 bar
8,4 C.M.F.
14,4 m3/h

29,17€



CA-940/12

Regulador de presión con manómetro y filtro
450 L/min
3/8" y 1/2"
0-12 bar
15,8 C.M.F.
27 m3/h

55,91€



CA-920

Filtro purificador
Conexión hembra 1/4"

25,53€



CA-919/12

Filtro purificador
Conexión hembra:
3/8" - 1/2"

44,97€



CA-921

Lubricador de aceite
42 cc
Conexión hembra:
1/4" - 1/4"
0-12 bar

27,96€



CA-929/12

Lubricador de aceite
68 cc
Conexión hembra:
3/8" - 1/2"
0-12 bar

43,76€



CA-871/1

Presostato con válvula de arranque.
8 bar.
Potencia: 2 HP
Monofásico.

18,85€

Conexión rápida 4 vías



CA-871/2

Presostato con válvula de arranque.
Monofásico con rosca para:
Huracán, Tornado,
Tifón, Pro 6,
Pro 24, Pro 50.

13,89€

8 Bar 4 vías



CA-840/1

Presostato sin válvula de arranque.
10 bar.
Potencia:
de 2 HP a 3 HP.
4-6,3 A

75€

10 Bar



CA-840/2

Presostato sin válvula de arranque. 380 V
Potencia:
de 3 HP a 5,5 HP
6-10 A

75€

12 Bar



CA-840/3

Presostato sin válvula de arranque. 380 V
Potencia:
de 4 HP a 7,5 HP
10-16 A

75€

12 Bar



CA-871/2/1

Presostato rosca 1 vía
Monofásico
Potencia:
2 HP

19,95€

8 Bar





#PROFESIONALES
TRABAJANDO PARA
PROFESIONALES

SOLDADURA

CE-MINI125

■ Digital

230 V - 50/60 Hz
120 A - Ø electrodo: 1,6 - 3,25 mm
60 V - 4,6 kW
3,3 Kg

79€

MMA



CE-MINI145X

■ Reducido tamaño

230 V - 50/60 Hz
140 A - Ø electrodo: 1,6-3,25 mm
58 - 62 V - 4,6 kW
2 Kg

99€

MMA
TIG
DC
LIFT



CE-SMART160

■ Display LCD

230 V - 50/60 Hz - 160 A
Ø electrodo: 1.6 - 4 mm
Incluye: pinza masa, pinza portaelectrodo y cepillo.

119€



MMA
HOT START
ARC FORCE
ANTI-STICK



CE-SMART200

■ Display LCD

230 V - 50/60 Hz - 200 A
Ø electrodo: 1.6 - 4 mm
Incluye: pinza masa, pinza portaelectrodo y cepillo.

149€

MMA
HOT START
ARC FORCE
ANTI-STICK



CE-ULTRA170LCD

230 V - 50/60 Hz - 170 A
 Ø electrodo: 1,6-4,0 mm
 56 V
 5 Kg
 Pantalla Din 9-13

Profesional
 Display LCD

159€

MMA
 TIG
 DC
 LIFT



CE-ULTRA200LCD

230 V - 50/60 Hz - 200 A
 Ø electrodo: 1,6-5,0 mm
 56 V
 7,1 Kg
 Pantalla Din 9-13

Profesional
 Display LCD

179€

MMA
 TIG
 DC
 LIFT



CE-TITANIUM162

230 V - 50/60 Hz - 160 A
 Ø electrodo: 1,6-4,0 mm
 73 V
 9,3 Kg

Display LCD



219€

MMA
 TIG
 DC
 LIFT



CE-TITANIUM202

230 V - 50/60 Hz - 200 A
 Ø electrodo: 1,6-5,0 mm
 58 V
 6,4 Kg

Display LCD



249€

MMA
 TIG
 DC
 LIFT



CE-MINIMIG120N

■ Hilo sin gas

230 V - 50/60 Hz - 120 A.
 Ø electrodo: 2,5 mm
 Ø hilo: 0,8-1,0 mm
 4 Kg

119€

MMA
 FLUX
 LIFT TIG



CE-ANTORCHA120N incluida.

CE-PROMIG130N

■ Hilo sin gas

230 V - 50/60 Hz - 130 A.
 Ø electrodo: 1,6-2,5 mm
 Ø hilo: 0,8-1,0 mm
 Bobina max.: 1 Kg - (100 mm)
 7,9 Kg

159€

MMA
 FLUX
 LIFT TIG



CE-ANTORCHA130N incluida.

CE-PROMIG170

■ Pantalla LCD
 SinÉrgico

230 V - 50/60 Hz - 20-160 A.
 Ø electrodo: 1,6-3,25 mm
 Ø hilo max.: 1,0 mm
 Bobina max.: 5 Kg (100 mm)
 Conexión D: Ø 50
 6,5 Kg

315€

MMA
 MIG-MAG
 LIFT TIG



CE-AM15-3M incluida.

CE-PROMIG200P

■ Pantalla LCD
 SinÉrgico

230 V - 50/60 Hz - 200 A.
 Ø electrodo: 1,6-4,0 mm
 Ø hilo max.: 1,2 mm
 Bobina max.: 5 Kg (200 mm)
 Conexión D: Ø 50
 12 Kg

559€

MMA
 MIG-MAG
 FLUX
 LIFT TIG
 PULSADO
 DOBLE PULSADO



CE-TROLLEY
 P.V.P.: 129,00€ opcional



CE-PROMIG215P

■ Pantalla LCD
 SinÉrgico

230 V - 50/60 Hz - 220 A.
 Ø electrodo: 1,6-4 mm
 Ø hilo max.: 1,0 mm
 Bobina max.: 15 Kg (300 mm)
 Conexión D: Ø 50
 20 Kg

769€

MMA
 MIG-MAG
 FLUX
 LIFT TIG



CE-AM25-3M incluida.

CE-TROLLEY P.V.P.: 129,00€ opcional



CE-PROMIG291

230 V - 50/60 Hz - 250 A.
 Ø electrodo: 1,6-4,0 mm
 Ø hilo max.: 1,2 mm
 Ø electrodo TIG: 3,2 mm
 Bobina max.: 15 Kg (300 mm)
 32,24 Kg

1.199€



Pantalla LCD SinÉrgico

MMA
MIG-MAG
FLUX
LIFT TIG



CE-AX36/3M incluida.

Incluye: pinza masa, pinza portaelectrodo, conector, 4 roldanas, toberas y llave

CE-PROMIG301

400 V - 50/60 Hz - 300 A.
 Ø electrodo: 1,6-5,0 mm
 Ø hilo max.: 1,2 mm
 Ø electrodo TIG: 4,0 mm
 Bobina max.: 15 Kg (300 mm)
 33 Kg

1.299€



Pantalla LCD SinÉrgico

MMA
MIG-MAG
FLUX
LIFT TIG



CE-AX36/3M incluida.

Incluye: pinza masa, pinza portaelectrodo, conector, 4 roldanas, toberas y llave

CE-PROMIG315DP

400 V - 50/60 Hz - 300 A.
 Ø electrodo: 1,6-4,0 mm
 Ø hilo max.: 1,2 mm
 Ø electrodo TIG: 4,0 mm
 Bobina max.: 15 Kg (300 mm)
 33,45 Kg

1.699€



Pantalla LCD SinÉrgico

MMA
MIG-MAG
FLUX
LIFT TIG

DOBLE PULSADO



CE-AX36/3M incluida.

Incluye: pinza masa, pinza portaelectrodo, conector, 6 roldanas, toberas y llave sirga para aluminio.

SOLDADURA **3 EN 1**

CE-PROMIG343WAV

230 V - 50/60 Hz. - 220 A
 Ø electrodo: 1,6-4,0 mm
 Ø hilo max.: 1,2 mm
 Bobina max.: 15 Kg
 (3 uds.) (300 mm)
 Incluye 3 antorchas,
 6 roldanas, pinza de masa

Sin Èrgico
3 bobinas posibles



3.599€

CE-AX15-3M incluidas



TE-742708 incluida



MMA
 MIG-MAG
 FLUX
 LIFT TIG

PULSADO
 DOBLE PULSADO

ESPECIAL
 AUTOMOCIÓN



CE-PROMIG500DP

400 V - 50/60 Hz - 500 A.
 Ø electrodo: 1,6-4,0 mm
 Ø hilo max.: 1,6 mm
 Ø electrodo TIG: 4,0 mm
 Bobina max.: 15 Kg (300 mm)
 95 Kg

Multiproceso
Pantalla LCD



3.999€



CE-MT501 incluida

Incluye: pinza masa, pinza portaelectrodo,
 conector, 8 roldanas, toberas y
 llave sirga para aluminio

MMA
 MIG
 TIG

DOBLE PULSADO

PARA INOXIDABLE,
 ALUMINIO, ACERO
 Y ACERO INOX



REFRIGERADO POR AGUA

Opcional: Extensión 10 m
 CE-PROMIG500EX
 P.V.P.: 499,00€
 Antorcha CE-MT501
 P.V.P.: 215,00€

CE-TITANTIG220P

230 V 50/60 Hz 10-220 (TIG)
 Ø electrodo: 1,6 - 4,0 mm
 Ø electrodo TIG: 3,2 mm
 Incluye: Antorcha Tig, pinza portaelectrodos y pinza de masa.

Pre y post gas
 Pantalla VRD

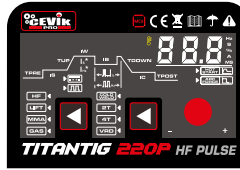

399€

MMA
 TIG LIFT
 HF

PARA ACERO
 Y ACERO INOX

PULSADO



CE-TORCHASR17 incluida

Opcional:
 CE-TORCHATIG268 P.V.P.: 109,00€
 CE-TORCHATIG26 P.V.P.: 79,00€

CE-TIG201ACDC

230 V 50/60 Hz
 200A TIG - 200A MMA
 Ø electrodo: 1.6 - 4 mm
 Ø electrodo: TIG 1.6 -3.25 mm
 Factor de marcha TIG al 30%: 200A
 Incluye: Antorcha Tig, pinza portaelectrodos y pinza de masa.

Aluminio
 AC-DC



799€

MMA AC/DC
 TIG AC/DC
 HF LIFT

PULSADO



CE-TORCHATIG26 incluida.

Opcional: CE-TORCHATIG268
 P.V.P.: 109,00€



Opcional: CE-PEDALTIG201
 P.V.P.: 89,00€

ACCESORIOS TIG

TE-804138

Kit de consumibles para antorchas TIG SR.17 y S.26

42€



CE-TORCHATIG26

Antorcha para soldadura TIG. 4 m Ø 35-50 mm

79€



CE-TORCHATIG268

Antorcha para soldadura TIG. 8 m Ø 35-50 mm

109€



TE-804127

Soporte para antorcha TIG. Base magnética (86 mm) Colocación horizontal o vertical.

17€



CORTE PLASMA

ACCESORIOS CORTE PLASMA

CE-CUT55KIT

29€



CE-CUT61KIT

79€



CE-CUT100KIT

149€



CE-CUT55TORCHA

55€



CE-CUT61TORCHA

129€



CE-CUT100TORCHA

6 m

299€



CE-CUT55

230 V
50/60 Hz
10-55 A
195 L/min
4-5 bar

299€

Corte m.x. 20 mm
Recomendado 15 mm



Incluye:
Antorcha completa y pinza masa.

CE-CUT61

230 V - 400 V
50/60 Hz
20-50/20-60 A
195 L/min
4-5 bar

799€

Corte m.x. 30 mm
Recomendado 20 mm

PUEDA CONECTARSE A CNC



Incluye:
Antorcha completa y pinza masa.

CE-CUT100

400 V
50/60 Hz
20-100 A
300 L/min
4-5 bar

1.699€

Corte m.x. 40 mm
Recomendado 30 mm

PUEDA CONECTARSE A CNC



Incluye:
Antorcha completa, pinza masa y manómetro.

Accesorios opcionales:

REFERENCIA	UDS	PRECIO
CE-CUT55-EL	10	38 €
CE-CUT55-BUZA	10	41 €
CE-CUT55-PORT	2	9 €



Accesorios opcionales:

REFERENCIA	UDS	PRECIO
CE-CUT61-BUZA	5	37 €
CE-CU61-DIF	5	39 €
CE-CUT61-EL	10	39 €
CE-CUT61-PORT	1	9 €

Accesorios opcionales:

REFERENCIA	UDS	PRECIO
CE-CUT100-BUZA	10	45 €
CE-CU100-DIF	2	29 €
CE-CU100-EL	10	39 €
CE-CU100-PORT	2	30 €
CE-CU100-SEP	1	12 €

ACCESORIOS DE SOLDADURA

ANTORCHAS - SOLDADURA MIG

MT15

Antorcha para soldadura con hilo.
Disponible en 2, 3 y 4 m



REF.	PARA HILO	PRECIO
CE-AX15/2MALU	ALUMINIO	74 €
CE-AM15-3M	ACERO, INOX, FLUX	49 €
CE-AX15/4M	ACERO, INOX, FLUX	64 €

MT25

Antorcha para soldadura con hilo.
Disponible en 2, 3, 4 y 5 m



REF.	PARA HILO	PRECIO
CE-AX25/2MALU	ALUMINIO	85 €
CE-AM25-3M	ACERO, INOX, FLUX	59 €
CE-AX25/4M	ACERO, INOX, FLUX	85 €
CE-AX25/5M	ACERO, INOX, FLUX	109 €

MT36

Antorcha para soldadura con hilo.
Disponible en 3, 4 y 5 m



REF.	PARA HILO	PRECIO
CE-AX36/3M	ACERO, INOX, FLUX	109 €
CE-AX36/4M	ACERO, INOX, FLUX	119 €
CE-AX36/5M	ACERO, INOX, FLUX	139 €

CE-SPOOLGUN200

Antorcha con bobina de hilo
para aluminio 0,8 gr

179€

VÁLIDA PARA MODELOS:
PROMIG200P-215-291
301-315DP



CP-SIRGA4MT

Sirga aluminio 4m

15€



ACCESORIOS ANTORCHAS - SOLDADURA MIG

CP-KITMT15

Kit completo de accesorios para antorcha de hilo MT15.

17€

REFERENCIA	CONTENIDO	PRECIO
CP-KITTOBERA	2 TOBERAS	9,00 €
CP-PUNTA0,8	5 PUNTAS 0,8 mm	7,00 €
CP-PUNTA1,0	5 PUNTAS 1,0 mm	5,90 €
CP-PUNTA1,2AL15	5 PUNTAS ALUMINIO / ANIMADO 1,2 mm	9,50 €
CP-DIFUSOR15	2 DIFUSORES	7,00 €
CP-MUELLE15	2 MUELLES	2,36 €

CP-KITMT25

Kit completo de accesorios para antorcha de hilo MT25.

20€

REFERENCIA	CONTENIDO	PRECIO
CP-KITTOBERA25	2 TOBERAS	10,00 €
CP-PUNTA0,825	5 PUNTAS 0,8 mm	9,00 €
CP-PUNTA1,025	5 PUNTAS 1,0 mm	8,25 €
CP-PUNTA1,2AL25	5 PUNTAS ALUMINIO / ANIMADO DE 1,2 mm	9,00 €
CP-DIFUSOR25	2 DIFUSORES	10,00 €
CP-MUELLE25	2 MUELLES	5,50 €

CP-KITMT36

Kit completo de accesorios para antorcha de hilo MT36.

59€

REFERENCIA	CONTENIDO	PRECIO
CP-KITTOBERA36	3 TOBERAS	22,00 €
CP-PUNTA0,836	10 PUNTAS 0,8 mm	12,00 €
CP-PUNTA1,036	10 PUNTAS 1,0 mm	12,00 €
CP-PUNTA1,236	10 PUNTAS 1,2 mm	12,00 €
CP-DIFUSOR36	3 DIFUSORES	12,00 €
CP-PORTATUBO36	3 PORTATUBOS	5,50 €

Válido para Promig 291-301-315DP



ACCESORIOS DE SOLDADURA

BOBINAS HILO - SOLDADURA MIG



ANIMADO-SIN GAS-FLUX

REFERENCIA	Ø BOBINA (mm)	Ø HILO (mm)	BOBINA (Kg)	PRECIO
CP-HILOANIMO,8N	100	0,8	0,8	17,00 €
CP-HILOANIMO,9N	100	0,9	0,8	17,00 €
CP-HILOANIM3KG	200	0,8	3	69,00 €
CP-HILOANIM30,9	200	0,9	3	69,00 €

INOXIDABLE ■ ■ 308L

REFERENCIA	Ø BOBINA (mm)	Ø HILO (mm)	BOBINA (kg)	PRECIO
CP-HILOINOX0,8	100	0,8	0,8	29,00 €
CP-HILOINOX1,0	100	1	0,8	29,00 €
CP-HILOINOX5KG	200	0,8	5	149,00 €
CP-HILOINOX51,0	200	1	5	139,00 €
CP-HILOINOX15KG	300	0,8	15	339,00 €

CUSI

REFERENCIA	Ø BOBINA (mm)	Ø HILO (mm)	BOBINA (kg)	PRECIO
CP-HILOCUSI0,8	100	1	0,8	48,00 €
CP-HILOCUSI5KG	200	0,8	5	237,00 €

ACERO ■ ■ ER70S

REFERENCIA	Ø BOBINA (mm)	Ø HILO (mm)	BOBINA (Kg)	PRECIO
BR-300962	100	0,6	0,2	5,50 €
BR-300982	100	0,8	0,2	5,50 €
CP-HILOACE0,8	100	0,8	0,8	9,99 €
CP-HILOACE5KG	200	0,8	5	29,00 €
CP-HILOACE51.0	200	1	5	29,00 €
CP-HILOACE15KG	300	0,8	15	59,00 €
CP-HILOACE151.0	300	1	15	59,00 €
CP-HILOACE151.2	300	1,2	15	59,00 €

ALUMINIO ■ ■ ALMg5% (5356)

REFERENCIA	Ø BOBINA (mm)	Ø HILO (mm)	BOBINA (kg)	PRECIO
CP-HILOALU0,8	100	0,8	0,5	25,00 €
CP-HILOALU2KG	200	0,8	2	59,00 €
CP-HILOALU2K1.0	200	1	2	59,00 €

ROLDANAS - SOLDADURA MIG

Rodillo de arrastre para equipos de hilo.

REFERENCIA	PARA HILO	Ø HILO (mm)	PARA MODELO	PRECIO
CE-ROLDA-PROMIG	ACERO	0,6-0,8		20,20 €
CE-PROMIG200-52	ACERO	0,8-1,0	Para PROMIG 165/170 200	17,98 €
CE-PROMIG200-AN	ANIMADO	0,8-1,0		17,98 €
CE-PROMIG200-AL	ALUMINIO	0,8-1,0		22,72 €
CE-PROMIG215AC	ACERO	0,6-0,8		15,00 €
CE-PROMIG215AC2	ACERO	0,8-1,0	Para PROMIG 200P y 215	15,00 €
CE-PROMIG215AN	ANIMADO	0,8-1,0		15,00 €
CE-PROMIG215AL	ALUMINIO	0,8-1,0		15,00 €
CE-PROMIG215AL2	ALUMINIO	1,0-1,2		CONSULTAR
TE-742090	ALUMINIO	0,8-1,0		24,38 €
TE-722575	ACERO	0,6-0,8	Para PROMIG 220P	21,20 €
TE-742054	ACERO	1,0-1,2		18,02 €
TE-722130	ANIMADO	1,0-1,2		33,92 €

REFERENCIA	PARA HILO	Ø HILO (mm)	PARA MODELO	PRECIO
CE-PROMIG291AC	ACERO	0,8-1,0		17,00 €
CE-PROMIG291AC2	ACERO	1,0-1,2	Para PROMIG 291/301 315DP 500DP	17,00 €
CE-PROMIG291AL	ALUMINIO	0,8-1,0		17,00 €
CE-PROMIG291AL2	ALUMINIO	1,0-1,2		CONSULTAR
CE-PROMIG291AN	ANIMADO	0,8-1,0		19,00 €
TE-742575	ACERO	0,6-0,8	Para PROMIG 343WAV	CONSULTAR
TE-742576	ACERO	0,6-0,8		7,77 €
TE-722167	ALUMINIO	1,0-1,2		21,37 €



ACCESORIOS DE SOLDADURA

ACCESORIOS - SOLDADURA MIG

CE-GASCO2PLUS ■ ■ CO2

Bombona. 1 L
No recargable
Tara: 1.190 g
Test de presión: 145 bar
Rosca: M10

21€

PARA HILO DE ACERO



CE-GASARGONPLUS ■ ■ ARG" N

Bombona. 1 L
No recargable
Tara: 1.190 g
Presión a +20°: 110 bar
Test de presión: 145 bar
Rosca: M10

21€

PARA HILO DE ALUMINIO
Y SOLDADURA TIG



CE-GASMIXTOPLUS ■ ■ CO2 (20%) ARG" N (80%)

Bombona. 1 L
No recargable
Presión a +20°: 110 bar
Test de presión: 145 bar
Rosca: M10

21€

PARA HILO DE INOXIDABLE



CP-RG2

Mano reductor para regular la presión de salida del gas

64€



TE-722120

Mano reductor para regular la presión de salida del gas

34€



CP-KITENLACE

Kit enlace para bombona
Para conectar el inverter a la bombona de gas

■ ■ NO RECARGABLE

49€



ACCESORIOS - SOLDADURA

CP-KITMMA10-25 ■ ■ y 10-25 mm²

Juego pinza masa y pinza porta-electrodos
Cable: 1.4 m
Ø 16 mm²

19€



CE-KITMMA35-50 ■ ■ y 35-50 mm²

Juego pinza masa y pinza porta-electrodos
Cable: 2 m
Ø 35 mm²

29€



PINZAS MASA

REFERENCIA	AMPERAJE (A)	PRECIO
CP-PINZAM150A	150	3,50 €
CP-PINZAM300A	300	5,90 €
CP-PINZAM600A	600	10,60 €



PINZAS PORTAELECTRODOS

REFERENCIA	AMPERAJE (A)	PRECIO
CP-PINZA150A	150	8,25 €
CP-PINZA300A	300	14,20 €
CP-PINZA600A	600	16,50 €



CONECTORES

REFERENCIA	TIPO	Ø CONEXIÓN (mm)	CANTIDAD (ud.)	PRECIO
CP-CONEC25M	MACHO	25	2	4,00 €
CP-CONEC50M	MACHO	50	1	7,00 €
CP-CONEC25H	HEMBRA	25	2	4,00 €
CP-CONEC50H	HEMBRA	50	2	9,00 €
AW-M00581SP	ADAPTADOR	25-50	1	15,00 €



ACCESORIOS DE SOLDADURA

CABLES DE SOLDADURA

REFERENCIA	LONGITUD (m)	SECCIÓN (mm ²)	PRECIO
CP-CABLEPRO16	10	16	42,00 €
CP-CABLEPRO25	10	25	58,00 €



PIQUETAS

REFERENCIA	CARACTERÍSTICAS	PRECIO
CP-PIQUETA	MANGO MADERA	7,00 €
CP-PIQUETAH	MANGO HIERRO	8,85 €



ELECTRODOS - SOLDADURA MMA

ELECTRODO BÁSICO (BLÍSTER) ■ ■ E-7016

REFERENCIA	BLÍSTER (uds.)	MEDIDAS (mm)	PRECIO
CP-BA2,0BLIS	30	2,0	4,95 €
CP-BA2,5BLIS	20	2,5	4,95 €



ELECTRODOS RUTILO (CAJA) ■ ■ E-6013

REFERENCIA	CAJA (uds.)	MEDIDAS (mm)	PRECIO
CP-RU2,0CAJA50	50	2,0	4,95 €
CP-RU2,5CAJA50	50	2,5	4,95 €
CP-RU3,25CAJA50	50	3,25	4,95 €
CP-RU2,0CAJA200	200	2,0	13,50 €
CP-RU2,5CAJA225	225	2,5	17,50 €
CP-RU3,25CAJ140	140	3,25	18,60 €
CP-RU4,0CAJA100	100	4,0	18,60 €



ELECTRODOS RUTILO (BLÍSTER) ■ ■ E-6013

REFERENCIA	BLÍSTER (uds.)	MEDIDAS (mm)	PRECIO
CP-RU1,6BLIS	30	1,6	6,20 €
CP-RU2,0BLIS	20	2,0	3,75 €
CP-RU2,5BLIS	20	2,5	3,75 €
CP-RU3,25BLIS	20	3,25	3,75 €



ELECTRODOS PARA INOXIDABLE (BLÍSTER) ■ ■ E-308L

REFERENCIA	BLÍSTER (uds.)	MEDIDAS (mm)	PRECIO
CP-INOX1,6	10	1,6	11,15 €
CP-INOX2,0	10	2,0	13,70 €
CP-INOX2,5	10	2,5	13,70 €
CP-INOX3,25	10	3,25	16,00 €

■ ■ E-316L

REFERENCIA	BLÍSTER (uds.)	MEDIDAS (mm)	PRECIO
CP-INOX316-1,6	10	1,6	4,57 €
CP-INOX316-2,0	10	2,0	5,71 €
CP-INOX316-2,5	10	2,5	7,11 €

ELECTRODOS PARA ALUMINIO (BLÍSTER) ■ ■ ALSI 12

REFERENCIA	BLÍSTER (uds.)	MEDIDAS (mm)	PRECIO
CP-ALU2,5	10	2,5	15,00 €
CP-ALU3,25	10	3,25	19,80 €

ELECTRODOS PARA FUNDICIÓN (BLÍSTER) ■ ■ 98% NÖQUEL NICKL

REFERENCIA	BLÍSTER (uds.)	MEDIDAS (mm)	PRECIO
CP-FE2.5BLIS	15	2,5	34,29 €
CP-FE3.25BLIS	10	3,25	44,57 €

■ ■ 55% ENIFE-CL

REFERENCIA	BLÍSTER (uds.)	MEDIDAS (mm)	PRECIO
CP-NIFE2.5BLIS	15	2,5	25,14 €

CE-PANTALLA410 ■ Din 12

Ligera
Área de visión:
105x50 mm

5,99€



CE-SPRAY ■ Sin silicona

Spray antiadherente
para eliminación de
proyecciones de
soldadura y escorias.
400 ml

8,25€



CP-123/1 ■ Espesor piel 1,1 mm

Delantal de
serraje vacuno natural
de una pieza.
(90x60 cm)

18,88€



TE-804136 ■ 550

Protector anticalor.
1950 x 2000 mm

72€



TE-802679 ■ 1.100

Protector anticalor.
1500 x 1900 mm

177€



TE-804135 ■ 1.300

Protector anticalor.
1800 x 2000 mm

227€



KITS Y PANTALLAS DE PROTECCIÓN

Pantallas protectoras separadoras. Kits completos con soporte de metal y ruedas. Protegen de UV, arcos ligeros y chispas.

REFERENCIA	CARACTERÍSTICAS	MEDIDAS (mm)	PRECIO	REFERENCIA	CARACTERÍSTICAS	MEDIDAS (mm)	PRECIO
TE-802676	Pantalla individual roja	1740x1740	71,02 €	TE-803508	Kit pantalla roja + soporte	1850x670x1950	185,50 €
TE-802677	Pantalla individual verde	1740x1740	71,02 €	TE-803509	Kit pantalla verde + soporte	1850x670x1950	185,50 €



ACCESORIOS DE SOLDADURA

CE-104K

Kit de soldadura: Pantalla de soldar (cristal incluido 50X105 mm)
Guantes de vacuno (espesor piel: 1,1 mm)
Escuadra magnética 4" (hasta 22 kg)
Escuadra magnética 3" (hasta 15 kg)

14,95€



CP-085R

Guantes serraje vacuno natural con manguito de 15 cm
Longitud. total: 34,5 cm
Talla 10.

5,30€



Espesor piel 1,1 mm

AR-WELDERK

Guantes serraje profesional para soldadura TIG.
Serraje anti-calórico e hidrófugo.
Forro no inflamable.
Largo: 35 cm. Talla 10

6,99€



Espesor piel 1,2 mm

CE-TROLLEY

Carro para equipo de soldar. 2 alturas
Compatible con PROMIG-170/200P/215

129€



TE-804109

Pinza multiusos

19,50€



TE-804128

Soporte para antorcha MIG-MAG con base magnética de 86 mm

19€



ColocaciÛn horizontal o vertical

CP-ESCUADRA

Magnética.
Para soldaduras en 45° ó 90°
Imán protegido.
Especial estructuras metálicas

5€



Hasta 22 kg

TE-804255

Escuadra magnética para soldaduras en 45°, 90° y 135°
Dispone de imán de activación ON/OFF

45€



Hasta 40 kg

TE-804256

Escuadra magnética para soldaduras en 45°, 90° y 135°
Dispone de imán de activación ON/OFF

66€



Hasta 70 kg

SOLDADURA TIG

ELECTRODOS PARA ALUMINIO

Tungsteno Puro. CA.

Electrodo verde

REFERENCIA	CAJA (uds.)	MEDIDAS (mm)	PRECIO
TE-802234	10	1,0	21,20 €
TE-802235	10	1,6	34,98 €
TE-802236	10	2,4	72,08 €
TE-802237	10	3,2	120,84 €



ELECTRODOS PARA ACEROS

Tungsteno/Cerio al 2%.

Electrodo gris

REFERENCIA	CAJA (uds.)	MEDIDAS (mm)	PRECIO
CE-TIGINOX1,6T	2	1,6	11,15 €
TE-802220	10	1,0	21,20 €
TE-802222	10	1,6	33,92 €
TE-802232	10	2,4	67,84 €
TE-802233	10	3,2	116,60 €



CE-TORCHA.SR17

Antorcha para soldadura TIG
Ø 10-25 mm
Válida también para Inverter
MMA y MIG

Longitud 4 m

69€



CE-TORCHA50.S26

Antorcha para soldadura TIG
Ø 35-50 mm
Válida también para Inverter
MMA y MIG

Longitud 4 m

99€



VARILLAS DE APORTACIÓN TIG

REFERENCIA	MEDIDAS (mm)	CARACTERÍSTICAS	CANTIDAD (uds.)	PRECIO
TE-804364	Ø 1,6 x 500	Inox 0,5 kg	62	19,43 €
TE-804365	Ø 2,0 x 500	Inox 0,5 kg	40	19,43 €
TE-804368	Ø 2,0 x 500	Alu 0,3 kg	66	12,64 €



ACCESORIOS TIG

REFERENCIA	KIT (uds.)	DESCRIPCIÓN Y MEDIDAS (mm)	PRECIO
CP-TIGDIFUSOR16	3	KIT DIFUSORES ELECTRODOS TIG 1,6	5,00 €
CP-TIGDIFUSOR20	3	KIT DIFUSORES ELECTRODOS TIG 2,0	5,00 €
CP-TIGDIFUSOR24	3	KIT DIFUSORES ELECTRODOS TIG 2,4	5,00 €
CP-TIGDIFUSOR32	3	KIT DIFUSORES ELECTRODOS TIG 3,2	5,00 €
CP-TIGPINZA16	3	KIT PINZAS PORTAELECTRODO TIG 1,6	5,00 €
CP-TIGPINZA20	3	KIT PINZAS PORTAELECTRODO TIG 2,0	5,00 €
CP-TIGPINZA24	3	KIT PINZAS PORTAELECTRODO TIG 2,4	5,00 €
CP-TIGPINZA32	3	KIT PINZAS PORTAELECTRODO TIG 3,2	5,00 €
CP-TIGCERAMICA4	10	KIT INYECTORES CERÁMICOS Nº4	8,00 €
CP-TIGCERAMICA5	10	KIT INYECTORES CERÁMICOS Nº5	8,00 €
CP-TIGCERAMICA6	10	KIT INYECTORES CERÁMICOS Nº6	8,00 €
CP-TIGCERAMICA7	10	KIT INYECTORES CERÁMICOS Nº7	8,00 €



CE-PEDALTIG201

Pedal con mando a distancia.
Controla el arco y la intensidad durante el proceso de soldadura.

Válido para CE-TIG201ACDC

89€



SOLDADURA AUTOMOCIÓN

PULLER 4000

230 V - 50/60 Hz
Corriente máx.: 2600 A
Potencia máx.: 7 kW
Tensión en vacío: 5,6 V
TE-828129

567€



DIGITAL PULLER 5500

230 V - 50/60 Hz
Corriente máx.: 3.800 A
Potencia máx.: 10,5 kW
Tensión en vacío: 5,6 V
TE-828127

799€



Pistola automática

Disponible en 400 V
P.V.P.: 809 €

DIGITAL PULLER 5500 DUO

230 V - 50/60 Hz
Corriente máx.: 3.800 A
Potencia máx.: 10,5 kW
Tensión en vacío: 5,6 V
Accesorios incluidos
TE-828131

1.050€

SINÉRGICO

ACERO

PANEL LCD

**Pistola manual
Pistola automática**



D-ARC200

Aluminio

230 V - 50/60 Hz
Corriente salida: 200 A
Tensión en vacío: 80 V
TE-816160

1.499€



"DELUXE BOX" - KIT CONSUMIBLES

50 arandelas planas AIMg, 50 arandelas planas ALSi, 50 arandelas rosca AIMg, 50 arandelas rosca ALSi, 50 pins ALSi, extractor, sostenedor.
TE-804412

367€

Consumibles disponibles:

ARANDELA PLANA (50 uds.)		PRECIO
TE-804140	AIMg	41,00 €
TE-804142	ALSi	60,00 €
TE-804250	Al 99,5%	41,00 €

ARANDELA ROSCA (50 uds.)		PRECIO
TE-804141	AIMg	41,00 €
TE-804143	ALSi	64,00 €
TE-804251	Al 99,5%	41,00 €

EXTRACTOR	PRECIO
TE-742778	34,00 €

SOSTENEDOR	PRECIO
TE-804147	31,00 €

PIN ALSI (50 uds.)	PRECIO
TE-804145	80,00 €





BATTERY PULLER

Soldadura por puntos sin cable
2800 A
Batería al Litio LiPo4
TE-828130

999€



T-RACTION 250

Sistema de polipasto manual.
Presión 6-8 bar
Con ruedas
40 kg
TE-804930

**Fuerza:
250 kg**

1.399€



KIT MULTI-GANCHOS

(6 ganchos + cáncamo)
TE-802700
P.V.P.: 41.40 €

SMART REPAIR **Especial abolladuras**

Kit profesional+pegamento
Incluye: ventosas, cola Elastic y cola Strong,
pistola de cola, martillo extractor, extractor de tracción,
martillo de aluminio con puntales intercambiables,
spray super remover para cola.
TE-804577

799€



SMART INDUCTOR 5000 DELUXE **Panel digital**

Calentador por inducción para operaciones
de extracción de partes de los vehículos.
200/240V - 50/60 Hz
2,4 kW
Calefacción: 35-100 kHz
2,3 kW.
TE-865012

2.475€



Incluye: Heat Twister, Metal Releaser, Super Remover, Glass Genius, Wonder Pen II, Pad Inductor y 3 palancas.

DOCTOR CHARGE 50 **Pantalla LCD**

Cargador multifunción
230 V 50/60 Hz 610 W
Tensión: 6-12-24 V
Corriente: 45/45/23 A
Capacidad: 40/40/20 Ah
TE-807613

426€

WET, GEL
MF, AGM
PB-CA
EFB, LI



DOCTOR CHARGE 130 **Pantalla LCD**

Cargador multifunción
230 V 50/60 Hz 1,8/2,00 W
Tensión: 12-16-24 V
Corriente: 140/70 A
Capacidad: 180 Ah
TE-807848

999€

WET, GEL
MF, AGM
PB-CA
EFB, LI



ACCESORIOS DE SOLDADURA

STUDDER BOX

TE-143780

Contiene: tornillos, arandelas, remaches, estrellas para tracción, calentadores de chapas y recalado.

82€



DENT PULLING KIT

TE-802838

Contiene: estrellas para tracción, arandelas, hilo ondulado.

59€



STUDDER READY BOX

TE-143722

Contiene: estrellas para tracción, arandelas, sostenes, remaches, calentadores de chapas y recalado.

49€



ESTRELLAS	REF.	PRECIO
ESTRELLAS FE-CU	TE-802296 100 uds.	66,00 €
MANDRIL	TE-722954	10,00 €

RECALCADO	REF.	PRECIO
ELECTRODO	TE-722963	9,00 €

REMACHES M5 - Ø5	REF.	PRECIO
18 mm	TE-802301 100 uds.	15,00 €

10 mm	TE-802299 100 uds.	11,20 €
-------	-----------------------	----------------

12 mm	TE-802302 100 uds.	14,00 €
-------	-----------------------	----------------

25 mm	TE-802304 100 uds.	15,00 €
-------	-----------------------	----------------

ELECTRODO M5 - M6	TE-722959	15,00 €
-------------------	-----------	----------------

MASA PARA PUNTEADO	REF.	PRECIO
-	TE-802462	16,00 €

REMACHES (M4)	REF.	PRECIO
15 mm	TE-802300 100 uds.	11,00 €
ELECTRODO	TE-722958	28,00 €

REMACHES (Ø3)	REF.	PRECIO
3,2 mm	TE-802297 100 uds.	9,00 €
4,5 mm	TE-802298 100 uds.	8,00 €
ELECTRODO	TE-742484	16,00 €

HILO ONDULADO	REF.	PRECIO
300 mm	TE-802339 50 uds.	34,00 €
200 mm	TE-802728 50 uds.	23,00 €
POSICIONADOR	TE-742087	48,00 €

CALENTAMIENTO	REF.	PRECIO
150 mm CARBON	TE-802608 5 uds.	12,00 €

EXTRACTORES	REF.	PRECIO
-	TE-722952	53,00 €
-	TE-802451	99,00 €

ARANDELAS GANCHO	REF.	PRECIO
ARANDELAS RECTAS	TE-802943 50 uds.	20,00 €
ARANDELAS DOBLADAS	TE-802944 50 uds.	24,00 €
ELECTRODO	TE-742541	27,00 €
210mm PALANCA	TE-484244	6,00 €
410mm PALANCA	TE-484635	7,00 €

CLAVOS	REF.	PRECIO
Ø2x50 mm	TE-802293 100 uds.	8,00 €
Ø2,6x50 mm	TE-802294 100 uds.	11,00 €
ELECTRODO	TE-742486	16,00 €
MANDRIL	TE-722953	99,00 €

ARANDELAS	REF.	PRECIO
Ø 8 mm	TE-802295 100 uds.	8,00 €
MANDRIL	TE-722955	20,00 €

SOLDADURA 1 LADO	REF.	PRECIO
ELECTRODO	TE-742485	12,00 €

TECHNOMIG 210

230 V - 50/60 Hz - 20-200 A
 Ø hilo acero: 0,6-1,0 mm
 Ø hilo alu: 0,8-1,0 mm
 Ø hilo sin gas: 0,8-1,2 mm
 Ø hilo inox: 0,8-1,0 mm
 TE-816055

899€

MIG MAG



TECHNOMIG 225

230 V - 50/60 Hz - 35-220 A
 Ø hilo acero: 0,6-1,0 mm
 Ø hilo alu: 0,8-1,0 mm
 Ø hilo sin gas: 0,8-1,2 mm
 Ø hilo inox: 0,8-1,0 mm
 TE-816057

1.245€

MIG MAG



TECHNOMIG 260

230 V - 50/60 Hz - 20-250 A
 Ø hilo acero: 0,6-1,0 mm
 Ø hilo alu: 0,8-1,0 mm
 Ø hilo sin gas: 0,8-1,2 mm
 Ø hilo inox: 0,8-1,0 mm
 TE-816056

1.299€

MIG MAG



TECHNOLOGY TIG 202 AC/DC

230 V - 50/60 Hz.
 95 V - 5-180 A
 115 A al 60%
 0,7 COSPHI
 Ø electrodos: 1,6-4 mm
 Accesorios incluidos.
 TE-816244

2.256€

TIG
 AC/DC
 HF O LIFT
 TIG PULSADO
 MMA



SUPERTIG 302 AC/DC

400 V - 50/60 Hz
 5-270 A - 95 V
 170 A en DC
 250 A al 30%
 Ø electrodos: 1,6-5 mm
 Accesorios incluidos.
 TE-816245

TIG
 AC/DC
 HF O LIFT
 TIG PULSADO
 MMA



CONSULTAR PRECIO

SUPERIOR TIG 422 WAVE

230 - 400 V - 50/60 Hz
 320-400 A - 79 V
 3-320/3 - 400 A en AC
 2-321/2 - 400 A en DC
 0,8 COSPHI
 Ø electrodos: 1,6-6 mm
 Accesorios incluidos.
 TE-816186

TIG
 AC/DC
 HF O LIFT
 TIG PULSADO
 MMA



CONSULTAR PRECIO

SUPERIOR PLASMA 70

400V - 13 A máx. - 70-30A
16 A máx. - 50-35 A
200 L/min - 4-5 bar
TE-816170

2.535€



Corte
m.x.
30 mm

SUPERIOR PLASMA 100

400V - 23,7 A - 100-30 A
20,8 A - 70-30 A
290 L/min - 4-5 bar
TE-816173

3.899€



Corte
m.x.
40 mm

SUPERIOR PLASMA 160

400V - 100-30 A - 38 A
40 A - 150-30A
290 L/min - 4-5 bar
TE-816174

5.399€



Corte
m.x.
50 mm

MODULAR 20/TI

230 V - 6 kW
Fusible de red
16 A - 2 V
5.800 A
TE-823015

750€



1+1 mm

DIGITAL MODULAR 230

230 V - 13 kW
Fusible de red
25 A - 2,5 V
6.900 A
TE-823016

912€



2+2 mm

DIGITAL MODULAR 400

400 V - 13 kW
Fusible de red
16 A - 2,5 V
6.900 A
TE-823017

945€



2+2 mm

SUPERMIG 350iPACK

400 V - 50/60 Hz - 3HP
20-270 A
Ø electrodo: 1,6 - 6 mm
Ø hilo: 0,6-1,2 mm
Cable prolongador 4 m
y carro incluido
TE-816903

2.983€



Multiproceso
Mig-Mag-Tig

inverter

ONE
TOUCH
LCD
SYNERGY

WIRE FEEDER
4
ROLLS

TIG
LIFT

CARBON
CUT

MIG SYNERGICA:
ACERO
INOX-ALU
FLUX-CUSI

SUPERMIG 450i PACK

400 V - 50/60 Hz - 3HP
20-450 A
Ø electrodo: 1,6 - 8 mm
Ø hilo: 0,6-1,6 mm
Cable prolongador 4 m
y carro incluido
TE-816905

3.519€



Multiproceso
Mig-Mag-Tig

inverter

ONE
TOUCH
LCD
SYNERGY

WIRE FEEDER
4
ROLLS

TIG
LIFT

CARBON
CUT

MIG SYNERGICA:
ACERO
INOX-ALU
FLUX-CUSI

INVERPULSE 40-40 WAVE

230 - 400 V - 50/60 Hz
 20-320 A
 20-400 A
 260 A al 40%
 350 A al 40%
 Corriente en DC: 200-270 A
 Ø electrodo: 1,6-8 mm
 Ø hilo:
 0,6-1,0 mm (acero aluminio inox.)
 0,8-1,2 mm (cusi)
 1,0-1,2 mm (halma)
 TE-816025

Multiproceso
 Mig-Mag-Tig

inverter

PULSE

PoP
 Pulse On Pulse

ATC
 Thermal Control

WIRE FEEDER
4 ROLLS

TIG LIFT

VRD
 VOLTAGE REDUCTION DEVICE

USB



CONSULTAR PRECIO

MIG SYNERGICA:
 ACERO-INOX-ALU FLUX-CUSI

CON ACCESORIOS



* Disponible versión Aqua
 TE-816226

INVERPULSE 60-30 WAVE

400 V - 50/60 Hz - 3 HP
 20-270 A
 270 A a 60%
 Ø electrodo: 1,6 - 8 mm
 Ø hilo: 0,6-2,0 mm
 Prolongador: 4/10/30 m
 TE-816175

Multiproceso
 Mig-Mag-Tig

inverter

Wave

PULSE

PoP
 Pulse On Pulse

ATC
 Thermal Control

WIRE FEEDER
4 ROLLS

CONSULTAR PRECIO

MIG SYNERGICA:
 ACERO
 INOX-ALU
 FLUX-CUSI



* Disponible versión Aqua
 TE-816176

INVERPULSE 60-40 WAVE

400 V - 50/60 Hz - 3 HP
 20-500 A
 400 A a 60%
 Ø electrodo: 1,6 - 8 mm
 Ø hilo: 0,6-2,4 mm
 Prolongador: 4/10/30 m
 TE-816178

Multiproceso
 Mig-Mag-Tig

inverter

Wave

PULSE

PoP
 Pulse On Pulse

ATC
 Thermal Control

WIRE FEEDER
4 ROLLS

CONSULTAR PRECIO

MIG SYNERGICA:
 ACERO
 INOX-ALU
 FLUX-CUSI



* Disponible versión Aqua
 TE-816179

PANTALLAS DE SOLDADURA

CP-PANTALLA2 ■■ Din 11

Pantalla tipo casco
Area de visión:
110x90 mm
Clase Optica 1

9,99€



CE-PE450S ■■ Din 9-13

Automática.
Regulable
Area de visión:
92x42 mm
Clase Optica
1/1/1/2

25€



**BATERÍA
RECAMBIABLE**

CE-PE801PRO ■■ Din 9-13

Automática.
Regulable
Area de visión:
92x42 mm
Clase Optica
1/1/1/2

39,95€



**BATERÍA
RECAMBIABLE**

CE-STARWHITE ■■ Din 9-13

Automática.
Regulable
Area de visión:
98x43 mm
Clase Optica
1/1/1/2

69€



**BATERÍA
RECAMBIABLE**

CE-PE1000/3XL ■■ Din 4-8 / 8-12 VisiÜn 180

Automática.
Regulable
Area de visión:
115x85 mm
Clase Optica
1/1/1/1 - 1/1/1/2

199€



**BATERÍA
RECAMBIABLE**

**TRUE
COLOR**

CE-PE903XL ■■ Din 5-9 / 9-13 VisiÜn 180

Automática.
Regulable
Area de visión:
100x67 mm
Clase Optica
1/1/1/1

69€



**BATERÍA
RECAMBIABLE**

**TRUE
COLOR**

CE-PE904XL ■■ Din 5-9 / 9-13 VisiÜn 180

Automática
Regulable
Area de visión:
100x67 mm
Clase Optica
1/1/1/1

69€



**BATERÍA
RECAMBIABLE**

**TRUE
COLOR**

CRISTALES

REFERENCIA	PROTECTOR	VÁLIDO PARA	PRECIO
CE-KITCRISTAL		PANTALLA410	5,83 €
CE-KITCRISTAL2		PANTALLA2	5,83 €
CE-PIN450S (10 uds.)	INTERIOR	PE450S	9,90 €
CE-PEX450S (10 uds.)	EXTERIOR	PE450S	16,99 €
CE-PEX800PRO	EXTERIOR	PE800PRO	3,18 €
CE-PIN800PRO	INTERIOR	PE800PRO	2,12 €
CE-PEXGRANDE800	INTERIOR	PE800PRO	4,47 €

REFERENCIA	PROTECTOR	VÁLIDO PARA	PRECIO
CE-PEXSTARWHITE	EXTERIOR	STARWHITE	2,12 €
CE-PEXIRONWELD	EXTERIOR	IRONWELD	4,77 €
CE-PINIRONWELD	INTERIOR	STARWHITE - IRONWELD	2,12 €
CE-PEX903-4	EXTERIOR	PE903XL - PE904XL	4,24 €
CE-PIN903-4	INTERIOR	PE903XL - PE904XL	2,12 €
CE-PEX1000/3XL	EXTERIOR	PE1000/3XL	4,24 €
CE-PIN1000/3XL	INTERIOR (2)	PE1000/3XL	3,18 €

CARGADORES Y ARRANCADORES

SP-H95 **|| Ultra-capacitador**

Arrancador sin baterías. 12 V
Arranque:
2.000 A (A-P. L.E.)

389€



SP-C1-TR-1224V **|| Profesional**

Arrancador sin baterías. 12-24 V
Arranque:
10.000 A

1.899€



SP-P24/1600 **|| Profesional**

Arrancador portátil
Batería 12 V
Arranque:
1.600 A (A-P. L.E.)

249€



SP-P5/2500 **|| Profesional**

Arrancador portátil
Batería 12 V
Arranque:
2.500 A

339€



SP-P5/12-24V **|| Profesional**

Arrancador portátil
Batería 12-24 V
Arranque:
2.500- 5.000 A

699€



SP-P01-TR-1224 **|| Profesional**

Arrancador portátil
Batería 12-24 V
Arranque:
10.000 A

1.099€



SP-GX2 **|| Automtico Litio**

Cargador 12 V 2.0 A
Carga máx.:
1,2 - 60 Ah
35 W

59€



SP-GX5 **|| Automtico Litio**

Cargador 12 V 5.0 A
Carga máx.:
1,2 - 110 Ah
85 W

69€



SP-GX15 **|| Automtico Litio**

Cargador 12-24 V 15 A
Carga máx.:
24 - 300 Ah
220 W

175€



CARGADORES Y ARRANCADORES

CE-FENIX21

Cargador alimentador
Batería 12-24 V
450 W
8-12A
20-180 Ah

59€



CE-FENIX60S

Cargador/arrancador
230 V - 12-24 V
6400 W
45 A
20/450 Ah

99€



CE-FENIX450CAR

Cargador/arrancador
230 V - 12-24 V
70 A - 300 Ah
20/700 Ah

175€

CONSULTAR
DISPONIBILIDAD



CE-FENIX650CAR

Cargador/arrancador
230 V - 12-24 V
100 A - 480 Ah
20/1050 Ah

240€

CONSULTAR
DISPONIBILIDAD



SP-LEM61211

Cargador/alimentador
1,1 A
Modo carga: 2,2 Ah/min - 32 Ah máx.
30 W

6-12 V
Gel

45€



SP-LEM122470

Cargador/alimentador
7-3,5 A
Modo carga: 12 V 14 Ah/min - 150 Ah máx.
Modo carga: 24 V 14 Ah/min - 75 Ah máx.
Mantenimiento hasta 225 Ah

12-24 V
Gel

79€



CARGADORES Y ARRANCADORES

ALASKA 150 START

Cargador
Batería 12 V
20 A
10/200 Ah (100%)
TE-807576

Led
Tronic

119€



ALASKA 210 START

Cargador
Batería 12-24 V
25/12 A
25/300 Ah (100%)
TE-807579

Led
Tronic

159€



DOCTOR START 330

Cargador/arrancador
230 V - 12-24 V
45 A - 300 Ah
10/450 Ah
TE-829344

555€



DOCTOR START 630







Cargador/arrancador
230 V - 12-24 V
90 A - 570 Ah
10/1050 Ah
TE-829342

770€









CARGADORES Y ARRANCADORES







ARRANCADOR

	VOLTAJE (V)	A-P.L.E. (A)							TIPO DE BATERÍAS						
									Wet	Gel	AGM	Pb Ca	MF	EFB	
SP-H95	12	2.000	✓	✓						✓	✓	✓	✓	✓	✓
SP-C1-TR-1224V	12-24	10.000	✓	✓	✓	✓	✓	✓		✓	✓	✓	✓	✓	✓
SP-24-1600	12	1.600	✓	✓						✓	✓	✓	✓	✓	✓
SP-P5/2500	12	2.500	✓	✓	✓	✓				✓	✓	✓	✓	✓	✓
SP-P5/12-24V	12-24	10.000	✓	✓	✓	✓	✓	✓		✓	✓	✓	✓	✓	✓
SP-P01-TR-1224	12-24	10.000	✓	✓	✓	✓	✓	✓		✓	✓	✓	✓	✓	✓

CARGADOR

	VOLTAJE (V)	CARGA (A)	CAP. CARGA (Ah)							TIPO DE BATERÍAS						
										Wet	Gel	AGM	Pb Ca	MF	EFB	LI
FENIX 21	12-24	20	20-180	✓	✓						✓	✓	✓	✓	✓	
ALASKA 150 START	12	20	10-200	✓	✓	✓	✓	✓	✓		✓	✓	✓	✓	✓	✓
ALASKA 210 START	12-24	25/12	25-30	✓	✓	✓	✓	✓	✓		✓	✓	✓	✓	✓	✓
SP-GX2	12	2	1.2-60	✓	✓						✓		✓	✓	✓	✓
SP-GX5	12	5	1.2-110	✓	✓	✓	✓				✓		✓	✓	✓	✓
SP-GX15	12-24	15/7.5	24-300	✓	✓	✓	✓	✓	✓		✓		✓	✓	✓	✓
LEM61211	6-12	1.1	1.1-40	✓	✓						✓	✓	✓	✓	✓	
LEM122470	12-24	7/3	14-150	✓	✓	✓	✓	✓	✓		✓	✓	✓	✓	✓	✓

CARGADOR ARRANCADOR

	VOLTAJE (V)	ARRANQUE (A)	CAP. CARGA (Ah)							TIPO DE BATERÍAS						
										Wet	Gel	AGM	Pb Ca	MF	EFB	LI
CE-FENIX60S	12-24	45	20-450	✓	✓	✓	✓				✓	✓	✓	✓	✓	
CE-FENIX450CAR	12-24	70	20-700	✓	✓	✓	✓				✓	✓	✓	✓	✓	
CE-FENIX650CAR	12-24	100	20-1050	✓	✓	✓	✓				✓	✓	✓	✓	✓	
DOCTOR START 330	12-24	300	10-450	✓	✓	✓	✓	✓	✓		✓	✓	✓	✓	✓	✓
DOCTOR START 630	12-24	570	10-1050	✓	✓	✓	✓	✓	✓		✓	✓	✓	✓	✓	✓



MEZCLADORES

CE-M1202PRO ■■ 2 Velocidades

1200 W
Volumen mezcla 40 L
180-400 r.p.m.
300-700 r.p.m.
Regulación electrónica
M14

79€



CE-M1600PRO ■■ 2 Velocidades

1600 W
Volumen mezcla 120 L
210-390 r.p.m.
350-650 r.p.m.
Regulación electrónica
M14

99€



ESPECIAL PINTURA

CE-M900R

850 W
Volumen mezcla 40 L
0-550 r.p.m.
M14

69€



CE-M1800PRO

1800 W
Volumen mezcla 140 L
180-400 r.p.m.
300-700 r.p.m.
Regulación electrónica
M14

109€

■■ 2 Velocidades



CE-MB18V

350 W - 18 V
Volumen mezcla 120 L
0-3420 r.p.m.
0-710 r.p.m.
Regulación electrónica
M14

199€

■■ Uso profesional



A BATERÍA
INCLUYE BATERÍA Y CARGADOR

DOBLE AISLAMIENTO

MALETA
DE
PLÁSTICO

Batería: CE-BAT18V P.V.P.: 45€

Cargador: CE-CARGADOR18V P.V.P.: 19€

VARILLAS PARA MEZCLADORES



REFERENCIA	ØxLARGO (mm)	MÉTRICA	PRECIO
CE-H2A	120x600	M14	12 €
CE-H2B	140x600	M14	13 €

REFERENCIA	ØxLARGO (mm)	MÉTRICA	PRECIO
CE-H3A	120x600	M14	14 €
CE-H3B	140x600	M14	15 €



VARILLAS PARA TALADRO

CE-VARILLA8X40

Medida: 80x400 mm

3,30€



CE-VARILLA10X60

Medida: 100x600 mm

4,40€



CE-2240 ■■■ Acero Inox

Juego 4 espátulas carroceo de 60/80/100 y 120 mm Especial para aplicar masillas y emplastecer.

3€

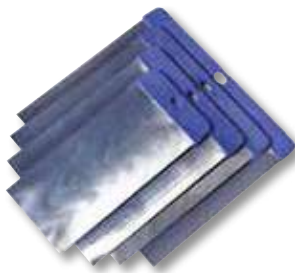

CE-2238 ■■■ Acero

Juego 4 espátulas carroceo de 60/80/100 y 120 mm Especial para aplicar masillas y emplastecer.

1,50€



CA-TIROLESA

Tirolesa manual. Empuñadura ergonómica para un fácil manejo.

19€



CA-RULO

Rulo completo para tirolesa. (15 peines)

5€



CE-GW1026M

2000 W - 50/550 °C
300 - 500 L/min
7 accesorios

■■■ Decapador
2 Velocidades

23€

MALETA DE PLÁSTICO

DECAPADORES

CE-GW1029M ■ ■ Display LCD

2000 W - 50/600 °C
2 velocidades
300 - 500 L/min
9 accesorios
En maleta de plástico

35€



SISTEMA DE ENFRIAMIENTO



MALETA DE PLÁSTICO

CE-GW1030M ■ ■ Display digital

2000 W - 50/600 °C
2 velocidades
200 - 500 L/min
9 accesorios
En maleta de plástico

45€



SISTEMA DE ENFRIAMIENTO



MALETA DE PLÁSTICO

ASPIRADORES SÓLIDOS-LÍQUIDOS

CP31-501 ■ ■ Telecomandado Filtro de agua

2200 W
Depósito: 30 L
Regulación electrónica

279€



Accesorios incluidos



Accesorios opcionales

CP31-501BOLSA	Bolsa superior 5 uds.
CP31-501BOLSA2	Bolsa inferior 5 uds.
CP31-501FP	Filtro sólidos
CP31-501FA	Filtro líquidos
CP31-501-52	Manguera Ø 32 mm
CP31-501SOPORTE	Soporte metálico

P.V.P.: 24,00 €
P.V.P.: 17,00 €
P.V.P.: 21,00 €
P.V.P.: 13,00 €
P.V.P.: 15,00 €
P.V.P.: 59,00 €

ESPECIAL PINTURA



ASPIRADORES SÓLIDOS-LÍQUIDOS

CE-PRO20X

1250 W
Caudal aire: 58 L/s
Depósito: 21 L

99€

DEPÓSITO
ACERO INOXIDABLE



Accesorios incluidos



CE-PRO30XT

1400 W
Caudal aire: 58 L/s
Depósito: 30 L

119€

DEPÓSITO
ACERO INOXIDABLE
TELECOMANDADO



Accesorios incluidos



CE-PRO50XT

1.400 W
Caudal aire: 58 L/s
Depósito: 50 L

189€

DEPÓSITO
ACERO INOXIDABLE
TELECOMANDADO



Accesorios incluidos



ESPECIAL TALLER / CONSTRUCCIÓN

ASPIRADORES SÓLIDOS-LÍQUIDOS

CE-PRO70ABS

1200 W
Caudal aire: 215 m³/h
Depósito: 77 L
65 dB

399€

DEPÓSITO
POLIPROPILENO



Accesorios incluidos



CE-PRO703INOXTR

■ ■ 2 motores

2900 W
Caudal aire: 510 m³/h
Depósito: 77 L
68 dB

599€

DEPÓSITO
ACERO INOXIDABLE

Accesorios incluidos



CE-PRO703ABS

■ ■ ■ 3 motores

2900 W
Caudal aire:
510 m³/h
Depósito: 77 L
68 dB

575€

DEPÓSITO
POLIPROPILENO

Accesorios incluidos



ACCESORIOS ASPIRADORES

REFERENCIA		PRO20X	PRO30XT	PRO50XT	PRO70ABS	PRO703ABS	PRO703INOX	PRECIO	
CE-AS1001	Bolsa papel (5 uds.)	✓	✓					14,00 €	
CE-AS1002	Bolsa papel (5 uds.)			✓				15,00 €	
CE-FI005C-5	Bolsa papel (5 uds.)				✓	✓	✓	51,55 €	
CE-FI005P/5	Saco poliéster (5 uds.)				✓	✓	✓	79,95 €	
CE-AS1008	Cartucho filtro sólidos	✓	✓	✓				16,00 €	
CE-FA044P	Filtro poliéster Ø 44				✓	✓	✓	29,95 €	
CE-AS1005	Filtro líquidos (2 uds.)	✓	✓	✓				12,00 €	
CE-ACCA165A	Filtro líquidos				✓	✓	✓	14,00 €	
CE-AS1001PRO	Manguera Ø 36	✓	✓	✓				10,00 €	
CE-ACFT38/2,5/C	Manguera Ø 40				✓	✓	✓	34,00 €	
CE-AS1009EKB	Boquilla Ø 36	✓	✓	✓				6,50 €	
CE-AS1002AKP	Extensión Ø 36	✓	✓	✓				7,00 €	
CE-ACTCO38C	Prolongador curvo Ø 40				✓	✓	✓	30,00 €	
CE-AS1004EKP	Prolongador metálico Ø 40	✓	✓	✓	✓	✓	✓	15,00 €	
CE-AS1002EKB	Prolongador metálico extensible	✓	✓	✓				8,00 €	
CE-ACLP036	Boquilla plana Ø 36	✓	✓	✓				3,00 €	
CE-ACLP040	Boquilla plana Ø 40				✓	✓	✓	5,00 €	
CE-AS1004EKB	Cepillo multiusos	✓	✓	✓				8,00 €	
CE-ACIL400	Cepillo líquidos				✓	✓	✓	12,50 €	
CE-ACIP400	Cepillo suelo 400 mm				✓	✓	✓	12,00 €	
CE-ACPE036	Cepillo redondo Ø 36	✓	✓	✓				5,90 €	
CE-ACPE040	Cepillo redondo Ø 40				✓	✓	✓	6,00 €	
CE-AS1003	Adaptador aspirador	✓	✓	✓				2,00 €	

CP31-800LED

Lijadora de pared
750 W
6 velocidades
Telescópica 110/170 cm
Plegable

Disco lija y 225 mm
Luz LED



149€

PACK DE LIJAS INCLUIDO



Plato circular Ref.: CP31-800-3
P.V.P.: 8,69 €



CP31-900BS

Lijadora de pared
500 W
6 velocidades
Telescópica 126/200 cm
Plegable

Disco lija y 225 mm
Luz LED



225€

PACK DE LIJAS INCLUIDO



Plato circular Ref.: CP31-900BS-3
P.V.P.: 7,12 €

MOTOR
"BRUSHLESS"



DISCO DE LIJA OXY

Pulido de calidad
Para madera, pintura,
cuero, resinas
Multiagujeros

Disco y 225 mm

4,99€

PACK

VÁLIDOS PARA: CP31-800LED, CP31-900BS, CP31-1100

*Pack 6 unidades

REFERENCIA	GRANO
OXYDF22540	40
OXYDF22560	60
OXYDF22580	80
OXYDF225100	100
OXYDF225120	120
OXYDF225150	150
OXYDF225180	180
OXYDF225220	220
OXYDF225240	240



Disponible grano 24: MSED225GR24
P.V.P. pack 6 uds.: 4,99 €

LIJADORAS

CP31-1100

Lijadora de pared
1010 W
6 velocidades

99€

PACK DE LIJAS INCLUIDO

Granos pack:
80-100-120-150-180-240

Disco lija
y 225 mm



DISCO DE LIJA OXY

Pulido de calidad
Para madera, pintura,
cuero, resinas
Multiagujeros
Ø 225 mm

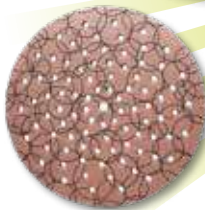

4,99€
PACK

*Pack 6 unidades



Plato circular Ref.: CP31-1112
P.V.P.: 35 €

CP31-1111

Plato triangular
P.V.P.: 35,20 €



PACKS 6 LIJAS TRIANGULARES

(29x29x29 cm)

CP31-1116. GR100. P.V.P.: 5,00 €
CP31-1117. GR150. P.V.P.: 5,00 €
CP31-1118. GR240. P.V.P.: 5,00 €

CP31-400

Lijadora roto orbital
230-240 V
Ø lija: 150 mm
400 - 10000 r.p.m.

179€

Orbita 5 mm



MOTOR
"BRUSHLESS"



CP31-401

Lijadora roto orbital
230-240 V
Ø lija: 150 mm
400 - 10000 r.p.m.

179€

Orbita 2,5 mm



MOTOR
"BRUSHLESS"



NE-RP7336S-1BIS

Plato de goma. Ø 150 mm
P.V.P.: 35,00 €

DISCOS DE LIJA IM-CARVF

Con velcro de gran
calidad. 15 agujeros
Válidos para modelos
CP31-400 / CP31-401

Ø 150 mm



REFERENCIA	GRANO	PRECIO
IM-CARVF402040	40	0,60 €
IM-CARVF402060	60	0,55 €
IM-CARVF402080	80	0,48 €
IM-CARVF402100	100	0,43 €
IM-CARVF402120	120	0,43 €

REFERENCIA	GRANO	PRECIO
IM-CARVF402150	150	
IM-CARVF402180	180	
IM-CARVF402220	220	0,39 €
IM-CARVF402240	240	
IM-CARVF402280	280	

REFERENCIA	GRANO	PRECIO
IM-CARVF402320	320	
IM-CARVF402400	400	
IM-CARVF402500	500	0,39 €
IM-CARVF402600	600	
IM-CARVF402800	800	

Cajas completas (100/50 uds.)

POLIPASTOS ELÉCTRICOS

CE-P125-250

540 W
125/250 Kg
Largo cable:
12,5/6,25 m

119€

CE-P250-500

1.020 W
250/500 Kg
Largo cable:
18,5/9,25 m

179€

CE-P500-990

1.600 W
500/990 Kg
Largo cable:
12,5/6,25 m

319€



CE-B750

Bandera para polipasto
250 Kg máximo
Largo bandera 750 mm
Ángulo de rotación: 180°

49€



CE-B1100

Bandera para polipasto
600 Kg máximo
Largo bandera 1.100 mm
Ángulo de rotación: 180°

55€

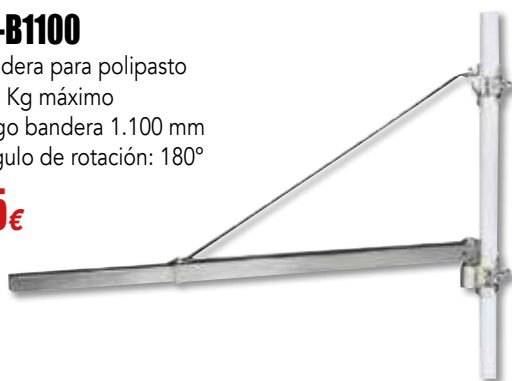

ESMERILADORAS

CP10-150MIXTA

Esmeriladora combinada
con cepillo de alambre
Ø muela: 150 mm
Ø cepillo: 150 mm
450 W - 2.950 r.p.m.
Grano muela 36 mm

2 en 1
muela y cepillo

59€



CP10-150AGUA

Esmeriladora afiladora de agua
Ø muela piedra: 150 mm
Ø muela agua: 200 mm
400 W - 2.950 r.p.m.
Grano muela 36 y 60 mm

Doble muela
agua/piedra

59€



CAUCHO

F-8800IT

Cubo italiano
32x32x18 cm
1,56 kg

8€



10 L

F-880011

Gaveta
42x53x15 cm
2,16 kg

13€



12 L

F-880015

Gaveta
54,6x43,6x17 cm
2,64 kg

14€



15 L

F-8812PICO

Cubo de obra con pico
32x33x31 cm
1,8 Kg

10,50€



12 L

F-880012

Espuerta
40x29x15 cm
1,1 kg

8€



11 L

F-880028

Espuerta
45x55x16,5 cm
2,88 kg

13,50€



20 L

F-880030

Carbonera
43x50x34 cm
2,91 kg

14,50€



30 L

PLÁSTICO

F-880003

Cubeta
32x22x6,5 cm

1,90€



3 L

CU-CALDERETA11L

Caldereta
Alto: 13 cm
Boca: 32 cm

2,70€



10 L

CU-CUBO12M

Cubo
Alto: 25,1 cm
Boca: 28,5 cm

1,50€



10,5 L

CU-CAPAZO26M

Capazo
Alto: 29,5 cm
Boca: 34 cm

3,60€



22 L

CU-CAPAZO26

Capazo
Alto: 29,5 cm
Boca: 34 cm

2,50€



22 L

CU-CAPAZO

Capazo
Alto: 33 cm
Boca: 44 cm

3,10€



42 L

CU-CAPAZO55

Capazo
Alto: 33 cm
Boca: 53 cm

4,40€



55 L

ESPECIAL TALLER / CONSTRUCCIÓN

ABRASIVOS: TACOS - ESPONJAS

TACO ABRASIVO

Granos fino, medio y grueso
MSE-TFINO
MSE-TMEDIO
MSE-TGRUESO

0,45€
UNIDAD



* Cajas de 50 uds.

ESPONJA ABRASIVA

Granos fino, medio y grueso
MSE-EFINO
MSE-EMEDIO
MSE-EGRUESO

0,45€
UNIDAD



* Cajas de 50 uds.

TACO ANGULO ABRASIVO

Granos fino, medio y grueso
MSE-ANGFINO
MSE-ANGMEDIO
MSE-ANGRUESO

0,65€
UNIDAD



* Cajas de 50 uds.

PACK 5 TACOS

MSE-TFINOPACK
MSE-TMEDIOPACK
MSE-TGRUESOPACK

1,79€
PACK



* Cajas de 10 packs

PACK 5 ESPONJAS

MSE-EFINOPACK
MSE-EMEDIOPACK
MSE-EGRUESOPACK

1,79€
PACK



* Cajas de 10 packs

TIPOS DE GRANO

FINO 100 MEDIO 60 GRUESO 36



ABRASIVOS: PLIEGOS

MSE-SIM

Lija soporte papel, adhesivo cola, abrasivo silíce
Granos: 60-80-100-120-150-180

0,18€
UNIDAD

MADERA Y METAL



* Cajas de 50 uds.

MSE-CRD

Lija soporte papel,
adhesivo cola, abrasivo
óxido de aluminio
Granos: 40-60-80-120-150

0,25€
UNIDAD

MADERA
BLANDA
Y METAL



* Cajas de 50 uds.

MSE-ASS

Lija soporte papel-latex, adhesivo cola
abrasivo corindón + estearato
Granos: 80-180-280-320-400

0,40€
UNIDAD

MADERA
BARNIZ
MÁRMOL
CARROCERÍA
Y PLÁSTICO



* Cajas de 100 uds.

MSE-FE

Lija soporte tela, adhesivo
cola abrasivo corindón,
óxido de aluminio
Granos: 40-60-80-100-120-150-180-220-320

0,48€
UNIDAD

METAL



* Cajas de 50 uds.

MSE-WEC

Lija al AGUA, soporte
papel impermeable,
adhesivo cola abrasivo
corindón + estearato
Granos: 180-220-280-360-500-800-2000

0,51€
UNIDAD

MADERA
BARNIZ Y
CARROCERÍA

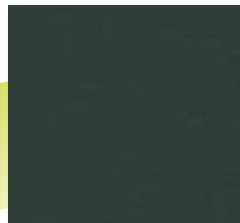

* Cajas de 100 uds.

MSE-IMJ

Pliego soporte tela abrasiva,
extra flexible al corindón,
adhesivo doble resina, abrasivo
corindón, óxido de aluminio
Granos: 60-80-120-180

0,77€
UNIDAD

MADERA
DURA Y
METAL



* Cajas de 50 uds.

ABRASIVOS: PAPEL

Abrasivo al corindón: resina sobre cola, esparcimiento semiabierto. Soporte papel. Para pulir madera basta, barnices sobre madera y metal.

93 x 230 mm

Lote 10 lijas
8 agujeros

REFERENCIA	GRANO	PRECIO
IMP3128	50	3,06 €
IMP3129	80	
IMP3130	120	
IMP3131	180	



115 x 280 mm

Lote 10 lijas
Ciego

REFERENCIA	GRANO	PRECIO
IMP3108	50	3,67 €
IMP3109	80	
IMP3110	120	
IMP3111	180	



Blister

115 x 280 mm

Lote 10 lijas
8 agujeros

REFERENCIA	GRANO	PRECIO
IMP3100	50	4,29 €
IMP3101	80	
IMP3102	120	3,67 €
IMP3103	180	



115 x 280 mm

Lote 10 lijas
14 agujeros

REFERENCIA	GRANO	PRECIO
IMP3104	50	4,29 €
IMP3105	80	
IMP3106	120	3,67 €
IMP3107	180	



93 x 185 mm

Lote 6 lijas
8 agujeros

REFERENCIA	GRANO	PRECIO
IMP3112	40	4,41 €
IMP3113	60	
IMP3114	80	
IMP3115	120	



93 x 185 mm

Lote 6 lijas
8 agujeros

REFERENCIA	GRANO	PRECIO
IMP3116	50	4,41 €
IMP3117	80	
IMP3118	120	
IMP3119	180	



93 x 230 mm

Lote 10 lijas
Ciego

REFERENCIA	GRANO	PRECIO
IMP3132	50	3,06 €
IMP3133	80	
IMP3134	120	



93 x 230 mm

Lote 10 lijas
8 agujeros

REFERENCIA	GRANO	PRECIO
IMP3124	50	3,06 €
IMP3125	80	
IMP3126	120	
IMP3127	180	



MSE-CRD93X230AS

Lote 10 lijas (93 x 230 mm)
8 agujeros
Granos surtidos

1,84 €



Retrctil

ESPECIAL TALLER / CONSTRUCCIÓN

ABRASIVOS: PATINES LIJA

93x93 mm

■ || Bilster

6 unidades



REFERENCIA	GRANO	PRECIO
IMP3140	50	2,53 €
IMP3141	80	2,26 €
IMP3142	120	2,20 €
IMP3143	180	2,26 €

93x93 mm

■ || Retrctil

6 unidades



REFERENCIA	GRANO	PRECIO
MSEDELTA93GR60	60	1,71 €
MSEDELTA93GR80	80	
MSEDELTA93GR120	120	
MSEDELTA93GR180	180	

105 x 175 mm

5 unidades



REFERENCIA	GRANO	PRECIO
IMP3170	50	3,27 €
IMP3171	80	
IMP3172	120	3,37 €
IMP3173	180	

95x135 mm

5 unidades



REFERENCIA	GRANO	PRECIO
MSE95x135GR60	60	1,71 €
MSE95x135GR80	80	
MSE95x135GR120	120	
MSE95x135GR180	180	

102x152 mm

■ || Retrctil

5 unidades



REFERENCIA	GRANO	PRECIO
MSE102GR60	60	1,71 €
MSE102GR80	80	
MSE102GR120	120	
MSE102GR180	180	

ABRASIVOS: DISCOS

DISCO MALLA 150 mm

5 unidades



REFERENCIA	GRANO	PRECIO
MSE-150RTVB60	60	5,21 €
MSE-150RTVB80	80	
MSE-150RTVB120	120	
MSE-150RTVB180	180	



DISCO MALLA 225 mm

5 unidades



REFERENCIA	GRANO	PRECIO
MSE-225RTVB60	60	6,29 €
MSE-225RTVB80	80	
MSE-225RTVB120	120	
MSE-225RTVB180	180	



DISCO OXY 180 mm

6 unidades. Pulido de calidad.

Para madera, pintura, cuero, resinas.

Multiagujeros



REFERENCIA	GRANO	PRECIO
OXYDF18040	40	4,50€
OXYDF18080	80	
OXYDF180120	120	
OXYDF180180	180	
OXYDF180220	220	
OXYDF180ASS	VARIOS	



ESPECIAL PARA
LJADORAS DE
PARED Y TECHO

DISCO OXY 225 mm

6 unidades. Pulido de calidad.

Para madera, pintura, cuero, resinas.

Multiagujeros



REFERENCIA	GRANO	PRECIO
OXYDF22540	40	4,99€
OXYDF22560	60	
OXYDF22580	80	
OXYDF225100	100	
OXYDF225120	120	
OXYDF225150	150	
OXYDF225180	180	
OXYDF225220	220	
OXYDF225240	240	



ESPECIAL PARA
LJADORAS DE
PARED Y TECHO

Disponible grano 24: MSED180GR24
P.V.P. pack 6 uds.: 4,50 €

Disponible grano 24: MSED225GR24 P.V.P. pack 6 uds.: 4,99 €

ABRASIVOS: DISCOS

■ || Cajas

Ø 150 MM - 15 AGUJEROS - VELCRO			Ø 150 MM - 15 AGUJEROS - VELCRO			Ø 150 MM - 15 AGUJEROS - VELCRO		
		PRECIO			PRECIO			PRECIO
IM-CARVF402040	Grano 40	0,60 €	IM-CARVF402150	Grano 150		IM-CARVF402320	Grano 320	
IM-CARVF402060	Grano 60	0,55 €	IM-CARVF402180	Grano 180		IM-CARVF402400	Grano 400	
IM-CARVF402080	Grano 80	0,48 €	IM-CARVF402220	Grano 220	0,39 €	IM-CARVF402500	Grano 500	0,39 €
IM-CARVF402100	Grano 100	0,43 €	IM-CARVF402240	Grano 240		IM-CARVF402600	Grano 600	
IM-CARVF402120	Grano 120	0,43 €	IM-CARVF402280	Grano 280		IM-CARVF402800	Grano 800	

Cajas completas (100/50 uds.)

VÁLIDO PARA MODELOS:
CP31-400 Y CP31-401

GRAN CALIDAD



■ || Bilster

Ø 115 MM - CIEGO (6 UDS.) - VELCRO		PRECIO
IMP3152	Grano 50	 2,69 €
IMP3153	Grano 80.	
IMP3154	Grano 120	

Ø 127 MM - 1 AGUJERO (10 UDS.)		PRECIO
IMP3163	Grano 50	 2,57 €
IMP3164	Grano 80	
IMP3165	Grano 120	

Ø 150 MM - 6 AGUJEROS (6 UDS.) - VELCRO		PRECIO
IMP3168	Grano 120	 3,55 €
IMP3169	Grano 180	

■ || Retrctil

Ø 125 MM - 8 AGUJEROS (6 UDS.) - VELCRO		PRECIO
MSEDF12540	Grano 40	 2,44 €
MSEDF12560	Grano 60	
MSEDF12580	Grano 80	
MSEDF125120	Grano 120	
MSEDF125180	Grano 180	

Ø 150 MM - 6 AGUJEROS (6 UDS.) - VELCRO		PRECIO
MSEDF15040	Grano 40	 3,37 €
MSEDF15060	Grano 60	
MSEDF15080	Grano 80	
MSEDF150120	Grano 120	
MSEDF150180	Grano 180	

Ø 150 MM - CIEGO (6 UDS.) - VELCRO		PRECIO
MSEDNF15060	Grano 60	 3,37 €
MSEDNF15080	Grano 80	
MSEDNF150120	Grano 120	
MSEDNF150180	Grano 180	

ABRASIVOS: BANDAS

■ || Retrctil

75X457 MM (3 BANDAS)		PRECIO
MSE75X457	Disponibles en grano 40 - 60 - 80 - 120	3,06 €

75X533 MM (3 BANDAS)		PRECIO
MSE75X533	Disponibles en grano 40 - 60 - 80 - 120	3,06 €

100X610 MM (3 BANDAS)		PRECIO
MSE100X610	Disponibles en grano 40 - 60 - 80 - 100 - 120	4,53 €

100X690 MM (3 BANDAS)		PRECIO
MSE100X690	Disponibles en grano 40 - 60 - 80 - 120	4,29 €

100X914 MM (3 BANDAS)		PRECIO
MSE100X914	Disponibles en grano 60 - 80 - 120 - 180	10,41 €

ABRASIVOS: BANDAS

■ ■ Blister

65x410 mm (3 bandas) PRECIO

IMP3194	GR40		
IMP3195	GR60		3,67 €
IMP3196	GR80		
IMP3197	GR120		
IMP3198	GR180		

60x400 mm (3 bandas) PRECIO

IMP3189	GR40		
IMP3190	GR60		3,67 €
IMP3191	GR80		
IMP3192	GR120		
IMP3193	GR180		

75x480 mm (3 bandas) PRECIO

IMP3204	GR40		4,39 €
IMP3205	GR60		
IMP3206	GR80		
IMP3207	GR120		
IMP3208	GR180		

75x510 mm (3 bandas) PRECIO

IMP3209	GR40		
IMP3210	GR60		4,41 €
IMP3211	GR80		
IMP3212	GR120		
IMP3213	GR180		

105x620 mm (3 bandas) PRECIO

IMP3219	GR40		
IMP3220	GR60		4,90 €
IMP3221	GR80		
IMP3222	GR120		
IMP3223	GR180		

100x560 mm (3 bandas) PRECIO

IMP3174	GR40		6,32 €
IMP3175	GR60		
IMP3176	GR80		
IMP3177	GR120		
IMP3178	GR180		

ABRASIVOS: ROLLOS

LEYENDA



MADERA JFN (115 mm)

■ ■ 5 m

Soporte papel. Óptimo para la lijadura y acabado en seco de madera, barnices y masillas.

REFERENCIA	GRANO	PRECIO
IM-12449542	40	2,99 €
IM-JFN217060	60	
IM-JFN217080	80	
IM-JFN217150	150	



MADERA PTK (100 mm)

■ ■ 3 m

Soporte "J Flex". Tela. Elaboraciones manuales de estampados metálicos y acabados calidad standard.

REFERENCIA	GRANO	PRECIO
IM-12449605	180	4,50 €
IM-12449626	240	
IM-12449633	280	
IM-12449654	320	



ABRASIVOS: ROLLOS

BARNIZ CCB (100 mm) ■|| 3 m

Soporte papel. Óptimo para el lijado y acabado en seco de barnices de poliéster y transparentes.

REFERENCIA	GRANO	PRECIO
IM-12449661	180	1,99 €
IM-12449675	240	
IM-12449696	280	
IM-12449724	320	

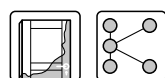

VELCRO E28V (120 mm) ■|| 3 m

Soporte papel. Elaboraciones sobre madera, materias plásticas, láminas metálicas, barnices sobre madera y metal.

REFERENCIA	GRANO	PRECIO
IM-E28V217040	40	5,99 €
IM-E28V217080	80	
IM-E28V217100	100	
IM-E28V217150	150	



UNIVERSAL KPF (115 mm) ■|| 5 m

Soporte papel al látex. Flexible como tela. Ideal para alisar las superficies perfiladas bastas o tratadas. Barnices, madera y materias plásticas.



PARA SECO Y HÚMEDO



REFERENCIA	GRANO	PRECIO
IM-KPF217060	60	3,75 €
IM-KPF217100	100	
IM-KPF217150	150	
IM-KPF217240	240	

PARED CRD (115 mm) ■|| 5 m

Soporte papel, adhesivo cola, abrasivo óxido de aluminio.

REFERENCIA	GRANO	PRECIO
MSE-CRD115x560	60	2,15 €
MSE-CRD115x580	80	
MSE-CRD115x5120	120	
MSE-CRD115x5180	180	



MADERA DURA Y METAL

MULTIPRODUCTO IMJ (115-120 mm) ■|| 5 m (115 mm)

Soporte de tela abrasiva, extra flexible al corindón, adhesivo doble resina, óxido de aluminio.

REFERENCIA	GRANO	PRECIO
MSE-IMJ115x560	60	7,99 €
MSE-IMJ115x580	80	
MSE-IMJ115x5120	120	
MSE-IMJ115x5180	180	



REFERENCIA	GRANO	PRECIO
MSE-CRD115x2560	60	9,99 €
MSE-CRD115x2580	80	
MSE-CRD115x2512	120	
MSE-CRD115x2518	180	



MADERA DURA Y METAL

REFERENCIA	GRANO	PRECIO
IM-213040	40	35 €
IM-213060	60	
IM-213080	80	
IM-213100	100	
IM-213120	120	
IM-213150	150	
IM-213180	180	
IM-213240	240	



CINTAS BIMETÁLICAS PARA METAL

Hojas bimetálicas al cobalto M42 para elevadas prestaciones de corte de metales. Ideales para corte en seco. Gran resistencia y productividad, tanto en materiales macizos, como en perfilados. Todas disponibles en varios dentados:

- **Mayor número de dientes:** válidas para tubo grueso o materiales muy duros.
- **Dentado intermedio:** universales.
- **Dentado mínimo:** Para tubo fino o materiales blandos.
- **(*) Máximo dentado:** Fabricación especial.

REFERENCIA	MEDIDAS (mm)	VÁLIDAS PARA MOD. CON NG SYSTEM	PRECIO (2 unidades)	
1440	FMCINT6NG120	1440x13x0.65 Z/1" 6	NG 120 / ABS NG120	52,50 €
	FMCINT812NG120	1440x13x0.65 Z/1" 8/12	NG 120 / ABS NG120	
	FMCINT14NG120	1440x13x0.65 Z/1" 14	NG 120 / ABS NG120	
	FMCINT18NG120	1440x13x0.65 Z/1" 18 (*)	NG 120 / ABS NG120	
1750	FMCINT6NG160	1735x13x0.9 Z/1" 6	NG-160 / ABS NG160	57,75 €
	FMCINT610NG160	1735x13x0.9 Z/1" 6/10	NG-160 / ABS NG160	
	FMCINT14NG160	1735x13x0.9 Z/1" 14	NG-160 / ABS NG160	
REFERENCIA	MEDIDAS (mm)	VÁLIDAS PARA	PRECIO (2 unidades)	
1330	FMCINT6780	1335x13x0.65 Z/1" 6	782 / 783 / 780 P / mod. XLy ABS 105	51,45 €
	FMCINT812780	1335x13x0.65 Z/1" 8/12	782 / 783 / 780 P / mod. XLy ABS 105	
	FMCINT14780	1335x13x0.65 Z/1" 14	782 / 783 / 780 P / mod. XLy ABS 105	
	FMCINT18780	1335x13x0.65 Z/1" 18 (*)	782 / 783 / 780 P / mod. XLy ABS 105	
1440	FMCINT812784	1440x13x0.65 Z/1" 8/12	784 XL	52,50 €
	FMCINT14784	1440x13x0.65 Z/1" 8/14	784 XL	
1750	FMCINT461750	1735x20x0.9 Z4/6	1750 XL - 1750 XLABS	60,90 €
	FMCINT8121750	1735x20x0.9 Z8/12	1750 XL - 1750 XLABS	
	FMCINT6101750	1735x20x0.9 Z6/10	1750 XL - 1750 XLABS	
	FMCINT141750	1735x20x0.9 Z14	1750 XL - 1750 XLABS	
1750	FMCINT6785	1735x13x0.9 Z/1" 6	785 P / 785XL	57,75 €
	FMCINT610785	1735x13x0.9 Z/1" 6/10	785 P / 785XL	
	FMCINT14785	1735x13x0.9 Z/1" 14	785 P / 785XL	
2200	FMCINT46792	2140x19x0.9 Z/1" 4/6	2200XL / 2200DAXL	72,45 €
	FMCINT610792	2140x19x0.9 Z/1" 6/10	2200XL / 2200DAXL	
	FMCINT14792	2140x19x0.9 Z/1" 14	2200XL / 2200DAXL	
2500	FMCINT610251	2480x27x0.9 6/10	N250DAXLY N251DAXL	84,00 €
	FMCINT46251	2480x27x0.9 4/6	N250DAXLY N251DAXL	
	FMCINT812251	2480x27x0.9 8/12	N250DAXLY N251DAXL	
	FMCINT14251	2480x27x0.9 10/14	N250DAXLY N251DAXL	
2750	FMCINT610310	2750x27x0.9 6/10	N310DA/DG	91,35 €
	FMCINT10/14310	2750x27x0.9 10/14	N310DA/DG	

DISCOS DE WIDIA

PARA MÁQUINAS ESTÁTICAS



REFERENCIA	Ø D=mm	Grueso B=mm	Eje D=mm	Z	PRECIO
DM20030Z30PRT	200	2,8	30	30	9,99 €
F36-080	210	2,5	30	40	19,00 €
DM25430Z42	254	3,2	30	42	22,00 €
DM25430Z60	254	3,2	30	60	25,00 €
DM25030Z42	250	3,2	30	42	22,00 €
DM30030Z48	300	3,2	30	48	25,00 €
DM25030Z60 *	250	3,2	30	60	53,00 €

* Discos de alto rendimiento

PARA ALUMINIO



REFERENCIA	Ø D=mm	Grueso B=mm	Eje D=mm	Z	PRECIO
DA25030Z80	250	3,2	30	80(*)	37,00 €
DA30032Z96*	305	3,0	32	96	113,00 €
DA40030Z96*	400	3,6/3,0	30	96	115,00 €

PARA DESBROZADORAS

REFERENCIA	Ø D=mm	Grueso B=mm	Eje D=mm	Z	PRECIO
DB25020Z20	250	2,8	20	20	22,00 €

* Discos de alto rendimiento



ANILLOS REDUCCIÓN PARA DISCOS

SUCA151825

Juego de 3 uds.
Reducción: 30/15 • 30/18 • 30/25

8,40€

SUCA162022

Juego de 3 uds.
Reducción: 30/16 • 30/20 • 30/22

8,40€



ACCESORIOS TALADROS DE COLUMNA

MORDAZAS

Para taladros de columna

REFERENCIA	MEDIDA (mm)	PRECIO
F12-900	55	12,00 €
FM-DP12-914	63	10,00 €
FM-DP12-915	100	18,00 €
FM-DP12-916	127	25,00 €
FM-DP12-917	150	35,00 €



PORTABROCAS

Para taladros de columna

REFERENCIA	CONO	MEDIDA (mm)	PRECIO
CP12-903	B13	1,5 - 13	24,00 €
CP12-904	B16	3 - 16	35,00 €
CP12-909	B22	5 - 20	41,00 €



ESPECIAL TALLER / CONSTRUCCIÓN

DISCOS DE LÁMINAS

PARA HIERRO

REFERENCIA	GRANO	PRECIO
DL11540H	40	1,30 €
DL11560H	60	
DL11580H	80	
DL115120H	120	1,40 €
DL125100H	100	
DL18040H	40	3,99 €
DL18060H	60	
DL18080H	80	
DL180100H	100	
DL180120H	120	



PARA INOXIDABLE

REFERENCIA	GRANO	PRECIO
DL11560INOX	60	1,30 €
DL115100INOX	100	
DL115120INOX	120	
DL12580INOX	80	1,40 €
DL125100INOX	100	
DL125120INOX	120	3,99 €
DL18040INOX	40	
DL18060INOX	60	
DL18080INOX	80	
DL180100INOX	100	



Ø 115/125 - Embalaje de 20 unidades
Ø 180 - Embalaje de 10 unidades

Ø 115/125 - Embalaje de 20 unidades
Ø 180 - Embalaje de 10 unidades

FRESAS METAL DURO PARA MADERA

FRESAS PARA PERNIOS

REFERENCIA	MEDIDAS (mm)		PRECIO
	Ø	MANGO	
FRH 12	12	8	26,86 €
FRH 13	13	8	
FRH 14	14	8	
FRH 15	15	8	
FRH 16	16	8	
FRH 12-6	12	6	



FRESAS DE DISCO

REFERENCIA	MEDIDAS (mm)		PRECIO
	A	B	
FR 65	40	1,5	12,85 €
FR 66	40	2,0	12,79 €
FR 67	40	2,5	
FR 68	40	3,0	
FR 69	40	4,0	
FR 70	40	5,0	

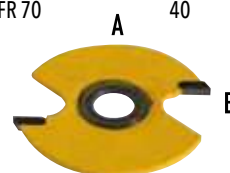

MANGO PARA FRESAS DE DISCO

REFERENCIA	EJE	PRECIO
MANGO 6		
FR72/6	6	9,67 €



MANGO PARA FRESAS DE DISCO

REFERENCIA	EJE	PRECIO
MANGO 8		
FR73/6	6	9,74 €



FRESAS METAL DURO PARA MADERA

REFERENCIA		MEDIDAS (mm)				PRECIO
MANGO 6	MANGO 8	A	B	D+B	R	
FR 40-6	FR 40-8	22,2	12,7	49	4,8	25,59 €
FR 41-6	FR 41-8	25,4	12,7	49	6,3	16,90 €
FR 42-6	FR 42-8	28,6	12,7	49	7,9	18,87 €
FR 43-6	-	31,8	15,9	52	9,5	20,39 €
FR 44-6	FR 44-8	38,1	19,1	55	12,7	22,91 €



REFERENCIA		MEDIDAS (mm)			PRECIO
MANGO 6	MANGO 8	A	B	D+B	
-	FR 1-8	3	11	51	5,11 €
FR 2-6	-	4	11	51	5,62 €
-	FR 3-8	5	11	51	5,62 €
FR 8-6	FR 8-8	8	25	63	7,10 €
FR 9-6	-	10	19	51	7,68 €
FR 10-6	-	10	32	63	7,10 €
FR 11-6	FR 11-8	12	19	54	7,68 €
-	FR 13-8	14	19	52	10,61 €
FR 14-6	-	16	25	57	7,68 €
FR 15-6	FR 15-8	18	19	52	10,14 €
-	FR 16-8	20	19	52	10,14 €
-	FR 22-8	22	19	52	10,14 €
FR 76-6	FR 76-8	15	19	52	7,68 €

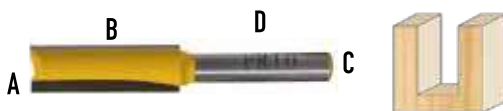

REFERENCIA		MEDIDAS (mm)				PRECIO
MANGO 6	MANGO 8	A	B	D+B	E	
FR 51-6	FR 51-8	31,8	12,7	50	45°	32,69 €

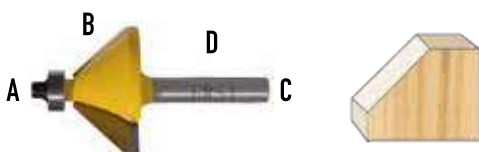

REFERENCIA		MEDIDAS (mm)				PRECIO
MANGO 6	MANGO 8	A	B	D+B	E	
FR 34-6	FR 34-8	12,7	12,7	44	14°	16,37 €



REFERENCIA		MEDIDAS (mm)				PRECIO
MANGO 6	MANGO 8	A	B	D+B	R	
FR 47-6	FR 47-8	22,2	14,3	52	6,3	29,08 €
FR 48-6	FR 48-8	25,4	14,3	52	7,9	22,35 €
FR 49-6	FR 49-8	28,6	14,3	52	9,5	24,80 €
FR 50-6	FR 50-8	34,9	19,1	57	12,7	27,88 €

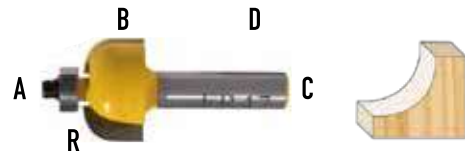

REFERENCIA		MEDIDAS (mm)			PRECIO
MANGO 6	MANGO 8	A	B	D+B	
FR 31-6	FR 31-8	12,7	12,7	44(60°)	19,79 €
FR 32-6	-	12,7	12,7	44(90°)	14,24 €
FR 33-6	FR 33-8	19,1	15,9	44(90°)	12,62 €



REFERENCIA		MEDIDAS (mm)				PRECIO
MANGO 6	MANGO 8	A	B	D+B	R	
-	FR 36-8	25,4	12,7	49	6,3	16,90 €
FR 37-6	FR 37-8	28,6	12,7	49	7,9	18,87 €
FR 38-6	FR 38-8	31,8	15,9	52	9,5	19,79 €
FR 39-6	FR 39-8	38,1	19,1	55	12,7	21,72 €

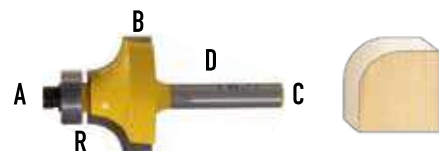

ESPECIAL TALLER / CONSTRUCCIÓN

FRESAS METAL DURO PARA MADERA

REFERENCIA	MEDIDAS (mm)					PRECIO
MANGO 6	MANGO 8	A	B	D+B	R	
FR 26-6	FR 26-8	6,3	4,8	44	3,2	14,05 €
FR 27-6	FR 27-8	9,5	6,3	38	4,8	9,47 €
FR 28-6	FR 28-8	12,7	7,9	38	6,3	11,39 €
FR 29-6	FR 29-8	15,9	9,5	38	7,9	13,19 €
FR 30-6	FR 30-8	19,1	12,7	38	9,5	17,82 €

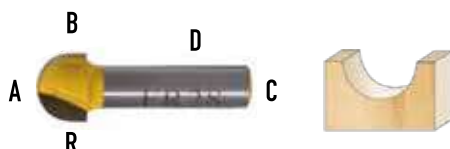

REFERENCIA	MEDIDAS (mm)					PRECIO
MANGO 6	MANGO 8	A	B	D+B	R	
FR 45-6	FR 45-8	25,4	15,9	52	4,0	25,59 €
FR 46-6	FR 46-8	34,9	22,2	57	6,3	26,84 €

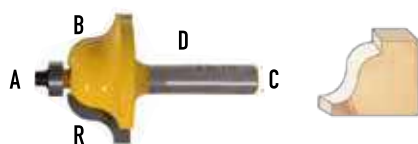

REFERENCIA	MEDIDAS (mm)						PRECIO
MANGO 6	MANGO 8	A	B	D+B	R1	R2	
FR 53-6	FR 53-8	25,4	15,9	52	4,0	4,0	26,06 €
FR 54-6	FR 54-8	34,9	22,2	57	6,3	6,3	37,84 €
FR 88-6	FR 88-8	37,1	12,7	52	4,7	1,6	37,84 €
FR 89-6	FR 89-8	38,1	15,9	53	6,0	3,6	45,50 €

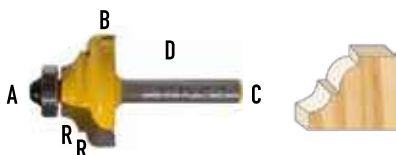

REFERENCIA	MEDIDAS (mm)					PRECIO
MANGO 6	MANGO 8	A	B	D+B	R	
FR 83-6	-	22,2	13,5	54	3,2	12,37 €
FR 84-6	FR 84-8	28,2	16,0	57	4,8	16,55 €
FR 85-6	FR 85-8	31,8	19,0	60	7,0	32,70 €



REFERENCIA	MEDIDAS (mm)					PRECIO
MANGO 8	A	B	D+B	R	R	
FR 62-8	19	12	54	45°	6,3	63,43 €



REFERENCIA	MEDIDAS (mm)					PRECIO
MANGO 8	MANGO 8	A	B	D+B	R	
FR 63-6	FR 63-8	24	12	55	25°	86,54 €



REFERENCIA	MEDIDAS (mm)					PRECIO
MANGO 6	MANGO 8	A	B	D+B	R	
FR 57-6	-	9,5	7,9	50	3,2	38,59 €

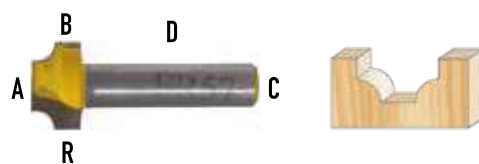

REFERENCIA	MEDIDAS (mm)					PRECIO
MANGO 6	MANGO 8	A	B	D+B	R	
FR 58-6	-	12,7	25,4	63		10,95 €
FR 59-6	-	16,0	15,9	50		9,09 €



REFERENCIA	MEDIDAS (mm)					PRECIO
MANGO 6	MANGO 8	A	B	D+B	R	
FR 64-6	FR 64-8	6,3	19,1	63		10,14 €



REFERENCIA	MEDIDAS (mm)						PRECIO
MANGO 6	MANGO 8	A	B	D+B	R1	R2	
FR 55-6	FR 55-8	34,9	13,5	52	4,8	3,6	37,84 €

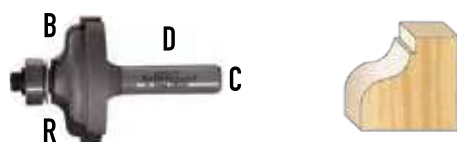

REFERENCIA	MEDIDAS (mm)						PRECIO
MANGO 6	MANGO 8	A	B	D+B	R1	R2	
FR 93-6	FR 93-8	19,1	12,7	54	3,7	4,0	23,23 €

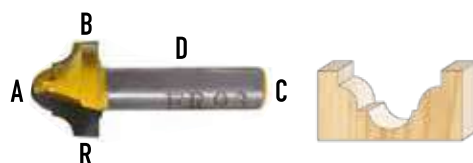

HERRAMIENTAS PARA CORTE

XWY-02K006

Corona de alta potencia de corte
Hojas de acero al tungsteno
Broca de centrado de 10 mm
Vástago hexagonal y cuerpo metálico
Profundidad de corte 33 mm
Usos:
Madera
Yeso encartonado
Planchas de construcción
Metales no féreos

||| y 60-67-74
81-95 mm



8,40€

XWY-02K005

Corona de alta potencia de corte
Hojas de acero al tungsteno
Broca de centrado de 8 mm
Vástago hexagonal y cuerpo metálico
Profundidad de corte 18 mm
Usos:
Madera
Yeso encartonado
Planchas de construcción
Metales no féreos.

||| y 26-35-38-45
50-56-63 mm



4,20€

CUCHILLAS REVERSIBLES

Válidas para cepillos eléctricos portátiles
Mod.: Ryobi, AEG, Black & Decker, Bosch
Dewalt, Hitachi, Makita, Metabo, Skill, Virutex



REFERENCIA		MEDIDAS (mm)	PRECIO
CU-REBLI82	Blister 2 uds.	82x55x1,1	5,25 €
CU-RECAJA10/78B	Caja 10 uds.	78x55x1,1	21,00 €
CU-RECAJA10/82B	Caja 10 uds.	82x55x1,1	

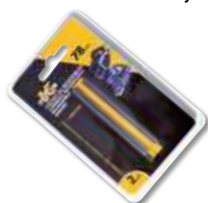

XWY-06K003

Cortacírculos con cuchillas ajustables, para cortes en techos, paredes y suelos. Usos: Madera laminada, madera contrachapada, yeso laminado y planchas acrílicas

11,50€



CORTE DE 30
A 250 MM

XWY-06K010

Cortacírculos regulable con
cuchillas ajustables
Usos: Contra-chapado,
plástico, pladur, escayola,
yeso... Con pantalla
protectora

||| Especial
techos

88,15€

CORTE REGULABLE DE 40 A 250 MM

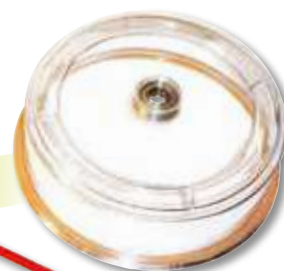

Cuchilla corta
Ref. XWY-06K010-1
P.V.P.: 4,41 €
Cuchilla widea
Ref. XWY-06K010-2
P.V.P.: 4,41 €
Cuchilla larga
Ref. XWY-06K010/1
P.V.P.: 4,99 €



CEPILLERÍA DE ALAMBRE

CEPILLO CIRCULAR TELA ALGODÓN

Para pulir el metal usando taladros y esmeriladoras

REFERENCIA	Ø	VÁSTAGO	EJE	PRECIO
ITBSP80	80	6 X 27	/	7,99 €
ITBSP150	150	/	16 - 20	12,30 €
ITSP200	200	/	20	20,98 €



CEPILLO TAZA - ACERO LATONADO

Para cepillado de grandes superficies en astilleros, calderería, construcción, etc. con amoladoras angulares

REFERENCIA	Ø	Ø HILO	PRECIO
ITT80BOX	75	0,30	9,18 €
ITT100	100	0,30	12,18 €
ITT120	120	0,30	16,80 €
ITT80Inox	75	0,30	17,98 €
ITT100Inox	100	0,30	29,66 €

■ || Eje M14



CEPILLO TAZA - ACERO TRENZADO

Para rebabas, satinado y pulido de grandes superficies con amoladoras angulares

REFERENCIA	Ø	TRENZA	PRECIO
ITTU71	70	18	17,67 €
ITTU85	85	22	31,47 €
ITTU111	105	26	38,90 €
ITTU131	120	32	48,08 €

■ || Eje M14



CEPILLO CÓNICO - ACERO

Para limpiezas de soldaduras y superficies irregulares en taladros y amoladoras angulares.

REFERENCIA	Ø	Ø HILO	TRENZA	PRECIO
ITCO90BOX(*)	95	0,30	18	8,68 €
ITCZ95BOX	95	0,30	26	15,48 €
ITCO90INOX	95	0,30	32	16,98 €
ITCO120BOX	120	0,35	22	19,54 €

(*) Acero latonado

■ || Eje M14



CEPILLO MANUAL

Limpieza de todo tipo de adherencias, pinturas y óxidos.

REFERENCIA	CALIDAD	Ø HILO	PRECIO
CE-CMLATON	Acero latonado	0.30	2,34 €
CE-CMINOX	Acero Inox.	0.15	2,94 €
ITSPIDPVC	PVC	0.30	5,51 €



CEPILLO CIRCULAR ACERO LATONADO

Para eliminación de óxidos, rebabas, pinturas, limpieza de piezas de fundición, cardado de pieles y cuero.

REFERENCIA	Ø	EJE	ESPESOR	PRECIO
IT3102	100	16	15	18,67 €
IT3122	125	16	17	18,66 €
IT4152	150	16	20	19,73 €
IT4203	200	20	29	32,28 €
IT6253	250	35	30	63,00 €

Uso con esmeriladoras

■ || y Hilo
0,30 mm



CEPILLO ACERO PARA TALADROS

Eliminación de óxidos, pinturas y adherencias. Preparación de superficies para la pintura. Pulido de piezas metálicas.

REFERENCIA	Ø	EJE	Ø HILO	ESPESOR	PRECIO
ITBG50	50	6 X 25	0,30	9	2,93 €
ITBG75	75	6 X 25	0,30	9	4,56 €
ITBG100	100	6 X 25	0,30	9	5,48 €
ITBTE50	50	6 X 30	0,30	/	3,88 €
ITBTE75	75	6 X 30	0,30	/	4,95 €
ITBGG73	70	6 X 25	0,30	12	14,85 €
ITBGG103	100	6 X 25	0,30	16	19,57 €
ITBP25	25	6 X 21	0,30	25	5,79 €
ITP20INOX	22	6 X 21	0,30	22	10,20 €



CEPILLO ITCZ200

Para desbrozadoras de más de 1,5 HP
Medida: 200x25,4x38 mm Z36
10.000 r.p.m. max. Acero 0,50 mm

63,70€



MIRA EL VIDEO



OFERTA SHOCK!!! PROMOCIÓN

femi
MADE IN ITALY

FM-780XL

Medida cinta (mm/Ø): 1.335x13x0,65
850 W
2 velocidades
Sin lubricación

CAPACIDAD DE CORTE

∠
(mm)

∅
(mm)

∠
(mm)

0°	105x93	105	102x102
45°	70x60	72	68x68

459€



Para celebrar
el logro de



1.000.000

de máquinas vendidas

Ahora...
la sierra 780XL
viene con la
mesa **Jobby**.

NO LO DEJES ESCAPAR

* Hasta fin de existencias

HERRAMIENTA / CORTE METAL

FM-784XL

Medida cinta (mm/Ø): 1.440x13x0,65
1.200 W
Regulación electrónica: "Constant speed"

725€

CAPACIDAD DE CORTE	∕ (mm)	∅ (mm)	∕ (mm)
0°	120x115	120	119x119
45°	85x70	85	80x80



SISTEMA DE TENSIÓN PATENTADO SIN LUBRICACIÓN

FM-785XL

Medida cinta (mm/Ø): 1.735x13x0,9
1.600 W
2 velocidades

1.200€

CAPACIDAD DE CORTE	∕ (mm)	∅ (mm)	∕ (mm)
0°	205x150	152	150x150
45°	105x95	106	102x102



SISTEMA EXCLUSIVO DE BRAZO ROTO-TRANSLANTE (PATENTADO) SIN LUBRICACIÓN

FM-787 "ALL ROAD"

Medida cinta (mm/Ø): 2.140x19x0,9
1.850 W

2.199€

CAPACIDAD DE CORTE	∕ (mm)	∅ (mm)	∕ (mm)
0°	213x150	175	150x150
45°	145x80	140	140x140



allroad



SISTEMA EXCLUSIVO DE BRAZO ROTO-TRANSLANTE (PATENTADO)

HERRAMIENTA / CORTE METAL



BAJADA AUTOMÁTICA



CICLO DE CORTE COMPLETAMENTE AUTÓNOMO, SIN PRESENCIA DEL OPERADOR

FM-ABS105

Medida cinta (mm/Ø): 1.335x13x0,65
950 W. 2 velocidades

750€

CAPACIDAD DE CORTE	∠ (mm)	∅ (mm)	∠ (mm)
0°	100x85	105	95x95
45°	65x60	65	65x65

FM-ABSNG120

Medida cinta (mm/Ø): 1.440x13x0,65
1.300 W - Regulación electrónica
"Constant speed"

1.099€



CAPACIDAD DE CORTE	∠ (mm)	∅ (mm)	∠ (mm)
0°	120x102	120	112x112
45°	78x78	80	78x78
60°	50x43	50	48x48



BAJADA AUTOMÁTICA

FM-ABSNG160

Medida cinta (mm/Ø): 1.735x13x0,9
2.000 W - Regulación electrónica
"Constant speed"

1.850€



CAPACIDAD DE CORTE	∠ (mm)	∅ (mm)	∠ (mm)
0°	160x140	150	150x150
45°	105x120	10	100x100



BAJADA AUTOMÁTICA

FM-NG105XL

Medida cinta (mm/Ø): 1.335x13x0,65
950 W

669€



CAPACIDAD DE CORTE	∠ (mm)	∅ (mm)	∠ (mm)
0°	100x85	105	95x95
45°	65x60	65	65x65



FM-NG120XL

Medida cinta (mm/Ø): 1.440x13x0,65
1300 W

999€



CAPACIDAD DE CORTE	∠ (mm)	∅ (mm)	∠ (mm)
0°	120x102	120	112x112
45°	78x78	80	78x78
60°	50x43	50	48x48



BAJADA AUTOMÁTICA





HERRAMIENTA / CORTE METAL

FM-1750XL Monofásica

Medida cinta (mm/Ø): 1.735x19x0,9
2000 W

1.799€

CAPACIDAD DE CORTE	 (mm)	 (mm)	 (mm)
0°	160x140	155	150x150
45°	100x120	110	100x100





MANUAL

FM-2200XL Monofásica

Medida cinta (mm/Ø): 2.140x19x0,9
2.000 W - Regulación electrónica
"Constant speed"

1.999€

CAPACIDAD DE CORTE	 (mm)	 (mm)	 (mm)
0°	200x75	17	175x175
45°	150x110	110	110x110
60°	100x70	75	75x75





MANUAL

FM-2200DAXL Monofásica

Medida cinta (mm/Ø): 2.140x19x0,9
2.000 W - Regulación electrónica
"Constant speed"

2.499€

CAPACIDAD DE CORTE	 (mm)	 (mm)	 (mm)
0°	200x75	175	175x175
45°	150x110	110	110x110
60°	100x70	75	75x75



BAJADA AUTOMÁTICA

FM-N250DAXL

■ ■ Monofásica

Medida cinta (mm/Ø): 2.480x27x0,9

1.100 W

2 velocidades

2.599€

CAPACIDAD DE CORTE	∕ (mm)	∅ (mm)	∕ (mm)
0°	245x160	225	185x185
45°	135x185	150	145x145
60°	63x107	70	70x70



SISTEMA HIDRÁULICO
BAJADA AUTOMÁTICA



FM-N251DAXL

■ ■ Trifásica

Medida cinta (mm/Ø): 2.480x27x0,9

750/1100 W

2 velocidades

2.599€

CAPACIDAD DE CORTE	∕ (mm)	∅ (mm)	∕ (mm)
0°	245x160	225	185x185
45°	135x185	150	145x145
60°	63x107	70	70x70



SISTEMA HIDRÁULICO
BAJADA AUTOMÁTICA



¡RECUERDA!

SOPORTE RODILLOS MODULARES

- Rodillos de acero Ø 50 mm montados sobre cojinetes.
- Recipiente de recogida del líquido de robusta chapa de acero.
- Estructura tubular de acero.
- Adaptación para 8 rodillos verticales anticáida.
- Pies de apoyo de altura regulable.

FM-326 FM-327

Para art.:
N310DADG
N257DADG
N276DAXL
N276XL
N250DAXL
N251DAXL
N266DAXL
N266XL
N265XL
N216XL
2200XL
2200DAXL



FM-N276DAXL

■ ■ Trifásica

Medida cinta (mm/Ø): 2.565x27x0,9
1.000/1300 W
2 velocidades

3.999€

CAPACIDAD DE CORTE	∇ (mm)	∅ (mm)	∇ (mm)
0°	265x200	255	200x200
45°	200x160	175	170x170
60°	115x100	110	100x100

SISTEMA HIDRÁULICO BAJADA AUTOMÁTICA



FM-N310DA/DG

■ ■ Trifásica

Medida cinta (mm/Ø): 2.750x27x0,9
1.000/1500 W
Mordaza deslizante. 2 velocidades

4.799€

CAPACIDAD DE CORTE	∇ (mm)	∅ (mm)	∇ (mm)
0°	320x200	255	195x195
45° IZDA.	210x80	205	195x195
60°	120x135	125	125x125
45° DCHA.	170x190	205	175x175

SISTEMA HIDRÁULICO BAJADA AUTOMÁTICA



FM-360 ■ Carga max. 120 kg

Banco multifunción
 Altura máx.
 rodillo: 500 mm
 Extensiones
 laterales: 120 mm

299€

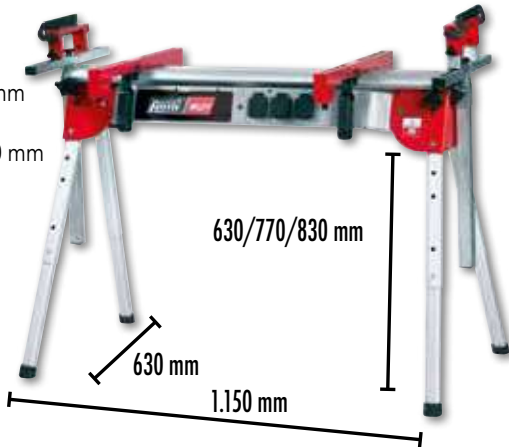

FM-330SMARTY ■ Carga max. 100 kg

Banco plegable

199€

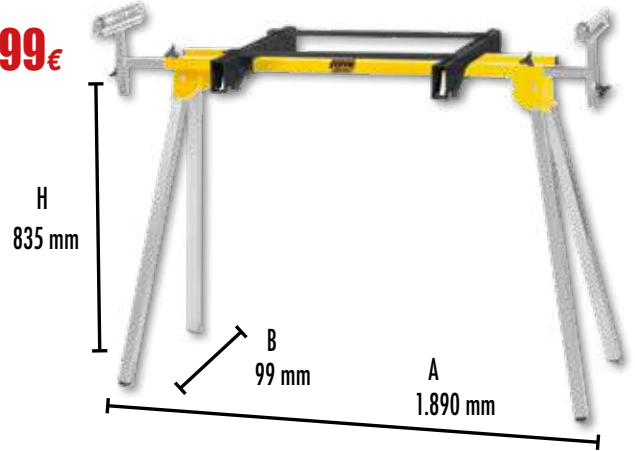

FM-326

Soporte de rodillos de
 entrada de 1 m
 Carga/descarga barras

399€

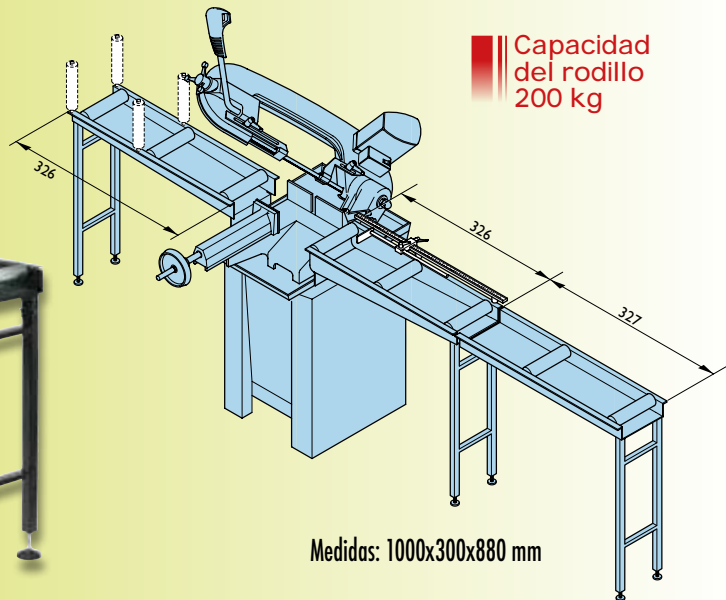

FM-327

Módulo adicional de
 soporte de rodillo de 1 m
 200 kg

255€

FM-300PLUS ■ Carga max. 50 kg

Banco plegable
 Jobby para ingletadoras
 y sierras de cinta
 3 alturas de trabajo: 740/820/870 mm
 Mesa: 650x420 cm

99€

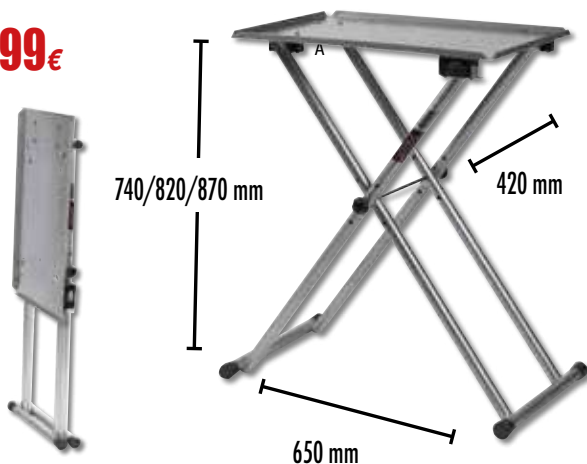

FM-301 ■ Carga max. 30 kg

Soporte de mono rodillo
 de acero galvanizado
 Regulable

75€

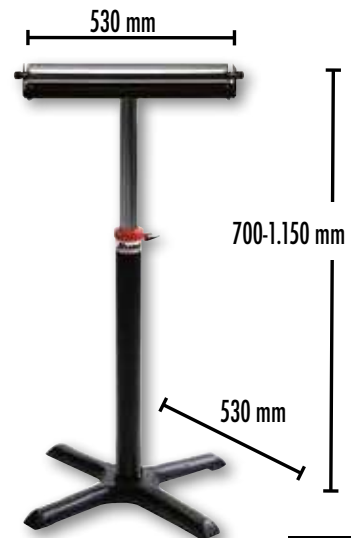

TALADROS DE COLUMNA

TODOS LOS MODELOS CON PORTA-BROCAS AUTOMÁTICO Y MORDAZA



	FM-611 VARIO	FM-614	FM-616	FM-621VARIO	FM-624
MOTOR (V-Hz)	230-50	230-50	400-50	230-50	230-50
POTENCIA (W)	550	750	750	1.110	1.100
CAPACIDAD DE PORTA-BROCAS (mm)	16	16	16	16	16
DIÁMETRO MÁX TALADRO (mm)	16	25	25	32	32
VELOCIDAD DE TALADRO (r.p.m.)	390-2200 Variable	220-2840	220-2840	440-2100 Variable	200-1990
DIÁMETRO DE COLUMNA (mm)	60	80	80	80	92
CARRERA DE HUSILLO (mm)	90	80	80	120	120
CONO	B16	B18	B18	B16	B18
CONEXIÓN	MT2	MT2	MT2	MT3	MT3
DISTANCIA TALADRO A COLUMNA (mm)	150	175	175	215	257
ALTURA (mm)	950	990	990	1650	1700
MESA CON EXTENSIÓN (mm)	243x243	290x290	290x290	335x335	395x425
LÁSER	Si	No	No	Sí	No
DISPLAY	Velocidad	No	No	Velocidad	No
LUZ	Si	No	No	Sí	No
MESA INCLINABLE	45° izda. 45° dcha.	45° izda. 45° dcha.	45° izda. 45° dcha.	45° izda. 45° dcha.	45° izda. 45° dcha.
PESO (Kg)	42	57	57	81	116



	FM-626	FM-634RV	FM-636RV	FM-646RVI
MOTOR (V-Hz)	400-50	230-50	400-50	400-50
POTENCIA (W)	1100	1500	1500	500-1000
CAPACIDAD DE PORTA-BROCAS (mm)	16	16	16	16
DIÁMETRO MÁX TALADRO (mm)	32	32	32	30
VELOCIDAD DE TALADRO (r.p.m.)	200-1990	150-2450	150-2450	127-2840
DIÁMETRO DE COLUMNA (mm)	92	92	92	98
CARRERA DE HUSILLO (mm)	120	120	120	100
CONO	B18	B18	B18	B16
CONEXIÓN	MT3	MT4	MT4	MT3
DISTANCIA TALADRO A COLUMNA (mm)	257	255	255	203
ALTURA (mm)	1700	1720	1720	1720
MESA CON EXTENSIÓN (mm)	395x425	460x425	460x425	350x280
LÁSER	No	No	No	Sí
DISPLAY	No	Sí	Sí	No
LUZ	No	Sí	Sí	Sí
MESA INCLINABLE	45° izda. 45° dcha.	360°	360°	360°
PESO (Kg)	116	135	135	200

ESMERILADORAS

ESMERILADORAS PROFESIONALES

FM-404 ■|| Doble muela

Esmeriladora/pulidora
Motor: 370 W
2.800 r.p.m.
Ø muela: 150x20x16 mm



299€



FM-405 ■|| Doble muela

Esmeriladora/pulidora
Motor: 500 W - 230 V
2.800 r.p.m.
Ø muela: 200x20x16 mm



399€



FM-424 ■|| Muela/Cepillo

Esmeriladora/pulidora
Motor 370 W - 230 V
Ø muela: 150x20x16 mm
Ø cepillo: 150x20x16 mm



349€



FM-425 ■|| Muela/Cepillo

Esmeriladora/pulidora
Motor: 500 W - 230 V
Ø muela: 200x20x16 mm
Ø cepillo: 150x20x16 mm



475€



ESMERILADORAS INDUSTRIALES ■|| Doble muela



REFERENCIA	VOLTAJE (V)	POTENCIA (W)	MUELA (mm)	r.p.m.	PRECIO
FM-241M	400	450	150x20x16	2800	515 €
FM-242M	230	750	200x25x20	2800	715 €
FM-243M	400	850	200x25x20	2800	715 €
FM-143MEVO	400	1100	200x30x20	2800	1.250 €
FM-145MEVO	230	1500	250x35x25	1400	1.550 €
FM-146M	230	2200	300x40x20	1400	1.699 €



ESMERILADORAS INDUSTRIALES COMBINADAS ■|| Muela/Cepillo



REFERENCIA	VOLTAJE (V)	POTENCIA (W)	MUELA (mm)	CEPILLO (mm)	PRECIO
FM-244M	230	450	150x25x16	150x25x16	604 €
FM-245M	400	450	150x25x16	150x25x16	604 €
FM-246M	230	750	200x25x20	200x25x16	756 €
FM-247M	400	850	200x25x20	200x25x16	756 €
FM-163MEVO	400	1100	200x40x20	200x30x20	1.350 €
FM-165MEVO	400	1500	250x40x25	250x40x20	1.500 €
FM-166M	400	2200	300x40x20	300x60x25	1.999 €



ESMERILADORAS / PULIDORAS / LIJADORAS

PULIDORAS INDUSTRIALES ■ ■ Cepillos no incluidos

REFERENCIA	VOLTAJE (V)	POTENCIA (W)	MUELA (mm)	r.p.m.	PRECIO
FM-213	230	750	200x25x16	2800	999 €
FM-209EVO	400	1100	250x40x20	2800	1.600 €
FM-211	400	2200	300x60x25	2800	3.600 €



ESMERILADORAS ECOLÓGICAS ■ ■ Doble muela

REFERENCIA	VOLTAJE (V)	POTENCIA (W)	MUELA (mm)	r.p.m.	PRECIO
FM-191M	400	450	150x20x16	2800	1.770 €
FM-192M	400	850	200x25x20	2800	1.999 €
FM-193MEVO	400	1100	200x30x20	2800	2.310 €
FM-194MEVO	400	1500	200x35x25	1400	2.661 €
FM-195M	400	2200	300x40x30	1400	4.500 €



LIJADORAS DE BANDA INDUSTRIALES

REFERENCIA	VOLTAJE (V)	POTENCIA (W)	BANDA (mm)	r.p.m.	PRECIO
FM-510	400	600	100x220	2800	1.399 €
FM-511	230	550	100x220	2800	1.399 €
FM-542B	400	1100	120x1500	1400	2.000 €
FM-543B	230	750	120x1500	1400	2.000 €
FM-504B	400	600-300	120x1500	1400/2800	2.400 €
FM-507B	400	1350-1600	150x17500	1400/2800	3.600 €



PULIDORAS ECOLÓGICAS

REFERENCIA	VOLTAJE (V)	POTENCIA (W)	CEPILLO (mm)	PRECIO
FM-204	400	850	200x25x16	2.500 €
FM-202EVO	400	1100	250x40x20	2.800 €
FM-203	400	2200	300x60x30	3.999 €



ESMERILADORAS ECOLÓGICAS ■ ■ Muela/Cepillo COMBINADAS

REFERENCIA	VOLTAJE (V)	POTENCIA (W)	CEPILLO (mm)	r.p.m.	PRECIO
FM-196M	400	450	150x20x16	2800	1.999 €
FM-198MEVO	400	1100	200x30x20	2800	2.500 €
FM-199MEVO	400	1500	250x35x25	1400	2.800 €
FM-200M	400	2200	300x40x30	1400	4.700 €



ESMERILADORAS / LIJADORAS

LIJADORAS DE BANDA-DISCO ■ ■ Industrial

REF.	VOLTAJE (V)	POTENCIA (W)	BANDA (mm)	m/s	PRECIO
FM-525B	400	1350-1600	150x1750	16	3.000 €
FM-539B	400	1350-1600	150x1750	30	5.500 €

Ø DISCO: 400 MM



ESMERILADORAS-LIJADORAS DE BANDA

REF.	VOLTAJE (V)	POTENCIA (W)	BANDA (mm)	r.p.m.	PRECIO
FM-293N	230	750	100x1000	2800	1.049 €
FM-294N	400	850	100x1000	2800	1.049 €

MUELA 200X25X20 MM



ESMERILADORAS LIJADORAS DE BANDA ■ ■ Industrial

REF.	VOLTAJE (V)	POTENCIA (W)	MUELA (mm)	r.p.m.	PRECIO
FM-296EVO	400	1100	200X25X20	2800	2.600 €
FM-298EVO	400	1100	-	2800	3.700 €

BANDA 50X2200 MM



LIJADORAS DE BANDA HORIZONTAL ■ ■ Industrial

REF.	VOLTAJE (V)	POTENCIA (W)	BANDA (mm)	m/s	PRECIO
FM-577	400	4000	150X2000	15/30	1.799 €
FM-575	400	3000	75X2000	30	999 €
FM-574	230	2200	75X2000	30	999 €





Femi
job Line

TALADROS DE COLUMNA

TODOS LOS MODELOS CON MORDAZA INCLUIDA

FM12-921PLUS



149€

FM-DIGIMAX13A



159€

FM-DIGIMAX13



Hasta fin de existencias

179€

FM12-941PLUS



269€

	FM12-921PLUS	FM-DIGIMAX13A	FM-DIGIMAX13	FM12-941PLUS
MOTOR (V-Hz)	230-50	230-50	230-50	230-50
POTENCIA (W)	500	720	720	460
CAPACIDAD DE PORTA-BROCAS (mm)	13	13	13	16
DIÁMETRO MÁX TALADRO (mm)	13	13	13	16
VELOCIDAD DE TALADRO (r.p.m.)	580-2650	500-2600	220-880 / 650-2550	230-2470
DIÁMETRO DE COLUMNA (mm)	46	46	46	60
CARRERA DE HUSILLO (mm)	50	80	80	60
CONO	B16	B16	B16	B16
CONEXIÓN	MT2	MT2	MT2	MT2
DISTANCIA TALADRO A COLUMNA (mm)	104	126	280	126
ALTURA (mm)	580	660	660	845
MESA CON EXTENSIÓN (mm)	160x160	340x300x40	340x300x40	202x197
LÁSER	No	Si	Si	No
DISPLAY	No	Si	Si	No
LUZ	No	Si	Si	No
MESA INCLINABLE	45° izda. / 45° dcha.	-	-	45° izda. / 45° dcha.
PORTABROCAS	Llave	Automático	Automático	Automático
PESO (Kg)	18	10	9,5	27

FM12-951PLUS



439€

FM12-953PLUS



649€

FM12-961PLUS



975€

	FM12-951PLUS	FM12-953PLUS	FM12-961PLUS
MOTOR (V-Hz)	230-50	230-50	230-50
POTENCIA (W)	550	750	1100
CAPACIDAD DE PORTA-BROCAS (mm)	16	16	20
DIÁMETRO MÁX TALADRO (mm)	16	25	32
VELOCIDAD DE TALADRO (r.p.m.)	180-2740	160-3000	150-2020
DIÁMETRO DE COLUMNA (mm)	70	80	92
CARRERA DE HUSILLO (mm)	80	80	120
CONO	B16	B22	B22
CONEXIÓN	MT2	MT2	MT3
DISTANCIA TALADRO A COLUMNA (mm)	170	215	257
ALTURA (mm)	1065	1635	1700
MESA CON EXTENSIÓN (mm)	255x255	323x323	475x475
LÁSER	No	No	No
DISPLAY	No	No	No
LUZ	No	No	No
MESA INCLINABLE	45° izda. / 45° dcha.	45° izda. / 45° dcha.	45° izda. / 45° dcha.
PORTABROCAS	Automático	Automático	Automático
PESO (Kg)	42	80	113

HERRAMIENTA MADERA

FM-TR076

1200 W
Motor universal

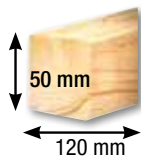

Disco Ø210 mm
F36-080

169€



FM-TR230

1200 W
Motor universal

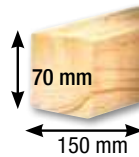

Disco Ø255 mm
DM25430Z42
DM25430Z60

229€



FM-TR235

1800 W
Motor universal

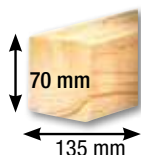

Disco Ø250 mm
DM25430Z42
DM25430Z60*
*Alto rendimiento

269€



FM-TR240

1450 W
Motor universal

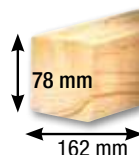

Disco Ø254 mm
DM25430Z42
DM25430Z60

309€



TOP
LINE

FM-TR100

2000 W
Motor universal

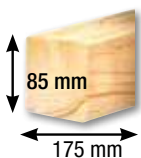

Disco Ø305 mm
FM-TR36-001 (Z24)
FM-TR36-002 (Z60)

379€



FM-TR305I

1.400 W
Motor inducción

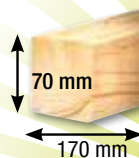

Disco Ø305 mm
FM-TR36-001 (Z24)
FM-TR36-002 (Z60)

689€



HERRAMIENTA MADERA

FM-TR1021DB

1700 W
Motor universal
Doble inclinación



Disco Ø210 mm
F36-080

179€

TELESCÓPICA



LASER

FM-TR1025B

2.000 W
Motor universal

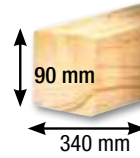

Disco Ø255 mm
DM25430Z42
DM25430Z60

259€

TELESCÓPICA



LASER

FM-TR1021

1500 W
Motor universal
Doble inclinación



Disco Ø210 mm
F36-080

309€

TELESCÓPICA



LASER

FM-TR1025A

2.200 W
Motor universal



Disco Ø255 mm
DM25430Z42
DM25430Z60

329€

TELESCÓPICA



LASER

FM-TR1030DB-A

2000 W
Motor universal
Doble inclinación

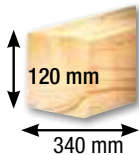

Disco Ø305 mm
FM-TR36-001 (Z24)
FM-TR36-002 (Z60)

399€

TELESCÓPICA



LASER

FM-1050/3D

1.800 W
Motor universal

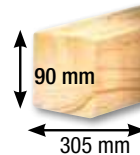

Disco Ø305 mm
FM-3278531 (Z48)

679€

TELESCÓPICA



LASER

HERRAMIENTA MADERA

FM-999EVO

1.700 W
Motor universal

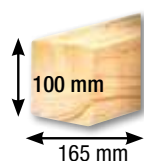

Disco Ø 305 mm
FM-3278531 (Z48)
P.V.P.: 115 €

999€



TOP
LINE

FM-IB500

■|| Guía ajustable

Encoladora de cantos
2.000 W
Flujo de calor: 18-30 m³/h
Ø borde: 48 mm
Temperatura de calentamiento:
350° a 500° °C

599€

2 VELOCIDADES



SH23-730

Afiladora
150 W
Muela: 200x40x12 mm
Disco: 200x30x12 mm

179€



CM60-150

■|| Motor universal

Máquina combinada: sierra circular,
escuadradora, tupi, fresadora, cepilladora,
calibradora
1.000 W
Altura corte: 60 mm
Ancho cepillado:
154 mm
Espesor cepillado:
170 mm
4.200 r.p.m.

1.799€

Ø DISCO 200 MM



BD31-462

Lijadora combinada
370 W
Ø disco de lija: 150 mm (autoadhesivo)
Banda de lija: 100x914mm

199€



SS40-562

Sierra para marquetería
125 W
Hoja de sierra:
127 mm

289€



Hoja de sierra/pelo segueta (Z6)
Ref.: SS40-615
P.V.P.: 26 €

FM28-182

250 W - 230V
Medida cinta (mm/Ø): 1.400x6x0,35 Z6
(de serie)

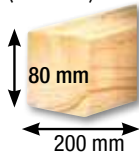

CINTAS DISPONIBLES

REFERENCIA	MEDIDAS (mm)	PRECIO
FM-VB28-183	1400x3x0,36 Z6	32,00€
FM-VB28-184	1400x6x0,36 Z6	
FM-VB28-185	1400x8x0,36 Z6	

179€



FM28-186

420 W - 230V
Medida cinta (mm/Ø): 1.790x10x0,35 Z6
(de serie)

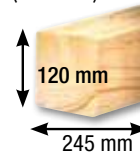

CINTAS DISPONIBLES

REFERENCIA	MEDIDAS (mm)	PRECIO
FM-VB28-187	1790x6x0,35 Z5	38,00€
FM-VB28-188	1790 x10x0,35 Z6	

275€



FM28-191

750 W - 230V
Medida cinta (mm/Ø): 2.240x12,5x0,5 Z4
(de serie)



CINTAS DISPONIBLES

REFERENCIA	MEDIDAS (mm)	PRECIO
FM-VB28-577	2240x6x0,5 Z6	46,00€
FM-VB28-578	2240x12,5x0,5 Z4	
FM-VB28-579	2240x20x0,5 Z4	

499€



FM28-194

1100 W - 230V
Medida cinta (mm/Ø): 2.560x10x0,5 Z4
(de serie)



CINTAS DISPONIBLES

REFERENCIA	MEDIDAS (mm)	PRECIO
FM-VB28-173	2560x25x0,5 Z4	68,00€
FM-VB28-171	2560x10x0,5 Z4	
FM-VB28-172	2560x20x0,5 Z4	

1.199€



FM28-195

2200 W - 230V
Medida cinta (mm/Ø): 3.607x25x0,6 Z3
(de serie)

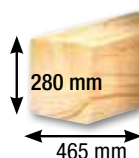

CINTAS DISPONIBLES

REFERENCIA	MEDIDAS (mm)	PRECIO
FM-VB28-598	3607x10x0,6 Z6	64,00€
FM-VB28-597	3607x25x0,6 Z3	

2.499€



FM-PF150

Cepilladora
1.500 W

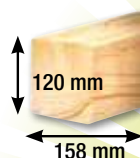

399€

Cuchillas 158x20x1,6 mm
Ref.: FM3280014
P.V.P.: 35 €



HERRAMIENTA MADERA

FM-CYCLONE

Cepilladora regruesadora
1.500 W

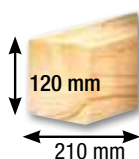

539€

Cuchillas 210x20x1,6 mm
Ref.: FM3280010
P.V.P.: 45 €

TS36-523

Motor universal

Sierra de mesa
1.800 W
5.700 r.p.m.
Mesa de trabajo:
480x640 mm
Altura max. de corte:
80 mm a 0°
60 mm a 45°



219€

Ø DISCO 254 MM

Disco Ø255 mm
FM-TR36-001 (Z24)
FM-TR36-002 (Z60)

FM36-528

Motor inducción

Sierra de mesa
2.000 W
2.800 r.p.m.
Altura max. de corte:
83 mm a 0°
49 mm a 45°



Mesa de trabajo:
800x550 mm

349€

Ø DISCO 315 MM

Disco Ø315 mm
FM-TS36-532 (Z24)
P.V.P.: 33 €

FM-PF250

Máquina combinada
1500 W
Ancho cepillado:
254 mm
Alto regrueso:
de 5 a 120 mm



429€

Cuchillas: 261x16,5 mm
Ref.: F22-573
P.V.P.: 49 €

PF250-600

2200 W

Cepilladora y calibradora
Profundidad max. cepillado: 3 mm
Anchura max. cepillado: 250 mm
Regrueso (altura): 190 mm



1.999€

3 CUCHILLAS

RT400

Fresadora de banco
1500 W
Regulación de la altura de corte: 0 a 40 mm
Dimensiones max. pieza:
650x160xH65 mm

519€



CONECTABLE
A ASPIRADOR

Aspiradores manejables para operaciones de aspiración de serrín. Adaptados para acoplarse a máquinas de carpintería. Silenciosos motores de inducción potentes. Con protección térmica. Filtración 35 micron. Ventilador de aspiración de aluminio.

FM-DC345PLUS

550 W
1.200 m³/h
Ø boquilla para tubo aspiración: 100x1
Presión: 71 mm
H2O
Tubo flexible: 2 m
Bolsa filtrante en hebrado (5µm) para virutas

Disponible kit de reducción para Ø de tubo:
100/70-70/45-45/40-40/35 mm

199€

MONOFÁSICO



FM-DC350PLUS

900 W
950 m³/h
Ø boquilla para tubo aspiración: 100x1
Presión: 175 mm
H2O
Tubo flexible: 2 m
Boquilla para pavimentos
Bolsa de recogida de polvo nylon
Bolsa filtrante en hebrado (5µm) para virutas

369€

TRIFÁSICO



REFERENCIA	TIPO/ MATERIAL	FILTRACIÓN (µ)	PARA	PRECIO
FM-5073239	Bolsa Nylon			23,00 €
FM-5073240	Saco hebrado	5	Polvo fino	18,00 €

REFERENCIA	TIPO/ MATERIAL	FILTRACIÓN (µ)	PARA	PRECIO
FM5073229	Bolsa Nylon			23,00 €
FM5073228	Saco algodón diagonal	40	Polvo y virutas de madera	19,00 €
FM-5073237	Saco hebrado	5	Polvo fino	19,00 €

FM-DC351PLUS

1.500 W
2.700 m³/h
Ø boquilla para tubo aspiración: 100x2
Presión: 196 mm
H2O
Tubo flexible: 2 m
Bolsa de recogida de polvo nylon
Bolsa filtrante en hebrado (5µm) para virutas

499€

MONOFÁSICO



FM-DC352PLUS
Versión trifásica
P.V.P.: 499 €

FM-DC355PLUS

2.200 W
3.900 m³/h
Ø boquilla para tubo aspiración: 100x3
Presión: 196 mm
H2O
Tubo flexible: 2 m
Bolsa de recogida de polvo nylon
Bolsa filtrante en hebrado (5µm) para virutas

649€

TRIFÁSICO



ACCESORIOS ASPIRADORES

REFERENCIA	TIPO/ MATERIAL	FILTRACIÓN (µ)	PARA	PRECIO
FM5073232	Bolsa Nylon			23,00 €
FM5073233	Saco algodón diagonal	30	Polvo y virutas de madera	23,00 €
FM5073234	Saco algodón diagonal	40	Polvo y virutas de madera	23,00 €
FM5073238	Saco hebrado	5	Polvo fino	18,00 €

HERRAMIENTA CORTE METAL



FM-1140E "FLEXICUT"

Sierra de cinta portátil. 1100 W
Medida cinta (mm/Ø): 1140x13x0.65 Z10/14
Velocidad: 0-144 r.p.m.
Regulación electrónica

269€

LED



CAPACIDAD DE CORTE	 (mm)	 (mm)	 (mm)
0°	130x120	120	120x120



FM-FLEXIBASE

Base con mordaza para trabajo de mesa

89€

OPCIONAL PARA FM-1140E



CAPACIDAD DE CORTE*	 (mm)	 (mm)	 (mm)
0°	95x80 (115x18)	80	80
45°	85x10 (58x28)	40	38

*Máquina + base

FM-XXEVO-ALU

Aluminio

Ingletadora 1500 W
Motor inducción

1.099€

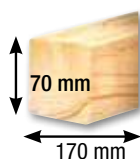

Disco Ø305 mm
FM-3271953 (Z84)



CS20-140

Tronzadora 2.000 W
3.000 r.p.m.
Motor universal

160€



Disco Ø355 mm
Ref.: DR350H
P.V.P.: 5 €

FM-MAGNETIKO

Varilla magnetica para recoger virutas inoxidable
Ø 20 mm. Largo: 435 mm

39,95€



FM-DIGITOML350

Torno para metal. 450 W
Portabrocas 3 pinzas
Ø portabrocas: 80 mm
Ø torneado máx.: 180 mm
Ø distancia entre brocas: 350 mm
Ataque: MT3. Cono morse: MT2
50-2500 r.p.m.

1.499€

REGULACIÓN ELECTRÓNICA

START/STOP



Juego de herramientas
Ref.: FM-3612010
P.V.P.: 59 €

FM-BG26N

Esmeriladora doble muela
150 W. Motor de inducción
Ø muela: 150x16x12,7 mm

49€

MUELAS
INCLUIDAS



FM-BG33N

Esmeriladora doble muela
370 W. Motor de inducción
Ø muela: 200x20x16 mm

89€

MUELAS
INCLUIDAS



*Base de plástico con
recipiente estándar para agua

FM-BG36N

Esmeriladora/Pulidora
330 W. Motor de inducción
Ø muela: 150x20x12,7 mm
Ø cepillo: 150x20x16 mm

89€

MUELAS
Y CEPILLO
INCLUIDOS



*Base de plástico con
recipiente estándar para agua

FM-BG46N

Afiladora combinada
400 W. Motor de inducción
Ø muela blanca: 200x40x20 mm
Ø muela gris: 150x20x12,7 mm

89€

MUELAS
INCLUIDAS



*Base de plástico con
recipiente estándar para agua

FM-BG56N

Esmeriladora/Lijadora
330 W. Motor de inducción
Ø muela gris: 150x20x12,7 mm
Banda: 50x686 mm

89€

MUELA
Y BANDA
INCLUIDAS



*Base de plástico con recipiente estándar para agua

ACCESORIOS ESMERILADORAS

REFERENCIA	GRANO	PRECIO
CE-MUELAGUA200	150	63,00 €
CE-MUELA150GR36	36	19,00 €
CE-MUELA150GR60	60	19,00 €
CE-MUELA200GR36	36	21,00 €
CE-MUELA200GR60	60	21,00 €
IM-BANDA50X680	80	15,00 €



WAGNER

CHANGE it.



Leyenda



Esmaltes, lacas
y barnices



Pinturas
plásticas

HEA HIGH EFFICIENCY
AIRLESS

SISTEMA AIRLESS DE BAJA PRESIÓN



TECNOLOGÍA

CLICK & PAINT



DECAPADORES

FURNO 100

Decapador
350 W
Flujo de aire: 100-150 l/min
Temperatura: 230°C - 360°C
WG-2398546

25€

2 NIVELES DE
TEMPERATURA



FURNO 300

Decapador
1.600 W
Flujo de aire: 675 l/min
Temperatura: 400°C - 575°C
WG-2359348

29€

2 NIVELES DE
TEMPERATURA



FURNO 750

Decapador
2.000 W
Flujo de aire regulable
820 l/min
Temperatura: 50°C - 650°C
4 boquillas
WG-2359358

Display
digital



81€

SISTEMA DE
AUTO-ENFRIAMIENTO



FURNO 500

Decapador 2.000 W
Flujo de aire regulable 800 l/min
Temperatura: 60°C - 600°C
2 boquillas
12 niveles de temperatura
WG-2359352

51€

SISTEMA DE
AUTO-ENFRIAMIENTO



CONTROL PRO 300 MOVE

Depósito: 4,7 l
Caudal: 0,9 l/min
Manguera: 7,5 m
Boquillas incluidas 311-515
300W
WG-2443925

Airless a batería
Producto base agua

HEA HIGH EFFICIENCY AIRLESS



699€

PUEDEN UTILIZARSE EN EXTERIOR E INTERIOR
GRAN VARIEDAD DE MATERIALES (PINTURAS PARED, ESMALTES, LACAS, IMPRIMACIONES...)

MÁXIMA LIBERTAD DE MOVIMIENTOS AL APLICAR.

SISTEMA HEA HASTA 55% MENOS DE NEBLINA.



* Cargador y batería INCLUIDOS



W600

Turbina a batería

Depósitos: 1300 ml + 800 ml
Tamaño de trabajo pequeño: 5m²/10 min
0,20 Bar
20V
WG-2420174

CLICK & PAINT



189€

COMPATIBLE CON BATERÍA BOSCH ALL 18 V SYSTEM



Batería y cargador NO INCLUIDOS



60€ Set cargador y batería
Ref.: WG-2448616



W250

Turbina a batería

Depósito: 800 ml
Tamaño de trabajo pequeño: 5m²/10 min
0,20 Bar
18V
WG-2457703

CLICK & PAINT



89,95€

COMPATIBLE CON BATERÍA BOSCH ALL 18 V SYSTEM



Batería y cargador NO INCLUIDOS



60€ Set cargador y batería
Ref.: WG-2448616



SISTEMAS DE PINTURA

W100

CLICK & PAINT



Depósito: 800 ml
Tamaño de trabajo pequeño:
5m²/10 min.
Consumo: 280 W
WG-2361507

88€



W125

CLICK & PAINT



Depósito: 600 ml
Tamaño de trabajo mediano:
5m²/10 min.
Consumo: 350 W
WG-2409303

65€



W180P

CLICK & PAINT



Depósito: 800 ml
Tamaño de trabajo mediano:
5m²/10 min.
Consumo: 110 W
WG-413001

69€



W450PLUS

Depósitos: 1300 ml + 1.800 ml
Potencia pulverización: 110 W
Tamaño de trabajo grande: 15m²/10 min
Consumo: 460 W
Manguera 1,8 m
WG-2373630

129€



CLICK & PAINT



W690 FLEXIO

Depósitos: 1800 + 800 ml
Tamaño de trabajo grande: 15m²/6 min
Consumo: 630 W
Manguera 3,5 m
WG-2361543

169€

CLICK & PAINT



W950 FLEXIO

Succión directa

CLICK & PAINT

Depósito: 800 ml
Tamaño de trabajo grande: 15m²/6 min
Consumo: 630 W
WG-2361555

249€



Incluye depósito adicional
WG-2361730



REGULACIÓN DE CAUDAL DE AIRE VARIABLE



BLACK RANGE

SISTEMAS DE PINTURA

W150

Depósito: 600 ml
Tamaño de trabajo mediano:
5m²/10 min
Consumo: 300 W
WG-2359328

CLICK & PAINT



79€



W510

Depósitos:
800 ml + 1300 ml
Tamaño de trabajo mediano:
5m²/6 min
Consumo: 460 W
WG-2402017

CLICK & PAINT



125€



W575 FLEXIO

Depósitos:
1300 ml + 800 ml
Tamaño de trabajo grande:
15m²/6 min
Consumo: 630 W
WG-2397237

CLICK & PAINT



149€



W975 FLEXIO

Depósito: 800 ml
Manguera: 3,5 m
Tamaño de trabajo grande:
15m²/5 min
Consumo: 630 W
WG-2454265

Succión directa

269€



CLICK & PAINT



Incluye set de limpieza

CONTROL PRO 275M

Caudal: 1,25 l/min
Manguera: 9 m
Boquillas incluidas: 311-517
Consumo: 550 W
WG-2443409

Succión directa

HEA HIGH EFFICIENCY AIRLESS



469€

AIRLESS



REGALO SUDADERA



SISTEMAS DE PINTURA AIRLESS

CONTROL PRO 150M

Caudal: 0,9 l/min
Manguera: 7,5 m
Boquillas incluidas: 311 - 515
Consumo: 300 W
WG-2394312

339€

PRODUCTO
BASE AGUA



HEA HIGH EFFICIENCY AIRLESS



Incluye nueva pistola:
T2 AIRLESS SPRAY GUN

CONTROL PRO 250M

Caudal: 1,25 l/min
Manguera: 9 m
Boquillas incluidas: 311- 517
Consumo: 550 W
WG-2371053

479€

PRODUCTO
BASE AGUA



HEA HIGH EFFICIENCY AIRLESS



CONTROL PRO 250R

Caudal: 1,25 l/min
Manguera: 9 m
Boquillas incluidas: 311- 517
Consumo: 550 W
WG-2371069

479€

PRODUCTO
BASE AGUA



HEA HIGH EFFICIENCY AIRLESS



CONTROL PRO 350R

Caudal: 1,50 l/min
Manguera: 15 m
Boquillas incluidas: 311 - 517
Consumo: 600 W
WG-2371073

599€

PRODUCTO
BASE AGUA

MAYOR POTENCIA



HEA HIGH EFFICIENCY AIRLESS



CONTROL PRO 350M

Caudal: 1,50 l/min
Manguera: 15 m
Boquillas incluidas: 311 - 517
Consumo: 600 W
WG-2371057

649€

PRODUCTO
BASE AGUA

MAYOR POTENCIA



HEA HIGH EFFICIENCY AIRLESS





W915E

Sistema de limpieza a vapor.
1500 W
Tiempo vaporizado máx.: 40 min
Depósito: 1,5 l
Presión: 3,5 bar
Longitud manguera: 2,4 m
WG-2452622

 Tiempo precalentado
9 min

139€



Accesorios incluidos

"STEAM FORCE"

Quitapapeles a vapor
2.000 W
Depósito: 4 l
Tiempo vaporizado máx.: 80 min
WG-2410385

55€

PARA PAPEL PINTADO



ACCESORIOS PARA SISTEMAS DE PULVERIZACIÓN

FRONTAL STANDARD

Depósito turbina
HVLP para esmaltes y lacas
WG-2361730

24€

800 ML



CLICK & PAINT

FRONTAL CORNER

Depósito turbina
HVLP para esmaltes y lacas
WG-2361742

24€

600 ML

ESQUINAS Y
RINCONES



CLICK & PAINT

FRONTAL DETAIL

Depósito turbina
HVLP para esmaltes y lacas.
WG-2361744

27€

250 ML

GRAN
PRECISIÓN



CLICK & PAINT

FRONTAL LARGE

Depósito turbina
HVLP para esmaltes y lacas
WG-2361736

24€

1400 ML

GRAN
AUTONOMÍA



CLICK & PAINT

FRONTAL BRILLIANT

Depósito turbina
HVLP para esmaltes y lacas
WG-2361738

24€

600 ML

ACABADO ALTA
CALIDAD



CLICK & PAINT

FRONTAL EXTRA I-SPRAY

Depósito turbina
HVLP para pinturas plásticas
WG-2361746

38€

1300 ML

AMPLIO ANCHO
DE ABANICO



CLICK & PAINT

FRONTAL EXTRA I-SPRAY

Depósito turbina
HVLV para pinturas plásticas
WG-2361749

40€

1800 ML

AMPLIO ANCHO
DE ABANICO



CLICK&PAINT

FRONTAL GRAVEDAD

Depósitos: 150+ 600 ml
Para trabajos
pequeños y medianos
WG-2412884

35€



CLICK&PAINT

EXTENSIÓN UNIVERSAL EXTRA

Prolongador ergonómico
Muy útil en paredes y techos
Ref.: WG-2361756

29€



CLICK&PAINT

Asa CLICK&PAINT

Para frontales Wall Extra
WG-2362879

16€



*Adaptador
WG-2315666
P.V.P.: 28 €

WG-50342

Viscosímetro grande
Ø 4 mm

7€



WG-209058

Viscosímetro pequeño
Ø 2,1 mm

6€



WG-517802

Manguera Control Pro
Ø 8 mm

116€

15 M



WG-580050

Manguera Control Pro
Ø 8 mm

95€

9 M



WG-2354639

Kit limpieza

9€



ACCESORIOS PARA SISTEMAS DE PULVERIZACIÓN

WG-517101

Pistola Control Pro Metal

188€



AIRLESS

SET 2 FILTROS

REFERENCIA	COLOR	PRECIO
WG-418711	ROJO	20,00 €
WG-418712	AMARILLO	
WG-418713	BLANCO	
WG-2450276 (*)	ROJO	24,00 €
WG-2450281 (*)	BLANCO	
WG-2450282 (*)	AMARILLO	

(*) Para Control Pro 300 Move



RODILLO DIY AUTOALIMENTADO

Depósito: 550 ml
Rendimiento: 5 m²
Longitud: 1,25 m
WG-2419944

36€



EXTENSIÓN CONTROL PRO

Incluye porta boquillas

REFERENCIA	LARGO (CM)	PRECIO
WG-517700	30	86,00 €
WG-517701	60	97,00 €



DISPOSITIVO BOQUILLA

WG-517200

36€



BOQUILLA HEA CONTROL PRO

WG-517

REFERENCIA	MARCAJE	VÁLIDA PARA
WG-517211	211	Esmaltes, lacas, barnices
WG-517311	311	Esmaltes, lacas, barnices
WG-517313	313	Esmaltes, lacas, barnices
WG-517413	413	Esmaltes, lacas, barnices
WG-517515	515	Pinturas plásticas interior
WG-517517	517	Pinturas plásticas interior
WG-517619	619	Pinturas plásticas exterior

55€



WG-998230

Recambio rodillo
230x12 mm

7€



WG-245717

Recambio rodillo
230x20 mm

7€



SISTEMAS DE PINTURA PROFESIONAL



FINISH CONTROL 3500

Consumo: 700 W
Presión máx.: 0,2 bar
Peso: 3,5 Kg
WG-2341501

Válido para
productos
disolventes

499€

TURBINA XVLP



CLICK AND PAINT



FINISH CONTROL 5500

Depósito: 800 ml
Tamaño de trabajo mediano:
5m²/10 min
0,29 bar. Consumo: 1.150 W
Doble filtro. Filtro de aire
Indicador luminoso
WG-2422986

Válido para
productos
disolventes

799€

TURBINA XVLP



REGALO
SUDADERA



Frontal Estándar
incluido

Ref.:WG-2430386

FINESPRAY

Frontal profesional
especial barnices,
lacas y lasures
WG-2430385

Boquilla
redonda

125€



WALLSPRAY

Frontal profesional
especial para
pinturas
de interior
WG-2430387

Boquilla
plana

125€



STANDARDSPRAY

Frontal profesional
especial esmaltes
WG-2430386

Boquilla
plana

125€



WAGNER

SISTEMAS DE PINTURA PROFESIONAL

FINISH CONTROL 4000

Depósito: 1.000 ml
 Tamaño de trabajo mediano:
 5m²/10 min
 0,20 bar
 Consumo: 370 W
 2 Baterías de 4 Ah
 WG-2437240

950€

TURBINA XVL P

AUTONOMÍA 25 MIN* APROX.

Válido para
 productos
 disolventes



*Dependiendo del tipo de material

Frontal Fine Finish incluido. Ref.:WG-2430385

		WG-2430385	WG-2430386	WG-2430387
FRONTAL		FineSpray Boquilla redonda	StandardSpray Boquilla plana	WallSpray Boquilla plana
Barnices/Lacas/Lasures. Baja viscosidad (Base agua y disolvente)		★★	★	★
Esmalte Base agua y disolvente	Standard	★★	★★	★★
	Alta viscosidad	★★	★	★
Pinturas interior. Emulsiones y pinturas LATEX		★★	★★	★★



INCLUYE: CARGADOR, BATERÍAS (BOSCH AMPSHARE PROCORE18V), SET DE LIMPIEZA Y MALETA



POWER PAINTER 90 SKID SPRAYPACK

Caudal: 1.9 l/min
Tamaño boquilla: 0,019"
Consumo: 0,8 kW
200 bar - 22,1 Mpa
WG-2414079

999€

Vlido para
productos
disolventes

HEA HIGH EFFICIENCY
AIRLESS

SISTEMA AIRLESS



Bomba "Doble efecto". Mayor vida útil de la máquina y menor desgaste

PROSPRAY3.20

Bomba eléctrica de pistón
207 bar
Tamaño boquilla: 0,021"
Caudal: 2 l/min
Consumo: 1,3 kW
15 m manguera
WG-2412438

1.499€

Vlido para
productos
disolventes

HEA HIGH EFFICIENCY
AIRLESS

REDUCCIÓN DE NIEBLA
casi en un 55%

PULVERIZACIÓN A
BAJA PRESIÓN

REGALO
SUDADERA



ACCESORIOS AIRLESS PROFESIONAL

BOQUILLAS AIRLESS

TRADE TIP3 AIRLESS

Máxima durabilidad
Incluyen filtro y junta
WG-553 + N° IMPAR

46€



Carburo tungsteno

TRADE TIP3 FINE FINISH

Máxima durabilidad
Incluyen filtro y junta
WG-554 + N° PAR

55€



Carburo tungsteno

SPEED TIP2 AIRLESS

Máxima durabilidad
Incluyen filtro y junta
WG-271

70€



Carburo tungsteno

HEA PROTIP

Máxima durabilidad
Incluyen filtro y junta
WG-554 + N° IMPAR

68€



Carburo tungsteno

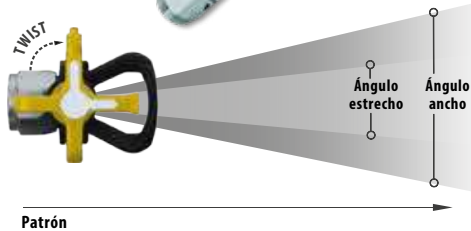

ÁNGULO DE BOQUILLA

El ángulo de la boquilla determina la anchura del chorro de pulverización

Ejemplo a 50°:

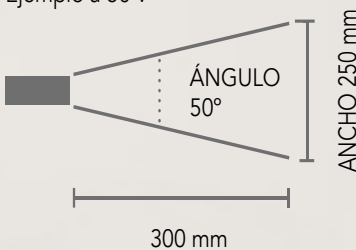

La distancia de pulverización en relación al soporte es siempre de unos 300 mm

Aplicación Producto	Marcaje Boquilla	Diámetro (pulgadas/mm)	Ángulo de pulverización en °	Anchura del chorro (mm)	Filtros	Referencia
Lacas, esmaltes, saturadores, desinfectantes, impresiones, aceites decapantes	211	0.011/0.28	20	120	rojo	WG-554211
	311	0.011/0.28	30	150	rojo	WG-554311
	411	0.011/0.28	40	190	rojo	WG-554411
	213	0,013/0.33	20	120	rojo	WG-554213
	313	0,013/0.33	30	150	rojo	WG-554313
	413	0,013/0.33	40	190	rojo	WG-554413
	415	0.015/0.38	40	190	amarillo	WG-554415
	515	0.015/0.38	50	225	amarillo	WG-554515
	615	0.015/0.38	60	270	amarillo	WG-554615
	Pinturas, paredes, techo, exteriores...	417	0.017/0.43	40	190	blanco
517		0.017/0.43	50	225	blanco	WG-554517
617		0.017/0.43	60	270	blanco	WG-554617
519		0.019/0.48	50	225	blanco	WG-554519
619		0.019/0.48	60	270	blanco	WG-554619
521		0.021/0.53	50	225	blanco	WG-554521
621		0.021/0.53	60	270	blanco	WG-554621

ACCESORIOS AIRLESS PROFESIONAL

LÍQUIDOS DE MANTENIMIENTO

TIP CLEAN DISOLVENTE

Ref.: WG-2400216

34€



EASY CLEAN LÍQUIDO LIMPIEZA

Ref.: WG-2475524

24€



TIP CLEAN DEPÓSITO BOQUILLAS

Ref.: WG-2400214

26€



EASY GLIDE ACEITE ESPECIAL

Ref.: WG-508619

13€



MODO DE EMPLEO



1. Abra la tapa y coloque hasta seis boquillas Airless Trade Tip en el recipiente



2. Cierre la tapa y gire el recipiente boca abajo. Deje que las boquillas se sumerjan en el agente limpiador



3. Sacudiendo el recipiente la suciedad y los residuos de pintura se despegan. Dejar reposar las boquillas en el agente de limpieza



4. El agente de limpieza fluye por el recipiente. Abra la tapa, retire las boquillas y retire el residuo con un cepillo. O deje actuar hasta el próximo uso

PISTOLA / MANGUERAS

PISTOLA VECTOR PRO ■ ■ ■ 4 Dedos

Ref.: WG-538040

293€



MANGUERAS AIRLESS ALTA PRESIÓN



REFERENCIA	TIPO	MPA	NPS	MEDIDA (m)	PRECIO
WG-9984583	NW327	27	1/4"	7,5	116,00 €
WG-9984573	NW4	25	1/4"	7,5	131,00 €
WG-9984574	NW6	25	1/4"	15	209,00 €
WG-2336583	NW10	25	3/8" (NPSM)	15	293,00 €

ACCESORIOS AIRLESS

PROLONGADOR DE BOQUILLAS



REFERENCIA	MEDIDA (cm)	PRECIO
WG-2418836	12	32,00 €
WG-2418839	25	39,00 €
WG-2418840	50	51,00 €
WG-2418841	75	65,00 €

RODILLO AUTOALIMENTADO PARA AIRLESS

Alimentación interior
Incluye extensión 0.9 m
Ref.: WG-2420499



289€



DISCO DE RECORTE

DISCO "SPEEDSHIELD"

Ref.: WG-538905

159€



Disco de recortes:
Pulverice directamente
sin tener que tapar/
cubrir

Cabeza orientable

Soporte disco
orientable

Con porta-boquilla
TradeTip3 7/8
incluido

Conexión entrada
producto 7/8 Rosca G



Seleccione bien su boquilla
para no ensuciar el disco





Profesionales trabajando para Profesionales

HIDROLIMPIADORAS

MPX14E

110 bar
390 l/h
1400 W
230V/50 Hz
HI-14648

89€

Accesorios:

Pistola 46160
Lanza 46163
Boquilla reg. 46167
Boquilla reg. giratoria 46164
Manguera 46174
Depósito detergente 46176



MPX19EH

140 bar
460 l/h
1900 W
230V/50 Hz
HI-14651

145€

Accesorios:

Pistola 46161
Lanza 46162
Boquilla reg. 46166
Boquilla reg. giratoria 46164
Manguera 46174
Depósito detergente 46176



MPX22EHDS

■ ■ ■ Total Stop System

160 bar
460 l/h
2200 W
230V/50 Hz
HI-14770

155€

INDUCCIÓN

Accesorios:

Pistola 46160
Lanza 46162
Boquilla reg. 46168
Boquilla reg. giratoria 46164
Manguera 46175
Depósito detergente 46176



MPX25EHDS

■ ■ ■ Total Stop System

170 bar
500 l/h
2500 W
230V/50 Hz
HI-14752

169€

2 VELOCIDADES

Accesorios:

Pistola 46160
Lanza 46162
Boquilla reg. 46168
Boquilla reg. giratoria 46164
Manguera 46175
Depósito detergente 46176



MPX25DTS

150 bar
810 l/h
2500 W
230V/50 Hz
HI-15052

 Total Stop System

289€

2 BOMBAS

SISTEMA DTS PATENTADO

Accesorios:

Pistola 46161
Lanza 46162
Portaboquilla doble 46654
Boquilla reg. 46655
Boquilla turbo 46656
Manguera 46657
Depósito espuma 46659



MPX27DTS

160 bar
850 l/h
2700 W
230V/50 Hz
HI-15053

 Total Stop System

299€

2 BOMBAS

SISTEMA DTS PATENTADO

Accesorios:

Pistola 46161
Lanza 46162
Portaboquilla doble 46654
Boquilla turbo 46656
Boquilla 5 en 1 46660
Manguera 46657
Depósito espuma 46659



MPX30EHB

180 bar
600 l/h
3.000 W
230V/50 Hz
HI-15342

 Total Stop System

499€

INDUCCIÓN

BOMBA DE LATÓN

Accesorios:

Pistola 47012
Lanza boquilla reg. 47014
Lanza giratoria 47015
Manguera 47016
Depósito espuma 47021
Filtro agua 46185



MPX160CK

160 bar
510 l/h
2900 W
230V/50 Hz
HI-14524



*Enrollador
opcional no
incluido

832€

INDUCCIÓN

BOMBA DE LATÓN

Accesorios:

Pistola 47012
Lanza boquilla reg. 41806
Manguera 3960970

ACC. ROTATIVA
Ref.: 40151
P.V.P.: 42 €



HIDROLIMPIADORAS

MPX150HDC

150 bar
630 l/h
3000 W
230V/50 Hz
1.450 r.p.m.
HI-24362

1.299€

INDUCCIÓN

BOMBA DE LATÓN



*Enrollador
opcional no
incluido

Accesorios:

Pistola 47042
Lanza 3600650
Boquilla 3600400
Boquilla 3600350
Boquilla 3600360
Boquilla 3600370
Manguera 1271960

ACC. ROTATIVA
Ref.: 41503
P.V.P.: 115 €

MPX230HDR

230 bar
900 l/h
7400 W
400V/50 Hz
HI-15353

1.599€

INDUCCIÓN

BOMBA DE LATÓN



*Enrollador
opcional no
incluido

Accesorios:

Pistola 47042
Lanza 3600650
Boquilla 3600400
Boquilla 3600350
Boquilla 3600360
Boquilla 3600380
Manguera 3961050

ACC. ROTATIVA
Ref.: 41503
P.V.P.: 115 €

MPX240TLA

Gasolina

240 bar
570 l/h
3.000 W
6 HP
HI-15350

499€

MOTOR LONCIN



Accesorios:

Pistola 46203
Lanza inox. 3600650
Boquilla 3600890
Boquilla 3600900
Boquilla 3600920
Boquilla 3600400
Manguera 4001170

ACC. ROTATIVA
Ref.: 46235
P.V.P.: 59 €

MPX240THO

Gasolina

240 bar
690 l/h
5,5 HP
HI-15351

789€

MOTOR HONDA

BOMBA DE LATÓN



Accesorios:

Pistola 47042
Lanza 3600650
Boquilla 3600400
Boquilla 3600350
Boquilla 3600360
Boquilla 3600380
Manguera 3961050

ACC. ROTATIVA
Ref.: 46149
P.V.P.: 59 €

HIDROLIMPIADORAS

SUPREME90

■ ■ Gasolina

280 bar
960 l/h
13 HP
HI-27754

2.499€

MOTOR HONDA

BOMBA DE LATÓN



Accesorios:

Pistola 47039
Lanza 3600650
Manguera 4001180

ACC. ROTATIVA
Ref.: 40964
P.V.P.: 68 €

MPX150HL

■ ■ Total Stop System

150 bar
500 l/h
2500 W
230V/50 Hz
HI-24332

1.599€

INDUCCIÓN

AGUA CALIENTE

BOMBA DE LATÓN



Accesorios:

Pistola 41047
Lanza 50690
Boquilla 3104
Manguera 3520550
Depósito espuma 40320



MPX200HD

■ ■ Agua caliente
Total Stop System

200 bar
900 l/h
7400 W
400V. /50 Hz
HI-24335

3.750€

INDUCCIÓN

BOMBA DE LATÓN

TRIFÁSICA









Accesorios:

Pistola 3523320
Lanza 3523330
Boquilla 3088
Manguera 3523340

HIDROLIMPIADORAS

ACCESORIOS INCLUIDOS

MPX14E

Pistola 46160	Lanza 46163	Boquilla reg. 46167	Manguera 46174	Depósito detergente 46176
19 €	16 €	9 €	25 €	19 €
		 Boquilla reg. giratoria 46164 9 € 		

MPX19EH

Pistola 46161	Lanza 46162	Boquilla reg. 46166	Manguera 46174	Depósito detergente 46176
19 €	15 €	9 €	25 €	19 €
		 Boquilla reg. giratoria 46164 9 € 		



MPX22EHDS

Pistola 46160	Lanza 46162	Boquilla reg. 46168	Manguera 46175	Depósito detergente 46176
19 €	15 €	12 €	26 €	19 €
		 Boquilla reg. giratoria 46164 9 € 		

MPX25EHDS

Pistola 46160	Lanza 46162	Boquilla reg. 46168	Manguera 46175	Depósito detergente 46176
19 €	15 €	12 €	26 €	19 €
		 Boquilla reg. giratoria 46164 9 € 		

MPX25DTS - MPX27DTS

Pistola 46161	Lanza 46162	Portaboquilla doble 46654	Boquilla reg. 46655	Boquilla turbo 46656	Manguera 46657	Depósito espuma 46659
19 €	15 €	18 €	19 €	12 €	29 €	16 €
						

MPX30EHB

Pistola 47012	Lanza boquilla reg. 47014	Lanza giratoria 47015	Manguera 47016	Depósito espuma 47021	Filtro agua 46185
33 €	23 €	32 €	79 €	18 €	8 €
					

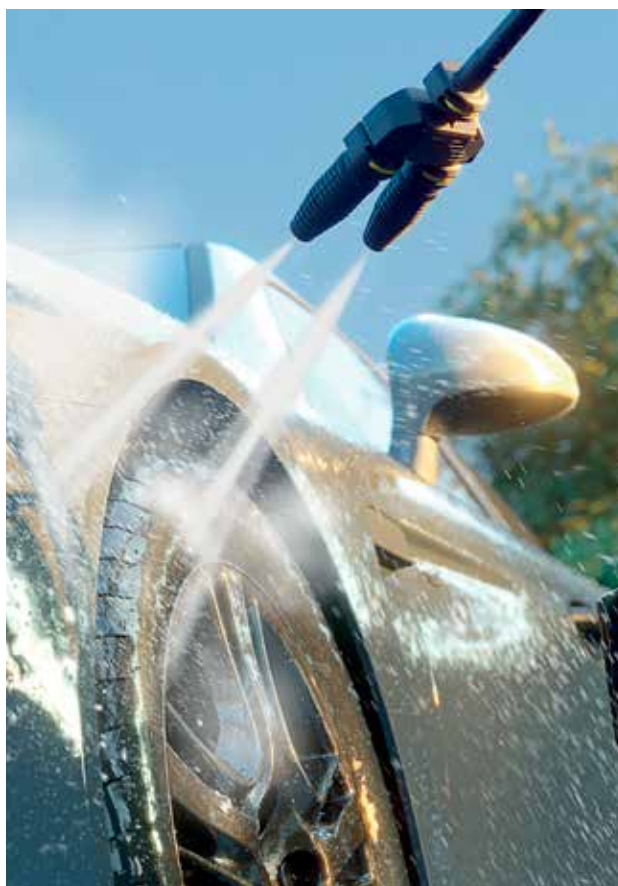

HIDROLIMPIADORAS

ACCESORIOS INCLUIDOS

MPX160CK

Pistola 47012 33 €	Lanza boquilla reg. 41806 35 €	Manguera 3960970 45 €
		

MPX150HDC - MPX230HDR

Pistola 47042 42 €	Lanza 3600650 29 €	Boquilla 3600400 10 €	Boquilla 3600360 5 €	Boquilla 3600380 5 €	Manguera 1271960 109 €
		 3600350 5 €	 3600370 5 €		

MPX240TLA - MPX240THO

Pistola 46203 36 €	Lanza inox. 3600650 29 €	Boquilla 3600890 3600900 3600920 3600400 10 €	Manguera 4001170 39 €
			

SUPREME90

Pistola 47039 59 €	Lanza 3600650 29 €	Manguera 4001180 60 €
		

MPX150HL

Pistola 41047 39 €	Lanza 50690 19 €	Boquilla 3104 18 €	Manguera 3520550 99 €	Depósito espuma 40320 9 €
				

MPX200HD

Pistola 3523320 99 €	Lanza 3523330 59 €	Boquilla 3088 18 €	Manguera 3523340 260 €
			



HIDROLIMPIADORAS

ACCESORIOS OPCIONALES

REFERENCIA		MPX 14E	MPX 16E	MPX 17EH	MPX 19EH	MPX 22EHDS	MPX 25EHDS	MPX DTS25	MPX DTS27	MPX 30EHB	PRECIO
Pistola	HI-46160	✓									19,00 €
Pistola	HI-46161		✓	✓	✓	✓	✓	✓	✓		19,00 €
Pistola	HI-47012									✓	33,00 €
Lanza	HI-46162	✓	✓	✓	✓	✓	✓	✓	✓		15,00 €
Lanza con boquilla reg.	HI-47014									✓	23,00 €
Boquilla regulable	HI-46167	✓		✓	✓						9,00 €
Boquilla regulable	HI-46166		✓								9,00 €
Boquilla regulable	HI-46168					✓					12,00 €
Boquilla regulable	HI-46169						✓				12,00 €
Boquilla regulable	HI-46655							✓	✓		19,00 €
Boquilla Turbo	HI-46164	✓	✓	✓	✓	✓	✓				9,00 €
Boquilla Turbo	HI-46656							✓	✓		12,00 €
Lanza Turbo	HI-47015									✓	32,00 €
Manguera 6mt	HI-46174	✓	✓	✓	✓						25,00 €
Manguera 8mt	HI-46175					✓	✓				26,00 €
Manguera 8mt	HI-46657							✓	✓		29,00 €
Manguera 10mt	HI-47016									✓	79,00 €
Cepillo rotativo	HI-46179	✓	✓	✓	✓	✓	✓	✓	✓	✓	33,60 €
Patio 25cm	HI-46196	✓	✓	✓	✓	✓	✓				42,00 €
Patio reg. 30cm	HI-46197	✓	✓	✓	✓	✓	✓				60,00 €
Kit succión agua	HI-41592	✓	✓	✓	✓	✓	✓	✓	✓	✓	59,00 €
Kit arena	HI-46180	✓	✓	✓	✓	✓	✓	✓	✓	✓	79,00 €
Kit 3 filtros	HI-46185	✓	✓	✓	✓	✓	✓	✓	✓	✓	8,00 €
Extensión 8mt	HI-46189	✓	✓	✓	✓	✓	✓				29,00 €
Extensión 10mt	HI-47017									✓	71,40 €
Limpia tubería 8mt	HI-46190	✓	✓	✓	✓	✓	✓	✓	✓	✓	49,00 €
Limpia tubería 16mt	HI-46191	✓	✓	✓	✓	✓	✓	✓	✓	✓	59,00 €
Adaptador Bayoneta ½	HI-40452	✓	✓	✓	✓	✓	✓	✓	✓	✓	19,00 €
Adaptador	HI-41513	✓	✓	✓	✓	✓	✓	✓	✓	✓	25,00 €
Cepillo redondo	HI-3082031	✓	✓	✓	✓	✓	✓	✓	✓	✓	13,00 €
Cepillo recto	HI-40951	✓	✓	✓	✓	✓	✓	✓	✓	✓	19,95 €

HIDROLIMPIADORAS

ACCESORIOS OPCIONALES

REFERENCIA		MPX 160CK	MPX 240TLA	MPX 240THO	SUPREME 90	MPX 150HDC	MPX 230HDR	MPX 150HL	MPX 200HD	PRECIO
Cepillo Patio reg. 30cm	HI-46223	✓	✓	✓		✓	✓	✓		74,00 €
Cepillo Patio 36cm	HI-46239	✓	✓	✓		✓	✓	✓		130,00 €
Kit Succión agua	HI-46181	✓	✓	✓		✓	✓	✓	✓	62,00 €
Kit arena	HI-46198	✓				✓		✓		179,00 €
Kit arena	HI-43750				✓					179,00 €
Kit arena	HI-46199		✓	✓			✓		✓	150,00 €
Extensión 15mt	HI-41505	✓				✓	✓	✓		115,00 €
Extensión 15mt	HI-46850				✓					169,00€
Limpia tubería 8mt	HI-46190	✓	✓	✓	✓	✓	✓			49,00 €
Limpia tubería 16mt	HI-46191	✓	✓	✓	✓	✓	✓			59,00 €
Enrollador sin manguera	HI-46039	✓								69,00 €
Enrollador sin manguera	HI-47045					✓	✓			106,00 €
Enrollador sin manguera	HI-41511								✓	148,00 €



GAMA INDUSTRIA BOMBAS NEUMÁTICAS

BOMBAS DE TRASVASE

BT-36TR

Bomba de trasvase. Ref.: BT-213601 ■ ■ 36 l/min

389€

CAUDAL (l/min)	36
RELACIÓN	1:1
PRESIÓN (bar)	1:8
PESO (kg)	4
CONEXIÓN	3/8"
MEDIDAS ENTRE TORNILLOS (cm)	15x10,5



* Disponible
BT-213601A Atex

SISTEMA DE ASPIRACIÓN OPCIONAL

BT-48TR

Bomba de trasvase. Ref.: BT-214801 ■ ■ 48 l/min

639€

CAUDAL (l/min)	48
RELACIÓN	1:1
PRESIÓN (bar)	1:8
PESO (kg)	4
CONEXIÓN	1/2"
MEDIDAS ENTRE TORNILLOS (cm)	16x12



* Disponibles:
BT-214801 Acero Atex
BT-214805 Nylon Atex
BT-214804 Inox Atex

SISTEMA DE ASPIRACIÓN OPCIONAL

BOMBAS DE DOBLE MEMBRANA

BT-36 ■ ■ 36 l/min

Bomba neumática doble membrana con carro.
Ref.: BT-213602

729€

CAUDAL (l/min)	36
RELACIÓN	1:1
PRESIÓN (bar)	1:8
PESO (kg)	13
CONEXIÓN	1/2"
MEDIDAS ENTRE TORNILLOS (cm)	16x12



Sistema de aspiración:
Ref.: BT-60012
P.V.P.: 44 €

SISTEMA DE ASPIRACIÓN OPCIONAL

BT-48 ■ ■ 48 l/min

Bomba neumática doble membrana con carro.
Ref.: BT-214802

969€

CAUDAL (l/min)	48
RELACIÓN	1:1
PRESIÓN (bar)	1:8
PESO (kg)	13
CONEXIÓN	1/2"
MEDIDAS ENTRE TORNILLOS (cm)	16x12



Sistema de aspiración:
Ref.: BT-60012
P.V.P.: 44€

SISTEMA DE ASPIRACIÓN OPCIONAL

BOMBA PARA ESMALTES

BT-33200

Conjunto bomba especial para esmaltes.

169€

DEPÓSITO (l)	2
MANGUERA (m)	3.5
PISTOLA BAJA PRESIÓN (bar)	6,8
PRESIÓN MÁX. (bar)	3,5
CONEXIÓN	1/4"



ACCESORIOS OPCIONALES



- BT-S71PRONA: Pistola baja presión
- BT-S71PRONA1.3M: 1,3 mm
- BT-S71PRONA: 1,5 mm
- BT-S71PRONA1.8M: 1,8 mm

P.V.P.: 120 €



- BT-886803: Manguera 3.5 m (1/4" - Rosca F)

P.V.P.: 39€



- BT-886875: Manguera 7.5 m (1/4" - Rosca F)

P.V.P.: 44 €

- BT-301060: Filtro de malla (Ø 60 mm)
- BT-301100: Filtro de malla (Ø 100 mm)
- BT-301150: Filtro de malla (Ø 150 mm)
- BT-301200: Filtro de malla (Ø 200 mm)

P.V.P.: 45 €

GAMA INDUSTRIA BOMBAS NEUMÁTICAS

BOMBAS MADERA Y METAL

FINEFINISH 40-15 S AIRLESS

Bomba pistón Ref.: WG-2309804
Incluye: Bomba FF40-15.5 de succión, manguera DN4 de 7,5 m, pistola AG14, boquilla 512 y llave de bola

PRESIÓN DE AIRE (bar)	2 - 7
PRESIÓN MÁX. FLUIDO (bar)	250
CAUDAL MÁX. (l/min)	0,9
RATIO PRESIÓN	40:1
TAMAÑO MÁX. BOQUILLA	0,013"

CONSULTAR PRECIOS

Versión disponible:

WG-2363202



FINEFINISH 20-30 S AIRCOAT

Bomba pistón Ref.: WG-2309802
Incluye: Bomba FF20-30 de succión, manguera AC de 7,5 m, pistola AC4600, retorno, boquilla, llave de bola y regulador AC

PRESIÓN DE AIRE (bar)	2 - 8
PRESIÓN MÁX. FLUIDO (bar)	160
CAUDAL MÁX. (l/min)	1,8
RATIO PRESIÓN	20:1
TAMAÑO MÁX. BOQUILLA	0,019"

CONSULTAR PRECIOS

Versión disponible:

WG-2309799



PUMA 28-40 AIRLESS

Bomba pistón Ref.: WG-2303397
Incluye: Bomba de succión, manguera DN4 de 7,5 m, pistola AG14, boquilla 512, filtro DN6 pintura y soporte cuatro patas

PRESIÓN DE AIRE (bar)	2 - 8
PRESIÓN MÁX. FLUIDO (bar)	224
CAUDAL MÁX. (l/min)	2,4
RATIO PRESIÓN	28:1
TAMAÑO MÁX. BOQUILLA	0,023"

CONSULTAR PRECIOS

Versión disponible:

WG-2301854



PUMA 28-40 AIRCOAT

Bomba pistón Ref.: WG-367168
Incluye: Bomba de succión, manguera AC de 7,5 m, pistola AC4600, boquilla 11/14, regulador AC y soporte cuatro patas

PRESIÓN DE AIRE (bar)	2,5 - 8
PRESIÓN MÁX. FLUIDO (bar)	224
CAUDAL MÁX. (l/min)	2,4
RATIO PRESIÓN	28:1
TAMAÑO MÁX. BOQUILLA	0,023"

CONSULTAR PRECIOS

Versiones disponibles:

WG-367167

WG-2301854



ZIP 52

Bomba doble membrana Ref.: WG-2309669
Incluye: Bomba de membrana, depósito 5l, manguera de 7,5 m, pistola presión y soporte patas

PRESIÓN DE AIRE (bar)	1 - 8
PRESIÓN MÁX. FLUIDO (bar)	8
CAUDAL MÁX. (l/min)	52
RATIO PRESIÓN	1:1

CONSULTAR PRECIOS

Versiones disponibles:

WG-2301838

WG-2301832



COBRA 40-10 AIRCOAT

Bomba membrana Ref.: WG-322112
Incluye: Bomba de membrana, depósito 5l, manguera DN3 de 7,5 m, pistola AC4600, boquilla 11/40 y regulador AC

PRESIÓN DE AIRE (bar)	2,5 - 6
PRESIÓN MÁX. FLUIDO (bar)	250
CAUDAL MÁX. (l/min)	2
RATIO PRESIÓN	40:1
VOLUMEN POR CICLO (cm³)	10
TAMAÑO MÁX. BOQUILLA	0,023"

CONSULTAR PRECIOS



GAMA INDUSTRIA SEÑALIZACIÓN VIAL

BOMBAS DE MEMBRANA

POWR LINER 3500

■ ■ Sistema alerta aceite

Señalización vial PowrLiner 3500

Membrana hidráulica: MÍNIMO DESGASTE BOMBA DE MEMBRANA
Pulverización de materiales de 1 y 2 componentes, para la señalización de garages y parkings, recubrimiento de calzadas y suelos. En definitiva todo tipo de marcado de carreteras y señalización horizontal.

CONSULTAR PRECIO

REFERENCIA	0537015
CAUDAL MÁXIMO (l/min)	2,8
BOQUILLAS MÁXIMA 1 PISTOLA	0.027"
BOQUILLA MÁXIMA 2 PISTOLA	0,025"
PRESIÓN MÁXIMA OPERATIVA (bar)	227
MOTOR (kW)	2,98

MOTOR HONDA GX120



Pistola Airless RX-80 incluida

SISTEMA HIDRÁULICO SELLADO
SIN ELECTRÓNICA
NI EMBRAGUES

MOTOR HONDA GX160

■ ■ Sistema alerta aceite

POWR LINER 5500

Señalización vial PowrLiner 5500 Membrana hidráulica: MÍNIMO DESGASTE BOMBA DE MEMBRANA
Pulverización de materiales de 1 y 2 componentes, para la señalización de garages y parkings, recubrimiento de calzadas y suelos. En definitiva todo tipo de marcado de carreteras y señalización horizontal.

CONSULTAR PRECIO

REFERENCIA	2468737
CAUDAL MÁXIMO (l/min)	4,7
BOQUILLAS MÁXIMA 1 PISTOLA	0,036"
BOQUILLA MÁXIMA 2 PISTOLA	0,025"
PRESIÓN MÁXIMA OPERATIVA (bar)	228
MOTOR (kW)	4.0



2 Pistolas Airless RX-80 incluidas

CARRO HIDRÁULICO

LAZYLINER PRO

■ ■ Asiento multiposición

Barra de parachoques de protección del motor
Neumáticos de alta resistencia (16" x 4,5")
Pedales de altura regulables

CONSULTAR PRECIO

MOTOR SUBARU

REFERENCIA	0290041
ARRANQUE	MANUAL
VELOCIDAD - HACIA DELANTE (Km/h)	0-19
VELOCIDAD - HACIA ATRÁS (Km/h)	0-11
MOTOR (cm ²)	169





PROTECCIÓN LABORAL



www.grupocevik.es

PROTECCIÓN LABORAL

G138106C

S1P SRA

Serraje
Tallas 36 a 47

26€



G138107C

S1P SRA

Serraje
Tallas 36 a 47

27€



G1388601C

S3 Metal FREE

Nobuk
Tallas 35 a 48

43€



G1388602C

S3 Metal FREE

Nobuk
Tallas 36 a 48

45€



G140-41PC

S3 SRC

Piel flor negra
Tallas 36 a 47

38€



G140-40PC

S3 SRC

Piel flor negra
Tallas 36 a 47

39€



GYSHU1506N

S1P SRA Metal FREE

Tejido Mesh
Tallas 35 a 47

55€



G138102C

S3 SRC

Nobuk. Suela Poliuretano
Tallas 37 a 47

16,50€



CONSULTAR
DISPONIBILIDAD

G138103C

S3 SRC

Nobuk. Suela Poliuretano
Tallas 37 a 47

16,80€



CONSULTAR
DISPONIBILIDAD

G139001

S1P

Metal FREE

Nobuk. Tejido Mesh
Suela EVA + RB
Plantilla/puntera: Kevlar/Composite
Tallas 37 a 47

59€



MODELO HERMES



CONSULTAR
DISPONIBILIDAD

G139002

S1P

Metal FREE

Microfibra. Tejido Mesh + EVA
Plantilla/puntera: Kevlar/Composite
Tallas 37 a 47

69€



MODELO ICARUS



CONSULTAR
DISPONIBILIDAD

G139003

S1P

Metal FREE

Tejido Mesh + TPV
Suela EVA + RB
Plantilla/puntera: Kevlar/Composite
Tallas 37 a 47

54€



MODELO ARES



CONSULTAR
DISPONIBILIDAD

G139004

S1P

Metal FREE

Nobuk. Tejido Mesh. Microfibra
Plantilla Kevlar
Tallas 37 a 47

45€



MODELO ZEUS



CONSULTAR
DISPONIBILIDAD

PROTECCIÓN LABORAL

AR-140/161

Bota de agua verde
Puntera y plantilla acero
Tallas 37 a 47

■ ■ PVC

DUNLOP
PROTECTIVE FOOTWEAR

S5 SRA

22€



AR-P101/XL

Chaleco reflectante
100% poliéster
Cierre velcro
Talla XL

2,50€

ALTA VISIBILIDAD



F-992002

■ ■ Bsica

Rodilleras de goma
espuma negra
Sujeción con banda
plástica ajustable

5,99€



F-992016

■ ■ Flexible

Rodilleras profesionales
Sujeción con bandas
elásticas y cierre velcro

11€



F-992008

■ ■ Confort

Rodilleras profesionales
con gel de silicona
en su interior
Sujeción con banda
ancha de velcro

18€



AR-5071PU

Guantes elásticos
con la palma recubierta
Puños de nylon y látex
Dorso aireado
Tallas 8, 9 y 10

■ ■ Nylon
Poliuretano

0,75€



AR-5071PB

Guantes elásticos
con la palma recubierta
Puños de nylon y látex
Dorso aireado
Tallas 6, 7, 8, 9 y 10

■ ■ Nylon
Poliuretano

0,75€



AR-5071PG

Guantes en hilo
continuo
Sin costuras
Óptima sensibilidad
Tallas 8, 9 y 10

■ ■ Nylon
Nitrilo

0,75€



AR-5071P

Guantes elásticos
Palma recubierta
Puños en nylon y látex
Dorso aireado
Tallas 8, 9 y 10

■ ■ Nylon
Poliuretano

0,79€



F-039

■ ■ Piel Flor

Guantes con dorso
y manguito en
algodón 100%
Buena sensibilidad
Espesor piel flor:
0,8-0,9 mm
Talla 10

0,78€



AR-L2N

■ ■ Piel Flor

Guantes blancos con ribete
Discreta sensibilidad
Espesor piel flor:
0,8 - 1 mm
Tallas 8, 9 y 10

2,49€



PROTECCIÓN LABORAL

F-142406

Gafa con lentes móviles
Cristal verde inactivo
Ø 50 mm

 Especial soldadura

5€



AR-580-I

Gafa monolente incolora en policarbonato
Compatible con gafas de prescripción
Ideal para visitantes
Tratamiento anti-vaho y anti-arañazos

1,99€



AR-539-C

Gafa integral panorámica incolora, fabricada por inyección de PVC flexible. Protección contra riesgo de impacto de partículas de alta velocidad y baja energía, gotas o salpicaduras de líquidos, partículas de polvo finas o gruesas y gas Tratamiento anti-vaho y anti-rayaduras. Gran campo visual

3,31€

COMPATIBLE CON GAFAS DE PRESCRIPCIÓN.



AR-569-I

Gafa en policarbonato incoloro con el frente de una sola pieza y tira frontal de poliamida azul. Patillas extensibles (tipo espátula). Protección lateral Resistente al impacto de pequeños proyectiles

2,49€



AR-599-G

Gafa de policarbonato panorámica gris

5,69€



F-1422988

Gafa en policarbonato incoloro
Patillas regulables. Tratamiento anti-vaho y anti-arañazos

3,95€



F-142/2503

Gafa máscara policarbonato incoloro
Especial sustancias químicas

5,99€



AR-2353710300UD ■■■ FFP1

Mascarilla con válvula
Pedido mínimo 12 uds.

1,08€
UNIDAD



AR-23537203500 ■■■ FFP2

Mascarilla con válvula
Pedido mínimo 12 uds.

1,25€
UNIDAD



AR-125FUD ■■■ FFP3

Mascarilla con válvula
Alta toxicidad
Pedido mínimo 12 uds.

2,25€
UNIDAD



AR-2353720100UD ■■■ FFP2

Mascarilla sin válvula
Pedido mínimo caja 20 uds.

0,90€
UNIDAD



F-C/19

Pantalla protectora de acetato transparente de 30 micras
Con banda de polietileno regulable

4€



F-142/2111

Visera tipo red con malla protectora, especial para desbrozar

11,99€



F-142/210

Visera policarbonato transparente con elástico. Eficaz protección contra impactos de alta velocidad (baja - media energía) y salpicaduras

2,99€



F-142/2100

Visera policarbonato transparente con arnes regulable. Eficaz protección contra impactos de alta velocidad (baja - media energía) y salpicaduras

5,49€



PROTECCIÓN LABORAL

AR-2351755801

Mascarilla con 2 filtros de gas: A1B1E1K1 incluidos

23€

SERIE 755



Filtro disponible:
AR-240175580091 (ABEK1)
P.V.P.: 11,34 €



AR-2351745100

Mascarilla con 1 filtro de gas A1 incluido

10,95€

SERIE 745



Filtros disponibles:
AR-2401760100 (A1) P.V.P.: 8,90 €
AR-24017607200 (ABEK1) P.V.P.: 7,89 €



AR-732N

Máscara facial completa de silicona de 2 filtros: A1-P3 (No incluidos)

66,15€

SERIE 732N



Filtros disponibles:
AR-757N-ABEK1 P.V.P.: 5,72 €
AR-757N-A1P3 P.V.P.: 8,40 €



AR-142/40F

Mascarilla de caucho termoplástico
Con 2 filtros de gas A1 incluidos

11,99€

SERIE 755



Filtro disponible:
AR-2401755100 (A1) P.V.P.: 8,93 €



AR-142/37F

Mascarilla de caucho termoplástico
Con 2 filtros de gas A2P3 incluidos
Especial fitosanitario, disolventes y pinturas a pistola

23€

SERIE 755



Filtro disponible:
AR-240175510491 (ABEK1) P.V.P.: 17 €



AR-PCX710

Mascarilla termoplástico con filtros AIP3 integrados
Especial gases y vapores (orgánicos)
Vida útil 6 meses

21,95€

SERIE 700



AR-PCX730

Mascarilla termoplástico con filtros A1B1E1K1P3 integrados
Especial gases, vapores, amoníaco y derivados, polvo
Vida útil 6 meses

29,95€

SERIE 700



AR-5RG

Casco de protección de polietileno alta densidad con regulador. Incorpora banda anti-sudor. Varios colores

4,25€

- AR-5RBL
- AR-5RGAM
- AR-5RGAZ



AR-5R

Casco de obra en polietileno ajustable Varios colores

2,29€

- AR-5RBL
- AR-5RAZ
- AR-5RAM
- AR-5RRO



F-142/110-15

Gorra de protección tipo "beisbol", antigolpes. Diseño en tela (100% algodón) con protección interior en ABS acolchado. Orificios de ventilación

8,59€



AR-CHSR

Barboquejo con mentonera. Válido para cascos de protección AR-5RG y AR-5R

1,35€



AR-250100550

■ 5 uds.

Barboquejo sin mentonera

4,85€



PROTECCIÓN LABORAL

CX-2651259100

Línea de vida horizontal HORIZONT
Cinta de poliéster naranja de 35 mm
Longitud 20 m. Elemento de trincaje
tipo carraca con doble bloqueo de
seguridad

51€



CX-2702111120

Línea de vida vertical
SEMI 11
Longitud 20 m

54€

CX-2702111150

Línea de vida vertical SEMI 11
Longitud 50 m

155€



CX-2702003800

Absorbedor de energía 31-A
Longitud 1,6 m
Con dos mosquetones
Mod.30

22€

1,6 m



CX-2702003200

Absorbedor de energía 31-A
Longitud 1,6 m
Con dos mosquetones
Mod.30 y Mod. 31

36€

1,6 m



CX-2702101100

Elemento de amarre U.29/1 SEMI
Cuerda de poliamida
de Ø11 mm y gaza
a cada extremo

10,50€



CX-2702005110

Línea de anclaje flexible.
Para uso vertical.
Poliamida de 3 cabos.115 g/m
Acabados: Lazada y nudo
terminal o guardacabos en los
extremos Ø 14 mm
Longitud a demanda

29€



CX-2702003100

Dispositivo anti-caídas
deslizante ADA 14
Con cierre de seguridad
Longitud:
Cuerda de 10 a 100 m
en tramos de 10 m

45€



CX-2702100601

Absorbedor de energía 35 SEMI. Con banda de absorción y
elemento de amarre en Y de poliamida de 11 mm. 3 conectores:
1 del mod. 32 y 2 del mod. 31. Válido para arnés 21CATEX

67€

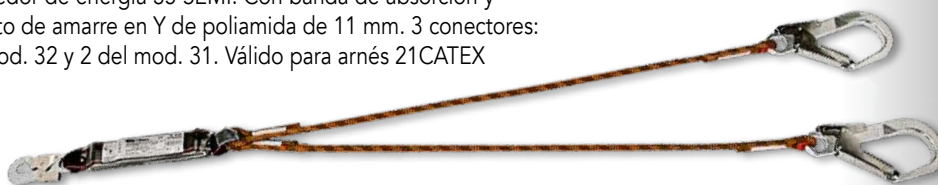



CX-2651010200

Arnés anticaídas
Cintas de poliéster
de 45 mm
Reguladores de
longitud en piernas,
punto de enganche
y anticaídas dorsal
Incluye: Arnés +
cuerda de 1,5 m
+ 2 mosquetones

24,50€



CX-2651010100

Arnés anti-caídas. 10 BASIC. Cintas de poliéster de
45 mm. Hebillas de regulación de piernas. Punto de
enganche. Anti-caídas dorsal

14,50€



CX-2651043100

Arnés anti-caídas ATLAS
Cintas de poliéster de 45 mm
Cinturón y perneras acolchada
3 aros porta-materiales
Hebillas de regulación

125€

140 KG



CX-2651252100

Arnés anti-caídas MAXIPRO
Punto de anclaje en dorsal en hebilla "D" de acero
de 8 mm. Punto de enganche frontal compuesto
por dos gazas. Banda dorsal acolchada

32€



CX-2651025200

Cinturón de sujeción 25-CN
Banda dorsal acolchada con
hebillas. Con cuerda
reguladora y mosquetón

29€



PROTECCIÓN LABORAL

CX-2707001400

Dispositivo anti-caidas ROC
Aluminio anodizado
Para cuerdas de 10,5 a 12,7 mm
homologadas

56€



CX-2703001100

Mosquetón 30
Conector de acero
Cierre automático
y bloqueo manual
Ø apertura 16 mm

3,50€



CX-2703001200

Mosquetón 31
Conector de acero
Con mecanismo de
cierre y bloqueo
de seguridad
automáticos
Ø apertura 54 mm

11€



CX-2703001700

Mosquetón KH-ALU
Aluminio. Conector en
forma de "D"
Bloqueo automático
Desbloqueo en tres
tiempos
Ø apertura 20 mm

11€



CX-270500810000

Bloqueador de cuerda
frontal. Aluminio
Ø apertura 12 mm

32€



CX-2705003200

Dispositivo de descenso
PCXPLORER
Sistema de seguridad
antipánico y función de
bloqueo gradual

222€



CX-2705001100

Puño de ascenso
derecho SARYU
Aluminio
Ø de trabajo
de 8 a 13 mm

36€



CX-2706001200

Asiento de suspensión prolongada con madera
Acolchamiento en glúteos
3 argollas porta-materiales
Longitud de cinta regulable
Medida: 67x24 cm

109€



CX-2706100130

Petate SPORT regulable para transporte de materiales y/o almacenamiento
30 l

65€



CX-2705004100

Pedal de YUMA para ascenso
Fabricado en cinta
Regulable
Con un maillón

36€



CX-2707002200

Dispositivo anti-caidas retráctil con 2 conectores Climax 30
Carcasa en ABS
Absorbedor de energía
Elemento de amarre a partir de cinta de poliamida de 49 mm
Longitud 2,5 m

59€



CX-2707003110

Dispositivo anti-caidas retráctil con conector Climax 30
Carcasa en ABS
Absorbedor de energía
Cable de acero de Ø 4,8 mm
Conector Climax KH-GIRO Ø 19 mm
Longitud 10 m

279€



PROTECCIÓN LABORAL

AR-225100910000

Auricular anti-ruido profesional SNR-25dB (*)
Diadema resistente.
Acolchados en goma y tejido suave Regulación de altura de las copas

5,99€

*SNR= Signal to noise ratio: Índice único de reducción de ruido



F-142/25

Auricular anti-ruido SNR-27 dB (*)
Con almohadilla para mayor comodidad y mejor adaptación

5,50€

*SNR= Signal to noise ratio: Índice único de reducción de ruido



F-142/50509C

Pack de 10 pares de tapones anti-ruido SNR 37dB (*)

3€



*SNR= Signal to noise ratio: Índice único de reducción de ruido

AR-18-P

Auricular anti-ruido SNR-31dB (*)
Con almohadilla para mayor comodidad y mejor adaptación

14,99€

*SNR= Signal to noise ratio: Índice único de reducción de ruido



F-991015

Cinturon de nylon para bolsas porta-herramientas
Cierre clip de seguridad
Resistente

2,90€



F-991022

Faja elástica de nylon con tirantes. Adaptable con velcro

10€



F-991121

Chaleco multibolsillos de nylon reforzado

9,99€



F-991053

Bolsa porta-herramientas con cinturón

8€



F-991045

Bolsillo porta-taladro de batería sin cinturón

7€



F-991056

Bolsa porta-herramientas sin cinturón
Extremos reforzados

9,99€

10 BOLSILLOS



F-66159

Destornillador de precisión 8 puntas

3€



F-770014

Destornillador bola multipuntas "12 en 1"

1,50€



F-770022

Palanca acero 600 mm

6,60€



F-770015

Destornillador impacto 7 piezas

5,50€



F-770013

Llave carraca 1/2"

4€



F-770018

Tenaza curva tubos 14 mm

7€



F-770017

Tijeras para tubos de plástico hasta Ø 42 mm

4,99€



PROTECCIÓN LABORAL

F-770045

Maletín fontanería 45 piezas: reparador tuberías y fregaderos, tenaza corta tubos, cortador de tubos, abocinador, kit reparador grifos, teflón, tenaza sifón

35€

MALETA PVC



F-770012

Maletín fontanería profesional 12 piezas: terrajas, tenaza corredera, tenaza sueca, asa, alargamiento de asa y teflón

50€

MALETA PVC



CE-E010WTH

Generador de ozono O3
Temporizador con
16 programas
85 W
52 dB

299€

COBERTURA MÁX. DESINFECCIÓN:
200M2 EN 1H.

SUMINISTRO INMEDIATO DESDE
EL ENCENDIDO

EUO₃TA.org
European Ozone Trade Association



Consulta periódicamente las NOVEDADES en nuestra web

www.grupocevik.es

energeeks



¡Bienvenidos al hogar inteligente!
Welcome to the Smarthome!

www.energeeks.com

casa conectada

Crea tu **ecosistema Energeeks** a medida, automatiza toda tu casa con nuestros dispositivos WIFI y haz que funcionen en conjunto desde nuestra app gratuita **Energeeks 3.0**

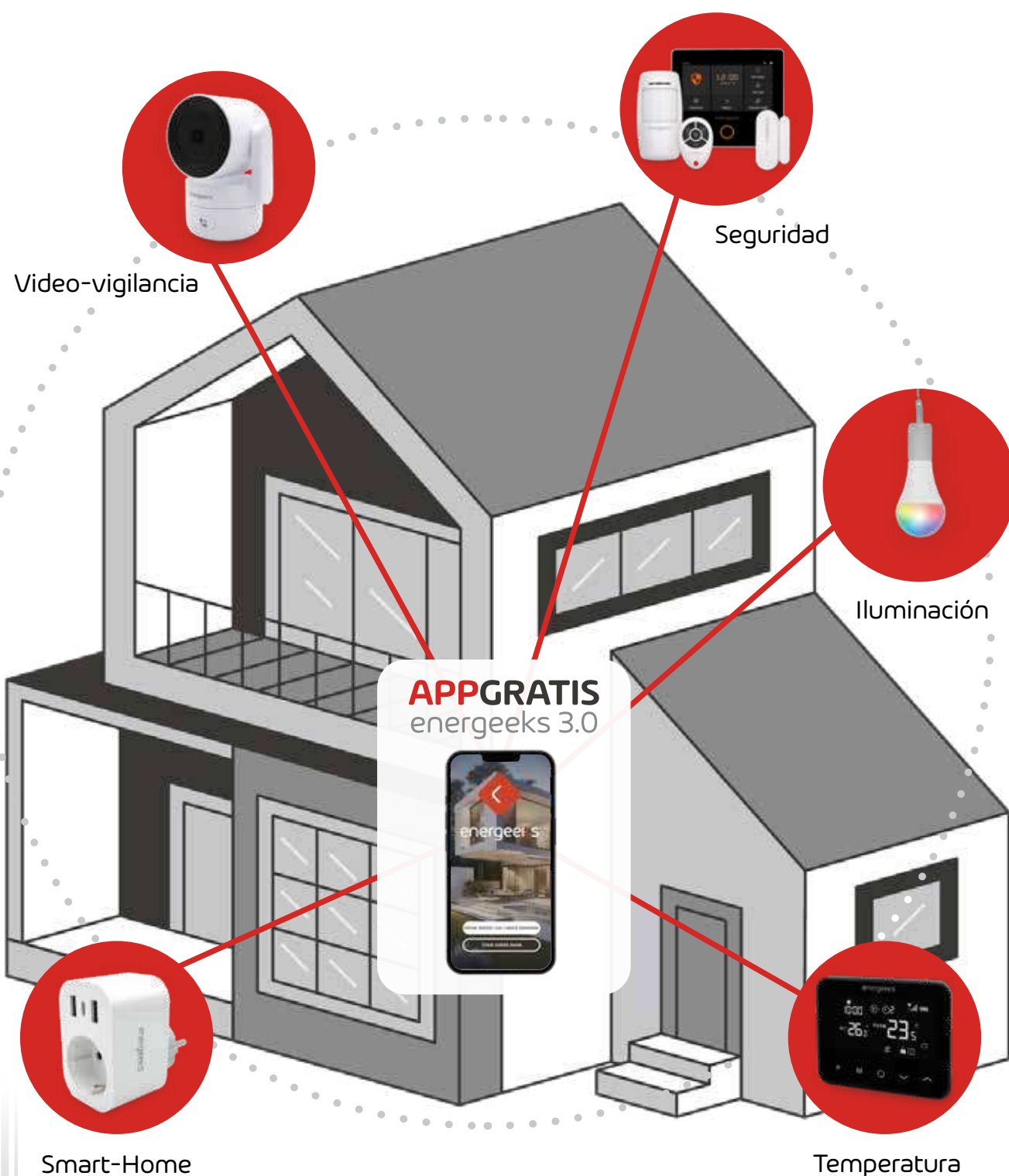

video-vigilancia

APP GRATIS
energeeks 3.0



CÁMARAS DE INTERIOR



WIFI



Instalación
bluetooth



Notificaciones



Función
habla/escucha



Detector con
filtro humano



Visión
nocturna



Auto-tracking
↔ 360°



Micro SD
/ Nube /
Grabador NVR



ONVIF®

1080P / FULL HD

Ref. EG-CIP005

Cámara WIFI
motorizada SCOUT

21,48€



Modo
privacidad
real



DUAL BAND WIFI

2,4 5 GHz

ONVIF®

3MP / SUPER HD

Ref. EG-CIP004

Cámara WIFI motorizada
SENTINEL III

24,79€



Kids



VIGILA BEBÉS



Sensor de
temperatura
y humedad



Sensor de
llanto de
bebé



NANAS
incluidas

3MP / SUPER HD

Ref. EG-CIPBB001

Cámara WIFI motorizada
SENTINEL KIDS

28,92€



WORKS WITH
amazon alexa

works with the
Google Assistant



DUAL BAND WIFI

2,4 5 GHz



Modo
privacidad
real



Botón
de llamada



Auto-tracking
↔ 360°
±120°

ONVIF®

4MP / ULTRA HD

Ref. EG-CIP006

Cámara WIFI motorizada
SENTINEL PRO

28,92€



¡NOVEDAD!

Disponible a partir del
1 DE ABRIL



DUAL BAND WIFI

2,4 5 GHz

360°



DOBLE LENTE

ONVIF®

4MP + 4MP / ULTRA HD

Ref. EG-CIP008

Doble cámara WIFI
motorizada SENTINEL DUO

33,05€

CÁMARAS DE EXTERIOR



WIFI



Instalación
bluetooth



Notificaciones



Exterior
IP65



Detector con
filtro humano



Visión
nocturna



Luz LED



Sirena
incorporada



Micro SD
/ Nube /
Grabador NVR



ONVIF®

4MP / ULTRA HD

Ref. EG-CIPEXT008

Cámara WIFI fija
GUARDIAN III

28,92€



Hasta fin de existencias

ONVIF®

4MP / ULTRA HD

Ref. EG-CIPEXT005

Cámara WIFI motorizada
DEFENDER III

33,05€



¡NOVEDAD!

Disponible a partir del
1 DE ABRIL

Sustituye al mod. DEFENDER III

ONVIF®

4MP / ULTRA HD

Ref. EG-CIPEXT009

Cámara WIFI motorizada
DEFENDER IV

33,05€



WORKS WITH
amazon alexa

works with the
Google Assistant



ONVIF®

4MP / ULTRA HD

Ref. EG-CIPEXT007

Cámara WIFI motorizada
DEFENDER PRO

41,31€



¡NOVEDAD!

Disponible a partir del
1 DE ABRIL

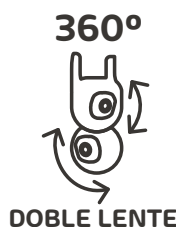

ONVIF®

4MP + 4MP / ULTRA HD

Ref. EG-CIPEXT010

Doble cámara WIFI
motorizada DEFENDER DUO

49,58€

CÁMARAS CON BATERÍA



WIFI



Instalación bluetooth



Notificaciones



Exterior IP65



Sin cables



Visión nocturna



Luz LED



Sirena incorporada



Micro SD / Nube



BATERÍA RECARGABLE 5200 mAh



DUAL BAND WIFI

2,4 5 GHz



Uso interior / exterior

4MP / ULTRA HD

Ref. EG-CIPBAT003

Cámara WIFI fija RANGER III

41,31€

EG-CIPBATSOLAR2

Panel solar de 5W compatible

10,74€



PANEL SOLAR

¡NOVEDAD!

Disponible a partir del 1 DE ABRIL

4MP / ULTRA HD

Ref. EG-CIPBATEXT002

Cámara WIFI fija con panel solar ATLAS NANO

53,71€



BATERÍA RECARGABLE 7800 mAh



DUAL BAND WIFI

2,4 5 GHz



Panel solar 1,8W integrado



BATERÍA RECARGABLE 9000 mAh



DUAL BAND WIFI

2,4 5 GHz



Panel solar 5W incluido

4MP / ULTRA HD

Ref. EG-CIPBATEXT001

Cámara WIFI motorizada con panel solar ATLAS

66,11€



Sin WIFI



Conexión 4G (SIM no necesaria)



Incluidos datos ilimitados



Notificaciones



Panel solar 5W incluido



Exterior IP65



Sin cables



Luz LED



Micro SD



Incluida conexión a internet

4G GRATIS

¡NOVEDAD!



BATERÍA RECARGABLE 8000 mAh

4MP / ULTRA HD

Ref. EG-CIPEXT4G002

Cámara 4G motorizada con panel solar PATROL II

115,69€

GRABADORES NVR



Notificaciones



Vídeo en directo

ONVIF®

Compatible con Onvif



16 canales



Grabador 1Tb (ampliable hasta 8Tb)



HDMI + VGA



Conector RJ45



Datos extraíbles



Ref. EG-NVRINT001

Pack grabador NVR 16 canales
+ disco duro 1TB
+ 2 cámaras interiores SENTINEL III

173,55€

PACK PARA INTERIOR



Ref. EG-NVR001

Grabador NVR de 16 canales
+ disco duro 1TB

148,75€

¡NOVEDAD!



Ref. EG-NVREXT002

Pack grabador NVR 16 canales
+ disco duro 1TB
+ 2 cámaras exteriores GUARDIAN III

206,60€

¡NOVEDAD!



Ref. EG-NVREXT003

Pack grabador NVR 16 canales
+ disco duro 1TB
+ 4 cámaras exteriores GUARDIAN III

247,93€

PACK PARA EXTERIOR

ONVIF®

El protocolo ONVIF es un estándar para los sistemas de videovigilancia que permite la inter-operabilidad entre los equipos de diferentes fabricantes.

La idea principal de este protocolo es asegurar que cualquier dispositivo que sea compatible con ONVIF pueda comunicarse con cualquier otro dispositivo que también sea compatible con ONVIF.



APPGRATIS
energeeks 3.0



SISTEMAS DE ALARMA



WIFI
2,4 Ghz



Sin
cuotas



Notificaciones



Control
a distancia



Batería
de respaldo



Instalación
sin cables



Programable



Multi
dispositivo



Ecosistema
energeeks



Conexión GSM
(SIM 2G + 4G)



Ref. EG-AWG003

**Sistema de alarma WIFI + GSM
PROTECT PLUS**

107,43€

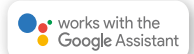

Ref. EG-AW003

**Sistema de alarma WIFI
PROTECT**

49,58€

SENSORES ADICIONALES GAMA PROTECT

Ref. EG-SA003

**Sensor de
apertura**



6,60€

Ref. EG-SM003

**Sensor de
movimiento**



9,08€

Ref. EG-MD003

**Mando a
distancia**



5,78€

Ref. EG-S003

**Sirena interior
estroboscópica**



Sirena
120dB

20,65€

APP GRATIS
energeeks 3.0



Escenarios inteligentes



Crea horarios,
calendarios y rutinas



Ahorra energía y dinero



Control a distancia

WORKS WITH
amazon alexa

works with the
Google Assistant

ENCHUFES WIFI INTELIGENTES

EG-EW009MC



PACK TRIPLE

32,22€



Control por separado



WIFI
2,4 Ghz



EG-EW006MC

Enchufe WIFI
inteligente doble

16,52€



Medidor
de consumo



WIFI
2,4 Ghz



Medidor
de consumo

EG-EW008MC

Enchufe
WIFI inteligente

11,56€



Control por separado



WIFI
2,4 Ghz



Medidor
de consumo

EG-BW003MC
Base multiple
WIFI inteligente

33,05€



WIFI
2,4 Ghz



Control por separado



Medidor
de consumo

EG-EW007MC
Enchufe WIFI
inteligente con 2x USB A + USB C

14,87€

CONTROL REMOTO Y SENSORES

CONTROL REMOTO



WIFI
2,4 Ghz



Instalación
bluetooth



Notificaciones



Control
por voz



Multi
dispositivo



Programable



Escenarios
inteligentes

WORKS WITH
amazon alexa

works with the
Google Assistant



Pantalla
LCD



Sensor de
temperatura y humedad

EG-IR003

Control remoto WIFI universal
IR / radio frecuencia para aire acondicionado

22,31€



EG-MODILU002

Módulo WIFI
de iluminación

12,39€



EG-MODPERS002

Módulo WIFI
de persianas

14,04€

SENSORES WIFI CONFORT Y AHORRO



WIFI
2,4 Ghz



Pilas incluidas
2x AAA

EG-SAW001

Sensor WIFI de
apertura

10,74€



WIFI
2,4 Ghz



Pilas incluidas
2x AAA

EG-SMW001

Sensor WIFI de
movimiento

13,21€



WIFI
2,4 Ghz



Pilas incluidas
3x AAA

EG-STHW002

Sensor WIFI de
temperatura y humedad

14,87€

DETECTORES DE INCENDIOS Y EMERGENCIAS

DETECTORES WIFI SEGURIDAD CONECTADA

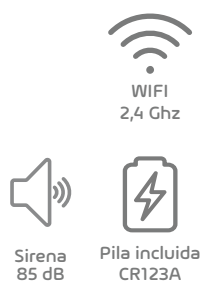

EG-SHW001
Detector WIFI
de humo

20,65€



EG-SCOW001
Detector WIFI
de monóxido de carbono

22,31€

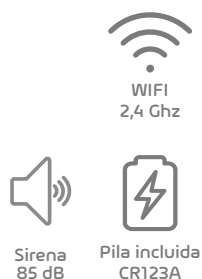

EG-SIW001
Detector WIFI
de inundación

13,21€

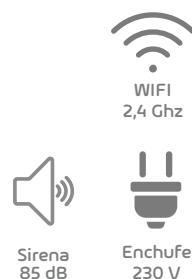

EG-SGW001
Detector WIFI
de gas

22,31€

DETECTORES NO WIFI SEGURIDAD LOCAL



EG-SH001
Detector de
humo

8,26€



EG-SCO001
Detector de
monóxido de carbono

12,39€

ILUMINACIÓN INTELIGENTE

BOMBILLAS LED WIFI



WIFI
2,4 Ghz



Instalación
bluetooth



Ahorra
energía



Programable



Escenarios
inteligentes

WORKS WITH
amazon alexa

works with the
Google Assistant



EG-BWA608W001
A60 8W E27
7,43€

PACK DOBLE

EG-BWA608WP001



13,21€



EG-BWA6014W001
A65 14W E27
10,74,€



EG-BWG9511W001
G95 E27 11W
9,91€



EG-BWG455W001
E27 5W
7,43€



EG-BWP455W001
E14 5W
7,43€



EG-BWGU105W001
GU10 5W
7,43€

PACK DOBLE

EG-BWGU105WP001



13,21€

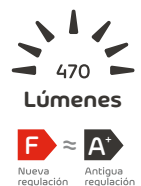

EG-BWC375W001
E14 5W
7,43€

SEGURIDAD LOCAL MINI - ALARMAS



Ref. EG-AL007

Sistema de alarma local +
timbre

33,05€



Ref. EG-ALT001

Alarma timbre con
detector de movimiento

12,39€



Ref. EG-ALT002

Alarma timbre con
detector de movimiento

6,60€

iNOVEDAD!



Ref. EG-ALT003

Alarma con detector de
movimiento y mando

9,91€

WIFI

iNOVEDAD!



Ref. EG-ALT003W

Alarma WIFI con detector
de movimiento y mando

18,17€

iNOVEDAD!



Ref. EG-AL009

Alarma de apertura
con mando a distancia

10,74€

iNOVEDAD!



Ref. EG-AL008

Alarma
de apertura

6,60€



Ref. EG-ALV001

Alarma
personal

3,30€



Ref. EG-ALV003

Alarma
tope de puertas

2,47€



Ref. EG-AL006

Pack 4 alarmas
de apertura

4,12€

XANLITE



PROYECTORES CONSTRUCCIÓN



5000 k
BLANCO
FRÍO



EG-PRAR20WRV23

2300 Lúmenes (20 W)
Autonomía 10 h. Resistencia al choque
IP54. Duración: 25000 h

33,05€



5000 k
BLANCO
FRÍO



PRAR30W3TRV23

3400 Lúmenes (30 W)
Autonomía 10 h. Resistencia al choque
IP54. Duración: 25000 h

41,31€



6000 k
BLANCO
FRÍO



5000 k
BLANCO
FRÍO



¡NOVEDAD!

EG-PR20WR

2300 Lúmenes (18 W). Autonomía 6 h
Resistencia al choque. IP54
Ángulo 110°. Duración: 25000 h

49,58€

**NUEVO MODELO DISPONIBLE
A PARTIR DEL 1 DE ABRIL**

EG-PR50WR

Proyector LED compacto y
portátil. IP54. 6000K.

53,71€

**DISPONIBLE A PARTIR
DEL 1 DE ABRIL**



5000 k
BLANCO
FRÍO



¡NOVEDAD!

**DISPONIBLE A PARTIR
DEL 1 DE ABRIL**

EG-PR4000R

Proyector LED compacto y portátil, 3 modos
de fijación. IP44. 6500K.

28,92€



5000 k
BLANCO
FRÍO



¡NOVEDAD!

**DISPONIBLE A PARTIR
DEL 1 DE ABRIL**

EG-PR10WRPI

Proyector LED con pinza, 1000 lúmenes,
intensidad regulable. IP54. 5000 K.

41,31€



PROYECTORES CONSTRUCCIÓN



6500 k
BLANCO
FRÍO



NUEVOS MODELOS DISPONIBLES
A PARTIR DEL 1 DE ABRIL

EG-PR10WF

800 Lúmenes (10 W) 2600 Lúmenes (30 W) 4200 Lúmenes (50 W)
IP44. Ángulo 110°. Longitud cable 1,5 m Duración: 25000 h

24,79€

EG-PR30WF

800 Lúmenes (10 W) 2600 Lúmenes (30 W) 4200 Lúmenes (50 W)
IP44. Ángulo 110°. Longitud cable 1,5 m Duración: 25000 h

33,05€

EG-PR50WF

800 Lúmenes (10 W) 2600 Lúmenes (30 W) 4200 Lúmenes (50 W)
IP44. Ángulo 110°. Longitud cable 1,5 m Duración: 25000 h

45,45€



6500 k
BLANCO
FRÍO



¡NOVEDAD!

DISPONIBLE A PARTIR
DEL 1 DE ABRIL

EG-PR100WF

Proyector LED con cable, compacto y portátil, iluminación potente, 2 tomas incluidas (230 V y USB-C), IP44.

61,98€



6500 k
BLANCO
FRÍO

EG-PR20W2T

1600 Lúmenes (20 W)
Resistencia al choque
IP44. Ángulo 110°. Longitud cable 2 m.
Duración: 25000 h

61,98€



NUEVO MODELO DISPONIBLE
A PARTIR DEL 1 DE ABRIL



¡NOVEDAD!

DISPONIBLE A PARTIR
DEL 1 DE ABRIL



6500 k
BLANCO
FRÍO

EG-TR1602T

Trípode compacto y portátil con altura regulable. 2 cabezales modulares.

20,65€



¡NOVEDAD!

DISPONIBLE A PARTIR
DEL 1 DE ABRIL



6500 k
BLANCO
FRÍO

EG-PRTU20WR

Proyector tubular LED portátil. 6500 K.

41,31€



6500 k
BLANCO
FRÍO

EG-PRTL2500R

Proyector LED portátil con trípode telescópico. CCT. Power Bank.

66,11€



¡NOVEDAD!

DISPONIBLE A PARTIR
DEL 1 DE ABRIL

LINTERNAS



EG-T0250S

300 Lúmenes
Baterías incluidas
Autonomía 10 h

9,08€



EG-T0600M

600 Lúmenes
Baterías incluidas
Autonomía 8 h

13,21€



4000 k
BLANCO
NEUTRO



EG-MTR200G

Mini linterna LED de aluminio.
200 lúmenes. Autonomía 6 h. 3
modos de iluminación. Color gris.

8,26€

¡NOVEDAD!

DISPONIBLE A PARTIR
DEL 1 DE ABRIL



Disponible color champán
Ref.: EG-MTR200C P.V.P.: 8,26 €



EG-BL250R

200 Lúmenes
IP20. Autonomía 3 h
Fijación por gancho / magnético

19€



EG-BL450RL

450 Lúmenes
IP20. Autonomía 2 h
Fijación por gancho / magnético

29,74€



EG-T02500RIP

2500 Lúmenes
IP44. Resistencia al choque.
Autonomía 6 h

41,31€



EG-T01000RIP

1000 Lúmenes
Resistencia al choque
Autonomía 15 h. Recargable USB
o batería. Indicador de carga

33,05€

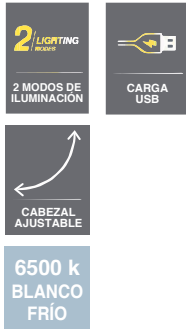

EG-BL700R

450/200 Lúmenes (según modo). IP20. Apoyo trípode. Autonomía 28 h. Resistencia al choque Indicador de carga

21,48€



EG-PR2000RIP

900+900 Lúmenes. Autonomía 50 h. Indicador de carga. Apoyo trípode. Resistencia al choque

57,84€



EG-FR350S

350 Lúmenes IP44. Autonomía 3h

24,79€



¡NOVEDAD!

DISPONIBLE A PARTIR DEL 1 DE ABRIL



EG-BL1500R

Lámpara LED portátil sin cable. IP44. 2 modos de fijación: gancho / magnético

28,92€



¡NOVEDAD!

DISPONIBLE A PARTIR DEL 1 DE ABRIL

PACK3VTOL700R

Pack 3 en 1, batería multiproducto: ventilador, linterna y linterna tipo farol LED. IP44. Intensidad regulable

41,31€

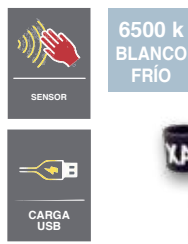

EG-FR450STRIP

300 Lúmenes. IP20. Resistencia al choque. Autonomía 15h

9,08€

¡NOVEDAD!



FR350SSTRIPB

Linterna frontal con sensor Bluetooth LED COB + XPE LED
Batería: polímero de 3,7 V-1200mAh

16,52€

DISPONIBLE A PARTIR DEL 1 DE ABRIL



ROLLOS LED "STRIP REELS"

EG-LSE10EXF

Enrollador LED de obra
Carrete: Ø295 mm
5.600 Lúmenes

49,58€



¡NOVEDAD!

DISPONIBLE A PARTIR
DEL 1 DE ABRIL

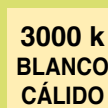

EG-LSE25CWEXF

230 V - 150 W
Vida útil de 25.000 horas
Carrete: Ø295 mm
15.400 Lúmenes
Kit de fijación incluido (50 pzas)

98,35€



EG-LSE50CWEXF

230 V - 300 W
Vida útil de 25.000 horas
Carrete: Ø300 mm
30800 Lúmenes
Kit de fijación incluido (100 pzas)

164,46€



...No te pierdas el resto de nuestros productos

Echa un vistazo a nuestros catálogos, leyendo con tu móvil estos códigos QR



**Catálogo
Gaming y Kids**



**Catálogo
Iluminación armarios**



**Catálogo
Tiras LED**



**Catálogo
Colección exterior**





Consulta todos nuestros catálogos en:

www.grupocevik.es

IVA NO INCLUIDO

La empresa no se hace responsable de posibles erratas tipográficas o de impresión en las especificaciones técnicas o en los precios mostrados en este folleto.



Fecha de validez hasta 31 de Agosto de 2026
o hasta fin de existencias.