



BOCK Condensing Units

60 Hz

With fans of the latest generation:
The next level of energy efficiency

colour the world
of tomorrow

Challenges welcome!

BOCK Condensing Units

Global warming is increasing more and more, hot countries are getting even hotter and even in Central Europe summer temperatures of 40° C are not infrequently reached. And this is exactly where the advantages of Bock condensing units become apparent. Exactly there, where others have to help themselves with adiabatic cooling, additional water spraying of the heat exchangers, we feel especially comfortable.

The Bock condenser-fan unit is designed for cold, but especially for very hot and in all respects demanding regions. One for all, that has been our way of thinking and working for decades when designing and manufacturing our air-cooled units. We want to live up to this claim also with the latest generation of our condensing units. Our goal is to exceed the efficiency standards in force in Europe and at the same time not to compromise on condensing performance.

We have achieved this goal:

- the heat exchangers were adapted to the new challenges
- no compromises were made in terms of robustness and durability
- cooling of the heat exchangers by the most efficient AC fans available on the market
- the use of these efficient AC fans allows us to maintain an unbeatable price/performance ratio
- of course, the two-, four- and six-cylinder semi-hermetic Bock compressors are responsible for reliable refrigeration

And so you as a customer continue to get **One Solution for All** your needs, regardless of whether your challenge is deep-freezing in the Sahara or normal cooling in the Arctic Circle.

Efficient condensers: +

- Condenser in reliable fin-tube design
- One condenser for low and high ambient temperatures

Optimized drive gear: +

more resistant to lack of lubrication

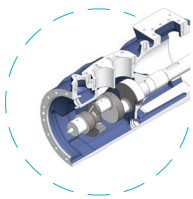

Reliable and safe oil supply: +

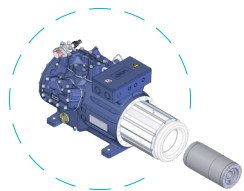
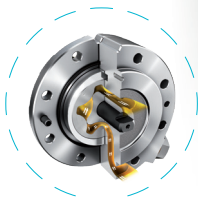

Service friendly design: +

- Easily to be replaced build-in motor due to slide fit (not press fit)
- Easily removable oil strainer

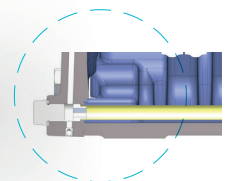

+ High efficient fans

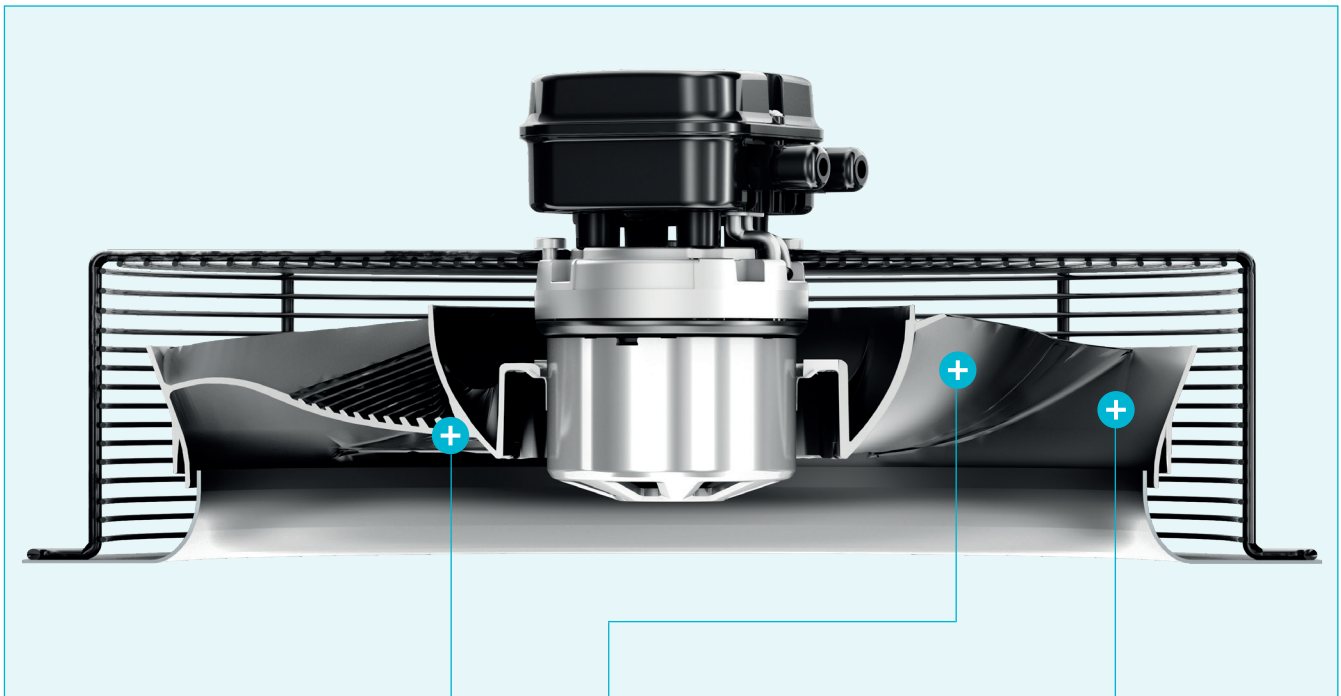

fan blades with grooves on the rear

- Increase in mechanical stability
- Higher power density



Optimum flow through impeller with improved geometry

- Three-dimensional improvement of the blade shape and optimization of the impeller
- Optimum flow through the fan due to immersed inlet ring and larger outlet opening



Increased efficiency due to pressure-boosting diffuser

- Diffuser ring integrated directly in the impeller, where it assumes the function of a diffuser
- Largest possible outflow angle
- **Increased efficiency of the fan:** reduction of outlet losses due to pressure-increasing effect of the diffuser
- Noise reduction

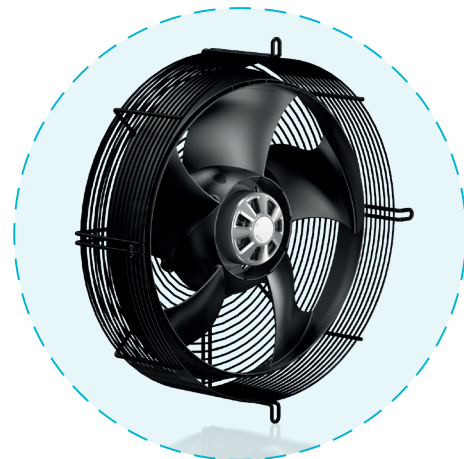
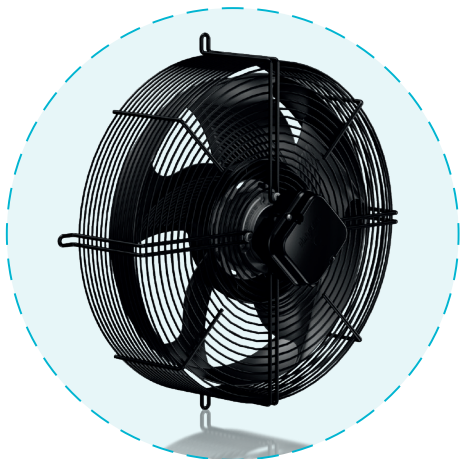

The current range

SHG air-cooled single- and two-stage condensing units

7 model sizes with 22 capacity stages from 6.4 to 139.8 m³/h (60 Hz)

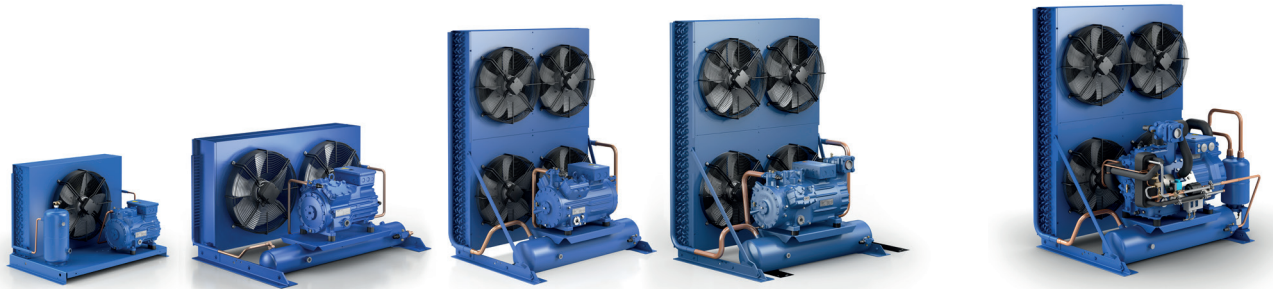
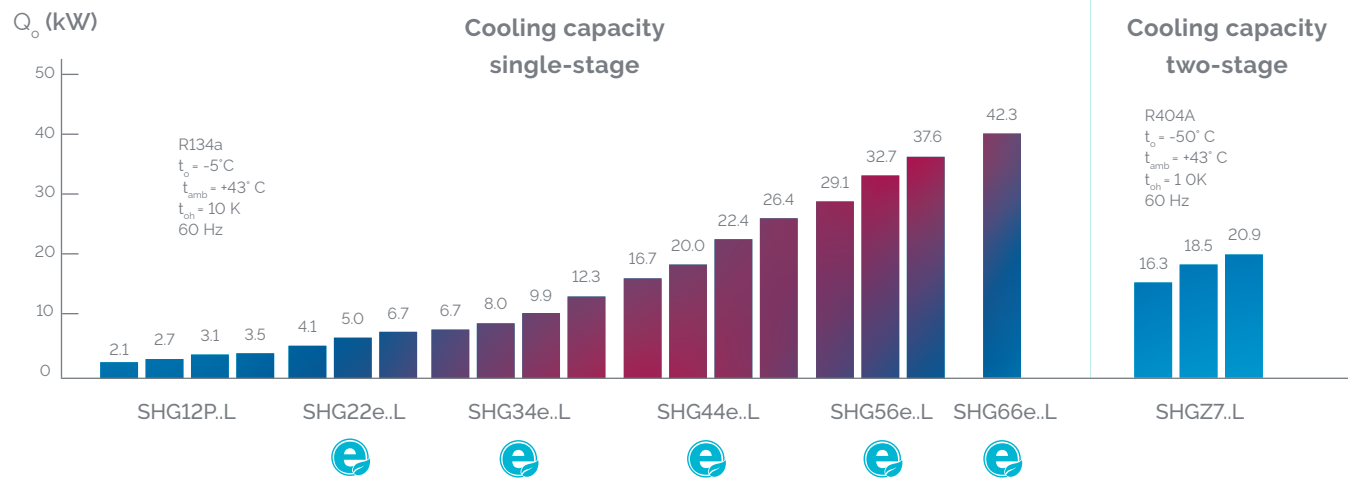

SHA air-cooled single-stage condensing units for efficient low temperature applications

3 model sizes with 10 capacity stages from 13.3 to 69.3 m³/h (60 Hz)

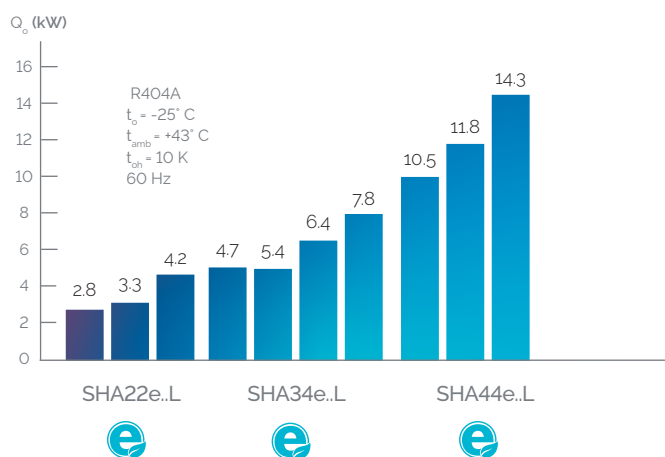

Performance comparison

Max. ambient temperature SHG44e/665-4 SL
Refrigerant: R404A

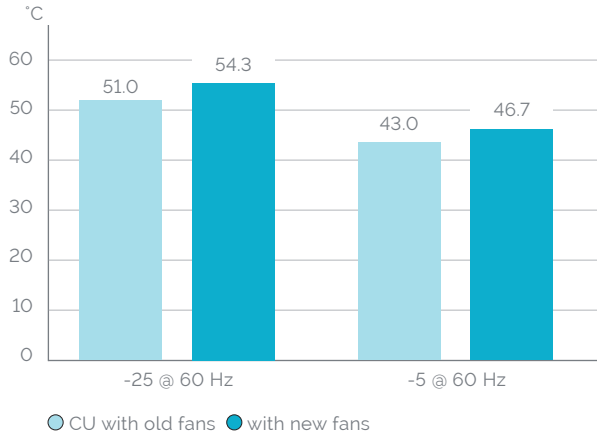

Max. ambient temperature SHG44e/665-4 SL
Refrigerant: R134A

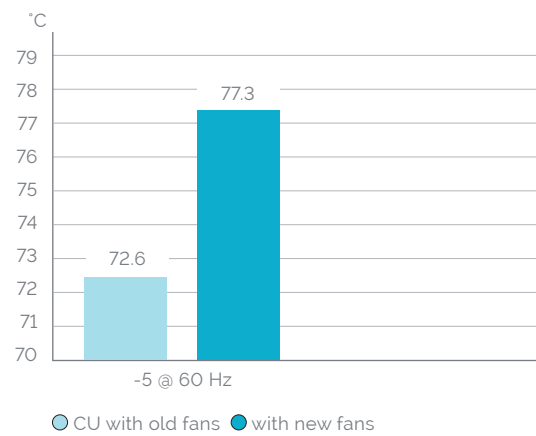

Capacity data SHG44e/665-4 SL
Refrigerant: R404A

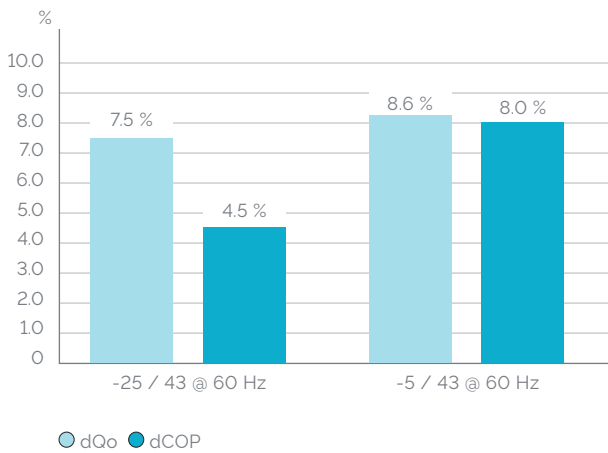

Capacity data SHG44e/665-4 SL
Refrigerant: R134A

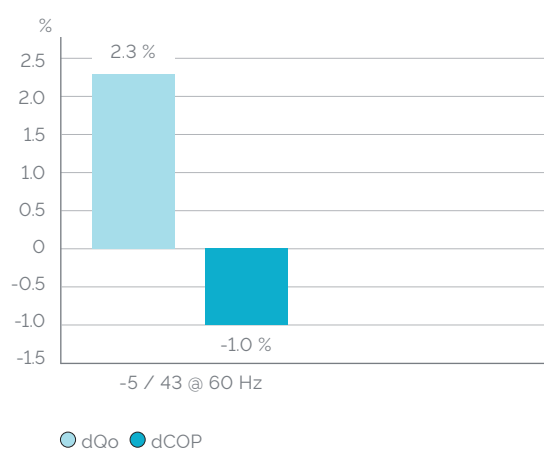

COMPRESSOR SELECTION PROGRAM

Up-to-date information on technical data, performance data, operating limits and much more can be accessed online via the BOCK compressor selection program (VAP): vap.bock.de





BOCK is one of the world's technology and innovation leaders in the development of environmentally friendly, economical solutions in the field of refrigeration and air-conditioning technology, including heat pumps and heat recovery – with one of the world's largest portfolios of compressors for natural refrigerants such as CO₂ (R744), hydrocarbons and other low-GWP refrigerants.

BOCK

Bock GmbH

Benzstraße 7
72636 Frickenhausen
Germany
Tel +49 7022 9454-0
Fax +49 7022 9454-137
bock.de