



intelsan
electric

www.intelsan.com



Catalogue



www.imtelsan.com



Lighting



IP65 Etanj Armatür (PC)
IP65 Etange waterproof with polycarbonates
пылевлагозащищенный



2118



2218



2136



2236



2158



2258



www.imtelsan.com

IP65 Oval Nemli Ortam (PC) 260 ∅
 IP65 Oval Waterproof Lighting
 IP65 овальный



1011

IP65 OVAL 260 ∅

Beyaz/Şeffaf
 White/Transparent
 белый/прозрачный



1012

IP65 OVAL 260 ∅

Beyaz/Opak
 White/Opak
 белый/ непрозрачный



1013

IP65 OVAL 260 ∅

Gri/Şeffaf
 Grey/Transparent
 серый/прозрачный



1014

IP65 OVAL 260 ∅

Gri/Opak
 Grey/Opak
 серый/непрозрачный



1015

IP65 OVAL 260 ∅

Siyah/Şeffaf
 Black/Transparent
 черный/прозрачный



1016

IP65 OVAL 260 ∅

Siyah/Opak
 Black/Opak
 черный/непрозрачный

IP65 DOUBLE OVAL 330 ∅

Beyaz/Şeffaf
 White/Transparent
 белый/прозрачный

IP65 DOUBLE OVAL 330 ∅

Beyaz/Opak
 White/Opak
 белый/ непрозрачный

IP65 DOUBLE OVAL 330 ∅

Gri/Şeffaf
 Grey/Transparent
 серый/прозрачный

IP65 DOUBLE OVAL 330 ∅

Gri/Opak
 Grey/Opak
 серый/непрозрачный

IP65 DOUBLE OVAL 330 ∅

Siyah/Şeffaf
 Black/Transparent
 черный/прозрачный

IP65 DOUBLE OVAL 330 ∅

Siyah/Opak
 Black/Opak
 черный/непрозрачный

IP65 Double Oval Nemli Ortam (PC) 330 ∅
 IP65 Double Oval Waterproof Lighting
 IP65 двойная лампа



1021



1022



1023



1024



1025



1026

E27 Duyulu

In Box	In Carton (pcs)	Weight (kg)	Volume (m³)
1	10	7,11 - 8,80	0,124

330 ∅

ÇİFT DUYLU

E27 Duyulu

In Box	In Carton (pcs)	Weight (kg)	Volume (m³)
1	10	4,32-5,60	0,071



imtelsan
light

www.imtelsan.com

imtelsan
light

www.imtelsan.com

IP65 Venüs Nemli Ortam (PC) 260 ∅
IP65 Venus Waterproof Lighting
IP65 Venus (водонепроницаемый)



260 ∅



1071



1072



1073



1074



1075



1076

IP65 VENÜS 260 ∅

Beyaz/Şeffaf
White/Transparent
белый/прозрачный

IP65 VENÜS 260 ∅

Beyaz/Opak
White/Opak
белый/ непрозрачный

IP65 VENÜS 260 ∅

Grİ/Şeffaf
Grey/Transparent
серый/прозрачный

IP65 VENÜS 260 ∅

Grİ/Opak
Grey/Opak
серый/непрозрачный

IP65 VENÜS 260 ∅

Siyah/Şeffaf
Black/Transparent
черный/прозрачный

IP65 VENÜS 260 ∅

Siyah/Opak
Black/Opak
черный/непрозрачный

IP65 DOUBLE VENÜS 330 ∅

Beyaz/Şeffaf
White/Transparent
белый/прозрачный

IP65 DOUBLE VENÜS 330 ∅

Beyaz/Opak
White/Opak
белый/ непрозрачный

IP65 DOUBLE VENÜS 330 ∅

Grİ/Şeffaf
Grey/Transparent
серый/прозрачный

IP65 DOUBLE VENÜS 330 ∅

Grİ/Opak
Grey/Opak
серый/непрозрачный

IP65 DOUBLE VENÜS 330 ∅

Siyah/Şeffaf
Black/Transparent
черный/прозрачный

IP65 DOUBLE VENÜS 330 ∅

Siyah/Opak
Black/Opak
черный/непрозрачный



1081



1082



1083



1084



1085



1086

IP65 Double Venüs Nemli Ortam (PC) 330 ∅
IP65 Venus Waterproof Lighting
IP65 Venus (водонепроницаемый)

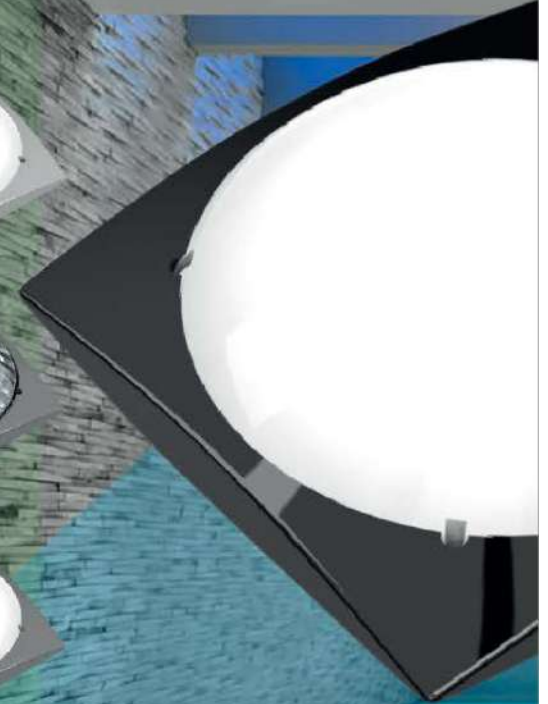

ÇİFT DUYLU

E27 Duyulu			
In Box	In Carton (pcs)	Weight (kg)	Volume (m ³)
1	10	4,69-6,05	0,071



E27 Duyulu			
In Box	In Carton (pcs)	Weight (kg)	Volume (m ³)
1	10	7,11 - 8,80	0,124



imtelsan
light

www.imtelsan.com

imtelsan
light

www.imtelsan.com

IP65 Elips Nemli Ortam (PC)
IP65 ellipse Waterproof Lighting
IP65 эллипс



1037



1038



1039



1040



1041



1042



E27 Duylu

In Box	In Carton (pcs)	Weight (kg)	Volume(m³)
1	10	3,58-4,5	0,042



imtelsan
light

www.imtelsan.com

6

IP65 ELIPS 260 ☒

Beyaz/Şeffaf
White/Transparent
белый/прозрачный

IP65 ELIPS 260 ☒

Beyaz/Opak
White/Opak
белый/ непрозрачный

IP65 ELIPS 260 ☒

Grİ/Şeffaf
Grey/Transparent
серый/прозрачный

IP65 ELIPS 260 ☒

Grİ/Opak
Grey/Opak
серый/непрозрачный

IP65 ELIPS 260 ☒

Siyah/Şeffaf
Black/Transparent
черный/прозрачный

IP65 ELIPS 260 ☒

Siyah/Opak
Black/Opak
черный/непрозрачный

IP65 KARE 260 ☒

Beyaz/Şeffaf
White/Transparent
белый/прозрачный

IP65 KARE 260 ☒

Beyaz/Opak
White/Opak
белый/ непрозрачный

IP65 KARE 260 ☒

Grİ/Şeffaf
Grey/Transparent
серый/прозрачный

IP65 KARE 260 ☒

Grİ/Opak
Grey/Opak
серый/непрозрачный

IP65 KARE 260 ☒

Siyah/Şeffaf
Black/Transparent
черный/прозрачный

IP65 KARE 260 ☒

Siyah/Opak
Black/Opak
черный/непрозрачный

1031



1032



1033



1034



1035



1036



IP65 Kare Nemli Ortam (PC)
IP65 Square Waterproof Lighting
IP65 БЕЛАЯ



E27 Duylu

In Box	In Carton (pcs)	Weight (kg)	Volume(m³)
1	10	3,70-4,10	0,042



imtelsan
light

www.imtelsan.com

7

IP54 Neptun Nemli Ortam (PC)
IP54 NEPTUNE Waterproof Lighting
IP54 Нептун



1090

IP54 NEPTUN

Beyaz/Şeffaf
White/Transparent
белый/прозрачный



1091

IP54 NEPTUN

Beyaz/Opak
White/Opak
белый/ непрозрачный



1092

IP54 NEPTUN

Gri/Şeffaf
Grey/Transparent
серый/прозрачный



1093

IP54 NEPTUN

Gri/Opak
Grey/Opak
серый/непрозрачный

12,20



1094

IP54 NEPTUN

Siyah/Şeffaf
Black/Transparent
черный/прозрачный

E27 Duylu

In Box	In Carton (pcs)	Weight (kg)	Volume(m ³)
4	32	9,60-10,60	0,091

1095

IP54 NEPTUN

Siyah/Opak
Black/Opak
черный/непрозрачный



Sensörlü Tavan Armatürü
Sensor ceiling luminaire
Датчик потолочный светильник

2010



In Box	In Carton (pcs)	Weight (kg)	Volume (m ³)
1	10	12,40-13,30	0,118

2x60 Sensörlü Armatür
Lighting Fixture With Sensor
Осветительная арматура с датчиком

2011



In Box	In Carton (pcs)	Weight (kg)	Volume (m ³)
1	10	12,40-13,30	0,118

2x60 Sensörlü Şarjlı Acil Kitli Armatür
Emergency Lighting Fixture With Sensor(Include Battery)
Аварийное освещение с датчиком

2012



In Box	In Carton (pcs)	Weight (kg)	Volume (m ³)
1	10	12,40-13,30	0,118

Ledli Sensörlü Armatür
Led Lighting Fixture With Sensor
Светодиодное освещение с датчиком

2013



In Box	In Carton (pcs)	Weight (kg)	Volume (m ³)
1	10	12,40-13,30	0,118

Ledli Sensörlü Şarjlı Acil Kitli Armatür
Led Emergency Lighting Fixture With Sensor(Include Battery)
Светодиодный светильник аварийного освещения с датчиком



www.imtelsan.com

IP20 Double Tuna Plastik Tavan Armatürü
 IP20 Double Tuna Ceiling lighting Fixture Lighting
 IP20 дважды тунца Потолочные Светильник



DOUBLE TUNA 1
 Beyaz
 White
 белый



1059

Altın
 Gold
 золото



1059-1

Piramit
 Pyramid



1059-3

Gümüş
 Silver
 серебро



1059-2

Kayın
 Oak
 бук



1059-4

Ceviz
 Walnut
 Орех



1059-6

230 V
 50 Hz.
 Max. 2x60 W

Beyaz/White

30,00 ₺

Renkli/Colored

32,00 ₺

In Box : 1
 In Carton (pcs) : 10
 Weight (kg) : 9.00-10.00
 Volume (m³) : 0.166



With ESL ÇİFT DUYLU

Kiraz
 Cherry
 ВИШНЯ



1059-5

MAXI TUNA 1
 Beyaz
 White
 белый



1057

Altın
 Gold
 золото



1057-1

Piramit
 Pyramid
 пирамида



1057-3

Gümüş
 Silver
 серебро



1057-2

Kayın
 Oak
 бук



1057-4

Ceviz
 Walnut
 Орех



1057-6

230 V
 50 Hz.
 Max. 60 W

Beyaz/White

15,60 ₺

Renkli/Colored

17,60 ₺

In Box : 5
 In Carton (pcs) : 20
 Weight (kg) : 6.53-7.00
 Volume (m³) : 0.051



With ESL

Kiraz
 Cherry
 ВИШНЯ



1057-5

DOUBLE TUNA 2
 Beyaz
 White
 белый



1060

Altın
 Gold
 золото



1060-1

Piramit
 Pyramid



1060-3

Gümüş
 Silver
 серебро



1060-2

Kayın
 Oak
 бук



1060-4

Ceviz
 Walnut
 Орех



1060-6

230 V
 50 Hz.
 Max. 2x60 W

Beyaz/White

30,00 ₺

Renkli/Colored

32,00 ₺

In Box : 1
 In Carton (pcs) : 10
 Weight (kg) : 9.00-10.00
 Volume (m³) : 0.166



With ESL ÇİFT DUYLU

Kiraz
 Cherry
 ВИШНЯ



1060-5

MAXI TUNA 2
 Beyaz
 White
 белый



1058

Altın
 Gold
 золото



1058-1

Piramit
 Pyramid
 пирамида



1058-3

Gümüş
 Silver
 серебро



1058-2

Kayın
 Oak
 бук



1058-4

Ceviz
 Walnut
 Орех



1058-6

230 V
 50 Hz.
 Max. 60 W

Beyaz/White

15,60 ₺

Renkli/Colored

17,60 ₺

In Box : 5
 In Carton (pcs) : 20
 Weight (kg) : 6.53-7.00
 Volume (m³) : 0.051



With ESL

Kiraz
 Cherry
 ВИШНЯ



1058-5

IP20 Tuna Plastik Tavan Armatürü

IP20 Tuna Ceiling lighting Fixture Lighting
IP20 тунца Потолочные Светильник-



TUNA 1
Beyaz
White
белый

1055



TUNA 2
Beyaz
White
белый

1056



TUNA 3
Beyaz
White
белый

1057



TUNA 4
Beyaz
White
белый

1058



Max 60 Watt

E27 Duyulu Beyaz/White				
In Box	In Carton (pcs)	Weight (kg)	Volume(m ³)	
5	40	10,88-13,00	0,077	



Max 60 Watt

E27 Renkli/Colored				
In Box	In Carton (pcs)	Weight (kg)	Volume(m ³)	
5	40	10,88-13,00	0,077	



IP20 Aplik Plastik Tavan Armatürü
IP20 Aplik Ceiling lighting Fixture Lighting
IP20 Aplik Потолочные Светильник-БУК

Aplik 1
Beyaz
White
белый

1061



Aplik 2
Beyaz
White
белый

1062



Max 60 Watt

E27 Duyulu Beyaz/White				
In Box	In Carton (pcs)	Weight (kg)	Volume(m ³)	
5	40	9,35-10,35	0,072	



Max 60 Watt

E27 Renkli/Colored				
In Box	In Carton (pcs)	Weight (kg)	Volume(m ³)	
5	40	9,35-10,35	0,072	

2095



2097



With ESL

E27 Duy Beyaz (Mars)				
In Box	In Carton (pcs)	Weight (kg)	Volume(m ³)	
5	40	8,00 - 8,50	0,065	









With ESL

E27 Duy Beyaz (Merkür)				
In Box	In Carton (pcs)	Weight (kg)	Volume(m ³)	
5	40	9,35-10,35	0,072	

Electric



 <p>32100 2'li Topraksız Grup Priz Klemensli 2 Gang Socket Колодка 2 гнезда без заземл.</p>	<p>32103 2'li Topraksız Grup Priz 3 mt Kablolu 2 Gang Socket With & 3m Cord удлинитель 2/3м без заземл.</p>
 <p>32102 2'li Topraksız Grup Priz 2 mt Kablolu 2 Gang Socket With & 2m Cord удлинитель 2/2м без заземл.</p>	<p>32105 2'li Topraksız Grup Priz 5 mt Kablolu 2 Gang Socket With & 5m Cord удлинитель 2/5м без заземл.</p>
 <p>32200 2'li Topraksız Anah. Grup Priz Klemensli 2 Gang Socket With Switch Колодка 2 гнезда без заземл. с выкл.</p>	<p>32203 2'li Topraksız Anah. Grup Priz 3 mt Kablolu 2 Gang Socket With Switch & 3m Cord удлинитель 2/3м без заземл. с выкл.</p>
 <p>32202 2'li Topraksız Anah. Grup Priz 2 mt Kablolu 2 Gang Socket With Switch & 2m Cord удлинитель 2/2м без заземл. с выкл.</p>	<p>32205 2'li Topraksız Anah. Grup Priz 5 mt Kablolu 2 Gang Socket With Switch & 5m Cord удлинитель 2/5м без заземл. с выкл.</p>
 <p>32300 2'li Topraklı Grup Priz Klemensli 2 Gang Earthed Socket Колодка 2 гнезда с заземлением</p>	<p>32303 2'li Topraklı Grup Priz 3 mt Kablolu 2 Gang Earthed Socket with 3m Cord удлинитель 2/3м с заземлением</p>
 <p>32302 2'li Topraklı Grup Priz 2 mt Kablolu 2 Gang Earthed Socket with 2m Cord удлинитель 2/2м с заземлением</p>	<p>32305 2'li Topraklı Grup Priz 5 mt Kablolu 2 Gang Earthed Socket with 5m Cord удлинитель 2/5м с заземлением</p>
<p>32400 2'li Topraklı Anah. Grup Priz Klemensli 2 Gang Earthed Socket With Switch Колодка 2 гнезда с заземл. с выкл.</p>	<p>32403 2'li Topraklı Anah. Grup Priz 3 mt Kablolu 2 Gang Earthed Socket With Switch & 3m Cord удлинитель 2/3м с заземлением с выключателем</p>
<p>32402 2'li Topraklı Anah. Grup Priz 2 mt Kablolu 2 Gang Earthed Socket With Switch & 2m Cord удлинитель 2/2м с заземлением с выключателем</p>	<p>32405 2'li Topraklı Anah. Grup Priz 5 mt Kablolu 2 Gang Earthed Socket With Switch & 5m Cord удлинитель 2/5м с заземлением с выключателем</p>
<p>33100 3'lu Topraksız Grup Priz Klemensli 3 Gang Socket Колодка 3 гнезда без заземл.</p>	<p>33103 3'lu Topraksız Grup Priz 3 mt Kablolu 3 Gang Socket With & 3m Cord удлинитель 3/3м без заземл.</p>
<p>33102 3'lu Topraksız Grup Priz 2 mt Kablolu 3 Gang Socket With & 2m Cord удлинитель 3/2м без заземл.</p>	<p>33105 3'lu Topraksız Grup Priz 5 mt Kablolu 3 Gang Socket With & 5m Cord удлинитель 3/5м без заземл.</p>
<p>33200 3'lu Topraksız Anah. Grup Priz Klemensli 3 Gang Socket With Switch Колодка 3 гнезда без заземл. с выкл.</p>	<p>33203 3'lu Topraksız Anah. Grup Priz 3 mt Kablolu 3 Gang Socket With Switch & 3m Cord удлинитель 3/3м без заземл. с выкл.</p>
<p>33202 3'lu Topraksız Anah. Grup Priz 2 mt Kablolu 3 Gang Socket With Switch & 2m Cord удлинитель 3/2м без заземл. с выкл.</p>	<p>33205 3'lu Topraksız Anah. Grup Priz 5 mt Kablolu 3 Gang Socket With Switch & 5m Cord удлинитель 3/5м без заземл. с выкл.</p>



33300
3'10 Topraklı Grup Priz Klemensli
3 Gang Earthed Socket
Колодка 3 гнезда с заземлением

33302
3'10 Topraklı Grup Priz 2 mt Kablolu
3 Gang Earthed Socket with 2m Cord
удлинитель 3/2м с заземлением

33303
3'10 Topraklı Grup Priz 3 mt Kablolu
3 Gang Earthed Socket with 3m Cord
Удлинитель 3/3м с заземлением

33305
3'10 Topraklı Grup Priz 5 mt Kablolu
3 Gang Earthed Socket with 5m Cord
удлинитель 3/5м с заземлением



33400
3'10 Topraklı Anah. Grup Priz Klemensli
3Gang Earthed Socket With Switch
Колодка 3 гнезда с заземл. с выкл.

33402
3'10 Topraklı Anah. Grup Priz 2 mt Kablolu
3Gang Earthed Socket With Switch & 2m Cord
удлинитель 3/2м с заземлением с выключателем

33403
3'10 Topraklı Anah. Grup Priz 3 mt Kablolu
3Gang Earthed Socket With Switch & 3m Cord
удлинитель 3/3м с заземлением с выключателем

33405
3'10 Topraklı Anah. Grup Priz 5 mt Kablolu
3Gang Earthed Socket With Switch & 5m Cord
удлинитель 3/5м с заземлением с выключателем



34100
4'10 Topraksız Grup Priz Klemensli
4 Gang Socket
Колодка 4 гнезда без заземл.

34102
4'10 Topraksız Grup Priz 2 mt Kablolu
4 Gang Socket With & 2m Cord
удлинитель 4/2м без заземл.

34103
4'10 Topraksız Grup Priz 3 mt Kablolu
4 Gang Socket With & 3m Cord
удлинитель 4/3м без заземл.

34105
4'10 Topraksız Grup Priz 5 mt Kablolu
4 Gang Socket With & 5m Cord
удлинитель 4/5м без заземл.



34200
4'10 Topraksız Anah. Grup Priz Klemensli
4 Gang Socket With Switch
Колодка 4 гнезда без заземл. с выкл.

34202
4'10 Topraksız Anah. Grup Priz 2 mt Kablolu
4 Gang Socket With Switch & 2m Cord
удлинитель 4/2м без заземл. с выкл.

34203
4'10 Topraksız Anah. Grup Priz 3 mt Kablolu
4 Gang Socket With Switch & 3m Cord
удлинитель 4/3м без заземл. с выкл.

34205
4'10 Topraksız Anah. Grup Priz 5 mt Kablolu
4 Gang Socket With Switch & 5m Cord
удлинитель 4/5м без заземл. с выкл.



34300
4'10 Topraklı Grup Priz Klemensli
4 Gang Earthed Socket
Колодка 4 гнезда с заземлением

34302
4'10 Topraklı Grup Priz 2 mt Kablolu
4 Gang Earthed Socket with 2m Cord
удлинитель 4/2м с заземлением

34303
4'10 Topraklı Grup Priz 3 mt Kablolu
4 Gang Earthed Socket with 3m Cord
Удлинитель 4/3м с заземлением

34305
4'10 Topraklı Grup Priz 5 mt Kablolu
4 Gang Earthed Socket with 5m Cord
Удлинитель 4/5м с заземлением



34400
4'10 Topraklı Anah. Grup Priz Klemensli
4Gang Earthed Socket With Switch
Колодка 4 гнезда с заземл. с выкл.

34402
4'10 Topraklı Anah. Grup Priz 2 mt Kablolu
4Gang Earthed Socket With Switch & 2m Cord
удлинитель 4/2м с заземлением с выключателем

34403
4'10 Topraklı Anah. Grup Priz 3 mt Kablolu
4Gang Earthed Socket With Switch & 3m Cord
удлинитель 4/3м с заземлением с выключателем

34405
4'10 Topraklı Anah. Grup Priz 5 mt Kablolu
4Gang Earthed Socket With Switch & 5m Cord
удлинитель 4/5м с заземлением с выключателем



35400
5'10 Topraklı Grup Priz Klemensli
5 Gang Earthed Socket
Колодка 5 гнезда с заземлением

35402
5'10 Topraklı Grup Priz 2 mt Kablolu
5 Gang Earthed Socket with 2m Cord
удлинитель 5/2м с заземлением

35403
5'10 Topraklı Grup Priz 3 mt Kablolu
5 Gang Earthed Socket with 3m Cord
Удлинитель 5/3м с заземлением

35405
5'10 Topraklı Grup Priz 5 mt Kablolu
5 Gang Earthed Socket with 5m Cord
удлинитель 5/5м с заземлением



35300
5'10 Topraklı Anah. Grup Priz Klemensli
5 Gang Earthed Socket With Switch
Колодка 5 гнезда с заземл. с выкл.

35302
5'10 Topraklı Anah. Grup Priz 2 mt Kablolu
5 Gang Earthed Socket With Switch & 2m Cord
удлинитель 5/2м с заземлением с выключателем

35303
5'10 Topraklı Anah. Grup Priz 3 mt Kablolu
5 Gang Earthed Socket With Switch & 3m Cord
удлинитель 5/3м с заземлением с выключателем

35305
5'10 Topraklı Anah. Grup Priz 5 mt Kablolu
5 Gang Earthed Socket With Switch & 5m Cord
удлинитель 5/5м с заземлением с выключателем



36300
6'10 Topraklı Grup Priz Klemensli
6 Gang Earthed Socket
Колодка 6 гнезд с заземлением

36302
6'10 Topraklı Grup Priz 2 mt Kablolu
6 Gang Earthed Socket with 2m Cord
удлинитель 6/2м с заземлением

36303
6'10 Topraklı Grup Priz 3 mt Kablolu
6 Gang Earthed Socket with 3m Cord
удлинитель 6/3м с заземлением

36305
6'10 Topraklı Grup Priz 5 mt Kablolu
6 Gang Earthed Socket with 5m Cord
удлинитель 6/5м с заземлением



36400
6'10 Topraklı Anah. Grup Priz Klemensli
6 Gang Earthed Socket With Switch
Колодка 6 гнезд с заземл. с выкл.

36402
6'10 Topraklı Anah. Grup Priz 2 mt Kablolu
6 Gang Earthed Socket With Switch & 2m Cord
Удлинитель 6/2м с заземлением с выключателем

36403
6'10 Topraklı Anah. Grup Priz 3 mt Kablolu
6 Gang Earthed Socket With Switch & 3m Cord
Удлинитель 6/3м с заземлением с выключателем

36405
6'10 Topraklı Anah. Grup Priz 5 mt Kablolu
6 Gang Earthed Socket With Switch & 5m Cord
Удлинитель 6/5м с заземлением с выключателем

4431



4'İD Topraklı Golyat Fiş Priz
4 Gang Earthed Plus & Socket
Разветлитель четверной с заземлением квадратный

Pcs./Box: 24 | Weight(kg): 3,92 | (m³): 0,0191

4231



2'İl Topraklı Golyat Fiş Priz
2 Gang Earthed Plus & Socket
Разветлитель двойной с заземлением

Pcs./Box: 160 | Weight(kg): 17,74 | (m³): 0,0814

4330



3'İD Topraklı Golyat Fiş Priz
3 Gang Earthed Plus & Socket
Разветлитель тройной с заземлением

Pcs./Box: 28 | Weight(kg): 3,32 | (m³): 0,0176

4331



3'İD Topraklı Papatyta Golyat Fiş Priz Beyaz
3 Gang Earthed Plug & Socket White
Разветлитель тройной с заземлением треугольный

Pcs./Box: 48 | Weight(kg): 5,70 | (m³): 0,0397

4332



3'İD Topraklı Papatyta Golyat Fiş Priz Gri
3 Gang Earthed Plug & Socket Grey
Разветлитель тройной с заземлением треугольный

Pcs./Box: 48 | Weight(kg): 5,70 | (m³): 0,0397

4333



3'İD Topraklı Papatyta Golyat Fiş Priz Siyah
3 Gang Earthed Plug & Socket Black
Разветлитель тройной с заземлением треугольный

Pcs./Box: 48 | Weight(kg): 5,70 | (m³): 0,0397

72001



İngiliz Golyat (İşklİ) (UK)
British Golyat (UK)
разветлитель англ. с подсветкой

Pcs./Box: 180 | Weight(kg): 12,52 | (m³): 0,0361

71001



İngiliz Adaptör
(British) MK Adapter
Разветлитель английский

Pcs./Box: 500 | Weight(kg): 13,91 | (m³): 0,0536

72002



İngiliz Golyat (İşklİ)
British Golyat
Разветлитель англ. с подсветкой

Pcs./Box: 192 | Weight(kg): 14,06 | (m³): 0,0361

4511



5'İl Fiş Golyat
Quintette Plug & Socket
разветлитель пентаборный

Pcs./Box: 500 | Weight(kg): 17,21 | (m³): 0,0536

4311



3'İD T Fiş
(British) MK Adapter
Разветлитель тройной английской

Pcs./Box: 500 | Weight(kg): 11,77 | (m³): 0,0536

515101



Yassı Erkek Fiş
Flat Male Plug
Вилка плоская

Pcs./Box: 1000 | Weight(kg): 15,19 | (m³): 0,0448

73001



American Fiş
American Plug
Американская вилка

Pcs./Box: 1000 | Weight(kg): 13,87 | (m³): 0,0448

81001 2,30t | 81002



Ara Puar Siyah-Beyaz
Intermediate Switch Black-White
Выключатель для бра белый/черный

Pcs./Box: 760 | Weight(kg): 12,48 | (m³): 0,0397

511311



Topraklı Erkek Fiş-UPS
Earthed male Plug-UPS
Вилка прямая с заземлением - UPS

Pcs./Box: 500 | Weight(kg): 16,45 | (m³): 0,0706

511101



Topraksız Erkek Fiş
Male Plug
Вилка обычная без заземления (минимоз)

Pcs./Box: 500 | Weight(kg): 10,83 | (m³): 0,0397

513311



Topraklı L Fiş Kulplu
Earthed male Plug (L)
Вилка штепсельная с заземлением с ручкой (L)

Pcs./Box: 500 | Weight(kg): 17,16 | (m³): 0,0706

511301



Topraklı Erkek Fiş
Earthed male Plug
Вилка прямая с заземлением

Pcs./Box: 500 | Weight(kg): 16,45 | (m³): 0,0706

506301



Topraklı Dişli Fiş
Earthed female Plug
Гнездо штепсельное с заземлением

Pcs./Box: 500 | Weight(kg): 15,00 | (m³): 0,0814

512301



Topraklı L Fiş
Earthed male Plug (L)
Вилка штепсельная с заземлением с ручкой (L)

Pcs./Box: 500 | Weight(kg): 17,16 | (m³): 0,0706

637105



5 mt Uzatma Kablo (3x1)
One Gang Earthed Socket 5m Cord (3x1)
Удлинитель 5 м (3x1)

Pcs./Box: 20 | Weight(kg): 10,67 | (m³): 0,0223

637107



7 mt Uzatma Kablo (3x1)
One Gang Earthed Socket 7m Cord (3x1)
Удлинитель 7 м (3x1)

Pcs./Box: 20 | Weight(kg): 13,85 | (m³): 0,0292

637110



10 mt Uzatma Kablo (3x1)
One Gang Earthed Socket 10m Cord (3x1)
Удлинитель 10 м (3x1)

Pcs./Box: 20 | Weight(kg): 18,94 | (m³): 0,0289

637115



15 mt Uzatma Kablo (3x1)
One Gang Earthed Socket 15m Cord (3x1)
Удлинитель 15 м (3x1)

Pcs./Box: 10 | Weight(kg): 14,76 | (m³): 0,0292

637120



20 mt Uzatma Kablo (3x1)
One Gang Earthed Socket 20m Cord (3x1)
Удлинитель 20 м (3x1)

Pcs./Box: 10 | Weight(kg): 19,19 | (m³): 0,0292

82002



Muhafazalı Tj Duy
Pendant Lamp Holder
Патрон для лампы со штангодержателем

Pcs./Box: 100 | Weight(kg): 7,59 | (m³): 0,0397

910001



KUTU AD. KOLI AD.
50 300

1x16 Kauçuk Erkek Fiş
1x16 Rubber Male Plug

910002



KUTU AD. KOLI AD.
30 180

1x16 Kauçuk Dişi Fiş (Kapaksız)
1x16 Rubber Female Plug

910003



KUTU AD. KOLI AD.
30 180

1x16 Kauçuk Dişi Fiş (Kapaklı)
1x16 Rubber Female Plug

910004



KUTU AD. KOLI AD.
18 108

1x16 Monofaze Topraklı Duvar Prizi
1x16 Single Phase Wall Type Socket

910205



KUTU AD. KOLI AD.
8 96

1x16 Kauçuk Monofaze 2'li Grup Priz
1x16 Rubber Three Phase 2 Gang
Group Socket

910306



KUTU AD. KOLI AD.
6 72

1x16 Monofaze 3'lü Grup Priz
1x16 Rubber Three Phase 3 Gang
Group Socket

910407



KUTU AD. KOLI AD.
9 54

1x16 Monofaze 4'lü Grup Priz
1x16 Group Socket with Monofaze 4

920011



KUTU AD. KOLI AD.
30 180

Trifaze Fiş
Triplicate Plug

920021



KUTU AD. KOLI AD.
16 96

Trifaze Priz
Triphase Socket

920001



KUTU AD. KOLI AD.
25 150

3x25 Kauçuk Trifaze Fiş
3x25 Rubber Trifaze Plug

920002



KUTU AD. KOLI AD.
20 120

3x25 Kauçuk Trifaze Priz
3x25 Three Phase Rubber Earthed

920003



KUTU AD. KOLI AD.
14 84

3x25 Kauçuk Duvar Prizi (Klemensli)
3x25 Three Phase Wall Type Socket

921104



KUTU AD. KOLI AD.
8 48

3x25 1Ad. / 1x16 1Ad. 1 Trifaze 1 Monofaze
3x25 Rubber Group Socket 1 Three Phase
And 1 Single Phase

920205



KUTU AD. KOLI AD.
8 48

3x25 2'li Trifaze Grup Priz
3x25 Rubber Three Phase 2 Gang
Group Socket

921206



KUTU AD. KOLI AD.
6 36

3x25 1Ad. / 1x16 2Ad. 1 Trifaze 2 Monofaze
3x25 Rubber Group Socket 1 Three Phase
and 2 Single Phase

921207



KUTU AD. KOLI AD.
6 36

3x25 2Ad. / 1x16 2Ad. 2 Trifaze 1 Monofaze
3x25 Rubber Group Socket 2 Three Phase
And 1 Single Phase

920308



KUTU AD. KOLI AD.
6 36

3x25 3'lü Trifaze Grup Priz
3x25 Rubber 2 Gang Group Socket

61001



Pcs./Box: 240 | Weight(kg): 15,84 | (m³): 0,1202

1-2'li W Otomat Kutusu
1-2 Fuse Box
Коробка под 1-2 автомата с местом под диодну Наружная

61003



Pcs./Box: 120 | Weight(kg): 10,52 | (m³): 0,0922

3-4'li W Otomat Kutusu
3-4 Fuse Box
Коробка под 3-4 автомата с местом под диодну Наружная

60002



Pcs./Box: 30 | Weight(kg): 6,82 | (m³): 0,0578

2'li Dekoratif Siva Altı W Otomat Kutusu
2 Flush Mounted Fuse Box
Коробка под 2 автомата внутренняя

61002



2'li Dekoratif Siva Üstü W Otomat Kutusu
2 Surface Mounted Fuse Box
Коробка под 2 автомата Наружная

60004



Pcs./Box: 30 | Weight(kg): 8,00 | (m³): 0,0691

4'li Dekoratif Siva Altı W Otomat Kutusu
4 Flush Mounted Fuse Box
Коробка под 4 автомата внутренняя

61004



4'li Dekoratif Siva Üstü W Otomat Kutusu
4 Surface Mounted Fuse Box
Коробка под 4 автомата Наружная

60006



Pcs./Box: 30 | Weight(kg): 10,40 | (m³): 0,0931

6'li Dekoratif Siva Altı W Otomat Kutusu
6 Flush Mounted Fuse Box
Коробка под 6 автоматов внутренняя

61006



6'li Dekoratif Siva Üstü W Otomat Kutusu
6 Surface Mounted Fuse Box
Коробка под 6 автоматов Наружная

60009



Pcs./Box: 30 | Weight(kg): 15,10 | (m³): 0,1474

9'li Dekoratif Siva Altı W Otomat Kutusu
9 Flush Mounted Fuse Box
Коробка под 9 автоматов внутренняя

61009



9'li Dekoratif Siva Üstü W Otomat Kutusu
9 Surface Mounted Fuse Box
Коробка под 9 автоматов Наружная

60012



Pcs./Box: 20 | Weight(kg): 15,20 | (m³): 0,1577

12'li Dekoratif Siva Altı W Otomat Kutusu
12 Flush Mounted Fuse Box
Коробка под 12 автоматов внутренняя

61012



12'li Dekoratif Siva Üstü W Otomat Kutusu
12 Surface Mounted Fuse Box
Коробка под 12 автоматов Наружная

60018



Pcs./Box: 18 | Weight(kg): 16,15 | (m³): 0,1642

18'li Dekoratif Siva Altı W Otomat Kutusu
18 Flush Mounted Fuse Box
Коробка под 18 автоматов внутренняя

61018



18'li Dekoratif Siva Üstü W Otomat Kutusu
18 Surface Mounted Fuse Box
Коробка под 18 автоматов Наружная

60016



Pcs./Box: 20 | Weight(kg): 18,90 | (m³): 0,1642

16'li Dekoratif Siva Altı W Otomat Kutusu
16 Flush Mounted Fuse Box
Коробка под 16 автоматов внутренняя

61016



16'li Dekoratif Siva Üstü W Otomat Kutusu
16 Surface Mounted Fuse Box
Коробка под 16 автоматов Наружная

60024



Pcs./Box: 10 | Weight(kg): 12,58 | (m³): 0,1279

24'li Dekoratif Siva Altı W Otomat Kutusu
24 Flush Mounted Fuse Box
Коробка под 24 автомата внутренняя

61024



24'li Dekoratif Siva Üstü W Otomat Kutusu
24 Surface Mounted Fuse Box
Коробка под 24 автоматов Наружная

60036



Pcs./Box: 10 | Weight(kg): 18,88 | (m³): 0,1784

36'li Dekoratif Siva Altı W Otomat Kutusu
36 Flush Mounted Fuse Box
Коробка под 36 автоматов внутренняя

61036



36'li Dekoratif Siva Üstü W Otomat Kutusu
36 Surface Mounted Fuse Box
Коробка под 36 автоматов Наружная

ÇİVİLİ KROŞE / CABLE CLIPS / ATACH CABLE BLONCH

Kod Code	Ürün Product	Pcs/ Carton
851000	Çivili Kroşe No. 0	20.000
851001	Çivili Kroşe No. 1	20.000
851002	Çivili Kroşe No. 2	20.000
851003	Çivili Kroşe No. 3	20.000
851004	Çivili Kroşe No. 4	20.000
851005	Çivili Kroşe No. 5	10.000
851006	Çivili Kroşe No. 6	10.000
851007	Çivili Kroşe No. 7	10.000
851008	Çivili Kroşe No. 8	6.000

PLASTİK SUSTA / SPRING PLASTIC CABLE PULLER

Kod Code	Ürün Product	Pcs/ Carton
860005	Plastik Susta 5 mt	20.000
860010	Plastik Susta 10 mt	20.000
860015	Plastik Susta 15 mt	20.000
860020	Plastik Susta 20 mt	20.000
860025	Plastik Susta 25 mt	20.000

ÇELİK SUSTA / SPRING STEEL CABLE PULLER

Kod / Code	Ürün Adı / Name of Product	Kutu Ad. In box	Koli Ad. In Carton
847010	Profesyonel Susta 10 Metre Çap 3,40 mm 10 m Profesional Spring Steel Cable Puller Ø 3,40 mm	30	30
847015	Profesyonel Susta 15 Metre Çap 3,40 mm 15 m Profesional Spring Steel Cable Puller Ø 3,40 mm	25	25
847020	Profesyonel Susta 20 Metre Çap 3,40 mm 20 m Profesional Spring Steel Cable Puller Ø 3,40 mm	20	20
847025	Profesyonel Susta 25 Metre Çap 3,40 mm 25 m Profesional Spring Steel Cable Puller Ø 3,40 mm	15	15
848010	Profesyonel Alman Susta 10 mt Çap 3,70 mm 10 m Profesional Spring Steel Cable Puller Ø 3,70 mm	30	30
848015	Profesyonel Alman Susta 15 mt Çap 3,70 mm 15 m Profesional Spring Steel Cable Puller Ø 3,70 mm	25	25
848020	Profesyonel Alman Susta 20 mt Çap 3,70 mm 20 m Profesional Spring Steel Cable Puller Ø 3,70 mm	20	20
848025	Profesyonel Alman Susta 25 mt Çap 3,70 mm 25 m Profesional Spring Steel Cable Puller Ø 3,70 mm	15	15
849010	Profesyonel Kolon Susta 10 mt Çap 4 mm 10 m Profesional Spring Steel Cable Puller Ø 4 mm	30	30
849015	Profesyonel Kolon Susta 15 mt Çap 4 mm 15 m Profesional Spring Steel Cable Puller Ø 4 mm	25	25
849020	Profesyonel Kolon Susta 20 mt Çap 4 mm 20 m Profesional Spring Steel Cable Puller Ø 4 mm	20	20
849025	Profesyonel Kolon Susta 25 mt Çap 4 mm 25 m Profesional Spring Steel Cable Puller Ø 4 mm	15	15
849030	Profesyonel Kolon Susta 30 mt Çap 4 mm 30 m Profesional Spring Steel Cable Puller Ø 4 mm	10	10
849050	Profesyonel Kolon Susta 50 mt Çap 4 mm 50 m Profesional Spring Steel Cable Puller Ø 4 mm	10	10

ŞEFFAF KAPAKLI TERMOPLASTİK BUATLAR



ÜRÜN KODU	ÖLÇÜ (mm)	A	B	C	CİNSİ	KOLİ AD.
VST 001	110 x 110 x 90				PC Buat	-----
VST 002	110 x 110 x 120				PC Buat	-----
NEW VST 003	80 x 120 x 60				PC Buat	-----
NEW VST 004	80 x 120 x 100				PC Buat	-----
NEW VST 005	110 x 150 x 65				PC Buat	-----
NEW VST 006	110 x 150 x 110				PC Buat	-----
NEW VST 007	110 x 180 x 65				PC Buat	-----
NEW VST 008	110 x 180 x 115				PC Buat	-----
VST 009	130 x 230 x 85				PC Buat	-----
VST 010	130 x 230 x 120				PC Buat	-----
NEW VST 011	200 x 250 x 90				PC Buat	-----
NEW VST 012	200 x 250 x 130				PC Buat	-----
VST 013	230 x 310 x 130				PC Buat	-----
VST 014	230 x 310 x 180				PC Buat	-----
NEW VST 015	120 x 210 x 65				PC Buat	-----
NEW VST 016	120 x 210 x 115				PC Buat	-----
VST 017	140 x 190 x 65					-----
VST 018	140 x 190 x 110					-----
VST 019	140 x 190 x 140					-----

KARE ANTİGRON BUATLER IP 54 - IP 44 (EKO)

NEW

ÜRÜN KODU	ÖLÇÜ (mm)	A	B	C	CİNSİ	KOLİ AD.
VEK 001	70 x 70 x 40				P.P Buat	-----
VEK 002	80 x 80 x 45				P.P Buat	-----
VEK 003	80 x 120 x 60				P.P Buat	-----
VEK 004	110 x 110 x 50				P.P Buat	-----
VEK 005	110 x 150 x 65				P.P Buat	-----

OPAK KAPAKLI ABS PANOLAR

ABS



ÖLÇÜ (mm)	A	B	C	CİNSİ	KOLİ AD.
200 x 300 x 120				ABS Pano	1 Adet
250 x 350 x 150				ABS Pano	1 Adet
300 x 400 x 180				ABS Pano	1 Adet
400 x 500 x 210				ABS Pano	1 Adet
400 x 600 x 200				ABS Pano	1 Adet
500 x 600 x 230				ABS Pano	1 Adet

NEW

KULLANIM ALANLARI



IP 65



FÜME KAPAKLI ABS PANOLAR

P.C



NEW

ÖLÇÜ (mm)	A	B	C	CİNSİ	KOLİ AD.
200 x 300 x 120				PC Pano	1 Adet
250 x 350 x 150				PC Pano	1 Adet
300 x 400 x 180				PC Pano	1 Adet
400 x 500 x 210				PC Pano	1 Adet
400 x 600 x 200				PC Pano	1 Adet
500 x 600 x 230				PC Pano	1 Adet

IP 65



ABS PANO AKSESUARLARI (Galveniz Taban Saçları)

ÜRÜN KODU	ÖLÇÜ (mm) A B C
OTS 203015	200 x 300 x 150
OTS 253313	250 x 330 x 130
OTS 304017	300 x 400 x 170
OTS 304020	300 x 400 x 200
OTS 355020	350 x 500 x 200
OTS 405020	400 x 500 x 200
OTS 405024	400 x 500 x 240
OTS 406020	400 x 600 x 200
OTS 406024	400 x 600 x 240
OTS 507025	500 x 700 x 250

PERDE PLASTİKLERİ VE SEPERATÖRLER



ÜRÜN KODU	ÖLÇÜ (mm) A B C	CİNSİ
OVP 2030 - 8	200 x 300 x 150	8 Otomatlı
OVP 3040 - 24	300 x 400 x 200	24 Otomatlı
OVP 4050 - 50	400 x 500 x 200	50 Otomatlı
OVP 4060 - 60	400 x 600 x 200	60 Otomatlı
OVP 2030 - 8	200 x 300 x 150	İç Perde Pls.
OVP 3040 - 24	300 x 400 x 200	İç Perde Pls.
OVP 4050 - 50	400 x 500 x 200	İç Perde Pls.
OVP 4060 - 60	400 x 600 x 200	İç Perde Pls.

PANO AKSESUARLARI

ÜRÜN KODU	CİNSİ
OVP 01	Klit Göbek Takımı
OVP 02	Pano Duvara Tutturma Aparatı (4'lü Set)
OVP 03	Plastik Üçgen Anahtar
OVP 04	Seperatör Tutturma Vidası

OPAK KAPAKLI ABS PANOLAR

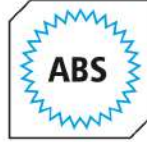
Opaque Colored Abs lid-plastic Enclosures



ÜRÜN KODU	ÖLÇÜ (mm) A B C	CİNSİ	KOLİ AD.
OTS 203015	200 x 300 x 150	ABS Pano	1 Adet
OTS 253313	250 x 330 x 130	ABS Pano	1 Adet
OTS 304017	300 x 400 x 170	ABS Pano	1 Adet
OTS 304020	300 x 400 x 200	ABS Pano	1 Adet
OTS 355020	350 x 500 x 200	ABS Pano	1 Adet
OTS 405020	400 x 500 x 200	ABS Pano	1 Adet
OTS 405024	400 x 500 x 240	ABS Pano	1 Adet
OTS 406020	400 x 600 x 200	ABS Pano	1 Adet
OTS 406024	400 x 600 x 240	ABS Pano	1 Adet
OTS 507025	500 x 700 x 250	ABS Pano	1 Adet

MAIN TECHNICAL FEATURES

- Resistance Chemical agents alkali, oils salts, etc.
- Rated Voltage Up to 690V
- Maximum Current: Up to 800A
- Operating Temperature -20 °C +65 °C
- Material ABS + Polycarbonate (Doors)
- Mounting Plate: Galvanised steel
- IP Degree: IP65
- IK Degree: Ik08
- Colour: RAL7035 Grey body smoked door (Other clorurs on request)

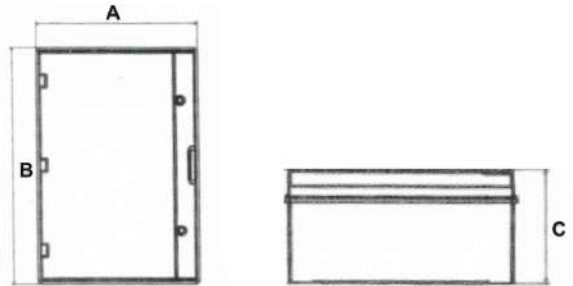

FÜME KAPAKLI ABS PANOLAR

Smoke Colored Abs lid-plastic Enclosures



ÜRÜN KODU	ÖLÇÜ (mm) A B C	CİNSİ	KOLİ AD.
FTS 203015	200 x 300 x 150	PC Pano	1 Adet
FTS 253313	250 x 330 x 130	PC Pano	1 Adet
FTS 304017	300 x 400 x 170	PC Pano	1 Adet
FTS 304020	300 x 400 x 200	PC Pano	1 Adet
FTS 355020	350 x 500 x 200	PC Pano	1 Adet
FTS 405020	400 x 500 x 200	PC Pano	1 Adet
FTS 405024	400 x 500 x 240	PC Pano	1 Adet
FTS 406020	400 x 600 x 200	PC Pano	1 Adet
FTS 406024	400 x 600 x 240	PC Pano	1 Adet
FTS 507025	500 x 700 x 250	PC Pano	1 Adet

MAIN TECHNICAL FEATURES

- Resistance Chemical agents alkali, oils salts, etc.
- Rated Voltage Up to 690V
- Maximum Current: Up to 800A
- Operating Temperature -20 °C +65 °C
- Material ABS + Polycarbonate (Doors)
- Mounting Plate: Galvanised steel
- IP Degree: IP65
- IK Degree: Ik08
- Colour: RAL7035 Grey body smoked door (Other clorurs on request)

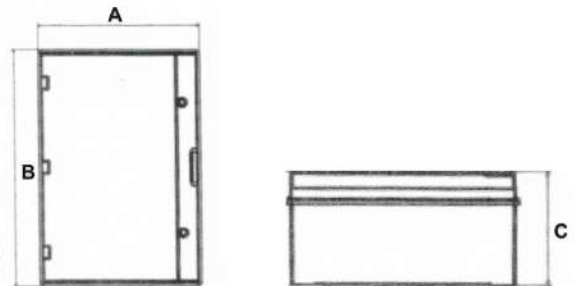

OPAK W OTOMAT DAĞITIM PANOLARI
Opaque Colored ABS Lid Distribution Box

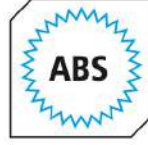

ÜRÜN KODU	ÖLÇÜ (mm) A B C	CİNSİ	KOLİ AD.
OVP 203015	200 x 300 x 150	8 Otomatlı	1 Adet
OVP 304017	300 x 400 x 170	24 Otomatlı	1 Adet
OVP 405020	400 x 500 x 200	50 Otomatlı	1 Adet
OVP 406020	400 x 600 x 200	60 Otomatlı	1 Adet
OVP 507025	500 x 700 x 250	80 Otomatlı	1 Adet

FÜME W OTOMAT DAĞITIM PANOLARI
Smoke Colored ABS Lid Distribution Box

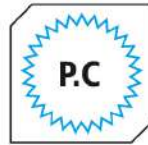

ÜRÜN KODU	ÖLÇÜ (mm) A B C	CİNSİ	KOLİ AD.
FVP 203015	200 x 300 x 150	8 Otomatlı	1 Adet
FVP 304017	300 x 400 x 170	24 Otomatlı	1 Adet
FVP 405020	400 x 500 x 200	50 Otomatlı	1 Adet
FVP 406020	400 x 600 x 200	60 Otomatlı	1 Adet
FVP 507025	500 x 700 x 250	80 Otomatlı	1 Adet



**OPAK KAPAKLI
W OTOMAT + PAKOLU DAĞITIM PANOLARI**

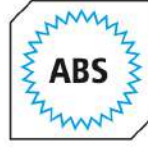

ÜRÜN KODU	ÖLÇÜ (mm) A B C	CİNSİ	KOLİ AD.
OVP 304017-12PK	300 x 400 x 170	12 W + Pakolu	1 Adet
OVP 405020-32PK	400 x 500 x 200	32 W + Pakolu	1 Adet
OVP 406020-46PK	400 x 600 x 200	46 W + Pakolu	1 Adet
OVP 507025-65PK	500 x 700 x 250	65 W + Pakolu	1 Adet

**FÜME KAPAKLI
W OTOMAT + PAKOLU DAĞITIM PANOLARI**

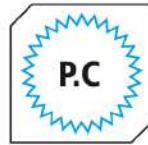

ÜRÜN KODU	ÖLÇÜ (mm) A B C	CİNSİ	KOLİ AD.
FVP 304017-12PK	300 x 400 x 170	12 W + Pakolu	1 Adet
FVP 405020-32PK	400 x 500 x 200	32 W + Pakolu	1 Adet
FVP 406020-46PK	400 x 600 x 200	46 W + Pakolu	1 Adet
FVP 507025-65PK	500 x 700 x 250	65 W + Pakolu	1 Adet



OPAK KAPAKLI TERMOPLASTİK BUATLAR

ÜRÜN KODU	ÖLÇÜ (mm)	A	B	C	CİNSİ	KOLİ AD.
VST 001	70 x 70 x 40				Termo Buat	60 Adet
NEW VST 002	85 x 85 x 45				Termo Buat	50 Adet
VST 003	110 x 110 x 50				Termo Buat	20 Adet
NEW VST 004	80 x 120 x 60				Termo Buat	24 Adet
NEW VST 005	110 x 150 x 65				Termo Buat	12 Adet
NEW VST 006	110 x 180 x 65				Termo Buat	10 Adet
VST 007	130 x 230 x 85				Termo Buat	60 Adet
NEW VST 008	200 x 250 x 90				Termo Buat	25 Adet
VST 009	230 x 310 x 130				Termo Buat	16 Adet
NEW VST 010	120 x 210 x 65				Termo Buat	70 Adet
VST 011	140 x 190 x 65				Termo Buat	İmalatta

OPAK KAPAKLI TERMOPLASTİK BUATLAR (DERİN)

ÜRÜN KODU	ÖLÇÜ (mm)	A	B	C	CİNSİ	KOLİ AD.
VSD 001	110 x 110 x 90				Termo Plastik	12 Adet
NEW VSD 002	110 x 110 x 120				Termo Plastik	12 Adet
NEW VSD 003	80 x 120 x 100				Termo Plastik	16 Adet
NEW VSD 004	110 x 150 x 110				Termo Plastik	8 Adet
NEW VSD 005	110 x 180 x 115				Termo Plastik	8 Adet
VSD 006	130 x 230 x 120				Termo Plastik	50 Adet
NEW VSD 007	200 x 250 x 130				Termo Plastik	18 Adet
VSD 008	230 x 310 x 180				Termo Plastik	16 Adet
NEW VSD 009	120 x 210 x 115				Termo Plastik	50 Adet
VSD 010	140 x 190 x 110				Termo Plastik	İmalatta
VSD 011	140 x 190 x 140				Termo Plastik	İmalatta



Kablo Kanalı / Kutu Ambalaj Cable Trunking / Box Packaging
Кабельные каналы / Упаковка коробки

Kod Code	Ebat Size	Kod Code	Ebat Size	Kod Code	Ebat Size
01201210	12x12 mm	03002010	30x20 mm	08004010	80x40 mm
01501010	15x10 mm	04001610	40x16 mm	08006010	80x40 mm
01601610	16x16 mm	04002510	40x25 mm	10004010	100x40 mm
02001310	20x13 mm	04004010	40x40 mm	10006010	100x60 mm
02501610	25x16 mm	06004010	60x40 mm	12006010	120x60 mm
02502510	25x25 mm	06006010	60x60 mm		

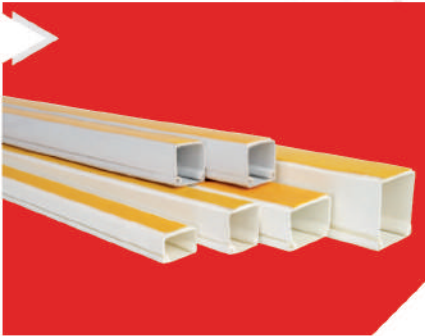

Yapışkan Bantlı Kablo Kanalı Self-Adhesive Cable Trunking
Кабельный канал с клейкой лентой

Kod Code	Ebat Size	Kod Code	Ebat Size
01201211	12x12 mm	03002011	30x20 mm
01501011	15x10 mm	04001611	40x16 mm
01601611	16x16 mm	04002511	40x25 mm
02001311	20x13 mm	04004011	40x40 mm
02501611	25x16 mm		
025002511	25x25 mm		

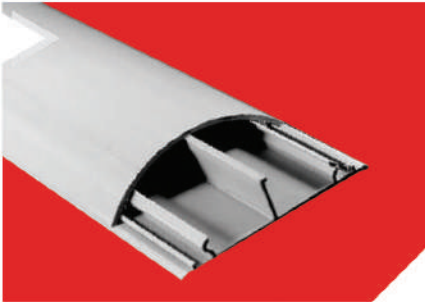

Döşeme Üstü Kablo Kanalları (Balık Sırtı) Floor Type Cable Trunking
Самоклеющийся напольный кабельный канал

Kod / Code	Ebat / Size
05001212	50x12 mm
07002012	70x20 mm
09002012	90x20 mm

Yapışkan Bantlı Döşeme Üstü Kablo Kanalları (Balık Sırtı) Self-Adhesive Floor Type Cable Trunking
Кабельный канал напольный, на несколько отделений, с двухсторонней клейкой лентой

Kod / Code	Ebat / Size
05001213	50x12 mm
07002013	70x20 mm
09002013	90x20 mm

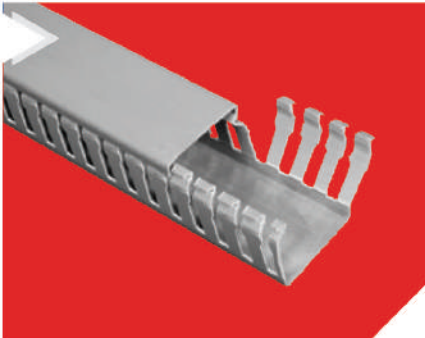

Pano Tipi Kablo Kanalı Panel Type Cable Trunking
Тип панели кабельного канала

Kod / Code	Ebat / Size
02502514	25x25 mm
02504014	25x40 mm
02506014	25x60 mm
04004014	40x40 mm
04006014	40x60 mm
04008014	40x80 mm
06004014	60x40 mm

Kod / Code	Ebat / Size
06006014	60x60 mm
06008014	60x80 mm
08006014	80x60 mm
08008014	80x80 mm
10006014	100x60 mm
10008014	100x80 mm

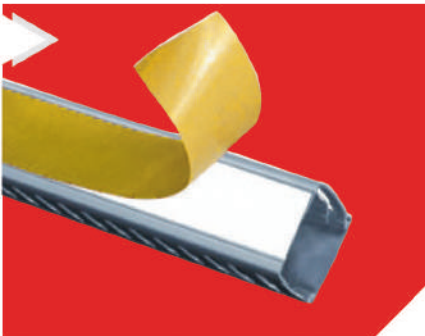

Yapışkan Bantlı Pano Tipi Kablo Kanalı Self-Adhesive Panel Type Cable Trunking
Кабельный канал с двухсторонней клейкой лентой

Kod / Code	Ebat / Size
02502515	25x25 mm
02504015	25x40 mm
02506015	25x60 mm
04004015	40x40 mm
04006015	40x60 mm
04008015	40x80 mm
06004015	60x40 mm

Kod / Code	Ebat / Size
06006015	60x60 mm
06008015	60x80 mm
08006015	80x60 mm
08008015	80x80 mm
10006015	100x60 mm
10008015	100x80 mm

PVC ALEV YAYMAYAN BORULAR

PVC FLAME PIPES

KOD / CODE	AÇIKLAMA / EXPLANATION	AMBALAJ PACKING
07 01 03 016 04	Pvc Boru Alev Yaymayan Boy Boru	3 MT
07 01 03 018 04	Pvc Boru Alev Yaymayan Boy Boru	3 MT
07 01 03 020 04	Pvc Boru Alev Yaymayan Boy Boru	3 MT
07 01 03 025 04	Pvc Boru Alev Yaymayan Boy Boru	3 MT
07 01 03 032 04	Pvc Boru Alev Yaymayan Boy Boru	3 MT



PVC ALEV YAYMAYAN MUFLU BORULAR

PVC FLAME-PROOF PIPES

KOD / CODE	AÇIKLAMA / EXPLANATION	İÇ ÇAP INSIDE	DIŞ ÇAP OUTSIDE	AMBALAJ PACKING
DMYMF 16	16 mm Pvc Rijit Düz Boru Muflu	13.6	16	102
DMYMF 20	20 mm Pvc Rijit Düz Boru Muflu	17.4	20	102
DMYMF 25	25 mm Pvc Rijit Düz Boru Muflu	21.8	25	102
DMYMF 32	32 mm Pvc Rijit Düz Boru Muflu	28.6	32	51



GEÇMELİ TİP ANTİGRON BORU KROŞELERİ

PIPE PLUGS

KOD / CODE	AÇIKLAMA / EXPLANATION	AMBALAJ PACKING
DMYKR 16	16 mm Antigrön Boru Kroşeleri	50
DMYKR 20	20 mm Antigrön Boru Kroşeleri	50
DMYKR 25	25 mm Antigrön Boru Kroşeleri	50
DMYKR 32	32 mm Antigrön Boru Kroşeleri	30
DMYKRK 16	16 mm Antigrön Boru Kroşesi Kapaklı	25
DMYKRK 20	20 mm Antigrön Boru Kroşesi Kapaklı	25
DMYKRK 25	25 mm Antigrön Boru Kroşesi Kapaklı	25



TÜNEL TİP KASA BUATLARI HALOJEN FREE

TUNNEL TYPE FRAME JUNCTIONS HALOGEN FREE

KOD / CODE	AÇIKLAMA / EXPLANATION	PAKET PACKING	AMBALAJ PACKING
DMYD01	Tünel Beton Buat Turuncu	100	1000
DMYD02	Buat Kasası Komple	100	500
DMYD03	Tavan Askı Kasası	100	1000
DMYD04	Kalıba Tespit Elmanı	100	1000
DMYD05	Buat Gövde 60 mm Turuncu	100	1000
DMYD06	Buat Arka Kapak	100	1000
DMYD07	Tavas Askı Kasası Derin Gövde	100	1000
DMYD08	Tespitli Geçmeli Derin Tünel Kasası (Deliksiz)	100	1000
DMYD09	Geçmeli Derin Kasa Turuncu	100	1000

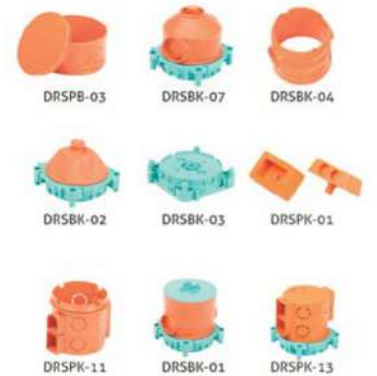

TUĞLA TİP KASA BUATLARI HALOJEN FREE

BRICK TYPE CASE JUNCTIONS HALOGEN FREE

KOD / CODE	AÇIKLAMA / EXPLANATION	PAKET PACKING	AMBALAJ PACKING
DMYDR-01-HF	Tespitli Geçmeli Derin Tünel Kasası (Deliksiz)	100	1000
DMYDR-02-HF	Çift Girişli Yeni Tespit Geçmeli Kasa Turuncu	100	500
DMYDR-03-HF	Çift Girişli Yeni Tespit Geçmeli Kapaklı Turuncu	100	1000
DMYDR-04-HF	Plastik Takoz 16-20 mm Turuncu	100	1000
DMYDR-05-HF	Geçmeli Tip Alçıpan Kasa Turuncu	100	1000
DMYDR-06-HF	Norm Buat Turuncu (Kapaksız)	100	1000
DMYDR-07-HF	Norm Buat Turuncu (Kapaklı)	100	1000
DMYDR-08-HF	Bombeli Lüks Buat Kapağı	100	1000



KASA BUAT ÇEŞİTLERİ (SİYAH)

TYPES OF CASE JUNCTION (BLACK)

KOD / CODE	AÇIKLAMA / EXPLANATION	PAKET PACKING	AMBALAJ PACKING
DMYDR-01-BT	Çift Girişli Yeni Tespit Geçmeli Kasa Siyah	100	1000
DMYDR-02-BT	Çift Girişli Yeni Tespit Geçmeli Kapaklı Siyah	100	500
DMYDR-03-BT	Plastik Takoz 16-20 mm Siyah	100	1000
DMYDR-04-BT	Geçmeli Tip Alçıpan Kasa Siyah	100	1000
DMYDR-05-BT	Norm Buat Turuncu (Kapaksız)	100	1000
DMYDR-06-BT	Norm Buat Turuncu (Kapaklı)	100	1000



PLASTİK DİRSEK (SİYAH)

PLASTIC ELBOW (BLACK)

KOD / CODE	AÇIKLAMA / EXPLANATION	PAKET PACKING	AMBALAJ PACKING
DMYDR 14	14 mm Plastik Dirsek (Siyah)	100	1000
DMYDR 16	16 mm Plastik Dirsek (Siyah)	100	1000
DMYDR 18	18 mm Plastik Dirsek (Siyah)	100	1000
DMYDR 20	20 mm Plastik Dirsek (Siyah)	100	1000
DMYDR 26	26 mm Plastik Dirsek (Siyah)	50	500
DMYDR 32	32 mm Plastik Dirsek (Siyah)	50	500



PLASTİK DİRSEK (RENKLİ)

PLASTIC ELBOW (COLOR)

KOD / CODE	AÇIKLAMA / EXPLANATION	PAKET PACKING	AMBALAJ PACKING
DMYHFDR 14	14 mm Plastik Dirsek (Turuncu)	100	1000
DMYHFDR 16	16 mm Plastik Dirsek (Turuncu)	100	1000
DMYHFDR 18	18 mm Plastik Dirsek (Turuncu)	100	1000
DMYHFDR 20	20 mm Plastik Dirsek (Turuncu)	100	1000
DMYHFDR 26	26 mm Plastik Dirsek (Turuncu)	50	500
DMYHFDR 32	32 mm Plastik Dirsek (Turuncu)	50	500



5100 100'lük Aspirator

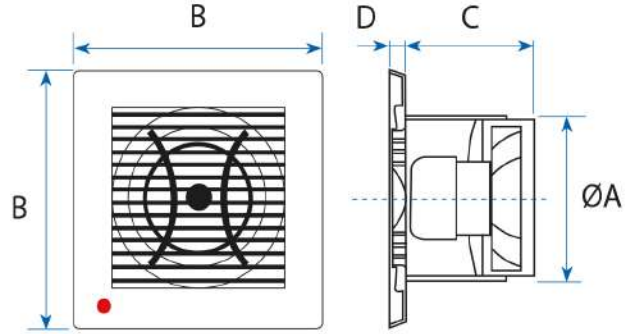

Tip/Type	ØA	B	C	D
5100	99	159	65	13
5120	119	188	76	13
5150	149	220	88	15

5120 120'lik Aspirator

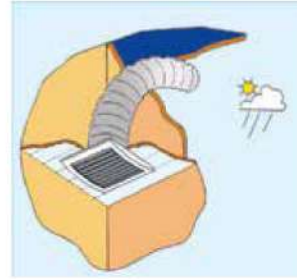

5150 150'lik Aspirator

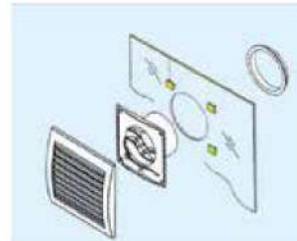
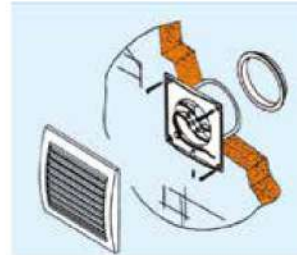

In Box	In Carton	Cartons Weight (kg)	Cartons Volume (m ³)
1	20	15,00	0,1000
1	20	16,00	0,1100
1	20	18,00	0,1100

www.imtelsan.com
Electric & Lighting



imtelsan
electric

www.imtelsan.com

Hamidiye Mah. Sezer Sok. No:4/4
Kağıthane / İstanbul / Türkiye
Tel: +90 212 674 71 51
www.imtelsan.com
info@imtelsan.com