



PT. MITRATAMA CIPTA SOLUSINDO

# CATALOGUE PRODUCT 2026



Let's the time for you to have the right  
product for your office equipment solution

[www.mitratamaciptasolusindo.com](http://www.mitratamaciptasolusindo.com)



PT. MITRATAMA CIPTA SOLUSINDO

# Product List **NON FURNITURE** **2026**



*RELIABLE INFRASTRUCTURE, YOUR BUSINESS IS SAFE*

# DAIKIN

## Ceiling Cassette (FCC)

Menggunakan refrigerant R-32, unit AC ini lebih hemat energi hingga 12% dibandingkan dengan AC R-410A. Selain itu memiliki desain yang ringkas serta instalasi dan perawatan yang mudah.



### HEMAT ENERGI

Refrigeran R32 memiliki kemampuan pemindahan panas lebih baik dibanding R410A. Keunggulan ini memberikan peningkatan efisiensi hingga 12%. Gambar menunjukkan Rasio rata-rata efisiensi penggunaan energi dengan perbedaan refrigerant

### DESAIN UNIT YANG RAMPING

Desain tubuh dengan ketebalan hanya 246mm membuatnya dapat menjadi solusi bagi pemasangan pada ruang langit-langit yang terbatas. Disamping pula memberikan penghematan pada penempatan.



### INSTALASI & PERAWATAN YANG MUDAH

Tiap sudutnya dilengkapi dengan pengatur ketinggian yang memudahkan pengguna melakukan penyesuaian ketinggian sesuai dengan kebutuhan.

Control Box berada pada tempat yang lebih nyaman dan mudah diakses. Tanpa perlu menyesuaikan panel, control box dapat diakses langsung dari grille intake. Hal ini menghemat waktu saat instalasi atau perawatan.



Easy Installation

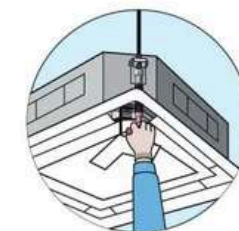

Easy Height Adjustment



Easy Access to Control Box Location



# SECURE

Access control systems secure physical and digital environments by verifying identities and restricting entry. Key features include multi-factor authentication, automated door schedules, and real-time activity logs. These provide direct benefits like data protection, asset security, and regulatory compliance

## Core Features

- **Multi-Factor Authentication (MFA):** Requires users to verify their identity using multiple methods like passwords, security tokens, or biometric scans (e.g., fingerprints)
- **Automated Time Rules:** Locks and unlocks specific doors, elevators, or server rooms based on predetermined dates, times, and role-based permissions
- **Audit Trails & Logs:** Automatically tracks and records real-time data on who entered which area, providing actionable records for forensic investigations



## Key Benefits

- **Enhanced Protection:** Drastically reduces the risk of break-ins, theft, or insider threats by ensuring only authorized personnel are in your spaces.
- **Regulatory Compliance:** Helps organizations meet strict data and privacy regulations (like GDPR or HIPAA) by controlling and documenting exactly who can access sensitive information

# Queue Management System (QMS)

A Queue Management System (QMS) is a digital solution that organizes and optimizes customer flow—replacing chaotic lines with automated check-ins and tracking. It streamlines the waiting experience, allowing customers to check in via kiosk, QR code, or mobile link and wait remotely until they are notified.

## Core Benefits

- **Shorter Perceived Wait Times:** Customers can wait where they prefer (in their car, at home, or browsing a store), which greatly reduces frustration and walk-aways
- **Increased Revenue:** In environments like retail or clinics, virtual waiting allows customers to browse or shop rather than standing stagnant, frequently boosting sales
- **Optimized Staff Efficiency:** Staff are relieved of manual crowd-control, allowing them to focus on delivering personalized, higher-quality service
- **Data-Driven Operations:** Detailed analytics help you identify bottlenecks and schedule the exact number of employees needed during specific hours.

## Key Features

- **Virtual Queuing & Check-in:** Customers can join a waitlist by scanning a QR code or using a self-service kiosk
- **Automated Notifications:** The system sends real-time updates, estimated wait times, and alerts (via SMS or WhatsApp) when it is the customer's turn
- **Centralized Staff Dashboard:** Staff and managers can monitor real-time queue data, route customers to the right service counter, and manage walk-ins from any device.
- **Appointment Scheduling:** Allows visitors to pre-book specific time slots, improving daily resource planning
- **Analytics & Reporting:** Collects data on peak times, service durations, and wait times to help optimize staffing



- The Innovative Curve Flattening Technology
- A Book Scanner with More Versatility
- Intelligent Image Processing Software

# CZUR ET Smart Book Scanner Book Scanning Is as Easy as Turning a Page CZUR ET18 Pro/ET16 Plus Smart Book Scanner



Unlike any other traditional scanners, CZUR ET Smart Book Scanner revolutionizes scanning experience by bringing simple, intelligent and fast scanning performance. All books, magazines, contracts and any paper documents within A3 size can be scanned directly without cutting or unbinding at the speed of 1.5s/scan. All of your scanned documents can be converted to editable Word、PDF、TIFF and Excel via OCR (Optical Character Recognition) function.

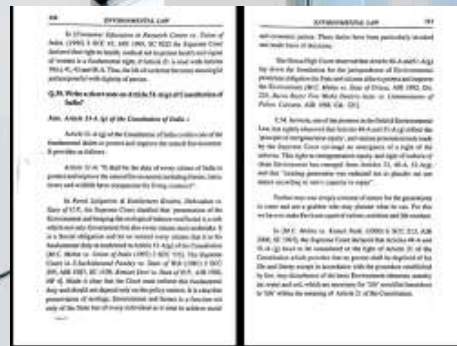
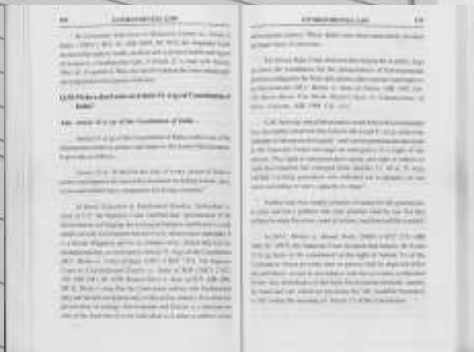

Original Page

CZUR Scan Result





# Product List

# **FURNITURE**

# **2026**



FOR MORE INFORMATION PLEASE CONTACT US :



0812 8616 9937



mitratamacipta@gmail.com

# Table Content



Furniture Fix & Loose



Sofa & Chair



Racking & Metal Product



# Sofa and Chair 2026

## What we do

Comfortable quality sofas designed for office spaces, homes, apartments, hotels and hospitals with ergonomics, durability and aesthetic appeal to improve the quality of life.

Key features include a sturdy, hardwood frame, high-density foam, and durable upholstery materials such as genuine leather, synthetic leather or high-quality fabric.

*Sit back, Relax, and Enjoyed*





## Belden Series

The sofas we make not only provide comfort but also give a classic, elegant and sturdy impression.

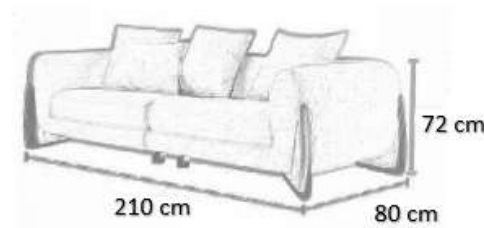

Frame Sofa

Genuine Leather



Faux Leather



Foam Seating



Fabric Upholstery





Available Colors: 



### Belden

LARGE DOUBLE SEAT

 P. 210 cm x L. 80 cm x T. 72 cm

 Specification :  
Wood Frame, Leg Wood Frame fin  
polish, Fabric or genuine leather or  
Faux leather upholstery and good  
density foam



### Belden

SINGLE SEAT

 P. 85 cm x L. 80 cm x T. 72 cm

 Specification :  
Wood Frame, Leg Wood Frame fin  
polish, Fabric or genuine leather or  
Faux leather upholstery and good  
density foam



### Belden

STOOL SEAT

 P. 55 cm x L. 55 cm x T. 45 cm

 Specification :  
Wood Frame, Leg Wood Frame fin  
polish, Fabric or genuine leather or  
Faux leather upholstery and good  
density foam



## Sermo Series

The sofas we make not only provide comfort but also give a classic, elegant and sturdy impression.

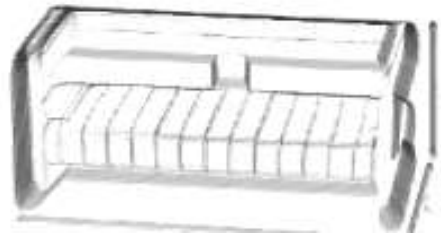

Genuine Leather



Faux Leather



Foam Seating



Fabric Upholstery





Available Colors: A row of six circular color swatches: dark grey, light grey, yellow, orange, light blue, and brown.



### Sermo

LARGE DOUBLE SEAT

 P. 150 cm x L. 70 cm x T. 72 cm

 Specification :  
Wood Frame, Fabric or genuine leather or Faux leather upholstery and good density foam



### Sermo

SINGLE SEAT

 P. 76 cm x L. 70 cm x T. 72 cm

 Specification :  
Wood Frame, Fabric or genuine leather or Faux leather upholstery and good density foam

Available Colors: A row of six color swatches: dark brown, light grey, yellow, orange, light blue, and medium brown.



### Oval

 P. 50 cm x L. 49 cm x T. 72 cm

 Specification :  
Wood Frame, Leg Iron fin Coating,  
Fabric or genuine leather or Faux  
leather upholstery and good density  
foam



### Talens

 Ø dia 50 cm x T. 72 cm

 Specification :  
Wood Frame, Leg Iron fin Coating,  
Fabric or genuine leather or Faux  
leather upholstery and good density  
foam



### Orbite

 P. 50 cm x L. 50 cm x T. 45 cm

 Specification :  
Wood Frame, Leg Wood Frame fin  
polish, Fabric or genuine leather or  
synthetic leather upholstery and  
good density foam



### Woody

 P. 50 cm x L. 49 cm x T. 72 cm

 Specification :  
Wood Frame, Leg Wood Frame  
fin polish, Fabric or genuine  
leather or synthetic leather  
upholstery and good density  
foam



### Zetta

 P. 65 cm x L. 78cm x T. 75 cm

 Specification :  
Wood Frame, Leg Iron fin Coating,  
Fabric or genuine leather or Faux  
leather upholstery and good density  
foam



### Whelton

 P. 55 cm x L. 59 cm x T. 77 cm

 Specification :  
Wood Frame, Leg Wood Frame  
fin polish, Fabric or genuine  
leather or synthetic leather  
upholstery and good density  
foam



### Iconic

 P. 68 cm x L. 78 cm x T. 75 cm

 Specification :  
Wood Frame, Leg Iron fin Coating,  
Fabric or genuine leather or Faux  
leather upholstery and good density  
foam



### Ibox one

 P. 70 cm x L. 78cm x T. 75 cm

 Specification :  
Wood Frame, Leg Iron fin Coating,  
Fabric or genuine leather or Faux  
leather upholstery and good density  
foam



### Ibox Three

 P. 210 cm x L. 78 cm x T. 75 cm

 Specification :  
Wood Frame, Leg Iron fin Coating,  
Fabric or genuine leather or Faux  
leather upholstery and good density  
foam



### Terra Bench

 P. 150 cm x L. 40 cm x T. 45 cm

 Specification :  
Wood Frame, Leg Iron fin  
Coating, Fabric or genuine  
leather or Faux leather  
upholstery and good density  
foam

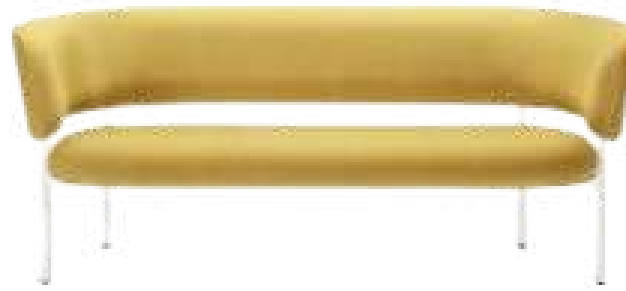

### Curve Bench

 P. 150 cm x L. 50 cm x T. 70 cm

 Specification :  
Wood Frame, Leg Iron fin  
Coating, Fabric or genuine  
leather or Faux leather  
upholstery and good density  
foam



### Luxe Bench

 P. 150 cm x L. 40 cm x T. 45 cm

 Specification :  
Wood Frame, Leg Iron fin  
Coating, Fabric or genuine  
leather or Faux leather  
upholstery and good density  
foam

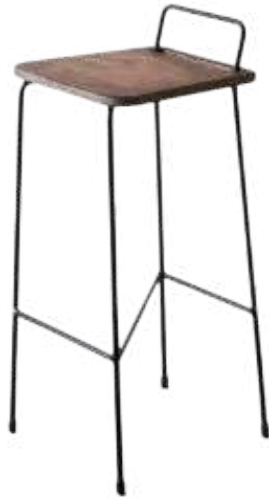

### Retro

 P. 36 cm x L. 39 cm x T. 70 cm

 Specification :  
Wood Frame, Leg Iron fin  
Coating, Fabric or genuine  
leather or Faux leather  
upholstery and good density  
foam



### Classic

 P. 36 cm x L. 36 cm x T. 70 cm

 Specification :  
Wood Frame, Leg Iron fin  
Coating, Fabric or genuine  
leather or Faux leather  
upholstery and good density  
foam



### Up Down

 dia 34 cm x T. 65 cm

 Specification :  
Wood Frame, Leg Iron fin  
Coating, Fabric or genuine  
leather or Faux leather  
upholstery and good density  
foam

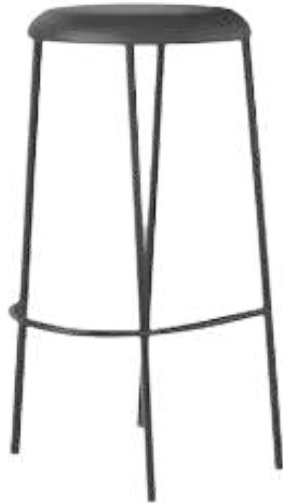

### Cafe



P. 36 cm x L. 39 cm x T. 70 cm



Specification :  
Wood Frame, Leg Iron fin Coating,  
Fabric or genuine leather or Faux  
leather upholstery and good density  
foam

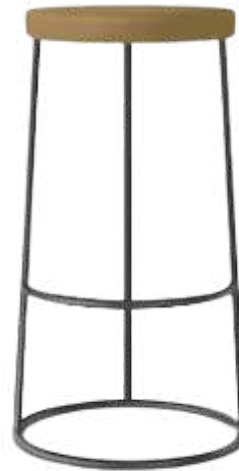

### Satelite



P. 36 cm x L. 39 cm x T. 70 cm



Specification :  
Wood Frame, Leg Iron fin Coating,  
Fabric or genuine leather or Faux  
leather upholstery and good density  
foam



### Ufo



dia 36 cm x T. 45 cm



Specification :  
Wood Frame, Leg Wood fin polish,  
Fabric or genuine leather or Faux  
leather upholstery and good  
density foam



### Lounge

LARGE DOUBLE SEAT



P. 210 cm x L. 85 cm x T. 82 cm



Specification :

Wood Frame, Leg Wood fin polish,  
Fabric or genuine leather or Faux  
leather upholstery and good density  
foam



### Luna

LARGE DOUBLE SEAT



P. 210 cm x L. 85 cm x T. 82 cm



Specification :

Wood Frame, Leg Wood fin polish,  
Fabric or genuine leather or Faux  
leather upholstery and good density  
foam



### Lumina

LARGE DOUBLE SEAT



P. 210 cm x L. 80 cm x T. 73 cm



Specification :

Wood Frame, Leg Wood fin polish,  
Fabric or genuine leather or Faux  
leather upholstery and good density  
foam



### Victoria

LARGE DOUBLE SEAT

 P. 210 cm x L. 80 cm x T. 75 cm

 Specification :  
Wood Frame, Leg Wood fin polish,  
Fabric or genuine leather or Faux  
leather upholstery and good density  
foam



### Urban

LARGE DOUBLE SEAT

 P. 210 cm x L. 80 cm x T. 75 cm

 Specification :  
Wood Frame, Leg Iron fin Coating,  
Fabric or genuine leather or Faux  
leather upholstery and good density  
foam



### Neo

 P. 85 cm x L. 80 cm x T. 75 cm

 Specification :  
Wood Frame, Leg Wood fin polish,  
Fabric or genuine leather or Faux  
leather upholstery and good density  
foam



## Custom Bench



Customize Dimension



Specification :

Wood Frame, Leg Wood Frame  
fin HPL, Fabric or genuine  
leather or synthetic leather  
upholstery and good density  
foam



Available Colors: 



## What we do

Elevate Your Office Aesthetic with Our Modern which can be adjusted to your budget but still has good quality standards.

Adapt your workspace on the fly. Designed for dynamic teams, these modular setups expand and reconfigure to fit your growing business."

# Furniture 2026

Configure your desk and  
Shop the Collection today



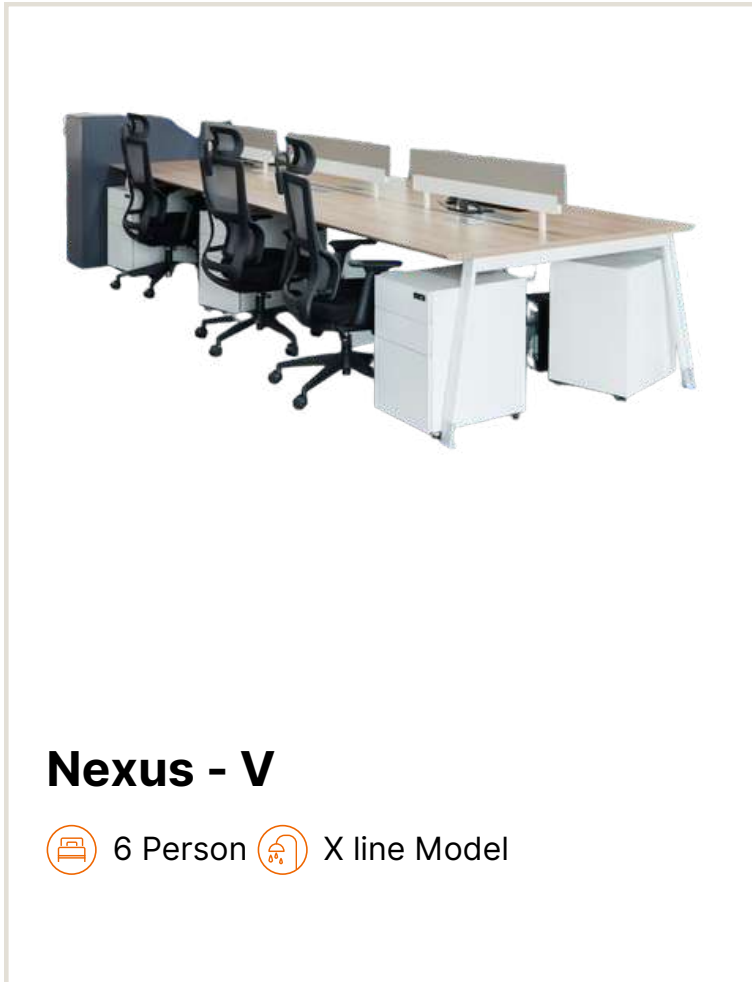

Product Specifications:  
 Openspace Desking System Work Desk, 3 Person  
 Xrossline Configuration, Material MDF Finishing  
 HPL (ex TACO), Iron table legs finishing coating

Standard size:  
 L. 3600 mm x W. 1200 mm x H. 750 mm

Note: serves custom products

Coating Colour option

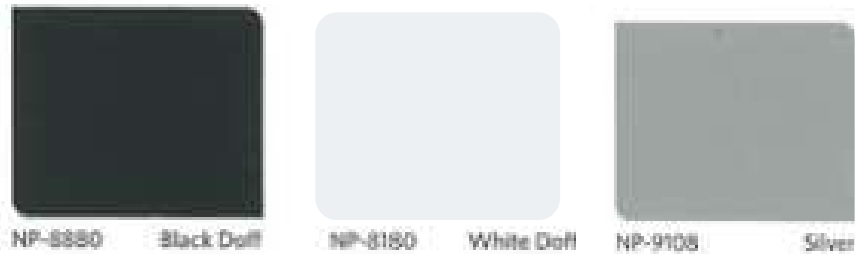

HPL option





Product Specifications:  
 Openspace Desking System Work Desk, 2 Person  
 Crossline Configuration, Material MDF Finishing  
 HPL (ex TACO), Iron table legs finishing coating

Standard size:  
 L. 2400 mm x W. 1200 mm x H. 750 mm

Note: serves custom products

HPL option



Coating Colour option

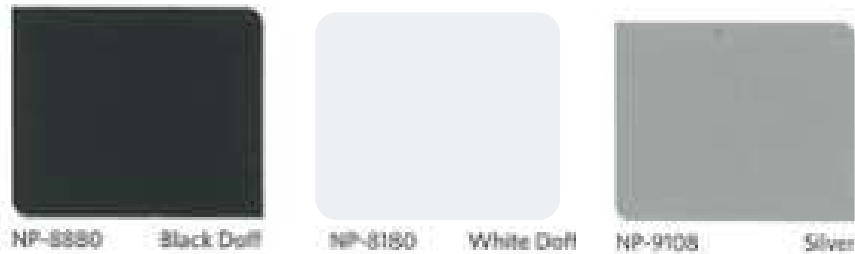



**Product Specifications:**

Openspace Desking System Work Desk, 3 Person  
 Xrossline Configuration, Material MDF Finishing  
 HPL (ex TACO), Iron table legs finishing coating

**Standard size:**

L. 3600 mm x W. 1200 mm x H. 750 mm

Note: serves custom products

**Coating Colour option**



NP-8880 Black Doff

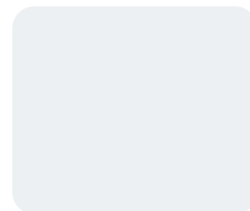

NP-8180 White Doff

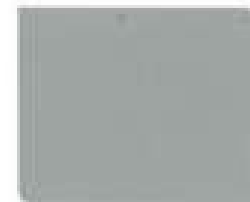

NP-9108 Silver

**HPL option**



TH-102 AA  
Elite Pear



TH-109 AA  
Spice Cherry



TH-110 AA  
Sim Echo



TH-120 AA  
Powdered



TH-131 AA  
Treap Wood



TH-154 AA  
Cream



TH-317 AA  
Brilliant Teak

## Executive - V



 Manager Desk

 Model L Shafe

### Product Specifications:

Executive Manager Desk with L-Shafe Configuration, Material option MDF/Multiplex board/Blockboard/Partikelboard with Finishing HPL (ex TACO), Iron table legs finishing coating.

### Standard size:

L. 1500 mm x W. 1500 mm x H. 750 mm

Note: serves custom products



Vice Cabinet/ L Shafe

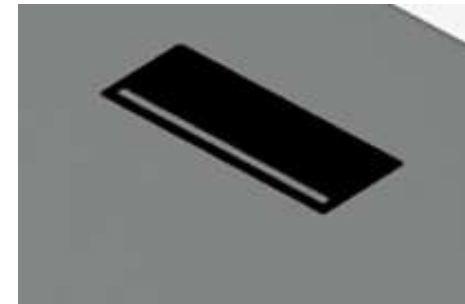

Wire Box



Vertical Wire Line

### Executive - V/ L Shafe

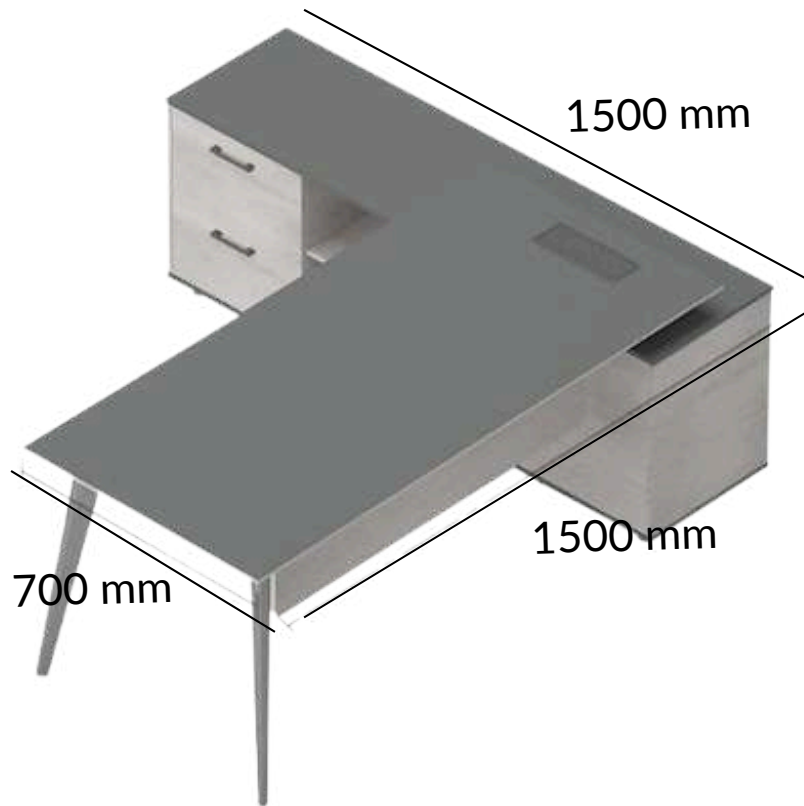

✓ E1 environmental protection sheet



✓ 25mm thick board



### Coating Colour option



NP-8880 Black Doff

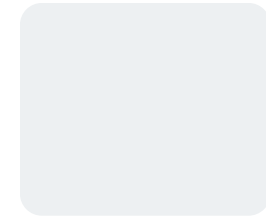

NP-8180 White Doff

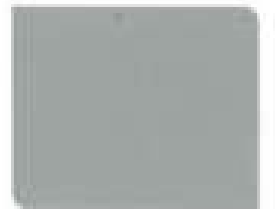

NP-9108 Silver

### HPL option

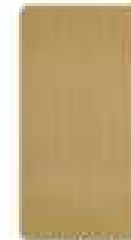

TH-102 AA  
Elite Pear

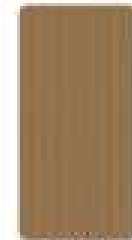

TH-103 AA  
Spice Cherry



TH-110 AA  
Slim Echo



TH-120 AA  
Powdered



TH-131 AA  
Teap Wood



TH-154 AA  
Cream



TH-217 AA  
Brilliant Teak

## Execuitve - Box



 Manager Desk

 Model L Shafe

### Product Specifications:

Executive Manager Desk with L-Shafe Configuration, Material option MDF/Multiplex board/Blockboard/Partikelboard with Finishing HPL (ex TACO), Iron table legs finishing coating.

### Standard size:

L. 1500 mm x W. 1500 mm x H. 750 mm

Note: serves custom products



Vice Cabinet/ L Shafe

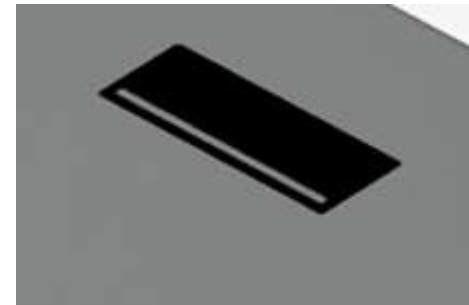

Wire Box



Vertical Wire Line

## Executive - Box / L Shafe

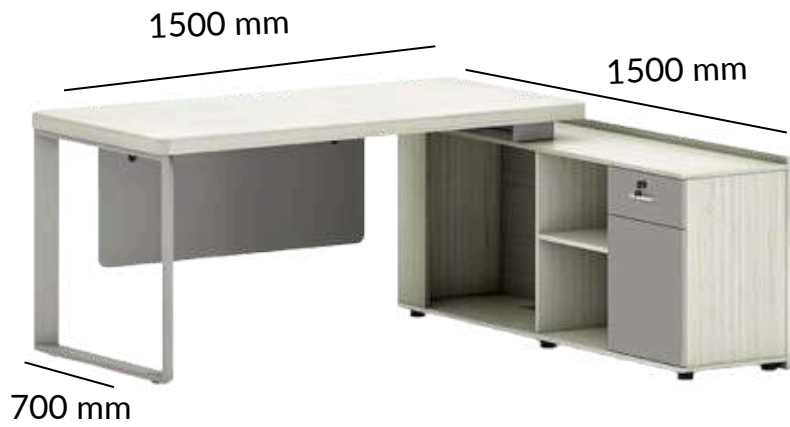

### Coating Colour option

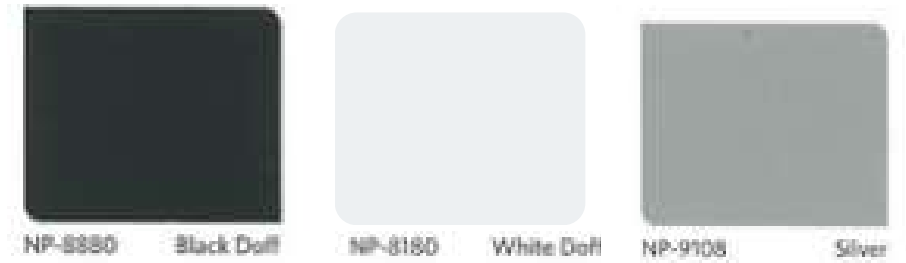



### HPL option



## Executive - U



 Manager Desk

 Model L Shafe

### **Product Specifications:**

Executive Manager Desk with L-Shafe Configuration, Material option MDF/Multiplex board/Blockboard/Partikelboard with Finishing HPL (ex TACO), Iron table legs finishing coating.

### **Standard size:**

L. 1500 mm x W. 1500 mm x H. 750 mm

Note: serves custom products



Vice Cabinet/ L Shafe

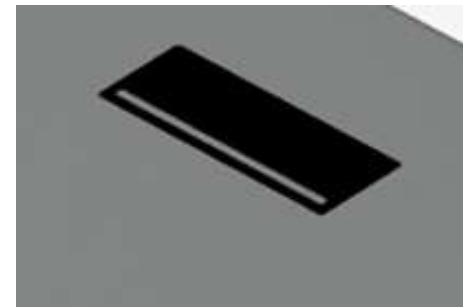

Wire Box



Vertical Wire Line

## Executive - U / L Shafe

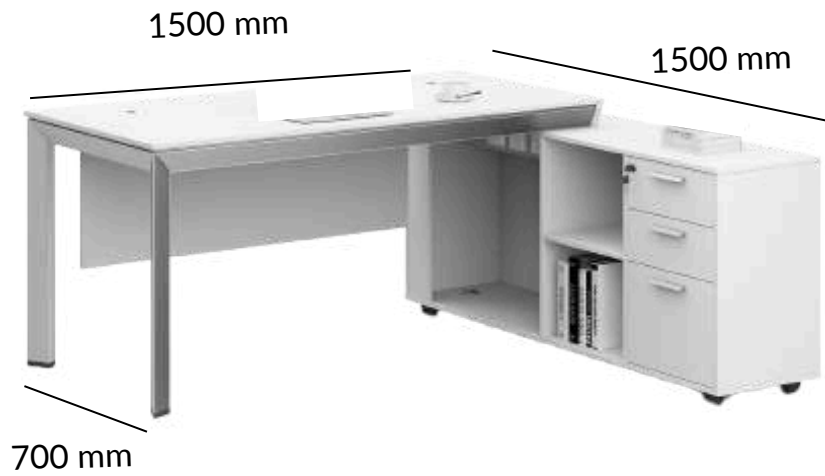

### Coating Colour option

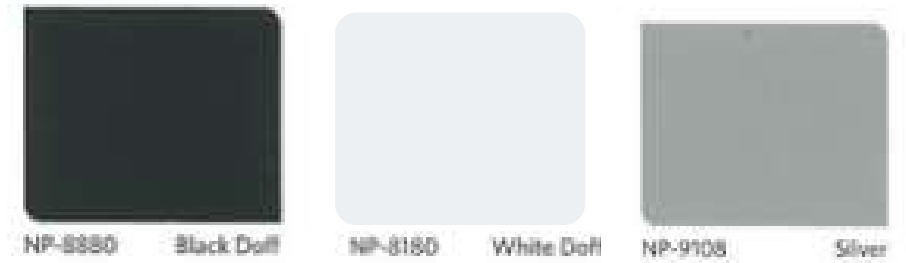

### HPL option





Product Specifications:  
 Credenza File type, Material MDF/Multiplex,  
 Blockboard or Partikelboard Finishing HPL  
 (ex TACO)

Standard size:  
 L. 2400 mm x W. 40 mm x H. 750 mm

Note: serves custom products

HPL option



TH-102 AA  
Elite Pear



TH-103 AA  
Spice Cherry



TH-110 AA  
Sim Echo



TH-120 AA  
Powdered



TH-131 AA  
Teak Wood



TH-154 AA  
Cream



TH-317 AA  
Brilliant Teak



## Cupboard - CBD 400

 Wood Cupboard

 Model Cuctome

### Product Specifications:

Cupboard File type, Material MDF/Multiplex,  
Blockboard or Partikelboard Finishing HPL (ex TACO)

### Standard size:

P. 4000 mm x L. 400 mm x T. 2000 mm

Note: serves custom products

### HPL option



TH-102 AA  
Elite Pear



TH-103 AA  
Spice Cherry

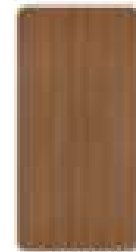

TH-110 AA  
Sim Echo



TH-120 AA  
Powdered



TH-131 AA  
Teak Wood



TH-154 AA  
Cream



TH-317 AA  
Brilliant Teak



# Racking and Metal 2026

## What we do

**Problem :**

Stocks are piling up but the old shelves are starting to sag?

**Our we do :**

Don't take the risk! Upgrade to our Heavy Duty Shelves. Each layer is strong enough to withstand loads of up to 2 tons .

**Problem :**

Small warehouse solution!

**Our we do :**

Maximize storage capacity without needing to rent a new warehouse. Our modular system can be adapted to your space needs."

## Easier, Longer, More Meaningful



## Compacto



Datascrip Compacto (also known as a mobile file system or roll o pack) is a high-density archive storage solution. It mounts shelving units on tracks, eliminating the need for multiple fixed aisles and allowing units to compact tightly together, maximizing document organization and saving up to 50% of floor space



## Compacto Features & Benefit

### Key Features

- **Track-and-Glider System:** The cabinets are fitted on sturdy tracks embedded in the floor, allowing them to glide smoothly side-to-side.
- **Drive Mechanisms:** Available in Manual (pushed by hand), Mechanical (operated using a wheel/hand-crank and gear system for effortless movement), and Motorized/Electric (automated motor and control buttons).
- **Heavy-Duty Materials:** Constructed from high-quality, powder-coated steel to support heavy box and folder loads without warping.
- **Central Locking System:** Equipped with master keys or central locks to ensure all compacted units are secured, providing high-level confidentiality.
- **Index Holders:** Built-in slots on the cabinet faces to allow quick tagging, categorizing, and locating of files.

### Primary Benefits

- **Maximum Space Efficiency:** By requiring only one active aisle at a time, it condenses storage and frees up to 50% of your room's footprint compared to standard lateral filing cabinets.
- **High-Capacity Storage:** Ideal for banks, hospitals, schools, and corporate offices dealing with large, expanding volumes of paper files and archives.
- **Enhanced Security:** Prevents unauthorized access or tampering with documents, as locked units keep sensitive materials fully enclosed.
- **Improved Organization:** Groups files logically on adjustable shelves, drastically reducing the time staff spends searching for specific records.
- **Scalable Setup:** Units like the [FIRM Double Mobile DM1020](#) can be added over time as your physical archiving needs scale







### Compacto / Mobile File Specifications

- Standard Overall Dimensions (H x W x L):
  - Typically 220 × 100 × 250 - 320 cm (for multi-bay mechanical or manual systems).
- Single Bay / Modular Dimensions:
  - Individual units (such as the S6 series) generally measure around 91.5 cm (Length) × 39.5 cm (Depth) × 205 cm (Height) for single-sided units, and 91.5 cm (L) × 79.5 cm (D) × 205 cm (H) for double-sided units.
- Material:
  - Heavy-duty steel sheet with a powder-coated finish.
- Operation Systems:
  - Manual push/pull handle or mechanical sprocket/chain drive for smooth movement along floor tracks.

## Racking



-  Light Duty Racking
-  Selective Pallet Racking
-  Double Deep Racking
-  Drive In Racking

### Product Specifications:

1. Light Duty Rack (Light Load Rack) Loading Capacity: Up to 300 kg per shelf level. Material: Steel frame equipped with decking. Use: Ideal for manual storage of goods (man to product) in ground floor areas and moderate operational needs.
2. Selective Pallet Racking Accessibility: Provides direct access to each pallet without having to move another pallet (100% selectivity). Standard Sizes: Rack depths are generally 36" to 48", and heights range from 8 feet to 24 feet (or more). Use: The most common and flexible system for various types of warehousing.
3. Double Deep Racking Capacity: Increases space density by storing double-deep pallets on each side of an aisle. Efficiency: Reduces the number of aisles required, thereby increasing overall storage capacity.
4. Drive-in Rack Capacity: Designed to be very dense (high-density) to obtain maximum storage capacity. How it Works: The forklift can enter directly into the rack line to pick up or place pallets.
5. Mezzanine Rack Function: Creates an additional floor in a warehouse building. Use: Very effective for maximizing vertical space to get additional area that can be used as storage, work area or office.

### Standard size:

P. 2500 mm x L. 1000 mm x T. 4000 mm

Note: serves custom products

# UPRIGHT SIZING

Standard for Most Pallet Racking Styles

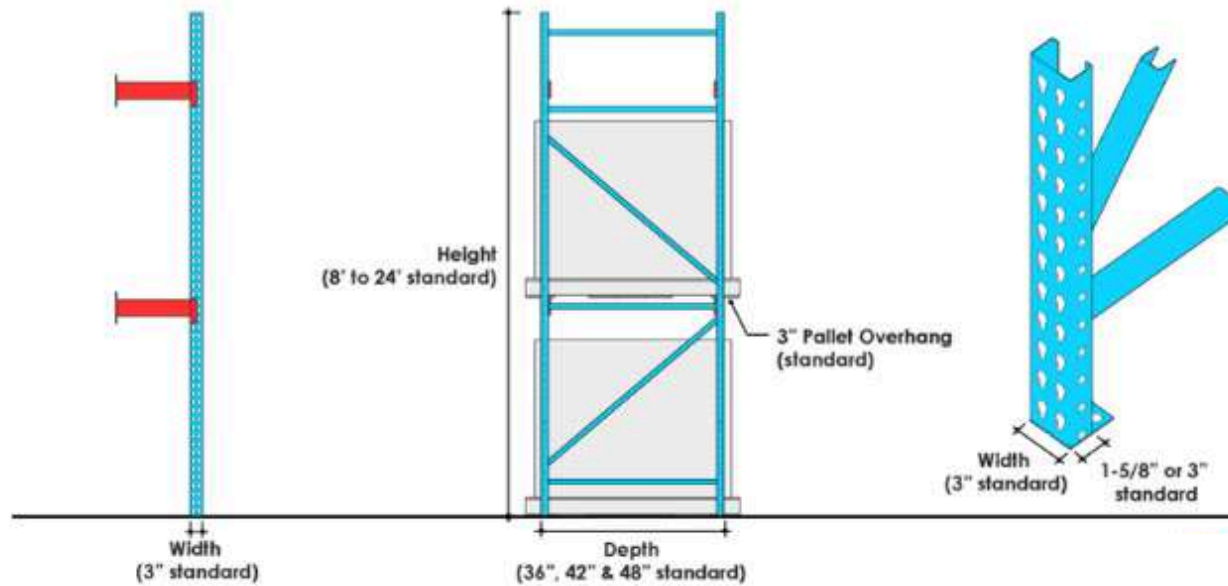

Front View



Side View

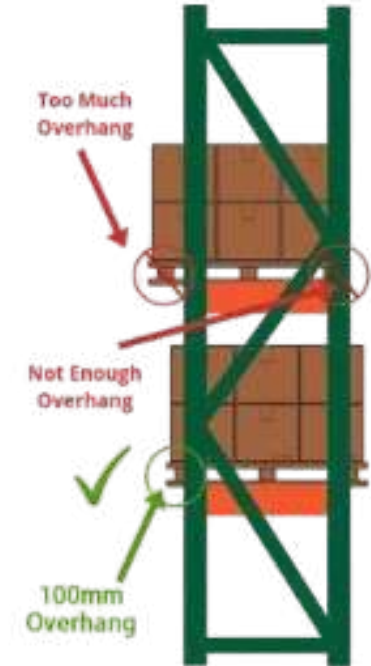



PT. MITRATAMA CIPTA SOLUSINDO

# Contact Us

## Office

Grand Galaxy Park, RSN2 No. 60  
Jl. Boulevard Raya , Jaka Setia  
Bekasi Selatan, Jawa Barat 17147

## Phone

021 82733010  
0812 8616 9937

## Workshop :

Jl. Bojong Kulur Raya 40,  
JatiAsih, Bekasi

## Email

[sales@mitratamaciptasolusindo.com](mailto:sales@mitratamaciptasolusindo.com)  
[mitratamacipta@gmail.com](mailto:mitratamacipta@gmail.com)



[www.mitratamaciptasolusindo.com](http://www.mitratamaciptasolusindo.com)