



RONDO-160

Frameless ventilation diffuser

Technical specification



reddot winner 2023

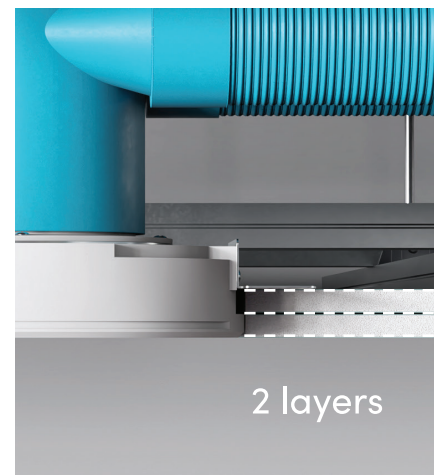
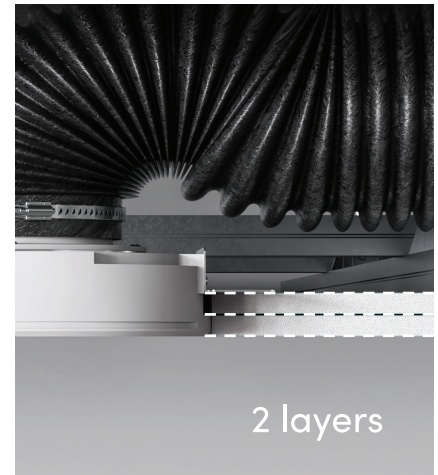
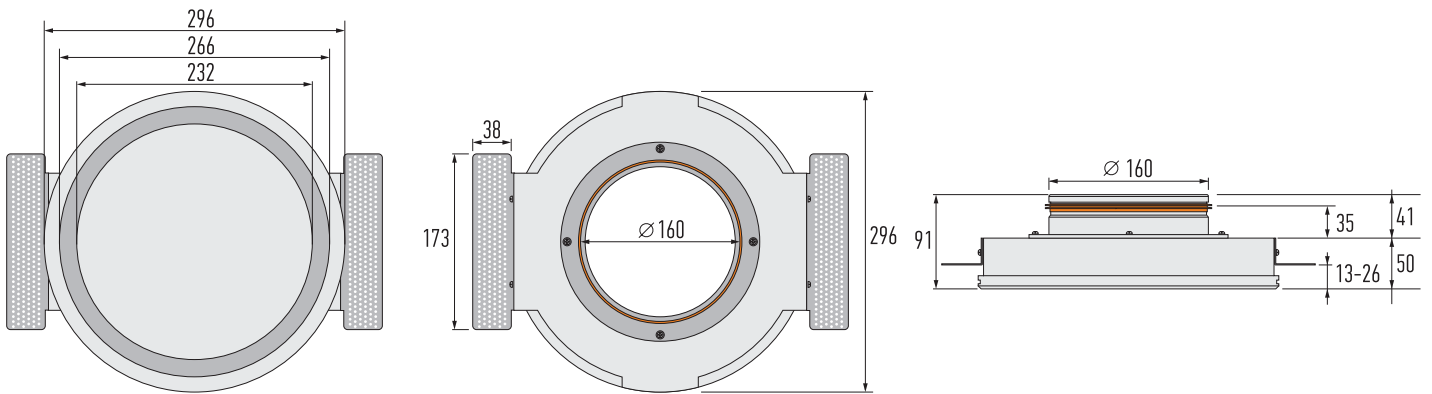

RONDO-160

Technical data

RONDO 160 (supply air)

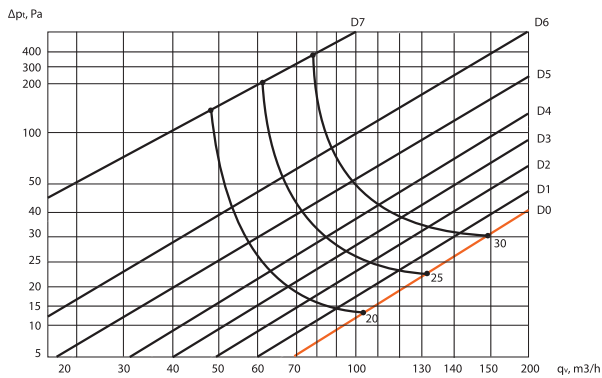

RONDO 160 (exhaust air)

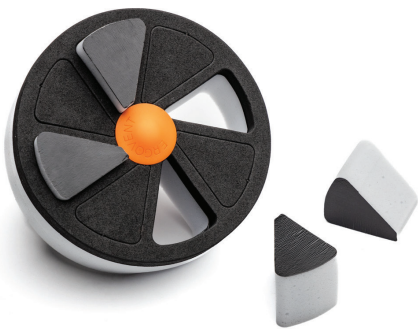
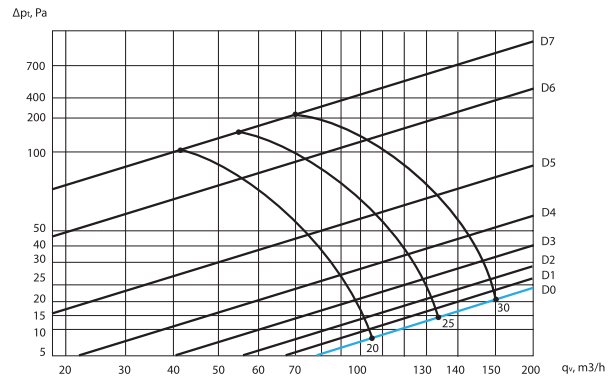

Polyurethane dampers are used to adjust the airflow.

- D0 – no damper inserted
- D1 – 1 segment inserted
- D2 – 2 segments inserted
- D3 – 3 segments inserted
- D4 – 4 segments inserted
- D5 – 5 segments inserted
- D6 – 6 segments inserted
- D7 – 7 segments inserted

RONDO 160
velocity, m/s

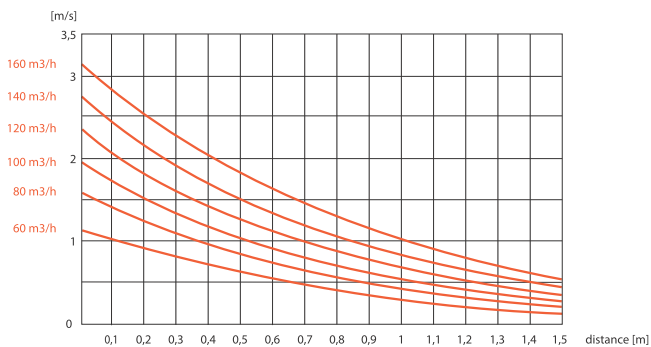

Scan QR code to download the installation instructions.