

SOLiSENZ

CSZ V3.0

User Manual

Centrate TSS Measurement System

Document Information

Document:	SOLiSENZ CSZ V3.0 User Manual
Version:	202604
Date:	April 2026
Manufacturer:	SOLiSENZ B.V.

Table of Contents

Table of Contents.....	2
1. Introduction	4
2. Safety Regulations.....	5
2.1 Intended Use	5
2.2 Responsibility	5
2.3 User Qualifications	5
2.4 Hazard Warnings	5
2.5 Internal Safety Measures	6
2.5.1 Emergency Stop Switch	6
2.5.2 Acid Shielding	6
2.5.3 Sample pump power readout	6
2.5.4 Service Mode button.....	6
2.5.5 Safe height of Acid Enclosure	6
3. Technical Description	7
3.1 Electrical Upper enclosure	7
3.1.1 Circuit Breakers	7
3.1.2 Ultrasonic Generator	7
3.2 Wetted Lower enclosure	8
3.2.1 TSS Sensor	8
3.2.2 Centrate Sample pump.....	8
3.2.3 Ultrasonic Device.....	8
3.2.4 Centrate Air Diffuser	8
3.2.5 Cleaning valves	8
3.2.6 Manual drain valves.....	8
3.3 Acid enclosure.....	9
3.3.1 Acid Pump	9
3.3.2 Level Sensor.....	9
3.4 Technical Specifications.....	10
System	10
Sensor	10
Sample Pump	10
PLC/HMI	10
3.5 Dimensions and Cleaner Enclosure.....	11
3.6 Installation Recommendations	11
General	11
Signal & Communication	11
Sample Connections	11
In- and Output Specifications	12
3.7 Installation of Acid Enclosure	13
General	13
Electrical	13
4. Software PLC/HMI	14

4.1 Main Screen	14
Main Screen States	14
4.2 Login.....	16
4.3 Graphs.....	16
Adjusting the Measurement Range	16
Timeframe.....	16
Historical Readings.....	16
4.4 Settings	16
4.4.1 Cleaning.....	17
4.4.2 Cleaning Options	19
4.4.3 Timing	19
4.4.4 Calibration	19
4.4.5 Alarms Settings	21
4.4.6 Data Output	21
4.4.7 Counters	21
4.4.8 Advanced Settings.....	21
5. Alarms	22
5.1 Alarm Summary Screen	22
5.2 Alarm History	23
5.3 Errors.....	24
6. Troubleshooting	25
7. Maintenance	26
7.1 Preventive Maintenance Schedule	26
7.2 Manual Cleaning of the TSS Sensor.....	27
7.3 Replacing the Acid Vessel	28
7.4 Dust Filter Check / Exchange	28
8. Modbus TCP Communication.....	29
8.1 Key Parameters	29
8.2 Function Code 01 - Coil Registers (Read/Write).....	29
8.3 Function Code 03 - Holding Registers	29
9. Electrical Connections	30
9.1 Terminal strip.....	30
9.1 Enclosure connections and cable glands.....	31
10. Parts List	32
Parts	32
11. Spare Parts.....	32

1. Introduction

The SOLiSENZ CSZ V3.0 has been developed to reliably measure TSS (Total Suspended Solids) in centrate/rejection water from sludge dewatering processes. The unique composition ensures reliable long-term TSS measurement in these challenging wastewater streams.

Key features of the SOLiSENZ CSZ V3.0:

- Robust peristaltic pump ensuring continuous sample flow
- Double automatic cleaning system for a continuously clean measurement cell
- Ultrasonic sample conditioning to remove microbubbles from the centrate
- Optical dual-channel TSS sensor at 880nm wavelength (ISO accepted method)
- Stainless steel IP65 enclosure for demanding industrial environments
- PLC with 5" colour touchscreen for easy operation
- Modbus TCP communication for SCADA integration

The stable measurement is achieved within 60 to 90 seconds from sample feed. The entire system is controlled by a PLC that can be operated via the touchscreen. The clear user interface allows the operator to adapt the system to their specific installation requirements.

Disclaimer

Despite carefully compiling this manual, errors may occur. SOLiSENZ is not responsible for loss of data or damage as a result. If any situations arise that are not covered in this manual, contact the service party or the supplier.

2. Safety Regulations

2.1 Intended Use

The SOLiSENZ CSZ V3.0 has been developed exclusively to reliably measure TSS in centrate/rejection water from sludge dewatering. It is not recommended to use the SOLiSENZ CSZ for other applications. The SOLiSENZ CSZ has a target lifespan of ten years, subject to the condition that maintenance is carried out in a timely manner and that the system is handled correctly.

2.2 Responsibility

Despite carefully compiling this manual, errors may occur. SOLiSENZ is not responsible for loss of data or damage as a result. If any situations arise not covered in this manual, contact the service department or the supplier.

2.3 User Qualifications



QUALIFIED PERSONNEL ONLY

The installation, operation, and maintenance of the SOLiSENZ CSZ V3.0 must only be carried out by qualified personnel. Personnel must be trained by SOLiSENZ and must be in possession of this manual.

2.4 Hazard Warnings

The following safety pictograms are used in this manual and on the SOLiSENZ CSZ V3.0. Always follow the instructions associated with these pictograms:

	GENERAL WARNING - Be extra alert to hazards near parts displaying this icon. On the SOLiSENZ CSZ V3.0 this icon is located on: PLC/HMI enclosure, Sensor enclosure, and Sample Conditioning enclosure. Only qualified, trained personnel may work in these areas.
	ELECTRICAL HAZARD - This icon warns of dangerous electrical voltage. On the SOLiSENZ CSZ V3.0 this hazard is present inside the PLC/HMI, Sensor enclosure, and Sample Conditioning enclosure. Only qualified electricians may work in these areas.
	BIOLOGICAL HAZARD - This pictogram warns of biological hazards from wastewater substances in the sensor and sample conditioning areas. Wear appropriate PPE at all times when handling wastewater.
	CORROSIVE SUBSTANCE - This pictogram warns of corrosive substances (hydrochloric acid) located in the Sensor enclosure. Always wear gloves and safety glasses when handling. Only trained personnel may replace the acid vessel.
	ROTATING PARTS - This pictogram warns of rotating parts that may entrap limbs. Located near the pump area. Keep clear of rotating parts during operation.
	PROTECTIVE GLOVES REQUIRED - Mandatory PPE when working on the Sensor enclosure, Sample Conditioning enclosure, and Cleaning enclosure. Chemical-resistant gloves must be worn when working with the acid system.
	SAFETY GOGGLES REQUIRED - Mandatory PPE when opening and working on the Sensor enclosure, Sample Conditioning enclosure, and Cleaning enclosure. Splashing of corrosive or biological substances is possible.



CONSULT MANUAL - Mandatory requirement to consult the user manual before performing any operation. Located on the PLC/HMI enclosure, Sensor enclosure, and Sample Conditioning enclosure.

2.5 Internal Safety Measures

The SOLiSENZ CSZ V3.0 has several live electrical parts and potential dangerous situations. The following built-in safety measures protect the operator:

2.5.1 Emergency Stop Switch

An emergency stop switch is located on the SOLiSENZ CSZ V3.0 and disconnects all power from the system. In unsafe situations, the system can be safely shut down without opening any enclosure.

2.5.2 Acid Shielding

The acid tubes in the SOLiSENZ CSZ V3.0 are double shielded. Any damage on the acid tube could not directly harm anyone when working in the stainless steel enclosure of the CSZ.

2.5.3 Sample pump power readout

The power usage of the sample pump is been constantly monitored to ensure no over pressured system. If there is any clogging in the system and pressure builds up, the centrate sample pump will shut down and the system will stop.

2.5.4 Service Mode button

An Service Mode button is in the top of the main screen of the SOLiSENZ CSZ V3.0 shuts down all moving parts.

2.5.5 Safe height of Acid Enclosure

The acid enclosure is designed separately from the SOLiSENZ CSZ 3.0 stainless steel enclosure. The customer has now the possibility to mount the acid enclosure and thus the acid vessel on a safe height

3. Technical Description

The SOLiSENZ CSZ V3.0 is a centrate TSS measurement with two enclosures. The system consists of three main components:

1. Electrical Upper enclosure
2. Wetted Lower enclosure
3. Acid Enclosure

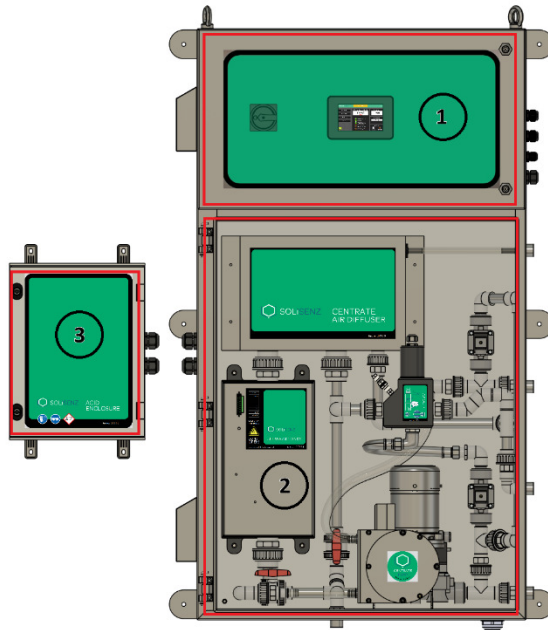

Fig. 3.1 - System overview

3.1 Electrical Upper enclosure

The electrical upper enclosure is the primary electrical enclosure of the SOLiSENZ CSZ V3.0. It contains the circuit breakers, power supply and ultrasonic generator.



ELECTRICAL HAZARD - QUALIFIED ELECTRICIANS ONLY

Opening the Electrical Upper Enclosure should only be done by a qualified and certified electrician. Always de-energize and lock out/tag out the system before making or modifying electrical connections.

3.1.1 Circuit Breakers

There are three circuit breakers in the electrical enclosure:

- 100F4 - C2 circuit breaker - Centrate Sample pump
- 100F6 - C4 circuit breaker - Ultrasonic Generator
- 300F2 - C2 circuit breaker - 24VDC power supply (HMI/PLC)

3.1.2 Ultrasonic Generator



DO NOT ADJUST - PRESET BY SUPPLIER

The ultrasonic generator is pre-set by the supplier and must not be adjusted. Incorrect settings will damage the ultrasonic transducer. The generator can be accessed by tilting the electrical mounting plate forward (secured by a hand-removable bolt). Only qualified personnel may access this component.

3.2 Wetted Lower enclosure

The wetted lower enclosure is the primary measurement enclosure of the SOLiSENZ CSZ V3.0. It contains the TSS measurement system with the following components:

- TSS Sensor + Flowcell
- Centrate Sample pump
- Ultrasonic Device
- Centrate Air Diffuser
- Cleaning Valves

3.2.1 TSS Sensor

The SOLiSENZ CSZ V3.0 uses a low-range dual-channel optical TSS sensor. Measurements can be taken over a range of 0 – 10,000 mg/l. The sensor uses an 880 nm infrared wavelength (ISO accepted method), meaning differences in centrate colour have no effect on measurements. The lens is made of a polymer with the same optical properties as water scratches on the lens do not affect the zero point, ensuring reliable long-term measurement and preventing the need for frequent recalibration.

3.2.2 Centrate Sample pump

The SOLiSENZ CSZ V3.0 uses a self-priming peristaltic pump for the supply of the sample at a flow rate of 60 L/hr.



WARNING - ROTATING PARTS

Never run the pump without its protective cover/glass in place. Keep fingers and loose clothing away from the pump head during operation. Only trained maintenance personnel should service the pump.

3.2.3 Ultrasonic Device

The ultrasonic transducer removes microbubbles from the centrate by vibrating them out of suspension. This is essential for reliable TSS measurement, as microbubbles would otherwise interfere with the optical sensor signal.

3.2.4 Centrate Air Diffuser

The Centrate Air Diffuser (CAD) is a state of the art water and air separator to instantly split the air from the centrate after the ultrasonic device removed the microbubbles.

3.2.5 Cleaning valves

The SOLiSENZ CSZ V3.0 has three cleaning valves for automatic cleaning. These are valves for Backflushing the sample tube, Cleaning the whole system and Jet Flushing the flowcell and sensor.

3.2.6 Manual drain valves

The SOLiSENZ CSZ V3.0 has two manual drain valves for draining the complete wetted part. The drain is placed on the bottom of the enclosure.

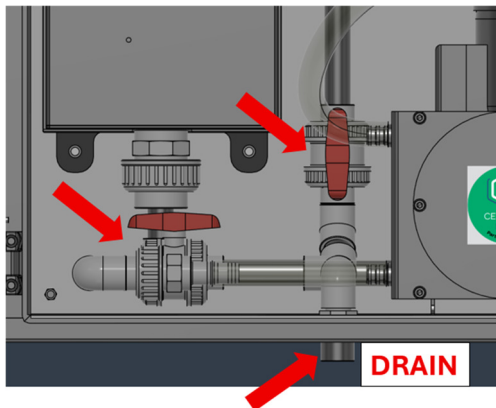

Fig. 3.2 - Manual valve and drain

3.3 Acid enclosure

The acid enclosure is designed separately from the SOLiSENZ CSZ 3.0 stainless steel enclosure. The customer has now the possibility to mount the acid enclosure and thus the acid vessel on a safe height.

3.3.1 Acid Pump



CORROSIVE SUBSTANCE - TRAINED PERSONNEL ONLY

The acid system uses citric acid, a corrosive substance. Only trained personnel are permitted to work on or near the acid pump and acid vessel. Always wear chemical-resistant gloves and safety goggles.



WARNING - ROTATING PARTS

Never run the pump without its protective cover/glass in place. Keep fingers and loose clothing away from the pump head during operation. Only trained maintenance personnel should service the pump.

The SOLiSENZ CSZ V3.0 uses a peristaltic pump to circulate citric acid from the acid vessel to the sensor for automatic cleaning. To prevent acid leaks, the acid tank is placed in a drip tray.

3.3.2 Level Sensor

The drip tray under the acid vessel is equipped with a level sensor that monitors the amount of acid remaining. When the acid level falls below the sensor threshold, an alarm is triggered (Error code 5 - Warning: acid tank low; Error code 9 - Alarm: acid tank empty). The alarm clears automatically after the vessel has been refilled.

3.4 Technical Specifications

System

Parameter	Value
Type	CSZ-03
Power Supply	85-264 VAC / 47-63 Hz
Nominal Power Usage	5.0 A
Max Pre-fuse	16.0 A
Working Temperature	5 – 40 °C non-condensing
IP Rating	IP65
Enclosure Material	Stainless Steel
Enclosure Dimensions (H x W x D)	1364 x 864 x 400 mm
Packing Dimensions (H x W x D)	1520 x 1070 x 610 mm
Weight	86 kg
Weight incl. Packing	167 kg

Sensor

Parameter	Value
Sensor Technology	Optical dual channel
Wavelength	880 nm
Measuring Range	0 – 10,000 mg/l
Resolution	1 mg/l
Accuracy	+/- 5%
Repeatability	+/- 1%
Measuring Delay (centrate to sensor)	60 – 90 seconds

Sample Pump

Parameter	Value
Type	Self-priming peristaltic pump
Flow Rate	60 L/hr

PLC/HMI

Parameter	Value
Screen	5" colour touchscreen
Analog Output	1x Analog 4-20 mA, 1500V galvanically isolated
Digital Communication	Modbus TCP
Alarm Output	Potential-free contact, max. 230 VAC / 5A
Input	External release, potential-free closing contact

3.5 Dimensions and Cleaner Enclosure

The SOLiSENZ CSZ V3.0 main enclosure dimensions are 1364 x 864 x 400 mm (H x W x D). The cleaner enclosure is a separate unit connected via tubing (maximum 100 cm tube length). The cleaner enclosure may be positioned higher or lower relative to the CSZ unit within this tubing constraint.

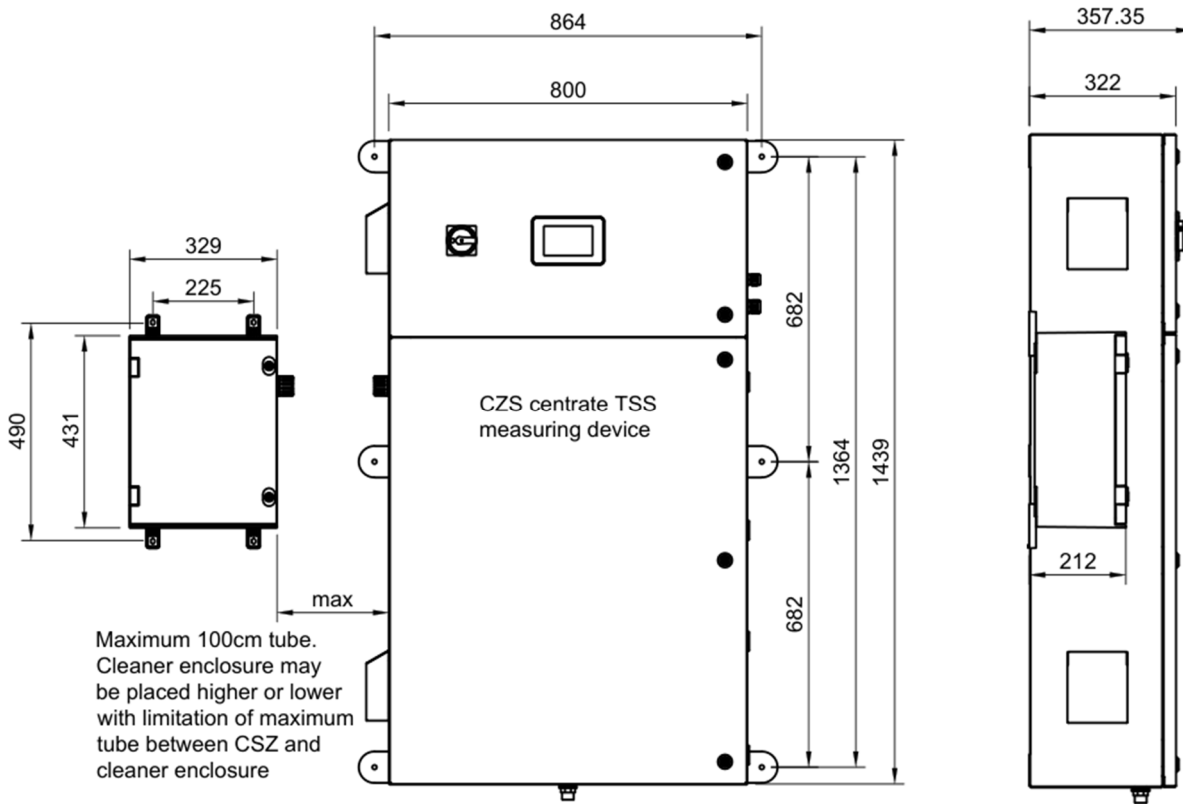

Fig. 3.2 - enclosure dimensions

3.6 Installation Recommendations

Quality and reliability of the SOLiSENZ CSZ V3.0 can only be guaranteed when the installation conforms to the following recommendations:

General

- The measurement system must be installed vibration-free
- Install the measuring system level on the correct mounting holes of the stainless steel housing
- Install the SOLiSENZ CSZ V3.0 housing (bottom) at least 45 cm above the floor

Signal & Communication

- All signals to and from the SOLiSENZ CSZ V3.0 must be properly grounded and shielded
- The Ethernet cable to the SOLiSENZ CSZ V3.0 must be of the SFTP type

Sample Connections

- If the centrate contains coarse particles larger than 5 mm, the Y-filter must be used
- Centrate flow must be at least 100 ltr/hr
- The sample supply tube must have an internal diameter of 25 mm
- When centrate flow comes from above: maximum pipe length 5 meters (from sample point to SOLiSENZ inlet)
- When centrate flow comes from below: maximum pipe length 2 meters (from sample point to SOLiSENZ inlet)

- The centrate sample point must NOT be at the bottom of the main centrate pipe; it must be positioned to obtain a representative sample

In- and Output Specifications

- The Y-filter must be installed within 1 meter of the sample point
- Y-filter automatic cleaning is controlled by the SOLiSENZ CSZ V3.0 system
- The vent outlet must be free of pressure and vacuum. See item 2 on figure below
- Centrate sample drain/outlet must be free of pressure and vacuum. It MUST NOT flow upwards. See item 3 on figure below
- Clean water connection requirements: < 1 mg/l TSS
- Minimum diameter of piping/hose for clean flush water: 3/4" or 19 mm
- Clean water supply must be adjustable/reducible with a pressure gauge; operating pressure 1.5 - 3 barg. See item 4 on figure below

Process Connections

Process connections are easily accessible. Drain connection at the bottom and connection on the right side of the SOLiSENZ CSZ V3.0 is stainless steel internal thread G3/4"

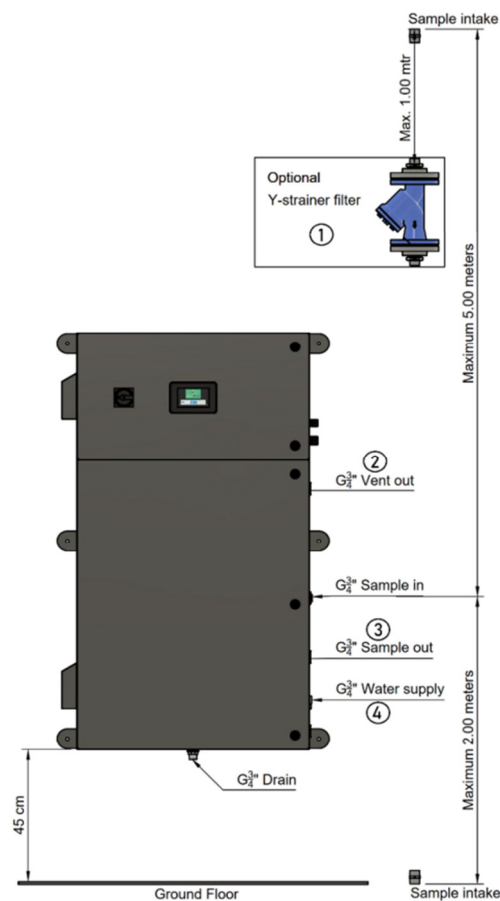

Fig. 3.3 - Installation Recommendations drawing

3.7 Installation of Acid Enclosure

The acid enclosure comes separately from the SOLiSENZ stainless steel enclosure. Therefore during installation this acid enclosure must be connected to the system. The following steps need to be taken.

General

- The acid enclosure must be placed on a safe height for exchanging the acid vessel
- The tubes length between the acid enclosure and the stainless steel enclosure is maximal 100cm. You may place it higher or lower with the limitation of the maximum tube length.

The upper cable gland is used for the tube with two electrical cables.

The lower cable gland is used for the PTFE acid tube and must be installed as shown on figure 3.6. The PTFE tube in the acid enclosure is not connected because it is easier to connect the PTFE tube first on the non-return valve of the flowcell. You may cut the PTFE tube in the acid enclosure if it is too long.



Fig. 3.4 - Tube cable glands



Fig. 3.5 - acid tube in acid enclosure



Fig. 3.6 - Acid tube fixation on non-return valve of flowcell

Electrical

In the upper tube there are two cables:

1: 2-wire cable for powering the acid pump

wire 1 = X8 terminal 8

wire 2 = X8 terminal 7

1: 2-wire cable for powering the acid pump

wire Brown = X7 terminal +

wire White = X7 terminal -

wire Green = X7 terminal 2

4. Software PLC/HMI

The PLC/HMI enables the user to configure settings and view measurement data. The PLC controls all inputs and outputs of the SOLiSENZ CSZ V3.0. It activates automatically when connected to the power supply.

The home screen is displayed on startup. Press the logo to proceed to the main screen, where the system status is shown graphically. The PLC automatically returns to the home screen after an adjustable minutes of inactivity.

4.1 Main Screen

The main screen provides a complete overview of the current system status:

Element	Description
Navigation buttons	GRAPHS, SETTINGS, ALARM LIST, INFO
Status bar (top)	Current status description and timestamp
Alarm indicator	Green = No alarm Red = Alarm active
Component status indicators	Shows active/inactive state for: MEASURING, PUMP, ULTRASONIC, CLEANING, QUICK CLEAN, BACKFLUSH
TSS Display	Current TSS measurement (calibrated value) - ACTIVE (green) or HOLD (red)
Zero-Value	Last measured zero value (determined after cleaning)
ACID EMPTY banner	Red banner displayed when acid tank is empty
Actual Status	Text description of current operation (Measuring, Waiting, Cleaning, etc.)
RELEASE	MANUAL = Manual release active (checkmark) EXTERNAL = Release via Modbus or digital contact (green LED)
SERVICE MODE button	Press to activate safe mode (RED). Press again to resume normal operation (YELLOW).
Alarm bell icon	Bottom left - flashing red = active alarm present

Main Screen States

The following screenshots show the main screen in various operational states:

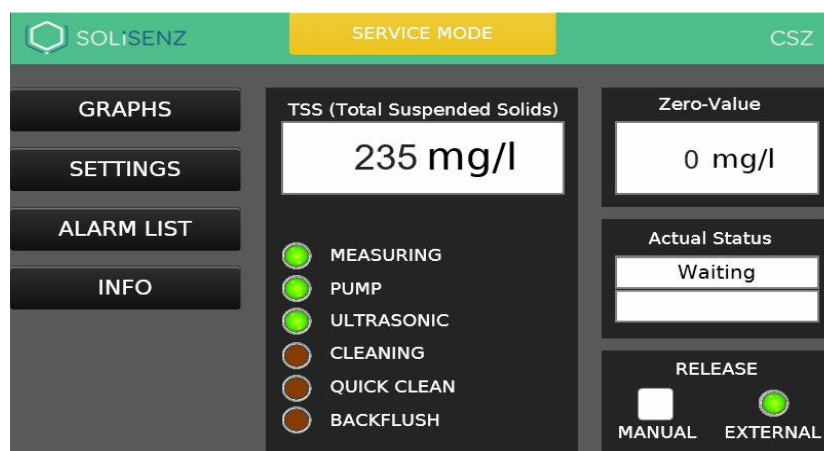

Fig. 4.1 - Main screen: System measuring (235 mg/l), EXTERNAL release active

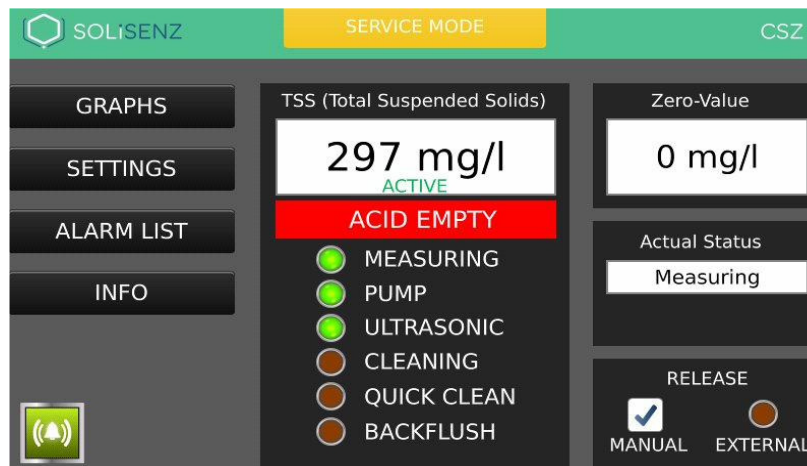

Fig. 4.2 - Main screen: ACID EMPTY alarm (297 mg/l, ACTIVE) — acid vessel requires refilling

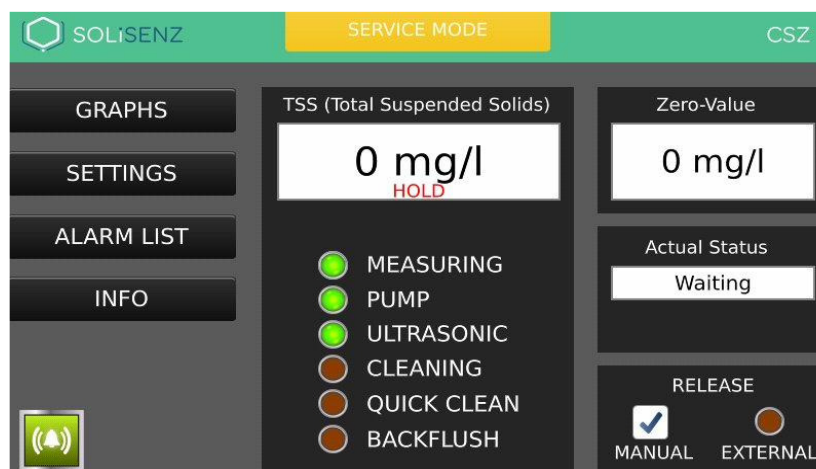

Fig. 4.3 - Main screen: Measurement on HOLD (0 mg/l) — last value frozen during cleaning

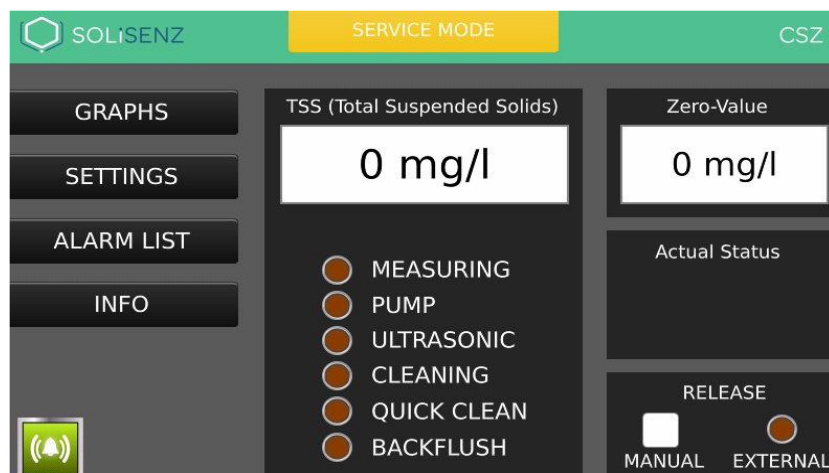

Fig. 4.4 - Main screen: System standby — all components inactive, no release active

4.2 Login

Settings that may affect the operation of the Solisenz CSZ are shielded behind a login screen. Only trained maintenance personnel are authorized to use this login.

To log in, please follow the procedure below:

To go to the login option, touch and maintain contact for several seconds with the upper right corner (at the CSZ notation) of the HMI Panel touchscreen until the sidebar menu appears.

Press login and use the following credentials

Name: Service
Password: 1791



When successfully logged in the button SETTINGS appears on the main screen.

4.3 Graphs

The GRAPHS button displays measured data in graphical form. Navigate between graphs using the NEXT button:

- Data (TSS) - Continuous TSS measurement, including during cleaning mode
- Data (TSS active) - TSS data sent to customer outputs
- Data (TSS 0 value) - Zero check values recorded during cleaning cycles

Adjusting the Measurement Range

The graph displays values within a set measurement range (default 300 mg/l). If an outlier occurs outside this range, it will temporarily not be visible. Adjust the range value (e.g., to 5,000 mg/l) to make all values visible.

Timeframe

You can choose different timeframes by clicking on the top 30 minutes, 2 hour or 8 hour buttons.

Historical Readings

Press the STOP button at the bottom left of the graph screen to activate the HISTORY button. A dropdown menu appears with historical values sorted by day.

4.4 Settings

The SETTINGS menu provides access to all configurable parameters. The following settings screens are available:

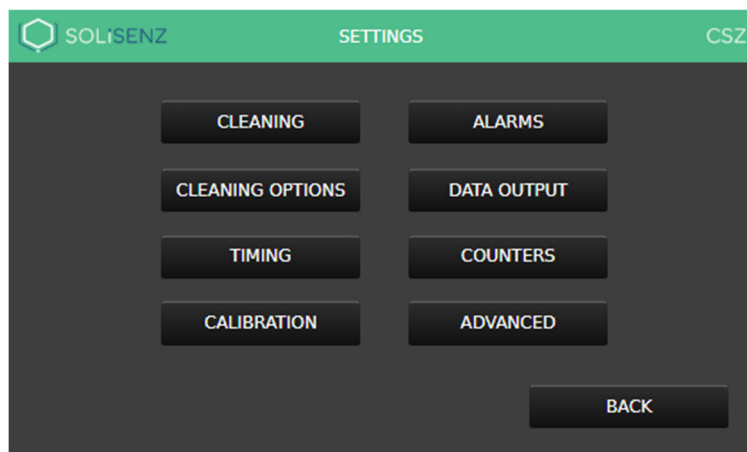

Fig. 4.5 - Settings menu overview

4.4.1 Cleaning

The SOLiSENZ CSZ V3.0 has two cleaning programs: CLEANING and QUICK CLEAN. Both can be activated automatically at set intervals or triggered manually. During any cleaning program, the TSS measurement is paused and the last measured value is held ('frozen') at the output.

When a cleaning cycle completes, the system measures the TSS sensor reading in clean water. This 'zero value' indicates whether the sensor is clean. If the zero value exceeds the set threshold, a BOOSTER cleaning program activates, injecting additional acid.

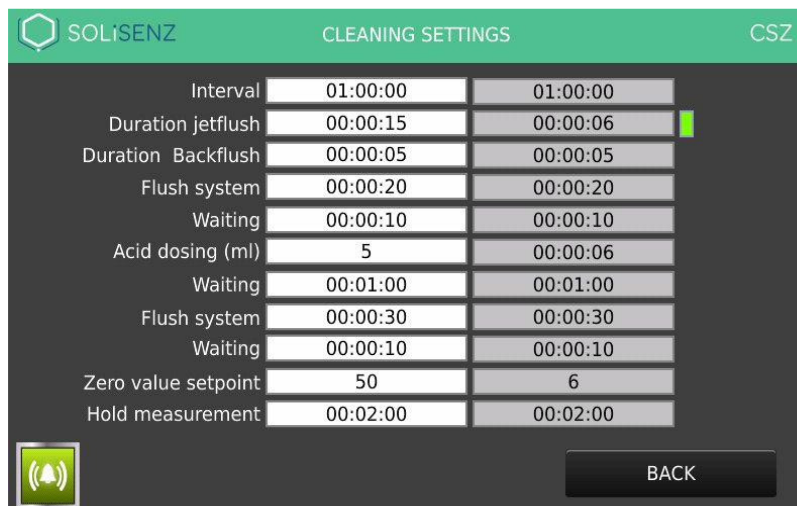

Fig. 4.6 - Cleaning Settings screen with configurable parameters

Cleaning Settings Parameters

Parameter	Description	Recommended Value
Interval	Time between full cleaning cycles	01:00:00
Duration jetflush	Duration of initial jet flush	00:00:20
Duration Backflush	Duration of backflush	00:00:13
Flush system	Duration of system water flush	00:00:20
Waiting	Waiting time after flush	00:00:10
Acid dosing (ml)	Acid volume used during sensor cleaning	5 ml
Waiting	Acid soaking time on sensor	00:00:30
Flush system	Second flush duration after acid	00:00:20
Waiting	Final waiting period	00:00:10
Zero value setpoint	If zero value is below this after cleaning, cleaning stops successfully. If higher, Booster Cleaning activates.	50 mg/l
Hold measurement	Wait time after cleaning before resuming measurement output	00:04:00

Booster Settings

The Booster programme activates when the zero value after cleaning exceeds the set threshold. It injects additional acid to achieve a clean sensor.

Parameter	Description	Recommended Value
Acid dosage (ml)	Acid volume for booster cleaning	10 ml

Parameter	Description	Recommended Value
Waiting	Acid soaking time	00:01:00
Duration of acid cleaning	Duration of acid cleaning step	00:00:30
Zero-value setpoint	Threshold for successful cleaning	50 mg/l

Quick Clean Settings

Parameter	Description	Recommended Value
Interval Quick Clean	Time between Quick Clean cycles	00:15:00
Duration jetflush	Duration of initial jet flush	00:00:10
Acid dosing (ml)	Acid volume used during sensor cleaning	5 ml
Waiting	Acid soaking time on sensor	00:00:10
Hold measurement after Quick Clean	Wait time before resuming measurement	00:00:30

Manual Activation

For immediate cleaning, use the ONE-TIME CLEANING or ONE-TIME QUICK CLEAN options. These activate the cleaning programme immediately and do not repeat automatically. Useful during maintenance or when the system is dirty outside the normal interval.

4.4.2 Cleaning Options

The Cleaning Options screen provides additional cleaning-related settings.

- Activating/Deactivating automatic cleaning
- Activating/Deactivating cleaning at startup
- Activating/Deactivating cleaning after release triggered

The system also starts a full cleaning if values are above 2500mg/l at a certain adjustable time or 5000mg/l at a certain adjustable time.

4.4.3 Timing

In the timing menu you can setup:

- Activating/Deactivating a startup delay if a decanters release signal is not delayed itself. Some decanters needs 10-30minutes to be fully operational and producing representative centrate.
- HOLD time before actual measurement. Standard set at 2 minutes. When the SOLiSENZ starts the TSS signal to the customer output is delayed with this time.
- Time to main screen. The screensaver to switch after this timer to main screen.

4.4.4 Calibration

A customer-specific TSS calibration may be performed for optimal accuracy. For a correct calibration, the procedure of taking a sample is very important.

Do **not** take samples in these situations:

- During startup of the centrifuge
- Zero-Value >100mg/l (Fouling sensor!)
- During a strong uptrend
- During a strong downtrend
- When SOLiSENZ is cleaning

Please note that the measurement delay from main centrate pipe to sensor is approximately 60-90 seconds. Always use a sample point at the outlet of the SOLiSENZ system.

Laboratory advise usage:

- Use a 1-2 micron Borosilicate fiberglas filter
- Use a **100ml sample** for accuracy of the validation
- Use covered libra with accuracy in milligrams or 0,001 grams

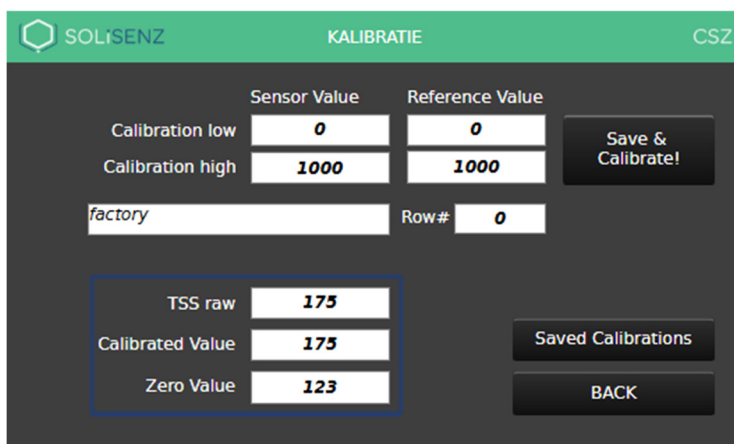

. 4.7 - Calibration menu

A calibration of the sensor is always a two point, linear (slope and offset) calibration. For a proper calibration, these two calibration values should be within the expected TSS range of the application.

Example:

	Sensor Value	Reference Value
Calibration Low	104	80
Calibration High	430	360

Performing a Calibration

Calibration Low:

Wait till the sensor reading is stabilized. Note directly after sampling (at sample OUT of SOLiSENZ CSZ) the raw value (TSS ruw) of the sensor. This is the non- calibrated value.

DO NOT note the TSS value from the main screen! This could be the previous calibrated value and will afterwards mix-up your new calibration.

Where the Sensor Value Low and High are the sensor (TSS raw) readings during taking a lab sample. The Reference Values Low and High are the validated laboratory results from the taken samples.

Repeat the procedure for the high sample at calibration high.

When the 4 inputs are filled in:

Calibrations can be saves on a certain row number with initials. Fill in the initials and row number before pressing Save & Calibrate. When this button is pressed the calibration is active.

All the saved calibrations are shown under the button Saved Calibrations. There can be checked which calibration is active.

4.4.5 Alarms Settings

Alarm threshold values can be set for:

- TSS Zero Value (mg/l) - High Alarm threshold (Warning) and Too High Alarm threshold (system stops)
- Pump power (A) - High Alarm (Warning) and Too High Alarm (system stops)

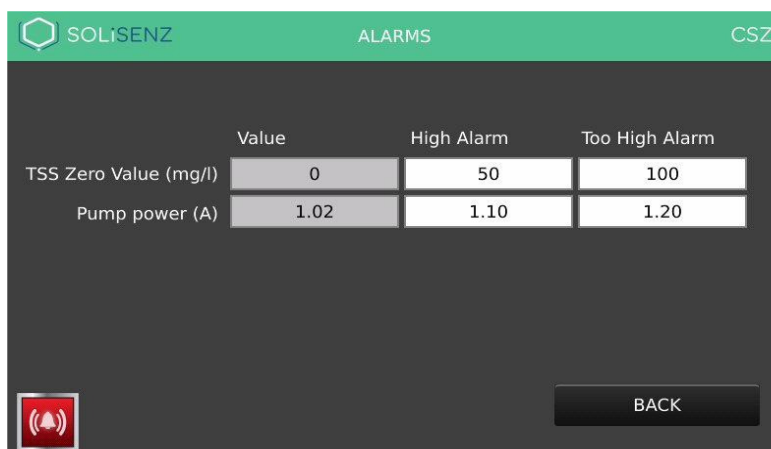

Fig. 4.8 - Alarm threshold settings screen

Each alarm has three columns: current measurement value, High Alarm threshold, and Too High Alarm threshold. When 'Too High' is reached, the SOLiSENZ CSZ V3.0 will shut down.

4.4.6 Data Output

In the Data Output menu, the 4-20 mA analogue output range can be configured for TSS. By checking 'mA Simulate', the analogue output can be set to a fixed test value for commissioning and SCADA testing. The analogue output is galvanically isolated up to 1500V.

4.4.7 Counters

The COUNTERS screen displays the operating time of various components: feeding pump, hose (feeding pump), ultrasonic, acid pump, hose (acid pump), and the acid tank contents. Reset the counter after replacing a component by pressing the corresponding reset button. If the acid tank drains unusually quickly, this may indicate a leak.

4.4.8 Advanced Settings



QUALIFIED PERSONNEL ONLY

The Advanced settings are pre-configured by the supplier and/or maintenance party. Incorrect settings may adversely affect measurement results and system operation. Only qualified personnel may modify these settings.

The ADVANCED button in the Settings menu provides access to advanced parameters including automatic cleaning enable/disable. These settings should only be modified by qualified and trained personnel. Login and password is on request.

5. Alarms

The alarm system has two severity levels: Warnings (orange) and Alarms (red). A Warning is a notification only, the SOLiSENZ CSZ V3.0 continues operating. If an Alarm is critical, the system shuts down.

The alarm bell icon at the bottom left of the main screen indicates alarm status: green = no alarm, flashing red = active alarm.

5.1 Alarm Summary Screen

Press ALARM LIST on the main screen to access the Alarm Summary. Alarms are displayed with: Severity, ID, Name, Value, Date/Time, Change (ON/OFF), ACK Pending, and an Info button.

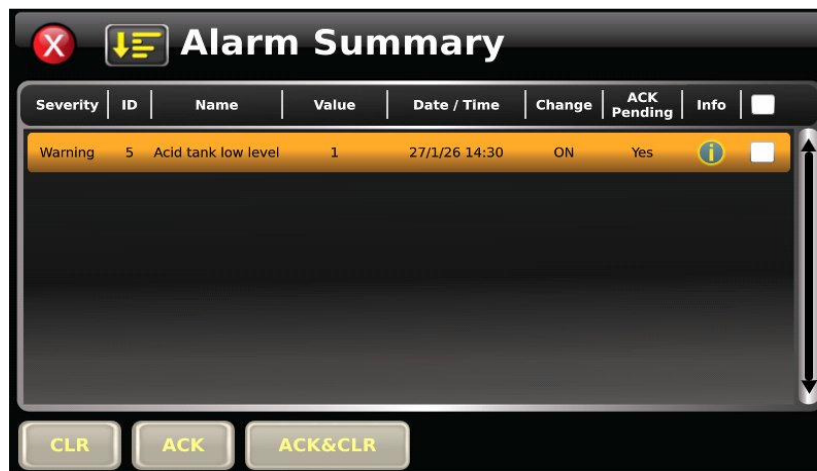

Fig. 5.1 - Alarm Summary: Single active warning (Acid tank low level)



Fig. 5.2 - Alarm Info popup: detailed description and guidance for the Acid tank low level warning



Fig. 5.3 - Alarm Summary: Two alarms shown — including alarm transition (ON and OFF events)



Fig. 5.4 - Alarm Summary: Alarms selected for acknowledgement

The status of an alarm is shown under 'Change' and 'ACK Pending'. Change = ON means the alarm is active. ACK Pending = Yes means the alarm requires acknowledgement from the operator before the system will restart.

Button	Action
CLR	Clear - removes the alarm from the display
ACK	Acknowledge - acknowledges the alarm; system can restart
ACK&CLR	Acknowledge and Clear - acknowledges and removes the alarm

5.2 Alarm History



Fig. 5.5 - Alarm History screen showing historical alarms with severity, value, and change status

The Alarm History is accessible via the ALARM LIST button on the main screen. It shows all past alarms with date/time, severity (Warning/Critical), value, change status, and the actions taken to resolve each alarm.

5.3 Errors

Error	Description	Type	Priority
Acid tank low level	Acid low level, 48H before Urgent (stop) alarm	Warning	Medium
Generator OFF	Generator should be ON but no respons	Warning	Medium
Power usage pump is high	Centrate sample pump takes more power	Warning	Medium
Pump error	Centrate sample pump should be ON but no respons	Warning	Medium
TSS measured concentration is too high	Measured value above 10.000mg/l	Warning	Medium
TSS Zero value is high	High alarm threshold for zero value	Warning	Medium

Error	Description	Type	Priority
Acid tank is empty	Acid tank is empty	Alarm	Urgent
Circuit Breaker 100F4	Circuit breaker 100F4 is OFF	Alarm	Urgent
Circuit Breaker 100F6	Circuit breaker 100F6 is OFF	Alarm	Urgent
Power usage pump is too high	Centrate sample pump takes too much power	Alarm	Urgent
TSS Zero value too high	Too high alarm threshold for zero value	Alarm	Urgent

Medium priority errors result in a warning notification only. Urgent priority alarms shut down the SOLiSENZ CSZ V3.0. Press the Info button (i) next to any alarm to view detailed guidance.

6. Troubleshooting

Problem	Possible Cause	Solution
Acid tank empties quickly	Cleaning settings, acid dosage too high	Reduce acid dosage amount; check zero value setpoint
Acid tank empties quickly	Sensor remains dirty, frequent cleaning triggered	Manually clean sensor (see Section 8.2); review zero value setpoint
TSS 0 value too high	Sensor remains dirty after cleaning	Manually clean sensor (see Section 8.2); review zero value setpoint
Motor current too high	Blockage in SOLiSENZ or drain	Check flow cell/sensor for clogging; check drain hose for blockage
Pump does not work	No power supply	Check that pump is powered on; verify power supply connections
Pump does not work	Pump roller wheel stuck	Check hose securing; check outlet pressure; check for sediment in hose
Hose service life too short	Solid particles (grains, struvite) in sample	Check sample feed and tubing for solids
Hose service life too short	Discharge pressure too high	Check pressure and clear any blockages
Hose service life too short	Temperature too high	Contact maintenance party or supplier

7. Maintenance



SAFETY - PPE REQUIRED FOR ALL MAINTENANCE

All maintenance activities must be carried out by qualified, trained personnel only. Before any maintenance, activate SERVICE MODE on the touchscreen. Always wear chemical-resistant gloves and safety goggles when working on or near the sensor, acid system, or sample conditioning enclosure.

7.1 Preventive Maintenance Schedule

Interval	Activity
Weekly	General physical inspection for alarms and leakages Check for high zero values, manually clean TSS sensor if zero value increases or does not return to zero after cleaning Check dust filters on cabinet ventilation
Every 3 months	Replace hose of the peristaltic acid pump
Every 6 months	Replace hose of the peristaltic centrate sample pump

Note

Centrate sample points, filters, and sample lines are not included in the scope of delivery of the SOLiSENZ CSZ V3.0.

7.2 Manual Cleaning of the TSS Sensor



CAUTION - OPTICAL SENSOR

The TSS sensor has optical windows that can be damaged by sharp tools or inappropriate cleaning materials. Use only soft tissues. Never use abrasive cloths or sharp objects.



PE REQUIRED

Wear gloves and safety goggles during sensor cleaning. The flow cell may contain sample water with biological hazards.

Procedure for manual cleaning of the TSS sensor:

1. Press on SERVICE MODE (Top of main screen) to activate safe mode
2. Remove the fixing ring by turning left
3. Remove sensor from flowcell
4. Insert a soft tissue in the measuring path and gently wipe the windows. If needed make the tissue wet with clean water and repeat cleaning.
5. Put the sensor in a beaker with clean water (0 mg/l TSS)
6. Go to Settings > Calibration and check if the TSS raw value is 0 mg/l. Repeat step 4 if it is not clean.
7. Place sensor back in the flowcell, fixate the fixing ring and press on the red SERVICE MODE button to activate the measurement again.

If the contamination is so severe that a cloth with water alone is insufficient to clean the sensor, an acid or degreaser may also be used. Apply the cleaning agent to a cloth and follow the procedure as described above.



7.3 Replacing the Acid Vessel



CORROSIVE SUBSTANCE - CITRIC ACID

You will be working with citric acid, which is a corrosive substance. This procedure must only be performed by trained personnel. Always wear chemical-resistant gloves and safety goggles. Fill replacement only in the designated laboratory or safety workspace.



SOLiSENZ advice to use citric acid 40-50% concentration

1. Open the acid enclosure
2. Remove the suction lance from the acid vessel
3. Refill the acid vessel on a safe location
4. Insert the suction lance fully into the acid vessel

After refilling

After refilling the acid vessel, the 'Acid tank low level' warning and/or 'Acid tank empty' alarm will clear automatically once the level sensor detects the new acid level.

7.4 Dust Filter Check / Exchange

1. Press the stainless steel ventilation cover upwards to remove it.
2. Pull the screen to the front to get access to the filter
3. Exchange filter
4. Reverse above actions to reassemble everything



8. Modbus TCP Communication

Parameter	Value
Protocol	Modbus TCP
Slave ID	1
Port	502
Main Control Parameter	TSS Actual Measurement (address 11, FC03)

8.1 Key Parameters

The TSS Actual Measurement (address 11, FC03) is the primary control parameter. It is only updated when the SOLiSENZ CSZ V3.0 has a representative TSS measurement. During cleaning or when measurement is on HOLD, the parameter is frozen to its last value. This value is calibrated.

TSS Raw (address 12, FC03) is the non-calibrated TSS value. TSS Zero-value (address 14, FC03) is measured during cleaning to validate sensor cleanliness ideal value is as low as possible (0 mg/l).

8.2 Function Code 01 - Coil Registers (Read/Write)

Address	Description	Type	Access
0	Release	BIT	Read/Write
1	Common/General Alarm	BIT	Read
2	Ultrasonic active	BIT	Read
3	Measurement is active	BIT	Read
4	System Flush Valve	BIT	Read
5	Acid pump active	BIT	Read
6	Acid Tank empty Alarm	BIT	Read
7	Acid Tank almost empty	BIT	Read
8	Out of range (> 10,000 mg/l)	BIT	Read

8.3 Function Code 03 - Holding Registers

Address	Description	Type	Access	Notes
0	Read/Write Alarm Word	INT16	R/W	bit 0 = Release
10	Read Alarm Word	INT16	Read	bit 0=Common Alarm, bit 1=Ultrasonic, bit 2=Measuring, bit 3=Flush Valve, bit 4=Acid pump, bit 5=Acid empty, bit 6=Acid low, bit 7=Out of range
11	TSS Actual Measurement	INT16	Read	mg/l ctive and calibrated
12	TSS Raw	INT16	Read	mg/l non-calibrated
14	TSS Zero-value	INT16	Read	mg/l sensor validation
15	Cleaning Interval	INT16	Read	Interval in hours

9. Electrical Connections



ELECTRICAL HAZARD - QUALIFIED ELECTRICIANS ONLY

All electrical connections must be made by a qualified and certified electrician. Always de-energize and lock out/tag out the system before making or modifying electrical connections.

9.1 Terminal strip

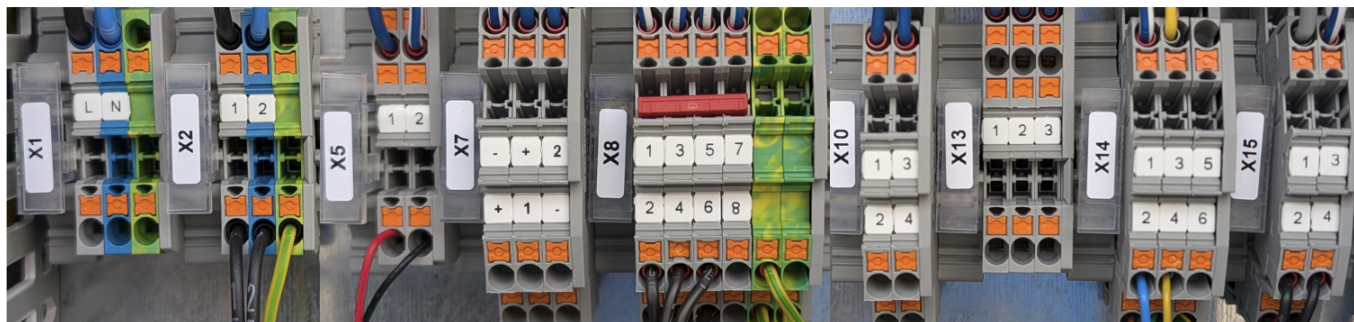

Fig. 9.1 - Terminal strip

Customer terminal:

Terminal	#	Description
X1		Power supply: 85-264 VAC / 47-63 Hz
X7	1	External release input: Potential-free closing contact
	+	24VDC
	-	GND
X10	1	-(minus) 4-20 mA, galvanically isolated to 1500V
X10	2	+(plus) 4-20 mA, galvanically isolated to 1500V
X13	1	COM, Alarm output: Potential-free contact, max. 230 VAC / 5A
X13	2	NC, Alarm output: Potential-free contact, max. 230 VAC / 5A
X13	3	NO, Alarm output: Potential-free contact, max. 230 VAC / 5A

Internal terminal:

Terminal	#	Description
X2		Centrate sample pump power supply
X5		Case fan power supply
X7	2	Input Acid low level indicator
	+	24VDC
	-	GND
X8	1&2	BackFlush Valve
X8	3&4	System Flush Valve

Terminal	#	Description
X8	5&6	Jet Flush Valve
X14		TSS Sensor wiring
X15		Ultrasonic wiring

9.1 Enclosure connections and cable glands

On the outside of the SOLiSENZ CSZ V3.0 enclosure there are 8 possible connections or cable glands:

- 3 x M16 cable glands
- 2 x M20 cable glands
- 1x M25 cable glands
- 1x USB connector (Data download or software upgrade)
- 1x RJ45 Ethernet connector (Modbus TCP communications)

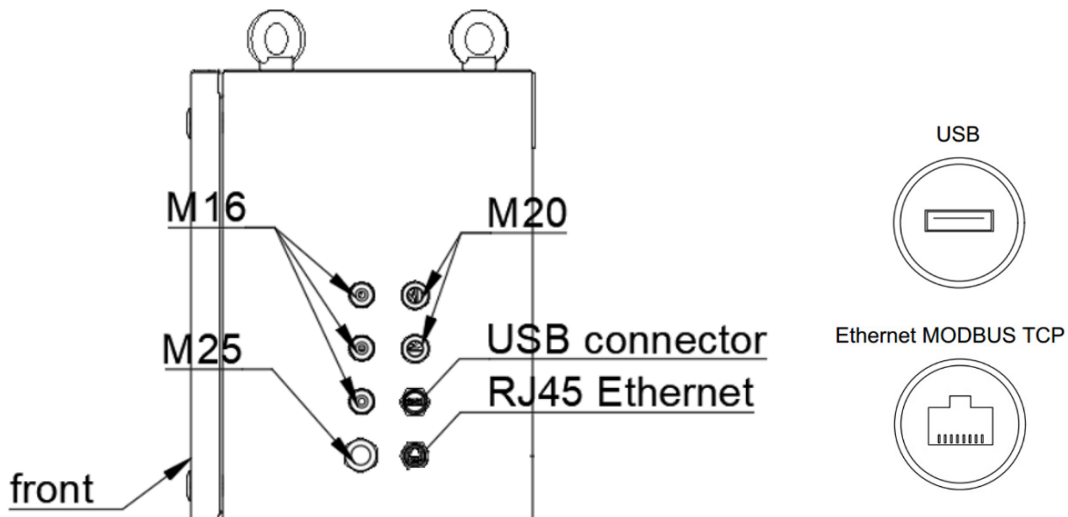

Fig. 9.2 - Enclosure connections and cable glands

10. Parts List

Parts

Part	Article Nr.
Flowcell CSZ V3.0	10905
TSS Sensor CSZ V3.0	10908
O-ring sensor CSZ V3.0	10956
Acid pump (complete with motor)	10574
Tube acid pump CSZ V3.0	10955
Pump head acid pump	10577
Ultrasonic Device CSZ V3.0	10608
Ultrasonic Generator CSZ V3.0	10959
Centrate Sample pump CSZ V3.0	10534
Tube centrate sample pump CSZ V3.0	10957
Cleaning Valve	10903
Filter enclosure fan (top left)	10958

11. Spare Parts

When purchasing a SOLiSENZ CSZ V3.0, a spare parts package is available.

Yearly Maintenance Kit, Part no: 10625

This package contains:

Part	Quantity	Article Nr.
Tube centrate sample pump CSZ V3.0	2	10957
Tube acid pump CSZ V3.0	4	10955
Pump head acid pump	1	10577

Individual parts can also be ordered separately using the part name and article number above. Contact your local SOLiSENZ service party or supplier for ordering.