

Dihedral

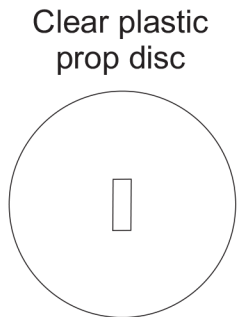

Clear plastic prop disc

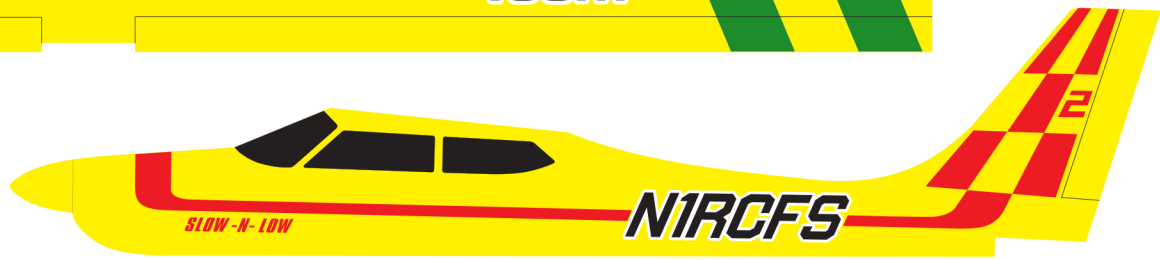
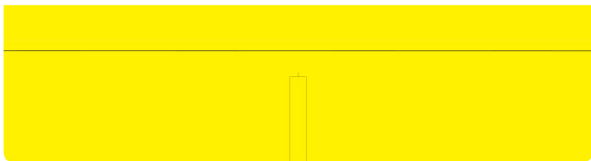
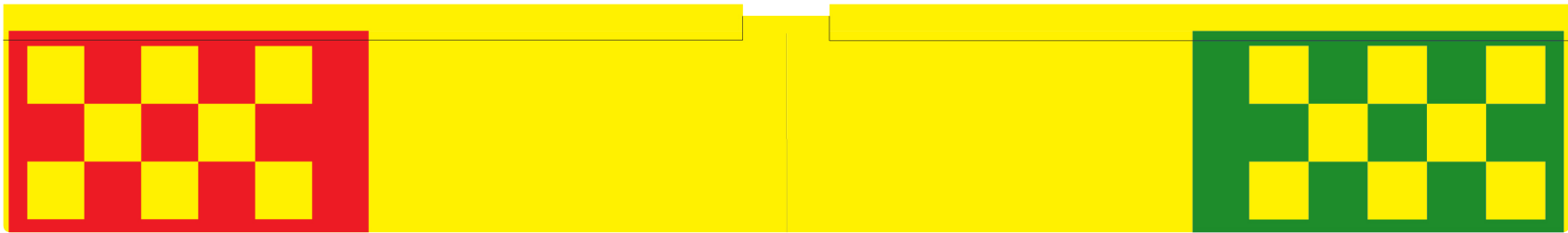
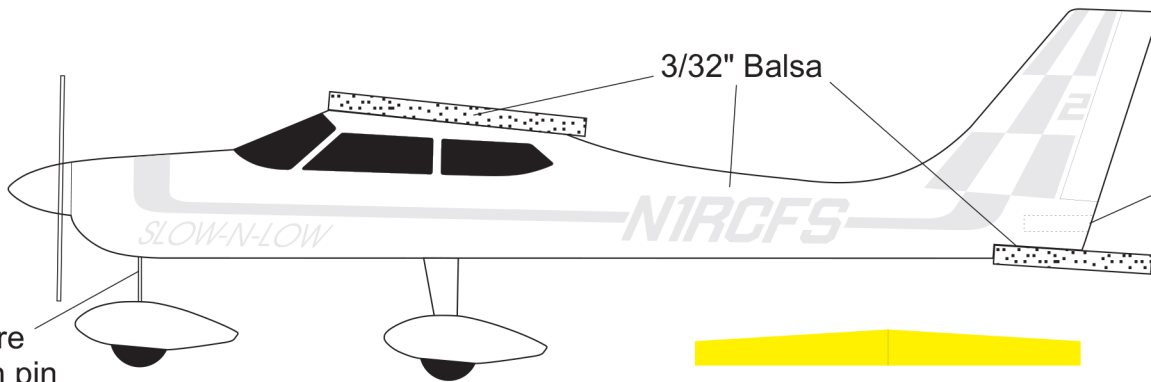

Wire (push pin cut to length).



Landing gear

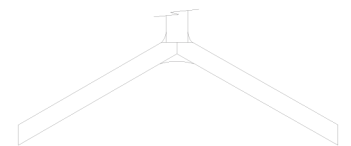

Approx. wire handle location.



3/32x3x8"

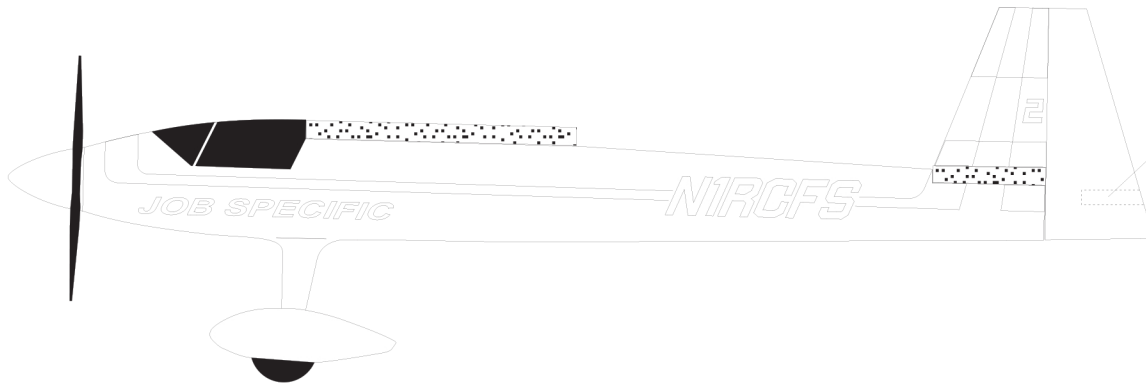
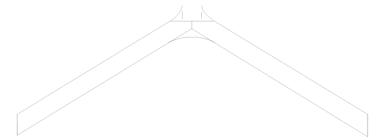

Approx. Wire Handle Location.

Clear plastic prop disc

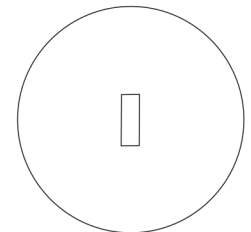

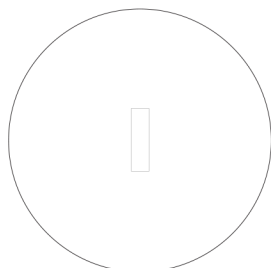
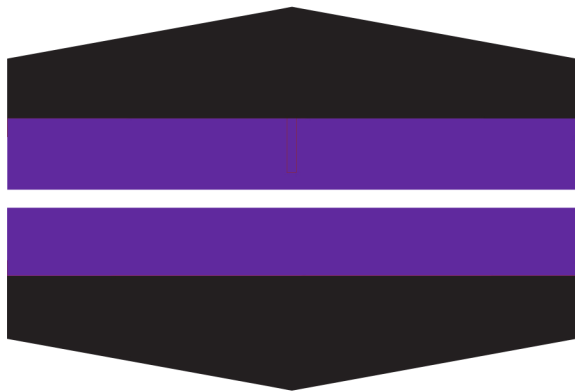
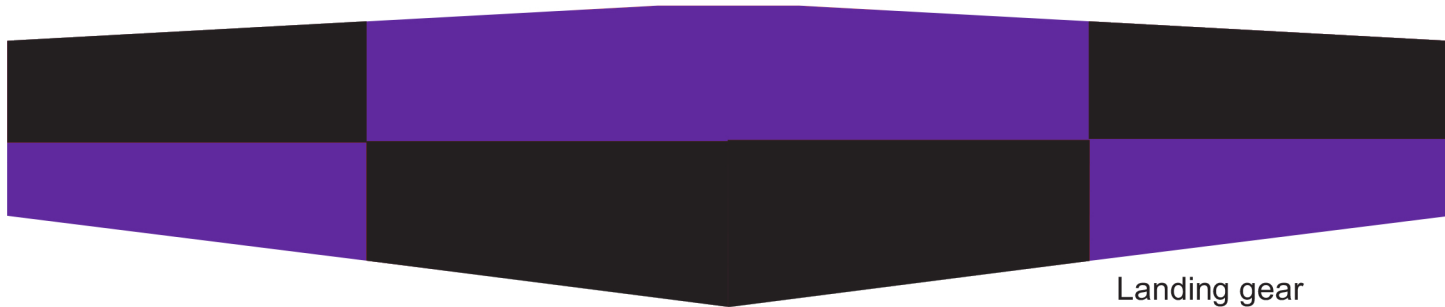
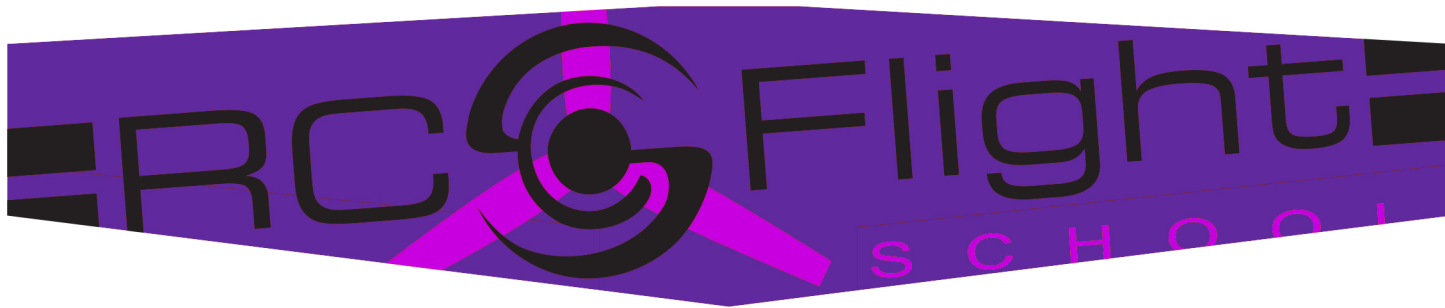

Clear plastic prop disk

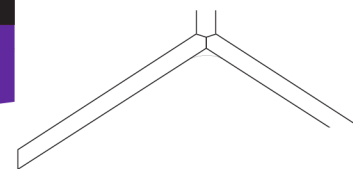

Landing gear

