

---

# Catalog

Air conditioning systems

2025 / 2026



# Versatile and flexible **Rotenso solutions**

---

**AIR CONDITIONING** SYSTEMS  
**RVF AIR CONDITIONING** SYSTEMS  
**VENTILATION** SYSTEMS  
**HEAT PUMP** SYSTEMS



*Rotenso participates in the EUROVENT programme.  
Check ongoing validity of certificate:  
[www.eurovent-certification.com](http://www.eurovent-certification.com)*

Always up-to-date catalogs  
on **rotenso.com**





# Welcome to the **Premium Class**

---

**Superior quality materials**

**The highest efficiency**

**Wide range  
of options &  
accessories**

**Unique design**



**Ergonomic controllers**

**Durability and reliability**

**Excellent air filtration system**

**High energy efficiency class**



# Table of contents

---

4

## General information

About Rotenso .....	06
Warehouse and logistics .....	06
Laboratory and quality control .....	08
Certificate Eurovent .....	09
Air conditioning systems .....	10
Air conditioners as air-to-air heat pumps .....	10
Cooling and heating of the future .....	11
SKYR modern technology systems .....	12
BLDC Inverter rotary compressors .....	13

## Rotenso air conditioning ..... 15

Match compatible Rotenso units .....	16
Solution Single 1:1 .....	18
Solution Dual 1:2 .....	20
Solution Multi 1:X .....	22
Solution Zone Management .....	24

## Technology you'll love ..... 26

Generation X in air conditioning .....	28
All-year-round operation devices .....	30
Useful features and modes of operation .....	32
Super silent eMOTO mode .....	33
Silence mode .....	33
Eco eMOTO mode .....	33
1W standby mode .....	33
Healthy air systems .....	34
Automatic purification iClean .....	34
Automatic purification iAIR .....	34
Electrostatic HD iAIR filter .....	34
Anti-corrosive gold-plated fins .....	34
Super Ionizer iAIR .....	34
UV lamp .....	34
Optional filters .....	35
Take a breath of clean air .....	36
Intelligent eMOTO venting systems .....	38
Windless eMOTO mode .....	38
Louvre 180° .....	38
SMART Eye Sensor .....	39
Turbo eMOTO mode .....	39
Automatic 4D louvres .....	39
Air supply eMOTO control system .....	39
We know that details matter .....	40
Intelligent control systems .....	41
Optimization of operation .....	42
Control your air conditioner .....	44
Airzone iCloud zone control .....	45
Features of Rotenso	
Air Conditioning Systems - tables .....	46



## Air conditioners

### Single, Dual, Multi ..... 51

Comfort, design, technology .....	52
Wall-mounted air conditioner Mirai .....	54
Wall-mounted air conditioner Fresh .....	58
Wall-mounted air conditioner Versu Mirror R15 .....	66
Wall-mounted air conditioner Versu Pure .....	70
Wall-mounted air conditioner Versu Cloth .....	74
Wall-mounted air conditioner Revio .....	84
Wall-mounted air conditioner Teta .....	90
Wall-mounted air conditioner Elis .....	100
Wall-mounted air conditioner Imoto .....	106
Wall-mounted air conditioner Ukura H .....	110
Wall-mounted air conditioner Ukura .....	114
Wall-mounted air conditioner Roni .....	118
Console air conditioner Aneru HP .....	122
Console air conditioner Aneru .....	126
Console air conditioner Aneru AN .....	132
Cassette air conditioner Tenji .....	136
Floor-ceiling air conditioner Jato .....	142
Ducted air conditioner Nevo .....	146
Nevo air conditioner zone management .....	150

### Aggregates Multi ..... 156

Meet new Multi product lines .....	158
Aggregate Hiro HP .....	160
Aggregate Hiro S .....	166
Aggregate Hiro N .....	172

## Remembers for you

### everything that matters ..... 178

Wireless controllers .....	180
Wi-Fi controllers .....	181
Wired controllers .....	182
Central controllers .....	183
Accessories .....	184
Dry Contact .....	184
MFBR multifunctional module .....	184
Alternating operation controller .....	185
Modbus 64 BMS/Bridge Gateway Module .....	185
Expansion manifold .....	186
SMART diagnostic module .....	186
BLACK and RAL panels .....	187
RVF-RDIX refrigerant distributors .....	187
Solutions for air handling units .....	187
RAHU condensing units .....	188
RVF AHU condensing units .....	189



## About Rotenso

---

We provide our partners with not only high-quality devices. We also provide them with knowledge and support.

Thanks to this, they can more easily solve problems with the design of air conditioning, heat pumps or recuperation systems.

We believe that their achievements determine our own success. For many years, we have been investing in the latest technologies. The result is effective and energy-saving products, the operation of which helps maintain good health of users. We offer devices with high parameters and versatile applications.

All this so that a given system can be properly adapted to the needs and expectations of customers.

6



**Exceptional**  
reliability



**Complete range  
of products**  
to suit your needs



## Warehouse and logistics

---

We have our own logistics center with an area of 8,200 m<sup>2</sup>, and together with the external warehouse, the total storage area is almost 20,000 m<sup>2</sup> and 40,000 pallet spaces. We offer our clients almost 4,000 indexes.



**Reliable**  
devices

Rotenso devices utilise top quality components and tried-and-tested solutions, all backed by a warranty.



**Professional**  
support

By opting for Rotenso solutions, you secure comprehensive technical and practical support throughout your investment journey.



**Industry**  
leader

ROTENSO is a trustworthy partner and a leader in the HVAC sector.

# Laboratory and quality control

<b>89</b>	<b>5</b>	<b>34</b>	<b>3000+</b>	<b>6000+</b>
Laboratories	R&D centers	Leading technologies	Engineers	Patents

## 3000 engineers and process supervisors:

- Quality system management.
- Supplier quality guarantee.
- Quality control of components.
- Quality control process.
- Final quality control.
- Improvement of customer service.



Rotenso brand equipment has been recognized with prestigious industrial design awards.

## The company's business model is oriented around three values:

**1.**  
Reliability

**2.**  
Quality

**3.**  
Development

whose formulated goal is the implementation of two projects:

### Rotenso Business DESIGN

The primary goal of this project is to act in responsible manner according to the principles of partnership. Immediate assistance, direct contact and reliable transportation result in satisfactory business relations.

### Rotenso Eco passport DESIGN

Ecology is Rotenso's top priority. Our light and energy effective appliances are packed into recyclable cardboard boxes. This goal is achieved by optimizing the production process.



Transportation



Assistance



Contact



Partnership



Energy



Packaging



Recycling



Weight



*Rotenso participates in the EUROVENT programme.  
Check ongoing validity of certificate:  
[www.eurovent-certification.com](http://www.eurovent-certification.com)*

## Certificate **Eurovent**

---

Eurovent Certita Certification is recognized as a world leader in the certification of products from the ventilation, air conditioning and refrigeration industry.

The Eurovent Certificate issued by it specifies and confirms the performance parameters of air conditioning and refrigeration devices, in accordance with European and international standards.

Designers, installation companies, investors and users choosing Rotenso products have the certainty that all technical data is up-to-date and verified by an independent certification company with a world-renowned.



## Air Conditioning systems

Whatever we do, you are always at the center. We use technological innovations to take care of the health and comfort of the air conditioning systems we supply. Multi-stage filtration and air purification processes make up Rotenso's PureAIR system, which takes care of healthy and clean air in your environment. Improved Silent mode of operation, gentle release of dispersed air, and intelligent control of air flow add up to an experience of unit comfort that you won't notice. The ever-increasing capacity and energy efficiency of our units respond to the growing need to rationalize energy costs and care for the environment.

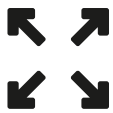

We give you everything - maximally equipped products tailored to your needs

SCOP  
5,3

Enjoy a high SCOP energy efficiency rating - up to 5.3



Extremely quiet units - high-end modern technology will take care of for your comfort



Control your system using app and module SMART Wi-Fi



Be confident in your device's operation in extreme temperatures even down to -30°C



Breathe healthy - an advanced, multi-stage system of air purification and filtration of air

## Air conditioners as air-to-air heat pumps

Thanks to advanced inverter technology, air-conditioning systems operate as reversible air-to-air heat pumps, effectively performing the function of heating or cooling buildings. The principle of operation of the heat pump air-conditioning system is that in heating mode, the outdoor unit takes the heat accumulated in the atmosphere and further, through the system of freon-compressor installation, gives it back through the indoor unit to the air inside the building. In cooling mode, the air-conditioning system reverses the circulation of the refrigerant, carrying out cooling functions in the same way.

To ensure trouble-free operation of equipment in heating mode, the unit should be equipped with a drip tray heater.

# Cooling and heating of the future

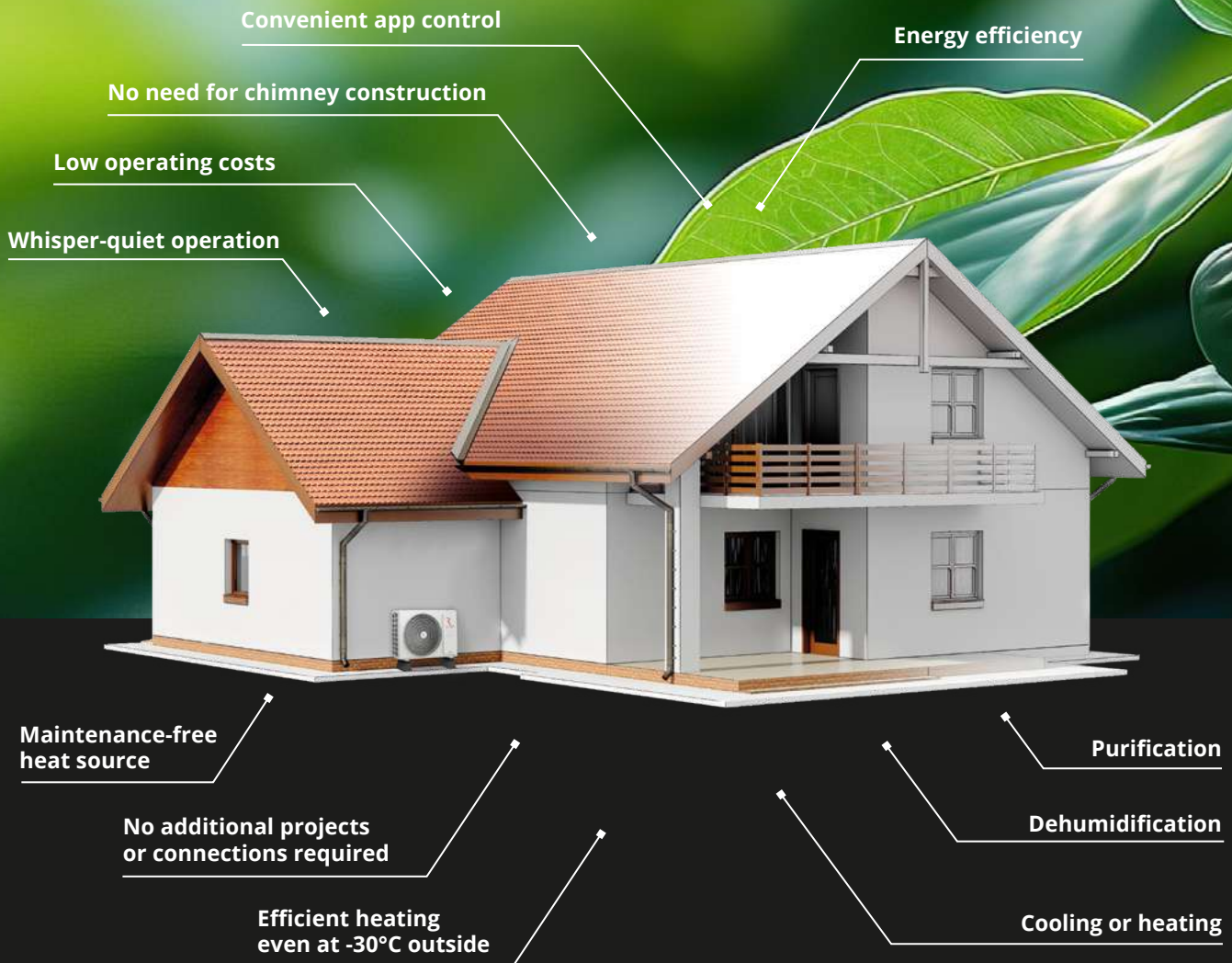

# SKYR<sup>®</sup> modern technology systems

---

## Bionic fan blade pattern and improved air duct

Innovative fan blade design based on bionic principles enables effective reduction of air flow resistance and noise levels. Optimized air duct ensures uniform air flow, consuming 30% less energy.

## DC Inverter sine wave control

The DC inverter's sinusoidal control enables high energy capacity and lower noise levels. The optimization technology has also allowed to reduce energy consumption.



## Rotary DC INVERTER compressors

Superior compressor capacity ensures unprecedented levels of efficiency. The unique design minimizes vibration during the operation of moving components, thus effectively reducing noise levels.

## Internally grooved tubes

By using densely grooved copper tubes, the heat transfer area has been increased. By increasing the number of grooves from 45 to 54, a significant improvement in engine capacity was achieved.

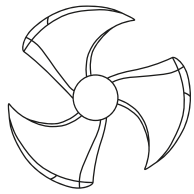

Classic blade design available on the market

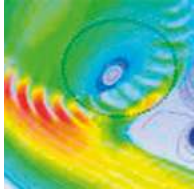

Standard air ducting

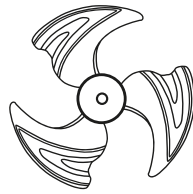

High-performance blade pattern Rotenso

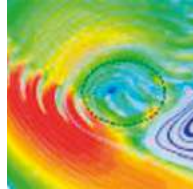

High-efficiency air duct

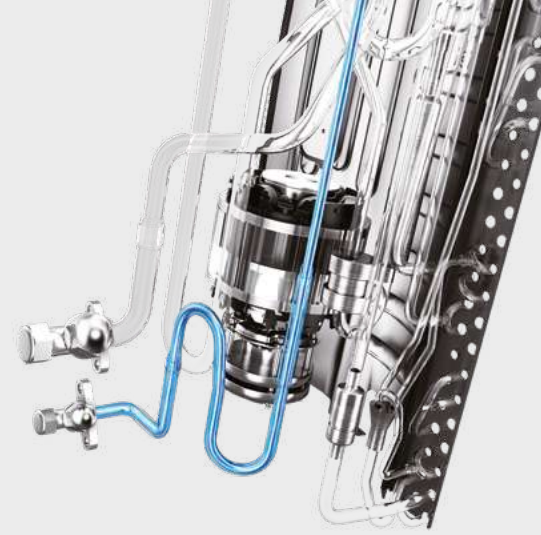
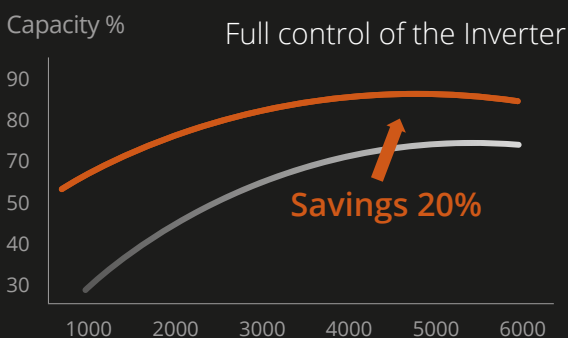

## Rotary compressors **BLDC Inverter**

Superior compressor capacity ensures unprecedented levels of efficiency. Unique design minimizes vibration during operation of moving components, effectively reducing noise levels. This modern solution provides energy-saving, trouble-free, long-term operation.

Modern design of circuits refrigerant uses improved radiation technology refrigeration to cool the heat exchanger.

This solution significantly increases the efficiency of the unit outdoor and stability of its operation at high ambient temperatures.

### Advantages of the compressor

- High-efficiency BLDC motor
- Better balance
- Lower vibration level
- Less noise
- High stability of moving parts.



## AIR CONDITIONING



## Technology that **allows you to expect even more**

---

**Rotenso air conditioners combine the latest technology with elegant style.**

**Provide a comfortable temperature in your home or office, but also redefine standards of comfort and design.**

Thanks to advanced features such as intelligent control, effective air filtration and energy efficiency, Rotenso air conditioners not only provide optimal climatic conditions, but also fresh and clean air for your well-being.

Discover how technology can blend with style and modern solutions in our line of Rotenso air conditioners.

**HP-LINE****S-LINE****N-LINE****1:X  
MULTI****1:2  
DUAL****1:1  
SINGLE**

## 16 Match compatible **Rotenso units**

Get to know the three Rotenso product lines:

**HP-LINE** „High Performance” air conditioners

**S-Line** premium air conditioners „Superior”

**N-Line** compact air conditioners „Normal”.

New and unique among our products are Rotenso’s HP-LINE, S-LINE and N-LINE air conditioning product lines.

















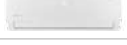

They give you the opportunity to match the ideal solution to your individual needs.

Rotenso’s range of air conditioners consists of split and multi split air conditioning systems that come in a variety of parameters.

They show excellent capacity, save energy and provide comfortable temperatures.

# Model compatibility in systems

## SINGLE, DUAL, MULTI

Model name and category	Model	HP-Line	S-Line	N-Line	S-Line	HP-Line	S-Line	N-Line
		SINGLE			DUAL	MULTI		
MIRAI Wall-mounted			•			•	•	
FRESH Wall-mounted				•				
VERSU MIRROR <sup>NEW [R15]</sup> Wall-mounted			•			•	•	
VERSU PURE Wall-mounted			•			•	•	
VERSU CLOTH STONE Wall-mounted			•			•	•	
VERSU CLOTH CARAMEL Wall-mounted			•			•	•	
REVIO Wall-mounted			•			• <sup>(1)</sup>	•	
TETA MIRROR Wall-mounted				•				• <sup>(6)</sup>
TETA Wall-mounted				•				• <sup>(6)</sup>
ELIS Wall-mounted				•				• <sup>(1)</sup>
ELIS SILVER Wall-mounted				•				• <sup>(1)</sup>
IMOTO Wall-mounted			• <sup>(2)</sup>			• <sup>(1)</sup>	•	
UKURA Wall-mounted			• <sup>(2)</sup>			• <sup>(1)</sup>	•	
UKURA H Wall-mounted			•					
RONI Wall-mounted				•				• <sup>(1)</sup>
TENJI CC Cassette 360° 620 x 620			• <sup>(4)</sup>		•	•	•	
TENJI CS Cassette 360° 950 x 950			•		•		• <sup>(7)</sup>	
JATO Floor-ceiling mounted			•		•	• <sup>(1)</sup>	• <sup>(3)</sup>	
NEVO Ducted			• <sup>(4)</sup>		•	• <sup>(1)</sup>	• <sup>(5)</sup>	
ANERU HP Console		•						
ANERU Console			•			•	•	
ANERU AN Console				•				•

1. Except for 6,8-7,1 kW 2. Except for 2,1 kW 3. For Jato 5,3 - 7,0 kW 4. Except for 2,1-2,6 kW 5. For Nevo 2,1-7,1 kW 6. Except for 5,1-6,9 kW 7. For Tenji 7,0 kW

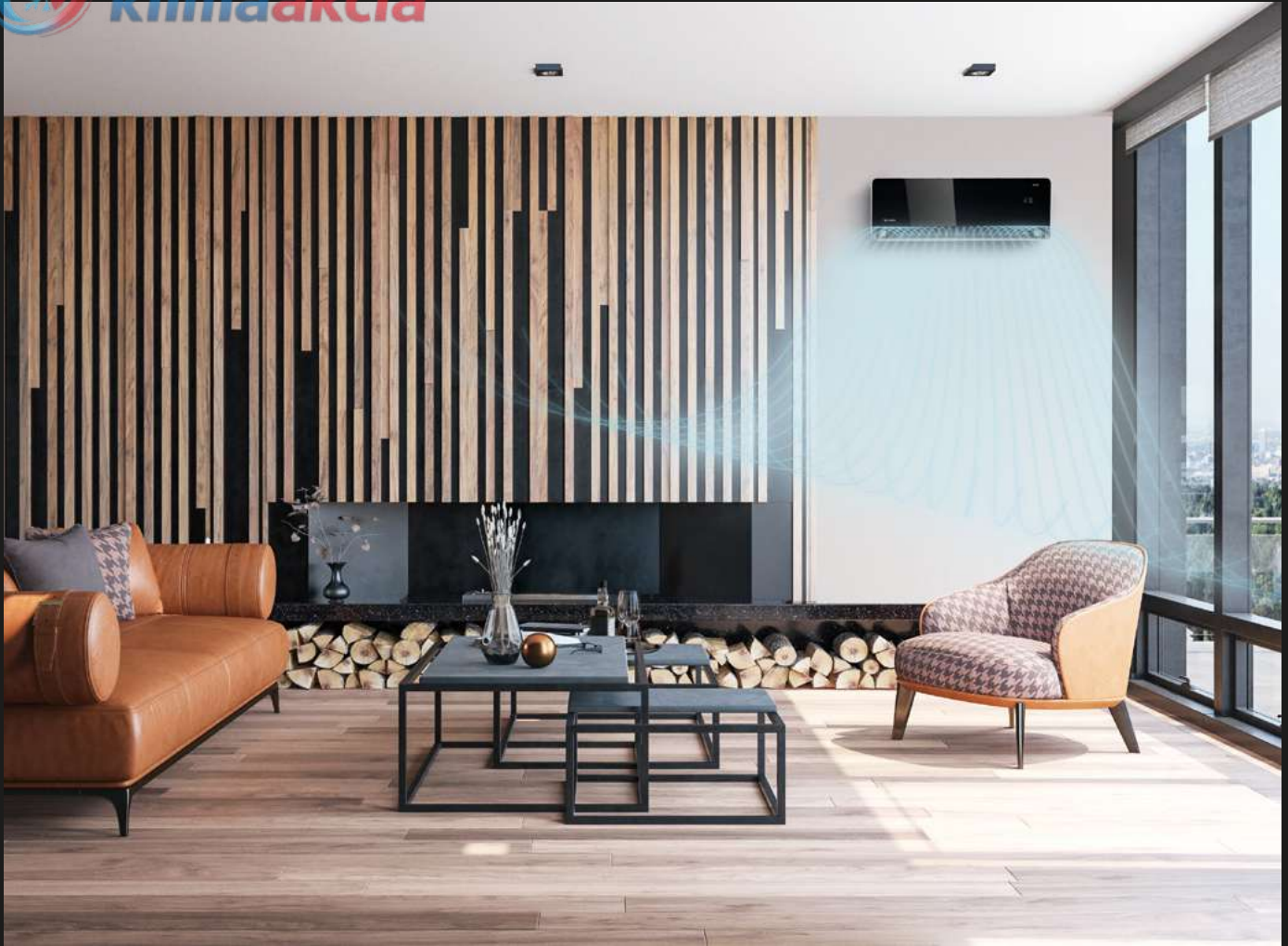

18

## Solution **Single 1:1**



Do you need a single air conditioner? Match any model from Rotenso's extensive range of units to the requirements and arrangement of your interior, and then match it with a dedicated outdoor unit, creating a universal set.

One unit indoors, the other outdoors - everything you need to feel the comfort of a Single 1:1 solution.

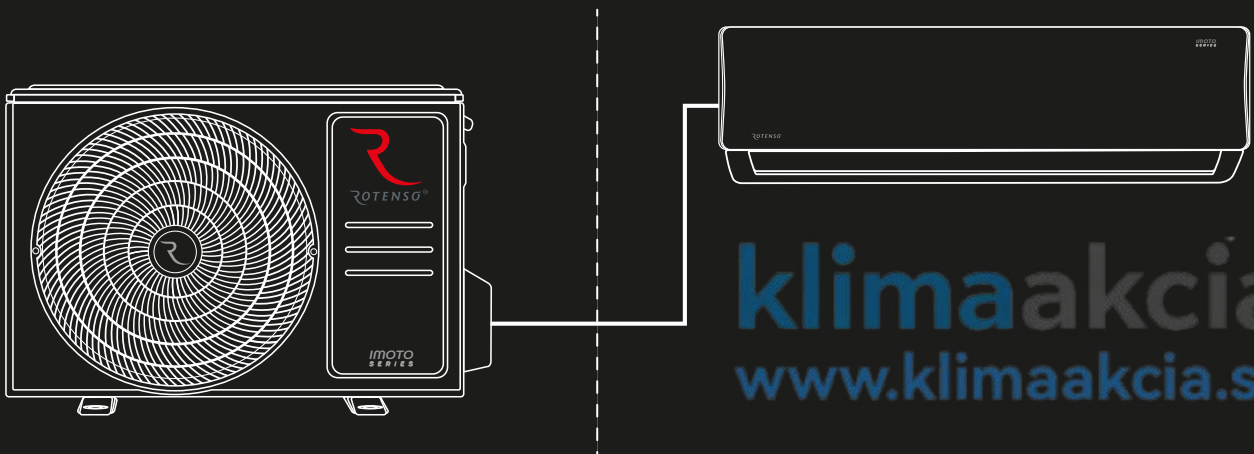

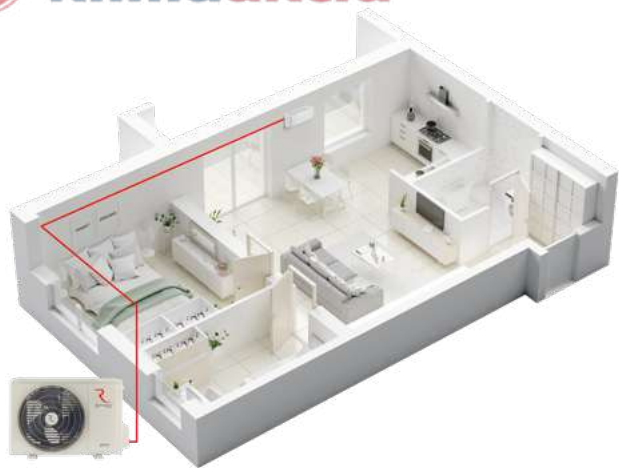

# 1 : 1

Model name and category	Model	2,6	2,7	3,4	3,5	3,6	4,7	5,0	5,1	5,3	6,8	6,9	7,0	7,1	8,8	9,0	10,6	12,0	12,1	14,1	15,2	15,5	15,8	
MIRAI Wall-mounted		•			•																			
FRESH Wall-mounted						•																		
VERSU MIRROR <sup>NEW [R15]</sup> Wall-mounted		•			•					•														
VERSU PURE Wall-mounted		•			•					•														
VERSU CLOTH STONE Wall-mounted		•			•					•														
VERSU CLOTH CARAMEL Wall-mounted		•			•					•														
REVIO Wall-mounted		•			•					•			•											
TETA MIRROR Wall-mounted		•			•				•			•												
TETA Wall-mounted		•			•				•			•												
ELIS Wall-mounted		•			•				•				•											
ELIS SILVER Wall-mounted		•			•				•				•											
IMOTO Wall-mounted		•			•					•			•											
UKURA Wall-mounted		•			•					•			•											
UKURA H Wall-mounted		•			•					•			•											
RONI Wall-mounted		•			•				•				•											
TENJI CC Cassette 360° 620 x 620					•					•														
TENJI CS Cassette 360° 950 x 950													•		•		•	•		•	•			
JATO Floor-ceiling mounted										•			•				•			•	•			
NEVO Ducted					•					•				•	•		•		•	•	•			
ANERU HP Console		•			•																			
ANERU Console		•			•			•																
ANERU AN Console					•		•																	

# Solution

## Dual 1:2



It will work well when you need a universal solution based on two twin indoor units of equal power to operate in the same mode and at the same time connected to a single outdoor unit.

Convenient simultaneous control of two air conditioners means even cooling or heating of larger spaces. The simultaneous saving of outdoor space and the even distribution of air in larger areas are the main features of the Dual 1:2 solution.

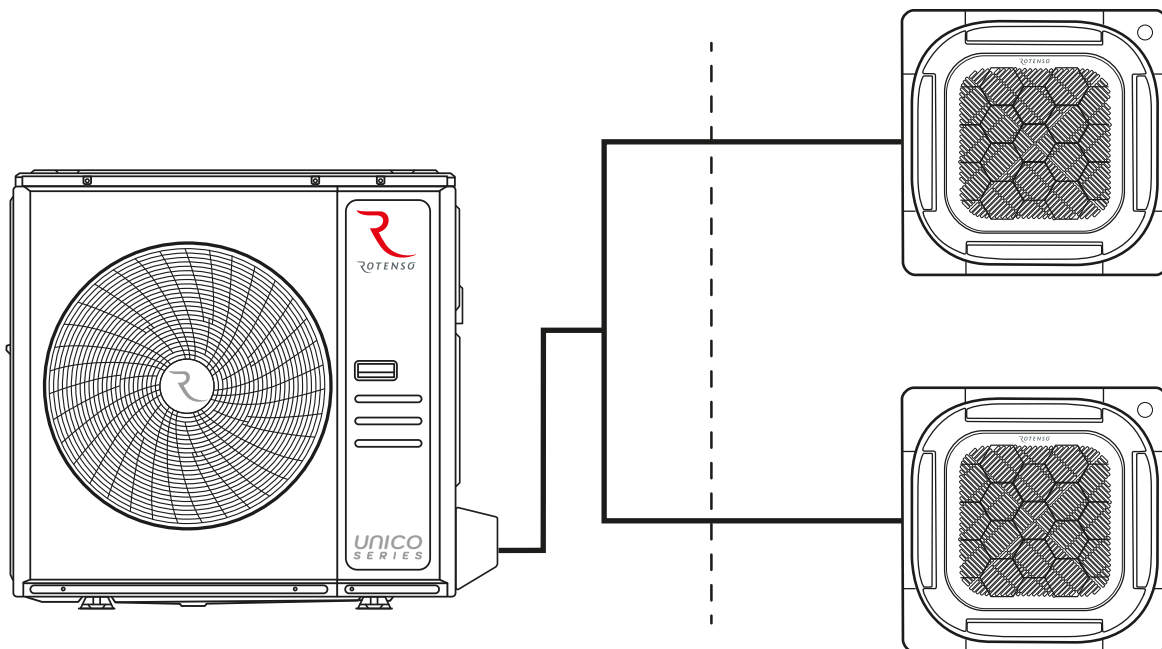





20

# 1 : 2





Model name and category	Model	Power [kW]											
		2,1	2,6	3,5	5,3	7,0	7,1	8,8	9,0	10,5	12,1	14,0	16,0
TENJI CC Cassette 360° 620 x 620				•	•								
TENJI CS Cassette 360° 950 x 950						•		•					
JATO Floor-ceiling mounted					•	•							
NEVO Ducted				•	•		•	•					

# Solution

## Multi 1:X



It allows you to create an extensive air conditioning system, in which, depending on your needs and preferences, you can configure up to any five air conditioners: wall, duct, cassette, floor-ceiling and console air conditioners operated by a single outdoor unit.



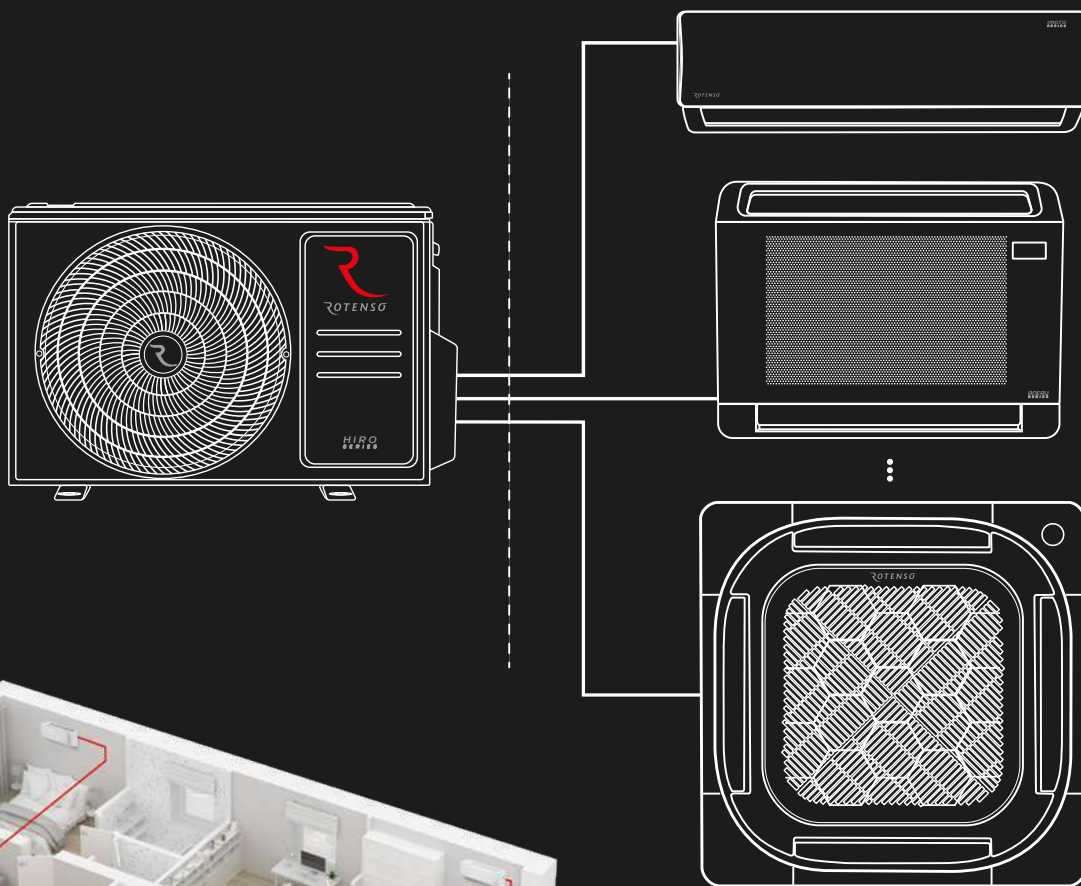



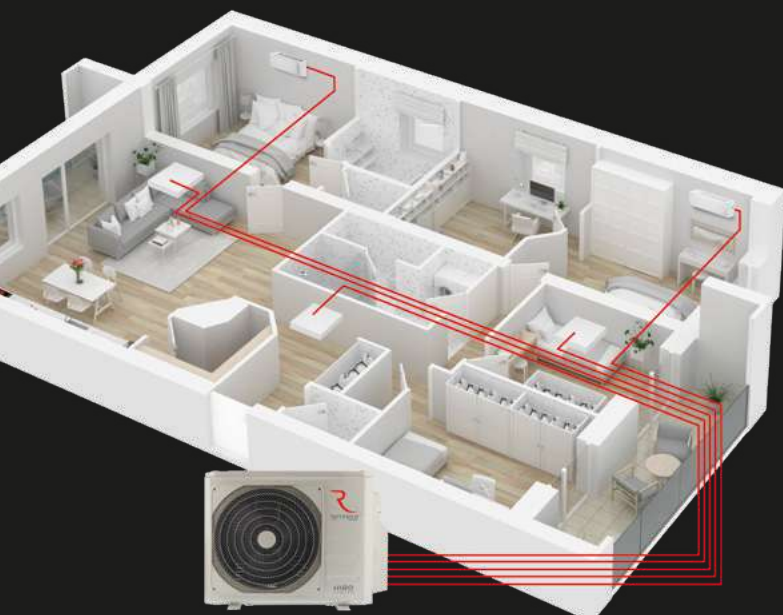







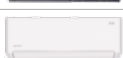

Choosing the multi system brings economic and aesthetic benefits. The ability to connect several air conditioners to a single unit means lower service costs, as well as space savings, lower noise emissions and less interference with the landscape.



22





Model name and category	Model	Power [kW]																						
		2,1	2,6	2,7	3,4	3,5	3,6	4,7	5,0	5,1	5,3	6,8	6,9	7,0	7,1	8,8	9,0	10,6	12,0	12,1	14,1	15,2	15,5	
MIRAI Wall-mounted			•			•																		
VERSU MIRROR <sup>NEW [R15]</sup> Wall-mounted			•			•					•													
VERSU PURE Wall-mounted			•			•					•													
VERSU CLOTH STONE Wall-mounted			•			•					•													
VERSU CLOTH CARAMEL Wall-mounted			•			•					•													
REVIO Wall-mounted			•			•					•				•									
TETA MIRROR Wall-mounted			•			•																		
TETA Wall-mounted			•			•																		
ELIS Wall-mounted			•			•					•													
ELIS SILVER Wall-mounted			•			•					•													
IMOTO Wall-mounted		•	•			•					•				•									
UKURA Wall-mounted		•	•			•					•				•									
RONI Wall-mounted			•			•					•													
TENJI CC Cassette 360° 620 x 620		•	•			•					•													
TENJI CS Cassette 360° 950 x 950															•									
JATO Floor-ceiling mounted											•				•									
NEVO Ducted		•	•			•					•				•									
ANERU Console			•			•			•															
ANERU AN Console						•		•																



# Solution

## Zone management

Airzone is a system for controlling and individually managing multiple zones with a single Rotenso Nevo ducted unit and the ability to integrate with a heat pump.

The advantages of zone management are:

- capacity energy efficiency and increased thermal comfort,
- centralized and remote control,
- system integration,
- control of up to 6 zones (ducted air conditioning),
- control of up to 8 circuits (heating),
- wired and wireless thermostats,
- cooperation with Rotenso Nevo ducted units,
- control of heating through thermoelectric heads.

24

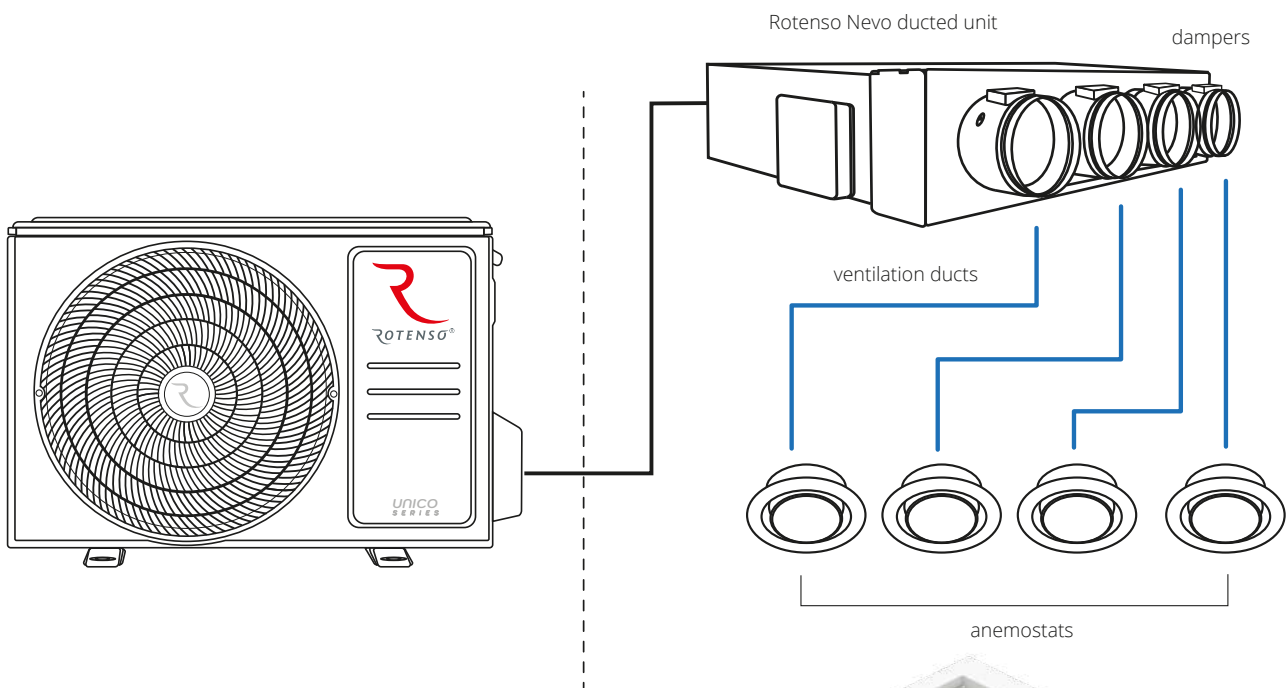

# AIR ZONE





## Control **air conditioning**

---

Zone management provides independent control of the temperature in each room through, among other things, thermostats that work together with dampers equipped with a fail-safe control actuator. Each thermostat additionally has a sensor for measuring relative humidity.

## Facilities **residential**

---



## Facilities **offices**

---



## Facilities **commercial**

---



# WE ARE COMFORT

Technology you'll love!  
**Rotenso air conditioning**  
is the ultimate in functionality  
and interesting design  
products suitable  
for any interior.

---



GENERATION X  
in Air Conditioning



## Generation X in air conditioning

28

Innovative technology, modern design and numerous features of Generation X air conditioners are the answer to the needs posed by reality.

You can demand this and much more from Generation X.



### Exceptional comfort

With its multi-level air purification system, intelligent control, Silent operation and mode Windless every day you will experience exceptional comfort.



## Zero-emission systems

Advanced technology makes Rotenso appliances compatible with each other - whether air conditioners, heat pumps, or and recuperators can be combined into one efficient and zero-emission system.



## Innovation for the environment

Innovation, ergonomics and environmentally friendly solutions are the features of Rotenso equipment. They can be supported by renewable energy sources such as photovoltaic panels, solar panels, etc.



## All-year-round operation devices

30

As a year-round unit, the air conditioner works effectively in heating mode at extremely low outdoor temperatures as low as  $-30^{\circ}\text{C}$ .

Rotenso air conditioners dedicated to heating reliably perform the heating function thanks to increased energy efficiency ratios and a built-in winter package, which consists of a built-in drip tray heater and compressor crankcase heater.

They counteract icing of the outdoor unit and fan disturbances, maintaining efficient operation of the unit and ensuring its long life. The technology used allows the air conditioner to work efficiently even in extreme weather conditions.



### Ready for the cold

Warming up the compressor prepares it for trouble-free and efficient operation in heating mode exactly when you need it.



Choose your model:



### Heating at -30°C outdoor temp.

Ideal solutions for the most severe frosts. Technology provides high heating capacity even down to an outdoor temperature of -30°C.

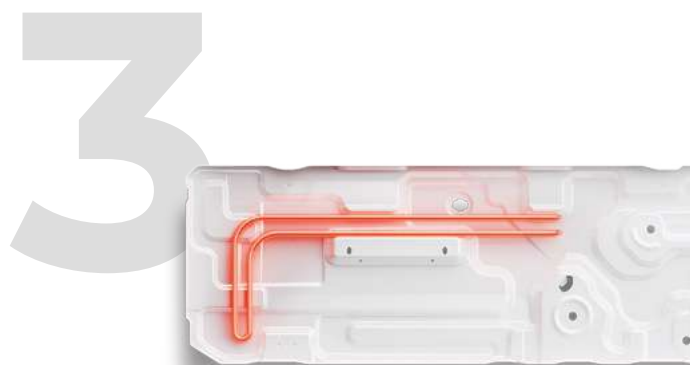

### No more icing

The drip tray heater used can quickly melt and remove snow and ice from inside the outdoor unit, ensuring the stability of the unit's operation.

Learn about  
the useful features  
and modes of  
**Rotenso**  
**air conditioners**

---



## eMOTO **Super quiet mode**

The unique fan design and modern motor of the indoor unit allow the air conditioner to operate comfortably and extremely quietly.



## Mode **silence**

For perfect comfort, there is an option to mute visual messages and sound signals of the air conditioner.



## eMOTO **ECO mode**

A special eco-friendly mode makes the air conditioner use up to 60% less electricity.



## Mode **1W standby**

The energy-saving function reduces power consumption in standby mode to 1W.



# Healthy air systems

---



## Automatic Purification iClean

---



The iClean function is an advanced option for sterilizing the exchanger of the air conditioner's indoor unit. It involves maximum cooling and then maximum heating of the exchanger to eliminate unwanted bacteria and fungi.



## Automatic cleaning iAIR

---



The iAIR cleaning function is an option that dries the exchanger of the air conditioner's indoor unit before completing its cooling operation. It prevents the growth of bacteria, fungi and contributes to improving indoor air quality.



## Electrostatic filter HD iAIR

---



One of the most effective ways to filter polluted air. It features high density and performance. Electrostatic discharge interacts with positively or negatively charged pollutant particles. As a result, the device blows clean air.



## Anti-corrosive gold-plated fins

---

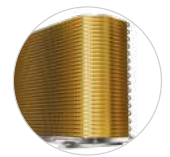

Thanks to their self-cleaning properties, they effectively protect the unit from bacterial growth, improving its performance. In addition, a unique gold fin effectively protects the air conditioner against corrosion.



## Super Ionizer iAIR

---



By creating negative oxygen ions, Super Ionizer iAIR eliminates viruses, bacteria, dust mites and allergens from the air. By acting on polluted air, it neutralizes unpleasant odours. Active Super Ionizer blade leaves the air clean and refreshed.



## Sterilization UV lamp

---



UV radiation has antibacterial properties, so it effectively breaks down organic elements and toxic substances such as benzene, ammonia, etc. UV radiation destroys the molecular structure of DNA or RNA of microorganisms, thus eliminating many bacteria from the air we breathe.

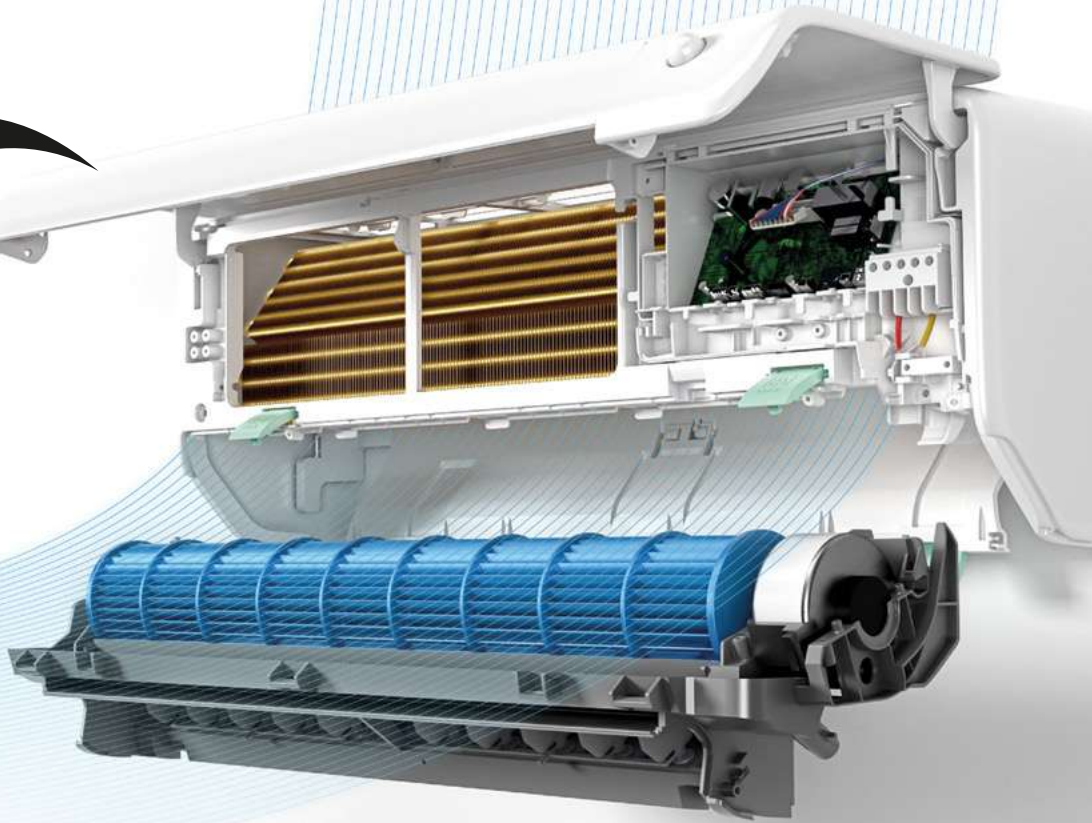

# Filters optional



Cold Nano filter + Dust mite filter + Vitamin C filter



Catechin + Silver Ion + Vitamin C filter



Antibacterial HEPA iAIR filter



Antibacterial EPA iAIR filter



Photocatalytic + Activated carbon + Cold Nano filters



Cold Nano iAIR + Activated carbon + Silver Ion filters



3M HAF filter



Cold Nano iAIR filter



Silver Ion filter



Ionizing filter



Activated Carbon iAIR filter



Jasmine flavouring filter



Active carbon filter with vitamin C



Enzyme iAIR filter

# Breathe of clean air

We understand perfectly well how important it is for you to take care of your health and care about the quality of the air you breathe every day. To meet these expectations, we have equipped Generation X units with a complete, effective air purification and filtration system. PureR Stage's healthy air system supports the antifungal and antimicrobial effects of gold-plated fins. It is based on efficient filters, ultraviolet radiation and ionization, which effectively purify the conditioned air from bacteria, viruses, fungi, and pollutants present in large numbers in the environment for your health.

**Filter  
electrostatic  
HD iAIR**

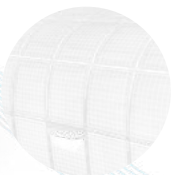

**Eliminates:**

- dust
- pollen
- larger pollutants

**Antibacterial  
gold-plated  
iAIR fins**



**Eliminates:**

- bacterial and fungal growth

**Antibacterial  
HEPA iAIR  
filter**

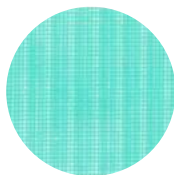

**Eliminates:**

- fungal cells
- protozoa
- bacteria
- viruses

**Fresh air  
filter  
EPA E12**



**Eliminates:**

- fungal cells
- dust
- pollen
- larger debris

**Silver Ion  
filter  
iAIR**

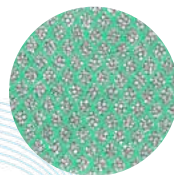

**Eliminates:**

- 99,9% of bacteria and fungi

**Filter  
with iAIR  
activated carbon**



**Eliminates:**

- ozone
- hydrocarbons
- sulphur compounds
- nitrogen

**iAIR  
photocatalytic  
filter**

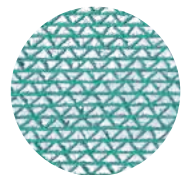

**Eliminates:**

- organic particles
- exhaust
- gases



QUANTITY OF LEVELS OF AIR QUALITY IMPROVEMENT PROCESSES PureR Stage		Electrostatic HD iAIR filter	Antibacterial gold-plated iAIR fins	Antibacterial HEPA iAIR filter	EPA E12 fresh air filter	Silver Ion iAIR filter
MIRAI	6-stage PureR Stage	•	•	•		•
FRESH	6-stage PureR Stage	•	•		•	
VERSU MIRROR [R15]	8-stage PureR Stage	•	•	•		•
VERSU PURE	8-stage PureR Stage	•	•	•		•
VERSU CLOTH	8-stage PureR Stage	•	•	•		•
REVIO	6-stage PureR Stage	•	•	•		
TETA / TETA MIRROR	12-stage PureR Stage	•	•			•
ELIS / ELIS SILVER	10-stage PureR Stage	•	•			•
IMOTO	6-stage PureR Stage	•	•	•		
UKURA, UKURA H	6-stage PureR Stage	•	•	•		
RONI	10-stage PureR Stage	•	•	•		•

## You can create your own healthy air system

We have taken care of the possibility of adding in the case of the need for additional filters to purify the air from, for example, tobacco smoke, pet dander, and to support allergy treatment or relieve stress.

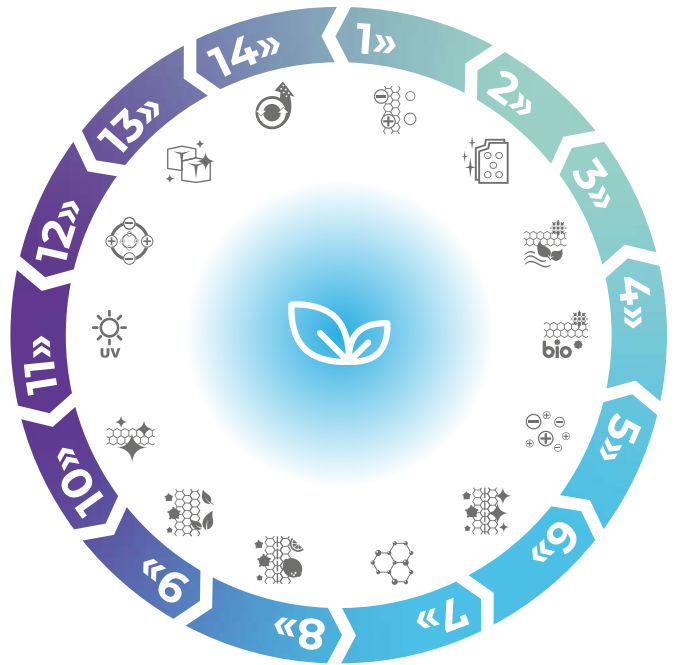

**Vitamin C filter iAIR**

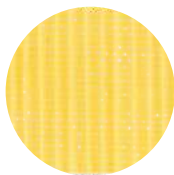

- Effective:**
- reduces stress levels
  - protects against UV rays

**Filter Catechin iAIR**

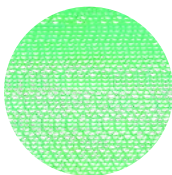

- Eliminates:**
- smell of cigarette smoke
  - kitchen fragrances

**Cold Nano iAIR filter**



- Eliminates:**
- harmful, organic compounds
  - volatile particles of formaldehyde

**UV lamp**



- Eliminates:**
- ammonia
  - benzene
  - bacteria

**Super Ionizer iAIR**



- Effective:**
- neutralizes free radicals
  - restores ionic balance

**Automatic purification iClean**



- Sterilizes:**
- the interior of the air conditioner from mold, dust and microbes

**Automatic cleaning iAIR**



- Dehumidification and cleanses:**
- interior of the air conditioner from moisture



Activated Carbon iAIR filter	Photo-catalytic iAIR filter	Vitamin C iAIR filter	Catechin iAIR filter	Cold Nano iAIR filter	UV lamp	Super Ionizer iAIR	Automatic purification iClean	Automatic cleaning iAIR
						•		•
					•		•	•
	•			•		•	•	
	•			•		•	•	
	•			•		•	•	
•	•	•	•	•	•	•	•	•
•	•	•	•	•		•	•	•
				•		•	•	•
				•		•	•	•
•	•	•	•	•		•	•	•

# eMOTO Smart Air supply systems

---



38

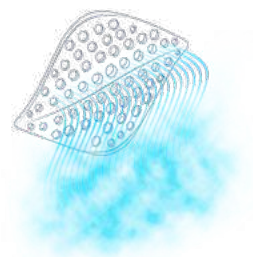

## eMOTO Windless mode

---

With Windless technology, the air conditioner releases air in a gentle, maximum dispersed stream at just 18 dB volume. Windless function is available in cooling mode on Teta, Teta Mirror and Fresh air conditioners.



## Louvre 180°

---

The horizontal louvre allows for precise air supply in any direction within a 180° up/down range.



## Sensor **SMART Eye**

---

The built-in smart presence sensor (SMART Eye) detects the user's presence, capable of performing SMART Eco Eye, SMART Eye Away or SMART Eye Follow functions.

The air conditioner optimizes performance when a user is present in the room: it follows the air supply to the person or avoids blowing on the person in the room.



**Turbo**

## eMOTO **Turbo mode**

---

Momentarily increases the capacity of the compressor and the fan allows the room to be cooled or heated faster. This can save up to 20% of the time it takes to reach the required temperature.



## Automatic **4D louvres**

---

Ability to automatically control the operation of horizontal and vertical louvres, as well as their automatic fanning by remote control or wired controller.



## eMOTO Air Supply **control systems**

---

Before starting the air supply in heating mode, the system starts working refrigeration system so as to prevent to the cold air supply.

WY  
M  
-  
D

## We know that **the details matter**

---

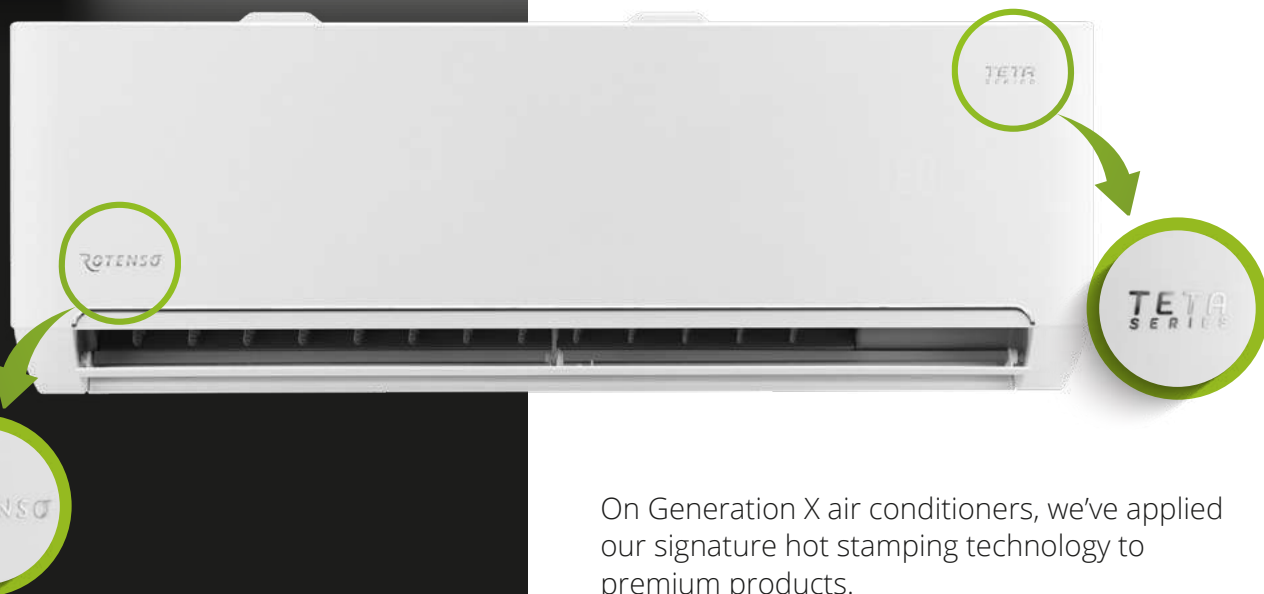

40

On Generation X air conditioners, we've applied our signature hot stamping technology to premium products.

The spacious, subtle silver-tone letters harmonize with the thoughtful design of the wall-mounted air conditioner models, giving our units a prestigious look.



# Intelligent control systems



## Dusk sensor

When darkness falls and the lights are turned off, the backlighting of the air conditioner will be smoothly extinguished and the sound signals will be muted.



## Humidity sensor

The relative humidity sensor allows you to ongoing monitoring of the humidity level in the room for ultimate comfort.



## SMART 8°C heating function

To prevent excessive cooling of the room, the air conditioner turns on automatically in heating mode. Thanks to this air temperature is maintained at 8°C.



## SMART heating to 12°C

This function is particularly useful during a prolonged absence. To ensure stable thermal conditions of the premises, the air conditioner turns on automatically in heating mode when the room temperature drops below 12°C.



## Energy optimization

Energy optimization is the function of saving energy consumption in case of a power outage and the need to use an emergency power source, such as an outdoor unit.



## On/off display SMART LED on panel

The ability to completely extinguish the display (e.g., during nighttime hours) provides the ultimate in air conditioner comfort.



# Optimization of work



## SMART Follow mode

Built into the controller is an additional temperature sensor allows you to precisely control the temperature in the room, which positively affects your thermal comfort.



42



## Timer

The function allows you to program the on and off time of the unit, making it easier to use the air conditioner.



## Self-diagnosis function

In case of a malfunction, an error message is presented on the unit's display or on the wired controller.



## SMART port of the wired controller

The smart connector offers the possibility to connect a wired controller to the air conditioner.



## Double-sided condensate drainage

Ability to drain condensate from both the left and right sides of the indoor unit.





## 1W standby mode

The energy-saving function reduces power consumption in standby mode to 1W. Saves up to 80% electricity compared to previous solutions.



## Sleep mode

A special program of operation of the device, in which the temperature and fan speed are automatically modified to ensure optimal conditions for a night's rest.



## Auto restart memory

A function to remember the last settings of the air-conditioning unit in the event of a temporary power failure. When switched on again, the air conditioner restores the previous operating mode.



## Setting memory louvers

The air conditioner remembers the last setting of the louvers, so that when they are restarted, their position is restored automatically - just the way you like it!



## Compressor crankcase heater

Thanks to the crankcase heater, the compressor is prepared for efficient and trouble-free operation in air conditioner heating mode, exactly when you need it. This ensures the unit's reliability for many years.

43



## Compressor winding heating

If necessary, the compressor's crankcase can also be warmed up with its winding, allowing it to operate at full capacity. In this way, the compressor is protected from failures and will serve its purpose for a long time.



## Drip tray heater

The built-in drip tray heater can quickly melt and remove snow and ice from inside the outdoor unit, ensuring stable operation of the device.





Can be integrated with:

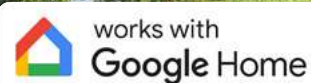

## Remotely control of air conditioner

The SmartLife-SmartHome and NetHome Plus apps allow you to control your air conditioner without a wireless controller. It is also possible to additionally program the unit to turn on or off.

Using SMART Wi-Fi and a Wi-Fi modem, the device can be controlled with a tablet or smartphone both inside and outside the home.



Control from home



Control outside your home



Timer work



Individual user profiles



Sleep mode



Self-diagnosis

App	Mirai	Fresh	Versu	Revio	Teta	Elis	Imoto	Ukura	Roni	Tenji	Nevo	Jato	Aneru	Aneru AN
SmartLife-SmartHome		•			•	•			•					•
Tuya Smart		•			•	•			•					•
Net Home Plus	•		•	•			•	•		•	•	•	•	



## Zone management

45

The Airzone Cloud app offers simple and intuitive management of the operation of the Rotenso Nevo zoning system. Ability to manage each zone separately. Access to the server through additional web modules.

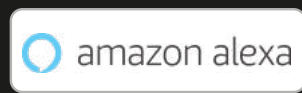

Using AIRZONE system, it is possible to integrate with a number of solutions that are available as expansion modules for, among others: Modbus, BACnet, KNX, Amazon Alexa, Google Assistant.

### Rotenso Nevo in combination with Airzone Cloud makes it possible:

- switching on/off each zone,
- editing the name of each zone,
- setting time schedules,
- setting the temperature for any zone,
- setting sleep mode for scheduled shutdown,
- setting of operating modes,
- enable Eco-Adapt function to improve energy efficiency of the installation,
- access to weather information and weather forecast.

System	Mode	Mirai	Fresh	Versu Mirror <sup>(R15)</sup>	Versu Pure	Versu Cloth	
<b>iAIR</b> Healthy air systems	Automatic cleaning iAIR <sup>(1)</sup>	•	•				
	Automatic purification iClean <sup>(1)</sup>		•	•	•	•	
	Fresh air supply		•				
	Super Ionizer iAIR	•		•	•	•	
	UV lamp		•				
	Cold Nano iAIR filter						
	3-in-1 filter (Catechin + Silver Ion + Vit. C) iAIR						
	3-in-1 filter (Silver Ion + Photocatalytic + Cold Nano) iAIR				•	•	
	3-in-1 filter (Photocatalytic + Act. carbon + Cold Nano) iAIR						
	Silver Ion iAIR filter	•					
	Antibacterial HEPA iAIR filter	•			•	•	
	Electrostatic HD iAIR filter	•	•	•	•	•	
	Fresh Air filter EPA iAIR			•			
	<b>eMOTO</b> Smart air supply systems	Super Silent eMOTO mode	•	•	•	•	•
Automatic 4D louvres		•	•	•	•	•	
Louvre 180°			•				
180° rotating louvre				•	•	•	
Windless eMOTO mode			•				
Turbo eMOTO mode		•	•	•	•	•	
Louvre setting memory		•	•	•	•	•	
Upwards cascade air supply				•	•	•	
Downwards cascade air supply				•	•	•	
Air supply eMOTO control system		•	•	•	•	•	
Eco eMOTO mode		•	•	•	•	•	
Wide-angle eMOTO air supply		•	•	•	•	•	
<b>SMART</b> Intelligent control systems		SMART Wi-Fi function	•	•	•	•	•
		Humidity sensor	•		•	•	•
	SMART Eye Away	•					
	SMART Eye Follow	•					
	SMART Eco Eye						
	SMART twilight sensor	•	•				
	Wired controller SMART port	•		•	•	•	
	Smart panel display ON/OFF	•	•	•	•	•	
	SMART Follow mode	•	•	•	•	•	
	Wireless remote controller	•	•	•	•	•	
	Wired controller	•		•	•	•	
	SMART heating to 8°C	•	•	•	•	•	
	SMART heating to 12°C	•					
	<b>OPTIMA</b> Optimization of work	1W standby mode	•		•	•	•
Auto restart memory		•	•	•	•	•	
Anti-corrosive gold fins		•	•	•	•	•	
Drip tray heater		•		•	•	•	
Compressor crankcase heater		•		•	•	•	
Compressor winding heating			•				
Silence mode		•	•	•	•	•	
Timer			•	•	•	•	
Cooling at low outdoor temperature down to -15°C			•	•	•	•	
Cooling at low outdoor temperature down to -25°C		•					
Heating at low outdoor temperature down to -20°C							
Heating at low outdoor temperature down to -22°C			•	•	•	•	
Heating at low outdoor temperature down to -25°C							
Heating at low outdoor temperature down to -30°C		•					
Double-sided condensate drainage		•		•	•	•	
Self-diagnosis function		•		•	•	•	
Sleep mode		•		•	•	•	
Energy optimization				•	•	•	
BMS Modbus		•		•	•	•	
BMS Bacnet		•		•	•	•	
Dedicated for heating		•		•	•	•	

		Revio	Teta Mirror	Teta	Elis	Elis Silver
<b>iAIR</b> Healthy air systems	Automatic cleaning iAIR <sup>(1)</sup>		•	•	•	•
	Automatic purification iClean <sup>(1)</sup>	•	•	•	•	•
	Fresh air supply					
	Super Ionizer iAIR	•	•	•		
	UV lamp		•	•		
	Cold Nano iAIR filter	•				
	3-in-1 filter (Catechin + Silver Ion + Vit. C) iAIR		•	•	•	•
	3-in-1 filter (Silver Ion + Photocatalytic + Cold Nano) iAIR			•	•	•
	3-in-1 filter (Photocatalytic + Act. carbon + Cold Nano) iAIR			•	•	•
	Silver Ion iAIR filter				•	•
	Antibacterial HEPA iAIR filter	•				
	Electrostatic HD iAIR filter	•	•	•	•	•
	Fresh Air filter EPA iAIR					
<b>eMOTO</b> Smart air supply systems	Super Silent eMOTO mode	•	•	•	•	•
	Automatic 4D louvres	•	•	•	•	•
	Louvre 180°					
	180° rotating louvre					
	Windless eMOTO mode		•	•		
	Turbo eMOTO mode	•	•	•	•	•
	Louvre setting memory	•	•	•		
	Upwards cascade air supply					
	Downwards cascade air supply					
	Air supply eMOTO control system	•	•	•	•	•
	Eco eMOTO mode	•	•	•	•	•
	Wide-angle eMOTO air supply	•	•	•	•	•
	<b>SMART</b> Intelligent control systems	SMART Wi-Fi function	•	•	•	•
Humidity sensor		•				
SMART Eye Away		•				
SMART Eye Follow						
SMART Eco Eye		•				
SMART twilight sensor						
Wired controller SMART port		•				
Smart panel display ON/OFF		•	•	•	•	•
SMART Follow mode		•	•	•	•	•
Wireless remote controller		•	•	•	•	•
Wired controller		•				
SMART heating to 8°C		•	•	•	•	•
SMART heating to 12°C						
<b>OPTIMA</b> Optimization of work	1W standby mode	•				
	Auto restart memory	•	•	•	•	•
	Anti-corrosive gold fins	•	•	•	•	•
	Drip tray heater	•	•	•		
	Compressor crankcase heater	•				
	Compressor winding heating		•	•		
	Silence mode	•				
	Timer	•	•	•	•	•
	Cooling at low outdoor temperature down to -15°C	•	•	•	•	•
	Cooling at low outdoor temperature down to -25°C					
	Heating at low outdoor temperature down to -20°C				•	•
	Heating at low outdoor temperature down to -22°C					
	Heating at low outdoor temperature down to -25°C	•	•	•		
	Heating at low outdoor temperature down to -30°C					
	Double-sided condensate drainage	•	•	•	•	•
	Self-diagnosis function	•	•	•	•	•
	Sleep mode	•				
	Energy optimization			•		
	BMS Modbus	•				
	BMS Bacnet	•				
Dedicated for heating	•	•	•			

System	Mode	Imoto	Ukura H	Ukura	Roni	
iAIR Healthy air systems	Automatic cleaning iAIR <sup>(1)</sup>	•	•	•	•	
	Automatic purification iClean <sup>(1)</sup>				•	
	Fresh air supply					
	Super Ionizer iAIR	•	•	•		
	UV lamp					
	Cold Nano iAIR filter	•	•	•		
	3-in-1 filter (Catechin + Silver Ion + Vit. C) iAIR				•	
	3-in-1 filter (Silver Ion + Photocatalytic + Cold Nano) iAIR					
	3-in-1 filter (Photocatalytic + Act. carbon + Cold Nano) iAIR				•	
	Silver Ion iAIR filter					
	Antibacterial HEPA iAIR filter	•	•	•		
	Electrostatic HD iAIR filter	•	•	•	•	
	Fresh Air filter EPA iAIR					
	eMOTO Smart air supply systems	Super Silent eMOTO mode	•	•	•	•
		Automatic 4D louvres	•	•	•	•
Louvre 180°						
180° rotating louvre						
Windless eMOTO mode						
Turbo eMOTO mode		•	•	•	•	
Louvre setting memory		•	•	•		
Upwards cascade air supply						
Downwards cascade air supply						
Air supply eMOTO control system		•	•	•	•	
Eco eMOTO mode					•	
Wide-angle eMOTO air supply		•	•	•	•	
SMART Intelligent control systems		SMART Wi-Fi function	•	•	•	•
		Humidity sensor				
		SMART Eye Away				
	SMART Eye Follow					
	SMART Eco Eye					
	SMART twilight sensor					
	Wired controller SMART port	•	•	•		
	Smart panel display ON/OFF	•	•	•	•	
	SMART Follow mode	•	•	•	•	
	Wireless remote controller	•	•	•	•	
	Wired controller	•	•	•		
	SMART heating to 8°C	•	•	•	•	
	SMART heating to 12°C					
	OPTIMA Optimization of work	1W standby mode	•	•	•	
		Auto restart memory	•	•	•	•
Anti-corrosive gold fins		•	•	•	•	
Drip tray heater		•	•			
Compressor crankcase heater		•	•			
Compressor winding heating						
Silence mode		•	•	•		
Timer		•	•	•	•	
Cooling at low outdoor temperature down to -15°C		•	•	•	•	
Cooling at low outdoor temperature down to -25°C						
Heating at low outdoor temperature down to -20°C			•	•	•	
Heating at low outdoor temperature down to -22°C		•				
Heating at low outdoor temperature down to -25°C						
Heating at low outdoor temperature down to -30°C						
Double-sided condensate drainage		•	•	•	•	
Self-diagnosis function		•	•	•	•	
Sleep mode		•	•	•	•	
Energy optimization						
BMS Modbus		•				
BMS Bacnet		•				
Dedicated for heating	•	•				

		Aneru HP	Aneru	Aneru AN	Tenji CC	Tenji CS	Jato	Nevo	
<b>SKYR Modern Technology</b>	SKY® DC motors	•	•	•	•	•	•	•	
	Digital DC Inverter SKY®	•	•	•	•	•	•	•	
<b>iAIR Healthy air systems</b>	Automatic cleaning iAIR <sup>(1)</sup>			•					
	Automatic purification iClean <sup>(1)</sup>	•	•		•	•	•	•	
	Electrostatic HD iAIR filter	•	•	•	•	•	•	•	
	Super Ionizer iAIR	•	•						
<b>eMOTO Smart air supply systems</b>	Super quiet mode eMOTO	•	• <sup>(1)</sup>	•	• <sup>(1)</sup>	• <sup>(1)</sup>			
	Turbo eMOTO mode	•	• <sup>(1)</sup>	•	• <sup>(1)</sup>	• <sup>(1)</sup>		• <sup>(1)</sup>	
	Louvre setting memory	•	•	•	•	•	•		
	Air supply eMOTO control system	•	•	•	•	•	•	•	
	Wide-angle eMOTO air supply	•	•	•	•	•	•	•	
	Eco eMOTO mode	•	• <sup>(1)</sup>	•	• <sup>(1)</sup>	• <sup>(1)</sup>	• <sup>(1)</sup>	• <sup>(1)</sup>	
	Automatic louvre	•	•	•					
	Automatic 4D louvres				•	•	•		
	Double-sided air supply	•	•	•					
	Four-sided air supply								
	360° air supply				•	•			
	Individual louvre control				•	•			
	Additional air supply				•	•		•	
	<b>SMART Intelligent control systems</b>	SMART Wi-Fi function (USB modem included)	•	•	•	•	•		•
		Smart Wi-Fi (optional modem)						• <sup>(3)</sup>	
Humidity sensor <sup>(1)</sup>		• <sup>(2)</sup>	• <sup>(2)</sup>		• <sup>(2)</sup>	• <sup>(2)</sup>			
Wired controller SMART port		• <sup>(3)</sup>	• <sup>(3)</sup>		•	•	•	•	
SMART LED temperature display		•	•	•	•	•	•		
Smart panel display ON/OFF		•	•	•	•	•	•		
SMART Follow mode		•	•	• <sup>(1)</sup>	•	•	•	•	
SMART heating to 8°C <sup>(1)</sup>		•	•		•	•	•	•	
Wireless remote controller		•	•	•	•	•	•	• <sup>(3)</sup>	
Wired controller		• <sup>(3)</sup>	• <sup>(3)</sup>		• <sup>(3)</sup>	• <sup>(3)</sup>	• <sup>(3)</sup>	•	
<b>OPTIMA Optimization of work</b>	Auto restart memory	•	•	•	•	•	•	•	
	Anti-corrosive gold fins	•	•	•	•	•	•	•	
	Compressor winding heating			•					
	Drip tray heater	•	•	•	•	•	•	•	
	Compressor crankcase heater	•	•		•	•	•	•	
	Silence mode	•	•					•	
	Timer	•	•	•	•	•	•	•	
	Cooling at low outdoor temperature down to -15°C		•	•	•	•	•	•	
	Cooling at low outdoor temperature down to -25°C	•							
	Heating at low outdoor temperature down to -20°C		•	•	•	•	•	•	
	Heating at low outdoor temperature down to -30°C	•							
	Double-sided condensate drainage						•	•	
	Self-diagnosis function	•	•	•	•	•	•	•	
	Sleep mode	•	•	•	•	•	•	• <sup>(3)</sup>	
	Integrated condensate pump				•	•		•	
	Fresh air supply				• <sup>(3)</sup>	• <sup>(3)</sup>		• <sup>(3)</sup>	
	ON/OFF remote output	• <sup>(3)</sup>	• <sup>(3)</sup>		•	•	•	•	
	Alarm output	• <sup>(3)</sup>	• <sup>(3)</sup>		•	•	•	•	
	Weekly controller output	• <sup>(3)</sup>	• <sup>(3)</sup>		•	•	•	•	
	Central controller output	• <sup>(3)</sup>	• <sup>(3)</sup>		•	•	•	•	
	Adjustable static pressure							•	
	Vertical and horizontal installation possible						•	•	
	Synchro - simultaneous operation					• <sup>(3)</sup>	• <sup>(3)</sup>	• <sup>(3)</sup>	
BMS Modbus	• <sup>(3)</sup>	• <sup>(3)</sup>		• <sup>(3)</sup>	• <sup>(3)</sup>	• <sup>(3)</sup>	• <sup>(3)</sup>		
BMS Bacnet	• <sup>(3)</sup>	• <sup>(3)</sup>		• <sup>(3)</sup>	• <sup>(3)</sup>	• <sup>(3)</sup>	• <sup>(3)</sup>		
Dedicated for heating	•	•		•	•	•	•		

1. Feature not available in Multi Split system. 2. Feature can be accessed via mobile app 3. Feature is only available as an option





1:1:1  
2  
1:1:1  
X  
1:1:1

## Air conditioners **Single, Dual, Multi**

---

**Your needs are our priority. That's why we have developed devices that will be a source of unparalleled comfort whether you are alone, spending time with loved ones or when you are working.**

Our air conditioning systems are versatile, so they can be tailored to meet the most exorbitant expectations.

The use of state-of-the-art technology makes them stand out for their energy efficiency and functionality.

A wide range of units with different parameters, compact dimensions and stylish design allow you to match the air conditioning system to any decor. Aesthetics and efficiency are our motto.

# WE ARE COOL & HEAT

All Rotenso's air conditioners offer **high capacity, energy saving, quiet operation and efficiency of cooling and heating.**

**An example is the new lines Multi Split systems: HP-LINE, S-LINE and N-LINE.**

COMFORT | DESIGN  
TECHNOLOGY



Rotenso Versu Mirror R15



## Wall-mounted air conditioner **Mirai**

**Not interested in compromises?  
Reach boldly for power! Mirai is maximum  
efficient technology and the highest energy  
efficiency class A+++.**

The advanced inverter technology used in the unit allows the unit to work efficiently even in extreme weather conditions.

As a result, the Mirai air conditioner effectively works even when the temperature outside drops to -30°C.

The built-in intelligent presence sensor (SMART EYE) detects the user's presence and automatically adjusts the direction and air flow to suit individual needs. This unique technology avoids or tracks the user's air flow in the room.

A special air outlet design distributes warm air to the ground and each corner of the room, and cooled air to the ceiling. This guarantees ultimate comfort.



**SMART EYE FOLLOW**  
FUNCTION AVAILABLE  
IN HEATING MODE





Function  
**SMART Eye Away**

The intelligent eye detects the activity of a person in the room and allows you to adjust the horizontal angle of the airflow to implement an airflow pattern that avoids the person in the room. Function available *in Cooling mode*.



Function  
**SMART Eye Follow**

The intelligent eye detects the activity of the person in the room and allows you to adjust the horizontal angle of air flow, to follow the air supply to the person in the room. The function is available *in Heating mode*.



Capacity 100%  
**at temp. -15°C**

Mirai achieves unparalleled performance in other units 100% efficiency at an outdoor temperature of -15°C. This makes it effectively heat your room even at low temperatures.



Heating power  
**up to 7,2 kW**

In turbo mode, the air conditioner achieves a high heating capacity of up to 7,2 kW, allowing you to heat the room in less time.



Heating  
**at -30°C**

The applied compressor technology, EXV valve and year-round operation package guarantee unprecedented efficiency of the air conditioner in heating mode, even in extreme weather conditions. In addition to the function of air-conditioning the room, this year-round device can work as the only source of heat in a house, apartment or office.



The highest energy  
**efficient class A+++**

Low power consumption means lower electricity bills.



## Features device

 Digital DC Inverter SKY <sup>®</sup>	 Automatic cleaning iAIR <sup>(1)</sup>	 Super Ionizer iAIR	 Silver Ion iAIR filter	 Antibacterial HEPA iAIR filter	 Electrostatic HD iAIR filter	 Super Silent eMOTO mode <sup>(1)</sup>	 Automatic 4D louvres
 Turbo eMOTO mode <sup>(1)</sup>	 Air supply eMOTO control system	 Eco eMOTO mode <sup>(1)</sup>	 Wide-angle eMOTO air supply	 SMART wi-fi	 Humidity sensor <sup>(1)(3)</sup>	 SMART Eye Away <sup>(1)</sup>	 SMART Eye Follow <sup>(1)</sup>
 SMART twilight sensor <sup>(1)</sup>	 Wired controller SMART port <sup>(2)</sup>	 Smart panel display ON/OFF	 SMART Follow mode	 Wireless remote controller	 Wired controller <sup>(2)</sup>	 SMART heating to 8°C <sup>(1)</sup>	 SMART heating to 12°C <sup>(1)</sup>
 Louvre setting memory	 1W standby mode <sup>(1)</sup>	 Auto restart memory	 Anti-corrosive gold fins	 Drip tray heater	 Compressor crankcase heater	 Silence mode	 Timer
 Cooling at low outdoor temp. down to -25°C <sup>(1)</sup>	 Heating at low outdoor temp. down to -30°C <sup>(1)</sup>	 Double-sided condensate drainage	 Self-diagnostics	 Sleep mode	 BMS Modbus <sup>(2)</sup>	 BMS Bacnet <sup>(2)</sup>	

Model				Mirai 2,6 kW	Mirai 3,5 kW
Capacity	Cooling	Nom. (Min. - Max.)	W	2638 (999-4158)	3517 (1031-4816)
Rated input		Nom. (Min. - Max.)	W	483 (87-1955)	750 (102-1955)
Operating current		Nom. (Min. - Max.)	A	2,1 (0,4-8,5)	3,3 (0,4-8,5)
Capacity	Heating	Nom. (Min. - Max.)	W	4103 (753-7000)	4250 (752-7200)
Rated input		Nom. (Min. - Max.)	W	834 (104-1955)	924 (104-2625)
Operating current		Nom. (Min. - Max.)	A	3,6 (0,5-8,5)	4,1 (0,4-11,4)
Reversible heat pump type				air-to-air	air-to-air
Design load in cooling mode			kW	2,6	3,5
SEER			W/W	9,3	9,2
Energy efficiency class - cooling				A+++	A+++
Annual electric energy consumption - cooling			kWh/a	98	133
Design load in heating mode (T <sub>biv</sub> -7°C)			kW	2,2	2,2
SCOP			W/W	5,3	5,3
Energy efficiency class - heating				A+++	A+++
Annual electric energy consumption - heating			kWh/a	620	620
Dehumidification			l/h	1,0	1,2
Maximum energy consumption			W	2950	2950
Maximum operating current			A	12,8	12,8
Indoor unit				M26Xi	M35Xi
EAN product code				5905567605918	5905567600852
Fan speed	T / H / M / L / ML / S	rpm	1250 / 1120 / 1050 / 690 / 630 / 580	1250 / 1120 / 1050 / 690 / 630 / 580	
Air flow	T / H / M / L / ML / S	m³/h	590 / 530 / 450 / 360 / 300 / 230	590 / 530 / 450 / 360 / 300 / 230	
Sound pressure level	T / H / M / L / ML / S	dB(A)	43 / 38 / 34 / 28 / 24 / 21	43 / 38 / 34 / 28 / 24 / 21	
Sound power level		dB(A)	59	59	
Rated input		W	23	23	
Operating current		A	0,2	0,2	
Net dimensions	W × D × H	mm	895 × 248 × 298	895 × 248 × 298	
Gross dimensions	W × D × H	mm	985 × 370 × 345	985 × 370 × 345	
Net weight / Gross weight		kg	13 / 17,1	13 / 17,1	
Condensate drain		mm	16	16	
Outdoor unit				M26Xo	M35Xo
EAN product code				5905567606793	5905567600869
Fan speed	H / M / L	rpm	850 / 750 / 450	850 / 750 / 450	
Maximum air flow		m³/h	2350	2350	
Sound pressure level		dB(A)	56	56	
Sound power level		dB(A)	60	60	
Net dimensions	W × D × H	mm	805 × 330 × 554	805 × 330 × 554	
Gross dimensions	W × D × H	mm	915 × 370 × 615	915 × 370 × 615	
Bracket spacing	W × D	(mm)	511 × 317	511 × 317	
Net weight / Gross weight		kg	28,4 / 31	28,4 / 31	
Refrigerant	Type		R32	R32	
	GWP*		675	675	
	Charged (≤ 5m)	kg	0,90	0,90	
		TCO <sub>2</sub> eq	0,607	0,607	
Charged (> 5m)	g/m	12	12		
Pipe connections	Liquid / Gas	mm (inch)	Φ6,35 / Φ9,52 (1/4" / 3/8")	Φ6,35 / Φ9,52 (1/4" / 3/8")	
Maximum installation length		m	25	25	
Maximum height difference		m	10	10	
Compressor type				Rotary DC	Rotary DC
Type of outdoor unit power supply		V-Hz, Ø	220-240-50, 1f	220-240-50, 1f	
Current protection		A	B16	B16	
Power cables: outdoor unit	L < 20m	pcs × mm²	3 × 1,5	3 × 1,5	
Control and power cables: indoor unit - outdoor unit		pcs × mm²	5 × 1,5	5 × 1,5	
Control and power cables: Hiro unit - indoor unit		pcs × mm²	4 × 1,5	4 × 1,5	
Indoor operating range (cooling / heating)		°C	16-32 / 0-30	16-32 / 0-30	
Outdoor operating range (cooling / heating)		°C	-25-50 / -30-30	-25-50 / -30-30	
Compatible systems					
1:1 SINGLE				•	•
1:2 DUAL					
1:X MULTI S-LINE				•	•
1:X MULTI N-LINE					
1:X MULTI HP-LINE				•	•

T - Turbo ; H - High; M - Medium; L - Low; ML - Medium Low; S - Silent



## Wall-mounted air conditioner **Fresh**

**Rotenso Fresh, with its innovative technology that allows fresh air to be supplied to the room, is a solution for users for whom health considerations are particularly important.**

58

Fresh air intake in Fresh mode is carried out by means of an installed additional ventilation pipe included in the kit and an additional fan. The air supplied to the room from the outside is filtered and then released by means of a pull-out disk from the top of the air conditioner panel. Depending on your preference, you can enjoy the striking illumination of the ejectable disk and the front panel or turn off the illumination functions.

The simple body and the extinguished white of the structured front panel decorated with silver piping will perfectly suit minimalist interiors. The Fresh air conditioning comfort experience consists of Louvre 180° and Windless technology.

Fresh system (fresh air intake), up to 3 built-in LED UV lamps and air filter are the advantages of the unit recommended especially for rooms without efficient ventilation.



DIRECT INFLOW OF  
**FRESH AIR**





### Inflow of **fresh air**

Fresh system allows the supply of fresh air into the room with a flow rate of up to 35 m<sup>3</sup>/h. Distribution of air from the outside is carried out by means of an additional insulated ventilation pipe (dia. 50 mm and a length of 2 m), which is part of the set, and a fan, the operation of which we can smoothly regulate with three gears.



### Comfortable **windless air supply**

With Windless technology - the air conditioner releases air in a gentle, maximum dispersed stream through 1330 microperforations achieving a volume at the lowest fan speed of only 18 dB.



### Fresh air filter **EPA E12**

Fresh air, from outside before being released into the room, flows through an EPA E12 class filter, making its quality much better.



### Louvre **180°**

A horizontal louvre operating in two independent planes allows precise air supply in any direction within a Range of 180° up and down.



### Built-in **3 x UV lamps**

Built-in three UV-C iAIR LED lamps effectively eliminate and block the proliferation of microorganisms, bacteria, fungi and toxic substances, making the room air healthier.



### Heating **even at -22°C**

The inverter technology used and the compressor crankcase warm-up function guarantee efficient operation of the air conditioner in heating mode, even at -22°C, achieving SCOP efficiency of 4.6.



# FRESH AIR

60

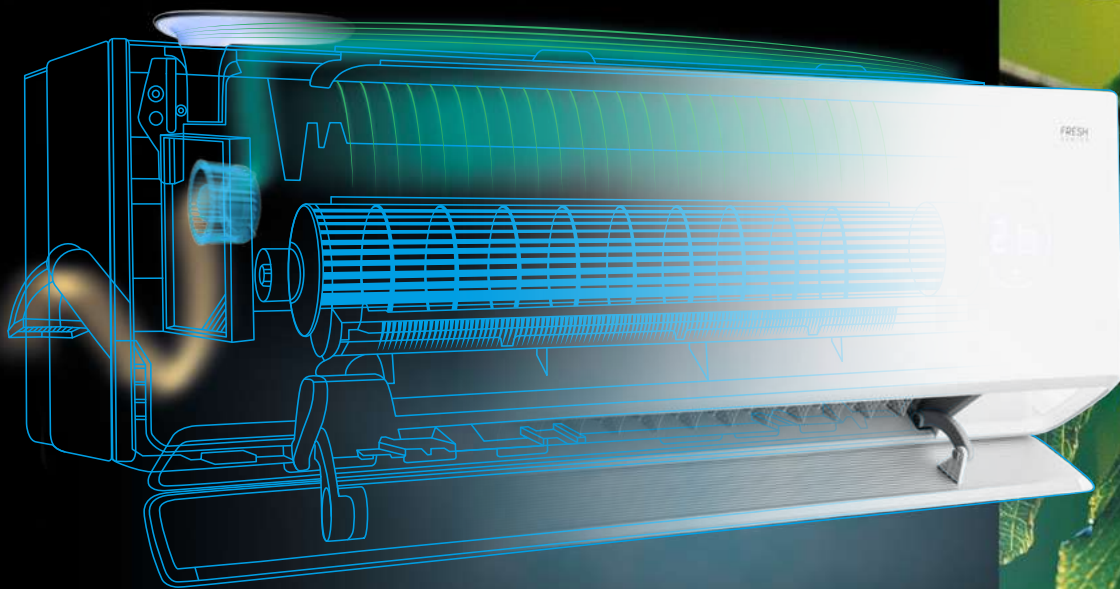
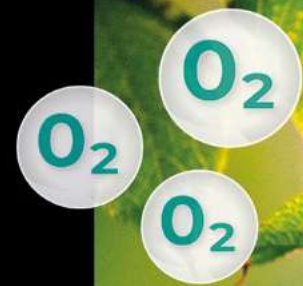

DIRECT SUPPLY OF FRESH,  
FILTERED AND HUMIDIFIED  
AIR FROM OUTSIDE



Quiet operation

FRESH AIR DISC

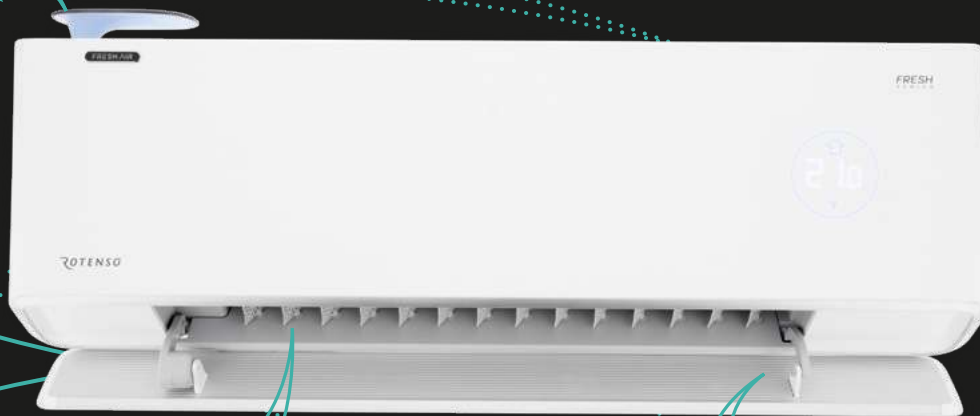

61

WINDLESS AIR SUPPLY

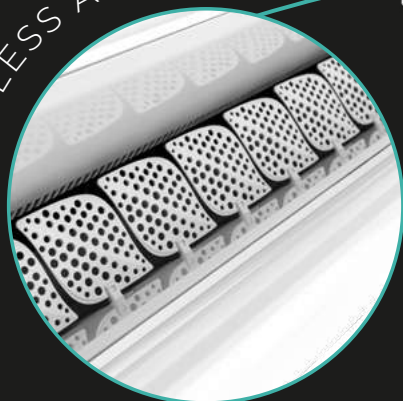

**FRESH**  
PRACTICAL  
AND MODERN

LOUVER 180°



With its innovative Fresh technology, the air conditioner ensures exchange and optimal indoor air quality, both in terms of temperature and humidity.

The air conditioner is an excellent solution for rooms in buildings without mechanical ventilation, where there may be a lack of fresh air after thermal upgrading. The quality of the incoming air is further taken care of by up to 3 built-in UV lamps and an EPA E12 air filter.

 **klimaakcia**  
**FRESH**  
AIR  
WINDLESS

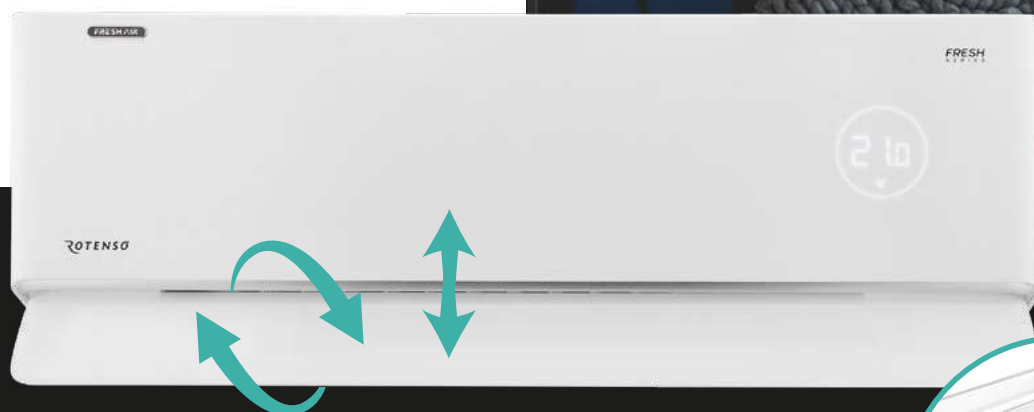

**FRESH** WITH LOUVRE 180°  
AND COMFORT FUNCTION WINDLESS

The Fresh air conditioning comfort experience consists of a 180° louvre and Windless technology, whereby, cooled or heated air is released into the room in a maximally dispersed stream flowing through 1330 micro-perforations.

In addition, Louvre 180° allows the user a to have a very wide Range of control over the air flow angle, thus achieving thermal comfort.

**klimaakcia**  
[www.klimaakcia.sk](http://www.klimaakcia.sk)



COMFORTABLE  
SETTING  
LOUVRES



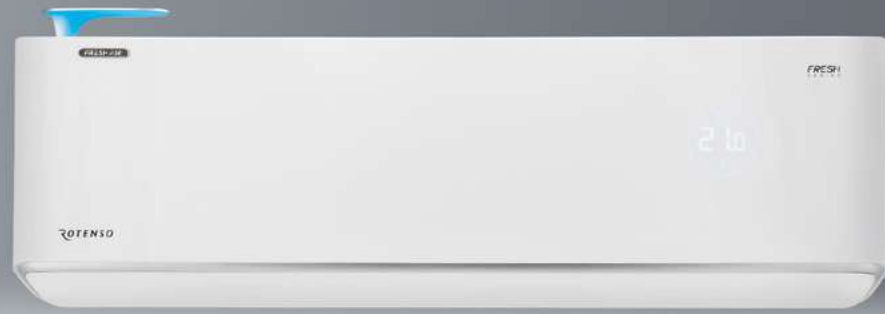

## Features device

64



Digital DC Inverter SKY<sup>®</sup>



Automatic cleaning iAIR



Automatic purification iClean



Fresh air supply



UV lamp



Electrostatic HD iAIR filter



EPA E12 fresh air filter



Super Silent eMOTO mode



Automatic 4D louvres



Louvre 180°



Windless eMOTO mode



Turbo eMOTO mode



Air supply control system eMOTO



ECO eMOTO mode



Wide angle eMOTO air supply



SMART Wi-Fi



SMART twilight sensor <sup>(1)</sup>



Smart panel display ON/OFF



SMART Follow mode



Wireless remote controller



SMART heating to 8°C



Louvre setting memory



Auto restart memory



Anti-corrosive gold fins



Compressor winding heating



Silence mode



Timer



Cooling at low outdoor temp. down to -15°C



Heating at low outdoor temp. down to -22°C



Double-sided condensate drainage



Self-diagnostics



Sleep mode



Energy optimization

1. Feature can be accessed via mobile app.

Model				Fresh 3,6 kW
Capacity	Cooling	Nom. (Min. - Max.)	W	3630 (1000-4000)
Rated input		Nom. (Min. - Max.)	W	921 (290-1510)
Operating current		Nom. (Min. - Max.)	A	4,0 (1,3-6,5)
Capacity	Heating	Nom. (Min. - Max.)	W	3900 (1000-4500)
Rated input		Nom. (Min. - Max.)	W	994 (290-1950)
Operating current		Nom. (Min. - Max.)	A	4,3 (1,3-8,5)
Reversible heat pump type				air-to-air
Design load in cooling mode			kW	3,6
SEER			W/W	8,5
Energy efficiency class - cooling				A+++
Annual electric energy consumption - cooling			kWh/a	148
Design load in heating mode (T <sub>biv</sub> -7°C)			kW	2,7
SCOP			W/W	4,6
Energy efficiency class - heating				A++
Annual electric energy consumption - heating			kWh/a	822
Dehumidification			l/h	1,2
Maximum energy consumption			W	1950
Maximum operating current			A	8,5
Indoor unit				FH35Xi
EAN product code				5905567600876
Fan speed	T / H / M / L / ML / S		rpm	1270 / 1200 / 1070 / 900 / 700 / 600
Air flow	T / H / M / L / ML / S		m <sup>3</sup> /h	660 / 542 / 474 / 405 / 295 / 205
Sound pressure level	T / H / M / L / ML / S		dB(A)	41 / 37 / 32 / 24 / 21 / 18
Sound power level			dB(A)	51
Rated input			W	26
Operating current			A	0,1
Net dimensions	W × D × H		mm	960 × 198 × 316
Gross dimensions	W × D × H		mm	1035 × 360 × 390
Net weight / Gross weight			kg	13 / 15
Condensate drain			mm	16
Outdoor unit				FH35Xo
EAN product code				5905567600883
Fan speed	H / M / L		rpm	1000 / 720 / 480
Maximum air flow			m <sup>3</sup> /h	2200
Sound pressure level			dB(A)	51
Sound power level			dB(A)	61
Net dimensions	W × D × H		mm	795 × 305 × 551
Gross dimensions	W × D × H		mm	835 × 328 × 575
Bracket spacing	W × D		(mm)	434 × 278
Net weight / Gross weight			kg	26,5 / 29,5
Refrigerant	Type			R32
	GWP*			675
	Charged (≤ 5m)		kg	0,805
			TCO <sub>2</sub> eq	0,544
Charged (> 5m)		g/m	12	
Pipe connections	Liquid / Gas		mm (inch)	Φ6,35 / Φ9,52 (1/4" / 3/8")
Maximum installation length			m	25
Maximum height difference			m	10
Compressor type				Rotary DC
Type of outdoor unit power supply			V-Hz, Ø	220-240-50, 1f
Current protection			A	B10
Power cables: outdoor unit	L < 20m		pcs × mm <sup>2</sup>	3 × 1,5
Control and power cables: indoor unit - outdoor unit			pcs × mm <sup>2</sup>	4 × 1,5
Control and power cables: hiro unit - indoor unit			pcs × mm <sup>2</sup>	-
Indoor operating range (cooling / heating)			°C	16~32 / 0~30
Outdoor operating range (cooling / heating)			°C	-15~53 / -22~30
Compatible systems				
1:1 SINGLE				•
1:2 DUAL				
1:X MULTI S-LINE				
1:X MULTI N-LINE				
1:X MULTI HP-LINE				

T - Turbo ; H - High; M - Medium; L - Low; ML - Medium Low; S - Silent



## Wall-mounted air conditioner **Versu Mirror**

**A new version of the iconic premium model among Rotenso air conditioners. The Versu Mirror's aesthetics are created by a dark-grey, gently iridescent casing and an interesting body. A striking finish is a sheet of dark mirror on the front of the air conditioner.**

The graphite Versu Mirror impresses with its aesthetics of workmanship, in addition to taking excellent care of air quality. The use of a series of filters and Super Ionizer iAIR allows the removal of harmful gases, viruses, bacteria, dust mites and allergens from the air, which positively affects the well-being of the occupants of the room. A built-in humidity sensor allows you to monitor air parameters that are important for well-being and health.

The high capacity of heating operation and the year-round operation package (Drip tray heater and Compressor crankcase heater) make the Versu Mirror also perfect for space heating even in extremely low temperatures down to -22°C.

With a rotating louvre 180° and the ability to control all louvres, the air conditioner releases air in a cascading yet gentle manner.



# 180°

klimaakcia  
ROTATING LOUVRE 180°  
[www.klimaakcia.sk](http://www.klimaakcia.sk)



# VERSU MIRROR



## Luxurious front panel

The dark-graphite, gently iridescent casing impressively finished with a sheet of dark mirror, makes up the modern and elegant design of the air conditioner.



## Volume only 19 dB

The unit can operate in Super Silent eMOTO mode, so it does not disturb your rest.



## Automatic 4D louvres

Built-in actuators allow you to control the operation of vertical and horizontal blinds with a remote control or wall-mounted controller. This guarantees the highest level of operating comfort and ensures efficient air distribution in the room.



## Rotating louvre 180°

Horizontal rotary louvre allows precise air supply in any direction within 180° up/down.



## Super Jonizer iAIR

By creating negative oxygen ions, Super Ionizer iAIR eliminates viruses, bacteria, dust mites and allergens from the air. Unpleasant odours are removed practically as soon as the ionizer comes into contact with the contaminated air.



## Heating even at -22°C

The technology used and the built-in year-round operation package enable efficient operation of the air conditioner even in extreme weather conditions. The air conditioner will effectively heat the room even at low outdoor temperatures.



## Features device

68

 Digital DC Inverter SKY®	 Automatic purification iClean (1)	 Super Ionizer iAIR	 3-in-1 filter (Si.Ion + Ca + Nano) iAIR (1)	 Antibacterial HEPA iAIR filter	 Electrostatic HD iAIR filter	 Super Silent eMOTO mode (1)	 Automatic 4D louvres
 Rotating louvre 180°	 Turbo eMOTO mode (1)	 Upwards cascade air supply	 Downwards cascade air supply	 Air supply control system eMOTO	 ECO eMOTO mode (1)	 Wide angle eMOTO air supply	 Humidity sensor (1)(3)
 SMART port wired controller (2)	 SMART Wi-Fi	 Smart panel display ON/OFF	 SMART Follow mode	 Wireless remote controller	 Wired controller (2)	 SMART heating to 8°C (1)	 Louvre setting memory
 1W standby mode (1)	 Auto restart memory	 Anti-corrosive gold fins	 Drip tray heater	 Compressor crankcase heater	 Silence mode	 Timer	 Cooling at low outdoor temp. down to -15°C
 Heating at low outdoor temp. down to -22°C	 Double-sided condensate drainage	 Self-diagnostics	 Sleep mode	 BMS Modbus (2)	 BMS Bacnet (2)		

1. Feature not available in Multi Split system. 2. Feature is only optional. 3. Feature can be accessed via mobile app.

\* Silver Ion + Photocatalytic + Cold Nano

Model				Versu Mirror 2,6 kW	Versu Mirror 3,5 kW	Versu Mirror 5,3 kW
Capacity	Cooling	Nom. (Min. - Max.)	W	2638 (1231-3297)	3516 (1320-4307)	5275 (1817-6008)
Rated input		Nom. (Min. - Max.)	W	600 (100-1260)	900 (130-1650)	1600 (140-2300)
Operating current		Nom. (Min. - Max.)	A	2,6 (0,4-5,5)	3,9 (0,6-7,2)	7,0 (0,6-10,0)
Capacity	Heating	Nom. (Min. - Max.)	W	2931 (847-3722)	3809 (879-4395)	5568 (1260-6154)
Rated input		Nom. (Min. - Max.)	W	623 (110-1320)	950 (120-1500)	1680 (220-2350)
Operating current		Nom. (Min. - Max.)	A	2,7 (0,5-5,7)	4,1 (0,5-6,5)	7,3 (1,0-10,2)
Reversible heat pump type				air-to-air	air-to-air	air-to-air
Design load in cooling mode			kW	2,6	3,5	5,3
SEER			W/W	8,8	8,5	6,3
Energy efficiency class - cooling				A+++	A+++	A++
Annual electric energy consumption - cooling			kWh/a	103	146	294
Design load in heating mode (T <sub>biv</sub> -7°C)			kW	2,5	2,5	4,1
SCOP			W/W	4,6	4,6	4,1
Energy efficiency class - heating				A++	A++	A+
Annual electric energy consumption - heating			kWh/a	776	776	1435
Dehumidification			l/h	1,0	1,2	1,8
Maximum energy consumption			W	2200	2200	2500
Maximum operating current			A	9,6	9,6	10,9
Indoor unit				VM26Xi	VM35Xi	VM50Xi
EAN product code				5905567600890	5905567600913	5905567600937
Fan speed	T / H / M / L / ML / S	rpm	1122 / 910 / 823 / 710 / 652 / 600	1122 / 910 / 823 / 710 / 652 / 600	1150 / 970 / 880 / 800 / 760 / 670	
Air flow	T / H / M / L / ML / S	m <sup>3</sup> /h	700 / 555 / 445 / 380 / 270 / 230	700 / 555 / 445 / 380 / 270 / 230	750 / 590 / 490 / 410 / 330 / 280	
Sound pressure level	T / H / M / L / ML / S	dB(A)	40 / 32 / 27 / 24 / 21 / 19	40 / 32 / 27 / 24 / 21 / 19	41 / 36 / 30 / 28 / 24 / 19	
Sound power level		dB(A)	53	53	54	
Rated input		W	23	23	23	
Operating current		A	0,1	0,1	0,1	
Net dimensions	W × D × H	mm	920 × 211 × 321	920 × 211 × 321	920 × 211 × 321	
Gross dimensions	W × D × H	mm	1005 × 295 × 385	1005 × 295 × 385	1005 × 295 × 385	
Net weight / Gross weight		kg	11,3 / 14,2	11,3 / 14,2	11,5 / 14,4	
Condensate drain		mm	16	16	16	
Outdoor unit				VM26Xo	VM35Xo	VM50Xo
EAN product code				5905567600906	5905567600920	5905567600944
Fan speed	H / M / L	rpm	800 / 620 / 450	800 / 620 / 450	760 / 650 / 490	
Maximum air flow		m <sup>3</sup> /h	2200	2200	2100	
Sound pressure level		dB(A)	53	53	54	
Sound power level		dB(A)	58	62	63	
Net dimensions	W × D × H	mm	765 × 303 × 555	765 × 303 × 555	805 × 330 × 554	
Gross dimensions	W × D × H	mm	887 × 337 × 610	887 × 337 × 610	915 × 370 × 615	
Bracket spacing	W × D	(mm)	452 × 286	452 × 286	511 × 317	
Net weight / Gross weight		kg	26,4 / 28,8	26,4 / 28,8	33,5 / 36,1	
Refrigerant	Type		R32	R32	R32	
	GWP*		675	675	675	
	Charged (≤ 5m)	kg	0,7	0,7	1,1	
		TCO <sub>2</sub> eq	0,472	0,472	0,74	
Charged (> 5m)	g/m	12	12	12		
Pipe connections	Liquid / Gas	mm (inch)	Φ6,35 / Φ9,52 (1/4" / 3/8")	Φ6,35 / Φ9,52 (1/4" / 3/8")	Φ6,35 / Φ12,7 (1/4" / 1/2")	
Maximum installation length		m	25	25	30	
Maximum height difference		m	10	10	20	
Compressor type				Rotary DC	Rotary DC	Rotary DC
Type of outdoor unit power supply			V-Hz, Ø	220-240-50, 1f	220-240-50, 1f	220-240-50, 1f
Current protection			A	B10	B10	B16
Power cables: outdoor unit	L < 20m	pcs × mm <sup>2</sup>	3 × 1,5	3 × 1,5	3 × 1,5	
Control and power cables: indoor unit - outdoor unit			pcs × mm <sup>2</sup>	5 × 1,5	5 × 1,5	5 × 1,5
Control and power cables: hiro unit - indoor unit			pcs × mm <sup>2</sup>	4 × 1,5	4 × 1,5	4 × 1,5
Indoor operating range (cooling / heating)			°C	16-32 / 0-30	16-32 / 0-30	16-32 / 0-30
Outdoor operating range (cooling / heating)			°C	-15-50 / -22-30	-15-50 / -22-30	-15-50 / -22-30
Compatible systems						
1:1 SINGLE				•	•	•
1:2 DUAL						
1:X MULTI S-LINE				•		•
1:X MULTI N-LINE						
1:X MULTI HP-LINE				•		•

T - Turbo ; H - High; M - Medium; L - Low; ML - Medium Low; S - Silent



## Wall-mounted air conditioner **Versu Pure**

**Versu Pure is a new version of the Versu Model, the most recognizable in Rotenso's range and a favourite among aesthetes.**

70

The unique, very elegant design of the device will find its fans among lovers of different styles. Versu Pure attracts attention with its pure form.

The original body refers to the design of its predecessors in the Versu family. In addition, the white and discreet silver trimming of the soft edges of the front panel of the air conditioner are in line with trends in modern design.

Cascading air supply - directly up/down, realized thanks to a horizontal louvre rotating 180 degrees around its axis, quiet operation - only 19 dB, and an advanced air purification system are the advantages of this highly efficient, year-round unit with the highest Cooling Energy efficiency class A+++.



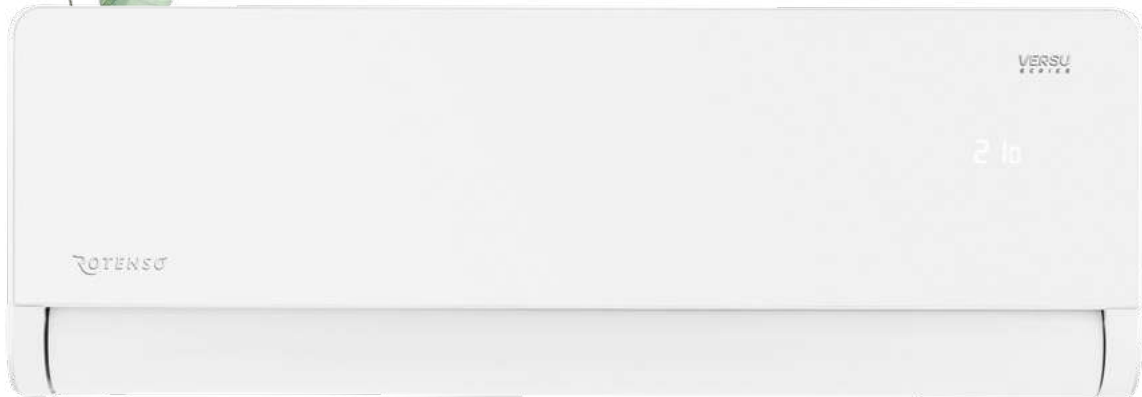

Function  
**SMART Wi-Fi**

Utilizing SMART Wi-Fi and a Wi-Fi modem, you can control the unit with a tablet or smartphone both inside and outside the home.



Volume  
**only 19 dB**

The unit can operate in Super Silent eMOTO mode, so it does not disturb your rest.



Automatic  
**4D louvres**

Built-in actuators allow you to control the operation of vertical and horizontal blinds with a remote control or wall-mounted controller. This guarantees the highest level of operating comfort and ensures efficient air distribution in the room.



Rotating  
**louvres 180°**

Horizontal rotary louvre allows precise air supply in any direction within 180° up/down.



Super  
**iAIR ionizer**

By creating negative oxygen ions, Super Ionizer iAIR eliminates viruses, bacteria, dust mites and allergens from the air. Unpleasant odours are removed practically as soon as the ionizer comes into contact with the contaminated air.



Heating  
**even at -22°C**

The technology used and the built-in year-round operation package enable efficient operation of the air conditioner even in extreme weather conditions.

The air conditioner will effectively heat the room even at low outdoor temperatures.

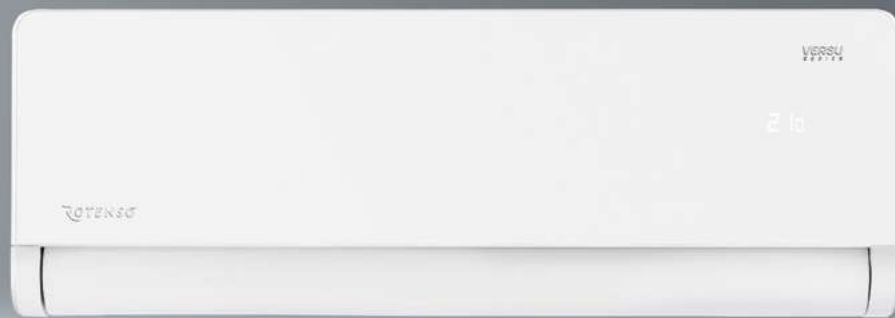

## Features device

72

 Digital DC Inverter SKY®	 Automatic purification iClean <sup>(1)</sup>	 Super Ionizer iAIR	 3-in-1 filter (Si.Ion + Ca + Nano) iAIR <sup>(1)</sup>	 Antibacterial HEPA iAIR filter	 Electrostatic HD iAIR filter	 Super Silent eMOTO mode <sup>(1)</sup>	 Automatic 4D louvres
 Rotating louvre 180°	 Turbo eMOTO mode <sup>(1)</sup>	 Upwards cascade air supply	 Downwards cascade air supply	 Air supply control system eMOTO	 ECO eMOTO mode <sup>(1)</sup>	 Wide angle eMOTO air supply	 Humidity sensor <sup>(1)(3)</sup>
 SMART port wired controller <sup>(2)</sup>	 SMART Wi-Fi	 Smart panel display ON/OFF	 SMART Follow mode	 Wireless remote controller	 Wired controller <sup>(2)</sup>	 SMART heating to 8°C <sup>(1)</sup>	 Louvre setting memory
 1W standby mode <sup>(1)</sup>	 Auto restart memory	 Anti-corrosive gold fins	 Drip tray heater	 Compressor crankcase heater	 Silence mode	 Timer	 Cooling at low outdoor temp. down to -15°C
 Heating at low outdoor temp. down to -22°C	 Double-sided condensate drainage	 Self-diagnostics	 Sleep mode	 BMS Modbus <sup>(2)</sup>	 BMS Bacnet <sup>(2)</sup>		

1. Feature not available in Multi Split system. 2. Feature is only optional. 3. Feature can be accessed via mobile app.

\* Silver Ion + Photocatalytic + Cold Nano

Model				Versu Pure 2,6 kW	Versu Pure 3,5 kW	Versu Pure 5,3 kW
Capacity	Cooling	Nom. (Min. - Max.)	W	2638 (1231-3297)	3516 (1320-4307)	5275 (1817-6008)
Rated input		Nom. (Min. - Max.)	W	600 (100-1260)	900 (130-1650)	1600 (140-2300)
Operating current		Nom. (Min. - Max.)	A	2,6 (0,4-5,5)	3,9 (0,6-7,2)	7,0 (0,6-10,0)
Capacity	Heating	Nom. (Min. - Max.)	W	2931 (847-3722)	3809 (879-4395)	5568 (1260-6154)
Rated input		Nom. (Min. - Max.)	W	623 (110-1320)	950 (120-1500)	1680 (220-2350)
Operating current		Nom. (Min. - Max.)	A	2,7 (0,5-5,7)	4,1 (0,5-6,5)	7,3 (1,0-10,2)
Reversible heat pump type				air-to-air	air-to-air	air-to-air
Design load in cooling mode			kW	2,6	3,5	5,3
SEER			W/W	8,8	8,5	6,3
Energy efficiency class - cooling				A+++	A+++	A++
Annual electric energy consumption - cooling			kWh/a	103	146	294
Design load in heating mode (Tbiv -7°C)			kW	2,5	2,5	4,1
SCOP			W/W	4,6	4,6	4,1
Energy efficiency class - heating				A++	A++	A+
Annual electric energy consumption - heating			kWh/a	776	776	1435
Dehumidification			l/h	1,0	1,2	1,8
Maximum energy consumption			W	2200	2200	2500
Maximum operating current			A	9,6	9,6	10,9
Indoor unit				VP26Xi	VP35Xi	VP50Xi
EAN product code				5905567600951	5905567600975	5905567600999
Fan speed	T / H / M / L / ML / S	rpm	1122 / 910 / 823 / 710 / 652 / 600	1122 / 910 / 823 / 710 / 652 / 600	1150 / 970 / 880 / 800 / 760 / 670	
Air flow	T / H / M / L / ML / S	m³/h	700 / 555 / 445 / 380 / 270 / 230	700 / 555 / 445 / 380 / 270 / 230	750 / 590 / 490 / 410 / 330 / 280	
Sound pressure level	T / H / M / L / ML / S	dB(A)	40 / 32 / 27 / 24 / 21 / 19	40 / 32 / 27 / 24 / 21 / 19	41 / 36 / 30 / 28 / 24 / 19	
Sound power level		dB(A)	53	53	54	
Rated input		W	23	23	23	
Operating current		A	0,1	0,1	0,1	
Net dimensions	W × D × H	mm	920 × 211 × 321	920 × 211 × 321	920 × 211 × 321	
Gross dimensions	W × D × H	mm	1005 × 295 × 385	1005 × 295 × 385	1005 × 295 × 385	
Net weight / Gross weight		kg	11,3 / 14,2	11,3 / 14,2	11,5 / 14,4	
Condensate drain		mm	16	16	16	
Outdoor unit				VP26Xo	VP35Xo	VP50Xo
EAN product code				5905567600968	5905567600982	5905567601002
Fan speed	H / M / L	rpm	800 / 620 / 450	800 / 620 / 450	760 / 650 / 490	
Maximum air flow		m³/h	2200	2200	2100	
Sound pressure level		dB(A)	53	53	54	
Sound power level		dB(A)	58	62	63	
Net dimensions	W × D × H	mm	765 × 303 × 555	765 × 303 × 555	805 × 330 × 554	
Gross dimensions	W × D × H	mm	887 × 337 × 610	887 × 337 × 610	915 × 370 × 615	
Bracket spacing	W × D	(mm)	452 × 286	452 × 286	511 × 317	
Net weight / Gross weight		kg	26,4 / 28,8	26,4 / 28,8	33,5 / 36,1	
Refrigerant	Type		R32	R32	R32	
	GWP*		675	675	675	
	Charged (≤ 5m)	kg	0,7	0,7	1,1	
		TCO <sub>2</sub> eq	0,472	0,472	0,74	
Charged (> 5m)	g/m	12	12	12		
Pipe connections	Liquid / Gas	mm (inch)	Φ6,35 / Φ9,52 (1/4" / 3/8")	Φ6,35 / Φ9,52 (1/4" / 3/8")	Φ6,35 / Φ12,7 (1/4" / 1/2")	
Maximum installation length		m	25	25	30	
Maximum height difference		m	10	10	20	
Compressor type				Rotary DC	Rotary DC	Rotary DC
Type of outdoor unit power supply			V-Hz, Ø	220-240-50, 1f	220-240-50, 1f	220-240-50, 1f
Current protection			A	B10	B10	B16
Power cables: outdoor unit	L < 20m	pcs × mm²	3 × 1,5	3 × 1,5	3 × 1,5	
Control and power cables: indoor unit - outdoor unit		pcs × mm²	5 × 1,5	5 × 1,5	5 × 1,5	
Control and power cables: Hiro unit - indoor unit		pcs × mm²	4 × 1,5	4 × 1,5	4 × 1,5	
Indoor operating range (cooling / heating)			°C	16-32 / 0-30	16-32 / 0-30	16-32 / 0-30
Outdoor operating range (cooling / heating)			°C	-15-50 / -22-30	-15-50 / -22-30	-15-50 / -22-30
Compatible systems						
1:1 SINGLE				•	•	•
1:2 DUAL						
1:X MULTI S-LINE				•	•	•
1:X MULTI N-LINE						
1:X MULTI HP-LINE				•	•	•

T - Turbo ; H - High; M - Medium; L - Low; ML - Medium Low; S - Silent



## Wall-mounted air conditioner **Versu Cloth**

**Versu Cloth we created for those,  
who are looking for their own way.**

The interchangeable textile panels, perfectly adhering to the front of the air conditioner, is an uninhibited play with color and a sensual experience of pleasant texture to the touch.

Versu Cloth is a year-round unit with the highest Energy efficiency class, cooling A+++.  
It's also quiet operation - the unit's volume is only 19 dB in the lowest gear, as well as a cascading air supply, which is mediated by a 180° rotating horizontal louvre.

With Versu Cloth you will create an arrangement in which all elements and decorations will be a stylistically coherent whole.

The warm golden shade of the Cloth Caramel case with the caramel color of the Panel will appeal to lovers of warm, nature-inspired tones. Versu Cloth Stone by contrast, is a variation on silver and gray created for modern, subdued interiors.



**TEXTILE**  
INTERCHANGEABLE  
FRONT PANELS



# VERSU CLOTH



Versu Cloth Stone

Versu Cloth Caramel



## Textile interchangeable front panels

Textile changeable front panel, available in up to 9 different colours, allows you to customize the design of the air conditioner to fit any room at any time.



## Volume only 19 dB

The unit can operate in super eMOTO Silent mode, so it does not disturb your rest.



## Automatic 4D louvres

Built-in actuators allow you to control the operation of vertical and horizontal blinds with a remote control or wall-mounted controller. This guarantees the highest level of operating comfort and ensures efficient air distribution in the room.



## Rotating louvre 180°

The horizontal rotating louvre allows you to precise air supply in any direction within 180° up/down.



## Super iAIR Ionizer

By creating negative oxygen ions, Super Ionizer iAIR eliminates viruses, bacteria, dust mites and allergens from the air. Unpleasant odours are removed practically as soon as the ionizer comes into contact with the contaminated air.



## Heating at down to -22°C

The technology used and the built-in year-round operation package enable efficient operation of the air conditioner even in extreme weather conditions.

The air conditioner will effectively heat the room even at low outdoor temperatures.

QUICK CHANGE  
OF INTERIOR  
DESIGN?



Versu Cloth Caramel with Rose Panel

**No problem!**

## VERSU CLOTH STONE

76

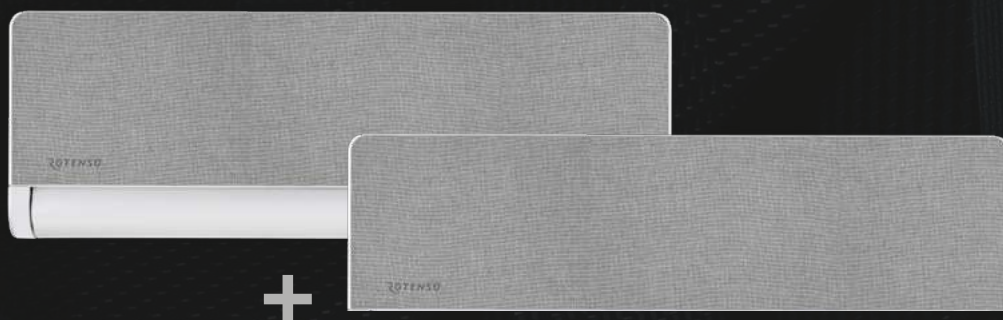

PANEL INCLUDED - STONE

## VERSU CLOTH CARAMEL



PANEL INCLUDED - CARAMEL



Versu Cloth Stone

Versu Cloth Caramel

# INTERCHANGEABLE TEXTILE MAGNETIC PANELS

COLOR VERSIONS OF THE TEXTILE INTERCHANGEABLE PANELS:



Marine



Desert

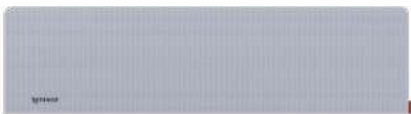

Storm



Rose



Coral



Mint

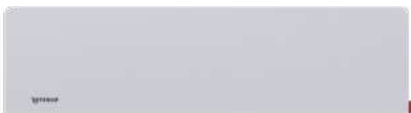

Chrome



Caramel



Stone



Easy replacement



Waterproof,  
stain resistant

Magnetic panel colours in print may differ from actual colours.

# FULL CONTROL 180° AIR SUPPLY



78

**AIR SUPPLY**  
cascade  
downwards

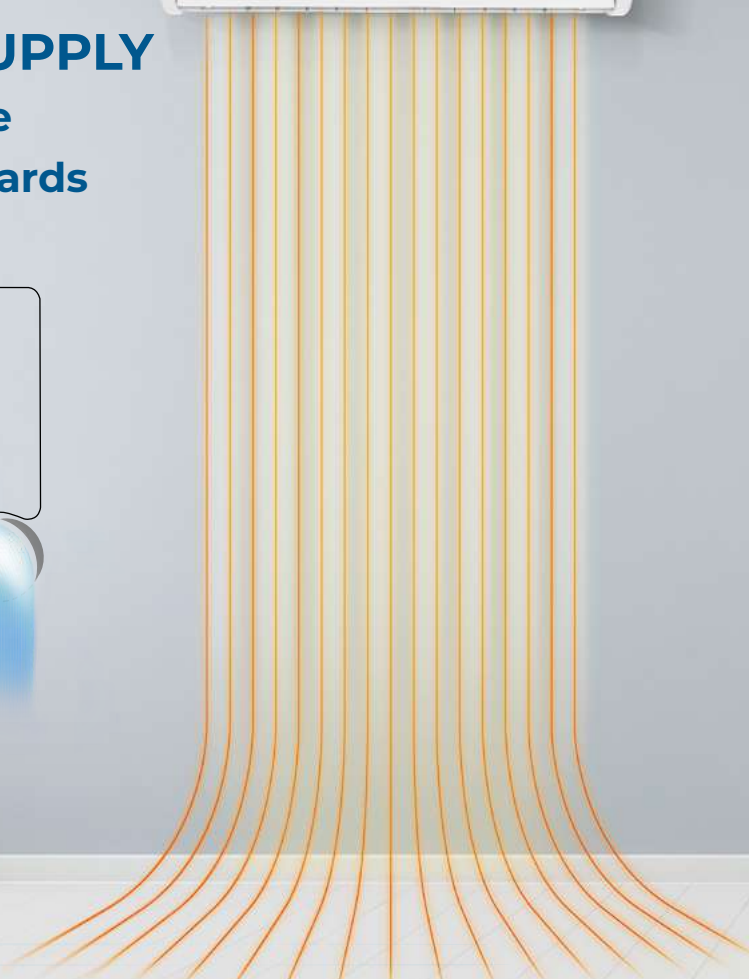
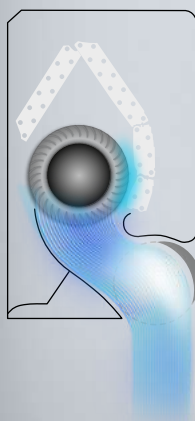

range  
**klimaakcia**  
up to **9m**  
[www.klimaakcia.sk](http://www.klimaakcia.sk)

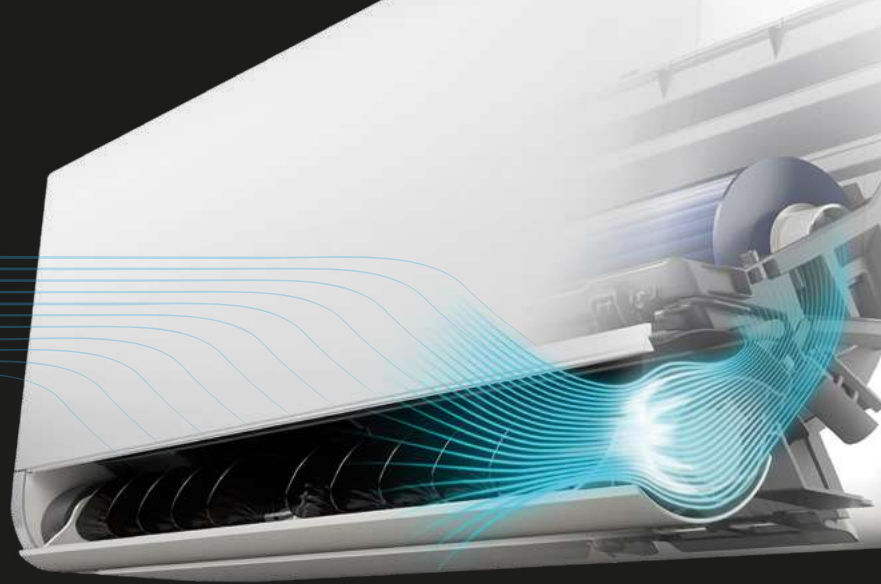

5 4 3 2 1 0

**AIR SUPPLY**  
cascade  
upwards



# klimaakcia

## Versu Cloth Stone

2,6-5,3 kW



S-LINE

HP-LINE

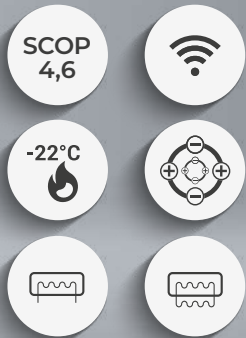

## Features device

80



Digital DC Inverter SKY®



Textile changeable front panel



Automatic Purification iClean <sup>(1)</sup>



Super Ionizer iAIR



3-in-1 filter (Si.Ion + Ca + Nano) iAIR <sup>(1)</sup>



Antibacterial HEPA iAIR filter



Electrostatic HD iAIR filter



Super Silent eMOTO mode <sup>(1)</sup>



Automatic 4D louvres



Rotating louvre 180°



Turbo eMOTO mode <sup>(1)</sup>



Upwards cascade air supply



Downwards cascade air supply



Air supply control system eMOTO



ECO eMOTO mode <sup>(1)</sup>



Wide angle eMOTO air supply



Humidity sensor <sup>(1)(2)</sup>



SMART Wi-Fi



SMART port wired controller <sup>(2)</sup>



Smart panel display ON/OFF



SMART Follow mode



Wireless remote controller



Wired controller <sup>(2)</sup>



SMART heating to 8°C <sup>(1)</sup>



Louvre setting memory



1W standby mode <sup>(1)</sup>



Auto restart memory



Anti-corrosive gold fins



Drip tray heater



Compressor crankcase heater



Silence mode



Timer



Cooling at low outdoor temp. down to -15°C



Heating at low outdoor temp. down to -22°C



Double-sided condensate drainage



Self-diagnostics



Sleep mode



BMS Modbus <sup>(2)</sup>



BMS Bacnet <sup>(2)</sup>

klimaakcia  
www.klimaakcia.sk

1. Feature not available in Multi Split system. 2. Feature is only optional. 3. Feature can be accessed via mobile app.

\* Silver Ion + Photocatalytic + Cold Nano

Model				Versu Cloth Stone 2,6 kW	Versu Cloth Stone 3,5 kW	Versu Cloth Stone 5,3 kW
Capacity	Cooling	Nom. (Min. - Max.)	W	2638 (1231-3297)	3516 (1320-4307)	5275 (1817-6008)
Rated input		Nom. (Min. - Max.)	W	600 (100-1260)	900 (130-1650)	1600 (140-2300)
Operating current		Nom. (Min. - Max.)	A	2,6 (0,4-5,5)	3,9 (0,6-7,2)	7,0 (0,6-10,0)
Capacity	Heating	Nom. (Min. - Max.)	W	2931 (847-3722)	3809 (879-4395)	5568 (1260-6154)
Rated input		Nom. (Min. - Max.)	W	623 (110-1320)	950 (120-1500)	1680 (220-2350)
Operating current		Nom. (Min. - Max.)	A	2,7 (0,5-5,7)	4,1 (0,5-6,5)	7,3 (1,0-10,2)
Reversible heat pump type				air-to-air	air-to-air	air-to-air
Design load in cooling mode			kW	2,6	3,5	5,3
SEER			W/W	8,8	8,5	6,3
Energy efficiency class - cooling				A+++	A+++	A++
Annual electric energy consumption - cooling			kWh/a	103	146	294
Design load in heating mode (T <sub>biv</sub> -7°C)			kW	2,5	2,5	4,1
SCOP			W/W	4,6	4,6	4,1
Energy efficiency class - heating				A++	A++	A+
Annual electric energy consumption - heating			kWh/a	776	776	1435
Dehumidification			l/h	1,0	1,2	1,8
Maximum energy consumption			W	2200	2200	2500
Maximum operating current			A	9,6	9,6	10,9
Indoor unit				VCS26Xi	VCS35Xi	VCS50Xi
EAN product code				5905567601026	5905567601088	5905567601095
Fan speed	T / H / M / L / ML / S	rpm	1122 / 910 / 823 / 710 / 652 / 600	1122 / 910 / 823 / 710 / 652 / 600	1150 / 970 / 880 / 800 / 760 / 670	
Air flow	T / H / M / L / ML / S	m <sup>3</sup> /h	700 / 555 / 445 / 380 / 270 / 230	700 / 555 / 445 / 380 / 270 / 230	750 / 590 / 490 / 410 / 330 / 280	
Sound pressure level	T / H / M / L / ML / S	dB(A)	40 / 32 / 27 / 24 / 21 / 19	40 / 32 / 27 / 24 / 21 / 19	41 / 36 / 30 / 28 / 24 / 19	
Sound power level		dB(A)	53	53	54	
Rated input		W	23	23	23	
Operating current		A	0,1	0,1	0,1	
Net dimensions	W × D × H	mm	920 × 211 × 321	920 × 211 × 321	920 × 211 × 321	
Gross dimensions	W × D × H	mm	1005 × 295 × 385	1005 × 295 × 385	1005 × 295 × 385	
Net weight / Gross weight		kg	11,3 / 14,2	11,3 / 14,2	11,5 / 14,4	
Condensate drain		mm	16	16	16	
Outdoor unit				VO26Xo	VO35Xo	VO50Xo
EAN product code				5905567606649	5905567606663	5905567606687
Fan speed	H / M / L	rpm	800 / 620 / 450	800 / 620 / 450	760 / 650 / 490	
Maximum air flow		m <sup>3</sup> /h	2200	2200	2100	
Sound pressure level		dB(A)	53	53	54	
Sound power level		dB(A)	58	62	63	
Net dimensions	W × D × H	mm	765 × 303 × 555	765 × 303 × 555	805 × 330 × 554	
Gross dimensions	W × D × H	mm	887 × 337 × 610	887 × 337 × 610	915 × 370 × 615	
Bracket spacing	W × D	(mm)	452 × 286	452 × 286	511 × 317	
Net weight / Gross weight		kg	26,4 / 28,8	26,4 / 28,8	33,5 / 36,1	
Refrigerant	Type		R32	R32	R32	
	GWP*		675	675	675	
	Charged (≤ 5m)	kg	0,7	0,7	1,1	
		TCO <sub>2</sub> eq	0,472	0,472	0,74	
Charged (> 5m)	g/m	12	12	12		
Pipe connections	Liquid / Gas	mm (inch)	Φ6,35 / Φ9,52 (1/4" / 3/8")	Φ6,35 / Φ9,52 (1/4" / 3/8")	Φ6,35 / Φ12,7 (1/4" / 1/2")	
Maximum installation length		m	25	25	30	
Maximum height difference		m	10	10	20	
Compressor type				Rotary DC	Rotary DC	Rotary DC
Type of outdoor unit power supply		V-Hz, Ø	220-240-50, 1f	220-240-50, 1f	220-240-50, 1f	
Current protection		A	B10	B10	B16	
Power cables: outdoor unit	L < 20m	pcs × mm <sup>2</sup>	3 × 1,5	3 × 1,5	3 × 1,5	
Control and power cables: indoor unit - outdoor unit		pcs × mm <sup>2</sup>	5 × 1,5	5 × 1,5	5 × 1,5	
Control and power cables: hiro unit - indoor unit		pcs × mm <sup>2</sup>	4 × 1,5	4 × 1,5	4 × 1,5	
Indoor operating range (cooling / heating)		°C	16~32 / 0~30	16~32 / 0~30	16~32 / 0~30	
Outdoor operating range (cooling / heating)		°C	-15~50 / -22~30	-15~50 / -22~30	-15~50 / -22~30	
Compatible systems						
1:1 SINGLE				•	•	•
1:2 DUAL						
1:X MULTI S-LINE				•	•	•
1:X MULTI N-LINE						
1:X MULTI HP-LINE				•	•	•

T - Turbo ; H - High; M - Medium; L - Low; ML - Medium Low; S - Silent

# klimaakcia

## Versu Cloth Caramel

2,6-5,3 kW



S-LINE  
HP-LINE

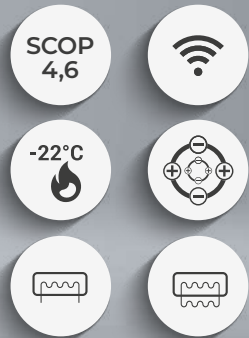

## Features device

82

 Digital DC Inverter SKY®	 Textile changeable front panel	 Automatic Purification iClean (1)	 Super Ionizer iAIR	 3-in-1 filter (Si.Ion + Ca + Nano) iAIR (1)	 Antibacterial HEPA iAIR filter	 Electrostatic HD iAIR filter	 Super Silent eMOTO mode (1)
 Automatic 4D louvres	 Rotating louvre 180°	 Turbo eMOTO mode (1)	 Upwards cascade air supply	 Downwards cascade air supply	 Air supply control system eMOTO	 ECO eMOTO mode (1)	 Wide angle eMOTO air supply
 Humidity sensor (1)(2)	 SMART Wi-Fi	 SMART port wired controller (2)	 Smart panel display ON/OFF	 SMART Follow mode	 Wireless remote controller	 Wired controller (2)	 SMART heating to 8°C (1)
 Louvre setting memory	 1W standby mode (1)	 Auto restart memory	 Anti-corrosive gold fins	 Drip tray heater	 Compressor crankcase heater	 Silence mode	 Timer
 Cooling at low outdoor temp. down to -15°C	 Heating at low outdoor temp. down to -22°C	 Double-sided condensate drainage	 Self-diagnostics	 Sleep mode	 BMS Modbus (2)	 BMS Bacnet (2)	

klimaakcia  
www.klimaakcia.sk

1. Feature not available in Multi Split system. 2. Feature is only optional. 3. Feature can be accessed via mobile app.

\* Silver Ion + Photocatalytic + Cold Nano

Model				Versu Cloth Caramel 2,6 kW	Versu Cloth Caramel 3,5 kW	Versu Cloth Caramel 5,3 kW
Capacity	Cooling	Nom. (Min. - Max.)	W	2638 (1231-3297)	3516 (1320-4307)	5275 (1817-6008)
Rated input		Nom. (Min. - Max.)	W	600 (100-1260)	900 (130-1650)	1600 (140-2300)
Operating current		Nom. (Min. - Max.)	A	2,6 (0,4-5,5)	3,9 (0,6-7,2)	7,0 (0,6-10,0)
Capacity	Heating	Nom. (Min. - Max.)	W	2931 (847-3722)	3809 (879-4395)	5568 (1260-6154)
Rated input		Nom. (Min. - Max.)	W	623 (110-1320)	950 (120-1500)	1680 (220-2350)
Operating current		Nom. (Min. - Max.)	A	2,7 (0,5-5,7)	4,1 (0,5-6,5)	7,3 (1,0-10,2)
Reversible heat pump type				air-to-air	air-to-air	air-to-air
Design load in cooling mode			kW	2,6	3,5	5,3
SEER			W/W	8,8	8,5	6,3
Energy efficiency class - cooling				A+++	A+++	A++
Annual electric energy consumption - cooling			kWh/a	103	146	294
Design load in heating mode (T <sub>biv</sub> -7°C)			kW	2,5	2,5	4,1
SCOP			W/W	4,6	4,6	4,1
Energy efficiency class - heating				A++	A++	A+
Annual electric energy consumption - heating			kWh/a	776	776	1435
Dehumidification			l/h	1,0	1,2	1,8
Maximum energy consumption			W	2200	2200	2500
Maximum operating current			A	9,6	9,6	10,9
Indoor unit				VCC26Xi	VCC35Xi	VCC50Xi
EAN product code				5905567601019	5905567601033	5905567601057
Fan speed	T / H / M / L / ML / S	rpm	1122 / 910 / 823 / 710 / 652 / 600	1122 / 910 / 823 / 710 / 652 / 600	1150 / 970 / 880 / 800 / 760 / 670	
Air flow	T / H / M / L / ML / S	m <sup>3</sup> /h	700 / 555 / 445 / 380 / 270 / 230	700 / 555 / 445 / 380 / 270 / 230	750 / 590 / 490 / 410 / 330 / 280	
Sound pressure level	T / H / M / L / ML / S	dB(A)	40 / 32 / 27 / 24 / 21 / 19	40 / 32 / 27 / 24 / 21 / 19	41 / 36 / 30 / 28 / 24 / 19	
Sound power level		dB(A)	53	53	54	
Rated input		W	23	23	23	
Operating current		A	0,1	0,1	0,1	
Net dimensions	W × D × H	mm	920 × 211 × 321	920 × 211 × 321	920 × 211 × 321	
Gross dimensions	W × D × H	mm	1005 × 295 × 385	1005 × 295 × 385	1005 × 295 × 385	
Net weight / Gross weight		kg	11,3 / 14,2	11,3 / 14,2	11,5 / 14,4	
Condensate drain		mm	16	16	16	
Outdoor unit				VO26Xo	VO35Xo	VO50Xo
EAN product code				5905567606649	5905567606663	5905567606687
Fan speed	H / M / L	rpm	800 / 620 / 450	800 / 620 / 450	760 / 650 / 490	
Maximum air flow		m <sup>3</sup> /h	2200	2200	2100	
Sound pressure level		dB(A)	53	53	54	
Sound power level		dB(A)	58	62	63	
Net dimensions	W × D × H	mm	765 × 303 × 555	765 × 303 × 555	805 × 330 × 554	
Gross dimensions	W × D × H	mm	887 × 337 × 610	887 × 337 × 610	915 × 370 × 615	
Bracket spacing	W × D	(mm)	452 × 286	452 × 286	511 × 317	
Net weight / Gross weight		kg	26,4 / 28,8	26,4 / 28,8	33,5 / 36,1	
Refrigerant	Type		R32	R32	R32	
	GWP*		675	675	675	
	Charged (≤ 5m)	kg	0,7	0,7	1,1	
		TCO <sub>2</sub> eq	0,472	0,472	0,74	
Charged (> 5m)	g/m	12	12	12		
Pipe connections	Liquid / Gas	mm (inch)	Φ6,35 / Φ9,52 (1/4" / 3/8")	Φ6,35 / Φ9,52 (1/4" / 3/8")	Φ6,35 / Φ12,7 (1/4" / 1/2")	
Maximum installation length		m	25	25	30	
Maximum height difference		m	10	10	20	
Compressor type				Rotary DC	Rotary DC	Rotary DC
Type of outdoor unit power supply			V-Hz, Ø	220-240-50, 1f	220-240-50, 1f	220-240-50, 1f
Current protection			A	B10	B10	B16
Power cables: outdoor unit	L < 20m	pcs × mm <sup>2</sup>	3 × 1,5	3 × 1,5	3 × 1,5	
Control and power cables: indoor unit - outdoor unit		pcs × mm <sup>2</sup>	5 × 1,5	5 × 1,5	5 × 1,5	
Control and power cables: hiro unit - indoor unit		pcs × mm <sup>2</sup>	4 × 1,5	4 × 1,5	4 × 1,5	
Indoor operating range (cooling / heating)			°C	16-32 / 0-30	16-32 / 0-30	16-32 / 0-30
Outdoor operating range (cooling / heating)			°C	-15-50 / -22-30	-15-50 / -22-30	-15-50 / -22-30
Compatible systems						
1:1 SINGLE				•	•	•
1:2 DUAL						
1:X MULTI S-LINE				•	•	•
1:X MULTI N-LINE						
1:X MULTI HP-LINE				•	•	•

T - Turbo ; H - High; M - Medium; L - Low; ML - Medium Low; S - Silent



## Wall-mounted air conditioner **Revio**

**Rotenso's flagship Revio air conditioner is designed to meet your need for safety and comfort.**

84

The improved technology, design and features of the new Generation X air conditioner are our answer to the needs of the new reality. The economical, year-round air conditioner operates efficiently in Heating mode at low outdoor temperatures down to  $-25^{\circ}\text{C}$ .

Revio features unprecedented ease of installation of the Indoor unit, which has only one screw and 4 snaps. Importantly, the unit can be installed as low as 5 cm from the ceiling.

The air conditioner has exceptionally easy access to the filters, thanks to a top cover innovatively fixed with magnets.

Thus, you can easily clean them yourself.

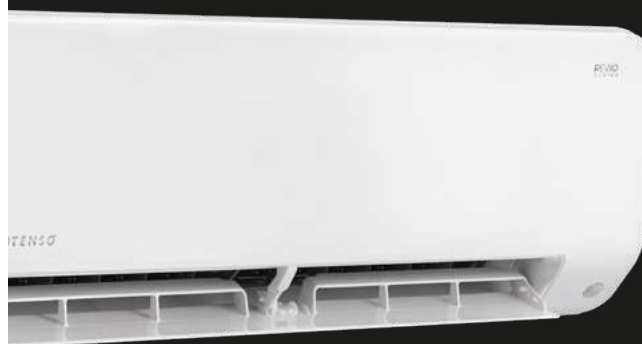

FUNCTIONS: SMART **ECO EYE**, SMART **EYE AWAY**





Function  
**SMART Eye Away**

The smart eye detects the activity of a person in the room and allows you to adjust the horizontal angle of air flow to implement a way of supply that avoids the person in the room.



Function  
**SMART ECO Eye**

The intelligent eye detects the activity of a person located in the room. The unit will start ECO mode if it does not notice the presence of a person in the room for more than 30 min.



Automatic  
**Purification iClean**

The iClean function is an advanced function that self-cleaning of the air conditioner's indoor unit exchanger. It involves maximum cooling and then maximum heating of the exchanger. The function is designed to eliminate unwanted bacteria and fungi.



Super  
**iAIR Ionizer**

By creating negative oxygen ions, Super Ionizer iAIR eliminates viruses, bacteria, dust mites and allergens from the air. Unpleasant odours are removed practically as soon as the ionizer comes into contact with the contaminated air.



Easy maintenance  
**and installation**

Disassembly of the unit, the structure of which is based on one screw and 4 latches, takes no more than a minute. **Yes, 1 minute!** Another advantage is the ability to quickly change the filters, which does not require the removal of the front panel of the air conditioner, but only the release of its top cover from the magnets. This design makes it possible to install the air conditioner as low as **5 cm from the ceiling**.



Heating  
**at down to -25°C**

The applied compressor technology, EXV valve and year-round operation package guarantee unprecedented efficiency of the air conditioner in heating mode, even in extreme weather conditions. In addition to the room air-conditioning function, this year-round device can work as the only source of heat in a house, apartment or office.

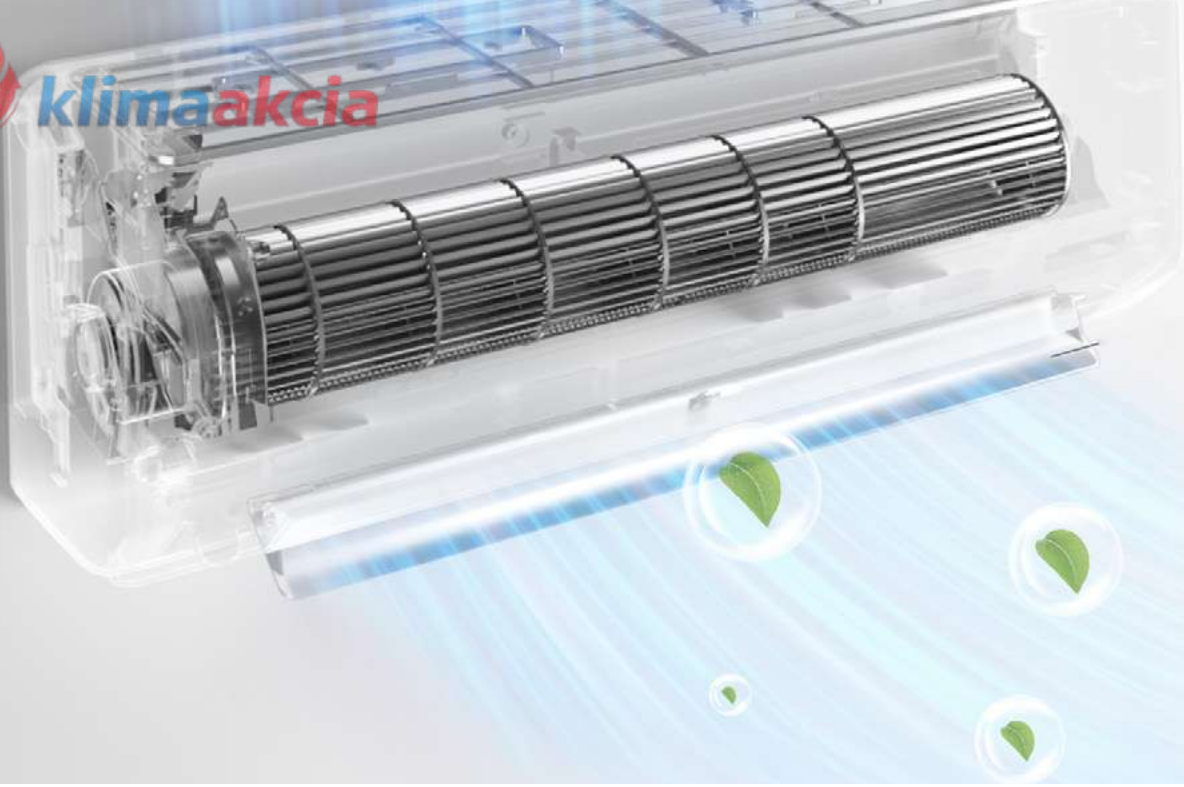



klimaakcia

# REVIO LUTION

# 1 MINUTE

# 1 SCREW

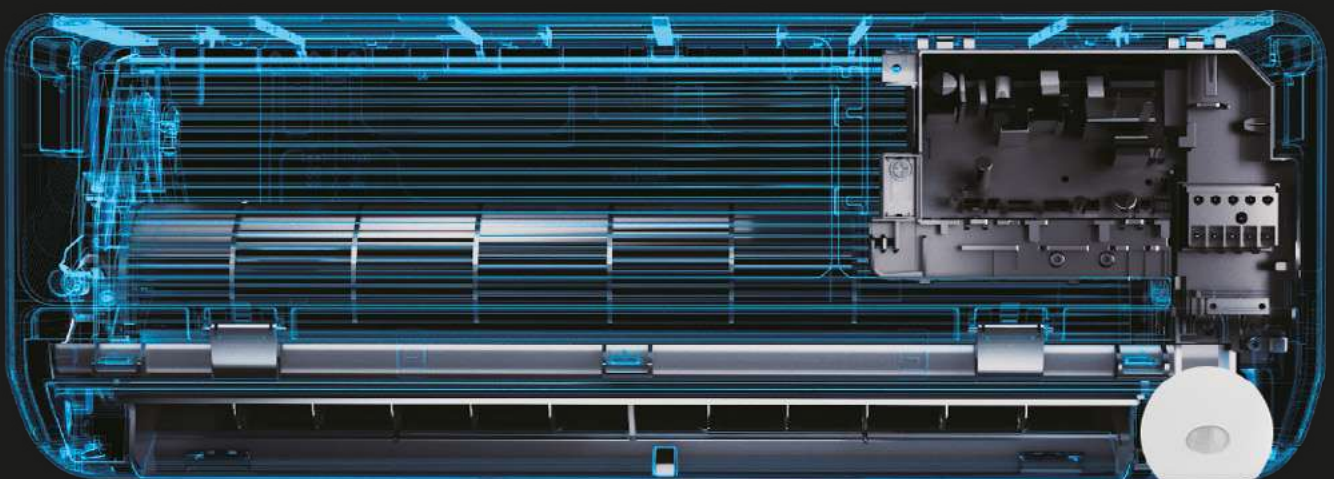

87

Revio is equipped with the Eco Eye function. The intelligent eye detects the activity of the occupants in the room and allows the air supply to be adjusted to avoid blowing directly at them.

The Automatic 4D louvres eMOTO system controls both horizontal and vertical louvres, which provides a unique sense of comfort in an air-conditioned room.

The expectations of demanding customers will also be met by the excellent performance of the device.

Larger air intake area by 23.5% ensures better efficiency of the unit.

Revio has outstanding SEER and SCOP ratings (seasonal energy efficiency in cooling and heating modes), as well as a high energy efficiency class. The economical year-round air conditioner operates in heating mode at low outdoor temperatures down to -25°C, so it can be the only source of heat.

klimaakcia  
[www.klimaakcia.sk](http://www.klimaakcia.sk)



S-LINE

HP-LINE

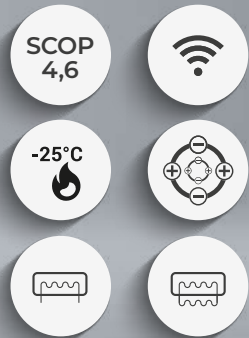

## Features device

88

 Digital DC Inverter SKY®	 Automatic purification iClean <sup>(1)</sup>	 Super Ionizer iAIR	 Cold Nano iAIR filter	 Antibacterial HEPA iAIR filter	 Electrostatic HD iAIR filter	 Super Silent eMOTO mode <sup>(1)</sup>	 Automatic 4D louvres
 Turbo eMOTO mode <sup>(1)</sup>	 Air supply control system eMOTO	 ECO eMOTO mode <sup>(1)</sup>	 Wide angle eMOTO air supply	 SMART Wi-Fi	 Humidity sensor <sup>(1)(3)</sup>	 SMART Eye Away <sup>(1)</sup>	 SMART Eco Eye <sup>(1)</sup>
 SMART port wired controller <sup>(2)</sup>	 Smart panel display ON/OFF	 SMART Follow mode	 Wireless remote controller	 Wired controller <sup>(2)</sup>	 SMART heating to 8°C <sup>(1)</sup>	 Louvre setting memory	 1W standby mode <sup>(1)</sup>
 Auto restart memory	 Anti-corrosive gold fins	 Drip tray heater	 Compressor crankcase heater	 Silence mode	 Timer	 Cooling at low outdoor temp. down to -15°C	 Heating at low outdoor temp. down to -25°C <sup>(1)</sup>
 Double-sided condensate drainage	 Self-diagnostics	 Sleep mode	 BMS Modbus <sup>(2)</sup>	 BMS Bacnet <sup>(2)</sup>	 <a href="http://www.klimaakcia.sk">www.klimaakcia.sk</a>		

1. Feature not available in Multi Split system. 2. Feature is only optional. 3. Feature can be accessed via mobile app.

Model				Revio 2,7 kW	Revio 3,5 kW	Revio 5,3 kW	Revio 7,0 kW
Capacity	Cooling	Nom. (Min. - Max.)	W	2725 (1319-3810)	3517 (1319-3956)	5275 (1993-6125)	7034 (2110-8206)
Rated input		Nom. (Min. - Max.)	W	600 (130-1200)	880 (130-1250)	1318 (160-1787)	1760 (420-3200)
Operating current		Nom. (Min. - Max.)	A	2,6 (0,6-5,2)	3,8 (0,6-5,4)	5,7 (0,7-7,8)	7,7 (1,8-13,9)
Capacity	Heating	Nom. (Min. - Max.)	W	3136 (880-4396)	3956 (879-4543)	5568 (1348-6770)	7327 (1553-8206)
Rated input		Nom. (Min. - Max.)	W	690 (120-1400)	990 (120-1450)	1500 (230-1695)	1975 (300-3100)
Operating current		Nom. (Min. - Max.)	A	3,0 (0,5-6,1)	4,3 (0,5-6,3)	6,5 (1,0-7,4)	8,6 (1,3-13,5)
Reversible heat pump type				air-to-air	air-to-air	air-to-air	air-to-air
Design load in cooling mode			kW	2,6	3,5	5,3	7,0
SEER			W/W	8,6	8,5	8,5	8,5
Energy efficiency class - cooling				A+++	A+++	A+++	A+++
Annual electric energy consumption - cooling			kWh/a	106	144	220	288
Design load in heating mode (T <sub>biv</sub> -7°C)			kW	2,4	2,4	4,3	5,0
SCOP			W/W	4,6	4,6	4,3	4,2
Energy efficiency class - heating				A++	A++	A+	A+
Annual electric energy consumption - heating			kWh/a	730	730	1400	1666
Dehumidification			l/h	1,0	1,2	1,8	2,7
Maximum energy consumption			W	2300	2300	2800	3700
Maximum operating current			A	10,0	10,0	12,2	16,1
Indoor unit				RO26Xi	RO35Xi	RO50Xi	RO70Xi
EAN product code				5905567601125	5905567601132	5905567606229	5905567601156
Fan speed	H / M / L / S	rpm	960 / 830 / 730 / 630	1000 / 850 / 775 / 700	1050 / 882 / 798 / 714	1000 / 850 / 775 / 700	
Air flow	H / M / L / S	m <sup>3</sup> /h	530 / 440 / 360 / 280	560 / 470 / 380 / 290	685 / 580 / 490 / 400	1092 / 724 / 552 / 379	
Sound pressure level	H / M / L / S	dB(A)	37 / 32 / 21,5 / 20,5	40 / 33 / 22 / 21	41 / 35 / 23 / 22	44,5 / 40 / 33 / 21	
Sound power level		dB(A)	58	59	59	65	
Rated input		W	21	25	36	60	
Operating current		A	0,2	0,2	0,2	0,3	
Net dimensions	W × D × H	mm	795 × 225 × 295	795 × 225 × 295	965 × 239 × 319	1140 × 275 × 370	
Gross dimensions	W × D × H	mm	870 × 305 × 370	870 × 305 × 370	1045 × 325 × 400	1230 × 355 × 455	
Net weight / Gross weight		kg	10,2 / 13	10,2 / 13	12,3 / 16,4	20 / 25,3	
Condensate drain		mm	16	16	16	16	
Outdoor unit				RO26Xo	RO35Xo	RO50Xo	RO70Xo
EAN product code				5905567601163	5905567601170	5905567606236	5905567601194
Fan speed	H / M / L	rpm	760 / 555 / 350	760 / 555 / 350	700 / 615 / 530	830 / 700 / 550	
Maximum air flow		m <sup>3</sup> /h	2200	2200	3500	3500	
Sound pressure level		dB(A)	57	57,5	56	58,5	
Sound power level		dB(A)	64	65	65	68	
Net dimensions	W × D × H	mm	805 × 330 × 554	805 × 330 × 554	890 × 342 × 673	890 × 342 × 673	
Gross dimensions	W × D × H	mm	915 × 370 × 615	915 × 370 × 615	995 × 398 × 740	995 × 398 × 740	
Bracket spacing	W × D	(mm)	511 × 317	511 × 317	663 × 348	663 × 348	
Net weight / Gross weight		kg	28,4 / 31	28,4 / 31	38,8 / 41,9	45,6 / 48,8	
Refrigerant	Type		R32	R32	R32	R32	
	GWP*		675	675	675	675	
	Charged (≤ 5m)	kg	0,69	0,69	1,10	1,50	
		TCO <sub>2</sub> eq	0,465	0,465	0,74	1,01	
Charged (> 5m)	g/m	12	12	12	24		
Pipe connections	Liquid / Gas	mm (inch)	Φ6,35 / Φ9,52 (1/4" / 3/8")	Φ6,35 / Φ9,52 (1/4" / 3/8")	Φ6,35 / Φ12,7 (1/4" / 1/2")	Φ9,52 / Φ15,9 (3/8" / 5/8")	
Maximum installation length		m	25	25	30	50	
Maximum height difference		m	10	10	20	25	
Compressor type				Rotary DC	Rotary DC	Rotary DC	Rotary DC
Type of outdoor unit power supply			V-Hz, Ø	220-240-50, 1f	220-240-50, 1f	220-240-50, 1f	220-240-50, 1f
Current protection			A	B10	B10	B16	B20
Power cables: outdoor unit	L < 20m	pcs × mm <sup>2</sup>	3 × 1,5	3 × 1,5	3 × 1,5	3 × 2,5	
Control and power cables: indoor unit - outdoor unit		pcs × mm <sup>2</sup>	5 × 1,5	5 × 1,5	5 × 1,5	5 × 2,5	
Control and power cables: hiro unit - indoor unit		pcs × mm <sup>2</sup>	4 × 1,5	4 × 1,5	4 × 1,5	4 × 1,5	
Indoor operating range (cooling / heating)			°C	16-32 / 0-30	16-32 / 0-30	16-32 / 0-30	16-32 / 0-30
Outdoor operating range (cooling / heating)			°C	-15-50 / -25-30	-15-50 / -25-30	-15-50 / -25-30	-15-50 / -25-30
Compatible systems							
1:1 SINGLE				•	•	•	•
1:2 DUAL							
1:X MULTI S-LINE				•	•	•	•
1:X MULTI N-LINE							
1:X MULTI HP-LINE				•	•	•	•

T - Turbo; H - High; M - Medium; L - Low; ML - Medium Low; S - Silent

For RO70Xi unit with Ø9.52 (3/8") and Ø15.9 (5/8") connections in MULTI systems, reduction required at outdoor unit to Ø6.35 (1/4") and Ø12.7 (1/2").



## Wall-mounted air conditioner **Teta**

**We created the Teta air conditioner as a modern, year-round cooling and heating unit, taking care of comfort and air quality in your room.**

The streamlined design, minimalist form and completely matte panel create a unlimited interior design possibilities.

Teta Mirror is a deep matte black the housings combined with the black mirrored front make up the modern and versatile look of the air conditioner, which will work well in interiors of different styles.

The reliability of the heating function, even at low outdoor temperatures down to -25°C, allows you to use the air conditioner as the only source of heat in your home or apartment.

Feel the comfort with Windless technology. Teta releases air in a gentle, maximally dispersed stream through countless micro-openings.

With a self-cleaning function and an 11-stage air quality improvement system, Teta takes care of your health.

The built-in UV LED lamp and bipolar Super Ionizer effectively eliminate microorganisms, bacteria, fungi and toxic substances, making the air in the air-conditioned room healthier.





### Matte housing

Teta air conditioner has a matte front panel finish in two color options: white and black. Teta Mirror is also a version with a mirrored front panel.



### Comfortable windless air supply

Thanks to Windless technology - Teta releases air in a gentle, maximally dispersed-stream through 975 microholes. All for your pleasure.



### Lamp UV

Built-in iAIR LED UV lamp effectively eliminates microorganisms, bacteria, fungi and toxic substances, making the air in the room healthier.



### 12 stages of PureR Stage purification

The healthy air system consists of up to of 12 stages of air purification and filtration. It removes most of the harmful bacteria, viruses, mites and fungi from the environment so that you you can breathe clean and healthy air.



### Bipolar iAIR Super Ionizer

By creating negative oxygen ions, Super Ionizer iAIR eliminates viruses, bacteria, dust mites and allergens from the air. Unpleasant odours are removed practically as soon as the ionizer comes into contact with the contaminated air.



### Heating even at -25°C

The applied compressor technology, EXV valve and year-round operation package guarantee unprecedented efficiency of the air conditioner in heating mode, even in extreme weather conditions. In addition to the room air-conditioning function, this year-round device can work as the only source of heat in a house, apartment or office.

# TETA

## MIRROR

### WIBBOB



92



**EASY**  
SERVICE



**QUICK**  
MAINTENANCE

Thanks to the unique design of the air conditioner housing based on 3 screws, service and maintenance of the model Teta is much faster compared to Standard solutions.





# WINDLESS

## GENTLE AIR SUPPLY

Thanks to Windless technology, Tetra releases air with a gentle, maximum dispersed stream at only 18 dB of volume. The Windless function is available in Cooling mode.

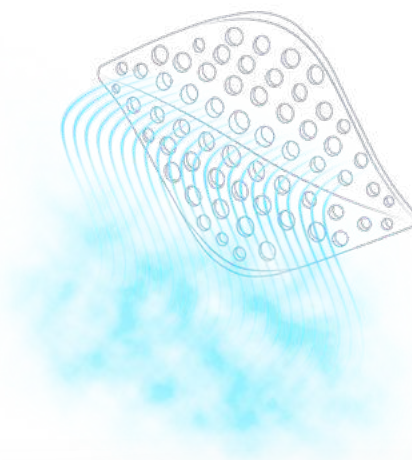

# TETA

# MIRROR

# WIKBOB



effect  
MIRROR  
MIRROR

94



Minimalist form, deep black and an interesting melange of textures make up the air conditioner's extremely elegant design.

Teta Mirror is an ideal choice for interiors where black plays a major role. The combination of matte front panel finish and mirrored front panel allows you to arrange the air conditioner in interiors that combine elements made of natural materials with glossy accessories.

# MIRROR

# BLACK PANEL

**klimaakcia**  
[www.klimaakcia.sk](http://www.klimaakcia.sk)



MATTE  
BLACK BODY



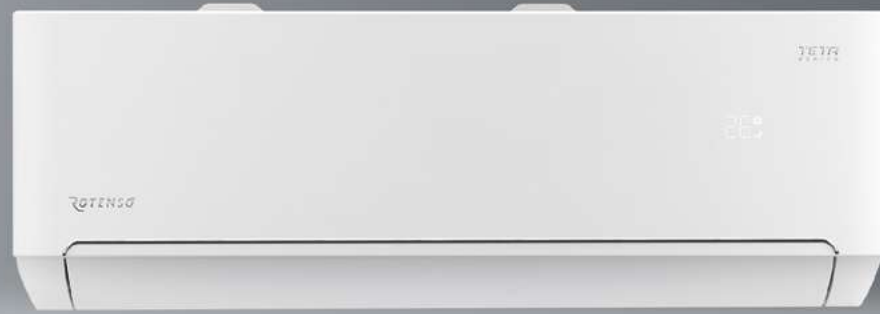
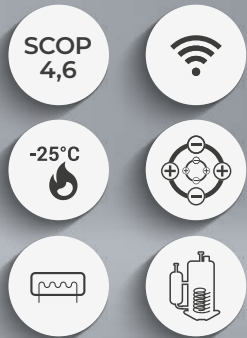

## Features device

 SKY inverter Digital DC Inverter SKY®	 Automatic cleaning iAIR	 Automatic purification iClean <sup>(1)</sup>	 Super Ionizer iAIR	 UV lamp	 3-in-1 filter (Ca + Si.Ion + vit.C) iAIR <sup>(*)</sup>	 3-in-1 filter (Photo. + Ac.c + Nano) iAIR <sup>(**)</sup>	 Electrostatic HD iAIR filter
 Super Silent eMOTO mode	 Automatic 4D louvers	 Windless eMOTO mode	 Turbo eMOTO mode	 Air supply control system eMOTO	 ECO eMOTO mode <sup>(1)</sup>	 Wide angle eMOTO air supply	 SMART Wi-Fi
 Smart panel display ON/OFF	 SMART Follow mode <sup>(1)</sup>	 Wireless remote controller	 SMART heating to 8°C <sup>(1)</sup>	 Memory setting of the louvers	 Auto restart memory	 Anti-corrosive gold fins	 Drip tray heater
 Compressor winding heating <sup>(1)</sup>	 Timer	 Cooling at low outdoor temp. down to -15°C	 Heating at low outdoor temp. down to -25°C <sup>(1)</sup>	 Double-sided condensate drainage	 Self-diagnostics	 Sleep mode	 Energy optimization <sup>(1)</sup>

1. Feature not available in Multi Split system.

\* 3-in-1 iAIR filter: Catechin + Silver Ion + Vitamin C

\*\* 3-in-1 iAIR filter: Photocatalytic + Activated carbon + Cold Nano

Model				Teta 2,6 kw	Teta 3,5 kW	Teta 5,1 kW	Teta 6,9 kW
Capacity	Cooling	Nom. (Min. - Max.)	W	2610 (940-3700)	3510 (1000-4600)	5100 (1250-5920)	6910 (1830-7820)
Rated input		Nom. (Min. - Max.)	W	699 (240-1380)	1000 (290-1510)	1260 (330-2350)	1940 (410-2830)
Operating current		Nom. (Min. - Max.)	A	3,0 (1,0-6,0)	4,3 (1,3-6,6)	5,5 (1,4-10,2)	8,4 (1,8-12,3)
Capacity	Heating	Nom. (Min. - Max.)	W	3000 (940-4000)	3800 (1000-4900)	5800 (1250-6690)	7100 (1850-7960)
Rated input		Nom. (Min. - Max.)	W	740 (240-1552)	970 (290-1720)	1330 (340-2540)	1810 (420-3010)
Operating current		Nom. (Min. - Max.)	A	3,2 (1,0-6,7)	4,2 (1,3-7,5)	5,8 (1,5-11,0)	7,9 (1,8-13,1)
Reversible heat pump type				air-to-air	air-to-air	air-to-air	air-to-air
Design load in cooling mode			kW	2,6	3,5	5,1	6,9
SEER			W/W	8,5	8,5	8,5	8,5
Energy efficiency class - cooling				A+++	A+++	A+++	A+++
Annual electric energy consumption - cooling			kWh/a	108	145	210	285
Design load in heating mode (Tbiv -7°C)			kW	2,4	2,6	4,5	5,5
SCOP			W/W	4,6	4,6	4,6	4,6
Energy efficiency class - heating				A++	A++	A++	A++
Annual electric energy consumption - heating			kWh/a	731	792	1370	1674
Dehumidification			l/h	1,0	1,2	1,8	2,0
Maximum energy consumption			W	1552	1720	2540	3010
Maximum operating current			A	6,7	7,5	11,1	13,1
Indoor unit				TA26Xi	TA35Xi	TA50Xi	TA70Xi
EAN product code				5905567606489	5905567601248	5905567601255	5905567606519
Fan speed	T / H / M / L / ML / S	rpm	1250 / 1080 / 920 / 800 / 700 / 650	1250 / 1100 / 930 / 850 / 750 / 650	1220 / 1130 / 990 / 910 / 850 / 750	1220 / 1130 / 990 / 910 / 850 / 750	
Air flow	T / H / M / L / ML / S	m³/h	560 / 480 / 410 / 360 / 310 / 275	670 / 590 / 460 / 400 / 350 / 275	1000 / 930 / 810 / 700 / 610 / 490	1100 / 1030 / 910 / 780 / 690 / 540	
Sound pressure level	T / H / M / L / ML / S	dB(A)	42 / 38 / 33 / 27 / 21 / 18	43 / 38 / 33 / 29 / 22 / 18	47 / 42 / 38 / 32 / 28 / 23	48 / 45 / 40 / 34 / 30 / 26	
Sound power level		dB(A)	52	53	57	58	
Rated input		W	25	25	45	45	
Operating current		A	0,1	0,1	0,2	0,2	
Net dimensions	W × D × H	mm	790 × 192 × 275	820 × 195 × 306	1100 × 222 × 333	1100 × 222 × 333	
Gross dimensions	W × D × H	mm	860 × 265 × 345	890 × 265 × 380	1165 × 295 × 405	1165 × 295 × 405	
Net weight / Gross weight		kg	8,5 / 10,5	9,5 / 12	13 / 16	14 / 17	
Condensate drain		mm	16	16	16	16	
Outdoor unit				TO26Xo	TO35Xo	TO50Xo	TO70Xo
EAN product code				5905567606502	5905567601224	5905567601231	5905567606533
Fan speed	T / H / M / L / S	rpm	900 / 810 / 730 / 610 / 450	900 / 870 / 830 / 670 / 650	910 / 790 / 690 / 610 / 550	850 / 850 / 750 / 630 / 510	
Maximum air flow		m³/h	2200	2200	3000	4000	
Sound pressure level		dB(A)	51	53	54	59	
Sound power level		dB(A)	61	63	64	69	
Net dimensions	W × D × H	mm	795 × 305 × 551	795 × 305 × 551	920 × 380 × 699	967 × 421 × 803	
Gross dimensions	W × D × H	mm	835 × 328 × 575	835 × 328 × 575	949 × 392 × 732	1022 × 835 × 480	
Bracket spacing	W × D	(mm)	434 × 278	434 × 278	586 × 348	607 × 390	
Net weight / Gross weight		kg	23 / 25	25 / 28	37 / 40	47 / 50	
Refrigerant	Type		R32	R32	R32	R32	
	GWP*		675	675	675	675	
	Charged (≤ 5m)	kg	0,45	0,63	1,14	1,27	
		TCO <sub>2</sub> eq	0,304	0,426	0,770	0,858	
Charged (> 5m)	g/m	15	15	25	25		
Pipe connections	Liquid / Gas	mm (inch)	Φ6,35 / Φ9,52 (1/4" / 3/8")	Φ6,35 / Φ9,52 (1/4" / 3/8")	Φ6,35 / Φ12,7 (1/4" / 1/2")	Φ6,35 / Φ12,7 (1/4" / 1/2")	
Maximum installation length		m	25	25	25	25	
Maximum height difference		m	10	10	10	10	
Compressor type				Rotary DC	Rotary DC	Rotary DC	Rotary DC
Type of outdoor unit power supply		V-Hz, Ø	220-240-50, 1f	220-240-50, 1f	220-240-50, 1f	220-240-50, 1f	
Current protection		A	B10	B10	B16	B20	
Power cables: outdoor unit	L < 20m	pcs × mm²	3 × 1,5	3 × 1,5	3 × 1,5	3 × 2,5	
Control and power cables: indoor unit - outdoor unit		pcs × mm²	5 × 1,5	5 × 1,5	5 × 1,5	5 × 2,5	
Control and power cables: hiro unit - indoor unit		pcs × mm²	4 × 1	4 × 1	-	-	
Indoor operating range (cooling / heating)		°C	16~32 / 0~30	16~32 / 0~30	16~32 / 0~30	16~32 / 0~30	
Outdoor operating range (cooling / heating)		°C	-15~53 / -25~30	-15~53 / -25~30	-15~53 / -25~30	-15~53 / -25~30	
Compatible systems							
1:1 SINGLE				•	•	•	•
1:2 DUAL							
1:X MULTI S-LINE							
1:X MULTI N-LINE				•	•		
1:X MULTI HP-LINE							

T - Turbo ; H - High; M - Medium; L - Low; ML - Medium Low; S - Silent



## Features device

Digital DC Inverter SKY®	Automatic cleaning iAIR	Automatic purification iClean <sup>(1)</sup>	Super Ionizer iAIR	UV lamp	3-in-1 filter (Ca + Si, Ion + vit. C) iAI <sup>(*)</sup>	3-in-1 filter (Photo. + Ac.c + Nano) iAIR <sup>(**)</sup>	Electrostatic HD iAIR filter
Super Silent eMOTO mode	Automatic 4D louvres	Windless eMOTO mode	Turbo eMOTO mode	Air supply control system eMOTO	ECO eMOTO mode <sup>(1)</sup>	Wide angle eMOTO air supply	SMART Wi-Fi
Smart panel display ON/OFF	SMART Follow mode <sup>(1)</sup>	Wireless remote controller	SMART heating to 8°C <sup>(1)</sup>	Memory setting of the louvres	Auto restart memory	Anti-corrosive gold fins	Drip tray heater
Compressor winding heating <sup>(1)</sup>	Timer	Cooling at low outdoor temp. down to -15°C	Heating at low outdoor temp. down to -25°C <sup>(1)</sup>	Double-sided condensate drainage	Self-diagnostics	Sleep mode	Energy optimization <sup>(1)</sup>

1. Feature not available in Multi Split system.

\* 3-in-1 iAIR filter: Catechin + Silver Ion + Vitamin C

\*\* 3-in-1 iAIR filter: Photocatalytic + Activated carbon + Cold Nano

Model				Teta Mirror 2,6 kW	Teta Mirror 3,5 kW	Teta Mirror 5,1 kW	Teta Mirror 6,9 kW
Capacity	Cooling	Nom. (Min. - Max.)	W	2610 (940-3700)	3510 (1000-4600)	5100 (1250-5920)	6910 (1830-7820)
Rated input		Nom. (Min. - Max.)	W	699 (240-1380)	1000 (290-1510)	1260 (330-2350)	1940 (410-2830)
Operating current		Nom. (Min. - Max.)	A	3,0 (1,0-6,0)	4,3 (1,3-6,6)	5,5 (1,4-10,2)	8,4 (1,8-12,3)
Capacity	Heating	Nom. (Min. - Max.)	W	3000 (940-4000)	3800 (1000-4900)	5800 (1250-6690)	7100 (1850-7960)
Rated input		Nom. (Min. - Max.)	W	740 (240-1552)	970 (290-1720)	1330 (340-2540)	1810 (420-3010)
Operating current		Nom. (Min. - Max.)	A	3,2 (1,0-6,7)	4,2 (1,3-7,5)	5,8 (1,5-11,0)	7,9 (1,8-13,1)
Reversible heat pump type				air-to-air	air-to-air	air-to-air	air-to-air
Design load in cooling mode			kW	2,6	3,5	5,1	6,9
SEER			W/W	8,5	8,5	8,5	8,5
Energy efficiency class - cooling				A+++	A+++	A+++	A+++
Annual electric energy consumption - cooling			kWh/a	108	145	210	285
Design load in heating mode (Tbiv -7°C)			kW	2,4	2,6	4,5	5,5
SCOP			W/W	4,6	4,6	4,6	4,6
Energy efficiency class - heating				A++	A++	A++	A++
Annual electric energy consumption - heating			kWh/a	731	792	1370	1674
Dehumidification			l/h	1,0	1,2	1,8	2,0
Maximum energy consumption			W	1552	1720	2540	3010
Maximum operating current			A	6,7	7,5	11,1	13,1
Indoor unit				TM26Xi	TM35Xi	TM50Xi	TM70Xi
EAN product code				5905567606496	5905567601200	5905567601217	5905567606526
Fan speed	T / H / M / L / ML / S	rpm	1250 / 1080 / 920 / 800 / 700 / 650	1250 / 1100 / 930 / 850 / 750 / 650	1220 / 1130 / 990 / 910 / 850 / 750	1220 / 1130 / 990 / 910 / 850 / 750	
Air flow	T / H / M / L / ML / S	m³/h	560 / 480 / 410 / 360 / 310 / 275	670 / 590 / 460 / 400 / 350 / 275	1000 / 930 / 810 / 700 / 610 / 490	1100 / 1030 / 910 / 780 / 690 / 540	
Sound pressure level	T / H / M / L / ML / S	dB(A)	42 / 38 / 33 / 27 / 21 / 18	43 / 38 / 33 / 29 / 22 / 18	47 / 42 / 38 / 32 / 28 / 23	48 / 45 / 40 / 34 / 30 / 26	
Sound power level		dB(A)	52	53	57	58	
Rated input		W	25	25	45	45	
Operating current		A	0,1	0,1	0,2	0,2	
Net dimensions	W × D × H	mm	790 × 192 × 275	820 × 195 × 306	1100 × 222 × 333	1100 × 222 × 333	
Gross dimensions	W × D × H	mm	860 × 265 × 345	890 × 265 × 380	1165 × 295 × 405	1165 × 295 × 405	
Net weight / Gross weight		kg	8,5 / 10,5	9,5 / 12	13 / 16	14 / 17	
Condensate drain		mm	16	16	16	16	
Outdoor unit				TO26Xo	TO35Xo	TO50Xo	TO70Xo
EAN product code				5905567606502	5905567601224	5905567601231	5905567606533
Fan speed	T / H / M / L / S	rpm	900 / 810 / 730 / 610 / 450	900 / 870 / 830 / 670 / 650	910 / 790 / 690 / 610 / 550	850 / 850 / 750 / 630 / 510	
Maximum air flow		m³/h	2200	2200	3000	4000	
Sound pressure level		dB(A)	51	53	54	59	
Sound power level		dB(A)	61	63	64	69	
Net dimensions	W × D × H	mm	795 × 305 × 551	795 × 305 × 551	920 × 380 × 699	967 × 421 × 803	
Gross dimensions	W × D × H	mm	835 × 328 × 575	835 × 328 × 575	949 × 392 × 732	1022 × 835 × 480	
Bracket spacing	W × D	(mm)	434 × 278	434 × 278	586 × 348	607 × 390	
Net weight / Gross weight		kg	23 / 25	25 / 28	37 / 40	47 / 50	
Refrigerant	Type		R32	R32	R32	R32	
	GWP*		675	675	675	675	
	Charged (≤ 5m)	kg	0,45	0,63	1,14	1,27	
		TCO <sub>2,eq</sub>	0,304	0,426	0,770	0,858	
Charged (> 5m)	g/m	15	15	25	25		
Pipe connections	Liquid / Gas	mm (inch)	Φ6,35 / Φ9,52 (1/4" / 3/8")	Φ6,35 / Φ9,52 (1/4" / 3/8")	Φ6,35 / Φ12,7 (1/4" / 1/2")	Φ6,35 / Φ12,7 (1/4" / 1/2")	
Maximum installation length		m	25	25	25	25	
Maximum height difference		m	10	10	10	10	
Compressor type				Rotary DC	Rotary DC	Rotary DC	Rotary DC
Type of outdoor unit power supply		V-Hz, Ø	220-240-50, 1f	220-240-50, 1f	220-240-50, 1f	220-240-50, 1f	
Current protection		A	B10	B10	B16	B20	
Power cables: outdoor unit	L < 20m	pcs × mm²	3 × 1,5	3 × 1,5	3 × 1,5	3 × 2,5	
Control and power cables: indoor unit - outdoor unit		pcs × mm²	5 × 1,5	5 × 1,5	5 × 1,5	5 × 2,5	
Control and power cables: hiro unit - indoor unit		pcs × mm²	4 × 1	4 × 1	-	-	
Indoor operating range (cooling / heating)		°C	16-32 / 0-30	16-32 / 0-30	16-32 / 0-30	16-32 / 0-30	
Outdoor operating range (cooling / heating)		°C	-15-53 / -25-30	-15-53 / -25-30	-15-53 / -25-30	-15-53 / -25-30	
Compatible systems							
1:1 SINGLE				•	•	•	•
1:2 DUAL							
1:X MULTI S-LINE							
1:X MULTI N-LINE				•	•		
1:X MULTI HP-LINE							

T - Turbo ; H - High; M - Medium; L - Low; ML - Medium Low; S - Silent



## Wall-mounted air conditioner **Elis**

**If you are looking for an unusual, modern form and an elegant accent for a fashionable interior in a loft, industrial or glamour style, here is Elis.**

The Elis air conditioner has an A++ cooling energy class and many functions useful in everyday use, such as: super Silent mode, Sleep mode, Timer, SMART Follow mode or Turbo mode.

Anti-corrosive gold fins of the unit effectively protect it from bacterial growth and prevent corrosion, maximizing the life of the air conditioner.

The air conditioner can operate in Heating mode even when the outside temperature drops to  $-20^{\circ}\text{C}$ .

The Wi-Fi module allows you to control the unit with a tablet or smartphone both inside and outside the home.



**ANTI-BACTERIAL  
GOLD-PLATED FINIS**

**klimaakcia**  
[www.klimaakcia.sk](http://www.klimaakcia.sk)



### Luxurious front panel

The minimalist form of the front panel imitating a sheet of dark glass fits perfectly in fashionable interiors in loft style, industrial or glamour.



### 10 stages of PureR Stage purification

The healthy air system consists of up to 10 stages of air purification and filtration to remove most of the harmful bacteria, viruses, dust mites and fungi from your environment so you can breathe clean and healthy air.



### Automatic 4D louvres

Built-in actuators allow you to control the operation of vertical and horizontal louvre with a remote control or wall-mounted controller. Guarantees it the highest level of operating comfort and ensures efficient air distribution in the room.



### Antibacterial gold-plated fins

The unique gold coating on the outdoor unit and Indoor unit has self-cleaning properties, so it effectively protects the unit from corrosion and prevents the proliferation of bacteria.



### Function SMART Wi-Fi

Utilizing SMART Wi-Fi and a Wi-Fi modem, you can control the unit with a tablet or smartphone both inside and outside the home.



### Heating even at -20°C

The inverter technology used enables efficient operation of the air conditioner even at low outside temperatures. Ukura will effectively heat a room even at -20°C.



## Features device

102



Digital DC Inverter SKY®



Automatic cleaning iAIR



Automatic purification iClean (1)



3-in-1 filter (Ca + Si.Ion + vit.C) iAI (1)



3-in-1 filter (Photo. + Ac.C + Nano) iAIR (\*\*)



Electrostatic HD iAIR filter



Super Silent eMOTO mode



Automatic 4D louvres



Turbo eMOTO mode



Air supply control system eMOTO



ECO eMOTO mode



Wide angle eMOTO air supply



SMART Wi-Fi



Smart panel display ON/OFF



SMART Follow mode (1)



Wireless remote controller



SMART heating to 8°C (1)



Auto restart memory



Anti-corrosive gold fins



Timer



Cooling at low outdoor temp. down to -15°C



Heating at low outdoor temp. down to -20°C



Double-sided condensate drainage



Self-diagnostics



Sleep mode

1. Feature not available in Multi Split system.

\* 3-in-1 iAIR filter: Catechin + Silver Ion + Vitamin C

\*\* 3-in-1 iAIR filter: Photocatalytic + Activated carbon + Cold Nano

Model				Elis 2,6 kW	Elis 3,5 kW	Elis 5,1 kW	Elis 7,0 kW
Capacity	Cooling	Nom. (Min. - Max.)	W	2600 (940-3300)	3502 (1000-3770)	5140 (1250-5910)	7040 (1500-7800)
Rated input		Nom. (Min. - Max.)	W	851 (240-1380)	1130 (290-1500)	1567 (330-2350)	2166 (390-2800)
Operating current		Nom. (Min. - Max.)	A	3,7 (1-6,0)	4,9 (1,3-6,5)	6,8 (1,4-10,2)	9,4 (1,7-12,2)
Capacity	Heating	Nom. (Min. - Max.)	W	2680 (940-3200)	3517 (1000-3810)	5210 (1250-6070)	7200 (1500-7900)
Rated input		Nom. (Min. - Max.)	W	786 (240-1552)	1005 (290-1720)	1376 (340-2550)	2112 (390-3000)
Operating current		Nom. (Min. - Max.)	A	3,4 (1-6,7)	4,4 (1,3-7,5)	6,0 (1,5-11,1)	9,2 (1,7-13,0)
Reversible heat pump type				air-to-air	air-to-air	air-to-air	air-to-air
Design load in cooling mode			kW	2,6	3,4	5,1	7,0
SEER			W/W	6,1	6,1	6,5	6,5
Energy efficiency class - cooling				A++	A++	A++	A++
Annual electric energy consumption - cooling			kWh/a	150	196	275	377
Design load in heating mode (Tbiv -7°C)			kW	2,0	2,2	3,9	4,9
SCOP			W/W	4,0	4,0	4,0	4,0
Energy efficiency class - heating				A+	A+	A+	A+
Annual electric energy consumption - heating			kWh/a	700	770	1365	1715
Dehumidification			l/h	1,0	1,2	1,5	1,8
Maximum energy consumption			W	1552	1720	2550	3000
Maximum operating current			A	6,7	7,5	11,1	13,0
Indoor unit				E26Xi	E35Xi	E50Xi	E70Xi
EAN product code				5905567614316	5905567614330	5905567614347	5905567614354
Fan speed	T / H / M / L / S	rpm	1400 / 1300 / 1100 / 1050 / 900	1400 / 1320 / 1150 / 1050 / 850	1400 / 1260 / 1150 / 960 / 800	1270 / 1200 / 1100 / 920 / 700	
Air flow	T / H / M / L / S	m³/h	420 / 390 / 330 / 320 / 270	570 / 530 / 460 / 430 / 360	800 / 760 / 690 / 580 / 440	1000 / 950 / 870 / 720 / 590	
Sound pressure level	T / H / M / L / S	dB(A)	42 / 37 / 33 / 25 / 22	43 / 38 / 35 / 27 / 22	45 / 40 / 37 / 34 / 27	46 / 41 / 39 / 36 / 30	
Sound power level		dB(A)	52	53	56	58	
Rated input		W	30	35	52	65	
Operating current		A	0,1	0,2	0,2	0,3	
Net dimensions	W × D × H	mm	698 × 205 × 255	777 × 205 × 250	910 × 205 × 292	1010 × 220 × 315	
Gross dimensions	W × D × H	mm	765 × 260 × 335	850 × 275 × 320	977 × 276 × 367	1094 × 300 × 386	
Net weight / Gross weight		kg	6,5 / 8,5	7 / 9	9,5 / 11,5	12 / 14	
Condensate drain		mm	16	16	16	16	
Outdoor unit				EO26Xo	EO35Xo	EO50Xo	EO70Xo
EAN product code				5905567614361	5905567614378	5905567614385	5905567614392
Fan speed	T / H / M / L / S	rpm	930 / 930 / 830 / 730 / 630	1000 / 910 / 830 / 710 / 710	910 / 830 / 710 / 630 / 450	930 / 830 / 690 / 570 / 450	
Maximum air flow		m³/h	1700	1700	2600	3000	
Sound pressure level		dB(A)	52	54	55	57	
Sound power level		dB(A)	62	62	65	67	
Net dimensions	W × D × H	mm	740 × 253 × 459	740 × 253 × 459	794 × 347 × 602	845 × 336 × 693	
Gross dimensions	W × D × H	mm	765 × 310 × 481	765 × 310 × 481	895 × 385 × 645	960 × 400 × 732	
Bracket spacing	W × D	(mm)	362 × 256	362 × 256	516 × 314	586 × 347	
Net weight / Gross weight		kg	19 / 21	20 / 22	30 / 32,5	40,5 / 42	
Refrigerant	Type		R32	R32	R32	R32	
	GWP*		675	675	675	675	
	Charged (≤ 5m)	kg	0,49	0,52	0,96	1,14	
		TCO <sub>2</sub> eq	0,33	0,35	0,65	0,77	
Charged (> 5m)	g/m	12	12	12	12		
Pipe connections	Liquid / Gas	mm (inch)	Φ6,35 / Φ9,52 (1/4" / 3/8")	Φ6,35 / Φ9,52 (1/4" / 3/8")	Φ6,35 / Φ9,52 (1/4" / 3/8")	Φ6,35 / Φ12,7 (1/4" / 1/2")	
Maximum installation length			m	25	25	25	
Maximum height difference			m	10	10	10	
Compressor type				Rotary DC	Rotary DC	Rotary DC	Rotary DC
Type of outdoor unit power supply			V-Hz, Ø	220-240-50, 1f	220-240-50, 1f	220-240-50, 1f	220-240-50, 1f
Current protection			A	B10	B10	B16	B20
Power cables: outdoor unit	L < 20m	pcs × mm²	3 × 1,5	3 × 1,5	3 × 1,5	3 × 2,5	
Control and power cables: indoor unit - outdoor unit			pcs × mm²	4 × 1	4 × 1	4 × 1	4 × 1
Control and power cables: hiro unit - indoor unit			pcs × mm²	4 × 1	4 × 1	4 × 1	-
Indoor operating range (cooling / heating)			°C	16-32 / 0-30	16-32 / 0-30	16-32 / 0-30	16-32 / 0-30
Outdoor operating range (cooling / heating)			°C	-15-53 / -20-30	-15-53 / -20-30	-15-53 / -20-30	-15-53 / -20-30
Compatible systems							
1:1 SINGLE				•	•	•	•
1:2 DUAL							
1:X MULTI S-LINE							
1:X MULTI N-LINE				•	•	•	•
1:X MULTI HP-LINE							

T - Turbo ; H - High; M - Medium; L - Low; ML - Medium Low; S - Silent

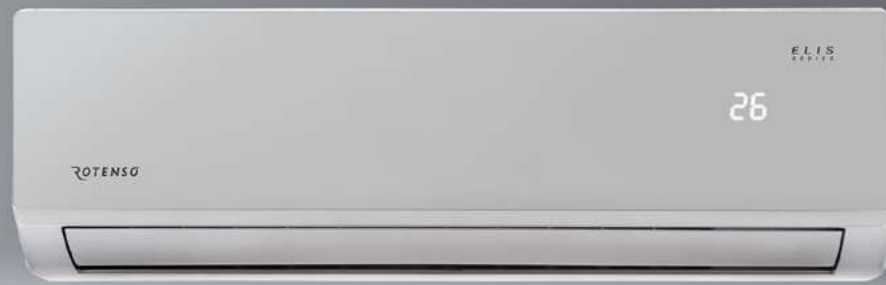

## Features device

104



Digital DC Inverter SKY®



Automatic cleaning iAIR



Automatic purification iClean (1)



3-in-1 filter (Ca + Si.Ion + vit.C) iAI (1)



3-in-1 filter (Photo. + Ac.C + Nano) iAIR (\*\*)



Electrostatic HD iAIR filter



Super Silent eMOTO mode



Automatic 4D louvres



Turbo eMOTO mode



Air supply control system eMOTO



ECO eMOTO mode



Wide angle eMOTO air supply



Funkcja SMART Wi-Fi



Smart panel display ON/OFF



SMART Follow mode (1)



Wireless remote controller



SMART heating to 8°C (1)



Auto restart memory



Anti-corrosive gold fins



Timer



Cooling at low outdoor temp. down to -15°C



Heating at low outdoor temp. down to -20°C



Double-sided condensate drainage



Self-diagnostics



Sleep mode

1. Feature not available in Multi Split system.

\* 3-in-1 iAIR filter: Catechin + Silver Ion + Vitamin C

\*\* 3-in-1 iAIR filter: Photocatalytic + Activated carbon + Cold Nano

Model				Elis Silver 2,6 kW	Elis Silver 3,5 kW	Elis Silver 5,1 kW	Elis Silver 7,0 kW
Capacity	Cooling	Nom. (Min. - Max.)	W	2600 (940-3300)	3502 (1000-3770)	5140 (1250-5910)	7040 (1500-7800)
Rated input		Nom. (Min. - Max.)	W	851 (240-1380)	1130 (290-1500)	1567 (330-2350)	2166 (390-2800)
Operating current		Nom. (Min. - Max.)	A	3,7 (1-6,0)	4,9 (1,3-6,5)	6,8 (1,4-10,2)	9,4 (1,7-12,2)
Capacity	Heating	Nom. (Min. - Max.)	W	2680 (940-3200)	3517 (1000-3810)	5210 (1250-6070)	7200 (1500-7900)
Rated input		Nom. (Min. - Max.)	W	786 (240-1552)	1005 (290-1720)	1376 (340-2550)	2112 (390-3000)
Operating current		Nom. (Min. - Max.)	A	3,4 (1-6,7)	4,4 (1,3-7,5)	6,0 (1,5-11,1)	9,2 (1,7-13,0)
Reversible heat pump type				air-to-air	air-to-air	air-to-air	air-to-air
Design load in cooling mode			kW	2,6	3,4	5,1	7,0
SEER			W/W	6,1	6,1	6,5	6,5
Energy efficiency class - cooling				A++	A++	A++	A++
Annual electric energy consumption - cooling			kWh/a	150	196	275	377
Design load in heating mode (T <sub>biv</sub> -7°C)			kW	2,0	2,2	3,9	4,9
SCOP			W/W	4,0	4,0	4,0	4,0
Energy efficiency class - heating				A+	A+	A+	A+
Annual electric energy consumption - heating			kWh/a	700	770	1365	1715
Dehumidification			l/h	1,0	1,2	1,5	1,8
Maximum energy consumption			W	1552	1720	2550	3000
Maximum operating current			A	6,7	7,5	11,1	13,0
Indoor unit				ES26Xi	ES35Xi	ES50Xi	ES70Xi
EAN product code				5905567614279	5905567614309	5905567614293	5905567614286
Fan speed	T / H / M / L / S	rpm	1400 / 1300 / 1100 / 1050 / 900	1400 / 1320 / 1150 / 1050 / 850	1400 / 1260 / 1150 / 960 / 800	1270 / 1200 / 1100 / 920 / 700	
Air flow	T / H / M / L / S	m <sup>3</sup> /h	420 / 390 / 330 / 320 / 270	570 / 530 / 460 / 430 / 360	800 / 760 / 690 / 580 / 440	1000 / 950 / 870 / 720 / 590	
Sound pressure level	T / H / M / L / S	dB(A)	42 / 37 / 33 / 25 / 22	43 / 38 / 35 / 27 / 22	45 / 40 / 37 / 34 / 27	46 / 41 / 39 / 36 / 30	
Sound power level		dB(A)	52	53	56	58	
Rated input		W	30	35	52	65	
Operating current		A	0,1	0,2	0,2	0,3	
Net dimensions	W × D × H	mm	698 × 205 × 255	777 × 205 × 250	910 × 205 × 292	1010 × 220 × 315	
Gross dimensions	W × D × H	mm	765 × 260 × 335	850 × 275 × 320	977 × 276 × 367	1094 × 300 × 386	
Net weight / Gross weight		kg	6,5 / 8,5	7 / 9	9,5 / 11,5	12 / 14	
Condensate drain		mm	16	16	16	16	
Outdoor unit				EO26Xo	EO35Xo	EO50Xo	EO70Xo
EAN product code				5905567614361	5905567614378	5905567614385	5905567614392
Fan speed	T / H / M / L / S	rpm	930 / 930 / 830 / 730 / 630	1000 / 910 / 830 / 710 / 710	910 / 830 / 710 / 630 / 450	930 / 830 / 690 / 570 / 450	
Maximum air flow		m <sup>3</sup> /h	1700	1700	2600	3000	
Sound pressure level		dB(A)	52	54	55	57	
Sound power level		dB(A)	62	62	65	67	
Net dimensions	W × D × H	mm	740 × 253 × 459	740 × 253 × 459	794 × 347 × 602	845 × 336 × 693	
Gross dimensions	W × D × H	mm	765 × 310 × 481	765 × 310 × 481	895 × 385 × 645	960 × 400 × 732	
Bracket spacing	W × D	(mm)	362 × 256	362 × 256	516 × 314	586 × 347	
Net weight / Gross weight		kg	19 / 21	20 / 22	30 / 32,5	40,5 / 42	
Refrigerant	Type		R32	R32	R32	R32	
	GWP*		675	675	675	675	
	Charged (≤ 5m)	kg	0,49	0,52	0,96	1,14	
		TCO <sub>2</sub> eq	0,33	0,35	0,65	0,77	
Charged (> 5m)	g/m	12	12	12	12		
Pipe connections	Liquid / Gas	mm (inch)	Φ6,35 / Φ9,52 (1/4" / 3/8")	Φ6,35 / Φ9,52 (1/4" / 3/8")	Φ6,35 / Φ9,52 (1/4" / 3/8")	Φ6,35 / Φ12,7 (1/4" / 1/2")	
Maximum installation length		m	25	25	25	25	
Maximum height difference		m	10	10	10	10	
Compressor type				Rotary DC	Rotary DC	Rotary DC	Rotary DC
Type of outdoor unit power supply			V-Hz, Ø	220-240-50, 1f	220-240-50, 1f	220-240-50, 1f	220-240-50, 1f
Current protection			A	B10	B10	B16	B20
Power cables: outdoor unit	L < 20m	pcs × mm <sup>2</sup>	3 × 1,5	3 × 1,5	3 × 1,5	3 × 2,5	
Control and power cables: indoor unit - outdoor unit		pcs × mm <sup>2</sup>	4 × 1	4 × 1	4 × 1	4 × 1	
Control and power cables: hiro unit - indoor unit		pcs × mm <sup>2</sup>	4 × 1	4 × 1	4 × 1	-	
Indoor operating range (cooling / heating)			°C	16-32 / 0-30	16-32 / 0-30	16-32 / 0-30	16-32 / 0-30
Outdoor operating range (cooling / heating)			°C	-15-53 / -20-30	-15-53 / -20-30	-15-53 / -20-30	-15-53 / -20-30
Compatible systems							
1:1 SINGLE				•	•	•	•
1:2 DUAL							
1:X MULTI S-LINE							
1:X MULTI N-LINE				•	•	•	•
1:X MULTI HP-LINE							

T - Turbo ; H - High; M - Medium; L - Low; ML - Medium Low; S - Silent



## Wall-mounted air conditioner **Imoto**

**Always fashionable, classic design and optimal features and filters will make you like Imoto.**

Panel edge is finished with transparent acrylic glass, which emphasizes the prestigious character of the unit. Despite its small size, the Imoto offers a very wide air flow angle, ensuring optimal temperature even in larger rooms.

The unit is equipped with an air ionizer and a series of properly selected filters for maximum capacity and effective cleaning.

The innovative filters are responsible for removing from the air all impurities (hair, dust, allergens, pollen, dust mites, mold spores and unpleasant odors).

Using a friendly mobile app, you can control the air conditioner from anywhere in the house and beyond.



klimaakcia  
[www.klimaakcia.sk](http://www.klimaakcia.sk)  
ANTIBACTERIAL HEPA AIR FILTER



### Antibacterial filter **HEPA iAIR**

The filter eliminates most mechanical impurities while disinfecting the air from fungal cells, protozoa, bacteria and viruses at 99,97%.



### Winter **package**

Imoto is an air conditioner suitable for year-round operation, both in Cooling and Heating modes. It effectively operates in heating mode even at temp. external -22°C. The reliability of the heating function is ensured by the built-in drip tray heater and compressor crankcase heater, which counteract the icing of the outdoor unit and fan disturbance, increasing the efficiency of operation.



### Antibacterial **gold-plated fins**

The unique gold coating on the outdoor unit and Indoor unit has self-cleaning properties, so it effectively protects the unit from corrosion and prevents the proliferation of bacteria.



### Automatic **4D louvres**

Built-in actuators allow you to control the operation of vertical and horizontal louvre with a remote control or wall-mounted controller. Guarantees it the highest level of operating comfort and ensures efficient air distribution in the room.



### Function **SMART Wi-Fi**

Thanks to the use of SMART Wi-Fi function and Wi-Fi modem, you can control the unit using a tablet or smartphone both inside and outside the home.



### Heating **even at -22°C**

The technology used and the built-in year-round operation package enable efficient operation of the air conditioner even in extreme weather conditions. The air conditioner will effectively heat the room even at low outdoor temperatures.

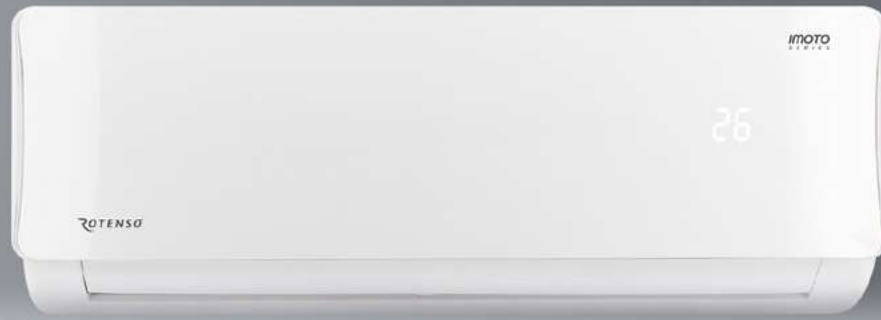
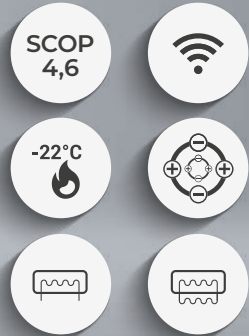

## Features device

108

- |   |                                     |  |  |                                      |                                  |                                 |                                 |
|---|-------------------------------------|--|--|--------------------------------------|----------------------------------|---------------------------------|---------------------------------|
| <br><b>SKY inverter</b><br>Digital DC Inverter SKY® | <br>Automatic cleaning iAIR (1)     | <br>Super Ionizer iAIR                         | <br>Cold Nano iAIR filter                      | <br>Antibacterial HEPA iAIR filter   | <br>Electrostatic HD iAIR filter | <br>Super Silent eMOTO mode (1) | <br>Automatic 4D louvres        |
| <br>Turbo eMOTO mode (1)                            | <br>Air supply control system eMOTO | <br>Wide angle eMOTO air supply                | <br>SMART Wi-Fi                                | <br>SMART port wired controller (2)  | <br>Smart panel display ON/OFF   | <br>SMART Follow mode           | <br>Wireless remote controller  |
| <br>Wired controller (2)                            | <br>SMART heating to 8°C (1)        | <br>Louvre setting memory                      | <br>1W standby mode (1)                        | <br>Auto restart memory              | <br>Anti-corrosive gold fins     | <br>Drip tray heater            | <br>Compressor crankcase heater |
| <br>Silence mode                                    | <br>Timer                           | <br>Cooling at low outdoor temp. down to -15°C | <br>Heating at low outdoor temp. down to -22°C | <br>Double-sided condensate drainage | <br>Self-diagnostics             | <br>Sleep mode                  | <br>BMS Modbus (2)              |
| <br>BMS Bacnet (2)                                  |                                     |  |  |                                      |                                  |                                 |                                 |

1. Feature not available in Multi Split system. 2. Feature is only optional. 3. Feature can be accessed via mobile app.

Model				Imoto 2,1 kW	Imoto 2,6 kW	Imoto 3,5 kW	Imoto 5,3 kW	Imoto 7,0 kW
Capacity	Cooling	Nom. (Min. - Max.)	W	2105	2638 (1026-3224)	3517 (1067-4381)	5275 (1934-6272)	7034 (3019-8792)
Rated input		Nom. (Min. - Max.)	W	-	613 (90-1140)	977 (130-1650)	1550 (150-2250)	2340 (340-3450)
Operating current		Nom. (Min. - Max.)	A	-	2,7 (0,4-5)	4,2 (0,6-7,2)	6,7 (0,7-9,8)	10,2 (1,5-15)
Capacity	Heating	Nom. (Min. - Max.)	W	2638	2931 (821-3370)	3810 (1067-4381)	5568 (1290-7004)	7327 (1524-9466)
Rated input		Nom. (Min. - Max.)	W	-	637 (110-1080)	977 (160-1560)	1500 (220-2350)	2130 (300-3150)
Operating current		Nom. (Min. - Max.)	A	-	2,8 (0,5-4,7)	4,2 (0,7-6,8)	6,5 (1,0-10,2)	9,3 (1,3-13,7)
Reversible heat pump type				air-to-air	air-to-air	air-to-air	air-to-air	air-to-air
Design load in cooling mode			kW	-	2,6	3,5	5,3	7,0
SEER			W/W	-	9,3	8,5	7,0	6,5
Energy efficiency class - cooling				-	A+++	A+++	A++	A++
Annual electric energy consumption - cooling			kWh/a	-	98	146	265	377
Design load in heating mode (Tbiv -7°C)			kW	-	2,4	2,6	4,1	4,9
SCOP			W/W	-	4,6	4,6	4,0	4,0
Energy efficiency class - heating				-	A++	A++	A+	A+
Annual electric energy consumption - heating			kWh/a	-	743	791	1435	1730
Dehumidification			l/h	0,9	1,0	1,2	1,8	2,4
Maximum energy consumption			W	-	2200	2200	2500	3700
Maximum operating current			A	-	9,6	9,6	10,9	16,1
Indoor unit				I21Xi	I26Xi	I35Xi	I50Xi	I70Xi
EAN product code				5905567600760	5905567600777	5905567600791	5905567600814	5905567600838
Fan speed	T / H / M / L / S	rpm	980 / 800 / 690 / 600	1000 / 820 / 710 / 630	1100 / 900 / 750 / 700	1150 / 950 / 800 / 700	1100 / 900 / 800 / 700	
Air flow	T / H / M / L / S	m³/h	511 / 403 / 303 / 242	483 / 433 / 362 / 303	584 / 477 / 395 / 292	850 / 730 / 500 / 420	1020 / 830 / 750 / 560	
Sound pressure level	T / H / M / L / S	dB(A)	35 / 25 / 21 / 20	36,5 / 29 / 24 / 20	39,5 / 33 / 25 / 21	43 / 33,5 / 28 / 22	47 / 41,5 / 30,5 / 25	
Sound power level		dB(A)	55	55	55	57	64	
Rated input		W	20	23	23	34	58	
Operating current		A	0,1	0,1	0,1	0,1	0,3	
Net dimensions	W × D × H	mm	802 × 189 × 297	802 × 189 × 297	802 × 189 × 297	965 × 215 × 319	1080 × 226 × 335	
Gross dimensions	W × D × H	mm	875 × 285 × 380	875 × 285 × 380	875 × 285 × 380	1045 × 305 × 405	1155 × 315 × 415	
Net weight / Gross weight		kg	8,6 / 11,1	8,6 / 11,1	8,6 / 11,1	10,9 / 14,2	13,7 / 17,3	
Condensate drain		mm	16	16	16	16	16	
Outdoor unit				-	I26Xo	I35Xo	I50Xo	I70Xo
EAN product code				-	5905567600784	5905567600807	5905567600821	5905567600845
Fan speed	H / M / L	rpm	-	780 / 640 / 450	800 / 710 / 450	810 / 700 / 650	830 / 700 / 550	
Maximum air flow		m³/h	-	2150	2200	2100	3500	
Sound pressure level		dB(A)	-	54	55	55	60	
Sound power level		dB(A)	-	60	62	65	67	
Net dimensions	W × D × H	mm	-	765 × 303 × 555	765 × 303 × 555	805 × 330 × 554	890 × 342 × 673	
Gross dimensions	W × D × H	mm	-	887 × 337 × 610	887 × 337 × 610	915 × 370 × 615	995 × 398 × 740	
Bracket spacing	W × D	(mm)	-	452 × 286	452 × 286	511 × 317	663 × 348	
Net weight / Gross weight		kg	-	26,4 / 28,8	26,4 / 28,7	33,5 / 36,1	43,9 / 46,9	
Refrigerant	Type		-	R32	R32	R32	R32	
	GWP*		-	675	675	675	675	
	Charged (≤ 5m)	kg	-	0,62	0,62	1,10	1,45	
		TCO <sub>2</sub> eq	-	0,418	0,418	0,74	0,978	
Charged (> 5m)	g/m	-	12	12	12	24		
Pipe connections	Liquid / Gas	mm (inch)	Φ6,35 / Φ9,52 (1/4" / 3/8")	Φ6,35 / Φ9,52 (1/4" / 3/8")	Φ6,35 / Φ9,52 (1/4" / 3/8")	Φ6,35 / Φ12,7 (1/4" / 1/2")	Φ9,52 / Φ15,9 (3/8" / 5/8")	
Maximum installation length		m	-	25	25	30	50	
Maximum height difference		m	-	10	10	20	25	
Compressor type			-	Rotary DC	Rotary DC	Rotary DC	Rotary DC	
Type of outdoor unit power supply		V-Hz, Ø	220-240-50, 1f	220-240-50, 1f	220-240-50, 1f	220-240-50, 1f	220-240-50, 1f	
Current protection		A	-	B10	B10	B16	B20	
Power cables: outdoor unit	L < 20m	pcs x mm²	Data in HIRO	3 × 1,5	3 × 1,5	3 × 1,5	3 × 2,5	
Control and power cables: indoor unit - outdoor unit		pcs x mm²	-	5 × 1,5	5 × 1,5	5 × 1,5	5 × 2,5	
Control and power cables: hiro unit - indoor unit		pcs x mm²	4 × 1,5	4 × 1,5	4 × 1,5	4 × 1,5	4 × 1,5	
Indoor operating range (cooling / heating)		°C	17-32 / 0-30	17-32 / 0-30	17-32 / 0-30	17-32 / 0-30	17-32 / 0-30	
Outdoor operating range (cooling / heating)		°C	-	-15-50 / -22-30	-15-50 / -22-30	-15-50 / -22-30	-15-50 / -22-30	
Compatible systems								
1:1 SINGLE					•		•	•
1:2 DUAL								
1:X MULTI S-LINE				•	•	•	•	•
1:X MULTI N-LINE								
1:X MULTI HP-LINE				•	•	•	•	•



## Wall-mounted air conditioner **Ukura H**

**Air conditioner with a compact design with modern curves of the front panel, enriched with delicate silver finishes.**

110

Ukura H (Generation X) is an economical unit with a high energy efficiency class A++.  
The air conditioner efficiently distributes air thanks to the 4D automatic supply system.  
It allows you to control the operation of vertical and horizontal louvres by remote control.

The use of additional filters: HEPA, Cold Nano, as well as electrostatic filter and air ionizer affects the effective elimination of pollutants and provides refreshed air in the room.

Ukura H is additionally equipped with Drip tray heater and Compressor crankcase heater, making it a highly efficient device for year-round operation.



BUILD-IN WINTER PACKAGE:  
**DRIP TRAY HEATER AND  
COMPRESSOR CRANKCASE HEATER**



## Function **SMART Wi-Fi**

By using SMART Wi-Fi and a Wi-Fi modem, you can control the unit, using a tablet or smartphone both inside and outside the home.



## Heating **even at -20°C**

The inverter technology used and the drip tray heater enable efficient operation of the air conditioner even at low outside temperatures. Ukura H will effectively heat a room even at -20°C.



## Automatic **4D louvres**

Built-in actuators allow you to control the operation of vertical and horizontal louvre with a remote control or wall-mounted controller. Guarantees it the highest level of operating comfort and ensures efficient air distribution in the room.



## Antibacterial **gold-plated fins**

The unique gold coating on the Outdoor unit and Indoor unit has self-cleaning properties, so it effectively protects the unit from corrosion and prevents the proliferation of bacteria.



## Bipolar iAIR **Super Ionizer**

By creating negative oxygen ions, Super Ionizer iAIR eliminates viruses, bacteria, dust mites and allergens from the air. Unpleasant odours are removed practically as soon as the ionizer comes into contact with the contaminated air.



## Built-in **winter package**

Ukura H is a model designed for year-round operation in both Cooling and Heating modes. It effectively operates in heating mode even at temp. external -20°C. The reliability of the heating function is ensured, among other things, by the built-in drip tray heater and compressor crankcase heater, which counteract the icing of the outdoor unit and fan disturbance, increasing the efficiency of operation.

# Ukura H

2,6-7,0 kW



S-LINE

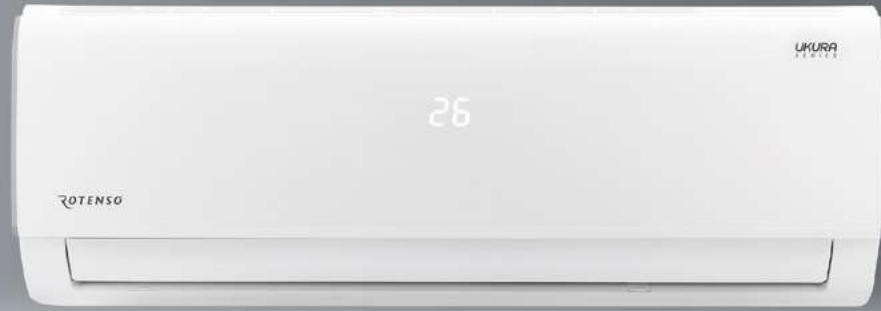

## Features device

112

 Digital DC Inverter SKY®	 Automatic cleaning iAIR	 Super Ionizer iAIR	 Cold Nano iAIR filter	 Antibacterial HEPA iAIR filter	 Electrostatic HD iAIR filter	 Super Silent eMOTO mode	 Automatic 4D louvres
 Turbo eMOTO mode	 Air supply control system eMOTO	 Wide angle eMOTO air supply	 SMART Wi-Fi	 SMART port wired controller <sup>(1)</sup>	 Smart panel display ON/OFF	 SMART Follow mode	 Wireless remote controller
 Wired controller <sup>(1)</sup>	 SMART heating to 8°C	 Louvre setting memory	 1W standby mode	 Auto restart memory	 Anti-corrosive gold fins	 Drip tray heater	 Compressor crankcase heater
 Silence mode	 Timer	 Cooling at low outdoor temp. down to -15°C	 Heating at low outdoor temp. down to -20°C	 Double-sided condensate drainage	 Self-diagnostics	 Sleep mode	

klimaakcia  
www.klimaakcia.sk

1. Feature is only optional.

Model				Ukura H 2,6 kW	Ukura H 3,5 kW	Ukura H 5,3 kW	Ukura H 7,0 kW
Capacity	Cooling	Nom. (Min. - Max.)	W	2638 (909-3400)	3517 (1114-3927)	5275 (1817-6154)	7034 (2081-7913)
Rated input		Nom. (Min. - Max.)	W	800 (100-1240)	1320 (83-1600)	1550 (140-2300)	2600 (420-3150)
Operating current		Nom. (Min. - Max.)	A	3,5 (0,4-5,4)	5,7 (0,4-7)	6,7 (0,6-10)	11,3 (1,8-13,7)
Capacity	Heating	Nom. (Min. - Max.)	W	2931 (821-3370)	3810 (1084-4162)	5568 (1290-6741)	7327 (1612-7913)
Rated input		Nom. (Min. - Max.)	W	930 (120-1200)	1190 (167-1400)	1570 (220-2350)	2400 (300-2750)
Operating current		Nom. (Min. - Max.)	A	4,0 (0,5-5,2)	5,2 (0,7-6,1)	6,8 (1,0-10,2)	10,4 (1,3-12,0)
Reversible heat pump type				air-to-air	air-to-air	air-to-air	air-to-air
Design load in cooling mode			kW	2,6	3,5	5,2	7,0
SEER			W/W	7,0	6,5	7,2	6,1
Energy efficiency class - cooling				A++	A++	A++	A++
Annual electric energy consumption - cooling			kWh/a	130	188	253	402
Design load in heating mode (T <sub>biv</sub> -7°C)			kW	2,3	2,8	4,1	4,8
SCOP			W/W	4,1	4,1	4,0	4,0
Energy efficiency class - heating				A+	A+	A+	A+
Annual electric energy consumption - heating			kWh/a	788	958	1436	1682
Dehumidification			l/h	1	1,2	1,8	2,4
Maximum energy consumption			W	2150	2150	2500	3500
Maximum operating current			A	9,3	9,3	10,9	15,2
Indoor unit				U26Xi	U35Xi	U50Xi	U70Xi
EAN product code				5905567606304	5905567606335	5905567606366	5905567606397
Fan speed	H / M / L / S	rpm	1100 / 900 / 750 / 590	1130 / 950 / 750 / 590	1130 / 900 / 800 / 710	1130 / 900 / 800 / 710	
Air flow	H / M / L / S	m³/h	435 / 389 / 333 / 259	530 / 480 / 430 / 310	840 / 760 / 680 / 540	980 / 899 / 817 / 662	
Sound pressure level	H / M / L / S	dB(A)	37 / 32 / 25 / 21,5	39,5 / 35,5 / 25 / 21,5	42,5 / 36 / 26 / 20	45 / 40,5 / 36 / 29,5	
Sound power level		dB(A)	53	54	56	60	
Rated input		W	30	30	31	42	
Operating current		A	0,2	0,2	0,2	0,3	
Net dimensions	W × D × H	mm	715 × 194 × 285	805 × 194 × 285	957 × 213 × 302	1040 × 220 × 327	
Gross dimensions	W × D × H	mm	780 × 270 × 365	870 × 270 × 365	1035 × 295 × 385	1120 × 405 × 315	
Net weight / Gross weight		kg	6,7 / 8,8	7,6 / 9,8	10 / 13	12,3 / 15,8	
Condensate drain		mm	16	16	16	16	
Outdoor unit				UH26Xo	UH35Xo	UH50Xo	UH70Xo
EAN product code				5905567606328	5905567606359	5905567606380	5905567606410
Fan speed	H / M / L	rpm	780 / 700 / 600	780 / 700 / 600	740 / 700 / 650	830 / 700 / 550	
Maximum air flow		m³/h	1750	1750	2100	3500	
Sound pressure level		dB(A)	55	55	56	59	
Sound power level		dB(A)	62	64	64	67	
Net dimensions	W × D × H	mm	720 × 270 × 495	720 × 270 × 495	805 × 330 × 554	890 × 342 × 673	
Gross dimensions	W × D × H	mm	835 × 300 × 540	835 × 300 × 540	915 × 370 × 615	995 × 398 × 740	
Bracket spacing	W × D	(mm)	452 × 255	452 × 255	511 × 317	663 × 348	
Net weight / Gross weight		kg	21 / 22,8	23,2 / 25,0	32,7 / 35,4	42,9 / 45,9	
Refrigerant	Type		R32	R32	R32	R32	
	GWP*		675	675	675	675	
	Charged (≤ 5m)	kg	0,47	0,52	1,08	1,42	
		TCO <sub>2eq</sub>	0,317	0,351	0,729	0,958	
Charged (> 5m)	g/m	12	12	12	24		
Pipe connections	Liquid / Gas	mm (inch)	Φ6,35 / Φ9,52 (1/4" / 3/8")	Φ6,35 / Φ9,52 (1/4" / 3/8")	Φ6,35 / Φ12,7 (1/4" / 1/2")	Φ9,52 / Φ15,9 (3/8" / 5/8")	
Maximum installation length		m	25	25	30	50	
Maximum height difference		m	10	10	20	25	
Compressor type				Rotary DC	Rotary DC	Rotary DC	Rotary DC
Type of outdoor unit power supply			V-Hz, Ø	220-240-50, 1f	220-240-50, 1f	220-240-50, 1f	220-240-50, 1f
Current protection			A	B10	B10	B16	B20
Power cables: outdoor unit	L < 20 m	pcs × mm²	3 × 1,5	3 × 1,5	3 × 1,5	3 × 2,5	
Control and power cables: indoor unit - outdoor unit			pcs × mm²	5 × 1,5	5 × 1,5	5 × 1,5	5 × 2,5
Control and power cables: hiro unit - indoor unit			pcs × mm²	-	-	-	-
Indoor operating range (cooling / heating)			°C	17-32 / 0-30	17-32 / 0-30	17-32 / 0-30	17-32 / 0-30
Outdoor operating range (cooling / heating)			°C	-15-50 / -20-30	-15-50 / -20-30	-15-50 / -20-30	-15-50 / -20-30
Compatible systems							
1:1 SINGLE				•	•	•	•
1:2 DUAL							
1:X MULTI S-LINE							
1:X MULTI N-LINE							
1:X MULTI HP-LINE							



## Wall-mounted air conditioner **Ukura**

**You will be delighted by the classic white body broken by delicate silver panel finishes. A small but richly equipped air conditioner is the comfort you deserve.**

Despite its small size, the air conditioner is characterized by high efficiency. Thanks to the eMOTO turbo function, it reaches the set temperature very quickly, even when the outside temperature is low (-20°C).

Many useful functions that the air conditioner is equipped with, including: timer, memory for setting the louvres, Auto restart memory make you enjoy the comfort of use every day. The special iAIR mode automatically cleans and dehumidifies the interior of the air conditioner, preventing unpleasant odors and the multiplication of bacteria.

Thanks to the aforementioned features, the Ukura air conditioner is a very convenient and comfortable to use and has no equal in this class of air conditioners.



eMOTO **WIDE  
ANGLE SUPPLY**



### Function **SMART Wi-Fi**

By using SMART Wi-Fi and a Wi-Fi modem, you can control the unit, using a tablet or smartphone both inside and outside the home.



### Wide angle eMOTO **air supply**

The air conditioner, through a wide range of supply airflow, efficiently distributes air in the room, providing effective cooling or heating.



### Automatic **4D louvres**

Built-in actuators allow you to control the operation of vertical and horizontal louvre with a remote control or wall-mounted controller. Guarantees it the highest level of operating comfort and ensures efficient air distribution in the room.



### Antibacterial **gold-plated fins**

The unique gold coating on the outdoor unit and Indoor unit has self-cleaning properties, so it effectively protects the unit from corrosion and prevents the proliferation of bacteria.



### Bipolar iAIR **Super Ionizer**

By creating negative oxygen ions, Super Ionizer iAIR eliminates viruses, bacteria, dust mites and allergens from the air. Unpleasant odours are removed practically as soon as the ionizer comes into contact with the contaminated air.



### Heating **even at -20°C**

The inverter technology used enables efficient operation of the air conditioner even at low outside temperatures. Ukura will effectively heat a room even at -20°C.

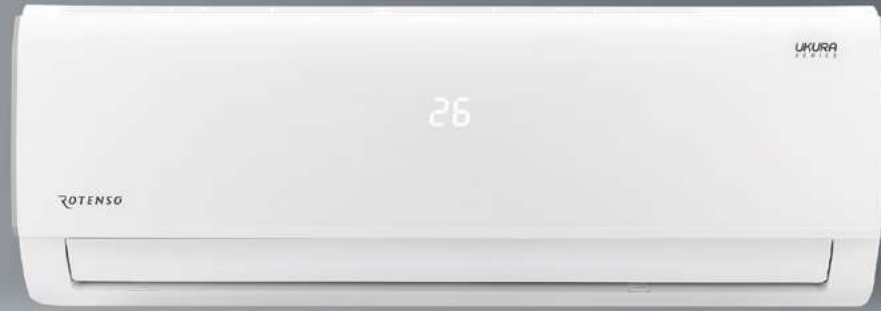

## Features device

116

- |   |   |                                      |                                    |  |                                  |  |                                |
|---|---|--------------------------------------|------------------------------------|--|----------------------------------|--|--------------------------------|
| <br><b>SKY inverter</b><br>Digital DC Inverter SKY® | <br>Automatic cleaning iAIR <sup>(1)</sup>                    | <br>Super Ionizer iAIR               | <br>Cold Nano iAIR filter          | <br>Antibacterial HEPA iAIR filter             | <br>Electrostatic HD iAIR filter | <br>Super Silent eMOTO mode <sup>(1)</sup> | <br>Automatic 4D louvers       |
| <br>Turbo eMOTO mode <sup>(1)</sup>                 | <br>Air supply control system eMOTO                           | <br>Wide angle eMOTO air supply      | <br>SMART Wi-Fi                    | <br>SMART port wired controller <sup>(2)</sup> | <br>Smart panel display ON/OFF   | <br>SMART Follow mode                      | <br>Wireless remote controller |
| <br>Wired controller <sup>(2)</sup>                 | <br>SMART heating to 8°C <sup>(1)</sup>                       | <br>Louvre setting memory            | <br>1W standby mode <sup>(1)</sup> | <br>Auto restart memory                        | <br>Anti-corrosive gold fins     | <br>Silence mode                           | <br>Timer                      |
| <br>Cooling at low outdoor temp. down to -15°C      | <br>Heating at low outdoor temp. down to -20°C <sup>(1)</sup> | <br>Double-sided condensate drainage | <br>Self-diagnostics               | <br>Sleep mode                                 |                                  |  |                                |

1. Feature not available in Multi Split system. 2. Feature is only optional.

Model				Ukura 2,1 kW	Ukura 2,6 kW	Ukura 3,5 kW	Ukura 5,3 kW	Ukura 7,0 kW
Capacity	Cooling	Nom. (Min. - Max.)	W	2051	2638 (909-3400)	3517 (1114-3927)	5275 (1817-6154)	7034 (2081-7913)
Rated input		Nom. (Min. - Max.)	W	-	800 (100-1240)	1320 (83-1600)	1550 (140-2300)	2600 (420-3150)
Operating current		Nom. (Min. - Max.)	A	-	3,5 (0,4-5,4)	5,7 (0,4-7)	6,7 (0,6-10)	11,3 (1,8-13,7)
Capacity	Heating	Nom. (Min. - Max.)	W	2345	2931 (821-3370)	3810 (1084-4162)	5568 (1290-6741)	7327 (1612-7913)
Rated input		Nom. (Min. - Max.)	W	-	930 (120-1200)	1190 (167-1400)	1570 (220-2350)	2400 (300-2750)
Operating current		Nom. (Min. - Max.)	A	-	4,0 (0,5-5,2)	5,2 (0,7-6,1)	6,8 (1,0-10,2)	10,4 (1,3-12,0)
Reversible heat pump type				air-to-air	air-to-air	air-to-air	air-to-air	air-to-air
Design load in cooling mode			kW	-	2,6	3,5	5,2	7,0
SEER			W/W	-	7,0	6,5	7,2	6,1
Energy efficiency class - cooling				-	A++	A++	A++	A++
Annual electric energy consumption - cooling			kWh/a	-	130	188	253	402
Design load in heating mode (T <sub>biv</sub> -7°C)			kW	-	2,3	2,8	4,1	4,8
SCOP			W/W	-	4,1	4,1	4,0	4,0
Energy efficiency class - heating				-	A+	A+	A+	A+
Annual electric energy consumption - heating			kWh/a	-	788	958	1436	1682
Dehumidification			l/h	-	1,0	1,2	1,8	2,4
Maximum energy consumption			W	-	2150	2150	2500	3500
Maximum operating current			A	-	9,3	9,3	10,9	15,2
Indoor unit				U21Xi	U26Xi	U35Xi	U50Xi	U70Xi
EAN product code				5905567613807	5905567606304	5905567606335	5905567606366	5905567606397
Fan speed	H / M / L / S	rpm	1100 / 900 / 750 / 590	1100 / 900 / 750 / 590	1130 / 950 / 750 / 590	1130 / 900 / 800 / 710	1130 / 900 / 800 / 710	
Air flow	H / M / L / S	m <sup>3</sup> /h	435 / 389 / 333 / 259	435 / 389 / 333 / 259	530 / 480 / 430 / 310	840 / 760 / 680 / 540	980 / 899 / 817 / 662	
Sound pressure level	H / M / L / S	dB(A)	37 / 32 / 25 / 21,5	37 / 32 / 25 / 21,5	39,5 / 35,5 / 25 / 21,5	42,5 / 36 / 26 / 20	45 / 40,5 / 36 / 29,5	
Sound power level		dB(A)	53	53	54	56	60	
Rated input		W	30	30	30	31	42	
Operating current		A	0,2	0,2	0,2	0,2	0,3	
Net dimensions	W × D × H	mm	715 × 194 × 285	715 × 194 × 285	805 × 194 × 285	957 × 213 × 302	1040 × 220 × 327	
Gross dimensions	W × D × H	mm	780 × 270 × 365	780 × 270 × 365	870 × 270 × 365	1035 × 295 × 385	1120 × 405 × 315	
Net weight / Gross weight		kg	6,7 / 8,8	6,7 / 8,8	7,6 / 9,8	10 / 13	12,3 / 15,8	
Condensate drain		mm	16	16	16	16	16	
Outdoor unit				-	U26Xo	U35Xo	U50Xo	U70Xo
EAN product code				-	5905567606311	5905567606342	5905567606373	5905567606403
Fan speed	H / M / L	rpm	-	780 / 700 / 600	780 / 700 / 600	740 / 700 / 650	830 / 700 / 550	
Maximum air flow		m <sup>3</sup> /h	-	1750	1750	2100	3500	
Sound pressure level		dB(A)	-	55	55	56	59	
Sound power level		dB(A)	-	62	64	64	67	
Net dimensions	W × D × H	mm	-	720 × 270 × 495	720 × 270 × 495	805 × 330 × 554	890 × 342 × 673	
Gross dimensions	W × D × H	mm	-	835 × 300 × 540	835 × 300 × 540	915 × 370 × 615	995 × 398 × 740	
Bracket spacing	W × D	(mm)	-	452 × 255	452 × 255	511 × 317	663 × 348	
Net weight / Gross weight		kg	-	21 / 22,8	23,2 / 25,0	32,7 / 35,4	42,9 / 45,9	
Refrigerant	Type		-	R32	R32	R32	R32	
	GWP*		-	675	675	675	675	
	Charged (≤ 5m)	kg	-	0,47	0,52	1,08	1,42	
		TCO <sub>2</sub> eq	-	0,317	0,351	0,729	0,958	
Charged (> 5m)	g/m	-	12	12	12	24		
Pipe connections	Liquid / Gas	mm (inch)	Φ6,35 / Φ9,52 (1/4" / 3/8")	Φ6,35 / Φ9,52 (1/4" / 3/8")	Φ6,35 / Φ9,52 (1/4" / 3/8")	Φ6,35 / Φ12,7 (1/4" / 1/2")	Φ9,52 / Φ15,9 (3/8" / 5/8")	
Maximum installation length		m	-	25	25	30	50	
Maximum height difference		m	-	10	10	20	25	
Compressor type			-	Rotary DC	Rotary DC	Rotary DC	Rotary DC	
Type of outdoor unit power supply	V-Hz, Ø		220-240-50, 1f	220-240-50, 1f	220-240-50, 1f	220-240-50, 1f	220-240-50, 1f	
Current protection	A		-	B10	B10	B16	B20	
Power cables: outdoor unit	L < 20 m	pcs × mm <sup>2</sup>	Data in HIRO	3 × 1,5	3 × 1,5	3 × 1,5	3 × 2,5	
Control and power cables: indoor unit - outdoor unit		pcs × mm <sup>2</sup>	-	5 × 1,5	5 × 1,5	5 × 1,5	5 × 2,5	
Control and power cables: hiro unit - indoor unit		pcs × mm <sup>2</sup>	4 × 1,5	4 × 1,5	4 × 1,5	4 × 1,5	4 × 1,5	
Indoor operating range (cooling / heating)		°C	17~32 / 0~30	17~32 / 0~30	17~32 / 0~30	17~32 / 0~30	17~32 / 0~30	
Outdoor operating range (cooling / heating)		°C	-	-15~50 / -20~30	-15~50 / -20~30	-15~50 / -20~30	-15~50 / -20~30	
Compatible systems								
1:1 SINGLE					•	•	•	•
1:2 DUAL								
1:X MULTI S-LINE				•	•	•	•	•
1:X MULTI N-LINE								
1:X MULTI HP-LINE				•	•	•	•	•

H - High; M - Medium; L - Low; S - Silent

For U70Xi unit with Ø9.52 (3/8") and Ø15.9 (5/8") connections in MULTI systems, reduction at outdoor unit to Ø6.35 (1/4") and Ø12.7 (1/2") necessary.



## Wall-mounted air conditioner **Roni**

**It has everything you need to enjoy the comfort of staying in an air-conditioned interior.**

118

This is a classic and bestseller in Rotenso's offer. Its advantage is a small size that allows discreet installation, especially when limited space is available. Optimal parameters and a package of necessary functions make the Roni air conditioner an excellent choice.

Automatic cleaning iAIR function prevents the multiplication of bacteria and the formation of unpleasant odors.

Electrostatic HD iAIR filter purifies the air in the room, effectively improving breathing comfort.



klimaakcia

[www.klimaakcia.sk](http://www.klimaakcia.sk)

10 STAGES OF AIR  
PureR Stage PURIFICATION



### Compact dimensions

It will work perfectly wherever space is limited. The device, despite its compact design, maintains high capacity.



### 10 stages of PureR Stage purification

The healthy air system consists of up to 10 stages of air purification and filtration to remove most of the harmful bacteria, viruses, dust mites and fungi from your environment so you can breathe clean and healthy air.



### Antibacterial gold-plated fins

The unique gold coating on the Outdoor unit and Indoor unit has self-cleaning properties, so it effectively protects the unit from corrosion and prevents the proliferation of bacteria.



### Automatic 4D louvres

Built-in actuators allow you to control the operation of vertical and horizontal louvre with a remote control or wall-mounted controller. Guarantees it the highest level of operating comfort and ensures efficient air distribution in the room.



### Function SMART Wi-Fi

Thanks to the use of SMART Wi-Fi function and Wi-Fi modem, you can control the unit using a tablet or smartphone both inside and outside the home.



### Heating even at -20°C

The inverter technology used enables efficient operation of the air conditioner even at low outside temperatures. Ukura will effectively heat a room even at -20°C.

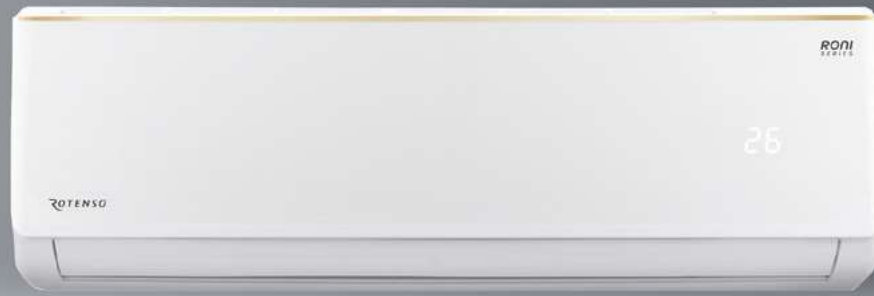

## Features device

120



Digital DC Inverter SKY®



Automatic cleaning iAIR



Automatic purification iClean (1)



3-in-1 filter (Ca + Si.Ion + vit.C) iAIR (1)



3-in-1 filter (Photo. + Ac.C + Nano) iAIR (\*\*)



Electrostatic HD iAIR filter



Super Silent eMOTO mode



Automatic 4D louvres



Turbo eMOTO mode



Air supply control system eMOTO



ECO eMOTO mode



Wide angle eMOTO air supply



SMART Wi-Fi



Smart panel display ON/OFF



SMART Follow mode (1)



Wireless remote controller



SMART heating to 8°C (1)



Auto restart memory



Anti-corrosive gold fins



Timer



Cooling at low outdoor temp. down to -15°C



Heating at low outdoor temp. down to -20°C



Double-sided condensate drainage



Self-diagnostics



Sleep mode

1. Function not available in the Multi Split system.

\* 3-in-1 iAIR filter: Catechin + Silver Ion + Vitamin C

\*\* 3-in-1 iAIR filter: Photocatalytic + Activated carbon + Cold Nano

Model				Roni 2,6 kW	Roni 3,5 kW	Roni 5,1 kW	Roni 7,0 kW
Capacity	Cooling	Nom. (Min. - Max.)	W	2600 (940-3300)	3502 (1000-3770)	5140 (1250-5910)	7040 (1500-7800)
Rated input		Nom. (Min. - Max.)	W	851 (240-1380)	1130 (290-1500)	1567 (330-2350)	2166 (390-2800)
Operating current		Nom. (Min. - Max.)	A	3,7 (1-6,0)	4,9 (1,3-6,5)	6,8 (1,4-10,2)	9,4 (1,7-12,2)
Capacity	Heating	Nom. (Min. - Max.)	W	2680 (940-3200)	3517 (1000-3810)	5210 (1250-6070)	7200 (1500-7900)
Rated input		Nom. (Min. - Max.)	W	786 (240-1552)	1005 (290-1720)	1376 (340-2550)	2112 (390-3000)
Operating current		Nom. (Min. - Max.)	A	3,4 (1-6,7)	4,4 (1,3-7,5)	6,0 (1,5-11,1)	9,2 (1,7-13,0)
Reversible heat pump type				air-to-air	air-to-air	air-to-air	air-to-air
Design load in cooling mode			kW	2,6	3,4	5,1	7,0
SEER			W/W	6,1	6,1	6,5	6,5
Energy efficiency class - cooling				A++	A++	A++	A++
Annual electric energy consumption - cooling			kWh/a	150	196	275	377
Design load in heating mode (T <sub>biv</sub> -7°C)			kW	2,0	2,2	3,9	4,9
SCOP			W/W	4,0	4,0	4,0	4,0
Energy efficiency class - heating				A+	A+	A+	A+
Annual electric energy consumption - heating			kWh/a	700	770	1365	1715
Dehumidification			l/h	1,0	1,2	1,5	1,8
Maximum energy consumption			W	1552	1720	2550	3000
Maximum operating current			A	6,7	7,5	11,1	13,0
Indoor unit				R26Xi	R35Xi	R50Xi	R70Xi
EAN product code				5905567614408	5905567614439	5905567614453	5905567614477
Fan speed		T / H / M / L / S	rpm	1400 / 1300 / 1100 / 1050 / 900	1400 / 1320 / 1150 / 1050 / 850	1400 / 1260 / 1150 / 960 / 800	1270 / 1200 / 1100 / 920 / 700
Air flow		T / H / M / L / S	m <sup>3</sup> /h	420 / 390 / 330 / 320 / 270	570 / 530 / 460 / 430 / 360	800 / 760 / 690 / 580 / 440	1000 / 950 / 870 / 720 / 590
Sound pressure level		T / H / M / L / S	dB(A)	42 / 37 / 33 / 25 / 22	43 / 38 / 35 / 27 / 22	45 / 40 / 37 / 34 / 27	46 / 41 / 39 / 36 / 30
Sound power level			dB(A)	52	53	56	58
Rated input			W	30	35	52	65
Operating current			A	0,1	0,2	0,2	0,3
Net dimensions		W × D × H	mm	698 × 205 × 255	777 × 205 × 250	910 × 205 × 292	1010 × 220 × 315
Gross dimensions		W × D × H	mm	765 × 260 × 335	850 × 275 × 320	977 × 276 × 367	1094 × 300 × 386
Net weight / Gross weight			kg	6,5 / 8,5	7 / 9	9,5 / 11,5	12 / 14
Condensate drain			mm	16	16	16	16
Outdoor unit				R26Xo	R35Xo	R50Xo	R70Xo
EAN product code				5905567614422	5905567614446	5905567614460	5905567614484
Fan speed		T / H / M / L / S	rpm	930 / 930 / 830 / 730 / 630	1000 / 910 / 830 / 710 / 710	910 / 830 / 710 / 630 / 450	930 / 830 / 690 / 570 / 450
Maximum air flow			m <sup>3</sup> /h	1700	1700	2600	3000
Sound pressure level			dB(A)	52	54	55	57
Sound power level			dB(A)	62	62	65	67
Net dimensions		W × D × H	mm	740 × 253 × 459	740 × 253 × 459	794 × 347 × 602	845 × 336 × 693
Gross dimensions		W × D × H	mm	765 × 310 × 481	765 × 310 × 481	895 × 385 × 645	960 × 400 × 732
Bracket spacing		W × D	(mm)	362 × 256	362 × 256	516 × 314	586 × 347
Net weight / Gross weight			kg	19 / 21	20 / 22	30 / 32,5	40,5 / 42
Refrigerant		Type		R32	R32	R32	R32
		GWP		675	675	675	675
		Charged (≤ 5m)	kg	0,49	0,52	0,96	1,14
			TCO <sub>2eq</sub>	0,33	0,35	0,65	0,77
Charged (> 5m)		g/m	12	12	12	12	
Pipe connections		Liquid / Gas	mm (inch)	Φ6,35 / Φ9,52 (1/4" / 3/8")	Φ6,35 / Φ9,52 (1/4" / 3/8")	Φ6,35 / Φ9,52 (1/4" / 3/8")	Φ6,35 / Φ12,7 (1/4" / 1/2")
Maximum installation length			m	25	25	25	25
Maximum height difference			m	10	10	10	10
Compressor type				Rotary DC	Rotary DC	Rotary DC	Rotary DC
Power cables: outdoor unit		L < 20 m	V-Hz, Ø	220-240-50, 1f	220-240-50, 1f	220-240-50, 1f	220-240-50, 1f
Current protection			A	B10	B10	B16	B20
Power cables: outdoor unit			pcs × mm <sup>2</sup>	3 × 1,5	3 × 1,5	3 × 2,5	3 × 2,5
Control and power cables: indoor unit - outdoor unit			pcs × mm <sup>2</sup>	4 × 1	4 × 1	4 × 1	4 × 1
Control and power cables: hiro unit - indoor unit			pcs × mm <sup>2</sup>	4 × 1	4 × 1	4 × 1	-
Indoor operating range (cooling / heating)			°C	16-32 / 0-30	16-32 / 0-30	16-32 / 0-30	16-32 / 0-30
Outdoor operating range (cooling / heating)			°C	-15-53 / -20-30	-15-53 / -20-30	-15-53 / -20-30	-15-53 / -20-30
Compatible systems							
1:1 SINGLE				•	•	•	•
1:2 DUAL							
1:X MULTI S-LINE							
1:X MULTI N-LINE				•	•	•	•
1:X MULTI HP-LINE							

T - Turbo; H - High; M - Medium; L - Low; ML - Medium Low; S - Silent



## Air conditioner consoley **Aneru HP**

122

**Aneru HP is an extremely high capacity High Performance unit.**

Rotenso Aneru HP is a console air conditioner, which, thanks to its double-sided top and bottom air supply, allows installation near the floor.

It is used in rooms with specific limitations, such as a large number of bevels and low knee walls, for example, in attics. The ability to mount the air conditioner at the floor also makes it a solution to avoid exposure of the unit under the ceiling.

The High Performance technology used allows the air conditioner to work efficiently even in extreme weather conditions. This means that the air conditioner will effectively heat the room at low outdoor temperatures as low as  $-30^{\circ}\text{C}$ .

The Aneru HP Console air conditioner also allows cooling in extreme temperatures of  $-25^{\circ}\text{C}$ . This makes it possible, for example, to protect electronic equipment from overheating in rooms that are much warmer than the rest of the building.

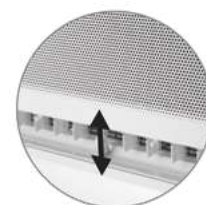
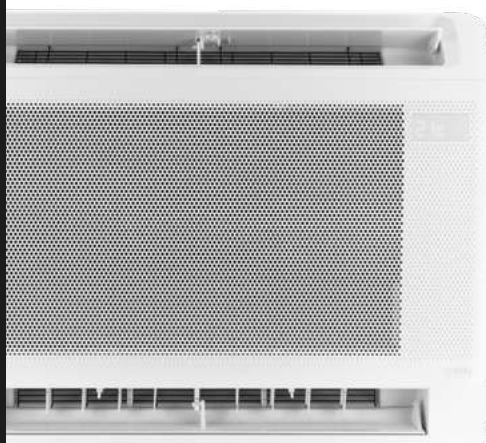

INDIVIDUAL LOUVRE CONTROL





## Super Ionizer **iAIR**

By creating negative oxygen ions, Super Ionizer iAIR eliminates viruses, bacteria, dust mites and allergens from the air. Unpleasant odors are removed immediately after the ionizer contacts with the contaminated air.



## Extremely **high performance**

The High Performance line technology used allows the air conditioner to work efficiently even in extreme weather conditions.



## Function **SMART Wi-Fi**

Utilizing SMART Wi-Fi and Wi-Fi modem, you can control the unit with a tablet or smartphone both inside and outside the home.



## Individual **louvre control**

Console unit allows precise control of the air direction depending on the selected mode of operation - top or bottom supply.



## Double-sided **air supply**

Air supply from two sides improves the effect-heating efficiency of the room. In addition to the standard louvre, in addition, there is a second air outlet at the bottom of the unit. The ability to control the top-down air supply independently allows the user to heat the room efficiently.



## Heating **even at -30°C**

The applied compressor technology, EXV valve and year-round operation package guarantee unprecedented efficiency of the air conditioner in heating mode, even in extreme weather conditions. In addition to the function of air conditioning the room, this year-round device can work as the only source of heat in a house, apartment or office.

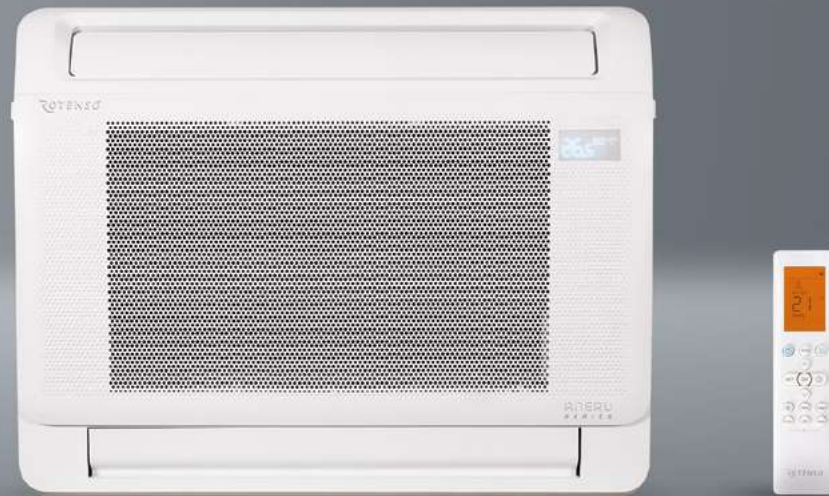
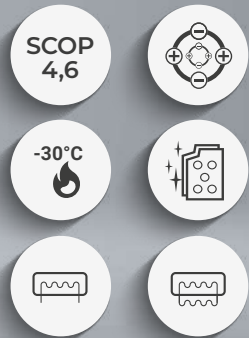

## Features device

 Digital DC Inverter SKY®	 Automatic purification iClean	 Electrostatic HD iAIR filter	 Super Ionizer iAIR	 Super Silent eMOTO mode	 Wide angle eMOTO air supply	 Turbo eMOTO mode	 Air supply eMOTO control system
 ECO eMOTO mode	 SMART Wi-Fi	 Humidity sensor <sup>(2)</sup>	 SMART port wired controller <sup>(1)</sup>	 Smart panel display ON/OFF	 Wireless remote controller	 Wired controller <sup>(1)</sup>	 SMART Follow filter
 SMART heating to 8°C	 Louvre setting memory	 Auto restart memory	 Anti-corrosive gold fins	 Drip tray heater	 Compressor crankcase heater	 Silence mode	 Timer
 Cooling at low outdoor temp. down to -25°C	 Heating at low outdoor temp. down to -30°C	 1-sided drain condensate	 Self-diagnostics	 Automatic louvre	 Sleep mode	 ON/OFF remote output <sup>(1)</sup>	 Alarm output <sup>(1)</sup>
 Weekly controller output <sup>(1)</sup>	 Central controller outdoor <sup>(1)</sup>	 Double-sided air supply	 Individual louvre control	 BMS Modbus <sup>(1)</sup>	 BMS Bacnet <sup>(1)</sup>		

1. Feature is only optional.

2. Feature can be accessed via mobile app.

Model				Aneru HP 2,6 kW	Aneru HP 3,5 kW
Capacity	Cooling	Nom. (Min. - Max.)	W	2638 (674-3956)	3517 (762-4982)
Rated input		Nom. (Min. - Max.)	W	570 (150-1250)	840 (170-1600)
Operating current		Nom. (Min. - Max.)	A	2,5 (0,7-5,4)	3,7 (0,7-7,0)
Capacity	Heating	Nom. (Min. - Max.)	W	3810 (410-5510)	4982 (454-6448)
Rated input		Nom. (Min. - Max.)	W	860 (130-1600)	1240 (150-1950)
Operating current		Nom. (Min. - Max.)	A	3,7 (0,6-7,0)	5,4 (0,7-8,5)
Reversible heat pump type				air-to-air	air-to-air
Design load in cooling mode			kW	2,6	3,6
SEER			W/W	8,5	8,5
Energy efficiency class - cooling				A+++	A+++
Annual electric energy consumption - cooling			kWh/a	107	148
Design load in heating mode (T <sub>biv</sub> -7°C)			kW	2,8	3,6
SCOP			W/W	4,6	4,6
Energy efficiency class - heating				A++	A++
Annual electric energy consumption - heating			kWh/a	854	1107
Dehumidification			l/h	1,2	1,8
Maximum energy consumption			W	2300	2800
Maximum operating current			A	10,0	12,2
Indoor unit				AHP26Xi	AHP35Xi
EAN product code				5905567606021	5905567606045
Fan speed	T / H / M / L		rpm	912 / 824 / 736 / 634	992 / 884 / 776 / 650
Air flow	T / H / M / L		m <sup>3</sup> /h	600 / 510 / 400 / 368	650 / 580 / 490 / 420
Sound pressure level	T / H / M / L		dB(A)	39,5 / 36 / 31 / 25 / 20	40 / 37,5 / 31,5 / 25 / 20
Sound power level			dB(A)	56	56
Rated input			W	42	42
Operating current			A	0,2	0,2
Net dimensions		W × D × H	mm	794 × 206 × 621	794 × 206 × 621
Gross dimensions		W × D × H	mm	865 × 280 × 719	865 × 280 × 719
Net weight / Gross weight			kg	14,9 / 18,8	14,9 / 18,8
Condensate drain			mm	16	16
Outdoor unit				AHP26Xo	AHP35Xo
EAN product code				5905567606038	5905567606052
Fan speed	H / M / L		rpm	790 / 690 / 600	700 / 610 / 530
Maximum air flow			m <sup>3</sup> /h	2150	3500
Sound pressure level			dB(A)	54	56
Sound power level			dB(A)	62	63
Net dimensions		W × D × H	mm	765 × 303 × 555	890 × 342 × 673
Gross dimensions		W × D × H	mm	887 × 337 × 610	995 × 398 × 740
Bracket spacing		W × D	(mm)	452 × 286	663 × 348
Net weight / Gross weight			kg	28,7 / 31,2	39,8 / 43
Refrigerant	Type			R32	R32
	GWP			675	675
	Charged (≤ 5m)	kg		0,75	1,15
		TCO <sub>2</sub> eq		0,506	0,78
Charged (> 5m)		g/m		12	12
Pipe connections		Liquid / Gas	mm (inch)	Φ6,35 / Φ9,52 (1/4" / 3/8")	Φ6,35 / Φ9,52 (1/4" / 3/8")
Maximum installation length			m	25	25
Maximum height difference			m	10	10
Compressor type				Rotary DC	Rotary DC
Type of outdoor unit power supply			V-Hz, Ø	220-240-50, 1f	220-240-50, 1f
Current protection			A	B10	B16
Power cables: outdoor unit		L < 20 m	pcs × mm <sup>2</sup>	3 × 1,5	3 × 1,5
Control and power cables: indoor unit - outdoor unit			pcs × mm <sup>2</sup>	4 × 1	4 × 1
Indoor operating range (cooling / heating)			°C	16-32 / 0-30	16-32 / 0-30
Outdoor operating range (cooling / heating)			°C	-25-50 / -30-24	-25-50 / -30-24
Compatible systems					
1:1 SINGLE				•	•
1:2 DUAL					
1:X MULTI S-LINE					
1:X MULTI N-LINE					
1:X MULTI HP-LINE					

T - Turbo ; W - High; M - Middle; N - Low;



## Air conditioner console **Aneru**

126

**Aesthetically pleasing matte front panel finish, unique design and the ability to independently control two-way up and down airflow are the advantages of the Console air conditioner Aneru designed for spaces requiring customized solutions.**

Rotenso Aneru is a Console air conditioner, which, thanks to its two-sided up and down air supply, allows for installation near the floor. It is used in rooms with specific limitations, such as a large number of bevels and low knee walls, for example, in attics.

The ability to mount the air conditioner near the floor also makes Aneru a popular choice for customers who want to avoid exposing the unit to the ceiling.

Rotenso Aneru is equipped with a year-round operation package, i.e. drip tray heater and Compressor crankcase heater.

The air conditioner has excellent capacity in both Cooling and Heating modes. Double-sided top and bottom air supply allows independent control of air ejection from the top or bottom of the unit, so it can be successfully operated as an independent heating source.

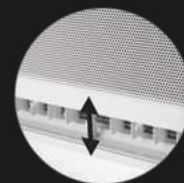
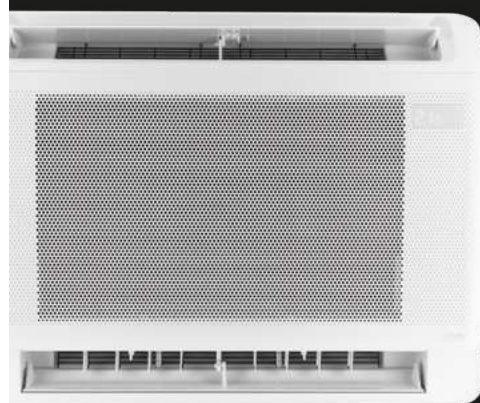

INDIVIDUAL  
LOUVRE CONTROL



DOUBLE-SIDED  
AIR SUPPLY



### Individual **louvre control**

Console unit allows precise control of the direction depending on the selected mode of operation - top or bottom supply.



### Double-sided **air supply**

Air supply from two sides improves the effect-heating efficiency of the room. In addition to the standard louvre, in addition, there is a second outlet at the bottom of the unit. The ability to control the top-down air supply independently allows the user to heat the room efficiently.



### Function **SMART Wi-Fi**

Utilizing SMART Wi-Fi and Wi-Fi modem, you can control the unit with a tablet or smartphone both inside and outside the home.



### Built-in **humidity sensor**

Humidity sensor allows the user to real-time monitoring of the humidity level in the room via the app for ultimate comfort.



### Super Ionizer **iAIR**

By creating negative oxygen ions, Super Ionizer iAIR eliminates viruses, bacteria, dust mites and allergens from the air. Unpleasant odors are removed immediately after the ionizer contacts with the contaminated air.



### Heating **at down to -20°C**

The technology used and the built-in year-round operation package enable efficient operation of the air conditioner even in extreme weather conditions. The air conditioner will effectively heat the room even at low outdoor temperatures.

# Cooling in summer

128



## Mode **cooling**

---

In Cooling mode, the overhead fan throws cool air upward. The cooled, heavier air falls naturally downward and cools the entire area evenly, bringing relief to the occupants.

# Heating in winter



## Mode **heating**

---

In heating mode, the top fan and bottom fan distribute warm air through both louvres. The bottom fan is designed to push the cooler, heavier air upward and warm the floor for ultimate comfort. The warmer, lighter air rises naturally upward in the room toward the ceiling, evenly warming the entire area.



S-LINE

HP-LINE

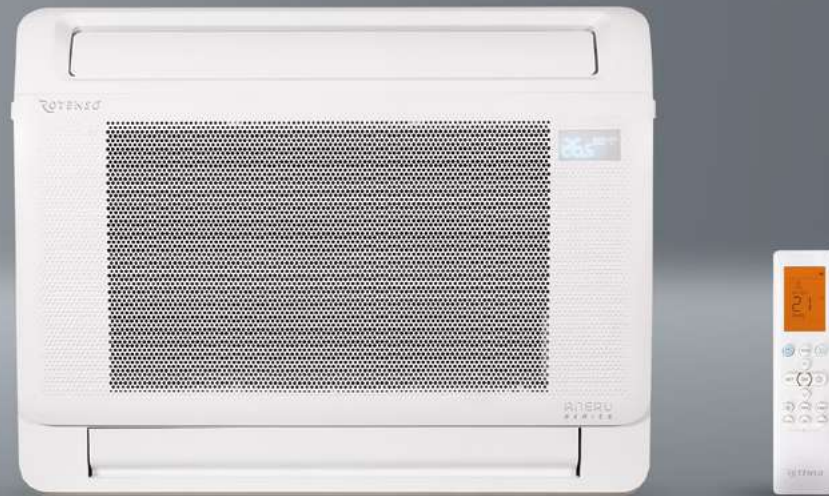

## Features device

130

 Digital DC Inverter SKY®	 Automatic purification iClean <sup>(1)</sup>	 Electrostatic HD iAIR filter	 Super Ionizer iAIR	 Super Silent eMOTO mode <sup>(1)</sup>	 Wide angle eMOTO air supply	 Turbo eMOTO mode <sup>(1)</sup>	 Air supply eMOTO control system
 ECO eMOTO mode <sup>(1)</sup>	 SMART Wi-Fi	 Humidity sensor <sup>(1)(2)</sup>	 SMART port wired controller <sup>(2)</sup>	 Smart panel display ON/OFF	 Wireless remote controller	 Wired controller <sup>(2)</sup>	 SMART Follow mode
 SMART heating to 8°C <sup>(1)</sup>	 Louvre setting memory	 Auto restart memory	 Anti-corrosive gold fins	 Drip tray heater	 Compressor crankcase heater	 Silence mode	 Timer
 Cooling at low outdoor temp. down to -15°C	 Heating at low outdoor temp. down to -20°C <sup>(1)</sup>	 1-sided drain condensate	 Self-diagnostics	 Automatic louvre	 Sleep mode	 ON/OFF remote output <sup>(2)</sup>	 Output alarm <sup>(2)</sup>
 Weekly controller output <sup>(2)</sup>	 Central controller output <sup>(2)</sup>	 Double-sided air supply	 Individual louvre control	 BMS Modbus <sup>(2)</sup>	 BMS Bacnet <sup>(2)</sup>		

1. Feature not available in Multi Split system. 2. Feature is only optional. 3. Feature can be accessed via mobile app.

Model				Aneru 2,6 kW	Aneru 3,5 kW	Aneru 5,0 kW
Capacity	Cooling	Nom. (Min. - Max.)	W	2638 (762-4250)	3517 (762-4250)	4982 (2638-5568)
Rated input		Nom. (Min. - Max.)	W	660 (170-1350)	1000 (170-1350)	1500 (650-1950)
Operating current		Nom. (Min. - Max.)	A	2,9 (0,7-5,9)	4,3 (0,7-5,9)	6,5 (2,8-8,5)
Capacity	Heating	Nom. (Min. - Max.)	W	2931 (454-4689)	3810 (454-4689)	5275 (2198-6301)
Rated input		Nom. (Min. - Max.)	W	700 (150-1300)	980 (150-1300)	1420 (600-1900)
Operating current		Nom. (Min. - Max.)	A	3,0 (0,6-5,7)	4,3 (0,7-5,7)	6,2 (2,6-8,3)
Reversible heat pump type				air-to-air	air-to-air	air-to-air
Design load in cooling mode			kW	2,6	3,5	5,0
SEER			W/W	7,4	7,3	6,7
Energy efficiency class - cooling				A++	A++	A++
Annual electric energy consumption - cooling			kWh/a	123	168	261
Design load in heating mode (T <sub>biv</sub> -7°C)			kW	2,2	2,6	4,0
SCOP			W/W	4,2	4,0	4,0
Energy efficiency class - heating				A+	A+	A+
Annual electric energy consumption - heating			kWh/a	734	910	1450
Dehumidification			l/h	1,0	1,2	1,8
Maximum energy consumption			W	1850	1850	2950
Maximum operating current			A	8,0	8,0	12,8
Indoor unit				A26Xi	A35Xi	A50Xi
EAN product code				5905567606007	5905567601972	5905567601996
Fan speed	T / H / M / L	rpm	992 / 884 / 776 / 650	992 / 884 / 776 / 650	1100 / 1000 / 900 / 800	
Air flow	T / H / M / L	m³/h	650 / 580 / 490 / 420	650 / 580 / 490 / 420	780 / 690 / 600 / 450	
Sound pressure level	T / H / M / L	dB(A)	35 / 32 / 25 / 20	36 / 33 / 25 / 20	39 / 36 / 30 / 21	
Sound power level		dB(A)	53	55	56	
Rated input		W	42	42	52	
Operating current		A	0,2	0,2	0,2	
Net dimensions		W × D × H	mm	794 × 206 × 621	794 × 206 × 621	794 × 206 × 621
Gross dimensions		W × D × H	mm	865 × 280 × 719	865 × 280 × 719	865 × 280 × 719
Net weight / Gross weight		kg	14,9 / 18,8	14,9 / 18,8	14,9 / 18,8	
Condensate drain		mm	16	16	16	
Outdoor unit				A26Xo	A35Xo	A50Xo
EAN product code				5905567606014	5905567601989	5905567602009
Fan speed	H / M / L	rpm	760 / 580 / 500	780 / 600 / 500	790 / 650 / 550	
Maximum air flow		m³/h	2160	2200	2400	
Sound pressure level		dB(A)	53	54	55	
Sound power level		dB(A)	63	63	64	
Net dimensions		W × D × H	mm	765 × 303 × 555	765 × 303 × 555	805 × 330 × 554
Gross dimensions		W × D × H	mm	887 × 337 × 610	887 × 337 × 610	915 × 370 × 615
Bracket spacing		W × D	(mm)	452 × 286	452 × 286	511 × 317
Net weight / Gross weight		kg	24,6 / 27,0	26,6 / 29,0	32,5 / 35,2	
Refrigerant	Type		R32	R32	R32	
	GWP		675	675	675	
	Charged (≤ 5m)	kg	0,71	0,71	1,15	
		TCO <sub>2</sub> eq	0,48	0,48	0,78	
Charged (> 5m)		g/m	12	12	12	
Pipe connections		Liquid / Gas	mm (inch)	Φ6,35 / Φ9,52 (1/4" / 3/8")	Φ6,35 / Φ12,7 (1/4" / 1/2")	
Maximum installation length		m	25	25	30	
Maximum height difference		m	10	10	20	
Compressor type				Rotary DC	Rotary DC	Rotary DC
Type of outdoor unit power supply		V-Hz, Ø	220-240-50, 1f	220-240-50, 1f	220-240-50, 1f	
Current protection		A	B10	B10	B16	
Power cables: outdoor unit		L < 20 m	pcs × mm²	3 × 1,5	3 × 1,5	
Control and power cables: indoor unit - outdoor unit		pcs × mm²	4 × 1	4 × 1	4 × 1	
Indoor operating range (cooling / heating)		°C	16-32 / 0-30	16-32 / 0-30	16-32 / 0-30	
Outdoor operating range (cooling / heating)		°C	-15-50 / -20-24	-15-50 / -20-24	-15-50 / -20-24	
Compatible systems						
1:1 SINGLE				•	•	•
1:2 DUAL						
1:X MULTI S-LINE				•	•	•
1:X MULTI N-LINE				•	•	•
1:X MULTI HP-LINE				•	•	•

T - Turbo ; W - High; M - Middle; N - Low;



## Air conditioner console

# Aneru AN

132

**Aneru AN console air conditioner is an excellent solution for the attic and wherever you expect high efficiency and space management options are limited.**

The compact dimensions and, above all, the low height of Aneru AN (only 60 cm) allows you to use the air conditioner in almost any room with low knee walls (haunches), often found in attics.

With as many as 4 air inlets and 2 air vents, the air conditioner works efficiently in both Heating and Cooling modes, evenly distributing the air.

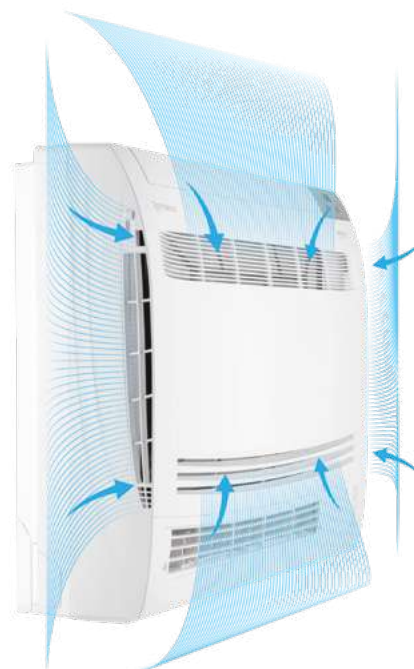

**4 AIR  
INLETS**

**DOUBLE-SIDED  
AIR SUPPLY**



**klimaakcia**  
[www.klimaakcia.sk](http://www.klimaakcia.sk)



## Compact dimensions

Aneru AN console air conditioner does not require much space for installation. Its dimensions are 700 x 215 x 600 mm. This allows installation even at very low walls that is, "bevels" in attics.



## Double-sided air supply

The two-sided air supply used in Aneru AN improves the heating and cooling efficiency of the room. In addition to the standard top louvre, there is also a second air outlet at the bottom of the unit.



## Function SMART Wi-Fi

By using SMART Wi-Fi and a Wi-Fi modem, you can control the unit, using a tablet or smartphone both inside and outside the home.



## 4 air inlets

The four inlets used allow air to flow freely into the device. This allows the air conditioner to work efficiently.



## Heating even at -20°C

The technology used and the built-in year-round operation package enable efficient operation of the air conditioner even in extreme weather conditions. The air conditioner will effectively heat the room even at low outdoor temperatures.



## Winter package

Reliability of the heating function of Rotenso air conditioners is ensured by an efficient compressor, built-in drip tray heater as standard and compressor winding heating, which make up the so-called year-round operation package.

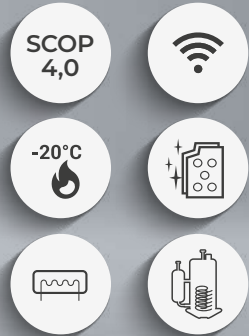

## Features device

134



Digital DC Inverter SKY®



Automatic cleaning iAIR



Electrostatic HD iAIR filter



Super Silent eMOTO mode



Wide angle eMOTO air supply



Turbo eMOTO mode



Air supply eMOTO control system



Eco eMOTO mode



SMART Wi-Fi



Smart panel display ON/OFF



Wireless remote controller



SMART Follow mode <sup>(1)</sup>



Louvre setting memory



Auto restart memory



Anti-corrosive gold fins



Drip tray heater



Compressor winding heating <sup>(1)</sup>



Timer



Cooling at low outdoor temp. down to -15°C



Heating at low outdoor temp. down to -20°C



1-sided drain condensate



Self-diagnostics



Automatic louvre



Double-sided air supply



Sleep mode

Model				Aneru 3,5 kW	Aneru 4,7 kW
Capacity	Cooling	Nom. (Min. - Max.)	W	3520 (600-4000)	4704 (620-5100)
Rated input		Nom. (Min. - Max.)	W	1052 (160-1660)	1480 (200-2150)
Operating current		Nom. (Min. - Max.)	A	4,6 (0,7-7,2)	6,4 (0,9-9,3)
Capacity	Heating	Nom. (Min. - Max.)	W	3558 (600-4100)	4704 (760-5320)
Rated input		Nom. (Min. - Max.)	W	899 (160-1660)	1390 (230-2150)
Operating current		Nom. (Min. - Max.)	A	3,9 (0,7-7,2)	6,0 (1,0-9,3)
Reversible heat pump type				air-to-air	air-to-air
Design load in cooling mode			kW	3,5	5,0
SEER			W/W	6,5	6,1
Energy efficiency class - cooling				A++	A++
Annual electric energy consumption - cooling			kWh/a	189	273
Design load in heating mode (T <sub>biv</sub> -7°C)			kW	2,3	3,9
SCOP			W/W	4,0	4,0
Energy efficiency class - heating				A+	A+
Annual electric energy consumption - heating			kWh/a	805	1365
Dehumidification			l/h	1,2	1,5
Maximum energy consumption			W	1660	2150
Maximum operating current			A	7,2	9,3
Indoor unit				AN35Xi	AN50Xi
EAN product code				5905567614491	5905567614507
Fan speed	T / H / M / L / S	rpm	670 / 630 / 570 / 510 / 480	880 / 800 / 700 / 620 / 550	
Air flow	T / H / M / L / S	m <sup>3</sup> /h	650 / 540 / 480 / 360	800 / 730 / 610 / 380	
Sound pressure level	T / H / M / L / S	dB(A)	42 / 38 / 32 / 24 / 23	46 / 43 / 38 / 30 / 24	
Sound power level		dB(A)	52	56	
Rated input		W	37	48	
Operating current		A	0,2	0,2	
Net dimensions		W × D × H	mm	700 × 215 × 600	
Gross dimensions		W × D × H	mm	775 × 280 × 725	
Net weight / Gross weight		kg	14,5 / 16,5	14,5 / 16,5	
Condensate drain		mm	16	16	
Outdoor unit				AN35Xo	AN50Xo
EAN product code				5905567614514	5905567614521
Fan speed	T / H / M / L / S	rpm	920 / 920 / 810 / 730 / 610	930 / 930 / 830 / 630 / 550	
Maximum air flow		m <sup>3</sup> /h	1900	2600	
Sound pressure level		dB(A)	52	55	
Sound power level		dB(A)	62	65	
Net dimensions		W × D × H	mm	777 × 291 × 498	
Gross dimensions		W × D × H	mm	818 × 325 × 520	
Bracket spacing		W × D	(mm)	415 × 225	
Net weight / Gross weight		kg	22 / 24	30 / 32,5	
Refrigerant	Type		R32	R32	
	GWP		675	675	
	Charged (≤ 5m)	kg	0,53	0,96	
		TCO <sub>2</sub> eq	0,358	0,648	
Charged (> 5m)		g/m	15	15	
Pipe connections		Liquid / Gas	mm (inch)	Φ6,35 / Φ9,52 (1/4" / 3/8")	
Maximum installation length		m	25	30	
Maximum height difference		m	10	20	
Compressor type				Rotary DC	Rotary DC
Type of outdoor unit power supply		V-Hz, Ø	220-240-50, 1f	220-240-50, 1f	
Current protection		A	B10	B16	
Power cables: outdoor unit		L < 20 m	pcs × mm <sup>2</sup>	3 × 1,5	
Control and power cables: indoor unit - outdoor unit		pcs × mm <sup>2</sup>	4 × 1	4 × 1	
Indoor operating range (cooling / heating)		°C	16-32 / 0-30	16-32 / 0-30	
Outdoor operating range (cooling / heating)		°C	-15-53 / -20-30	-15-53 / -20-30	
Compatible systems					
1:1 SINGLE				•	•
1:2 DUAL					
1:X MULTI S-LINE					
1:X MULTI N-LINE				•	•
1:X MULTI HP-LINE					

T - Turbo ; W - High; M - Middle; N - Low;



## Air conditioner cassette **Tenji**

136

**360° ventilation, advanced control features and the ability to mount the device discreetly are advantages that will make you like the new Tenji cassette.**

Tenji cassette air conditioner is widely used in commercial premises, offices, stores, doctors' offices, service outlets, etc. Increasingly, cassette units are also being installed in apartments and homes.

For the comfort of the room's occupants, the peripheral air supply (360°) directs the released air, evenly, in all directions - providing effective cooling or heating.





Tenji CS - 950 x 950 [mm]



Tenji CC - 620 x 620 [mm]



## Display **LCD**

Information about the temperature and enabled functions can be read directly from the aesthetically pleasing and easy-to-read display, built into the corner of the cassette.



## The supply of **fresh air**

Allows you to supply fresh air from outside to the air conditioner through an additional channel. This allows you to simultaneously cool and ventilate the room.



## Individual **louvres control**

Possibility of independent control of each from the four louvres allows you to optimally adjust the air flow according to the needs arising from the distribution of zones in the room and the activity of the occupants.



## Air supply **360°**

Thanks to the design of the air supply from four sides, Tenji air conditioner efficiently distributes air in the room, providing effective cooling or heating.



## Function **SMART Wi-Fi**

By using the SMART Wi-Fi smart control system, the operation of the air conditioner can be controlled by several users using a tablet or smartphone both from home and outside of it.



## Built-in **condensate pump**

The compact design of the improved unit has allowed the air conditioner to be equipped with a condensate pump with a head of up to 1000 mm. This improvement will save both space and money.

# Tenji CC [620 x 620]

## 2,1-5,3 kW



S-LINE  
HP-LINE



## Features device

138



Digital DC Inverter SKY<sup>®</sup>



Automatic purification iClean<sup>(1)</sup>



Electrostatic HD iAIR filter



Super Silent eMOTO mode<sup>(1)</sup>



Wide angle eMOTO air supply



Turbo eMOTO mode<sup>(1)</sup>



Air supply eMOTO control system



Eco eMOTO mode<sup>(1)</sup>



SMART Wi-Fi



Humidity sensor<sup>(1) (3)</sup>



SMART port wired controller



Smart panel display ON/OFF



Wireless remote controller



Wired controller<sup>(2)</sup>



SMART heating to 8°C<sup>(1)</sup>



SMART Follow mode



Louvre setting memory



Auto restart memory



Anti-corrosive gold fins



Drip tray heater



Compressor crankcase heater



Timer



Cooling at low outdoor temp. down to -15°C



Heating at low outdoor temp. down to -20°C<sup>(1)</sup>



Self-diagnostics



Sleep mode



Automatic 4D louvres



Integrated condensate pump



Fresh air supply<sup>(2)</sup>



ON/OFF remote output



Alarm output



Weekly controller output



Central controller output



360° air supply



Individual louvre control



Synchro-simultaneous operation<sup>(2)</sup>



BMS Modbus<sup>(2)</sup>



BMS Bacnet<sup>(2)</sup>

klimaakcia  
www.klimaakcia.sk

1. Feature not available in Multi Split system. 2. Feature is only optional. 3. Feature can be accessed via mobile app.



Rotenso participates in the EUROVENT programme.  
 Check ongoing validity of certificate:  
[www.eurovent-certification.com](http://www.eurovent-certification.com)

## Features device

Digital DC Inverter SKY <sup>®</sup>	Automatic purification iClean <sup>(1)</sup>	Electrostatic HD iAIR filter	Super Silent eMOTO mode <sup>(1)</sup>	Wide angle eMOTO air supply	Turbo eMOTO mode <sup>(1)</sup>	Air supply eMOTO control system	Eco eMOTO mode <sup>(1)</sup>
SMART Wi-Fi	Humidity sensor <sup>(1) (2)</sup>	SMART port wired controller	Smart panel display ON/OFF	Wireless remote controller	Wired controller <sup>(2)</sup>	SMART heating to 8°C <sup>(1)</sup>	SMART Follow filter
Louvre setting memory	Auto restart memory	Anti-corrosive gold fins	Drip tray heater	Compressor crankcase heater	Timer	Cooling at low outdoor temp. down to -15°C	Heating at low outdoor temp. down to -20°C <sup>(1)</sup>
Self-diagnostics	Sleep mode	Automatic 4D louvres	Integrated condensate pump	Fresh air supply <sup>(2)</sup>	ON/OFF remote output	Alarm output	Weekly controller output
Central controller output	360° air supply	Individual louvre control	Additional air supply <sup>(2)</sup>	Synchro - simultaneous operation <sup>(2)</sup>	BMS Modbus <sup>(2)</sup>	BMS Bacnet <sup>(2)</sup>	

1. Feature not available in Multi Split system. 2. Feature is only optional. 3. Feature can be accessed via mobile app.

Model				Tenji 2,1 kW	Tenji 2,6 kW	Tenji 3,5 kW	Tenji 5,3 kW	Tenji 7,0 kW
Capacity	Cooling	Nom. (Min. - Max.)	W	2051	2638	3517 (850-4162)	5275 (2901-5861)	7034 (3297-7913)
Rated input		Nom. (Min. - Max.)	W	-	-	1015 (160-1450)	1550 (720-2040)	2320 (780-2750)
Operating current		Nom. (Min. - Max.)	A	-	-	4,4 (0,7-6,3)	6,7 (3,1-8,9)	10,1 (3,4-11,9)
Capacity	Heating	Nom. (Min. - Max.)	W	2345	2931	3810 (469-4337)	5568 (2374-6301)	7620 (2784-8499)
Rated input		Nom. (Min. - Max.)	W	-	-	1020 (125-1390)	1560 (700-1950)	1900 (610-2300)
Operating current		Nom. (Min. - Max.)	A	-	-	4,4 (0,5-6,0)	6,8 (3,0-8,5)	8,3 (2,7-10)
Reversible heat pump type				air-to-air	air-to-air	air-to-air	air-to-air	air-to-air
Design load in cooling mode			kW	-	-	3,5	5,3	7,1
SEER			W/W	-	-	6,8	6,5	6,3
Energy efficiency class - cooling				-	-	A++	A++	A++
Annual electric energy consumption - cooling			kWh/a	-	-	184	285	394
Design load in heating mode (T <sub>biv</sub> -7°C)			kW	-	-	2,7	4,2	6,2
SCOP			W/W	-	-	4,1	4,1	4,1
Energy efficiency class - heating				-	-	A+	A+	A+
Annual electric energy consumption - heating			kWh/a	-	-	922	1431	2117
Dehumidification			l/h	-	-	1,2	1,8	2,4
Maximum energy consumption			W	-	-	1850	2950	3700
Maximum operating current			A	-	-	8	12,8	16,1
Indoor unit				T21Xi	T26Xi	T35Xi	T50Xi	T70Xi
EAN product code				5905567606250	5905567606267	5905567606274	5905567606281	5905567601736
Fan speed	T / H / M / L	rpm	840 / 770 / 730 / 680	840 / 770 / 730 / 680	850 / 800 / 750 / 700	850 / 800 / 750 / 700	608 / 552 / 524 / 496	
Air flow	T / H / M / L	m <sup>3</sup> /h	610 / 500 / 415 / 320	610 / 500 / 415 / 320	620 / 520 / 430 / 330	660 / 540 / 450 / 300	1247 / 1118 / 1054 / 992	
Sound pressure level	T / H / M / L	dB(A)	41 / 37 / 30,5 / 24,5	41 / 37 / 30,5 / 24,5	42 / 38,5 / 31,5 / 25,5	44 / 41 / 31,5 / 25	45 / 42,5 / 37 / 27,5	
Sound power level		dB(A)	55	55	55	59	59	
Rated input		W	40	40	40	40	64	
Operating current		A	0,2	0,2	0,2	0,2	0,3	
Net dimensions	W × D × H	mm	570 × 570 × 245	570 × 570 × 245	570 × 570 × 245	570 × 570 × 245	830 × 830 × 205	
Gross dimensions	W × D × H	mm	715 × 640 × 295	715 × 640 × 295	715 × 640 × 295	715 × 640 × 295	910 × 910 × 250	
Net weight / Gross weight		kg	16,1 / 18,8	16,1 / 18,8	16,1 / 18,8	16,3 / 19	21,6 / 25,4	
Condensate drain		mm	25	25	25	25	25	
Panel	Model		TCCX2p [R15]	TCCX2p [R15]	TCCX2p [R15]	TCCX2p [R15]	TSCX2p	
	EAN product code		5905567606243	5905567606243	5905567606243	5905567606243	5905567603181	
	Net dimensions	W × D × H	mm	620 × 620 × 50	620 × 620 × 50	620 × 620 × 50	620 × 620 × 50	950 × 950 × 55
	Gross dimensions	W × D × H	mm	715 × 700 × 115	715 × 700 × 115	715 × 700 × 115	715 × 700 × 115	1035 × 1035 × 90
	Net weight / Gross weight		kg	2,7 / 4,3	2,7 / 4,3	2,7 / 4,3	2,7 / 4,3	6 / 9
Outdoor unit				-	-	UO35Xo	UO50Xo	UO70Xo
EAN product code				-	-	5905567601545	5905567601552	5905567613050
Fan speed	H / M / L	rpm	-	-	780 / 675 / 600	760 / 715 / 650	830 / 700 / 550	
Maximum air flow		m <sup>3</sup> /h	-	-	2200	2100	3500	
Sound pressure level		dB(A)	-	-	57	58	60	
Sound power level		dB(A)	-	-	62	65	68	
Net dimensions	W × D × H	mm	-	-	765 × 303 × 555	805 × 330 × 554	890 × 342 × 673	
Gross dimensions	W × D × H	mm	-	-	887 × 337 × 610	915 × 370 × 615	995 × 398 × 740	
Bracket spacing	W × D	(mm)	-	-	452 × 286	511 × 317	663 × 348	
Net weight / Gross weight		kg	-	-	26,6 / 29,0	32,5 / 35,2	41,9 / 45,2	
Refrigerant	Type		-	-	R32	R32	R32	
	GWP		-	-	675	675	675	
	Charged (≤ 5m)	kg		-	-	0,71	1,15	1,4
		TCO <sub>2,eq</sub>		-	-	0,48	0,78	0,95
Charged (> 5m)	g/m		-	-	12	12	24	
Pipe connections	Liquid / Gas	mm (inch)	Φ6,35 / Φ9,52 (1/4" / 3/8")	Φ6,35 / Φ9,52 (1/4" / 3/8")	Φ6,35 / Φ9,52 (1/4" / 3/8")	Φ6,35 / Φ12,7 (1/4" / 1/2")	Φ9,52 / Φ15,9 (3/8" / 5/8")	
Maximum installation length		m	-	-	25	30	50	
Maximum height difference		m	-	-	10	20	25	
Compressor type				-	-	Rotary DC	Rotary DC	Rotary DC
Type of outdoor unit power supply			V-Hz, Ø	220-240-50, 1f	220-240-50, 1f	220-240-50, 1f	220-240-50, 1f	220-240-50, 1f
Current protection			A	-	-	B10	B16	B20
Power cables: outdoor unit	L < 20 m	pcs × mm <sup>2</sup>	Data in HIRO	Data in HIRO	3 × 1,5	3 × 1,5	3 × 2,5	
Control and power cables: unit outdoor- indoor			pcs × mm <sup>2</sup>	4 × 1	4 × 1	4 × 1	4 × 1	4 × 1
Indoor operating range (cooling / heating)			°C	16~32 / 0~30	16~32 / 0~30	16~32 / 0~30	16~32 / 0~30	16~32 / 0~30
Outdoor operating range (cooling / heating)			°C	-	-	-15-50 / -20~24	-15-50 / -20~24	-15-50 / -20~24
Compatible systems								
1:1 SINGLE								
1:2 DUAL								
1:X MULTI S-LINE				•	•	•	•	•
1:X MULTI N-LINE				•	•	•	•	•
1:X MULTI HP-LINE				•	•	•	•	•

T - Turbo; H - High; ML - Middle; L - Low

For T70Xi unit with Ø9.52 (3/8") and Ø15.9 (5/8") connections for MULTI systems, reduction at outdoor unit to Ø6.35 (1/4") and Ø12.7 (1/2") required



Model				Tenji 8,8 kW	Tenji 10,6 kW	Tenji 12,0 kW	Tenji 14,1 kW	Tenji 15,2 kW
Capacity	Cooling	Nom. (Min. - Max.)	W	8792 (2227-9378)	10551 (2696-11429)	12016 (2930-12309)	14067 (3517-15826)	15240 (4103-16119)
Rated input		Nom. (Min. - Max.)	W	2750 (190-3000)	4000 (890-4150)	4200 (680-4350)	4980 (810-6350)	5700 (1000-6250)
Operating current		Nom. (Min. - Max.)	A	12 (0,8-13,0)	6,8 (1,5-7,0)	18,3 (3,0-18,9)	8,4 (1,4-10,7)	9,6 (1,7-10,6)
Capacity	Heating	Nom. (Min. - Max.)	W	9378 (2696-9730)	11137 (2784-12660)	13481 (3370-14067)	16119 (4103-17291)	18170 (4396-19050)
Rated input		Nom. (Min. - Max.)	W	2450 (430-2550)	3000 (780-4000)	3700 (750-4250)	4580 (910-5900)	5700 (1020-6350)
Operating current		Nom. (Min. - Max.)	A	10,7 (1,9-11,1)	5,1 (1,3-6,8)	16,1 (3,3-18,5)	7,7 (1,5-10,0)	9,6 (1,7-10,7)
Reversible heat pump type				air-to-air	air-to-air	air-to-air	air-to-air	air-to-air
Design load in cooling mode			kW	8,8	10,5	12,1	14,0	15,3
SEER			W/W	6,6	6,3	6,1	5,8	5,8
Energy efficiency class - cooling				A++	A++	A++	A+	A+
Annual electric energy consumption - cooling			kWh/a	467	583	700	1450	1583
Design load in heating mode (Tbiv -7°C)			kW	7,7	8,0	9,5	11,2	11,8
SCOP			W/W	4,2	3,9	4,0	4,0	4,0
Energy efficiency class - heating				A+	A	A+	A+	A+
Annual electric energy consumption - heating			kWh/a	2567	2872	3275	3920	4130
Dehumidification			l/h	3,0	3,6	4,2	4,8	5,5
Maximum energy consumption			W	4500	5000	5000	7300	7500
Maximum operating current			A	19,6	8,4	21,7	12,3	12,7
Indoor unit				T90Xi	T100Xi	T120Xi	T140Xi	T160Xi
EAN product code				5905567601743	5905567601750	5905567601767	5905567601774	5905567601781
Fan speed	T / H / M / L	rpm	660 / 600 / 575 / 550	700 / 630 / 600 / 570	712 / 648 / 616 / 584	712 / 648 / 616 / 584	736 / 672 / 640 / 608	
Air flow	T / H / M / L	m³/h	1700 / 1530 / 1415 / 1300	1700 / 1530 / 1415 / 1300	1900 / 1750 / 1670 / 1600	1900 / 1750 / 1670 / 1600	2000 / 1850 / 1750 / 1650	
Sound pressure level	T / H / M / L	dB(A)	50,5 / 48 / 46 / 40	51 / 49 / 46 / 39	52,5 / 50 / 47,5 / 40	51,5 / 49 / 46,5 / 38,5	53 / 50,5 / 45,5 / 40	
Sound power level		dB(A)	63	64	66	66	66	
Rated input		W	157	157	157	157	157	
Operating current		A	0,7	0,7	0,7	0,7	0,7	
Net dimensions	W × D × H	mm	830 × 830 × 245	830 × 830 × 245	830 × 830 × 287	830 × 830 × 287	830 × 830 × 287	
Gross dimensions	W × D × H	mm	910 × 910 × 290	910 × 910 × 290	910 × 910 × 330	910 × 910 × 330	910 × 910 × 330	
Net weight / Gross weight		kg	24,6 / 28,6	27,2 / 31,2	29,3 / 33,5	29,3 / 33,5	29,3 / 33,5	
Condensate drain		mm	25	25	25	25	25	
Panel	Model		TSCX2p	TSCX2p	TSCX2p	TSCX2p	TSCX2p	
	EAN product code		5905567603181	5905567603181	5905567603181	5905567603181	5905567603181	
	Net dimensions	W × D × H	mm	950 × 950 × 55	950 × 950 × 55	950 × 950 × 55	950 × 950 × 55	950 × 950 × 55
	Gross dimensions	W × D × H	mm	1035 × 1035 × 90	1035 × 1035 × 90	1035 × 1035 × 90	1035 × 1035 × 90	1035 × 1035 × 90
	Net weight / Gross weight		kg	6 / 9	6 / 9	6 / 9	6 / 9	6 / 9
Outdoor unit				UO90Xo	UO100Xo	UO120Xo	UO140Xo	UO160Xo
EAN product code				5905567613067	5905567601583	5905567601590	5905567606427	5905567606434
Fan speed	H / M / L	rpm	900 / 750 / 550	950 / 850 / 700	950 / 830 / 750	850 / 600 / 400	850 / 600 / 400	
Maximum air flow		m³/h	3800	4000	4000	7500	7500	
Sound pressure level		dB(A)	62	62	63	64	65	
Sound power level		dB(A)	70	70	72	73	75	
Net dimensions	W × D × H	mm	946 × 410 × 810	946 × 410 × 810	946 × 410 × 810	980 × 375 × 975	980 × 375 × 975	
Gross dimensions	W × D × H	mm	1090 × 500 × 885	1090 × 500 × 885	1090 × 500 × 885	1145 × 500 × 1080	1145 × 500 × 1080	
Bracket spacing	W × D	(mm)	673 × 403	673 × 403	673 × 403	615 × 397	615 × 397	
Net weight / Gross weight		kg	51 / 55,7	80,5 / 85	71,0 / 75,0	92 / 107	92 / 107	
Refrigerant	Type		R32	R32	R32	R32	R32	
	GWP		675	675	675	675	675	
	Charged (≤ 5m)	kg	1,8	2,4	2,8	2,9	3,2	
		TCO <sub>eq</sub>	1,22	1,62	1,89	1,96	2,16	
	Charged (> 5m)	g/m	24	24	24	24	24	
Pipe connections	Liquid / Gas	mm (inch)	Φ9,52 / Φ15,9 (3/8" / 5/8")	Φ9,52 / Φ15,9 (3/8" / 5/8")	Φ9,52 / Φ15,9 (3/8" / 5/8")	Φ9,52 / Φ15,9 (3/8" / 5/8")	Φ9,52 / Φ15,9 (3/8" / 5/8")	
Maximum installation length		m	50	75	75	75	75	
Maximum height difference		m	25	30	30	30	30	
Compressor type				Rotary DC	Rotary DC	Rotary DC	Rotary DC	Rotary DC
Type of outdoor unit power supply		V-Hz, Ø	220-240-50, 1f	380-420-50, 3f	220-240-50, 1f	380-420-50, 3f	380-420-50, 3f	380-420-50, 3f
Current protection		A	B25	B16	B25	B16	B16	B16
Power cables: outdoor unit	L < 20 m	pcs × mm²	3 × 2,5	5 × 2,5	3 × 4	5 × 2,5	5 × 2,5	
Control and power cables: unit outdoor- indoor		pcs × mm²	4 × 1	4 × 1	4 × 1	4 × 1	4 × 1	
Indoor operating range (cooling / heating)		°C	16~32 / 0~30	16~32 / 0~30	16~32 / 0~30	16~32 / 0~30	16~32 / 0~30	
Outdoor operating range (cooling / heating)		°C	-15~50 / -20~24	-15~50 / -20~24	-15~50 / -20~24	-15~50 / -20~24	-15~50 / -20~24	
Compatible systems								
1:1 SINGLE				•	•	•	•	•
1:2 DUAL				•				
1:X MULTI S-LINE								
1:X MULTI N-LINE								
1:X MULTI HP-LINE								



## Air conditioner Floor- ceiling **Jato**

142

**Floor-ceiling air conditioner Jato is an universal device - depending on your needs you will mount it on the wall (vertically), as well as on the ceiling (horizontally).**

It is available in 5 capacities (from 5.3 kW to 15.2 kW) and in Cooling class A++.  
The Jato air conditioner has an efficient, a long range of supply air, thus enabling cooling of large rooms (e.g., meeting rooms and banquet halls, waiting rooms, customer service rooms).

Gold-plated fins have self-cleaning properties and effectively protect the air conditioner from corrosion.

Jato air conditioners are characterized by wide possibilities of control.



LONG AIRFLOW RANGE  
**AUTOMATIC 4D LOUVRES**





### Long range air supply

Advanced, efficient fan design provides long airflow range. Jato air conditioner allows cooling of large rooms (conference and banquet halls).



### Mounting **vertically** and **horizontally**

Jato is a universal device that can be mounted both vertically and horizontally. It is used in large, commercial rooms (customer service rooms, conference and banquet halls).



### Automatic 4D louvres

Built-in actuators allow you to control the operation of vertical and horizontal blinds, using a remote control or wall-mounted controller. This guarantees the highest level of operating comfort and ensures efficient air distribution in the room.



### Heating even at **-20°C**

The technology used and the built-in year-round operation package enable efficient operation of the air conditioner even in extreme weather conditions. The air conditioner will effectively heat the room even at low outdoor temperatures.



### Remote output **ON/OFF**

The option to remotely turn the unit on or off with, for example, a switch using the built-in output on the board main indoor unit



### Winter package

The reliability of the heating function of Rotenso air conditioners is ensured by a new, more efficient compressor, as well as a standard built-in drip tray heater and compressor crankcase heater, which make up the so-called year-round operation package.

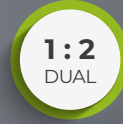

Rotenso participates in the EUROVENT programme.  
Check ongoing validity of certificate:  
[www.eurovent-certification.com](http://www.eurovent-certification.com)

## Features device

Digital DC Inverter SKY <sup>®</sup>	Automatic purification iClean <sup>(1)</sup>	Electrostatic HD iAIR filter	Wide angle eMOTO air supply	Air supply eMOTO control system	Eco eMOTO mode <sup>(1)</sup>	SMART Wi-Fi <sup>(2)</sup>	SMART port wired controller
Smart panel display ON/OFF	Wireless remote controller	Wired controller <sup>(2)</sup>	SMART Follow mode	SMART heating to 8°C <sup>(1)</sup>	Louvre setting memory	Auto restart memory	Anti-corrosive gold fins
Drip tray heater	Compressor crankcase heater	Timer	Cooling at low outdoor temp. down to -15°C	Heating at low outdoor temp. down to -20°C <sup>(1)</sup>	Double-sided condensate drainage	Self-diagnostics	Automatic 4D louvres
Sleep mode	ON/OFF remote output	Alarm output	Weekly controller output	Central controller output	Synchro - simultaneous operation <sup>(2)</sup>	BMS Modbus <sup>(2)</sup>	BMS Bacnet <sup>(2)</sup>

1. Feature not available in Multi Split system. 2. Feature is only optional.

Model				Jato 5,3 kW	Jato 7,0 kW	Jato 10,6 kW	Jato 14,1 kW	Jato 15,2 kW
Capacity	Cooling	Nom. (Min. - Max.)	W	5275 (2711-5861)	7034 (3221-7942)	10551 (2726-11781)	14067 (3517-15240)	15240 (4103-16119)
Rated input		Nom. (Min. - Max.)	W	1450 (670-2027)	2300 (750-2730)	4000 (890-4300)	5000 (910-6200)	5900 (1100-6500)
Operating current		Nom. (Min. - Max.)	A	6,3 (2,9-8,8)	10,0 (3,3-11,9)	6,8 (1,5-7,3)	8,4 (1,5-10,5)	10,0 (1,9-11,0)
Capacity	Heating	Nom. (Min. - Max.)	W	5568 (2418-6301)	7620 (2720-8499)	11723 (2784-12778)	16119 (4103-17584)	18170 (4396-19343)
Rated input		Nom. (Min. - Max.)	W	1500 (540-1640)	1980 (650-2940)	3350 (780-3950)	4800 (950-5950)	5950 (1120-6350)
Operating current		Nom. (Min. - Max.)	A	6,5 (2,3-7,1)	8,6 (2,8-12,8)	5,7 (1,3-6,7)	8,1 (1,6-10)	10,0 (1,9-10,7)
Reversible heat pump type				air-to-air	air-to-air	air-to-air	air-to-air	air-to-air
Design load in cooling mode			kW	5,4	7,1	10,5	14,0	15,3
SEER			W/W	6,2	6,3	6,2	5,8	5,8
Energy efficiency class - cooling				A++	A++	A++	A+	A+
Annual electric energy consumption - cooling			kWh/a	305	401	592	1448	1584
Design load in heating mode (T <sub>biv</sub> -7°C)			kW	4,0	5,9	8,6	11,2	11,8
SCOP			W/W	4,0	4,1	4,0	4,0	4,0
Energy efficiency class - heating				A+	A+	A+	A+	A+
Annual electric energy consumption - heating			kWh/a	1400	2015	3010	3920	4130
Dehumidification			l/h	1,8	2,4	3,6	4,8	5,5
Maximum energy consumption			W	2950	3700	5000	7300	7500
Maximum operating current			A	12,8	16,1	8,4	12,3	12,7
Indoor unit				J50Xi	J70Xi	J100Xi	J140Xi	J160Xi
EAN product code				5905567601828	5905567601835	5905567601842	5905567601859	5905567601866
Fan speed	T / H / M / L	rpm	950 / 850 / 800 / 750	1202 / 1051 / 976 / 900	1160 / 1040 / 980 / 920	1300 / 1200 / 1150 / 1100	1350 / 1050 / 950 / 850	
Air flow	T / H / M / L	m <sup>3</sup> /h	958 / 839 / 781 / 723	1192 / 1023 / 938 / 853	1955 / 1728 / 1616 / 1504	2100 / 1850 / 1725 / 1600	2200 / 1950 / 1800 / 1650	
Sound pressure level	T / H / M / L	dB(A)	44 / 41 / 37 / 24	49,5 / 45,5 / 36,5 / 22,5	51 / 47,5 / 45 / 37	51 / 49 / 43 / 35	53 / 50 / 42 / 36	
Sound power level			dB(A)	59	63	65	68	70
Rated input			W	96	96	96	96	200
Operating current			A	0,4	0,4	0,4	0,4	0,9
Net dimensions		W × D × H	mm	1068 × 675 × 235	1068 × 675 × 235	1650 × 675 × 235	1650 × 675 × 235	1650 × 675 × 235
Gross dimensions		W × D × H	mm	1145 × 755 × 318	1145 × 755 × 318	1725 × 755 × 318	1725 × 755 × 318	1725 × 755 × 318
Net weight / Gross weight			kg	28 / 33,3	28 / 33,3	41,5 / 48	41,7 / 48,5	42,3 / 49,2
Condensate drain			mm	25	25	25	25	25
Outdoor unit				UO50Xo	UO70Xo	UO100Xo	UO140Xo	UO160Xo
EAN product code				5905567601552	5905567613050	5905567601583	5905567606427	5905567606434
Fan speed	W / M / L	rpm	760 / 715 / 650	830 / 700 / 550	950 / 850 / 700	850 / 600 / 400	830 / 740 / 650	
Maximum air flow			m <sup>3</sup> /h	2100	3500	4000	7500	7500
Sound pressure level			dB(A)	55	60	62	64	65
Sound power level			dB(A)	65	69	70	73	75
Net dimensions		W × D × H	mm	805 × 330 × 554	890 × 342 × 673	946 × 410 × 810	980 × 375 × 975	980 × 375 × 975
Gross dimensions		W × D × H	mm	915 × 370 × 615	995 × 398 × 740	1090 × 500 × 885	1145 × 500 × 1080	1145 × 500 × 1080
Bracket spacing		W × D	(mm)	511 × 317	663 × 348	673 × 403	615 × 397	615 × 397
Net weight / Gross weight			kg	32,5 / 35,2	41,9 / 45,2	80,5 / 85	92 / 107	92 / 107
Refrigerant		Type		R32	R32	R32	R32	R32
		GWP		675	675	675	675	675
		Charged (≤ 5m)	kg	1,15	1,4	2,4	2,9	3,2
			TCO <sub>2</sub> eq	0,78	0,95	1,62	1,96	2,16
Charged (> 5m)		g/m	12	24	24	24	24	
Pipe connections		Liquid / Gas	mm (inch)	Φ6,35 / Φ12,7 (1/4" / 1/2")	Φ9,52 / Φ15,9 (3/8" / 5/8")	Φ9,52 / Φ15,9 (3/8" / 5/8")	Φ9,52 / Φ15,9 (3/8" / 5/8")	Φ9,52 / Φ15,9 (3/8" / 5/8")
Maximum installation length			m	30	50	75	75	75
Maximum height difference			m	20	25	30	30	30
Compressor type				Rotary DC	Rotary DC	Rotary DC	Rotary DC	Rotary DC
Power cables: outdoor unit		V-Hz, Ø	220-240-50, 1f	220-240-50, 1f	380-420-50, 3f	380-420-50, 3f	380-420-50, 3f	380-420-50, 3f
Current protection			A	B16	B20	B16	B16	B16
Power cables: outdoor unit		L < 20 m	pcs × mm <sup>2</sup>	3 × 1,5	3 × 2,5	5 × 2,5	5 × 2,5	5 × 2,5
Control and power cables: unit outdoor- indoor			pcs × mm <sup>2</sup>	4 × 1	4 × 1	4 × 1	4 × 1	4 × 1
Indoor operating range (cooling / heating)			°C	16~32 / 0~30	16~32 / 0~30	16~32 / 0~30	16~32 / 0~30	16~32 / 0~30
Outdoor operating range (cooling / heating)			°C	-15~50 / -20~24	-15~50 / -20~24	-15~50 / -20~24	-15~50 / -20~24	-15~50 / -20~24
Compatible systems								
1:1 SINGLE				•	•	•	•	•
1:2 DUAL				•	•			
1:X MULTI S-LINE				•	•			
1:X MULTI N-LINE								
1:X MULTI HP-LINE				•				



## Air conditioner ducted **Nevo**

146

**Ducted air conditioner Nevo is a versatile solution that works well in hotels, offices and even apartments.**

It allows discreet installation, not standing out in the room. A modern controller allows you to control all available functions of the device.

Thanks to the built-in Wi-Fi module, the user can control the air conditioner from anywhere. The device offers the possibility of horizontal or vertical installation, and the air intake can be set at the top or bottom.

Ducted air conditioner Nevo has a condensate pump adjustable up to 1000 mm.



INSTALLATION OPTION  
**HORIZONTALLY OR VERTICALLY**





### Function **SMART Wi-Fi**

Thanks to the included controller, which has a built-in SMART Wi-Fi module, the operation of the air conditioner can be controlled remotely via a mobile app.



### Mounting **vertically** and **horizontally**

Thanks to flexible mounting options the air conditioner can be suspended from the ceiling or built into the wall.

*\* Except of models 2,1-3,5 kW.*



### Built-in **condensate pump**

The compact design of the improved unit has allowed the air conditioner to be equipped with a condensate pump with a head of up to 1000 mm. This improvement will save both space and money.



### Temperature **hold function 8°C**

To prevent excessive cooling of the room, the air conditioner turns on automatically in heating mode. This maintains the air temperature at 8°C.



### Heating **even at -20°C**

The technology used and the built-in year-round operation package enable efficient operation of the air conditioner even in extreme weather conditions. The air conditioner will effectively heat the room even at low outdoor temperatures.



### Winter **package**

The reliability of the heating function of Rotenso air conditioners is ensured by an efficient compressor, as well as a drip tray heater and Compressor crankcase heater built in as standard, making up the so-called year-round operation package.



148

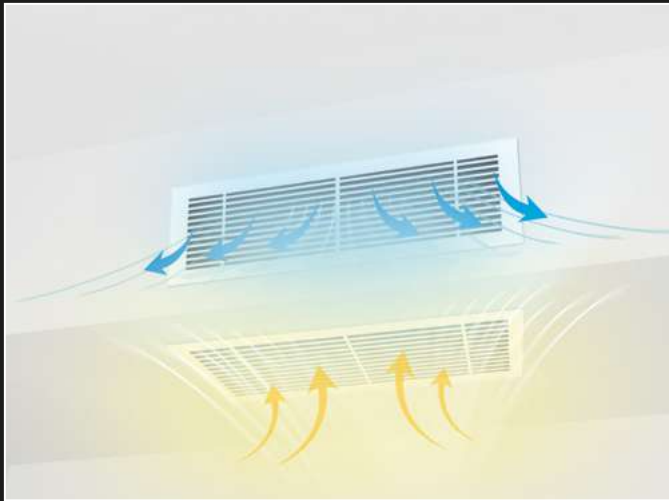

DUCTED  
AIR CONDITIONER  
ROTENSO **NEVO**  
CAN BE  
MOUNTED  
HORIZONTALLY  
OR VERTICALLY

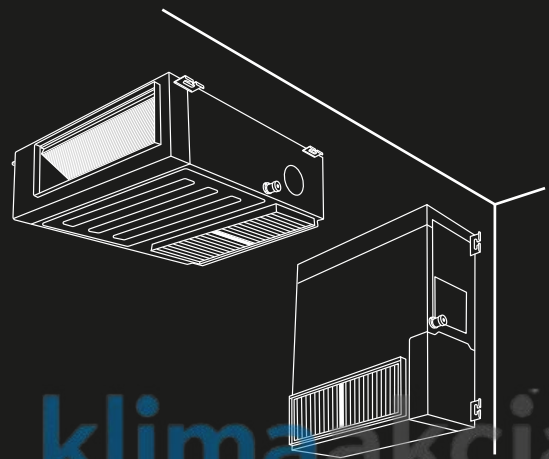



ENABLES ASSEMBLY  
**HORIZONTALLY OR VERTICALLY**

This solution makes it possible, for example, to mount under the ceiling flat or build the device into the wall vertically by mounting in a low wall or wall under a window.

**MOUNTING IN VERTICAL**

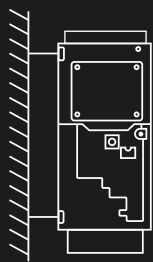

**MOUNTING HORIZONTALLY**

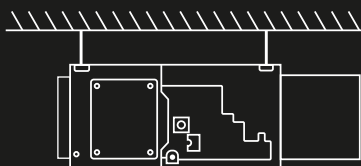

# Zone management

## Nevo air conditioner



CPCC dampers

### Zone control

AIRZONE provides independent temperature control in each room, among other things, thanks to thermostats that work with dampers equipped with a fail-safe control actuator. Each thermostat additionally has a relative humidity sensor. AIRZONE also allows integration with the heating system by controlling thermoelectric heads.



LITE thermostat

18°



LITE thermostat

Off



THINK thermostat

23°

### CPCC dampers

A circular duct with a damper and 12-volt motor drive, controls air flow for a given zone. Dampers are available in three diameters: 125 mm, 160 mm, 200 mm.

150

AIR  
ZONE

## Independent temperature control

In each zone we place one of the three available touch thermostats: BLUEFACE, THINK or LITE. Each available in white or black. The THINK and LITE models are also available in a wireless version.

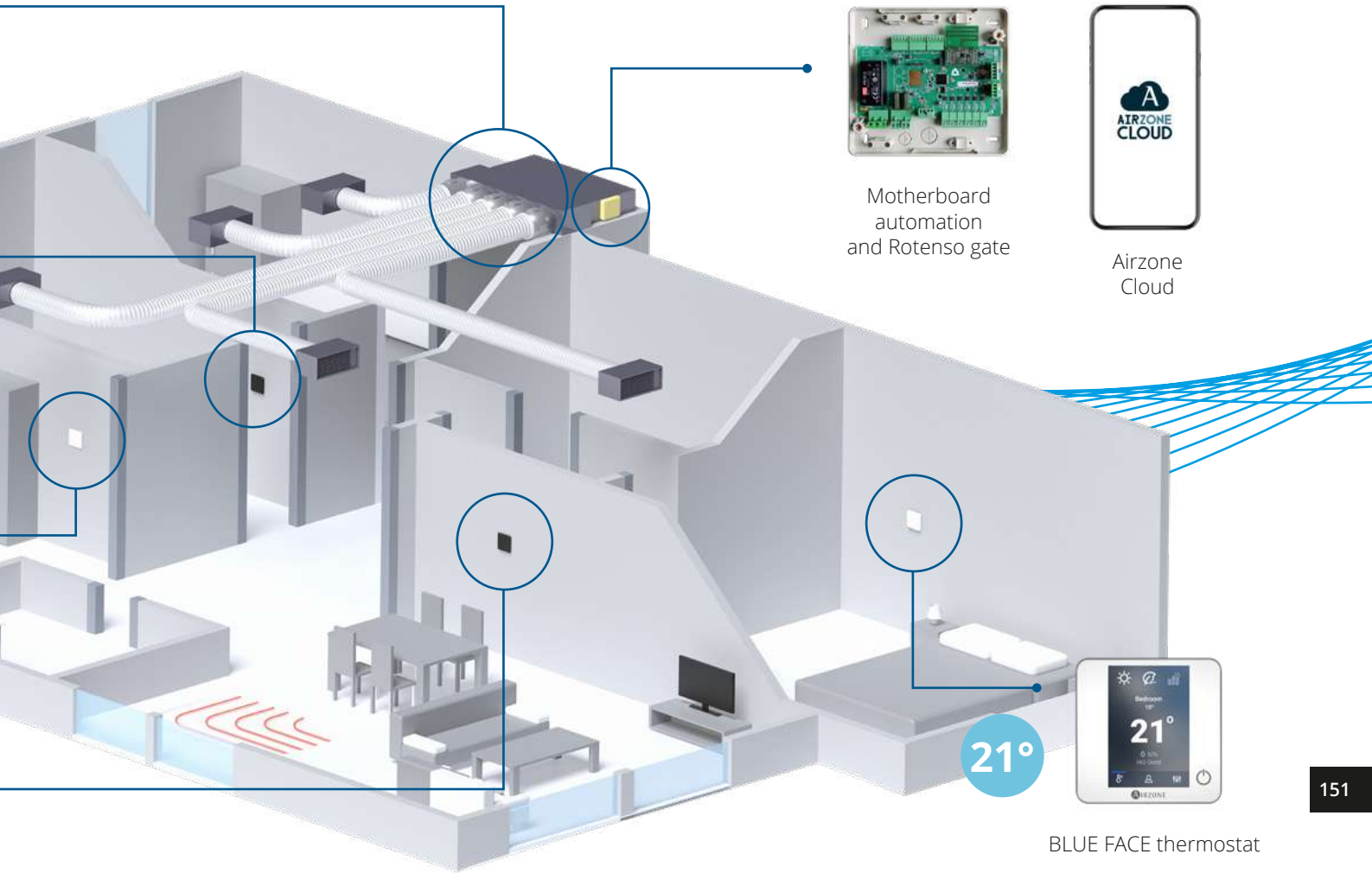

Thermostat **THINK**

Thermostat **BLUE FACE**

Thermostat **LITE**



Master thermostat, wired, with color, touch display 3,5 inches in size.



Master thermostat wireless, with a touchscreen display type e-paper.



Simple zone temperature control thermostat, wired or wireless, without display +/- 3°C.

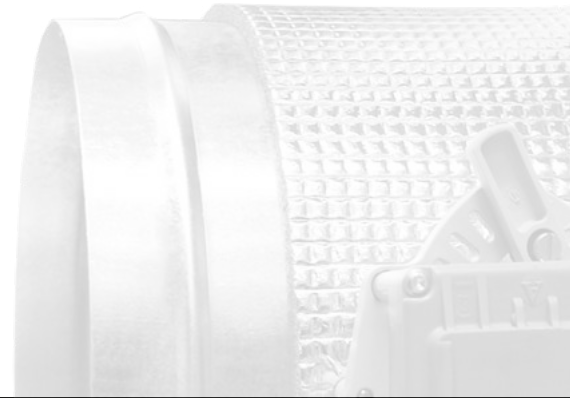

# Zone management nevo air conditioner

---

## Nevo ducted units in SINGLE system with AIRZONE

- Aesthetically pleasing and minimalist solution, without installation of equipment in the rooms.
- Centralized maintenance.
- Air conditioner power precisely adjusted to the heating and cooling demand.

152

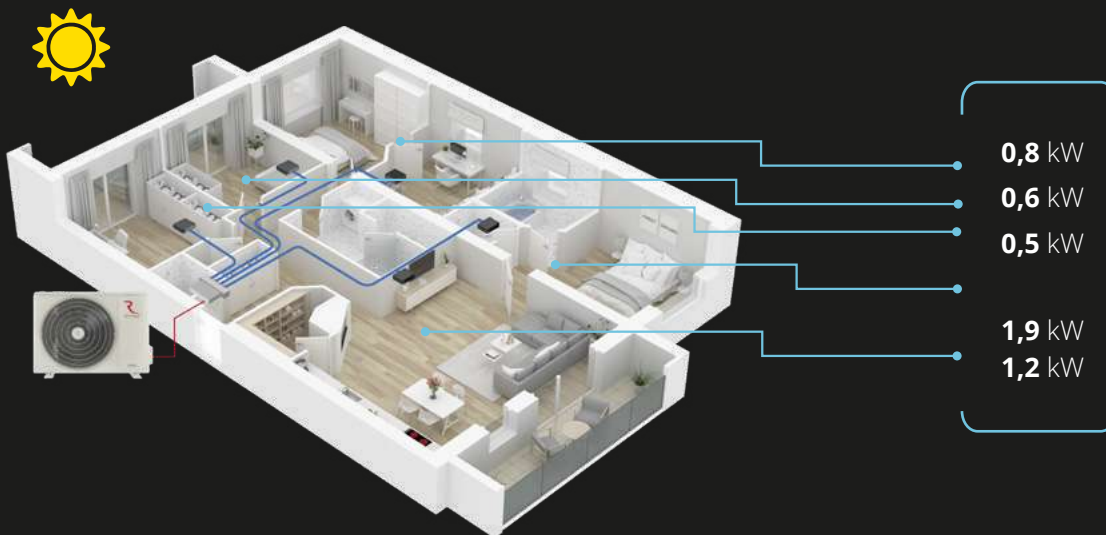

**5 kW**

*Precisely matched Indoor unit power to total total power demand.*

## Wall-mounted units in MULTI system

- Equipment with higher capacity than demand.
- Larger power consumption.
- More Indoor units.
- Need for more space.

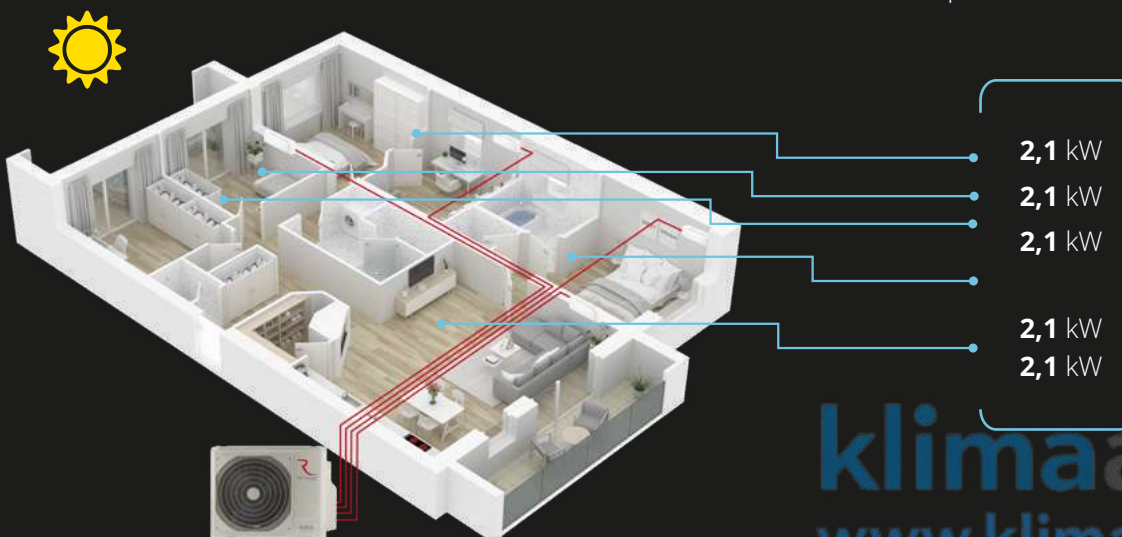

**10,5 kW**

*Minimum power of Indoor units more than the actual demand.*

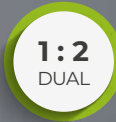

Rotenso participates in the EUROVENT programme.  
Check ongoing validity of certificate:  
[www.eurovent-certification.com](http://www.eurovent-certification.com)

## Features device

 Digital DC Inverter SKY <sup>®</sup>	 Automatic purification iClean <sup>(1)</sup>	 Electrostatic HD iAIR filter	 Turbo eMOTO mode <sup>(1)</sup>	 Wide angle eMOTO air supply	 Wide angle eMOTO air supply	 Eco eMOTO mode <sup>(1)</sup>	 SMART Wi-Fi
 SMART port wired controller	 Wireless remote controller <sup>(2)</sup>	 Wired controller	 SMART Follow mode	 SMART heating to 8°C <sup>(1)</sup>	 Auto restart memory	 Anti-corrosive gold fins	 Drip tray heater
 Compressor crankcase heater	 Silence mode	 Timer	 Cooling at low outdoor temp. down to -15°C	 Heating at low outdoor temp. down to -20°C <sup>(1)</sup>	 Double-sided condensate drainage	 Self-diagnostics	 Sleep mode
 Integrated condensate pump	 Fresh air supply <sup>(2)</sup>	 ON/OFF remote output	 Alarm output	 Weekly controller output	 Central controller output	 Adjustable static pressure	 Additional air supply <sup>(2)</sup>
 Synchro-simultaneous operation <sup>(2)</sup>	 BMS Modbus <sup>(2)</sup>	 BMS Bacnet <sup>(2)</sup>	 Intake air back / bottom	 IrDA receiver for remote control	 Mounting vertical/horizontal <sup>(3)</sup>		

1. Feature not available in Multi Split system. 2. Feature is only optional. 3. Except for Models 2.1-3.5 kW.

Model				Nevo 2,1 kW	Nevo 2,6 kW	Nevo 3,5 kW	Nevo 5,3 kW	Nevo 7,1 kW
Capacity	Cooling	Nom. (Min. - Max.)	W	2051	2638	3517 (528-3908)	5275 (1319-6154)	7092 (3224-7913)
Rated input		Nom. (Min. - Max.)	W	-	-	1164 (155-1465)	1590 (360-2130)	2280 (750-2860)
Operating current		Nom. (Min. - Max.)	A	-	-	5,1 (0,7-6,4)	6,9 (1,6-9,3)	9,9 (3,3-12,4)
Capacity	Heating	Nom. (Min. - Max.)	W	2345	2931	3810 (996-4467)	6008 (1495-6301)	7972 (2784-8558)
Rated input		Nom. (Min. - Max.)	W	-	-	1285 (302-1423)	1615 (500-1850)	2000 (640-2500)
Operating current		Nom. (Min. - Max.)	A	-	-	5,6 (1,3-6,2)	7,0 (2,2-8)	8,7 (2,8-10,9)
Reversible heat pump type				air-to-air	air-to-air	air-to-air	air-to-air	air-to-air
Design load in cooling mode			kW	-	-	3,5	5,3	7,1
SEER			W/W	-	-	6,5	6,5	6,6
Energy efficiency class - cooling				-	-	A++	A++	A++
Annual electric energy consumption - cooling			kWh/a	-	-	189	285	377
Design load in heating mode (Tbiv -7°C)			kW	-	-	2,7	4,3	5,6
SCOP			W/W	-	-	4,1	4,1	4,2
Energy efficiency class - heating				-	-	A+	A+	A+
Annual electric energy consumption - heating			kWh/a	-	-	922	1468	1867
Dehumidification			l/h	-	-	1,2	1,9	1,9
Maximum energy consumption			W	-	-	1850	2950	3700
Maximum operating current			A	-	-	8	12,8	16,1
Indoor unit				N21Xi	N26Xi	N35Xi	N50Xi	N70Xi
EAN product code				5905567606120	5905567606137	5905567606144	5905567606151	5905567606168
Fan speed	T / H / M / L	rpm	1100 / 1070 / 1030 / 950	1130 / 1080 / 1047 / 965	1140 / 1090 / 1052 / 975	1000 / 950 / 900 / 800	950 / 905 / 850 / 750	
Air flow	T / H / M / L	m³/h	610 / 560 / 530 / 420	620 / 575 / 540 / 450	660 / 605 / 570 / 470	900 / 855 / 780 / 650	1200 / 1110 / 1000 / 700	
Sound pressure level	T / H / M / L	dB(A)	34 / 33 / 32 / 30	34,5 / 33 / 32 / 31	35 / 33 / 32 / 31	36,5 / 34 / 33 / 31	33,5 / 32,5 / 32 / 31	
Sound power level		dB(A)	52	52	52	53	56	
Rated input		W	80	80	80	80	150	
Operating current		A	0,3	0,3	0,3	0,3	0,7	
ESP - External static pressure	Standard	Pa	25	25	25	25	25	
	Range	Pa	0 - 80	0 - 80	0 - 100	0 - 160	0 - 160	
Net dimensions	W × D × H	mm	700 × 506 × 200	700 × 506 × 200	700 × 506 × 200	700 × 750 × 245	1000 × 750 × 245	
Gross dimensions	W × D × H	mm	860 × 540 × 285	860 × 540 × 285	860 × 540 × 285	925 × 850 × 298	1225 × 860 × 304	
Net weight / Gross weight		kg	16,6 / 19,8	16,6 / 19,8	16,6 / 19,8	24,4 / 29	31,8 / 37,2	
Condensate drain		mm	25	25	25	25	25	
Outdoor unit				-	-	UO35Xo	UO50Xo	UO70Xo
EAN product code				-	-	5905567601545	5905567601552	5905567613050
Fan speed	H / M / L	rpm	-	-	780 / 675 / 600	760 / 715 / 650	830 / 700 / 550	
Maximum air flow		m³/h	-	-	2200	2100	3500	
Sound pressure level		dB(A)	-	-	55,5	59	60	
Sound power level		dB(A)	-	-	62	62	69	
Net dimensions	W × D × H	mm	-	-	765 × 303 × 555	805 × 330 × 554	890 × 342 × 673	
Gross dimensions	W × D × H	mm	-	-	887 × 337 × 610	915 × 370 × 615	995 × 398 × 740	
Bracket spacing	W × D	(mm)	-	-	452 × 286	511 × 317	663 × 348	
Net weight / Gross weight		kg	-	-	26,6 / 29,0	32,5 / 35,2	41,9 / 45,2	
Refrigerant	Type		-	-	R32	R32	R32	
	GWP		-	-	675	675	675	
	Charged (≤ 5m)	kg	-	-	0,71	1,15	1,4	
		TCO <sub>2</sub> eq	-	-	0,48	0,78	0,95	
Charged (> 5m)	g/mb	-	-	12	12	24		
Pipe connections	Liquid / Gas	mm (inch)	Φ6,35 / Φ9,52 (1/4" / 3/8")	Φ6,35 / Φ9,52 (1/4" / 3/8")	Φ6,35 / Φ9,52 (1/4" / 3/8")	Φ6,35 / Φ12,7 (1/4" / 1/2")	Φ9,52 / Φ15,9 (3/8" / 5/8")	
Maximum installation length		m	-	-	25	30	50	
Maximum height difference		m	-	-	10	20	25	
Compressor type			-	-	Rotary DC	Rotary DC	Rotary DC	
Outdoor unit power supply		V-Hz, Ø	220-240-50, 1f	220-240-50, 1f	220-240-50, 1f	220-240-50, 1f	220-240-50, 1f	
Current protection		A	-	-	B10	B16	B20	
Power cables: outdoor unit	L < 20 m	pcs × mm²	Data in HIRO	Data in HIRO	3 × 1,5	3 × 1,5	3 × 2,5	
Control and power cables: unit outdoor- indoor		pcs × mm²	4 × 1	4 × 1	4 × 1	4 × 1	4 × 1	
Indoor operating range (cooling / heating)		°C	16-32 / 0-30	16-32 / 0-30	16-32 / 0-30	16-32 / 0-30	16-32 / 0-30	
Outdoor operating range (cooling / heating)		°C	-	-	-15-50 / -20-24	-15-50 / -20-24	-15-50 / -20-24	
Compatible systems								
1:1 SINGLE						•	•	•
1:2 DUAL						•	•	•
1:X MULTI S-LINE				•	•	•	•	•
1:X MULTI N-LINE						•	•	•
1:X MULTI HP-LINE				•	•	•	•	•

T - Turbo; H - High; ML - Middle; L - Low

For N70Xi unit with Ø9.52 (3/8") and Ø15.9 (5/8") connections for MULTI systems, reduction at outdoor unit to Ø6.35 (1/4") and Ø12.7 (1/2") is necessary

Model				Nevo 8,8 kW	Nevo 10,6 kW	Nevo 12,1 kW	Nevo 14,1 kW	Nevo 15,2 kW
Capacity	Cooling	Nom. (Min. - Max.)	W	8792 (2227-9964)	10551 (2726-11723)	12104 (2931-12309)	14067 (3517-15826)	15240 (4103-17291)
Rated input		Nom. (Min. - Max.)	W	2800 (190-3450)	3900 (890-4200)	4000 (680-4500)	4500 (810-6450)	5250 (1030-6650)
Operating current		Nom. (Min. - Max.)	A	12,2 (0,8-15)	6,6 (1,5-7,1)	17,4 (3-19,6)	7,6 (1,4-10,9)	8,9 (1,7-11,2)
Capacity	Heating	Nom. (Min. - Max.)	W	9378 (2696-9994)	11723 (2784-12837)	13481 (3370-14067)	16119 (4103-17291)	18170 (4396-20515)
Rated input		Nom. (Min. - Max.)	W	2400 (430-2550)	3300 (780-4000)	3550 (750-4100)	4600 (950-5800)	5150 (950-6600)
Operating current		Nom. (Min. - Max.)	A	10,4 (1,9-11,1)	5,6 (1,3-6,8)	15,4 (3,3-17,8)	7,8 (1,6-9,8)	8,7 (1,6-11,1)
Reversible heat pump type				air-to-air	air-to-air	air-to-air	air-to-air	air-to-air
Design load in cooling mode			kW	8,8	10,6	12,1	14,0	15,3
SEER			W/W	6,6	6,1	6,1	5,8	6,1
Energy efficiency class - cooling				A++	A++	A++	A+	A++
Annual electric energy consumption - cooling			kWh/a	467	608	1190	1448	1505
Design load in heating mode (Tbiv -7°C)			kW	8,0	8,8	9,5	11,5	12,5
SCOP			W/W	4,2	4,0	4,0	4,0	4,0
Energy efficiency class - heating				A+	A+	A+	A+	A+
Annual electric energy consumption - heating			kWh/a	2667	3080	3340	4027	4375
Dehumidification			l/h	3,0	3,8	4,2	5,1	5,8
Maximum energy consumption			W	4500	5000	5000	7300	7500
Maximum operating current			A	19,5	8,4	21,7	12,3	12,7
Indoor unit				N90Xi	N100Xi	N120Xi	N140Xi	N160Xi
EAN product code				5905567606175	5905567606182	5905567606199	5905567606205	5905567606212
Fan speed	T / H / M / L	rpm	1180 / 1100 / 1040 / 910	1120 / 1000 / 940 / 880	1350 / 1230 / 1180 / 1110	1350 / 1230 / 1180 / 1110	910 / 855 / 760 / 690	
Air flow	T / H / M / L	m³/h	1500 / 1330 / 1200 / 900	1700 / 1400 / 1230 / 1100	2000 / 1700 / 1480 / 1300	2000 / 1700 / 1480 / 1300	2200 / 1900 / 1710 / 1500	
Sound pressure level	T / H / M / L	dB(A)	39 / 37 / 36 / 35	40 / 37 / 35 / 34	39 / 37,5 / 37 / 36	43,5 / 41,5 / 40,5 / 39,5	44,5 / 43 / 42 / 41,5	
Sound power level		dB(A)	60	62	62	65	66	
Rated input		W	150	300	400	400	400	
Operating current		A	0,7	1,3	1,7	1,7	1,7	
ESP - External static pressure	Standard	Pa	37	37	50	50	50	
	Range	Pa	0 - 160	0 - 160	0 - 160	0 - 160	0 - 160	
Net dimensions	W × D × H	mm	1000 × 750 × 245	1200 × 750 × 245	1200 × 750 × 245	1200 × 750 × 245	1200 × 750 × 300	
Gross dimensions	W × D × H	mm	1225 × 860 × 304	1425 × 860 × 304	1425 × 860 × 304	1425 × 860 × 304	1425 × 860 × 354	
Net weight / Gross weight		kg	32,7 / 38,3	38,4 / 44,4	40,6 / 46,1	40,4 / 46,8	42,9 / 49,1	
Condensate drain		mm	25	25	25	25	25	
Outdoor unit				UO90Xo	UO100Xo	UO120Xo	UO140Xo	UO160Xo
EAN product code				5905567613067	5905567601583	5905567601590	5905567606427	5905567606434
Fan speed	H / M / L	rpm	900 / 750 / 550	950 / 850 / 700	950 / 830 / 750	850 / 600 / 400	850 / 600 / 400	
Maximum air flow		m³/h	3800	4000	4000	7500	7500	
Sound pressure level		dB(A)	60	65	63,5	64,5	65	
Sound power level		dB(A)	70	70	72	73	75	
Net dimensions		W × D × H	mm	946 × 410 × 810	946 × 410 × 810	946 × 410 × 810	980 × 375 × 975	980 × 375 × 975
Gross dimensions		W × D × H	mm	1090 × 500 × 885	1090 × 500 × 885	1090 × 500 × 885	1145 × 500 × 1080	1145 × 500 × 1080
Bracket spacing		W × D	(mm)	673 × 403	673 × 403	673 × 403	615 × 397	615 × 397
Net weight / Gross weight		kg	51 / 55,7	80,5 / 85	71,0 / 75,0	92 / 107	92 / 107	
Refrigerant	Type		R32	R32	R32	R32	R32	
	GWP		675	675	675	675	675	
	Charged (≤ 5m)	kg	1,8	2,4	2,8	2,9	3,2	
		TCO <sub>2,eq</sub>	1,22	1,62	1,89	1,96	2,16	
Charged (> 5m)	g/mb	24	24	24	24	24		
Pipe connections		Liquid / Gas	mm (inch)	Φ9,52 / Φ15,9 (3/8" / 5/8")	Φ9,52 / Φ15,9 (3/8" / 5/8")	Φ9,52 / Φ15,9 (3/8" / 5/8")	Φ9,52 / Φ15,9 (3/8" / 5/8")	Φ9,52 / Φ15,9 (3/8" / 5/8")
Maximum installation length		m	50	75	75	75	75	
Maximum height difference		m	25	30	30	30	30	
Compressor type				Rotary DC	Rotary DC	Rotary DC	Rotary DC	Rotary DC
Outdoor unit power supply		V-Hz, Ø	220-240-50, 1f	380-420-50, 3f	220-240-50, 1f	380-420-50, 3f	380-420-50, 3f	
Current protection		A	B25	B16	B25	B16	B16	
Power cables: outdoor unit		L < 20 m	pcs × mm²	3 × 2,5	5 × 2,5	3 × 4	5 × 2,5	5 × 2,5
Control and power cables: unit outdoor- indoor			pcs × mm²	4 × 1	4 × 1	4 × 1	4 × 1	4 × 1
Indoor operating range (cooling / heating)		°C	16-32 / 0-30	16-32 / 0-30	16-32 / 0-30	16-32 / 0-30	16-32 / 0-30	
Outdoor operating range (cooling / heating)		°C	-15-50 / -20-24	-15-50 / -20-24	-15-50 / -20-24	-15-50 / -20-24	-15-50 / -20-24	
Compatible systems								
1:1 SINGLE				•	•	•	•	•
1:2 DUAL				•				
1:X MULTI S-LINE								
1:X MULTI N-LINE								
1:X MULTI HP-LINE								



**Multi Rotenso HIRO units  
allow you to build  
air conditioning systems  
in various configurations  
that will be optimally  
suited to each property.**

---

# WE ARE COOL & HEAT



WE ARE **FUTURE**

1:X  
MULTI

HP-LINE

S-LINE

N-LINE

158

**Discover the new  
Rotenso product lines**  
with different power,  
optimal operating parameters  
and possibilities of adapting  
the installation to different needs

---

They show great performance, thanks to which they save energy  
and also ensure a comfortable temperature.

## MULTI aggregates **HP-Line**

HP-LINE

High Performance Rotenso Hiro HP-Line outdoor unit is compatible with S line indoor air conditioners:

**Mirai, Versu, Revio, Imoto, Ukura, Aneru, Nevo, Jato, Tenji.**

- Extremely high performance
- Support for up to 3 indoor units
- Dedicated to heating in extreme conditions
- SMART drip tray heater
- Compressor crankcase heater
- Cooling at -25°C
- Heating at -30°C



## MULTI aggregates **S-Line**

S-LINE

Premium superior Rotenso Hiro S-Line outdoor unit is compatible with S line air conditioners:

**Mirai, Versu, Revio, Imoto, Ukura, Aneru, Nevo, Jato, Tenji.**

- High performance
- Support for up to 5 indoor units
- A wide range of devices
- Dedicated to heating in difficult conditions
- SMART drip tray heater
- Compressor crankcase heater
- Heating at -22°C



159

## MULTI aggregates **N-Line**

N-LINE

The Rotenso Hiro N-Line compact normal outdoor unit is compatible with N line air conditioners:

**Teta, Elis, Roni, Aneru AN.**

- Support for up to 5 indoor units
- Dedicated to heating
- Drip tray heater
- Heating at -20°C





## Aggregate Hiro HP

### Rotenso Hiro HP-Line outdoor unit.

160

Premium high performance unit Rotenso Hiro HP-Line gives you the freedom to choose and create countless combinations with compatible S-Line air conditioners, allowing adapt the system to your needs, allowing you to connect units internal S-Line: wall, cassette, channel, console or floor-ceiling.

You choose!  
Modern and extremely efficient outdoor unit can support up to three indoor units and even has the ability to heat at  $-30^{\circ}\text{C}$ .

Built-in intelligent work package year-round, it enables efficient and energy-saving operation as the only source of heat.

Create your perfect atmosphere.  
No compromise!



**klimaakcia**  
[www.klimaakcia.pl](http://www.klimaakcia.pl)

THE UNIT IS EQUIPPED  
IN DRIP TRAY HEATER AND THE  
COMPRESSOR CRANKCASE HEATER



## Device line **High Performance**

A line of multi high performance units HP-Line is a combination of extreme performance, reliability and energy efficiency.



## Compatibility **with S-Line units**

Compatibility with indoor units S-Line:  
**Mirai, Versu, Revio, Imoto, Ukura, Aneru, Nevo, Jato, Tenji.**

161



## Extremely high **work productivity**

HP line air conditioners have been designed with the most demanding climatic conditions in mind, guaranteeing stable and efficient work.



## Heater **drip tray**

The SMART drip tray heater can quickly melt and remove snow and ice from inside the outdoor unit, ensuring stable operation of the device.



## Heating at temp. **external -30°C**

The technology used allows the air conditioner to operate efficiently even in extreme weather conditions. Air conditioner it will even heat the room effectively at low outdoor temperatures.



## Compressor **crankcase heater**

The compressor's crankcase heater prepares it for trouble-free and efficient operation in heating mode when you need it, ensuring long-term reliability for many years.



## Features device

162



Digital DC Inverter SKY®



Auto restart memory



Anti-corrosive gold fins



Drip tray heater



Compressor crankcase heater



Cooling at low outdoor temp. down to -25°C



Heating at low outdoor temp. down to -30°C



Self-diagnostics







































Configuration tables **HIRO HP** generator you will find on the website [rotenso.com](http://rotenso.com)

## Up to 3 devices internal

Rotenso unit Hiro HP allows you to connect up to three units internal (depending on model):

<b>HHP50Xm2</b>	<b>HHP70Xm3</b>
down to <b>2</b> indoor units	down to <b>3</b> indoor units



Indoor unit	2,1 kW		2,6 - 2,7 kW		3,5 kW		5,0 - 5,3 kW		7,0 - 7,3 kW	
MIRAI Wall-mounted	-		M26Xi		M35Xi		-		-	
VERSU MIRROR <sup>NEW (R15)</sup> Wall-mounted	-		VM26Xi		VM35Xi		VM50Xi		-	
VERSU PURE Wall-mounted	-		VP26Xi		VP35Xi		VP50Xi		-	
VERSU CLOTH STONE Wall-mounted	-		VCS26Xi		VCS35Xi		VCS50Xi		-	
VERSU CLOTH CARAMEL Wall-mounted	-		VCC26Xi		VCC35Xi		VCC50Xi		-	
REVIO Wall-mounted	-		RO26Xi		RO35Xi		RO50Xi		-	
IMOTO Wall-mounted	I21Xi		I26Xi		I35Xi		I50Xi		-	
UKURA Wall-mounted	U21Xi		U26Xi		U35Xi		U50Xi		-	
TENJI CC Cassette 360° 620 x 620	T21Xi		T26Xi		T35Xi		T50Xi		-	
JATO Floor-standing ceiling mounted	-		-		-		J50Xi		-	
NEVO Ducted	N21Xi		N26Xi		N35Xi		N50Xi		-	
ANERU Console	-		A26Xi		A35Xi		A50Xi		-	

## Extremely high performance

Modern and extremely efficient outdoor unit with built-in an intelligent year-round work package. Enables efficient and energy-saving operation work as the only source of heat.



Highly efficient work parameters



Model				Hiro HP 5,3 kW	Hiro HP 7,9 kW
Capacity	Cooling	Nom. (Min. - Max.)	W	5275 (920-6935)	7913 (1100-8774)
Rated input		Nom. (Min. - Max.)	W	1080 (250-1460)	1978 (260-2400)
Operating current		Nom. (Min. - Max.)	A	4,7 (1,1-6,3)	8,6 (1,1-10,4)
Capacity	Heating	Nom. (Min. - Max.)	W	5275 (980-7350)	8206 (1705-9330)
Rated input		Nom. (Min. - Max.)	W	1080 (250-1690)	2159 (260-2300)
Operating current		Nom. (Min. - Max.)	A	4,7 (1,1-7,3)	9,4 (1,1-10)
Reversible heat pump type				air-to-air	air-to-air
Design load in cooling mode			kW	5,3	7,9
SEER			W/W	8,5	8,5
Energy efficiency class - cooling				A+++	A+++
Annual electric energy consumption - cooling			kWh/a	218	325
Design load in heating mode (Tbiv -7°C)			kW	4,3	6,0
SCOP			W/W	4,6	4,6
Energy efficiency class - heating				A++	A++
Annual electric energy consumption - heating			kWh/a	1309	1826
Maximum energy consumption			W	3050	4100
Maximum operating current			A	13,3	17,8
Outdoor unit				HHP50Xm2	HHP70Xm3
EAN product code				5905567606076	5905567606113
Fan speed	H / M / L	rpm	850 / 690 / 580	900 / 750 / 600	
Maximum air flow			m³/h	3000	4000
Sound pressure level			dB(A)	59	62
Sound power level			dB(A)	65	66
Net dimensions	W × D × H	mm	890 × 342 × 673	946 × 410 × 810	
Gross dimensions	W × D × H	mm	1030 × 438 × 750	1090 × 500 × 875	
Bracket spacing	W × D	mm	663 × 348	673 × 403	
Net weight / Gross weight			kg	45 / 48,5	62 / 66
Refrigerant	Type		R32	R32	
	GWP		675	675	
	Factor quantity	kg	1,5 (up to 15 mb)	2,1 (up to 22,5 mb)	
		TCO <sub>2</sub> eq	1,01	1,42	
Additional quantity	g/m	12 (over 15 meters)	12 (over 22,5 meters)		
Pipe connections	Liquid / Gas	mm (inch)	2 × Φ6,35 / Φ9,52 (2 × 1/4" / 3/8")	3 × Φ6,35 / Φ9,52 + 1 × Φ12,7 (3 × 1/4" / 2 × 3/8" + 1 × 1/2")	
Max. number of connected indoor units			pcs	2	3
Max. installation length for all indoor units			m	40	60
Max. installation length for 1 indoor unit			m	25	30
Max. level difference between indoor and outdoor unit	Outdoor unit is higher than indoor	m	10	10	
	Outdoor unit is lower than indoor	m	15	15	
Max. level difference between indoor units			m	10	10
Compressor type				Rotary DC	Rotary DC
Type of outdoor unit power supply			V-Hz, Ø	220-240~ 50, 1f	220-240~ 50, 1f
Current protection			A	B16	B20
Power cables: outdoor unit	L < 20 m	pcs × mm²	3 × 2,5	3 × 2,5	
Control and power cables: unit, external - internal			pcs × mm²	4 × 1,5	4 × 1,5
Outdoor operating range (cooling / heating)			°C	-25~50 / -30~24	-25~50 / -30~24
Compatible systems					
1:1 SINGLE					
1:2 DUAL					
1:X MULTI S-LINE					
1:X MULTI N-LINE					
1:X MULTI HP-LINE					

H - High; M - Medium; L - Low





## Aggregate Hiro S

**The Rotenso Hiro S-Line unit will allow you to create the perfect climate without compromise!**

The superior Rotenso Hiro S-Line unit gives you the freedom to choose and create countless combinations with compatible S-line air conditioners, allowing you to adapt the system to your needs by connecting up to 5 indoor units.

S-Line: wall, cassette, channel, console or floor-ceiling.

You choose!

A modern and efficient outdoor unit available in as many as 8 variants of outdoor units (from 4.1 kW to 12.3 kW).

The built-in intelligent year-round operation package enables efficient, energy-saving operation even as the only heat source.





Device line  
**Premium S**

A line of premium superior air conditioners S-Line is a unique combination of performance, reliability and energy efficiency.



Compatibility  
**with S-Line units**

Compatibility with S-Line units:  
**Mirai, Versu, Revio, Imoto, Ukura, Aneru, Nevo, Jato, Tenji.**



Up to 5 units  
**internal**

Rotenso unit Hiro S allows you to connect connection of up to five indoor units (depending on the model).



Heater  
**drip tray**

The SMART drip tray heater can quickly melt and remove snow and ice from inside the outdoor unit, ensuring stable operation of the device.



Heating at temp.  
**external -22°C**

The technology used allows the air conditioner to operate efficiently even in extreme weather conditions. Air conditioner it will even heat the room effectively at low outdoor temperatures.



Compressor  
**crankcase heater**

The compressor's crankcase heater prepares it for trouble-free and efficient operation in heating mode when you need it, ensuring long-term reliability for many years.

4,1 -12,3 kW



S-LINE



## Features device

168



Digital DC Inverter SKY<sup>®</sup>



Auto restart memory



Anti-corrosive gold fins



Drip tray heater



Compressor crankcase heater



Cooling at low outdoor temp. down to -15°C



Heating at low outdoor temp. down to -22°C



Self-diagnostics





















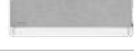
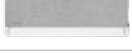
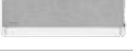





















Configuration tables  
**HIRO S** unit you will find on the website  
[rotenso.com](http://rotenso.com)

## Up to 5 devices internal

Rotenso unit Hiro S allows you to connect up to five indoor units (depending on the model):



H40Xm2	H50Xm2	H50Xm3	H60Xm3	H70Xm3	H80Xm4	H100Xm4	H120Xm5
down to 2 indoor units	down to 2 indoor units	down to 3 indoor units	down to 3 indoor units	down to 3 indoor units	down to 4 indoor units	down to 4 indoor units	down to 5 indoor units

Indoor unit	2,1 kW		2,6 - 2,7 kW		3,5 kW		5,0 - 5,3 kW		7,0 - 7,3 kW	
MIRAI Wall-mounted	-		M26Xi		M35Xi		-		-	
VERSU MIRROR <sup>NEW (R15)</sup> Wall-mounted	-		VM26Xi		VM35Xi		VM50Xi		-	
VERSU PURE Wall-mounted	-		VP26Xi		VP35Xi		VP50Xi		-	
VERSU CLOTH STONE Wall-mounted	-		VCS26Xi		VCS35Xi		VCS50Xi		-	
VERSU CLOTH CARAMEL Wall-mounted	-		VCC26Xi		VCC35Xi		VCC50Xi		-	
REVIO Wall-mounted	-		RO26Xi		RO35Xi		RO50Xi		RO70Xi	
IMOTO Wall-mounted	I21Xi		I26Xi		I35Xi		I50Xi		I70Xi	
UKURA Wall-mounted	U21Xi		U26Xi		U35Xi		U50Xi		U70Xi	
TENJI CC Cassette 360° 620 x 620	T21Xi		T26Xi		T35Xi		T50Xi		-	
TENJI CS Cassette 360° 950 x 950	-		-		-		-		T70Xi	
JATO Floor-standing ceiling mounted	-		-		-		J50Xi		J70Xi	
NEVO Ducted	N21Xi		N26Xi		N35Xi		N50Xi		N70Xi	
ANERU Console	-		A26Xi		A35Xi		A50Xi		-	

## Quiet Work

The unique design of the Rotenso Hiro S unit minimizes vibrations of moving elements during operation, thanks to which the noise level is effectively reduced.



Quiet as the sound of the forest



Model				Hiro S 4,1 kW	Hiro S 5,3 kW	Hiro S 5,3 kW	Hiro S 6,2 kW
Capacity	Cooling	Nom. (Min. - Max.)	W	4102 (965-5650)	5275 (970-6520)	5275 (970-6630)	6154 (1164-7650)
Rated input		Nom. (Min. - Max.)	W	1270 (120-1650)	1630 (125-2000)	1630 (125-2070)	1905 (180-3120)
Operating current		Nom. (Min. - Max.)	A	5,5 (0,5-7,2)	7,1 (0,5-8,7)	7,1 (0,5-9,0)	8,3 (0,8-13,6)
Capacity	Heating	Nom. (Min. - Max.)	W	4396 (1030-6221)	5568 (1030-7000)	5272 (1030-7100)	6448 (1580-7950)
Rated input		Nom. (Min. - Max.)	W	1200 (250-1620)	1500 (250-1670)	1500 (250-1780)	1738 (350-1800)
Operating current		Nom. (Min. - Max.)	A	5,2 (1,1-7,0)	6,5 (1,1-7,3)	6,5 (1,1-7,7)	7,6 (1,5-7,8)
Reversible heat pump type				air-to-air	air-to-air	air-to-air	air-to-air
Design load in cooling mode			kW	4,1	5,3	5,3	6,1
SEER			W/W	6,8	6,3	6,8	6,3
Energy efficiency class - cooling				A++	A++	A++	A++
Annual electric energy consumption - cooling			kWh/a	211	294	273	339
Design load in heating mode (T <sub>biv</sub> -7°C)			kW	3,7	4,3	4,5	5,1
SCOP			W/W	4,0	4,0	4,0	4,1
Energy efficiency class - heating				A+	A+	A+	A+
Annual electric energy consumption - heating			kWh/a	1295	1575	1575	1741
Maximum energy consumption			W	2750	3050	2760	3910
Maximum operating current			A	12,0	13,3	12,0	17,0
Outdoor unit				H40Xm2	H50Xm2	H50Xm3	H60Xm3
EAN product code				5905567601620	5905567601637	5905567606069	5905567601644
Fan speed	H / M / L	rpm	800 / 750 / 700	850 / 800 / 750	810 / 700 / 500	900 / 850 / 750	
Maximum air flow			m <sup>3</sup> /h	2200	2200	2200	3000
Sound pressure level			dB(A)	55	54	56	54
Sound power level			dB(A)	65	65	65	66
Net dimensions		W × D × H	mm	805 × 330 × 554	805 × 330 × 554	805 × 330 × 554	890 × 342 × 673
Gross dimensions		W × D × H	mm	920 × 380 × 615	920 × 380 × 615	950 × 380 × 615	1005 × 440 × 750
Bracket spacing		W × D	mm	511 × 317	511 × 317	511 × 317	663 × 348
Net weight / Gross weight			kg	31,6 / 34,7	35,5 / 38,5	36,2 / 39,4	46,8 / 51,1
Refrigerant	Type			R32	R32	R32	R32
	GWP			675	675	675	675
	Factor quantity	kg		1,1 (up to 15 meters)	1,25 (up to 15 meters)	1,5 (up to 22,5 meters)	1,5 (up to 22,5 meters)
		TCO <sub>2eq</sub>		0,74	0,84	1,01	1,01
Additional quantity		g/m	12 (over 15 meters)	12 (over 15 meters)	12 (over 22,5 meters)	12 (over 22,5 meters)	
Pipe connections		Liquid / Gas	mm (inch)	2 × Ø6,35 / Ø9,52 (2 × 1/4" / 3/8")	2 × Ø6,35 / Ø9,52 (2 × 1/4" / 3/8")	3 × Ø6,35 / Ø9,52 (3 × 1/4" / 3/8")	3 × Ø6,35 / Ø9,52 (3 × 1/4" / 3/8")
Max. number of connected indoor units			pcs	2	2	3	3
Max. installation length for all indoor units			m	40	40	60	60
Max. installation length for 1 indoor unit			m	25	25	30	30
Max. level difference between indoor and outdoor unit	Outdoor unit is higher than indoor		m	10	10	10	10
	Outdoor unit is lower than indoor		m	15	15	15	15
Max. level difference between indoor units			m	10	10	10	10
Compressor type				Rotary DC	Rotary DC	Rotary DC	Rotary DC
Type of outdoor unit power supply			V-Hz, Ø	220-240~ 50, 1f	220-240~ 50, 1f	220-240~ 50, 1f	220-240~ 50, 1f
Current protection			A	B16	B16	B16	B20
Power cables: outdoor unit		L < 20 m	pcs × mm <sup>2</sup>	3 × 1,5	3 × 2,5	3 × 2,5	3 × 2,5
Control and power cables: unit external - internal			pcs × mm <sup>2</sup>	4 × 1,5	4 × 1,5	4 × 1,5	4 × 1,5
Outdoor operating range (cooling / heating)			°C	-15-50 / -22-24	-15-50 / -22-24	-15-50 / -22-24	-15-50 / -22-24
Compatible systems							
1:1 SINGLE							
1:2 DUAL							
1:X MULTI S-LINE							
1:X MULTI N-LINE							
1:X MULTI HP-LINE							

H - High; M - Medium; L - Low

Model				Hiro S 7,9 kW	Hiro S 8,2 kW	Hiro S 10,5 kW	Hiro S 12,3 kW
Capacity	Cooling	Nom. (Min. - Max.)	W	7912 (1158-8342)	8205 (1143-9948)	10550 (945-13800)	12308 (970-14740)
Rated input		Nom. (Min. - Max.)	W	2450 (220-3120)	2540 (130-3400)	3270 (295-4150)	3810 (180-4650)
Operating current		Nom. (Min. - Max.)	A	10,65 (1,0-13,6)	11,0 (0,6-14,8)	14,2 (1,3-18)	16,6 (0,8-20,2)
Capacity	Heating	Nom. (Min. - Max.)	W	8206 (1795-8890)	8792 (1844-10655)	10550 (1855-14400)	12309 (1110-15540)
Rated input		Nom. (Min. - Max.)	W	2200 (320-2900)	2370 (280-3100)	2880 (603-4483)	3315 (550-4050)
Operating current		Nom. (Min. - Max.)	A	9,6 (1,4-12,6)	10,3 (1,2-13,5)	12,5 (2,6-19,5)	14,4 (2,4-17,6)
Reversible heat pump type				air-to-air	air-to-air	air-to-air	air-to-air
Design load in cooling mode			kW	7,9	8,2	10,5	12,1
SEER			W/W	6,3	7,0	6,7	6,9
Energy efficiency class - cooling				A++	A++	A++	A++
Annual electric energy consumption - cooling			kWh/a	439	410	549	614
Design load in heating mode (T <sub>biv</sub> -7°C)			kW	5,3	6,5	8,2	9,3
SCOP			W/W	4,1	4,0	4,0	4,0
Energy efficiency class - heating				A+	A+	A+	A+
Annual electric energy consumption - heating			kWh/a	1810	2275	2870	3255
Maximum energy consumption			W	4100	4150	4600	4700
Maximum operating current			A	17,8	18,0	20,0	20,4
Outdoor unit				H70Xm3	H80Xm4	H100Xm4	H120Xm5
EAN product code				5905567601651	5905567601668	5905567601675	5905567601682
Fan speed	H / M / L	rpm	900 / 850 / 750	1150 / 1050 / 900	900 / 750 / 600	900 / 750 / 600	
Maximum air flow			m <sup>3</sup> /h	3000	3800	4000	3850
Sound pressure level			dB(A)	55	61	62	64
Sound power level			dB(A)	67	67	68	69
Net dimensions		W × D × H	mm	890 × 342 × 673	946 × 410 × 810	946 × 410 × 810	946 × 410 × 810
Gross dimensions		W × D × H	mm	1005 × 440 × 750	1090 × 500 × 875	1090 × 500 × 865	1090 × 500 × 865
Bracket spacing		W × D	mm	663 × 348	673 × 403	673 × 403	673 × 403
Net weight / Gross weight			kg	51,1 / 56,8	62,1 / 67,7	68,8 / 75,6	73,3 / 80,4
Refrigerant	Type			R32	R32	R32	R32
	GWP			675	675	675	675
	Factor quantity	kg		1,85 (up to 22,5 meters)	2,1 (up to 30 meters)	2,1 (up to 30 meters)	2,9 (up to 37,5 meters)
		TCO <sub>2eq</sub>		1,240	1,420	1,420	1,960
Additional quantity		g/m	12 (over 22,5 meters)	12 (over 30 meters)	12 (over 30 meters)	12 (over 37,5 meters)	
Pipe connections		Liquid / Gas	mm (inch)	3 × Ø6,35 / Ø9,52 (3 × 1/4" / 3/8")	4 × Ø6,35 / 3 × Ø9,52 + 1 × Ø12,7 (4 × 1/4" / 3 × 3/8" + 1 × 1/2")	4 × Ø6,35 / 3 × Ø9,52 + 1 × Ø12,7 (4 × 1/4" / 3 × 3/8" + 1 × 1/2")	5 × Ø6,35 / 4 × Ø9,52 + 1 × Ø12,7 (5 × 1/4" / 4 × 3/8" + 1 × 1/2")
Max. number of connected indoor units			pcs	3	4	4	5
Max. installation length for all indoor units			m	60	80	80	80
Max. installation length for 1 indoor unit			m	30	35	35	35
Max. level difference between indoor and outdoor unit	Outdoor unit is higher than indoor		m	10	10	10	10
	Outdoor unit is lower than indoor		m	15	15	15	15
Max. level difference between indoor units			m	10	10	10	10
Compressor type				Rotary DC	Rotary DC	Rotary DC	Rotary DC
Type of outdoor unit power supply			V-Hz, Ø	220-240~ 50, 1f	220-240~ 50, 1f	220-240~ 50, 1f	220-240~ 50, 1f
Current protection			A	B20	B25	B25	B25
Power cables: outdoor unit		L < 20 m	pcs × mm <sup>2</sup>	3 × 2,5	3 × 2,5	3 × 2,5	3 × 4,0
Control and power cables: unit external - internal			pcs × mm <sup>2</sup>	4 × 1,5	4 × 1,5	4 × 1,5	4 × 1,5
Outdoor operating range (cooling / heating)			°C	-15-50 / -22-24	-15-50 / -22-24	-15-50 / -22-24	-15-50 / -22-24
Compatible systems							
1:1 SINGLE							
1:2 DUAL							
1:X MULTI S-LINE				•	•	•	•
1:X MULTI N-LINE							
1:X MULTI HP-LINE							

H - High; M - Medium; L - Low



## Aggregate Hiro N

Thanks to normal Rotenso Hiro N-Line units, you can create a solution that will be precisely tailored to your home and needs.

The Rotenso Hiro N-Line compact normal unit gives you unlimited choice and creation of countless combinations with compatible N-line air conditioners, allowing you to adapt the system to your needs, enabling the connection of up to 5 N-Line indoor units: wall-mounted or console-mounted.

A modern and efficient outdoor unit available in 5 unit variants (from 4.1 kW to 11.8 kW).

The built-in drip tray heater allows efficient operation even as the only heat source.





Device line  
**Compact N**

Thanks to normal Rotenso Hiro N-Line units, you can create a solution that will be precisely tailored to your home and needs.



Compatibility  
**with N-Line units**

Compatibility with N-Line units:  
**Teta, Elis, Roni, Aneru AN.**



Up to 5 units  
**internal**

Rotenso unit Hiro N allows you to connect connection of up to five indoor units (depending on the model).



5 variants  
**unit external**

The Rotenso Hiro N unit is available in 5 different variants and allows you to connect up to five indoor units (depending on the model).



Heating at temp.  
**external -20°C**

The technology used allows the air conditioner to operate efficiently even in extreme weather conditions. Air conditioner it will even heat the room effectively at low outdoor temperatures.



Heater  
**drip tray**

The built-in drip tray heater can quickly melt and remove snow and ice from inside the outdoor unit, ensuring stable operation of the device.



## Features device

174



Digital DC Inverter SKY®



Auto restart memory



Anti-corrosive gold fins



Drip tray heater



Compact dimensions



Cooling at low outdoor temp. down to -15°C



Heating at low outdoor temp. down to -20°C



Self-diagnostics



Configuration tables **HIRO N** unit you will find on the website [rotenso.com](http://rotenso.com)

## Up to 5 devices internal

Rotenso unit Hiro N allows you to connect up to five indoor units (depending on the model):

HN40Xm2	HN50Xm2	HN70Xm3	HN90Xm4	HN120Xm5
down to 2 indoor units	down to 2 indoor units	down to 3 indoor units	down to 4 indoor units	down to 5 indoor units



# Indoor units compatible in the N-Line system

Indoor unit	2,6 kW		3,4 - 3,6 kW		4,7 - 5,1 kW		6,8 - 7,0 kW
TETA Wall-mounted	TA26Xi		TA35Xi		-		-
TETA MIRROR Wall-mounted	TM26Xi		TM35Xi		-		-
ELIS Wall-mounted	E26Xi		E35Xi		E50Xi		-
ELIS SILVER Wall-mounted	ES26Xi		ES35Xi		ES50Xi		-
RONI Wall-mounted	R26Xi		R35Xi		R50Xi		-
ANERU AN Console	-		AN35Xi		AN50Xi		-



Model				Hiro N 4,1 kW	Hiro N 5,1 kW	Hiro N 7,5 kW
Capacity	Cooling	Nom. (Min. - Max.)	W	4103 (1172-4836)	5099 (1231-5598)	7512 (1448-7929)
Rated input		Nom. (Min. - Max.)	W	1269 (250-1660)	1545 (280-2050)	2445 (350-2850)
Operating current		Nom. (Min. - Max.)	A	5,5 (1,1-7,2)	6,7 (1,2-8,9)	10,6 (1,5-12,4)
Capacity	Heating	Nom. (Min. - Max.)	W	4499 (1260-5217)	5275 (1290-5744)	7913 (2239-8450)
Rated input		Nom. (Min. - Max.)	W	1212 (230-1660)	1333 (280-2050)	2145 (420-2850)
Operating current		Nom. (Min. - Max.)	A	5,0 (1,0-7,2)	5,8 (1,2-8,9)	9,3 (1,8-12,4)
Reversible heat pump type				air-to-air	air-to-air	air-to-air
Design load in cooling mode			kW	4,1	5,1	7,9
SEER			W/W	6,1	6,1	6,1
Energy efficiency class - cooling				A++	A++	A++
Annual electric energy consumption - cooling			kWh/a	235	293	453
Design load in heating mode (Tbiv -7°C)			kW	3,6	4,0	5,6
SCOP			W/W	4,0	4,0	4,0
Energy efficiency class - heating				A+	A+	A+
Annual electric energy consumption - heating			kWh/a	1260	1400	1960
Maximum energy consumption			W	1660	2050	2850
Maximum operating current			A	7,2	8,9	12,4
Outdoor unit				HN40Xm2	HN50Xm2	HN70Xm3
EAN product code				5905567606540	5905567606557	5905567606564
Fan speed	H / M / L	rpm	1000 / 900 / 800	1000 / 900 / 800	850 / 750 / 700	
Maximum air flow			m³/h	2600	2600	3000
Sound pressure level			dB(A)	55	55	58
Sound power level			dB(A)	64	65	67
Net dimensions	W × D × H	mm	853 × 349 × 602	853 × 349 × 602	913 × 362 × 699	
Gross dimensions	W × D × H	mm	890 × 385 × 628	890 × 385 × 628	960 × 400 × 732	
Bracket spacing	W × D	mm	516 × 314	516 × 314	586 × 348	
Net weight / Gross weight			kg	29 / 31	31 / 33	42 / 45
Refrigerant	Type		R32	R32	R32	
	GWP		675	675	675	
	Factor quantity	kg	0,83 (up to 10 meters)	1,1 (up to 10 meters)	1,5 (up to 15 meters)	
		TCO <sub>2</sub> eq	0,56	0,74	1,01	
Additional quantity	g/m	15 (over 10 meters)	15 (over 10 meters)	15 (over 15 meters)		
Pipe connections	Liquid / Gas	mm (inch)	2 × Ø6,35 / Ø9,52 (2 × 1/4" / 3/8")	2 × Ø6,35 / Ø9,52 (2 × 1/4" / 3/8")	3 × Ø6,35 / Ø9,52 (3 × 1/4" / 3/8")	
Max. number of connected indoor units			pcs	2	2	3
Max. installation length for all indoor units			m	30	30	45
Max. installation length for 1 indoor unit			m	15	15	15
Max. level difference between indoor and outdoor unit	Outdoor unit is higher than indoor	m	10	10	10	
	Outdoor unit is lower than indoor	m	10	10	10	
Max. level difference between indoor units			m	20	20	20
Compressor type				Rotary DC	Rotary DC	Rotary DC
Type of outdoor unit power supply			V-Hz, Ø	220-240~ 50, 1f	220-240~ 50, 1f	220-240~ 50, 1f
Current protection			A	B16	B16	B16
Power cables: outdoor unit	L < 20 m	pcs × mm²	3 × 1,5	3 × 1,5	3 × 1,5	
Control and power cables: unit external - internal			pcs × mm²	4 × 1,0	4 × 1,0	4 × 1,0
Outdoor operating range (cooling / heating)			°C	-15~50 / -20~24	-15~50 / -20~24	-15~50 / -20~24
Compatible systems						
1:1 SINGLE						
1:2 DUAL						
1:X MULTI S-LINE						
1:X MULTI N-LINE				•	•	•
1:X MULTI HP-LINE						

H - High; M - Medium; L - Low

\* Selected IDU 18K models require a 1/2 > 3/8 reduction

Model				Hiro N 9,4 kW	Hiro N 11,8 kW
Capacity	Cooling	Nom. (Min. - Max.)	W	9378 (1443-10439)	11809 (1554-13100)
Rated input		Nom. (Min. - Max.)	W	2765 (410-3500)	3812 (730-5400)
Operating current		Nom. (Min. - Max.)	A	12,0 (1,8-15,2)	16,6 (3,2-23,5)
Capacity	Heating	Nom. (Min. - Max.)	W	9378 (2318-11290)	12309 (1782-13730)
Rated input		Nom. (Min. - Max.)	W	2547 (510-3500)	3686 (800-5400)
Operating current		Nom. (Min. - Max.)	A	11,1 (2,2-15,2)	16,1 (3,5-23,5)
Reversible heat pump type				air-to-air	air-to-air
Design load in cooling mode			kW	9,3	12,2
SEER			W/W	6,1	6,1
Energy efficiency class - cooling				A++	A++
Annual electric energy consumption - cooling			kWh/a	534	700
Design load in heating mode (Tbiv -7°C)			kW	7,3	9,5
SCOP			W/W	4,0	4,0
Energy efficiency class - heating				A+	A+
Annual electric energy consumption - heating			kWh/a	2555	3325
Maximum energy consumption			W	3500	5400
Maximum operating current			A	15,2	23,5
Outdoor unit				HN90Xm4	HN120Xm5
EAN product code				5905567606571	5905567606588
Fan speed	H / M / L	rpm	850 / 750 / 700	900 / 800 / 700	
Maximum air flow			m³/h	4000	4000
Sound pressure level			dB(A)	60	60
Sound power level			dB(A)	70	70
Net dimensions	W × D × H	mm	1010 × 380 × 910	1010 × 380 × 910	
Gross dimensions	W × D × H	mm	1030 × 430 × 950	1030 × 430 × 950	
Bracket spacing	W × D	mm	600 × 375	600 × 375	
Net weight / Gross weight			kg	68 / 80	73 / 85
Refrigerant	Type		R32	R32	
	GWP		675	675	
	Factor quantity	kg	2,2 (up to 20 meters)	3,0 (up to 25 meters)	
		TCO <sub>2</sub> eq	1,49	2,03	
Additional quantity		g/m	15 (over 20 meters)	15 (over 25 meters)	
Pipe connections	Liquid / Gas	mm (inch)	4 × Ø6,35 / Ø9,52 (4 × 1/4" / 3/8")	5 × Ø6,35 / Ø9,52 (5 × 1/4" / 3/8")	
Max. number of connected indoor units			pcs	4	5
Max. installation length for all indoor units			m	60	75
Max. installation length for 1 indoor unit			m	15	15
Max. level difference between indoor and outdoor unit	Outdoor unit is higher than indoor	m	10	10	
	Outdoor unit is lower than indoor	m	10	10	
Max. level difference between indoor units			m	20	20
Compressor type				Rotary DC	Rotary DC
Type of outdoor unit power supply			V-Hz, Ø	220-240~ 50, 1f	220-240~ 50, 1f
Current protection			A	B20	B25
Power cables: outdoor unit	L < 20 m	pcs × mm²	3 × 2,5	3 × 4,0	
Control and power cables: unit external - internal			pcs × mm²	4 × 1,0	4 × 1,0
Outdoor operating range (cooling / heating)			°C	-15~50 / -20~24	-15~50 / -20~24
Compatible systems					
1:1 SINGLE					
1:2 DUAL					
1:X MULTI S-LINE					
1:X MULTI N-LINE					
1:X MULTI HP-LINE					

H - High; M - Medium; L - Low

\* Selected IDU 18K models require a 1/2 > 3/8 reduction

A photograph of a man with a beard and short dark hair, wearing a light-colored ribbed sweater, laughing heartily. He is sitting on a grey sofa. A young girl with long brown hair, wearing a white shirt, is leaning over his shoulder from behind, smiling. A young boy with blonde hair, wearing a blue and white striped shirt, is leaning towards him from the right, also smiling. The background is a bright, out-of-focus interior space with white curtains.

Remembers everything  
**that matters to you**

---

# WE ARE ROTENSO



Wireless controllers that allow you to conveniently control the operation of Rotenso air conditioners. All controllers have a wide range of functions.



Feature	Button	SETU	ANZU	FIRA	LINO	PAKO	DEFO	DEPO	GOTE	LEAF
Turn on/off	On / Off	●	●	●	●	●	●	●	●	●
SMART Follow function	Follow me / I feel	●	●	●	●	●	●	●	●	●
Select operating modes settings	Mode	●	●	●	●	●	●	●	●	●
Select operating time settings	Timer	●	●	●	●	●	●	●	●	●
Select fan speed modes	Fan speed	●	●	●	●	●	●	●	●	●
Select airflow direction	Swing	●	●	●	●	●	●	●	●	●
Select temperature	+ - / ^ v	●	●	●	●	●	●	●	●	●
Turn on/off panel display	Display / LED	●	●	●	●	●	●	●	●	●
Turbo mode	Turbo	●	●	●	●	●	●	●	●	●
Silent mode	Silence	●	●	●	●	●	●	●	●	●
Silence mode	Mute	●	●	●	●	●	●	●	●	●
Sleep mode	Sleep	●	●	●	●	●	●	●	●	●
Automatic louvre swinging mode	Swing	●	●	●	●	●	●	●	●	●
Heating 8°C mode	FP 8°C	●	●	●	●	●	●	●	●	●
Heating 12°C mode	FP 12°C							●		
Eco mode	Eco	●		●	●		●	●	●	●
Fresh air supply	Fresh Air									●
Individual louvre control	Swing	●	●	●	●		●	●	●	●
Downwards cascade air supply	Cascade DOWN			●						
Upwards cascade air supply	Cascade UP			●						
SMART Eye Away	Breeze Away Mode						●	●		
SMART Eye Follow	Wind Follow							●		
SMART Eco Eye	Smart Eco Eye						●			
Automatic purification iAIR	Self clean		●			●		●	●	●
Automatic purification iClean	Active clean	●		●	●		●		●	●
Super ionizer iAIR	Fresh / Health	●	●	●	●	●	●	●	●	●
UV lamp	Health								●	●
Automatic 4D louvres	HL / VL	●	●	●	●	●	●	●	●	●
Windless eMOTO mode	Fan + Mute								●	●
SMART twilight sensor	Led									
Humidity sensor	Humidity						●	●		
Select weekly schedule	Week timer									
Simultaneous control of up to 16 units	-									
Button lock	Lock	●	●	●	●	●	●	●	●	●
Remote control lock	RC lock									
<b>Compatible models</b>										
MIRAI								● <sup>(2)</sup>		
FRESH										●
VERSU MIRROR R15, VERSU CLOTH, VERSU PURE				●						
REVIQ							●			
TETA, TETA MIRROR									●	
ELIS, ELIS SILVER									●	
IMOTO			●							
UKURA, UKURA H			●							
RONI									●	
TENJI CC					● <sup>(2)</sup>					
TENJI CS					● <sup>(1)</sup>					
ANERU, ANERU HP		●								
ANERU AN									●	
JATO		●								
NEVO		○								

● - standard equipment; ○ - optional equipment

1. Applies to Models with revision R16 or higher. 2. Applies to models with revision R14 and R15. 3. Applies to models with revision R15.

The SMART Wi-Fi modem allows you to conveniently control the operation of Rotenso air conditioners remotely using a tablet or smartphone both inside and outside the home. Each Indoor unit requires the use of an individual module. We can operate all air conditioners using a single application dedicated to a specific module.



Feature	Button	SMART WI-FI REF	SMART WI-FI T	SMART WI-FI SCREEN PCB	SMART WI-FI X	SMART WI-FI CAC	SAVA X WI-FI
Turn on/off	On / Off	●	●	●	●	●	●
SMART Follow function	Follow me / I feel						●
Select operating modes settings	Mode	●	●	●	●	●	●
Select operating time settings	Timer	●	●	●	●	●	●
Select fan speed modes	Fan speed	●	●	●	●	●	●
Select airflow direction	Swing	●	●	●	●	●	●
Select temperature	+ - / ^ v	●	●	●	●	●	●
Turn on/off panel display	Display / LED	●	●	●			
Turbo mode	Turbo	●	●	●	●	●	●
Silent mode	Silence / Buzzer	●	●	●	●		
Silence mode	Mute	●	●	●			
Sleep mode	Sleep	●	●	●	●	●	●
Automatic louvre swinging mode	Swing	●	●	●	●	●	●
Heating 8°C mode	FP 8°C / Heater	●	●	●	●	●	●
Heating 12°C mode	FP 12°C						
Eco mode	Eco	●	●	●	●	●	●
Fresh air supply	Fresh Air			●			
Individual louvre control	Swing				●		
Downwards cascade air supply	Cascade DOWN				●		
Upwards cascade air supply	Cascade UP				●		
SMART Eye Away	Breeze Away Mode				●		
SMART Eye Follow	Wind Follow				●		
SMART Eco Eye	Smart Eco Eye				●		
Automatic purification iAIR	Self clean / Anti-Mildew	●	●	○			
Automatic purification iClean	Active clean / Evaporator	●	●	●	●		
Super Ionizer iAIR	Fresh / Health	●	●	●			
UV lamp	Health	●	●	●			
Automatic 4D louvres	HL / VL	●	●	●	●		
Windless eMOTO mode	Fan + Mute / Soft Wind	●	●	●			
SMART twilight sensor	Led	○	○	○			
Humidity sensor	Humidity				○		
Select weekly schedule	Week timer	●	●	●	●	●	●
Simultaneous control of up to 16 units	-						
Cooling mode locking	-						
Cooling mode locking	-						
Button lock	Lock						
Remote control lock	RC lock						
Compatible models / Application		SmartLife-SmartHome / Tuya SMART			NetHome Plus		
MIRAI					●		
FRESH				●			
VERSU MIRROR R15, VERSU CLOTH, VERSU PURE					●		○
REVI0					●		○
TETA, TETA MIRROR			●				
ELIS, ELIS SILVER		●					
IMOTO					●		
UKURA, UKURA H					●		
RONI		●					
ANERU, ANERU HP					●		○
ANERU AN		●					
TENJI CC					● <sup>(1)</sup>	○	○
TENJI CS					●	○	○
JATO						○	○
NEVO						○	● <sup>(1)</sup>

● - standard equipment; ○ - optional equipment

1. Applies to models with revision R15 or higher.

Control system that allows individual control of the indoor unit. From the wired controller, you can manage all available functions of the air conditioner. The SAVA controller offers one-week programming for up to eight periods per day containing operating time, mode and desired temperature.



Features	Button	SAVA X	SAVA X WI-FI	SAVA XD WI-FI	SAVA X WM	LOKA HAHB	ZATO X
Turn on/off	On / Off	●	●	●	●	●	●
SMART Follow function	Follow me / I feel	●	●	●	●	●	●
Select operating modes settings	Mode	●	●	●	●	●	●
Select operating time settings	Timer	●	●	●	●	●	●
Select fan speed modes	Fan speed	●	●	●	●	●	●
Select airflow direction	Swing	●	●	●	●	●	●
Select temperature	+ - / ^ v	●	●	●	●	●	●
Turn on/off panel display	Display / LED						
Turbo mode	Turbo	●	●	●	●	●	
Silent mode	Silence						
Silence mode	Mute	●	●	●	●	●	
Sleep mode	Sleep						
Automatic louvre swinging mode	Swing	●	●	●	●	●	●
Heating 8°C mode	FP 8°C	●	●	●	●		●
Heating 12°C mode	FP 12°C						
Eco mode	Eco						
Fresh air supply	Fresh Air						
Individual louvre control	Swing	● <sup>(4)</sup>	● <sup>(4)</sup>	● <sup>(5)</sup>		○ <sup>(4)</sup>	
Downwards cascade air supply	Cascade DOWN						
Upwards cascade air supply	Cascade UP						
SMART Eye Away	Breeze Away Mode						
SMART Eye Follow	Wind Follow						
SMART Eco Eye	Smart Eco Eye						
Automatic purification iAIR	Self clean						
Automatic purification iClean	Active clean						
Super Ionizer iAIR	Fresh / Health						
UV lamp	Health						
Automatic 4D louvres	HL / VL						
Breeze Away eMoto	BA						
Windless eMOTO mode	Fan + Mute						
SMART twilight sensor	Led						
Humidity sensor	Humidity						
Select weekly schedule	Week timer	●	●	●	●	●	
Simultaneous control of up to 16 units	-	○ <sup>(1)</sup>	○ <sup>(1)</sup>	○ <sup>(1)</sup>		○ <sup>(9)</sup>	
Button lock	Lock	●	●	●	●	●	
Group operation management	Group Control			○ <sup>(1)</sup>		●	
Built-in Wi-Fi module	WIFI		●	●			
<b>Compatible models</b>							
MIRAI					○ <sup>(2)</sup>		○ <sup>(3)</sup>
FRESH							
VERSU MIRROR R15, VERSU CLOTH, VERSU PURE		○ <sup>(2)</sup>	○ <sup>(2)</sup>	○ <sup>(2)</sup>			
REVIO		○ <sup>(2)</sup>	○ <sup>(2)</sup>	○ <sup>(2)</sup>			
TETA, TETA MIRROR							
ELIS, ELIS SILVER							
IMOTO					○ <sup>(2)</sup>		○ <sup>(3)</sup>
UKURA, UKURA H							○ <sup>(3)</sup>
RONI							
ANERU, ANERU HP		○ <sup>(2)</sup>		○ <sup>(2)</sup>		○ <sup>(2)</sup>	
ANERU AN							
TENJI CC		○	○ <sup>(1)</sup>	○ <sup>(1)</sup>		○ <sup>(1)</sup>	
TENJI CS		○ <sup>(5)</sup>	○	○ <sup>(5)</sup>		○ <sup>(7)</sup>	
JATO		○	○ <sup>(1)</sup>	○ <sup>(1)</sup>		○ <sup>(1)</sup>	
NEVO		○		●		○ <sup>(1)</sup>	

● - standard equipment; ○ - optional equipment

1. Additional SAVA CS module required for each indoor unit for Group operation;
2. Required additional MFBR multiplication module for individual control;
3. Required additional ZATO module for individual control;
4. Function available on T21Xi-T50Xi cassette units (R15 revision and above) and T70Xi-T160Xi;
5. Except for TENJI T70Xi-T160X models with R14 revision;
6. For Tenji T70Xi-T160X models with R14 revision as an individual driver directly to the HAHB port;
7. Exclusively for R14 revision as a group operation controller without an additional module;
8. The use of ZATO controller excludes the use of WIFI module at the same time.
9. Without additional group operation module on Tenji T70Xi-T160X models with R14 revision.
10. Function available from the optional wireless remote controller SETU.

Manage the operation of up to 64 Indoor units with a maximum control cable length of up to 1200 m.  
Allows control of a selected Indoor unit or all units simultaneously.

RSCPT controller additionally allows weekly programming of up to four periods per day containing operating time, mode and desired temperature.



Features	Button	RSC	RSCPT
Turn on/off	On / Off	●	●
SMART Follow function	Follow me / I feel		
Select operating modes settings	Mode	●	●
Select operating time settings	Timer	●	●
Select fan speed modes	Fan speed	●	●
Select airflow direction	Swing	●	●
Select temperature	+ - / ^ v	●	●
Turn on/off panel display	Display / LED		
Turbo mode	Turbo		
Silent mode	Silence		
Silence mode	Mute		
Sleep mode	Sleep		
Automatic louvre swinging mode	Swing	●	●
Heating 8°C mode	FP 8°C		
Heating 12°C mode	FP 12°C		
Eco mode	Eco		
Individual louvre control	Swing		
SMART Eye	Smart Eye		
SMART Eco Eye	Eco Smart Eye		
Automatic cleaning iAIR	Self clean		
Automatic cleaning iClean	Active clean		
Super ionizer iAIR	Fresh / Health		
UV lamp	Health		
Automatic 4D louvres	HL / VL		
Breeze Away eMoto	BA		
Windless eMOTO mode	Fan + Mute		
SMART twilight sensor	Led		
Humidity sensor	Humidity		
Select weekly schedule	Week timer		●
Simultaneous control of up to 16 units	-		
Cooling mode locking	-	●	●
Button lock	Lock	●	●
Remote control lock	RC lock	●	●
Forced operation	Forced On	●	●
Emergency stop	Emergency Stop	●	●
230 V power supply	Power Supply 230V	●	●
<b>Compatible models</b>			
MIRAI		○ <sup>(1)</sup>	○ <sup>(1)</sup>
FRESH			
VERSU MIRROR R15, VERSU CLOTH, VERSU PURE		○ <sup>(1)</sup>	○ <sup>(1)</sup>
REVI0		○ <sup>(1)</sup>	○ <sup>(1)</sup>
TETA, TETA MIRROR			
ELIS, ELIS SILVER			
IMOTO		○ <sup>(1)</sup>	○ <sup>(1)</sup>
UKURA, UKURA H			
RONI			
ANERU, ANERU HP		○ <sup>(1)</sup>	○ <sup>(1)</sup>
ANERU AN			
TENJI CC		●	●
TENJI CS		●	●
JATO		●	●
NEVO		●	●

● - standard equipment; ○ - optional equipment

1. Optional equipment - additional MFBR module required.

## Dry Contact

Allows the air conditioner to be turned on/off with an external ON/OFF signal.

Application: hotel switches, window contacts, alarm control of the condensate pump, activation of the unit by thermostat.



Feature	RDCV	RDCX
IR diode	•	
Communication cable		•
<b>Connection possibilities</b>		
Door or window reed switch	•	•
Occupancy sensor	•	•
Hotel card	•	•
<b>Compatible models</b>		
MIRAI	•	
FRESH	•	
VERSU MIRROR R15, VERSU CLOTH, VERSU PURE	•	
REVIO	•	
TETA, TETA MIRROR	•	
ELIS, ELIS SILVER	•	
IMOTO	•	•
UKURA, UKURA H	•	
RONI	•	
TENJI CC	•	
TENJI CS	•	
JATO	•	
NEVO	•	
ANERU, ANERU HP	•	
ANERU AN	•	

• - standard equipment; o - optional equipment

## MFBR multifunction module



Equipped with a potential-free on/off contact and an output to the control panel. Allows you to extend the functionality of the air conditioner with a communication port for the BMS Modbus signal or by connecting additional devices such as a central or individual controller. At the same time, a Wi-Fi Module or MFBR Multifunction Module can be connected to the wall-mounted air conditioner.

Feature	MFBR MIRAI	MFBR VERSU R15	MFBR REVIO	MFBR IMOTO	MFBR ANERU XYE	MFBR ANERU HAHB
Wired controller weekly SAVA X WM	•			•		
Wired controller weekly SAVA X		•	•		•	
Wired controller weekly SAVA X WI-FI		•	•		•	
Wired controller weekly SAVA CS HAHB						•
XYE communication port for Modbus BMS gateway	•	•	•	•	•	
Central controller RSC	•	•	•	•	•	
Weekly central controller RSCPT	•	•	•	•	•	
Permission contact ON/OFF	•	•	•	•	•	•
Rotenso turnout controller AOC4WRB	•	•	•	•	•	•
<b>Compatible models</b>						
MIRAI	•					
VERSU [R15]		•				
REVIO			•			
IMOTO				•		
ANERU, ANERU HP					•	

• - standard equipment; o - optional equipment

## Alternating operation controller

Controller with touch display and intuitive menu in Polish language, which allows controlling the operation of up to four air conditioners in rotary (turn/ alternate) mode without using a computer. An additional advantage is temperature monitoring and a built-in alarm that sounds if the set temperature threshold is exceeded.

Depending on the version of the device, you can control the operation of the air conditioners with ON/OFF signal by wire or wireless. Ideal for technical rooms such as: server rooms or transistor rooms.

AOC4WRB - wired control via ON/OFF relays

AOC4IRB - wirelessly using IRDA infrared transmitters with ON/OFF signals.



Feature	AOC4IRB	AOC4WRB
IR diode IRDA	●	
Wired via relays		●
<b>Connection possibilities</b>		
Temperature sensor	●	●
Temperature monitoring	●	●
Built-in alarm contact	●	●
<b>Compatible models</b>		
MIRAI	●	○ <sup>(2)</sup>
FRESH	●	
VERSU MIRROR R15, VERSU CLOTH, VERSU PURE	●	○ <sup>(2)</sup>
REVIO	●	○ <sup>(2)</sup>
TETA, TETA MIRROR	●	
ELIS, ELIS SILVER	●	
IMOTO	●	○ <sup>(2)(3)</sup>
UKURA, UKURA H	●	
RONI	●	
TENJI CC	●	●
TENJI CS	●	●
JATO	●	●
NEVO	●	●
ANERU, ANERU HP	●	○ <sup>(2)</sup>
ANERU AN	●	

● - standard equipment; ○ - Optional equipment

2. Optional equipment - additional MFBR module required (wired connection) 3. Optional equipment - additional RDCX module (wired connection) required

## Modbus 64 gateway module – BMS / BRIDGE

A single gateway allows integration of up to 64 air conditioners via RTU and TCP/IP communication protocol with the BMS Modbus building management system.











Feature / compatibility with models	MIRAI	VERSU R15	REVIO	IMOTO	TENJI	JATO	NEVO	ANERU, ANERU HP
Modbus protocol network support	●	●	●	●	●	●	●	●
Built-in web server function	●	●	●	●	●	●	●	●
Ability to connect up to 64 air conditioners into a single gateway	●	●	●	●	●	●	●	●
Required use of MFBR XYE module	●	●	●	●	●	●	●	●

● - standard equipment; ○ - optional equipment

## Expansion manifold

Allows the connection of multiple ducts supplying or distributing air from duct equipment. Additionally expands the air Compatible with Nevo ducted units from the R15 revision.

	N26Xi	N35Xi	N50Xi	N70Xi	N90Xi	N100Xi	N120Xi	N140Xi	N160Xi
									
<b>Exhaust / Air intake</b>									
Number of spigots	3	3	3	3	3	3	3	3	3
Diameter of spigots (fi)	160	160	160	160	160	200	200	200	200
Exhaust / Air intake	XRRW21-26-35	o	o						
	XRRW50			o					
	XRRW70-90				o	o			
	XRRW100-120-140						o	o	o
	XRRW160								o
<b>Air supply</b>									
Number of spigots	3	3	3	3	3	3	3	3	3
Diameter of spigots (fi)	125	125	125	160	160	160	160	160	160
Air supply	XRRN21-26-35	o	o						
	XRRN50			o					
	XRRN70-90				o	o			
	XRRN100-120-140						o	o	o
	XRRN160								o

● - standard equipment; o - optional equipment

## SMART diagnostic module



The advanced SMART diagnostic interface allows you to read the current operating parameters of air conditioners and their diagnostics. In addition, it allows you to manually control individual components of the Outdoor unit and view unit parameters.

Compatibility	MIRAI	VERSU	REVIQ	IMOTO	UKURA, UKURA H	ANERU, ANERU HP	TENJI	NEVO	JATO	UNICO	HIRO S-Line
Current compressor operating frequency	●	●	●	●	●	●	●	●	●	●	●
Exchanger temperature indoor unit	●	●	●	●	●	●	●	●	●	●	●
Exchanger temperature outdoor unit	●	●	●	●	●	●	●	●	●	●	●
Air-to-air temperature of Indoor unit	●	●	●	●	●	●	●	●	●	●	●
Outside unit temperature	●	●	●	●	●	●	●	●	●	●	●
Discharge temperature	●	●	●	●	●	●	●	●	●	●	●
Refrigerant return temperature to the outdoor unit	●	●	●	●	●	●	●	●	●	●	●
Target operating frequency of the compressor	●	●	●	●	●	●	●	●	●	●	●
Operating current of the unit	●	●	●	●	●	●	●	●	●	●	●
Outdoor unit supply voltage (IPM module)	●	●	●	●	●	●	●	●	●	●	●
Highest value of supply voltage	●	●	●	●	●	●	●	●	●	●	●
Set temperature	●	●	●	●	●	●	●	●	●	●	●
EEV valve opening	●	●	●	●	●	●	●	●	●	●	●
Operating mode	●	●	●	●	●	●	●	●	●	●	●
Indoor unit operating mode	●	●	●	●	●	●	●	●	●	●	●
Load on the outdoor unit	●	●	●	●	●	●	●	●	●	●	●
Indoor unit error	●	●	●	●	●	●	●	●	●	●	●
Outdoor unit error	●	●	●	●	●	●	●	●	●	●	●
Fan speed outdoor unit	●	●	●	●	●	●	●	●	●	●	●

● - standard equipment; o - optional equipment

## BLACK and RAL panels

To meet the ever-increasing expectations of our customers, air conditioning equipment manufacturer Rotenso has introduced cover panels for TENJI cassette units as optional accessories in black or any other RAL color. The panels are available upon advance order.



Compatibility	TCCX2p BLACK	TSCX2p BLACK
TENJI CC series "X" 620 × 620	•	
TENJI CS series "X" 950 × 950		•



Compatibility	TCCX2p RAL	TSCX2p RAL
TENJI CC series "X" 620 × 620	•	
TENJI CS series "X" 950 × 950		•

## RVF-RDIX distributor

A set of two distributors (for gas and liquid pipe) used for Rotenso's DUAL and RVF systems. All Rotenso distributors to be used in several size ranges for self-cutting. Dedicated thermal insulation is included, which significantly speeds up and facilitates the processing of the installation.

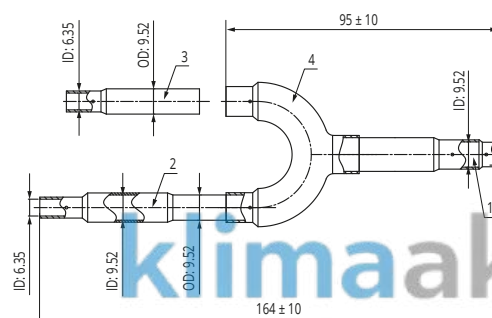
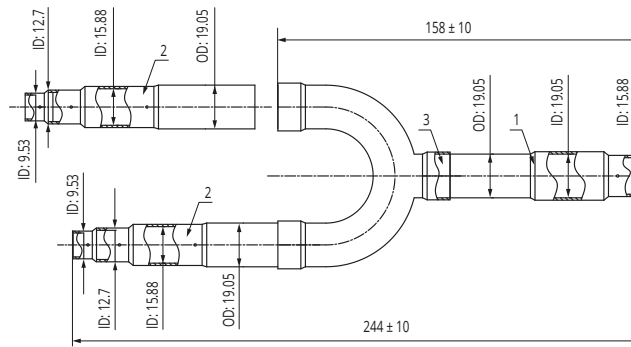
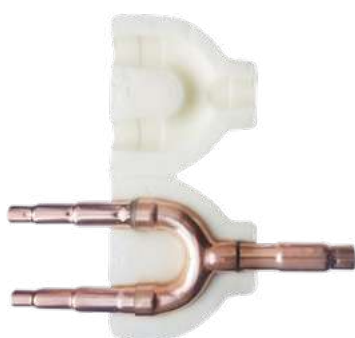

# for air handling units

With AHUBOX modules, it is possible to connect Rotenso outdoor units to freon coolers/heaters in air handling units. Rotenso outdoor units, together with the air handling unit connection module, create an ideal solution to operate in cooling and heating modes. One air handling unit requires at least one AHU kit.



## RAHU condensing units

Communication module RCU-AHUBOX-1C works with Outdoor units of Imoto I26Xo, I35Xo, I50Xo, I70Xo series and Unico UO90Xo, UO100Xo, UO120Xo, UO140Xo, UO160Xo series inverter units of 2,6 kW to 15,2 kW.

Cooling/Heating mode is controlled by a 0-10V voltage signal in the capacity range from 0 to 100%.

The module is equipped with a defrost and alarm mode control output.

Air handling unit connection module			RCU-AHUBOX-1C								
Outdoor unit model			Imoto I26Xo	Imoto I35Xo	Imoto I50Xo	Imoto I70Xo	Unico UO90Xo	Unico UO100Xo	Unico UO120Xo	Unico UO140Xo	Unico UO160Xo
Capacity		kW	2,6	3,5	5,3	7,0	8,8	10,6	12,1	14,1	15,2
Diameter of connections	Liquid	mm	Φ6,35	Φ6,35	Φ6,35	Φ9,52	Φ9,52	Φ9,52	Φ9,52	Φ9,52	Φ9,52
	Gas	mm	Φ9,52	Φ9,52	Φ12,7	Φ15,9	Φ15,9	Φ15,9	Φ15,9	Φ15,9	Φ15,9
Control			0 - 10V	0 - 10V	0 - 10V	0 - 10V	0 - 10V	0 - 10V	0 - 10V	0 - 10V	0 - 10V
Power supply	V-Hz, Ø		220-240-50, 1f				380-420-50, 3f		220-240-50, 1f		380-420-50, 3f
Power cables: outdoor unit	pcs × mm <sup>2</sup>		3 × 1,5	3 × 1,5	3 × 2,5	3 × 2,5	3 × 2,5	5 × 2,5	3 × 2,5	5 × 2,5	5 × 2,5
Control and power wires: outdoor unit × mm 2 - RCU	pcs × mm <sup>2</sup>		4 × 1,5	4 × 1,5	4 × 1,5	4 × 1,5	4 × 1,5	4 × 1,5	4 × 1,5	4 × 1,5	4 × 1,5
Control wires: control unit - RCU	pcs × mm <sup>2</sup>		10 × 0,25	10 × 0,25	10 × 0,25	10 × 0,25	10 × 0,25	10 × 0,25	10 × 0,25	10 × 0,25	10 × 0,25

Notes:  
 1. Requires a 0-10V control signal from the air handling unit and a closed/open signal to switch heating/cooling operating modes.  
 2. S1 Communication

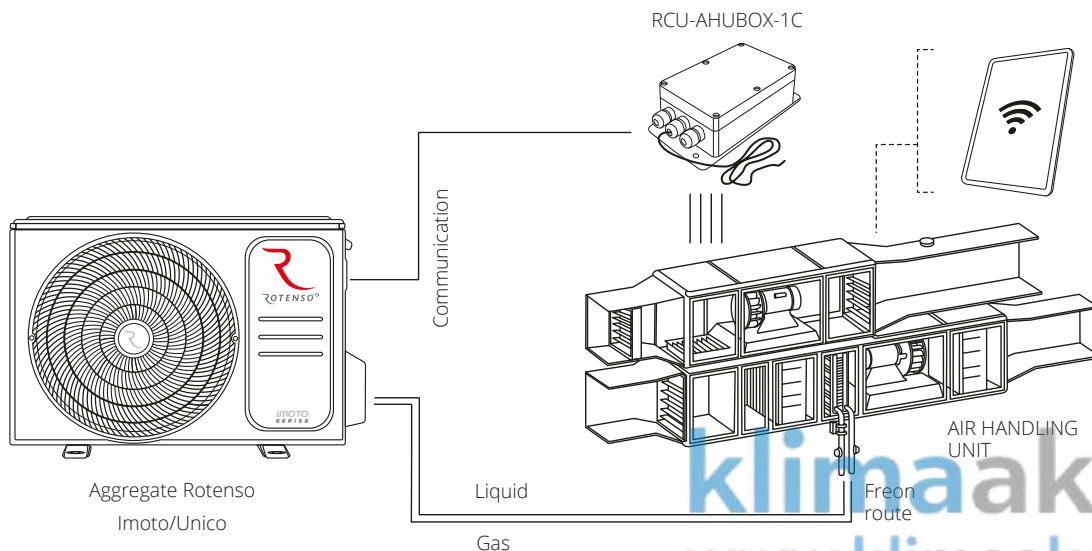

The RVF-AHU-KIT module works with Outdoor units of the V-STAGE, miniRVF and RVF series with a capacity of 10 kW to 244 kW. It allows the connection of up to four RVF-AHU-EXV expansion valves, which serve the freon exchangers of any manufacturer's air handling unit. RVF-AHU-KIT module can automatically manage Cooling or Heating operation modes, control can be done by 0-10V voltage signal in Capacity Range from 0 to 100% or by permission signal from controller in combination with temperature sensors included in the kit. It is equipped with a control output for defrost and alarm mode. The AHU module has a built-in expansion valve, temperature sensors, controller and complete automation. One air handling unit requires at least one AHU kit.

Model			RVF-AHU-KIT	RVF-AHU-EXV-2-8	RVF-AHU-EXV-9-20	RVF-AHU-EXV-22-40	RVF-AHU-EXV-45-61
Capacity		kW	-	2 - 8	9 - 20	22 - 40	45 - 61
Pipe connections	Liquid input	mm (inch)	-	Φ9,52 (3/8")	Φ9,52 (3/8")	Φ12,7 (1/2")	Φ15,9 (5/8")
	Liquid output	mm (inch)	-	Φ9,52 (3/8")	Φ9,52 (3/8")	Φ12,7 (1/2")	Φ15,9 (5/8")
Control			0-10V	0-10V	0-10V	0-10V	0-10V
Power supply		V-Hz, Ø	220-240-50, 1f	220-240-50, 1f	220-240-50, 1f	220-240-50, 1f	220-240-50, 1f
Cables	Communication PQE	pcs × mm <sup>2</sup>	2 × 0,75-1,0 (shielded)				
	Power supply	pcs × mm <sup>2</sup>	3 × 1,0				
Net dimensions	W × D × H	mm	347 × 245 × 73	212 × 276 × 71	212 × 276 × 71	212 × 276 × 71	212 × 276 × 71
Gross dimensions	W × D × H	mm	385 × 280 × 175	240 × 335 × 135	240 × 335 × 135	240 × 335 × 135	240 × 335 × 135
Net weight / Gross weight		kg	1,7 / 2,1	1,8 / 2,2	1,8 / 2,2	1,8 / 2,2	3,0 / 4,6

RVF-AHU module works with all Outdoor units of the RVF series with a capacity from 10 kW to 244 kW. It allows you to connect the Freon exchanger of the air handling unit of any manufacturer and control the Cooling or Heating mode. Control is provided by a 0-10V voltage signal in the Range of Capacity from 0 to 100% or by a permission signal from the controller in combination with temperature sensors, which are included in the kit for RVF-AHU-KIT. The RVF-AHU-KIT module supports up to four RVF-AHU-EXV valves, has a defrost and alarm mode control output, temperature sensors, controller and complete automation included. The RVF-AHU-EXV module is an expansion valve in an ibro-insulated housing. RVF-AHU-KIT is a universal automation, supporting up to 4 pcs. RVF-AHU-EXV valves.

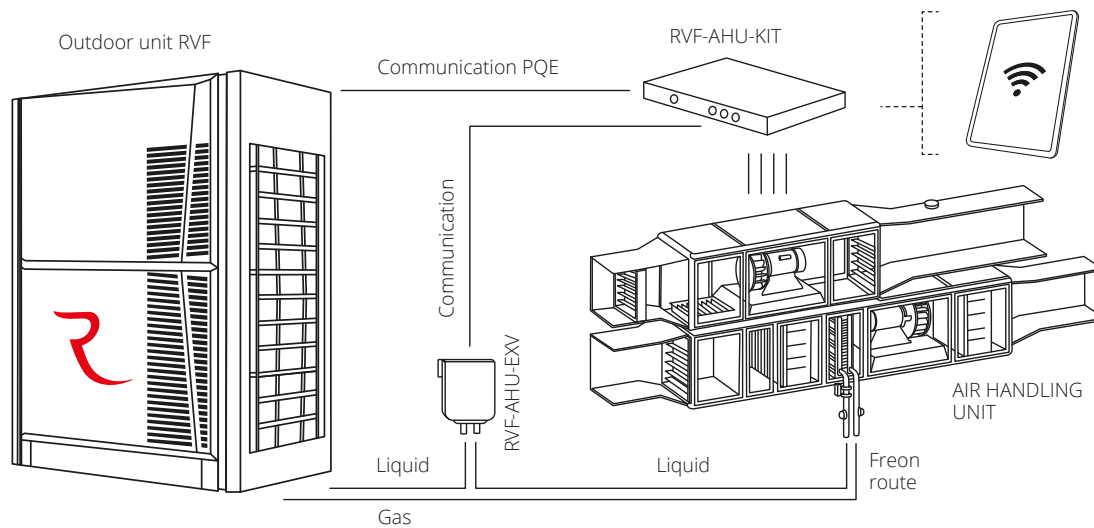

Compatibility	RCU AHUBOX1C	RVF-AHU
Cooperation with Imoto and Unico Outdoor units	●	
Cooperation with Outdoor units RVF		●
Internal expansion valve in the unit	●	
External expansion valve in the module		●
Cooling function	●	●
Heating function	●	●
Automatic change of heating/cooling modes	●	●
0-10V signal control	●	●
ON-OFF signal control		●
Additional temperature sensors		●
Additional controller		●
Additional automatics		●
Blue Fin unit		●
Gold Fin unit	●	
Compressor crankcase heater built-in	●	●
Built-in drip tray heater	●	
EVI technology		○ (*)
Heating at down to -20°C	●	
Heating at down to -30°C		● (*)

● - standard equipment; ○ - optional equipment

(\*) Range of operation depends on the outdoor unit RVF used.







[rotenso.com](https://rotenso.com)

