

# Brisk Surgical Instruments

## Product Catalog



BRISK

# Conversions

Fractional Inches	Millimeters
1/16	1.588
1/8	3.175
3/16	4.736
1/4	6.350
5/16	7.938
3/8	9.525
7/16	11.113
1/2	12.700
9/16	14.288
5/8	15.875
11/16	17.463
3/4	19.050
13/16	20.638
7/8	22.225
15/16	23.813
1	25.400

## Conversions:

### Inches to Centimeters

$$\text{cm} = \text{in} \times 2.54$$

### Centimeters to Inches

$$\text{in} = \text{cm} \times 0.3937$$

### Millimeters to Inches

$$\text{in} = \text{mm} \times 0.03937$$

## Instrument Angles

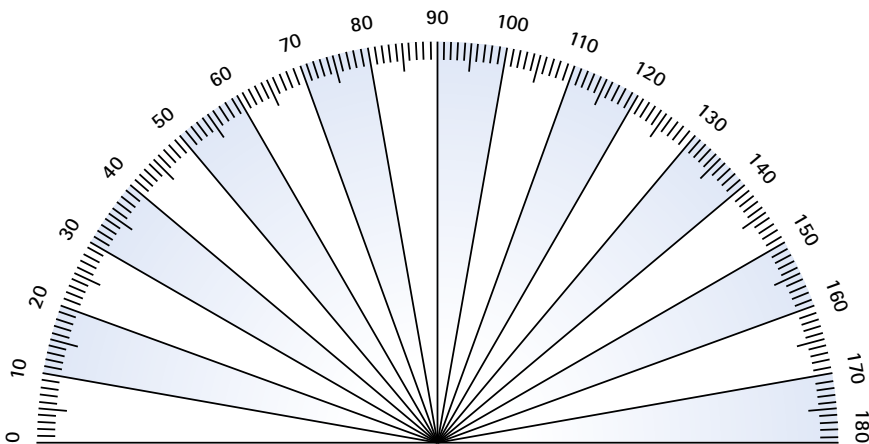

# Conversion Scales and Gauges

Conversion Scale		
To Convert From	To	Multiply
Ounces (AVDP.)	Grams	28.349523
Ounces (APOTH.)	Grams	31.103486
Grains	Grams	0.06479891
Pounds (AVDP.)	Kilograms	0.45359237
Inches	Centimeters	2.54
Feet	Meters	0.3048
Yards	Meters	0.9144
Ounces (U.S. Fluid)	Cubic Centimeters	29.573730
Ounces (British Fluid)	Cubic Centimeters	28.41305
Quarts (U.S. Fluid)	Liters	0.9463264
Cubic Inches	Cubic Centimeters	16.387064
Grams	Grains	15.432358
Grams	Ounces (AVDP.)	0.35273962
Grams	Ounces (APOTH.)	0.32150737
Kilograms	Pounds (AVDP.)	2.2046226
Millimeters	Inches	0.039370079
Centimeters	Inches	0.39370079
Meters	Feet	3.2808399
Cubic Centimeters	Cubic Inches	0.61023744
Cubic Centimeters (Fluid)	Ounces U.S. Fluid)	0.33814023
Liters	Quarts (U.S. Fluid)	1.056718

Fahrenheit and Centigrade Scales	
F.	C.
500°	260°
400	205
392	200
383	195
374	190
356	180
347	175
338	170
329	165
320	160
311	155
302	150
284	140
275	135
266	130
248	120
239	115
230	110
212	100
203	95
194	90
176	80
167	75
140	60
122	50
113	45
105	40.56
104	40
100	37.8
98.5	36.9
95	35
86	30
77	25
68	20
50	10
41	5
32	0
23	-5
14	-10
+5	-15
-4	-20
-13	-25
-22	-30
-40	-40
-76	-60
1° F. = 5/9° C.	
1.8° F. = 1° C.	
3.6° F. = 2° C.	
4.5° F. = 2.5° C.	
5.4° F. = 3° C.	

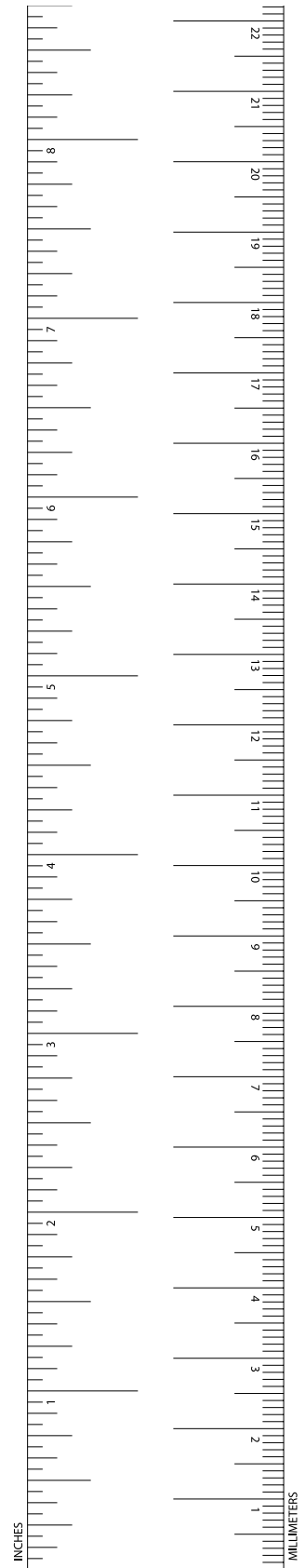

# Standard French (Charrière) Gauge

## Standard French:

The standard French or Charrière is used to measure diameters of all Bougies, Sounds, Catheters, Suction Tubes and Uterine Dilators.

### Example:

12 Fr indicates a diameter of 4 mm

21 Fr indicates a diameter of 7 mm

<i>French</i>	3	4	5	6	7	8	9	10	11	12	13	14	15
<i>American</i>				4			6			8			10
	◦	◦	◦	○	○	○	○	○	○	○	○	○	○
	1 mm			2 mm			3 mm			4 mm		5 mm	

<i>French</i>	16	17	18	19	20	22	24	26	28	30	32	34
<i>American</i>			12				16			20		
	○	○	○	○	○	○	○	○	○	○	○	○
			6 mm				8 mm			10 mm		

<i>French</i>	36	38	40	42	44	45
<i>American</i>	24					30
	○	○	○	○	○	○
	12 mm					15 mm

\* Chart is actual size

# Instrument Measurements

Illustration 1:

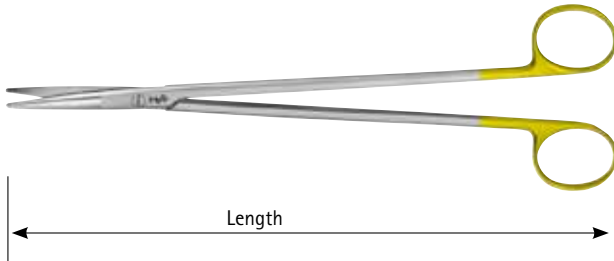

Illustration 2:

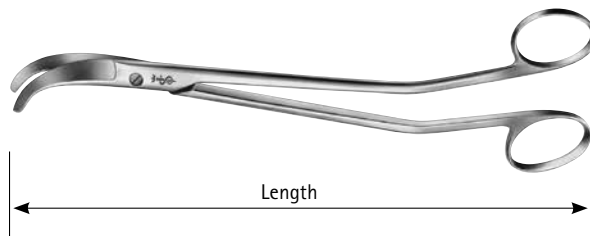

Illustration 3:

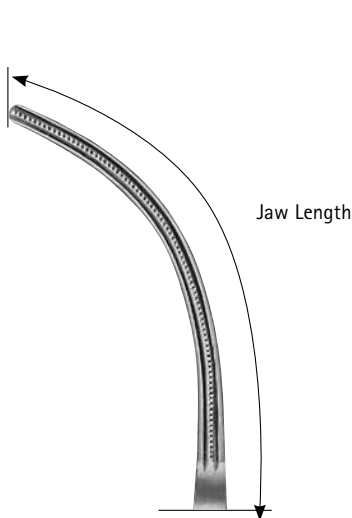
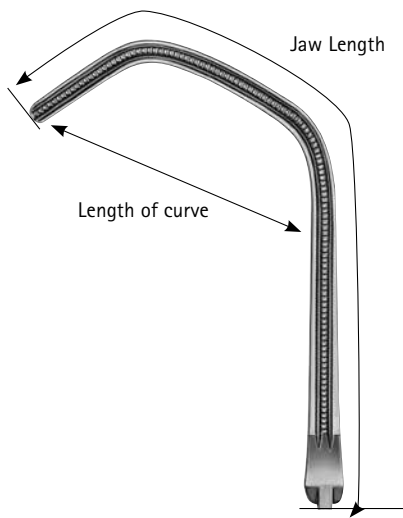

Illustration 4:



## Instrument Length:

To measure the total length of an instrument, start at the bottom of the instrument and measure to the farthest tip in a straight line (*Illustration 1*).

For curved and angled instruments, the distance of a perpendicular line drawn from the bottom of the instrument to the farthest point will determine the overall instrument length (*Illustration 2*).

## Jaw:

The jaw length of a clamp is measured from the beginning of the jaw to the bottom of the serrations (*Illustration 3*). For partial occlusion clamps, see *Illustration 4*.

Tip and jaw illustrations are approximate unless otherwise noted.

# General Surgery

## Scissors

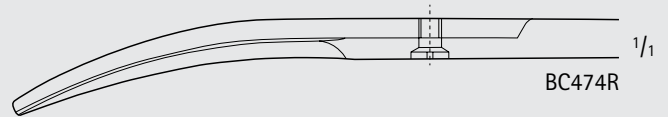
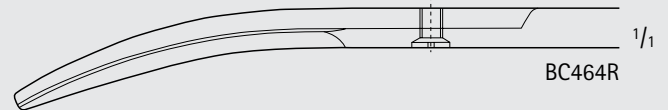
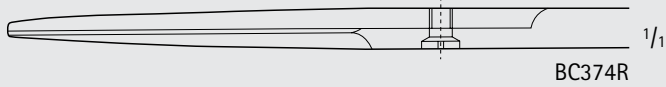

### DEAVER Suture Scissors

Catalog Number	Tip	Blade	Length (in.)
BC374R	S/B	STR	5 3/4
BC474R	S/B	CVD	5 3/4
BC464R	B/B	CVD	5 3/4

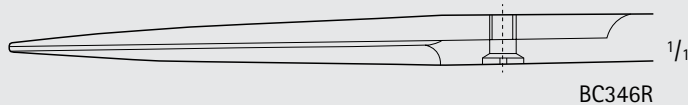
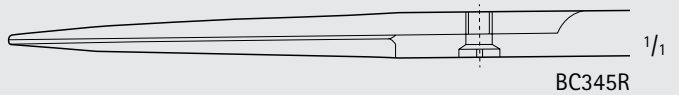
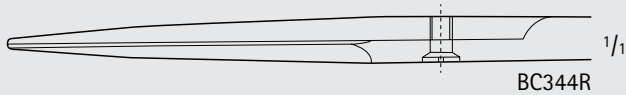
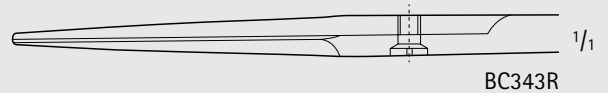
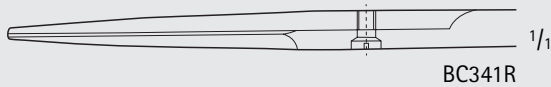
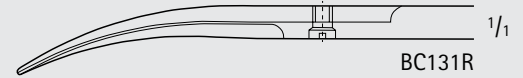
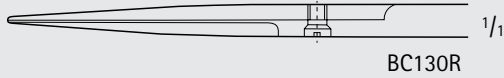

### Suture Scissors

Catalog Number	Tip	Blade	Length (in.)
BC130R	S/S	STR	4 3/4
BC341R	S/S	STR	4 1/2
BC343R	S/S	STR	5 1/8
BC344R	S/S	STR	5 3/4
BC345R	S/S	STR	6
BC346R	S/S	STR	6 1/2
BC131R	S/S	CVD	4 3/4



BC441R-BC445R

Suture Scissors

Catalog Number	Tip	Blade	Length (in.)
BC441R	S/S	CVD	4 1/2
BC443R	S/S	CVD	5 1/8
BC444R	S/S	CVD	5 3/4
BC445R	S/S	CVD	6

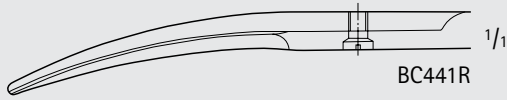

BC441R

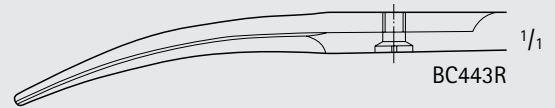

BC443R

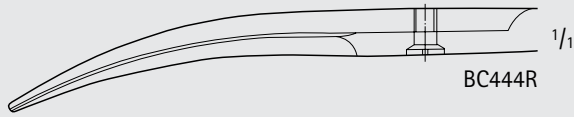

BC444R

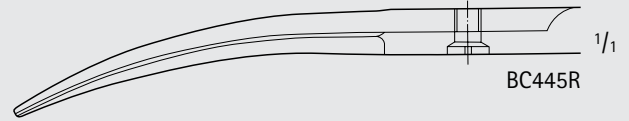

BC445R



BC303R-BC304R

Suture Scissors

Catalog Number	Tip	Blade	Length (in.)
BC303R	S/B	DEL, STR	5 1/8
BC304R	S/B	DEL, STR	5 3/4

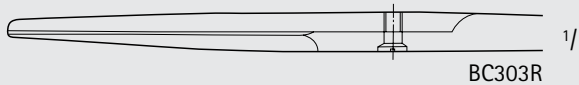

BC303R

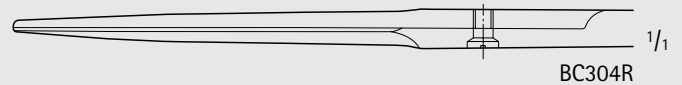

BC304R



BC496R

Scissors

Catalog Number	Tip	Blade	Length (in.)
BC496R	S/B	STR/1-SERR	5 1/8

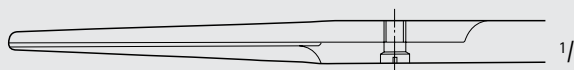

BC496R



# General Surgery

## Scissors

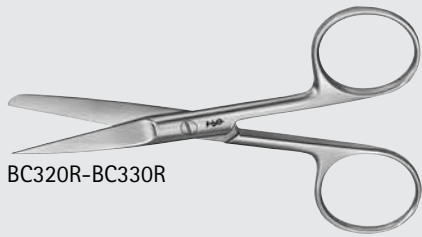

BC320R-BC330R

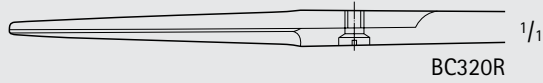

BC320R

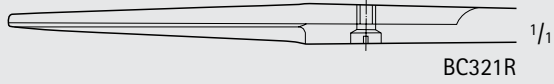

BC321R

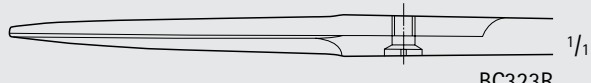

BC323R

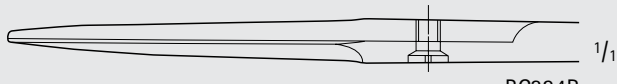

BC324R

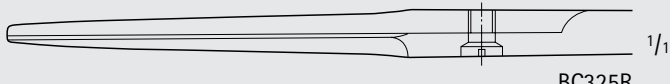

BC325R

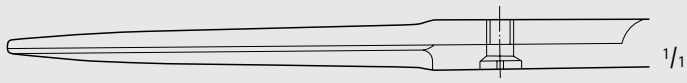

BC326R

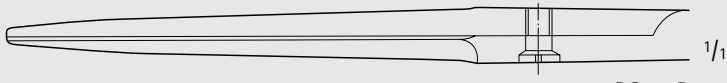

BC327R

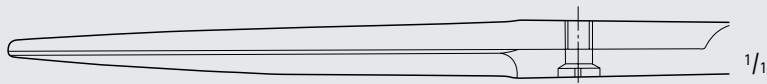

BC328R

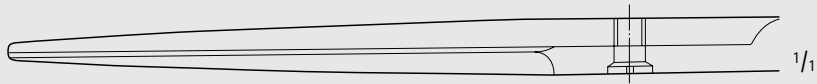

BC330R

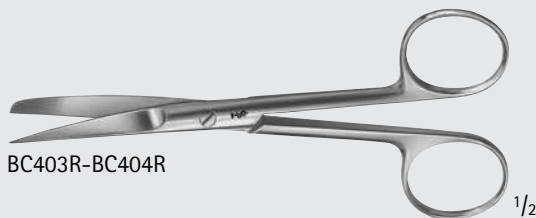

BC403R-BC404R

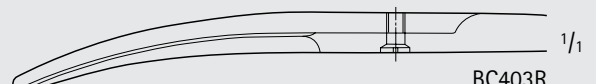

BC403R

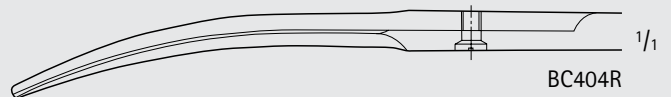

BC404R

### Suture Scissors

Catalog Number	Tip	Blade	Length (in.)
BC320R	S/B	STR	4 1/8
BC321R	S/B	STR	4 1/2
BC323R	S/B	STR	5 1/8
BC324R	S/B	STR	5 3/4
BC325R	S/B	STR	6
BC326R	S/B	STR	6 1/2
BC327R	S/B	STR	6 7/8
BC328R	S/B	STR	7 1/4
BC330R	S/B	STR	7 7/8
BC403R	S/B	CVD	5 1/8
BC404R	S/B	CVD	5 3/4

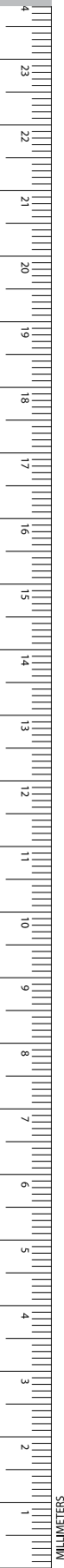



BC421R-BC428R

Suture Scissors

Catalog Number	Tip	Blade	Length (in.)
BC421R	S/B	CVD	4 1/2
BC423R	S/B	CVD	5 1/8
BC424R	S/B	CVD	5 3/4
BC425R	S/B	CVD	6
BC426R	S/B	CVD	6 1/2
BC428R	S/B	CVD	7 1/4

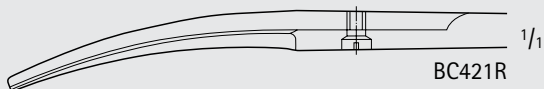

BC421R

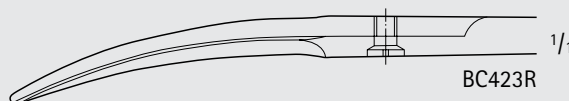

BC423R

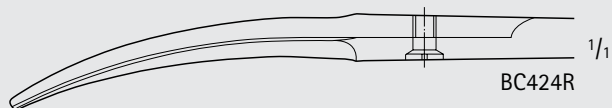

BC424R

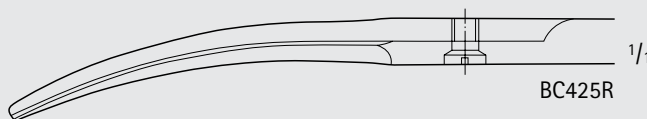

BC425R



BC426R

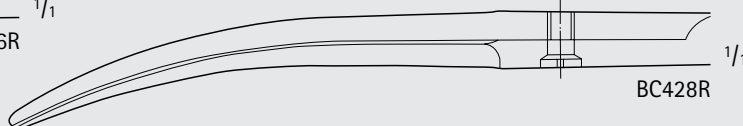

BC428R



BC135R

Suture Scissors

Catalog Number	Tip	Blade	Length (in.)
BC135R	B/B	CVD, DEL	4 3/4

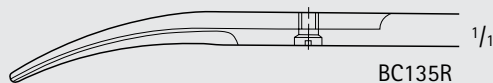

BC135R



# General Surgery

## Scissors

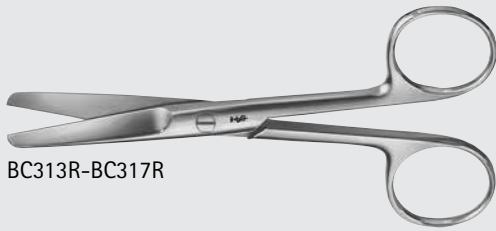

BC313R-BC317R

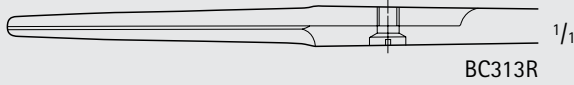

BC313R

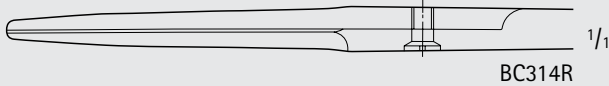

BC314R

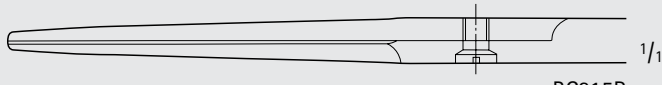

BC315R

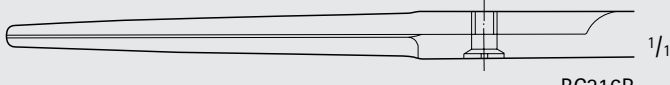

BC316R

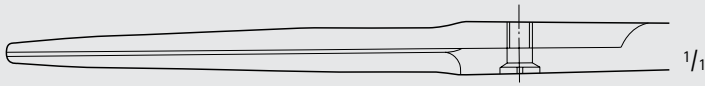

BC317R



BC411R-BC417R

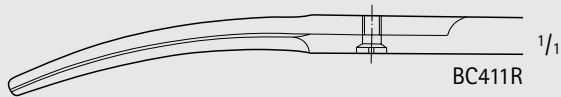

BC411R

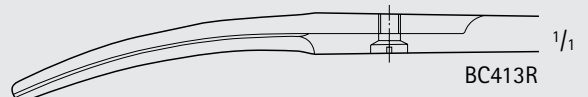

BC413R

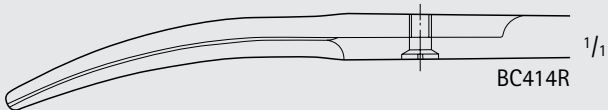

BC414R

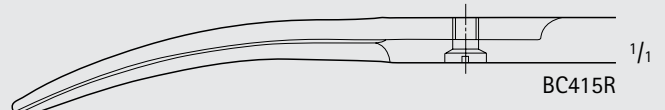

BC415R

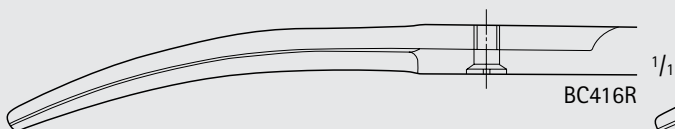

BC416R

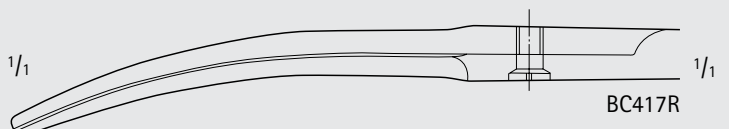

BC417R

### COOPER Suture Scissors

Catalog Number	Tip	Blade	Length (in.)
BC313R	B/B	STR	5 1/8
BC314R	B/B	STR	5 3/4
BC315R	B/B	STR	6
BC316R	B/B	STR	6 1/2
BC317R	B/B	STR	6 7/8
BC411R	B/B	CVD	4 1/2
BC413R	B/B	CVD	5 1/8
BC414R	B/B	CVD	5 3/4
BC415R	B/B	CVD	6
BC416R	B/B	CVD	6 1/2
BC417R	B/B	CVD	6 7/8

LITTAUER Ligature Scissors

Catalog Number	Tip	Blade	Length (in.)
BC803R	B/1-NOTCH	STR	5 1/4

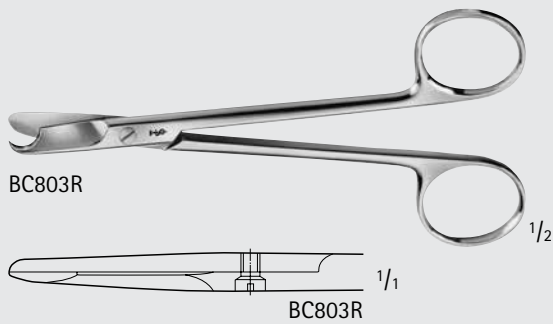

NORTHBENT Ligature Scissors

Catalog Number	Tip	Blade	Length (in.)
BC805R	B/1-NOTCH	LAT-CVD	4 3/4

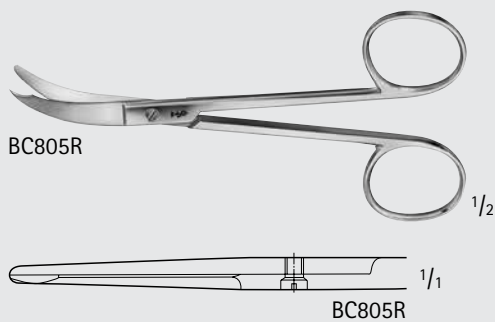

SPENCER Suture Scissors

Catalog Number	Tip	Blade	Length (in.)
BC801R	B/1-NOTCH	STR	3 1/2
BC802R	B/1-NOTCH	STR	4 1/2

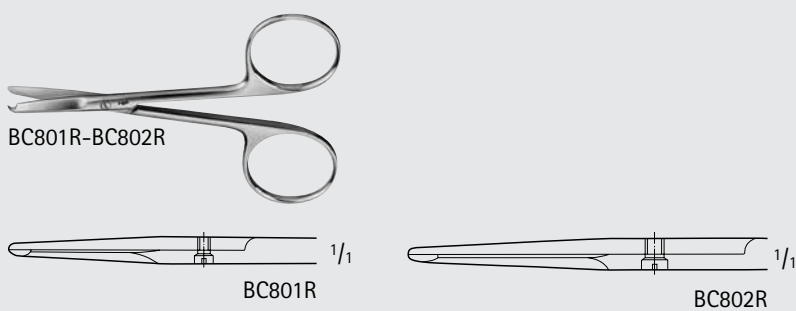

KNOWLES Bandage Scissors

Catalog Number	Tip	Blade	Length (in.)
BC846R	1-PROBE-POINT	STR	5 3/4
BC847R	1-PROBE-POINT	LAT-ANG	5 1/2

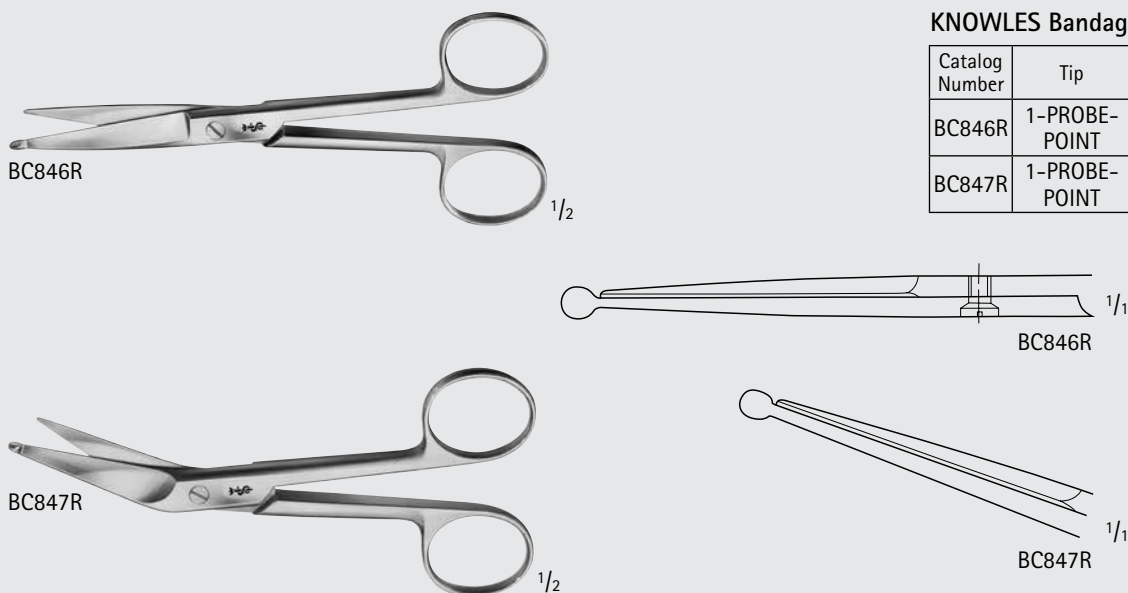

# General Surgery

## Scissors



BC848R-BC863R

### LISTER Bandage Scissors

Catalog Number	Blade	Length (in.)
BC848R	LONG	6 1/8
BC849R	LONG	7
BC860R	STANDARD	4 1/2
BC861R	STANDARD	5 1/2
BC862R	STANDARD	7
BC863R	STANDARD	7 7/8

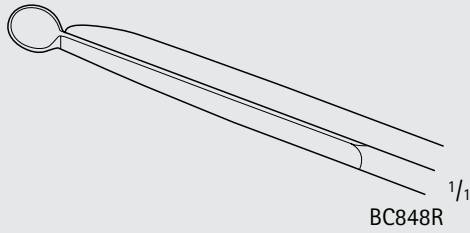

BC848R

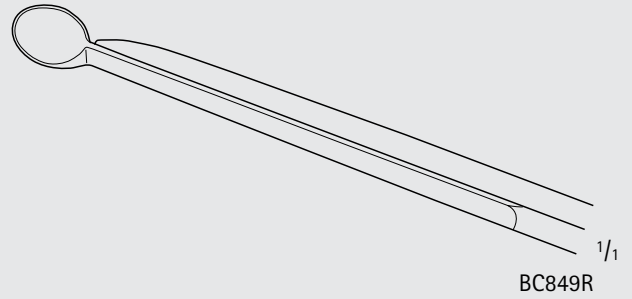

BC849R

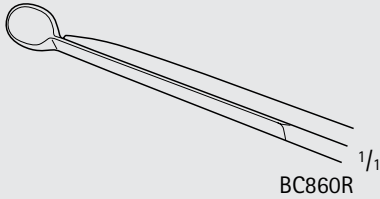

BC860R

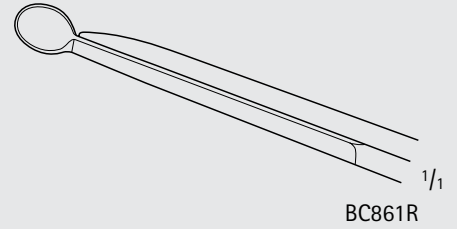

BC861R

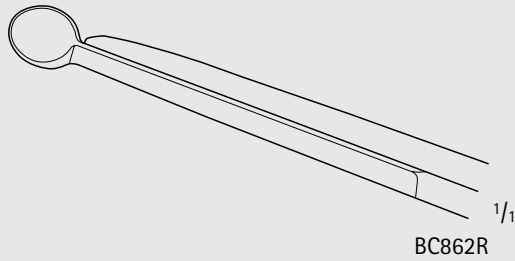

BC862R

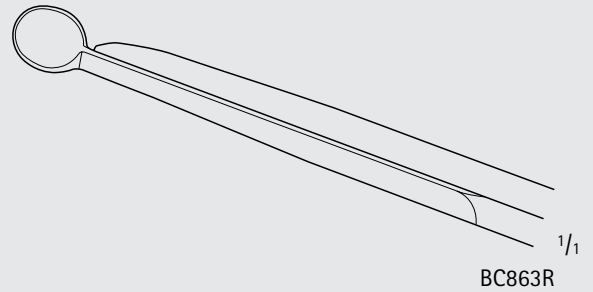

BC863R

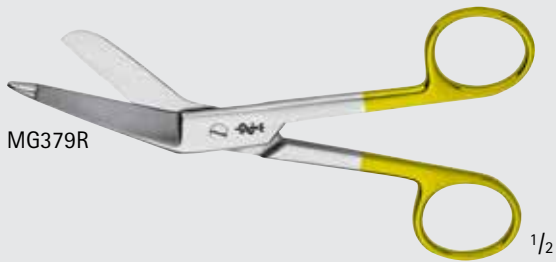

MG379R

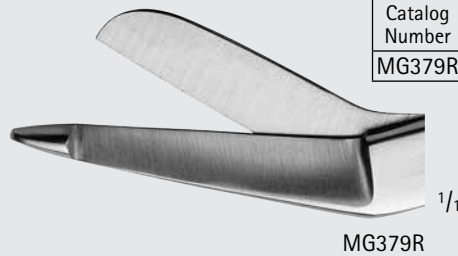

MG379R

### LISTER Bandage Scissors, Gold Handle

Catalog Number	Length (in.)
MG379R	5 1/2

LISTER Bandage Scissors, W/ One Large Ring

Catalog Number	Length (in.)
MB223	8

MB223



MB223

LISTER Bandage Scissors, Serrated

Catalog Number	Length (in.)
MB146R	3 1/2
BC876R	6 1/4

BC876R, MB146R

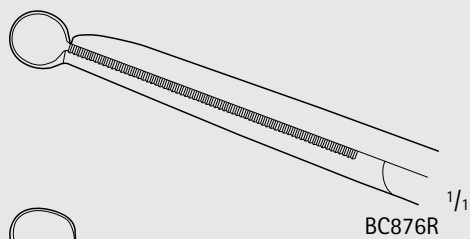

BC876R

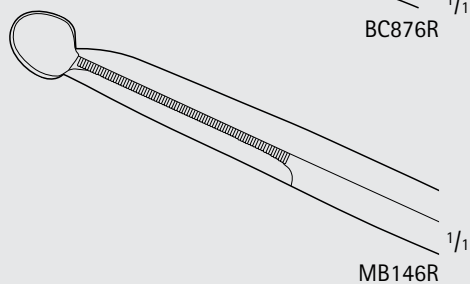

MB146R

# General Surgery

## Scissors

GENERAL SURGERY

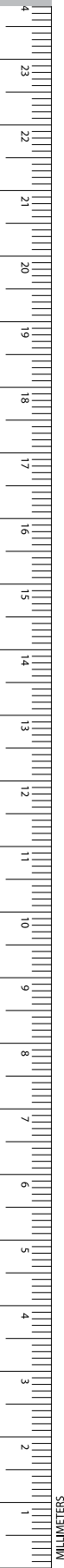

BC890R

1/2

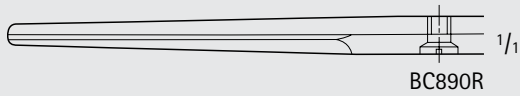

BC890R

1/1

### Nurse's Bandage Scissors

Catalog Number	Tip	Blade	Handle Color	Length (in.)
BC890R	B/B	STR	RED	5 3/4



BC885R-BC979R

1/2

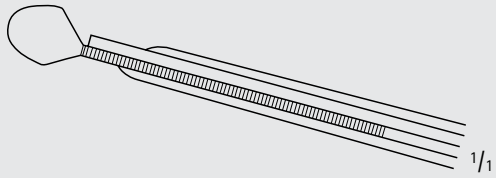

BC885R-BC979R

1/1

### LISTER Universal Bandage Scissors, Serrated

Catalog Number	Handle Color	Length (in.)
BC885R	BLACK	5 3/4
BC970R	RED	5 3/4
BC971R	BLUE	5 3/4
BC973R	YELLOW	5 3/4
BC975R	ORANGE	5 3/4
BC977R	PINK	5 3/4
BC978R	LIGHT GREEN	5 3/4
BC979R	VIOLET	5 3/4



BC881R-BC989R

1/2

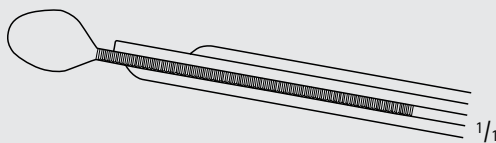

BC881R-BC989R

1/1

### Universal Bandage Scissors, W/ One Large Ring, Serrated

Catalog Number	Handle Color	Length (in.)
BC881R	BLACK	7
BC980R	RED	7
BC981R	BLUE	7
BC983R	YELLOW	7
BC985R	ORANGE	7
BC987R	PINK	7
BC988R	LIGHT GREEN	7
BC989R	VIOLET	7

**STILLE Dissecting Scissors, Round Blades**

Catalog Number	Tip	Blade	Length (in.)
BC580R	B/B	STR	6
BC581R	B/B	CVD	6

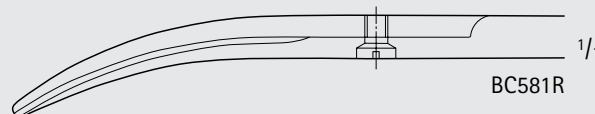
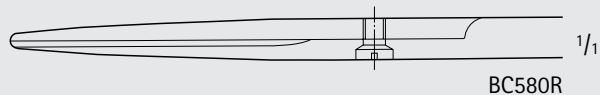
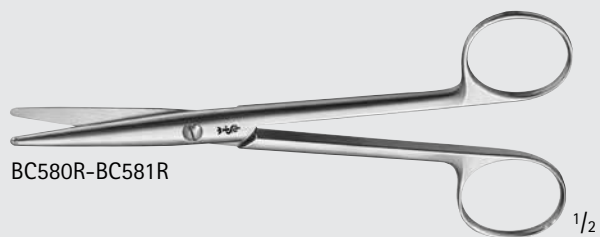

**MAYO Dissecting Scissors, Round Blade**

Catalog Number	Tip	Blade	Length (in.)
BC584R	B/B	STR	6 1/2
BC585R	B/B	STR	7 7/8
BC587R	B/B	CVD	6 1/2
BC588R	B/B	CVD	7 7/8
BC589R	B/B	CVD	8 1/4

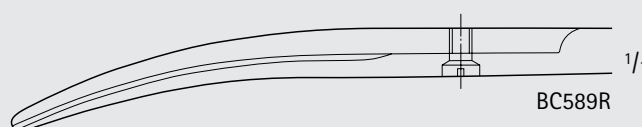
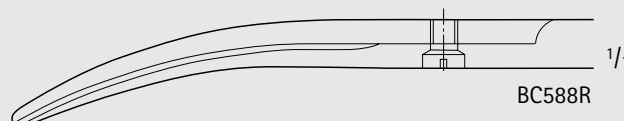
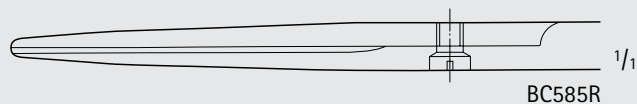
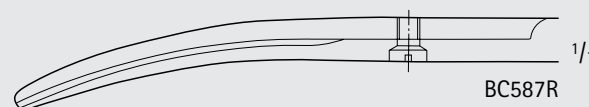
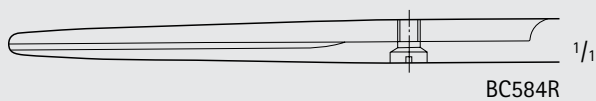

# General Surgery

## Scissors

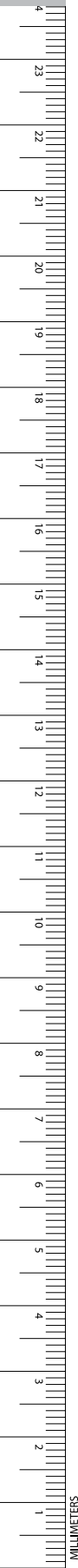

BC560R-BC561R  $\frac{1}{3}$

BC560R  $\frac{1}{1}$

BC561R  $\frac{1}{1}$

MAYO-HARRINGTON Dissecting Scissors			
Catalog Number	Tip	Blade	Length (in.)
BC560R	B/B	STR	9
BC561R	B/B	CVD	9

BC567R-BC568R  $\frac{1}{3}$

BC568R  $\frac{1}{1}$

BC567R  $\frac{1}{1}$

MAYO-HARRINGTON Dissecting Scissors			
Catalog Number	Tip	Blade	Length (in.)
BC568R	B/B	STR	11
BC567R	B/B	CVD	11

MB148R  $\frac{1}{3}$

MB148R  $\frac{1}{1}$

MAYO Dissecting Scissors, W/ One Large Ring			
Catalog Number	Tip	Blade	Length (in.)
MB148R	B/B	HEAVY	14

MAYO Dissecting Scissors, Beveled Blade

Catalog Number	Tip	Blade	Length (in.)
BC544R	B/B	STR	5 1/2
BC545R	B/B	STR	6 1/8
BC547R	B/B	STR	6 3/4
BC562R	B/B	STR	7 1/2
BC564R	B/B	STR	8 1/2
BC554R	B/B	CVD	5 1/2
BC555R	B/B	CVD	6 1/8
BC557R	B/B	CVD	6 3/4
BC563R	B/B	CVD	7 1/2
BC565R	B/B	CVD	8 1/2



BC544R-BC557R

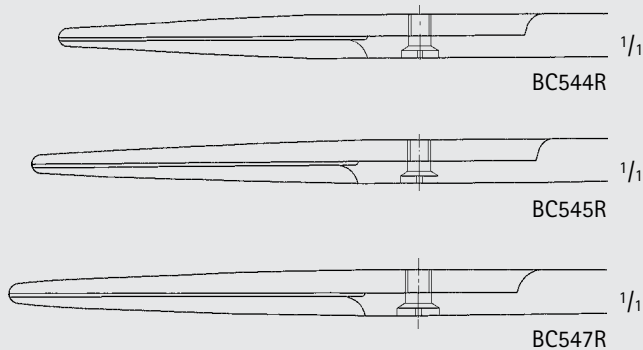

BC544R

BC545R

BC547R

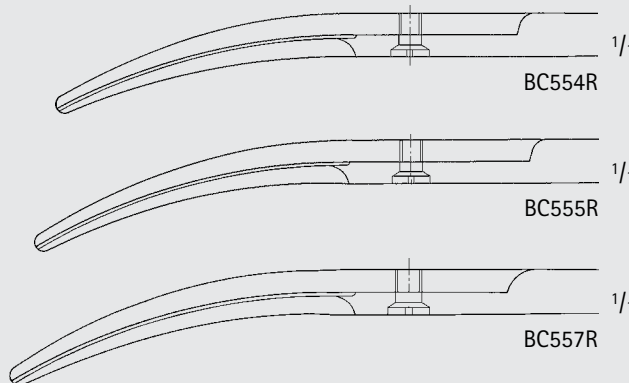

BC554R

BC555R

BC557R



BC562R-BC565R

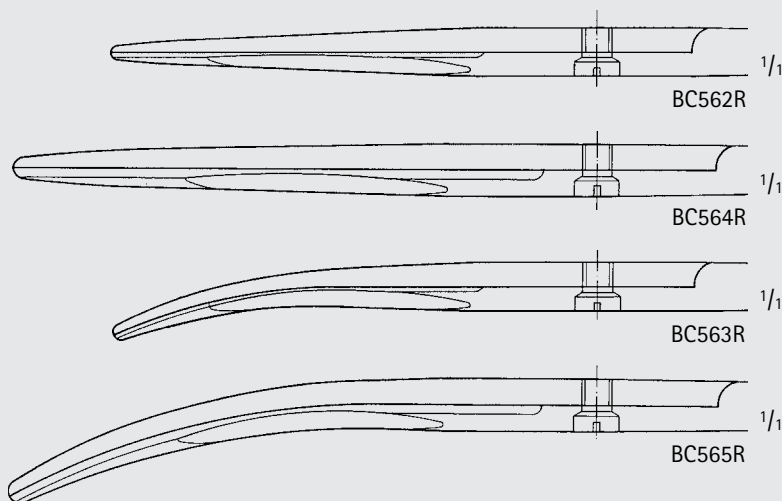

BC562R

BC564R

BC563R

BC565R



INCHES

# General Surgery

## Scissors

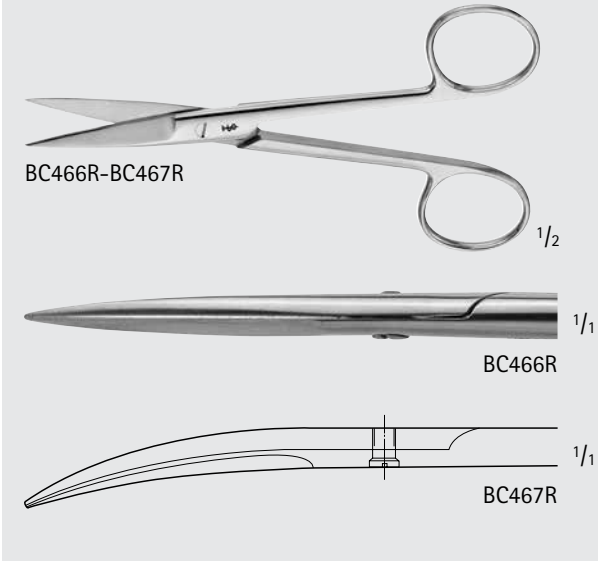

### MAYO Operating Scissors

Catalog Number	Tip	Blade	Length (in.)
BC466R	S/S	STR	5 1/2
BC467R	S/S	CVD	5 1/2

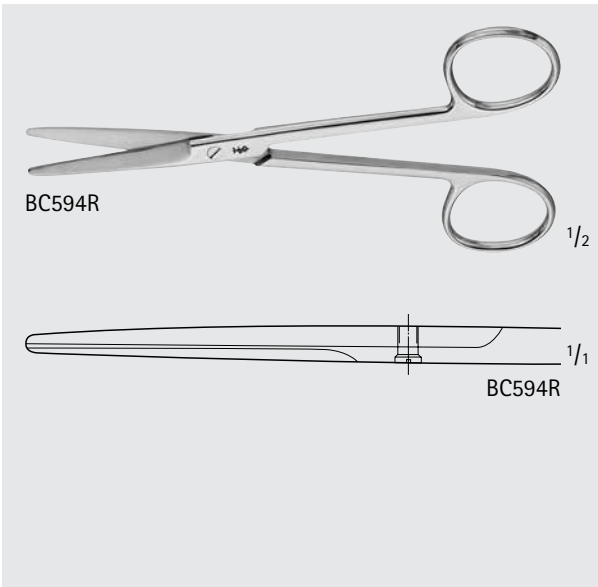

### MAYO Dissecting Scissors, Delicate

Catalog Number	Tip	Blade	Length (in.)
BC594R	B/B	STR	5 1/2

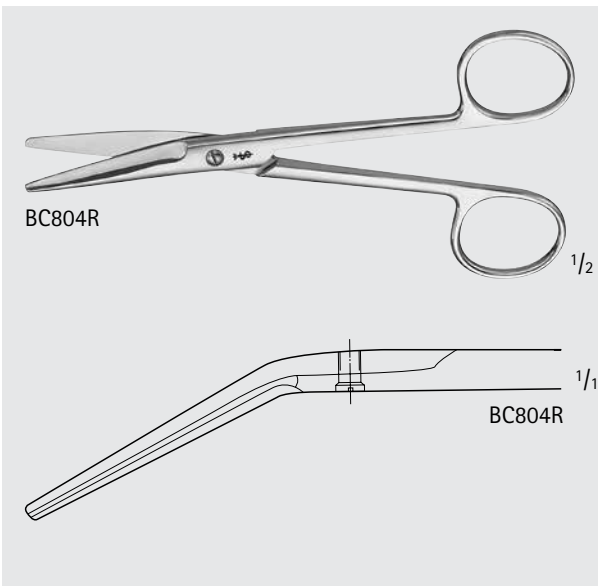

### NEW'S Suture Scissors

Catalog Number	Tip	Blade	Length (in.)
BC804R	B/B	ANG	5 1/2

Suture Scissors

Catalog Number	Tip	Blade	Length (in.)
BC806R	B/B	STR	4 1/2

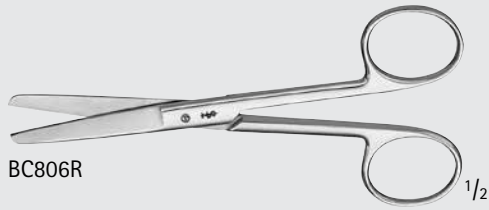

BC806R

1/2

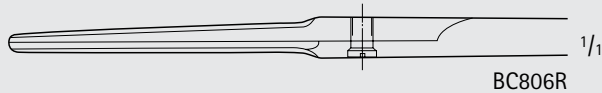

BC806R

1/1

LEXER Dissecting Scissors, Delicate

Catalog Number	Tip	Blade	Length (in.)
BC590R	B/B	STR	6 1/2
BC591R	B/B	CVD	6 1/2

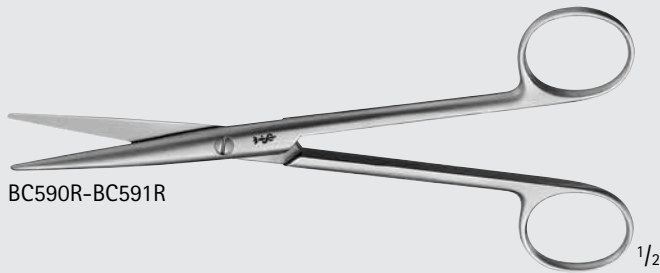

BC590R-BC591R

1/2

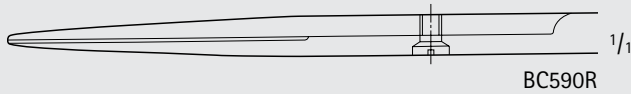

BC590R

1/1

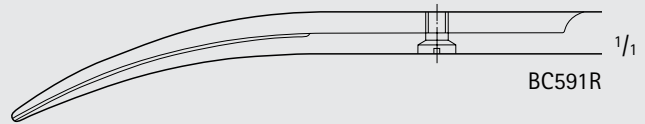

BC591R

1/1

MAYO-LEXER Dissecting Scissors

Catalog Number	Tip	Blade	Length (in.)
BC592R	B/B	CVD	6 1/2

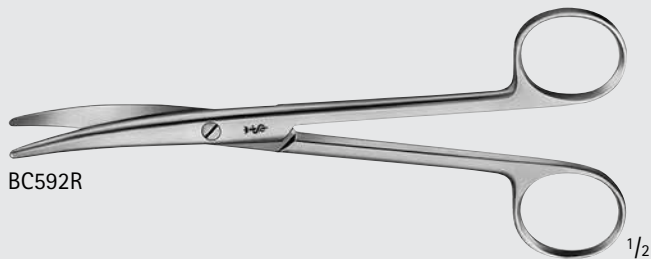

BC592R

1/2

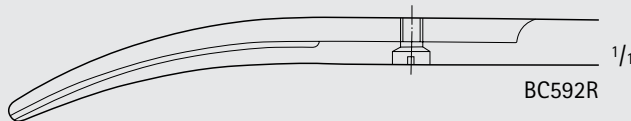

BC592R

1/1

MAYO-SIMS Dissecting Scissors

Catalog Number	Tip	Blade	Length (in.)
MB149R	B/B	STR	7 3/4

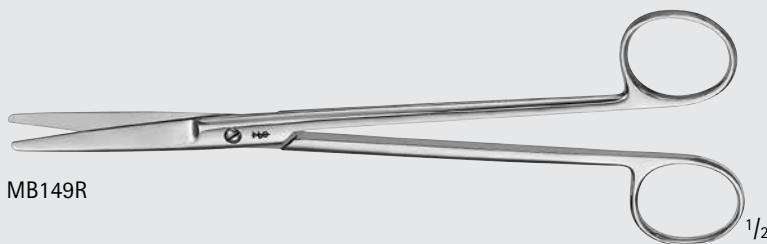

MB149R

1/2

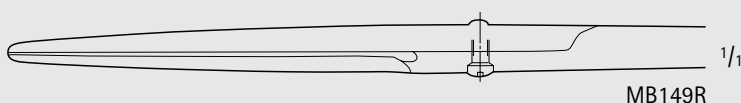

MB149R

1/1



INCHES

# General Surgery

## Scissors

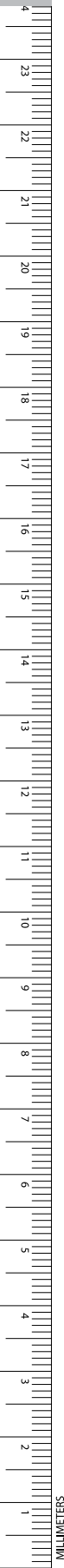

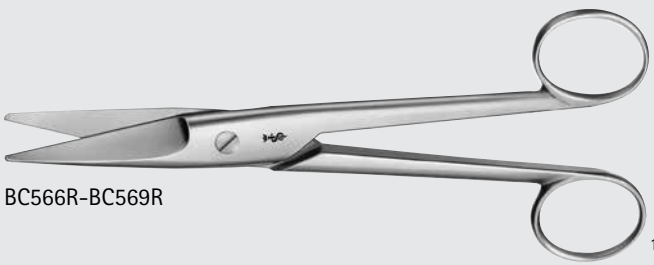

BC566R-BC569R

1/2

**MAYO–NOBLE Dissecting Scissors, Broad Blade**

Catalog Number	Tip	Blade	Length (in.)
BC566R	B/B	STR	6 3/4
BC569R	B/B	CVD	6 3/4

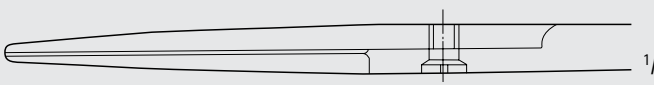

BC566R

1/1

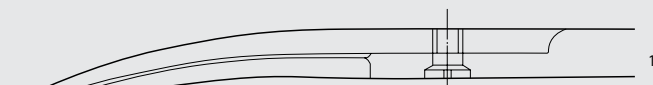

BC569R

1/1



BC576R-BC579R

**MAYO–STILLE Dissecting Scissors, Beveled Blade**

Catalog Number	Tip	Blade	Length (in.)
BC576R	B/B	STR	5 1/2
BC578R	B/B	STR	6 1/2
BC577R	B/B	CVD	5 1/2
BC579R	B/B	CVD	6 1/2

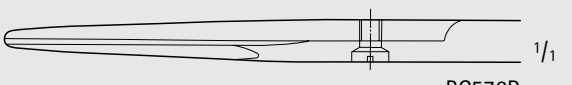

BC576R

1/1

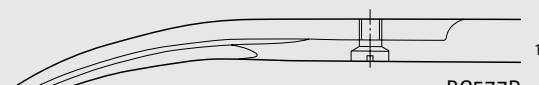

BC577R

1/1

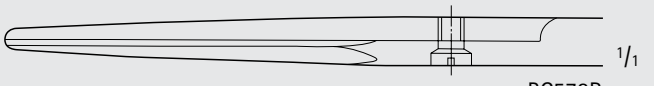

BC578R

1/1

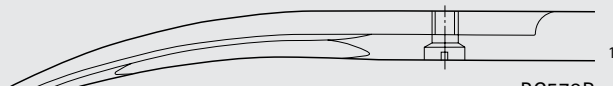

BC579R

1/1



BC570R-BC575R

**MAYO–STILLE Dissecting Scissors, Flat Blade**

Catalog Number	Tip	Blade	Length (in.)
BC570R	B/B	STR	5 1/2
BC572R	B/B	STR	6 3/4
BC573R	B/B	CVD	5 1/2
BC575R	B/B	CVD	6 3/4

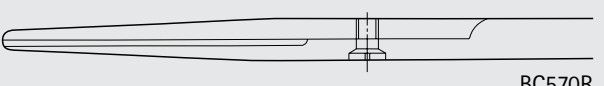

BC570R

1/1

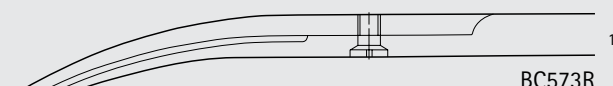

BC573R

1/1

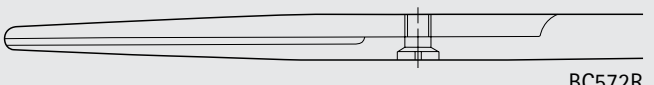

BC572R

1/1

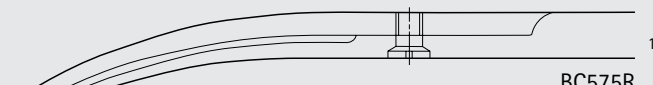

BC575R

1/1



**TOENNIS Dissecting Scissors**

Catalog Number	Tip	Blade	Length (in.)
BC633R	B/B	X-DEL, STR	7
BC634R	B/B	DEL, STR	7
BC635R	B/B	DEL, CVD	7

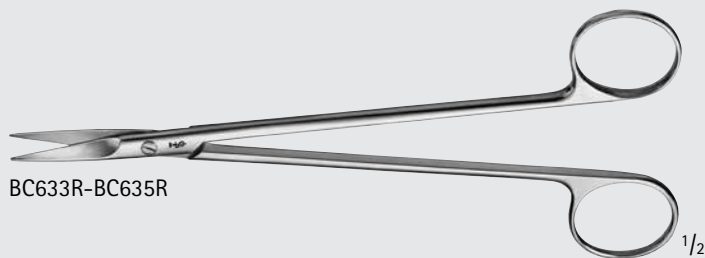

BC633R-BC635R

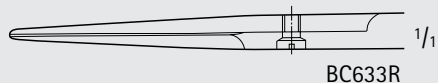

BC633R

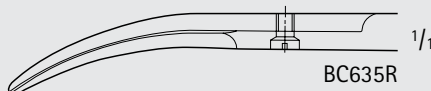

BC635R

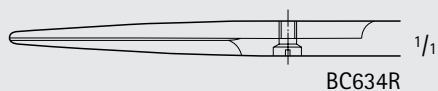

BC634R

**Nerve Dissecting Scissors**

Catalog Number	Tip	Blade	Length (in.)
BC628R	S/S	CVD	6

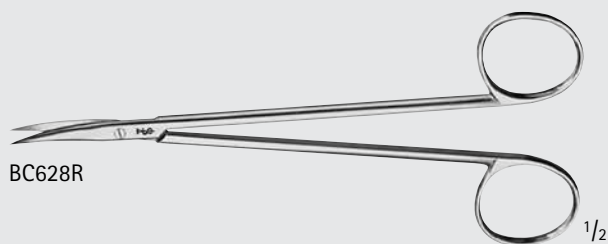

BC628R

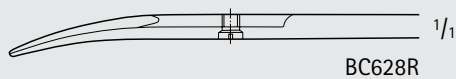

BC628R

**TOENNIS-ADSON Dissecting Scissors**

Catalog Number	Tip	Blade	Length (in.)
BC630R	X-DEL	CVD	6 7/8
BC631R	DEL	CVD	6 7/8

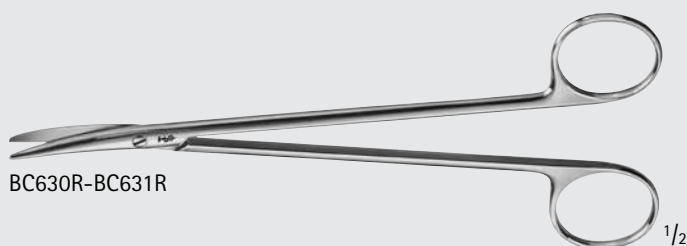

BC630R-BC631R

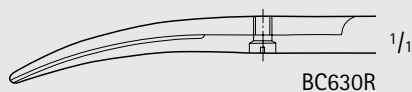

BC630R

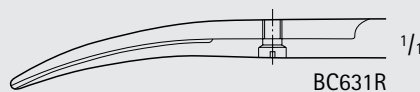

BC631R

# General Surgery

## Scissors

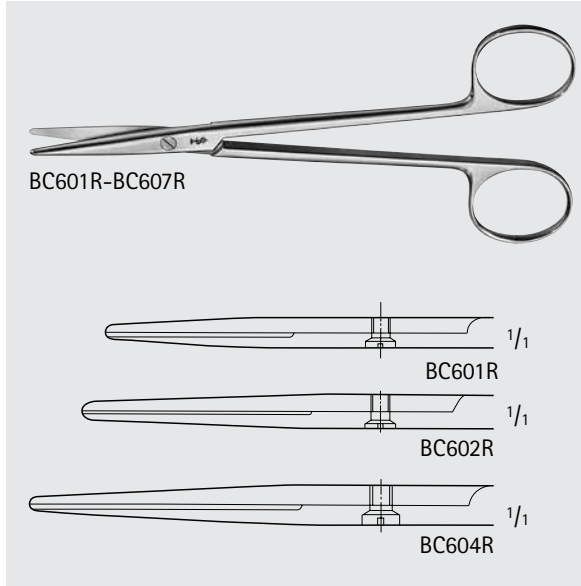
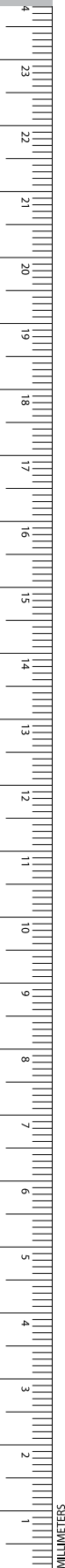

### METZENBAUM Dissecting Scissors

Catalog Number	Tip	Blade	Length (in.)
BC601R	B/B	STR	5 3/4
BC602R	B/B	STR	7
BC604R	B/B	STR	7 7/8
BC605R	B/B	CVD	5 3/4
BC606R	B/B	CVD	7
BC607R	B/B	CVD	7 7/8

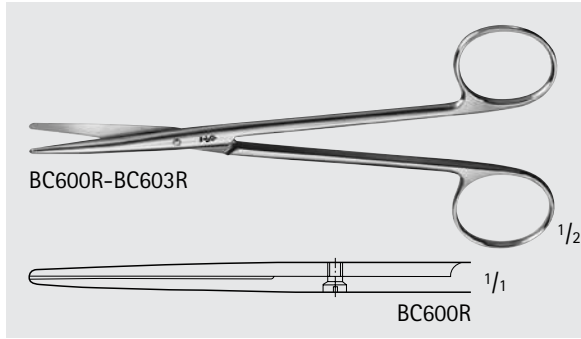
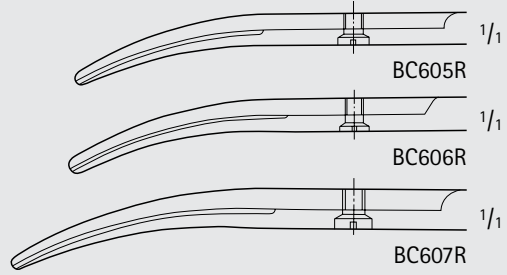

### Baby METZENBAUM Dissecting Scissors, Delicate

Catalog Number	Tip	Blade	Length (in.)
BC600R	B/B	STR	5 3/4
BC603R	B/B	CVD	5 3/4

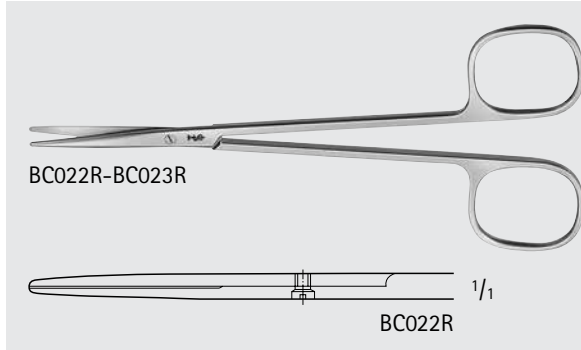
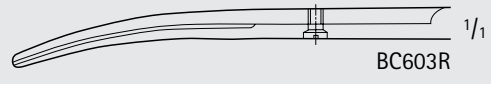

### Baby METZENBAUM Dissecting Scissors

Catalog Number	Tip	Blade	Length (in.)
BC022R	B/B	STR	5 3/4
BC023R	B/B	CVD	5 3/4

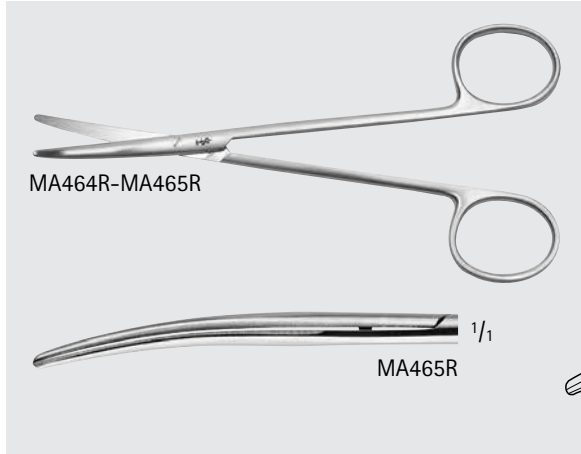
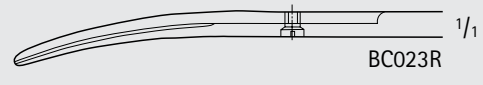

### METZENBAUM Scissors, Delicate

Catalog Number	Tip	Blade	Length (in.)
MA464R	B/B	CVD	5 1/2
MA465R	B/B	CVD	8

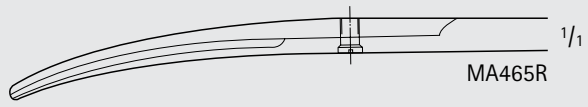

**NELSON-METZENBAUM Dissecting Scissors**

Catalog Number	Tip	Blade	Length (in.)
BC611R	B/B	STR	9
BC612R	B/B	STR	9 3/4
BC613R	B/B	STR	11 1/4
BC614R	B/B	STR	12
BC615R	B/B	CVD	9
BC616R	B/B	CVD	9 3/4
BC618R	B/B	CVD	11 1/4
BC619R	B/B	CVD	12
MB926R	B/B	CVD	16

BC611R-BC619R, MB926R

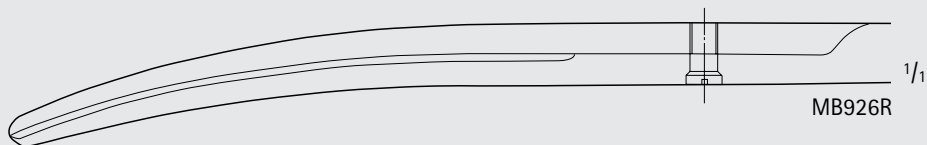
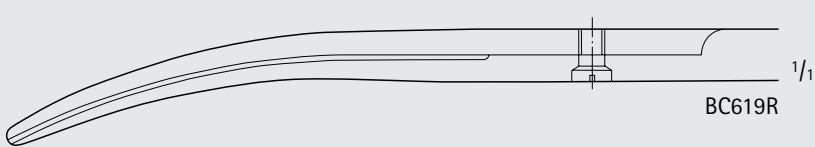
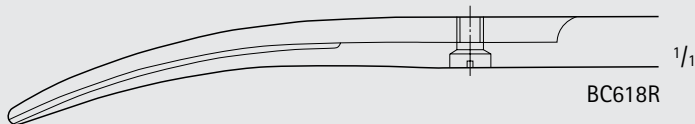
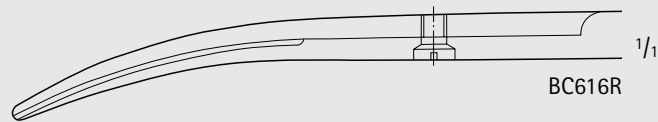
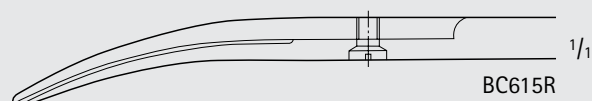
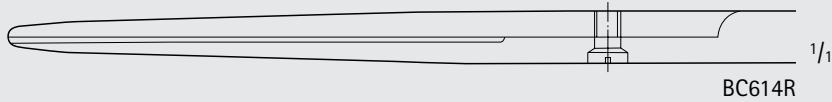
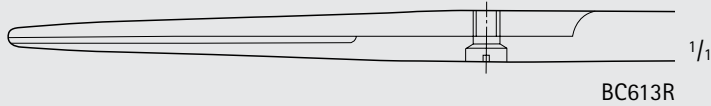
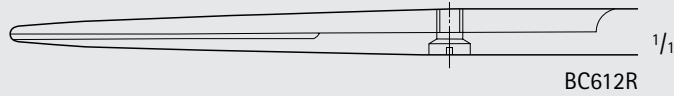
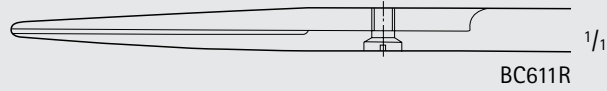
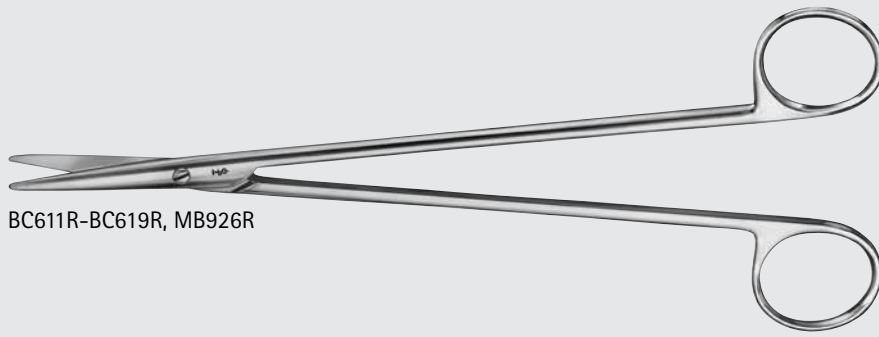

# General Surgery

## Scissors



### NELSON-METZENBAUM Dissecting Scissors, Delicate

Catalog Number	Tip	Blade	Length (in.)
BC625R	B/B	CVD	13 3/4

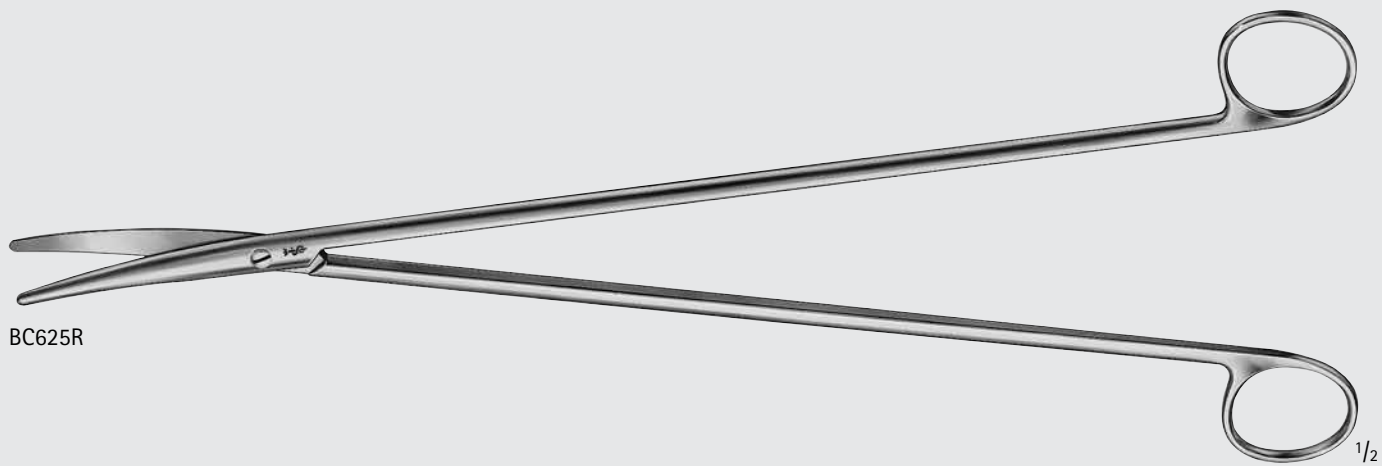

BC625R

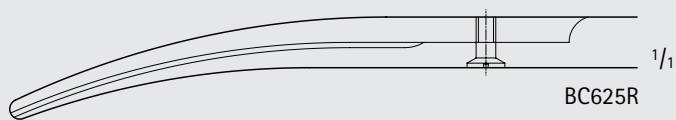

BC625R

### WELLER Dissecting Scissors

Catalog Number	Tip	Blade	Length (in.)
BC620R	B/B	HEAVY-CVD	11

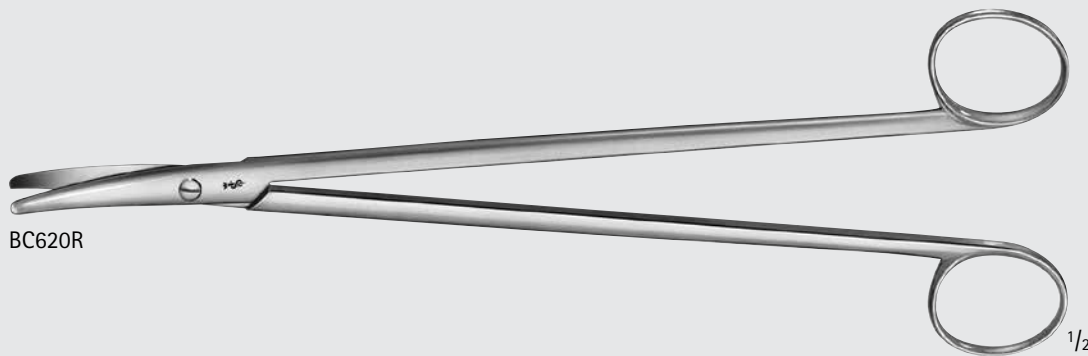

BC620R

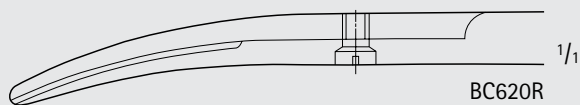

BC620R

Abdominal Scissors

Catalog Number	Tip	Blade	Length (in.)
BC774R	B/B	STR	7



BC774R

1/2

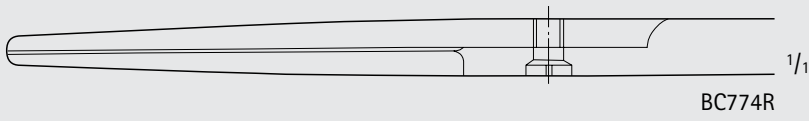

BC774R

1/1

Rectal Scissors

Catalog Number	Tip	Blade	Length (in.)
BC617R	B/B	HEAVY-CVD	12 3/4

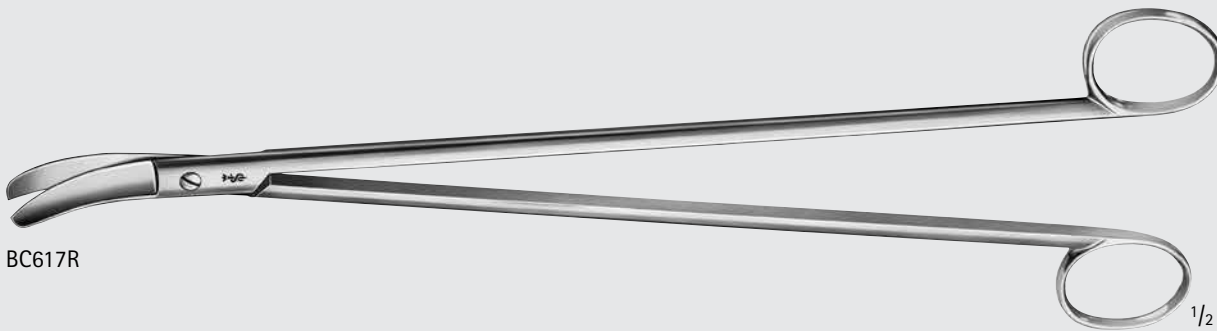

BC617R

1/2

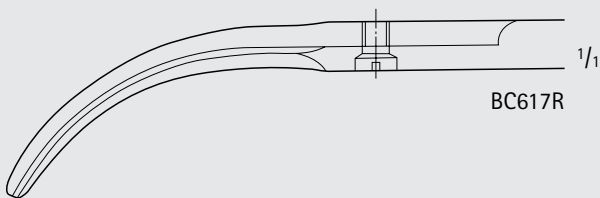

BC617R

1/1



# General Surgery

## Scissors

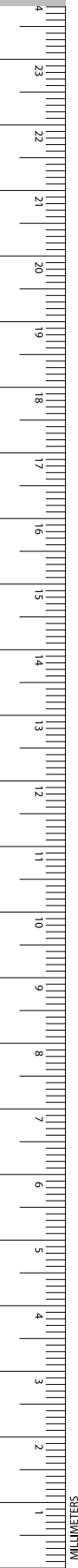

### LLOYD-DAVIES Rectal Scissors

Catalog Number	Tip	Blade	Length (in.)
BC621R	B/B	CVD	10 5/8

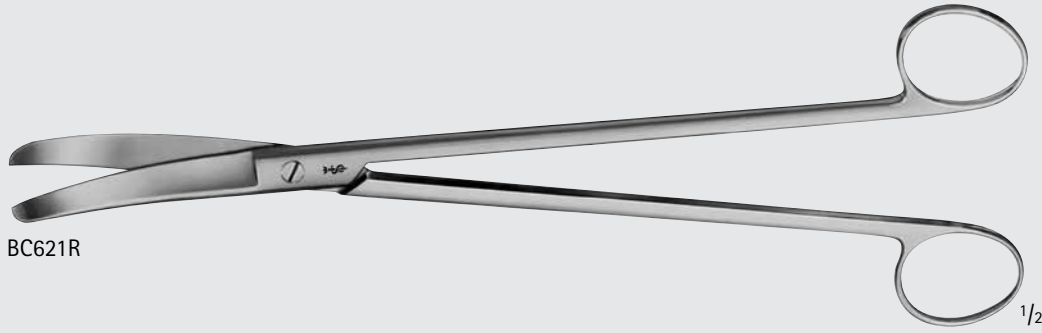

BC621R

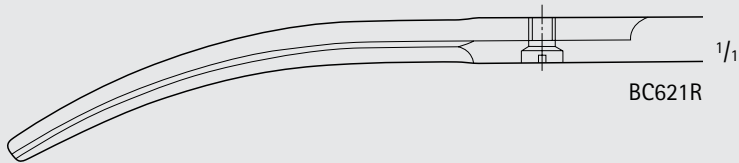

BC621R

### STELZNER Rectal Scissors

Catalog Number	Tip	Blade	Length (in.)
BC622R	B/B	STR	12 1/4
BC623R	B/B	CVD	12 1/4

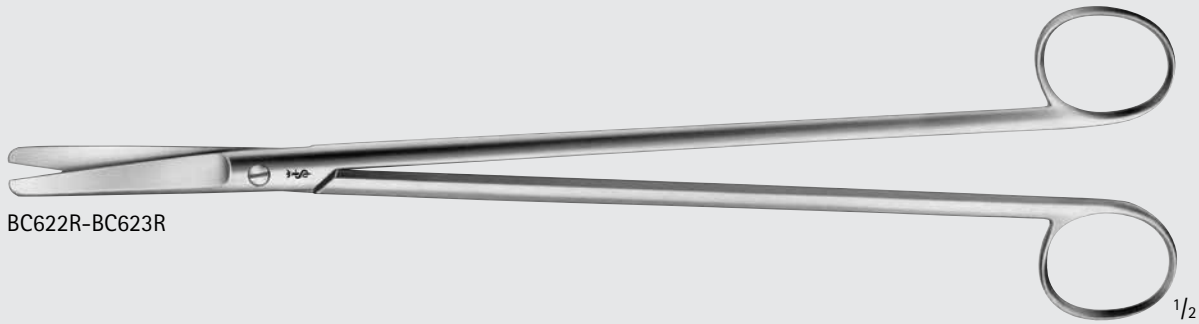

BC622R-BC623R

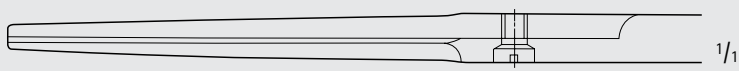

BC622R



BC623R

MUELLER Rectal Scissors

Catalog Number	Tip	Blade	Length (in.)
BC627R	B/B	CVD	12 3/4

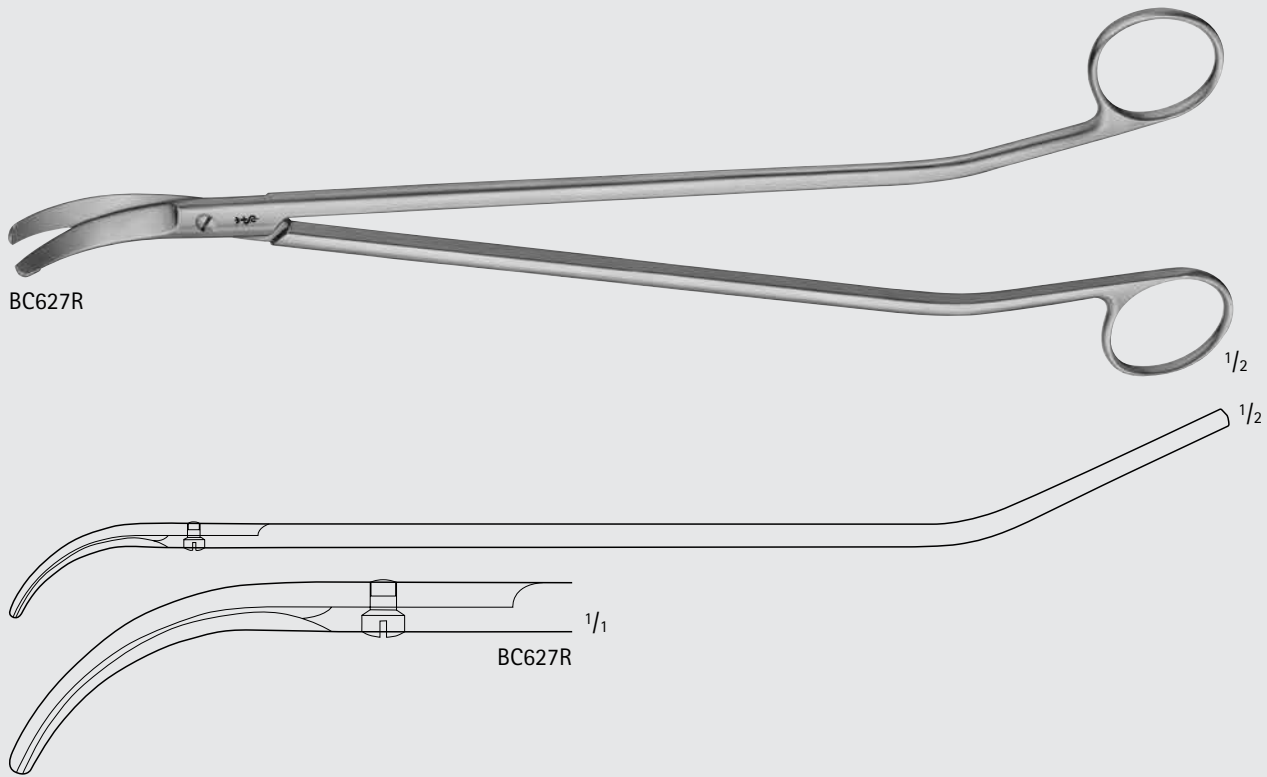

HARVEY Wire Scissors

Catalog Number	Tip	Blade	Length (in.)
BC815R	B/B	SERR	5

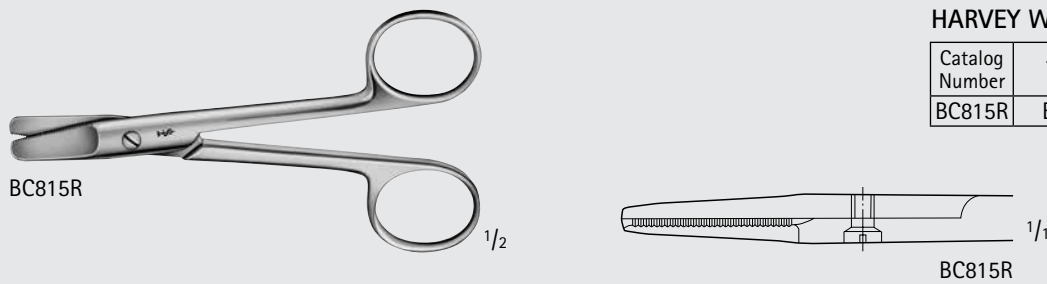

Wire Cutting Scissors

Catalog Number	For Wire Size	Length (in.)
DP551R	SOFT, UP TO 1.2MM AND HARD, UP TO 0.6 MM	4 3/4

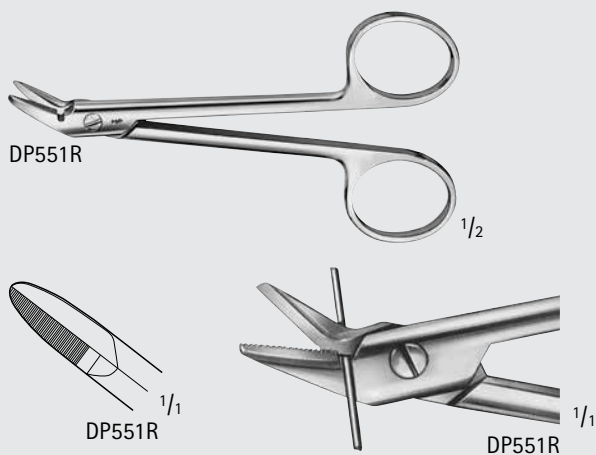

# General Surgery

## Delicate Scissors

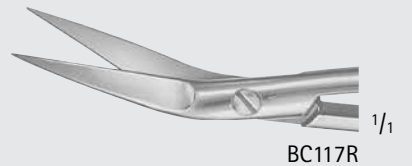
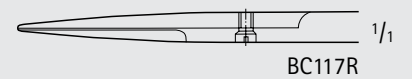
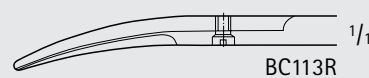
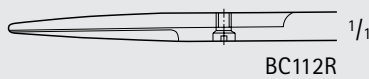
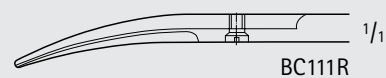
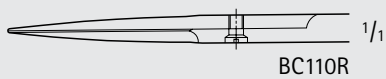
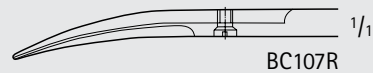
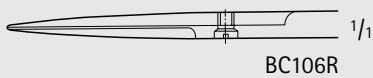
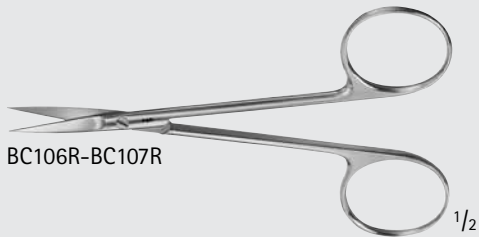
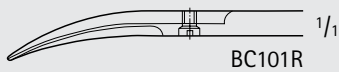
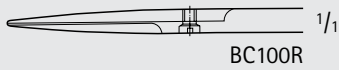
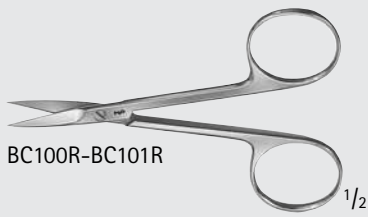
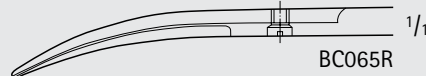
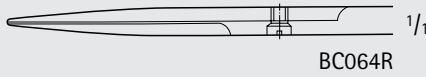
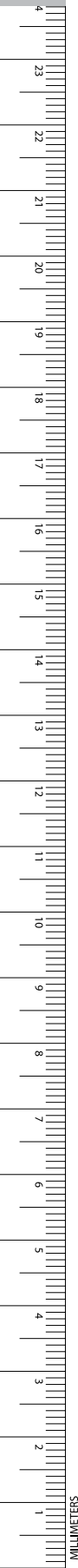

### Iris Scissors

Catalog Number	Tip	Blade	Length (in.)
BC100R	S/S	STR	3 1/2
BC110R	S/S	STR	4 1/4
BC106R	S/S	STR	4 1/2
BC064R	S/S	STR	4 3/4
BC101R	S/S	CVD	3 1/2
BC111R	S/S	CVD	4 1/4
BC107R	S/S	CVD	4 1/2
BC065R	S/S	CVD	4 3/4
BC112R	S/B	STR	4 1/4
BC113R	S/B	CVD	4 1/4
BC117R	S/S	LAT-ANG	4 1/4

REYNOLDS-JAMESON Tenotomy Scissors

Catalog Number	Tip	Blade	Handle	Length (in.)
BC015R	B/B	CVD	SQUARE	5 1/2

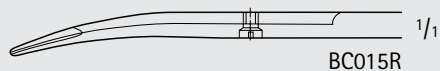
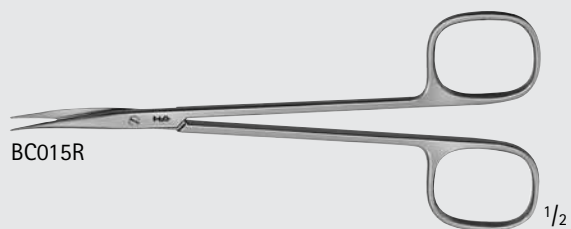

Strabismus Scissors

Catalog Number	Tip	Blade	Length (in.)
BC164R	B/B	STR	4 1/2
BC165R	B/B	CVD	4 1/2

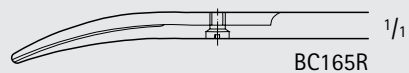
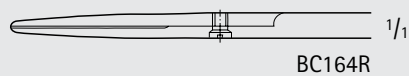

# General Surgery

## Delicate Scissors

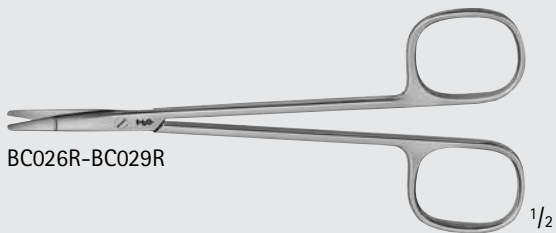

BC026R-BC029R

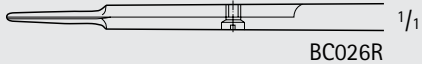

BC026R

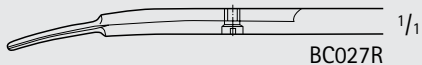

BC027R

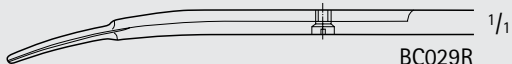

BC029R

### RAGNELL Dissecting Scissors

Catalog Number	Tip	Blade	Length (in.)
BC026R	B/B	STR	5 1/4
BC027R	B/B	CVD	5 1/4
BC029R	B/B	CVD	6

CHADWICK Scissors, Delicate

Catalog Number	Tip	Blade	Length (in.)
BC153R	S/S	CVD	4 1/2



BC153R

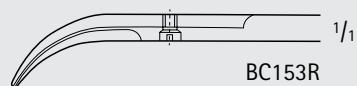

BC153R

LA GRANGE Scissors

Catalog Number	Tip	Blade	Length (in.)
BC154R	S/S	1-SERR	4 1/4

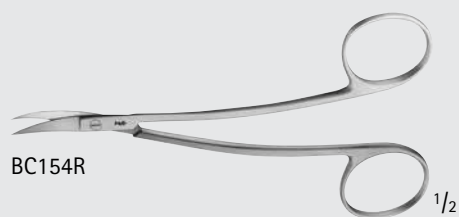

BC154R

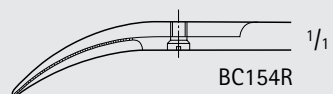

BC154R

KELLY Scissors

Catalog Number	Tip	Blade	Length (in.)
BC160R	S/S	STR	6 7/8
BC161R	S/S	CVD	6 7/8

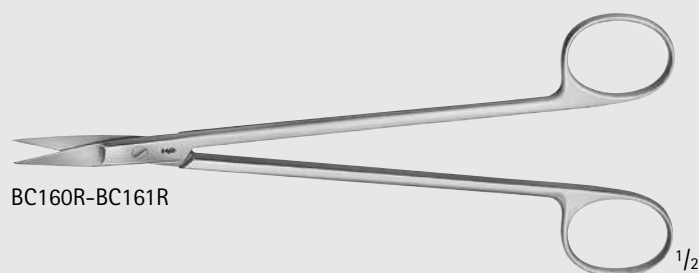

BC160R-BC161R

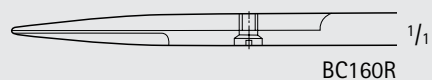

BC160R

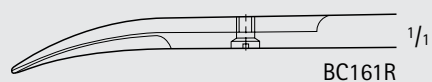

BC161R

# General Surgery

## Delicate Scissors



MG220R

1/2

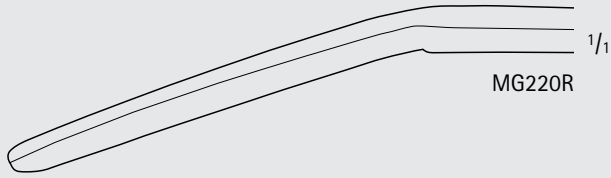

MG220R

1/1

### ROCHESTER-FERGUSON Scissors

Catalog Number	Tip	Blade	Length (in.)
MG220R	B/B	ANG FLAT	7

DUROTIP Tungsten Carbide Scissors

- Excellent cutting accuracy
- Long working life
- Gold-plated rings

DUROTIP TC Suture Scissors

Catalog Number	Tip	Blade	Length (in.)
BC228R	S/S	STR	5 3/4
BC224R	S/B	STR	5 3/4
BC234R	S/B	CVD	5 3/4

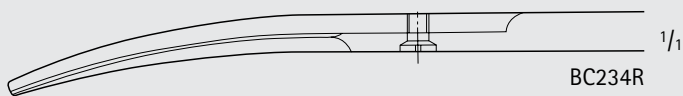
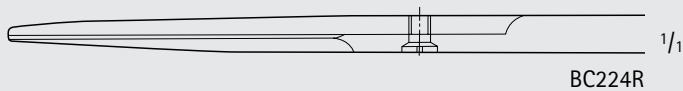
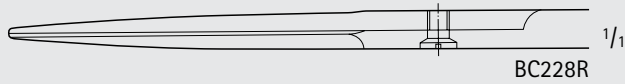

DUROTIP TC Operating Scissors

Catalog Number	Tip	Blade	Length (in.)
BC236R	S/S	STR	5 3/4
MB171R	S/S	CVD	5 3/4

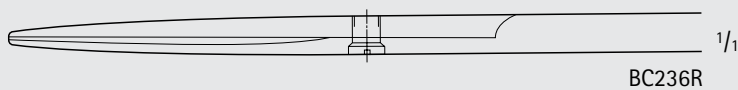
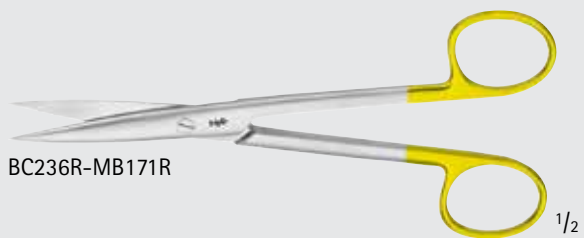

INCHES

General Surgery  
DUROTIP™ TC Scissors

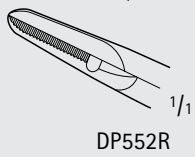
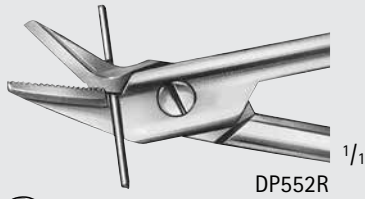
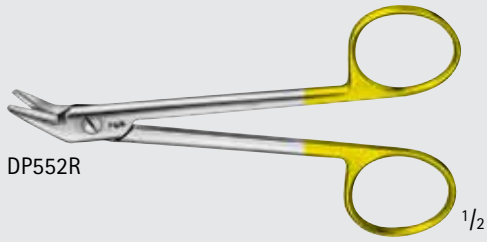
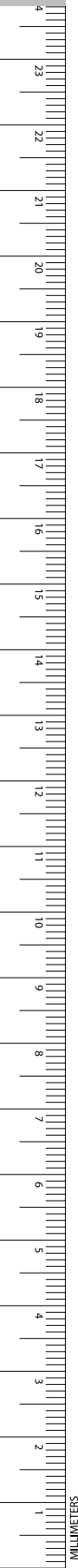

DUROTIP TC Wire Cutting Scissors

Catalog Number	Blade	For Wire Size	Length (in.)
DP552R	1-SERR	SOFT, UP TO 1.2 MM AND HARD, UP TO 0.8 MM	4 3/4

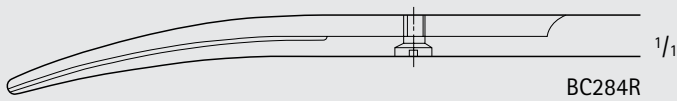
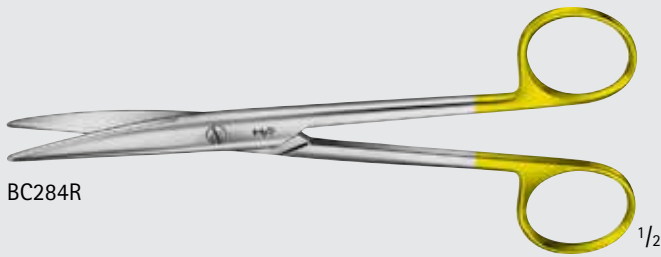

DUROTIP TC MAYO-LEXER Dissecting Scissors, Round Blades

Catalog Number	Tip	Blade	Length (in.)
BC284R	B/B	CVD	6 1/2



BC240R-BC243R

**DUROTIP TC MAYO Dissecting Scissors,  
Round Blades**

Catalog Number	Tip	Blade	Length (in.)
BC240R	B/B	STR	5 1/2
BC242R	B/B	STR	6 3/4
BC241R	B/B	CVD	5 1/2
BC243R	B/B	CVD	6 3/4

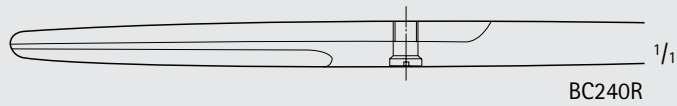

BC240R

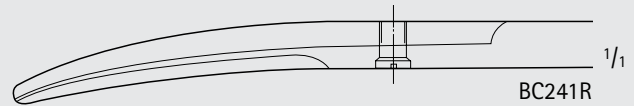

BC241R

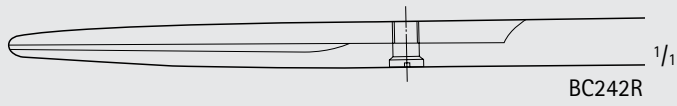

BC242R



BC243R



BC250R-BC253R

**DUROTIP TC MAYO Dissecting Scissors,  
Beveled Blades**

Catalog Number	Tip	Blade	Length (in.)
BC250R	B/B	STR	5 1/2
BC252R	B/B	STR	6 3/4
BC251R	B/B	CVD	5 1/2
BC253R	B/B	CVD	6 3/4

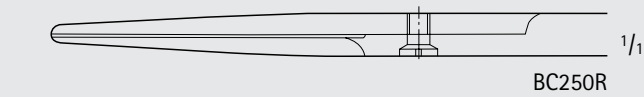

BC250R

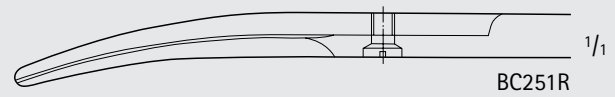

BC251R

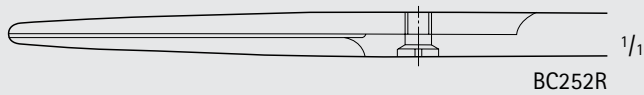

BC252R

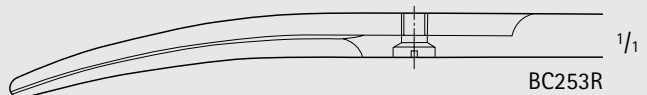

BC253R



INCHES

# General Surgery

## DUROTIP™ TC Scissors

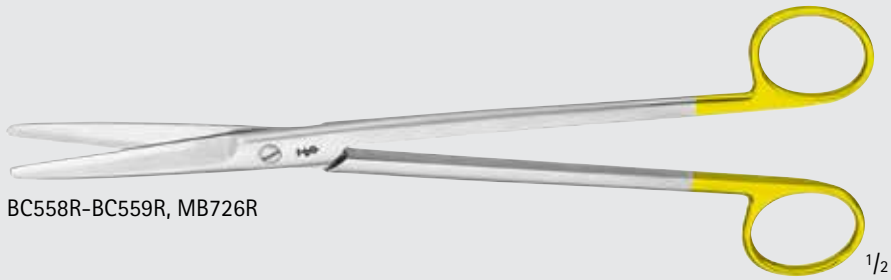

BC558R-BC559R, MB726R

### DUROTIP TC MAYO Dissecting Scissors

Catalog Number	Tip	Blade	Length (in.)
BC558R	B/B	STR	9
MG215R	B/B	STR	14
BC559R	B/B	CVD	9
MB726R	B/B	CVD	14

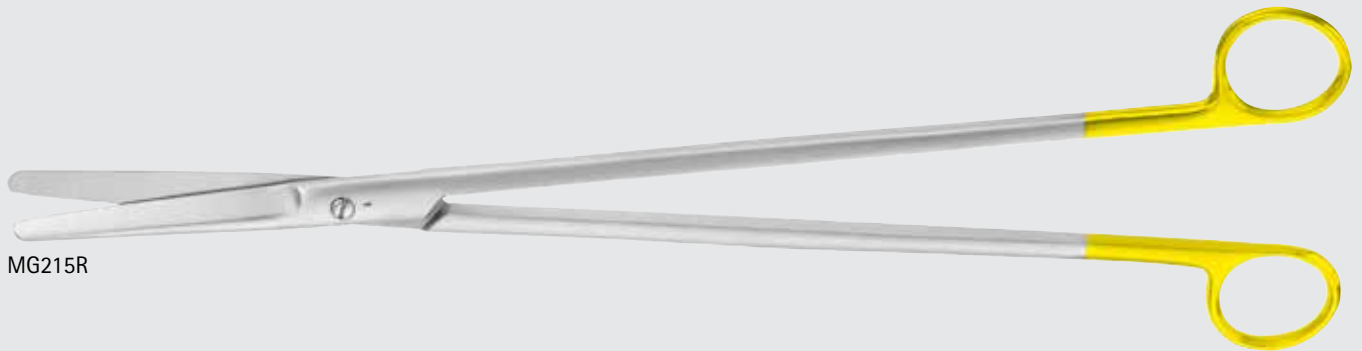
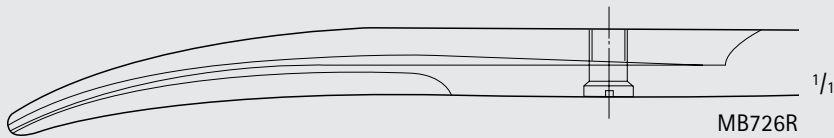
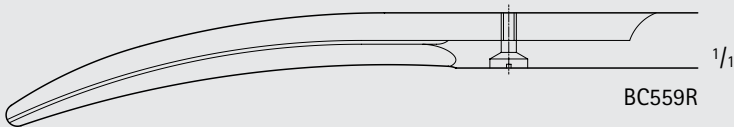
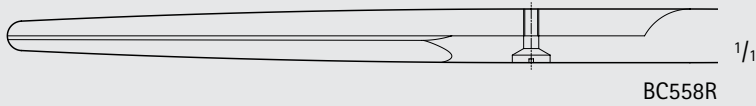

MG215R

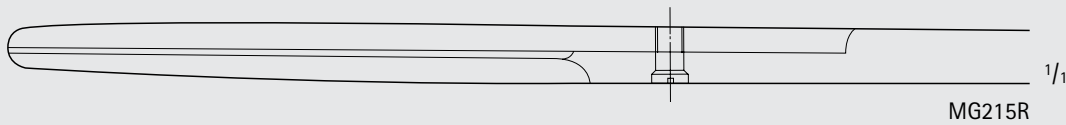

DUROTIP TC METZENBAUM Dissecting Scissors, Delicate

Catalog Number	Tip	Blade	Length (in.)
MB205R	S/S	STR	9 1/4
MB207R	S/S	CVD	5 3/4
MD496	S/S	CVD	7
MB206R	S/S	CVD	9 1/4

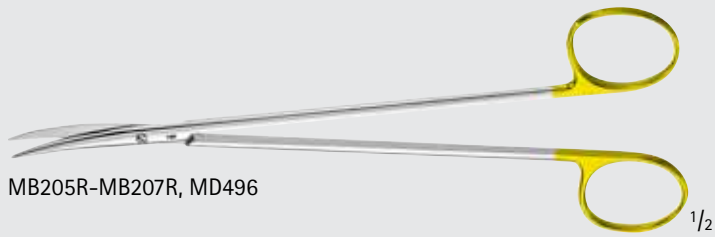

MB205R-MB207R, MD496

1/2



MB205R

1/1

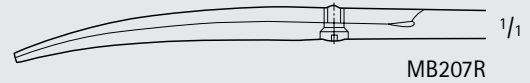

MB207R

1/1



MD496

1/1

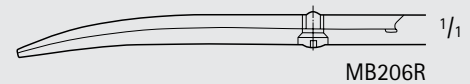

MB206R

1/1



BC260R-BC265R

DUROTIP TC METZENBAUM Dissecting Scissors

Catalog Number	Tip	Blade	Length (in.)
BC260R	B/B	STR	5 3/4
BC262R	B/B	STR	7
BC261R	B/B	CVD	5 3/4
BC263R	B/B	CVD	7
BC265R	B/B	CVD	7 7/8

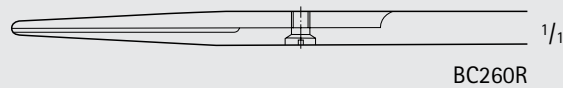

BC260R

1/1

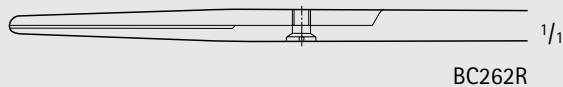

BC262R

1/1

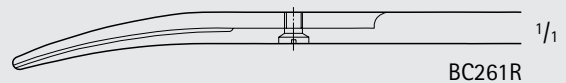

BC261R

1/1

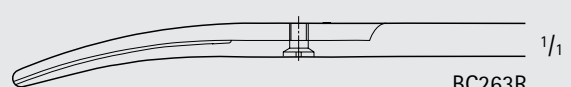

BC263R

1/1

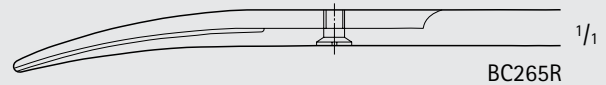

BC265R

1/1



INCHES

# General Surgery

## DUROTIP™ TC Scissors



**BC287R**

**DUROTIP TC METZENBAUM Dissecting Scissors**

Catalog Number	Tip	Blade	Length (in.)
BC287R	B/B	CVD	9

**BC287R**

**BC270R-BC277R**

**DUROTIP TC METZENBAUM Dissecting Scissors, Delicate**

Catalog Number	Tip	Blade	Length (in.)
BC270R	B/B	STR	7
BC274R	B/B	STR	7 7/8
BC276R	B/B	STR	9
BC271R	B/B	CVD	7
BC275R	B/B	CVD	7 7/8
BC277R	B/B	CVD	9

**BC270R**

**BC271R**

**BC274R**

**BC275R**

**BC276R**

**BC277R**



BC258R-BC259R

**DUROTIP TC Baby METZENBAUM  
Dissecting Scissors, Delicate**

Catalog Number	Tip	Blade	Length (in.)
BC258R	B/B	STR	5 3/4
BC259R	B/B	CVD	5 3/4

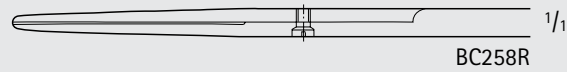

BC258R

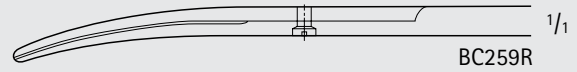

BC259R

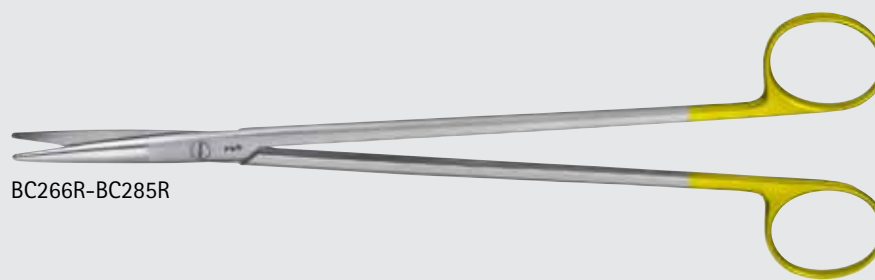

BC266R-BC285R

**DUROTIP TC NELSON-METZENBAUM  
Dissecting Scissors**

Catalog Number	Tip	Blade	Length (in.)
BC266R	B/B	STR	9
BC267R	B/B	CVD	9
BC279R	B/B	CVD	10 1/4
BC281R	B/B	CVD	11
BC282R	B/B	CVD	11 1/4
BC289R	B/B	CVD	11 3/4
BC285R	B/B	CVD	13 3/4

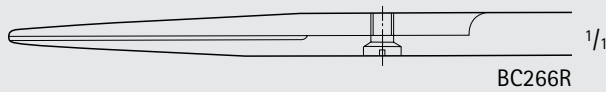

BC266R

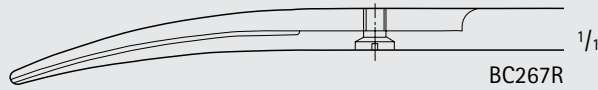

BC267R

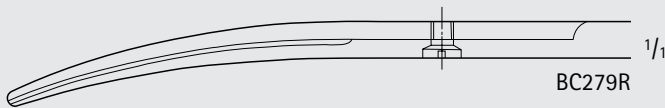

BC279R

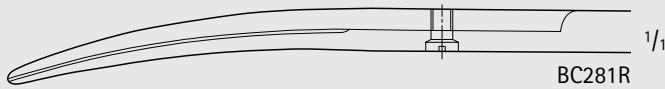

BC281R

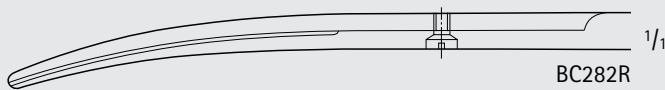

BC282R

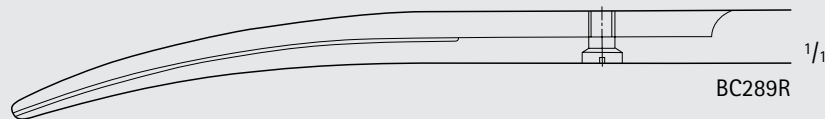

BC289R

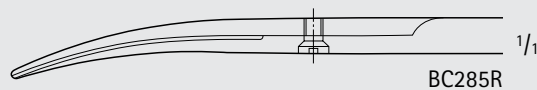

BC285R



INCHES

General Surgery  
DUROTIP™ TC Scissors

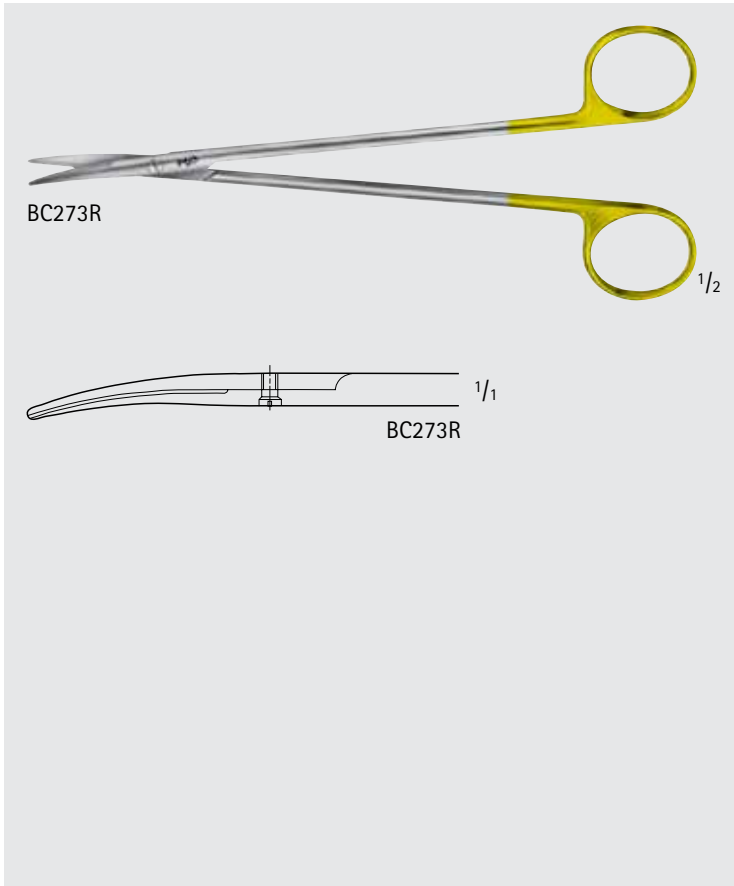

**DUROTIP TC TOENNIS-ADSON**  
Dissecting Scissors, Delicate

Catalog Number	Tip	Blade	Length (in.)
BC273R	B/B	CVD	6 7/8

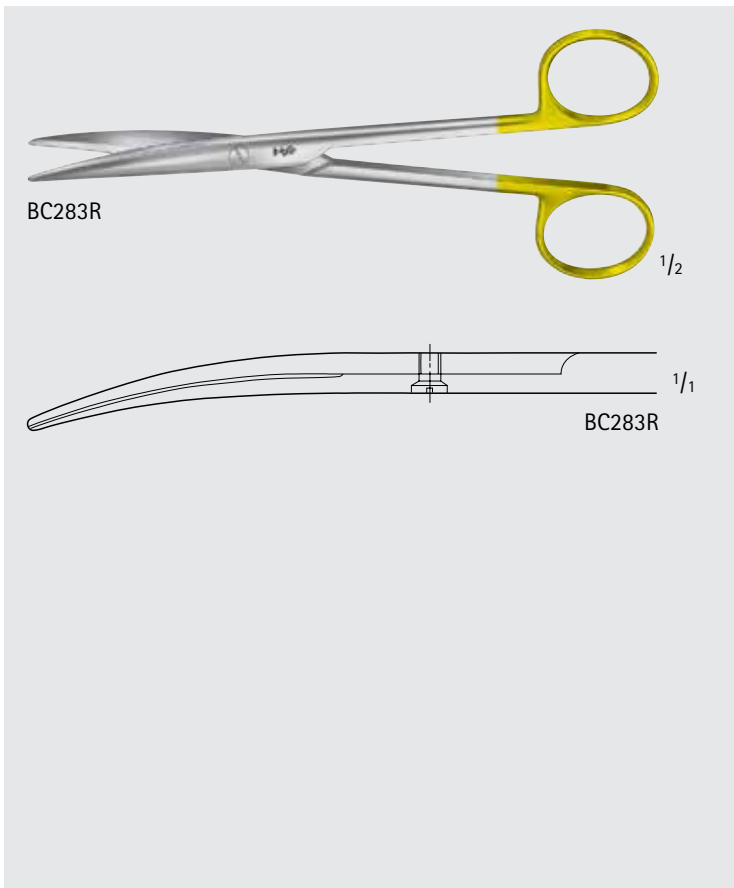

**DUROTIP TC LEXER** Dissecting Scissors,  
Delicate

Catalog Number	Tip	Blade	Length (in.)
BC283R	B/B	CVD	6 1/2



**Wavecut**

■ Wavecut scissors have one serrated cutting edge to prevent tissue from slipping. The W after the item number indicates the scissors are the wavecut style, e.g. BC211W.



BC253W

1/2

**DUROTIP TC MAYO Wavecut Dissecting Scissors, Beveled Blades**

Catalog Number	Tip	Blade	Length (in.)
BC253W	B/B	CVD	6 3/4

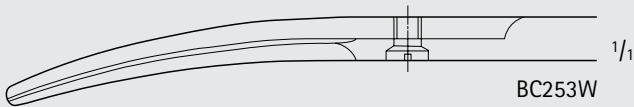

1/1

BC253W



BC259W

1/2

**DUROTIP TC Baby METZENBAUM Wavecut Dissecting Scissors, Delicate**

Catalog Number	Tip	Blade	Length (in.)
BC259W	B/B	CVD	5 3/4

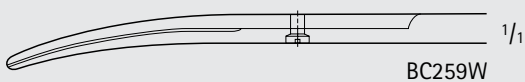

1/1

BC259W



INCHES

# General Surgery

## DUROTIP™ TC Scissors



BC261W-BC265W

Catalog Number	Tip	Blade	Length (in.)
BC261W	B/B	CVD	5 3/4
BC263W	B/B	CVD	7
BC265W	B/B	CVD	7 7/8

BC261W 1/1

BC263W 1/1

BC265W 1/1

BC271W-BC277W

Catalog Number	Tip	Blade	Length (in.)
BC271W	B/B	CVD	7
BC275W	B/B	CVD	7 7/8
BC277W	B/B	CVD	9

BC271W 1/1

BC275W 1/1

BC277W 1/1

BC287W

Catalog Number	Tip	Blade	Length (in.)
BC287W	B/B	CVD	9

BC287W 1/1

**DUROTIP TC TOENNIS-ADSON Wavecut  
 Dissecting Scissors**

Catalog Number	Tip	Blade	Length (in.)
BC273W	B/B	CVD	6 7/8

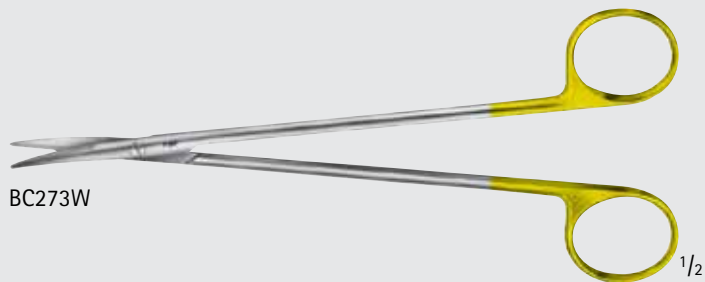

BC273W

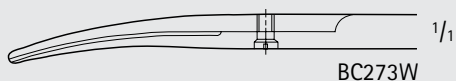

BC273W

**DUROTIP TC NELSON-METZENBAUM  
 Wavecut Dissecting Scissors**

Catalog Number	Tip	Blade	Length (in.)
BC267W	B/B	CVD	9
BC279W	B/B	CVD	10 1/4
BC281W	B/B	CVD	11

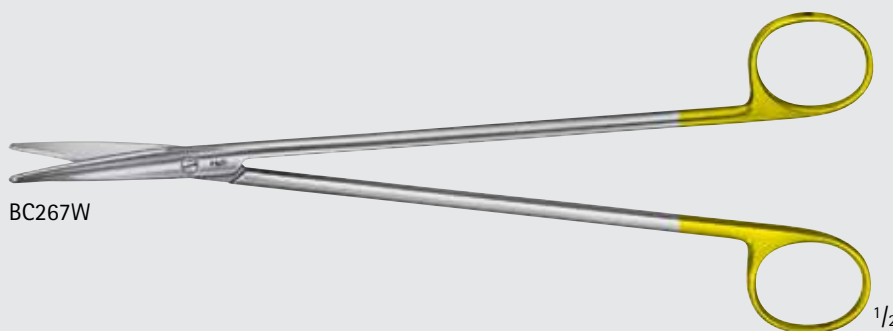

BC267W

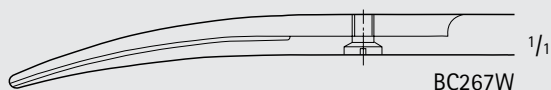

BC267W

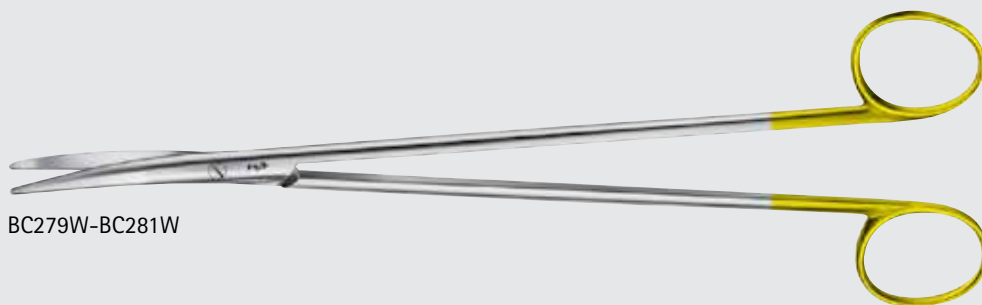

BC279W-BC281W

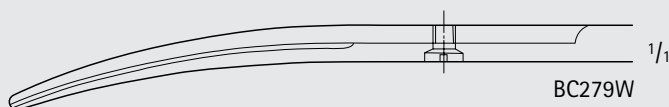

BC279W

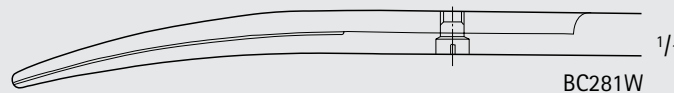

BC281W

# General Surgery

## DUROTIP™ TC Scissors

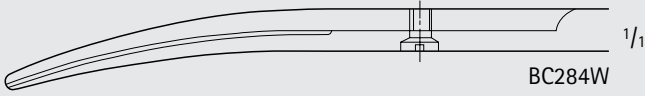
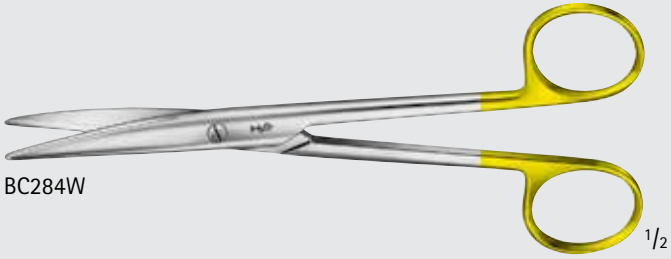
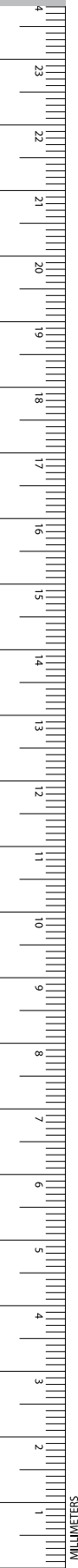

### DUROTIP TC MAYO-LEXER Wavecut Scissors

Catalog Number	Tip	Blade	Length (in.)
BC284W	B/B	CVD	6 1/2

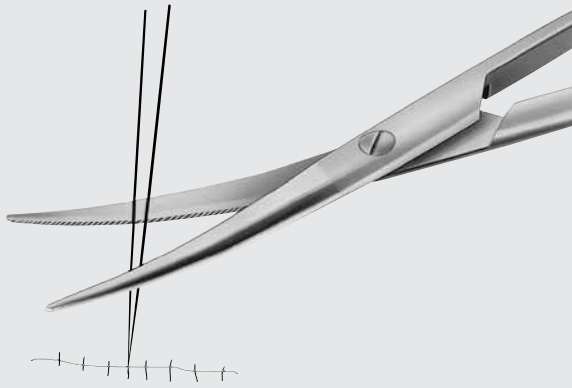

**DUROTIP TC Ligature Scissors**

- Carbide inserts guarantee permanent sharp cutting edge (also in the distal area of the blades).
- Wavecut prevents suture materials from slipping.
- Identified by 1 gold-plated ring.



BC294W-BC298W

**DUROTIP TC Ligature Wavecut Scissors**

Catalog Number	Tip	Blade	Length (in.)
BC294W	B/B	CVD	5 3/4
BC295W	B/B	CVD	7
BC296W	B/B	CVD	9
BC297W	B/B	CVD	10 1/4
BC298W	B/B	CVD	13 3/4

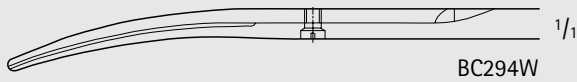

BC294W

1/1

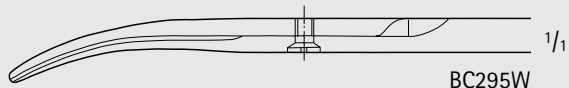

BC295W

1/1

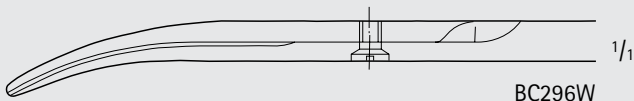

BC296W

1/1

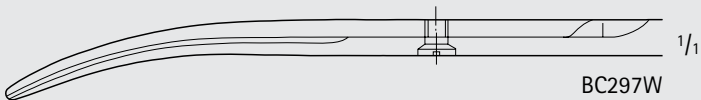

BC297W

1/1

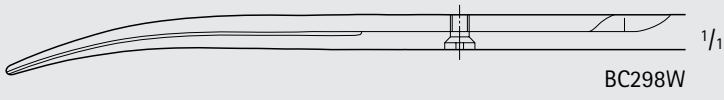

BC298W

1/1

# General Surgery

## SuperCut Scissors

### SuperCut Scissors

Your everyday black handle scissors

- **Microtome Edge**
  - Razor sharp cutting edge facilitates gentle cutting with minimal force
- **Wavecut Blade**
  - Prevents tissue from slipping out during the cutting process

For more information about SuperCut Scissors see brochure number **DOC821**.



BC900R-BC901R

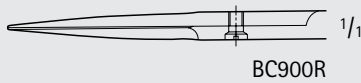

BC900R

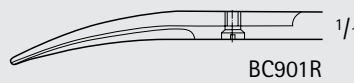

BC901R

### Iris SuperCut Scissors, Delicate

Catalog Number	Tip	Blade	Length (in.)
BC900R	S/S	STR	4 1/4
BC901R	S/S	CVD	4 1/4



BC903R

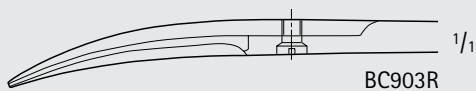

BC903R

### SuperCut Plastic Standard Scissors

Catalog Number	Tip	Blade	Length (in.)
BC903R	S/S	CVD	5



BC904R-BC905R

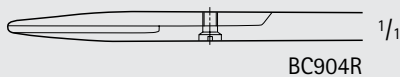

BC904R

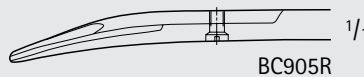

BC905R

### STEVENS SuperCut Scissors

Catalog Number	Tip	Tip Size (mm)	Blade	Length (in.)
BC904R	B/B	12	STR	4 1/8
BC905R	B/B	12	CVD	4 1/8

STEVENS SuperCut Scissors (continued)

Catalog Number	Tip	Tip Size (mm)	Blade	Length (in.)
BC906R	B/B	13	STR	4 1/4
BC907R	B/B	13	CVD	4 1/4

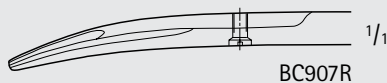
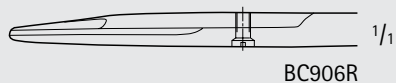
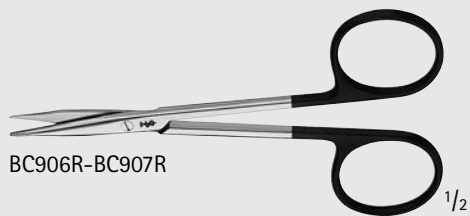

GOLDMANN-FOX SuperCut Scissors

Catalog Number	Tip	Blade	Length (in.)
BC909R	S/S	CVD	5 1/8

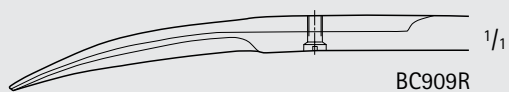

# General Surgery

## SuperCut Scissors

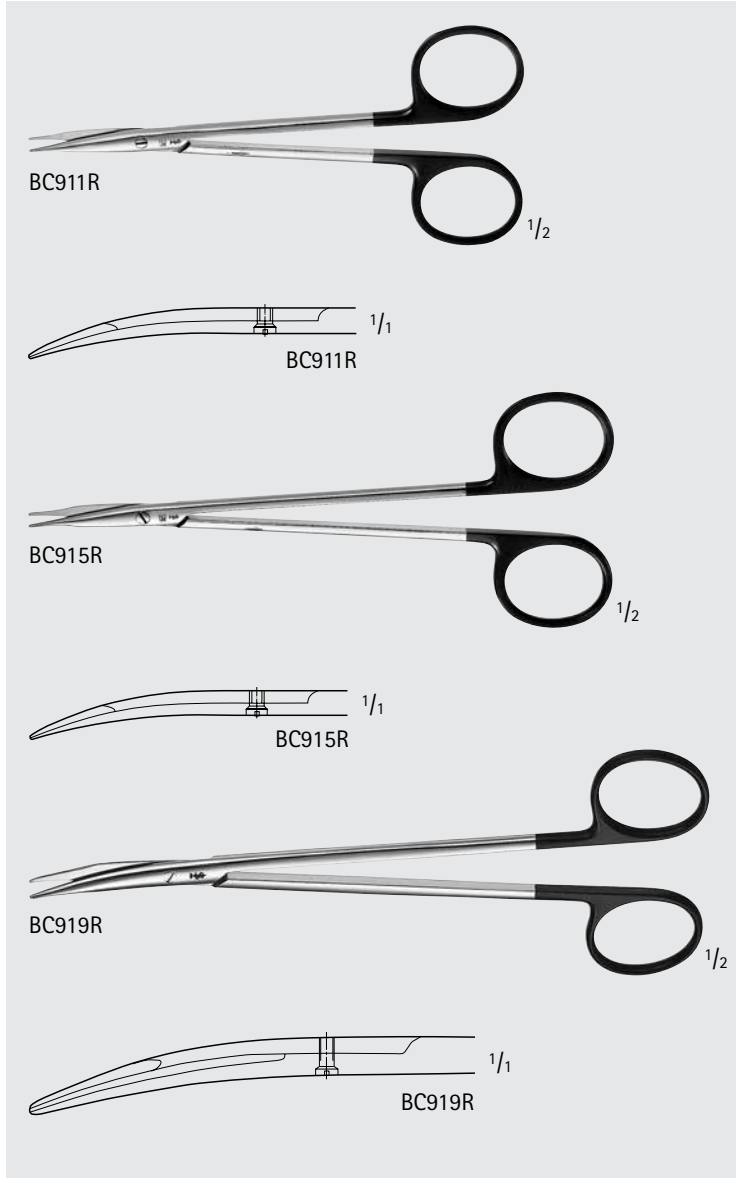
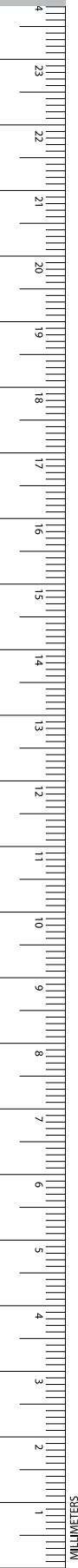

### JAMESON SuperCut Scissors, Delicate

Catalog Number	Tip	Blade	Length (in.)
BC911R	B/B	CVD	5 1/8
BC915R	B/B	CVD	6
BC919R	B/B	CVD	7

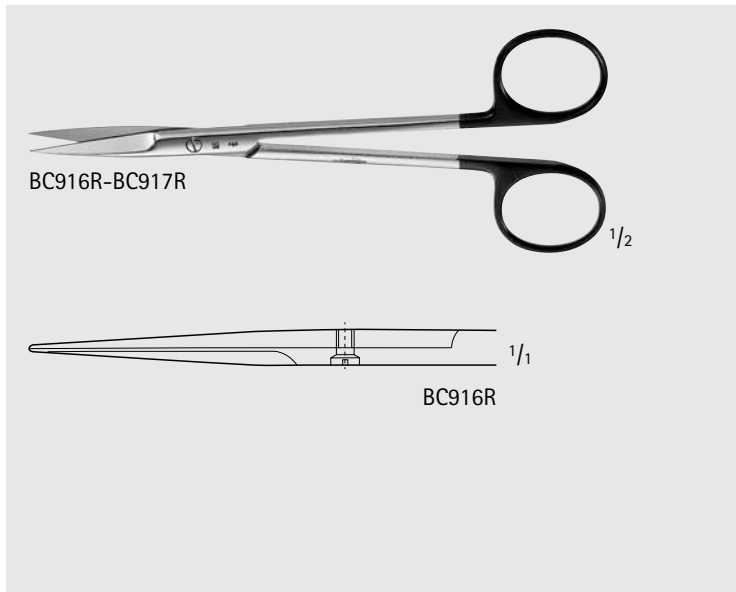

### JOSEPH SuperCut Scissors, Delicate

Catalog Number	Tip	Blade	Length (in.)
BC916R	S/S	STR	6
BC917R	S/S	CVD	6

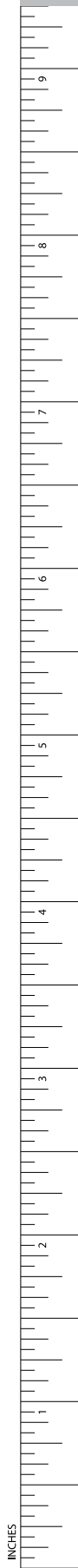

**GORNEY SuperCut Scissors, Delicate**

Catalog Number	Tip	Blade	Length (in.)
BC920R	B/B	STR	7 3/4
BC921R	B/B	CVD	7 3/4



BC920R-BC921R

1/2

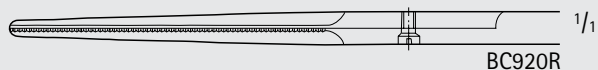

BC920R

1/1

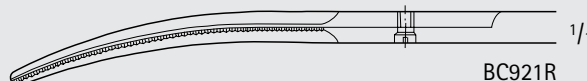

BC921R

1/1

**KAYE SuperCut Facelift Scissors, Delicate**

Catalog Number	Tip	Blade	Length (in.)
BC933R	B/B	CVD	7 3/4

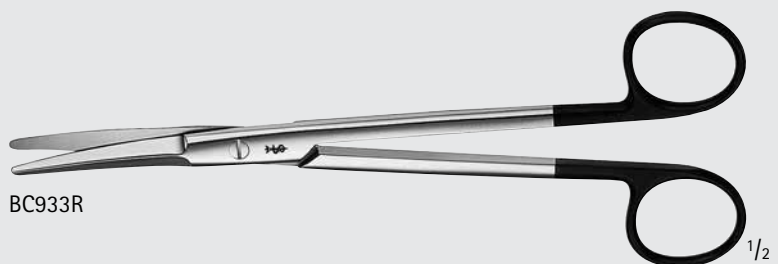

BC933R

1/2

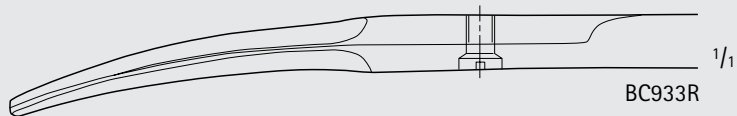

BC933R

1/1

**MAYO SuperCut Scissors, Delicate**

Catalog Number	Tip	Blade	Length (in.)
BC926R	B/B	STR, BEVELED	5 3/4
BC927R	B/B	CVD, BEVELED	5 3/4
BC924R	B/B	STR, ROUND	6 1/2
BC925R	B/B	CVD, ROUND	6 1/2



BC926R-BC927R

1/2

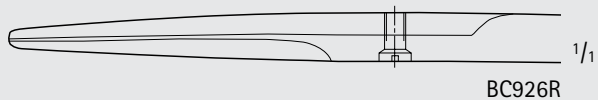

BC926R

1/1



BC927R

1/1



BC924R-BC925R

1/2

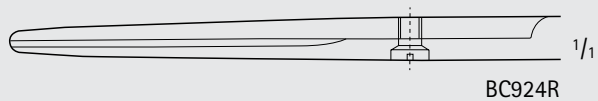

BC924R

1/1

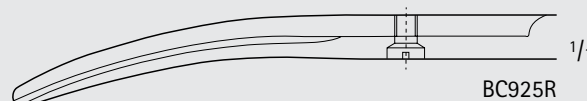

BC925R

1/1

# General Surgery

## SuperCut Scissors

MAYO SuperCut Scissors, Beveled

Catalog Number	Tip	Blade	Length (in.)
MG216R	B/B	STR	9
BC922R	B/B	STR	10
BC938R	B/B	STR	12
MG087R	B/B	CVD	9
BC929R	B/B	CVD	11

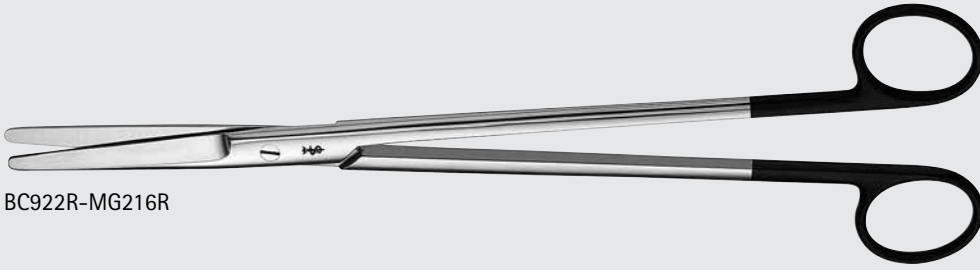

BC922R-MG216R

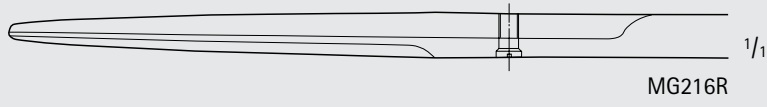

MG216R

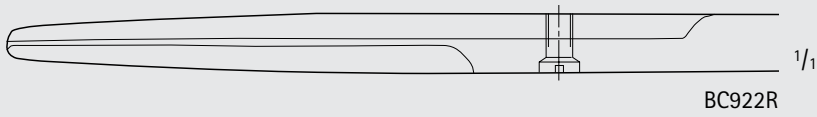

BC922R

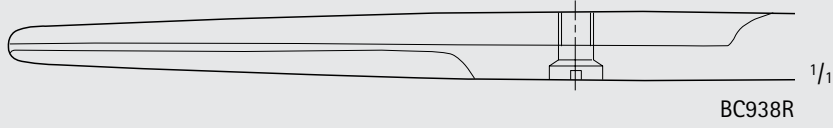

BC938R

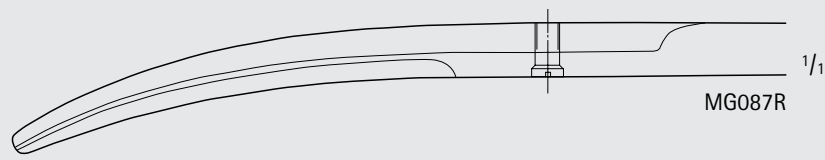

MG087R

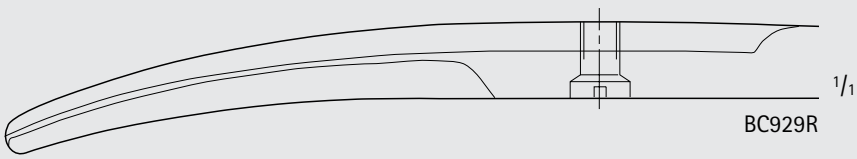

BC929R

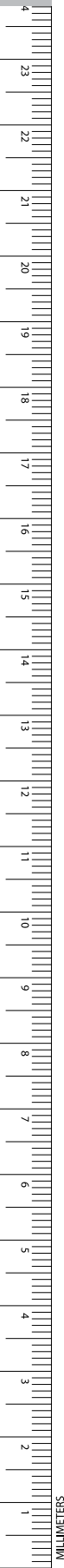

Baby METZENBAUM SuperCut Scissors, Delicate

Catalog Number	Tip	Blade	Length (in.)
BC930R	B/B	STR	4 1/2
BC931R	B/B	CVD	4 1/2



BC930R-BC931R

1/2

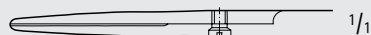

BC930R

1/1

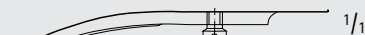

BC931R

1/1

METZENBAUM SuperCut Scissors, Delicate

Catalog Number	Tip	Blade	Length (in.)
BC934R	B/B	STR	5 3/4
BC936R	B/B	STR	7
BC935R	B/B	CVD	5 3/4
BC937R	B/B	CVD	7



BC934R-BC937R

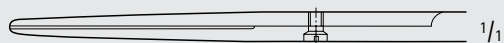

BC934R

1/1

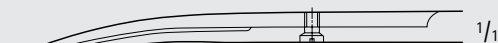

BC935R

1/1

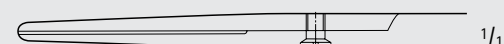

BC936R

1/1

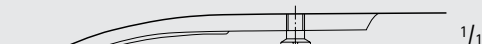

BC937R

1/1

# General Surgery

## SuperCut Scissors

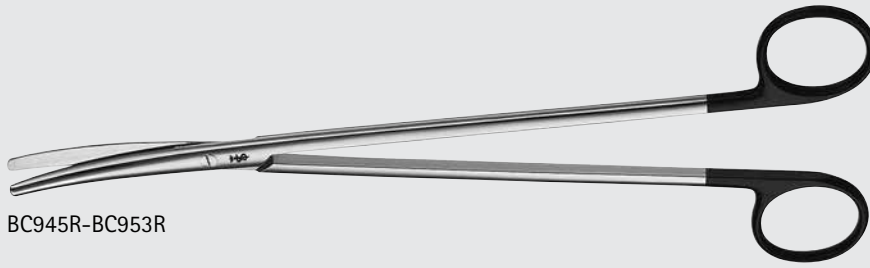

BC945R-BC953R

### METZENBAUM SuperCut Scissors, Delicate

Catalog Number	Tip	Blade	Length (in.)
BC945R	B/B	CVD	9
BC947R	B/B	CVD	10 1/4
BC949R	B/B	CVD	11 1/4
BC951R	B/B	CVD	11 3/4
BC953R	B/B	CVD	14

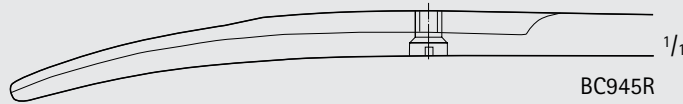

BC945R

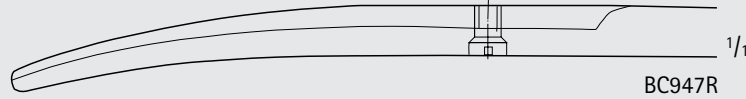

BC947R

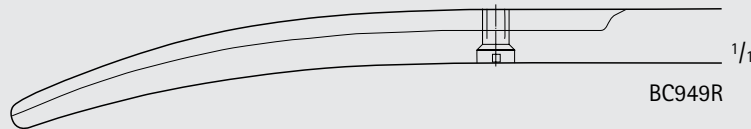

BC949R

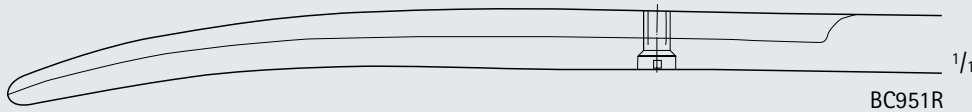

BC951R

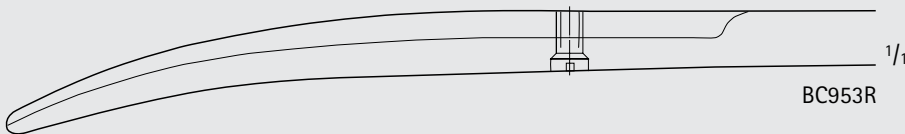

BC953R

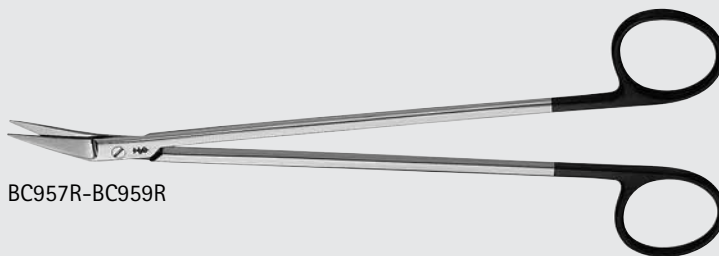

BC957R-BC959R

### POTTS-SMITH SuperCut Scissors

Catalog Number	Tip	Blade Angle	Blade Size (mm)	Length (in.)
BC957R	B/B	25°	22	7 1/2
BC958R	B/B	45°	20	7 1/4
BC959R	B/B	60°	19	7



BC957R



BC958R



BC959R

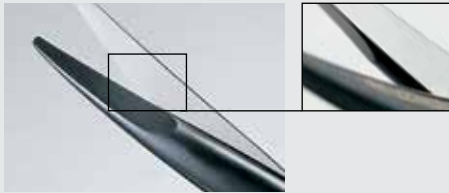

Microtome Edge

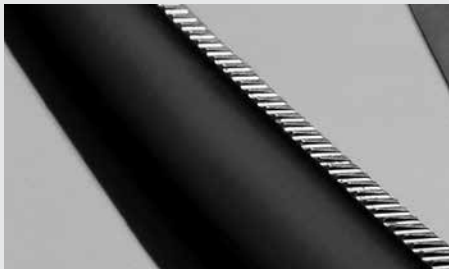

Wavecut

Noir Supreme Cut Scissors

- **Noir**  
The combination of the renowned Aesculap Tungsten Carbide technology with the Aesculap Noir coating results in an extremely high surface hardness and therefore high wear resistance in daily hospital use.
- **Microtome edge**  
The extremely sharp cutting edge of the scissors blade facilitates gentle cutting of tissue with minimal use of force.
- **Wavecut** prevents tissue from slipping out during the cutting process.
- The WB after the item number indicates the Noir scissors are the wavecut style, e.g. BC211WB.

For more information about Noir Supreme Cut Scissors see our brochure number DOC637.



BC252B-BC253WB

1/2



1/1

BC252B



1/1

BC253B, BC253WB

Noir MAYO Dissecting Scissors

Catalog Number	Tip	Blade	Length (in.)
BC252B	B/B	STR	6 3/4
BC253B	B/B	CVD	6 3/4
BC253WB	B/B	CVD	6 3/4



BC284B-BC284WB

1/2



1/1

BC284B-BC284WB

Noir MAYO-LEXER Dissecting Scissors

Catalog Number	Tip	Blade	Length (in.)
BC284B	B/B	CVD	6 1/2
BC284WB	B/B	CVD	6 1/2



INCHES

# General Surgery

## Noir™ Supreme Cut Scissors





BC283B-BC283WB 1/2



BC283B-BC283WB 1/1

### Noir LEXER Dissecting Scissors

Catalog Number	Tip	Blade	Length (in.)
BC283B	B/B	DEL, CVD	6 1/2
BC283WB	B/B	DEL, CVD	6 1/2



BC210B-BC211WB 1/2



BC210B 1/1



BC211B, BC211WB 1/1

### Noir Iris Dissecting Scissors

Catalog Number	Tip	Blade	Length (in.)
BC210B	S/S	STR	4 1/4
BC211B	S/S	CVD	4 1/4
BC211WB	S/S	CVD	4 1/4



BC273B-BC273WB 1/2



BC273B-BC273WB 1/1

### Noir TOENNIS-ADSON Dissecting Scissors

Catalog Number	Tip	Blade	Length (in.)
BC273B	B/B	DEL, CVD	6 7/8
BC273WB	B/B	DEL, CVD	6 7/8

# General Surgery

## Noir™ Supreme Cut Scissors

### Noir METZENBAUM Dissecting Scissors

Catalog Number	Tip	Blade	Length (in.)
BC261B	B/B	CVD	5 3/4
BC261WB	B/B	CVD	5 3/4
BC263B	B/B	CVD	7
BC263WB	B/B	CVD	7
BC271B	B/B	DEL, CVD	7
BC271WB	B/B	DEL, CVD	7
BC265B	B/B	CVD	7 7/8
BC265WB	B/B	CVD	7 7/8
BC275B	B/B	DEL, CVD	7 7/8
BC275WB	B/B	DEL, CVD	7 7/8
BC267B	B/B	CVD	9
BC267WB	B/B	CVD	9
BC277B	B/B	DEL, CVD	9
BC277WB	B/B	DEL, CVD	9

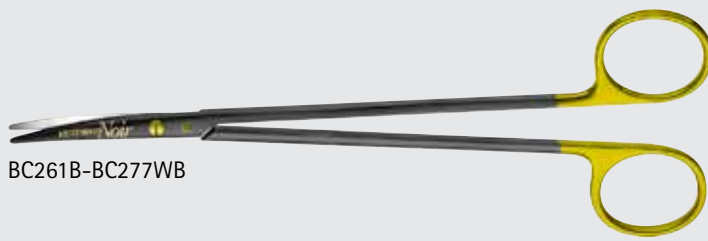

BC261B-BC277WB



BC261B, BC261WB

1/1



BC263B, BC263WB

1/1



BC271B, BC271WB

1/1



BC265B, BC265WB

1/1



BC275B, BC275WB

1/1



BC267B, BC267WB

1/1



BC277B, BC277WB

1/1



# General Surgery

## Noir™ Supreme Cut Scissors

### Noir NELSON-METZENBAUM Dissecting Scissors

Catalog Number	Tip	Blade	Length (in.)
BC279B	B/B	DEL, CVD	10 1/4
BC279WB	B/B	DEL, CVD	10 1/4
BC281B	B/B	DEL, CVD	11
BC281WB	B/B	DEL, CVD	11

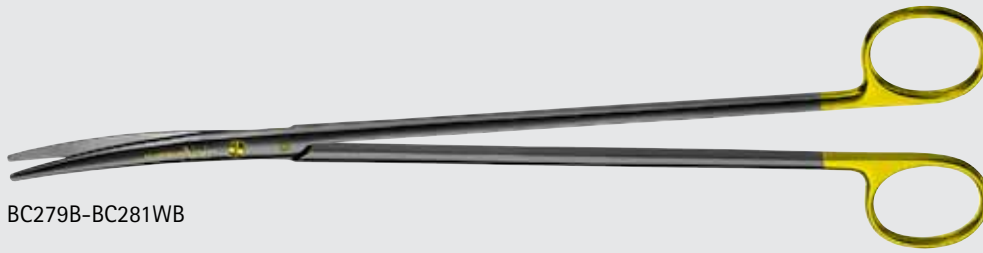

BC279B-BC281WB



BC279B, BC279WB



BC281B, BC281WB



**CONVERSE Needle Holder**

Catalog Number	Jaw	Length (in.)
BM200R	LONG SERR	5 1/8

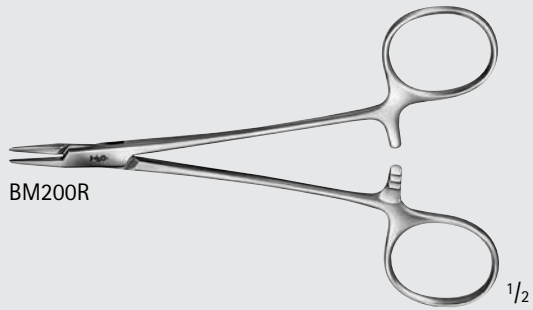

BM200R



BM200R

**HALSEY Needle Holder**

Catalog Number	Tip	Jaw	Length (in.)
BM201R	DEL	SMOOTH	5 1/8
BM205R	DEL	X-SERR	5 1/8

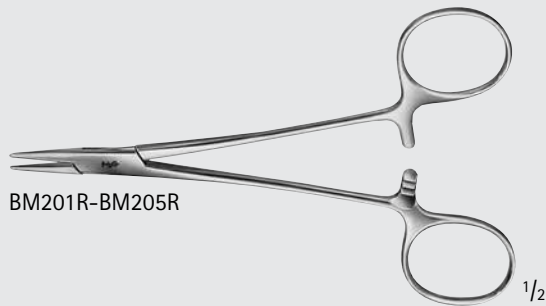

BM201R-BM205R

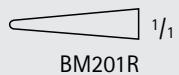

BM201R



BM205R

**WEBSTER Needle Holder**

Catalog Number	Jaw	Length (in.)
BM202R	SMOOTH	5

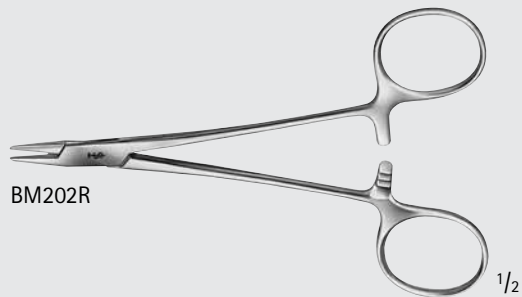

BM202R

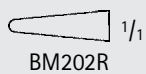

BM202R

**DERF Needle Holder**

Catalog Number	Jaw	Length (in.)
BM204R	SERR	5

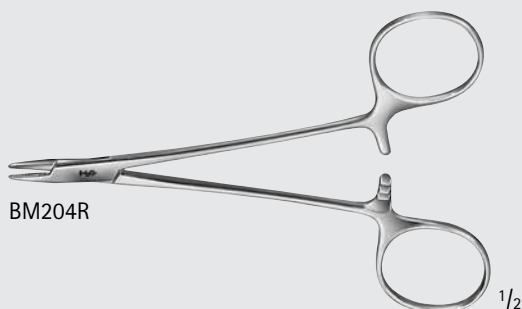

BM204R



BM204R



INCHES

# General Surgery

## Needle Holders



BM210R

1/2



BM210R

1/1

### DOYEN Needle Holder

Catalog Number	Jaw	Length (in.)
BM210R	X-SERR	5

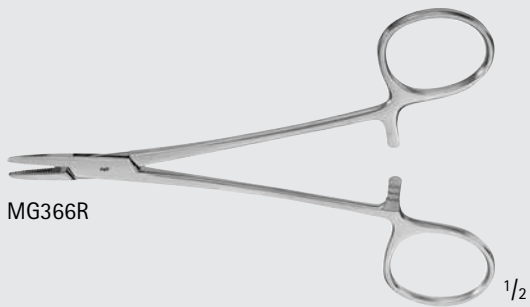

MG366R

1/2



MG366R

1/1

### COLLIER Needle Holder, Fenestrated

Catalog Number	Jaw	Length (in.)
MG366R	SERR	5

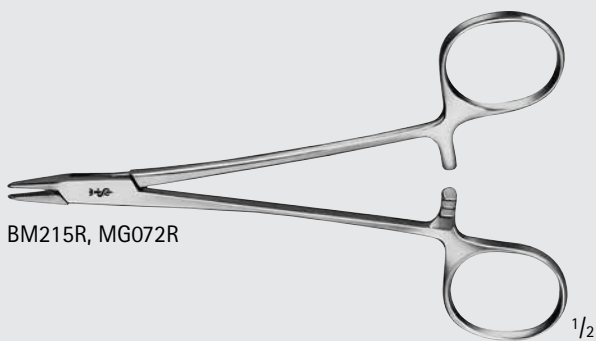

BM215R, MG072R

1/2



MG072R

1/1



BM215R

1/1

### BAUMGARTNER Needle Holder

Catalog Number	Jaw	Length (in.)
MG072R	SERR, GROOVED	5 1/4
BM215R	X-SERR	5 3/4



**CRILE-WOOD Needle Holder**

Catalog Number	Jaw	Length (in.)
BM218R	X-SERR	6
BM220R	X-SERR	6 1/4

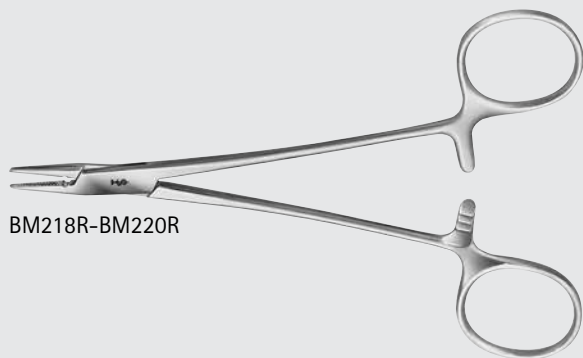

BM218R-BM220R

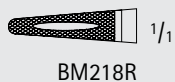

BM218R



BM220R

**CRILE-MURRAY Needle Holder**

Catalog Number	Jaw	Length (in.)
BM219R	SERR	6

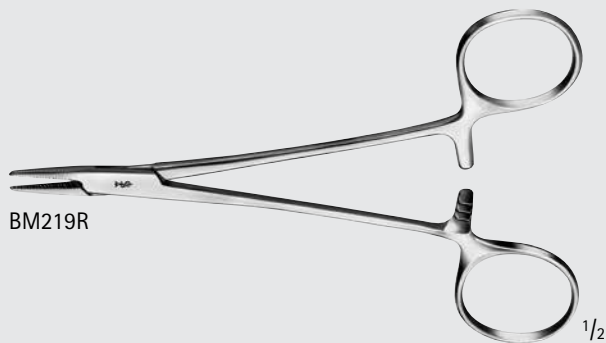

BM219R



BM219R

**ADSON Needle Holder, Fenestrated**

Catalog Number	Jaw	Length (in.)
BM224R	SERR	7

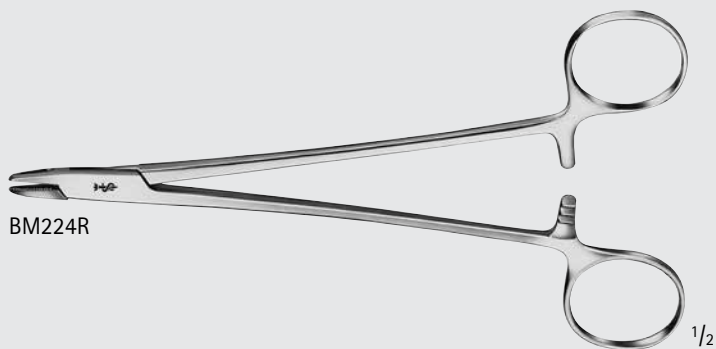

BM224R



BM224R



1/1

# General Surgery

## Needle Holders

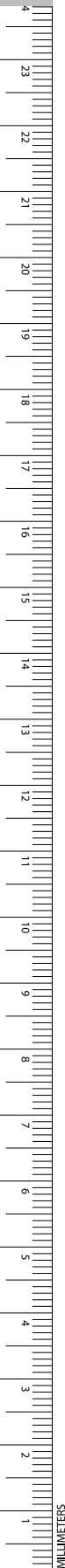

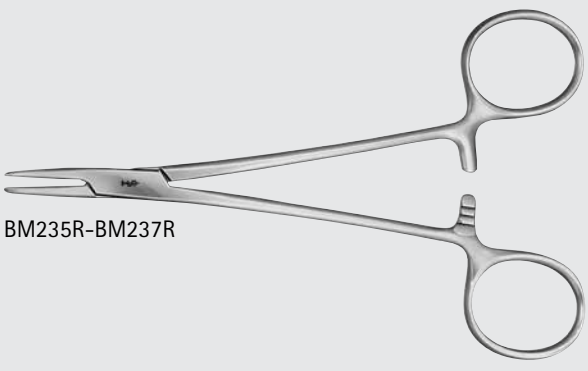



BM235R-BM237R



BM235R 1/1



BM236R 1/1



BM237R 1/1

### MAYO-HEGAR Needle Holder

Catalog Number	Jaw	Length (in.)
BM235R	X-SERR	6
BM236R	X-SERR	7 1/4
BM237R	X-SERR	7 7/8

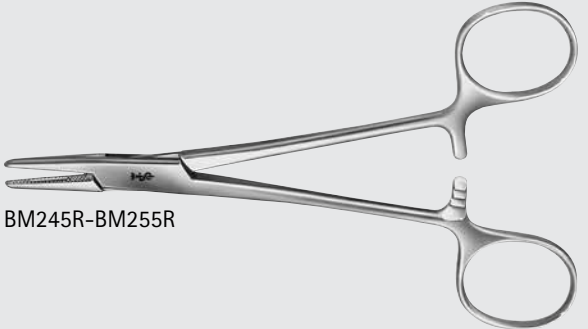

BM245R-BM255R



BM245R 1/1



BM247R 1/1



BM249R 1/1



BM255R 1/1

### HEGAR Needle Holder

Catalog Number	Tip	Jaw	Length (in.)
BM245R	HEAVY	X-SERR	6
BM247R	HEAVY	X-SERR	6 7/8
BM249R	HEAVY	X-SERR	8
BM255R	HEAVY	X-SERR	8

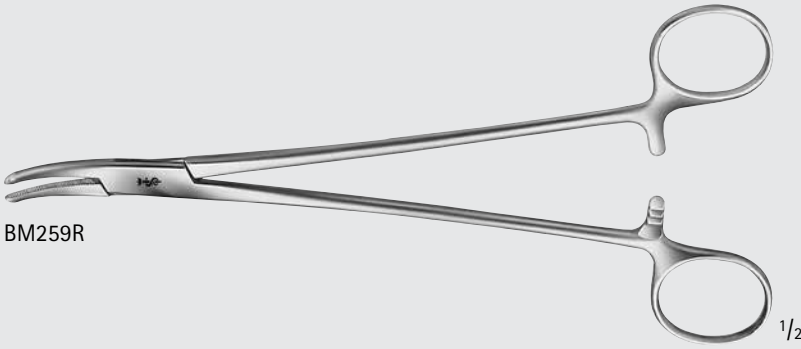

BM259R

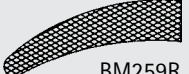

BM259R 1/1

### HEANEY Needle Holder

Catalog Number	Tip	Jaw	Length (in.)
BM259R	CVD	SERR	7 7/8



**JAMESON Needle Holder**

Catalog Number	Tip	Jaw	Length (in.)
BM270R	DEL	X-SERR	9

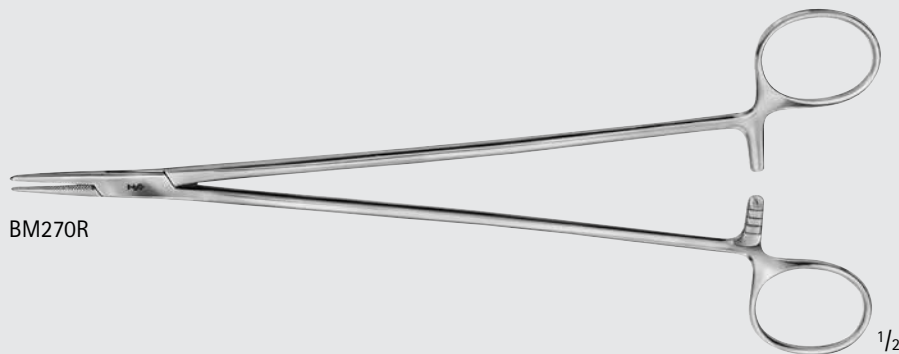

BM270R



BM270R

1/1

1/2

**WANGENSTEEN Needle Holder**

Catalog Number	Jaw	Length (in.)
BM272R	X-SERR	10 3/4

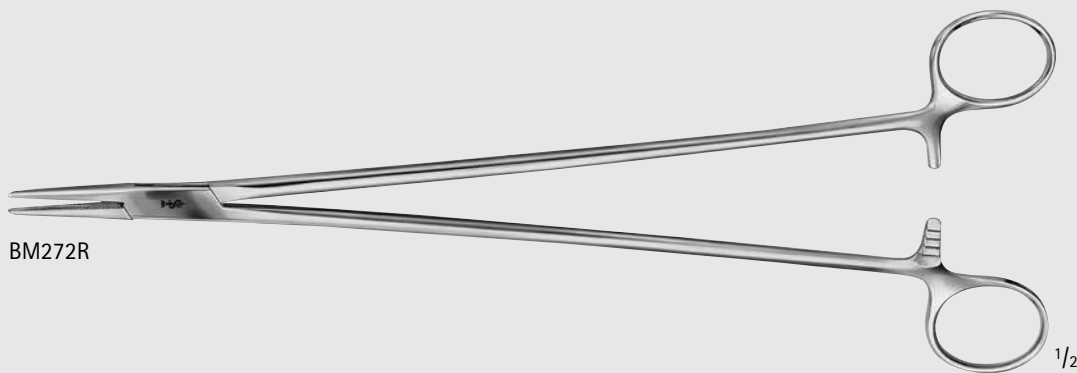

BM272R



BM272R

1/1

1/2

**MASSON Needle Holder**

Catalog Number	Jaw	Length (in.)
BM275R	X-SERR	10 1/2

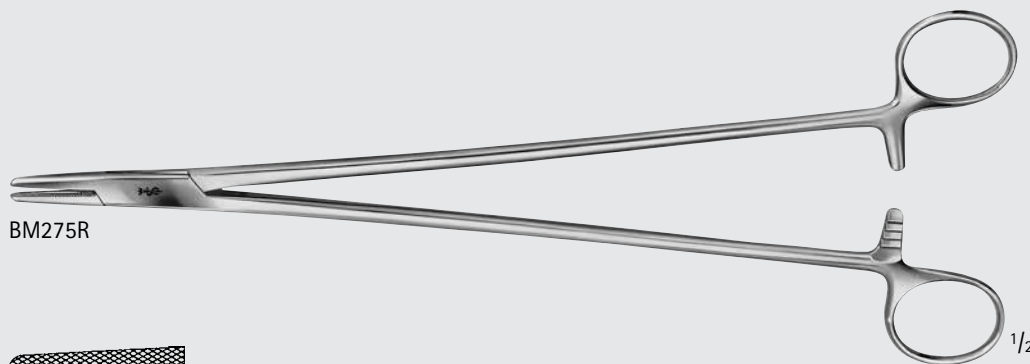

BM275R



BM275R

1/1

1/2

# General Surgery

## Needle Holders

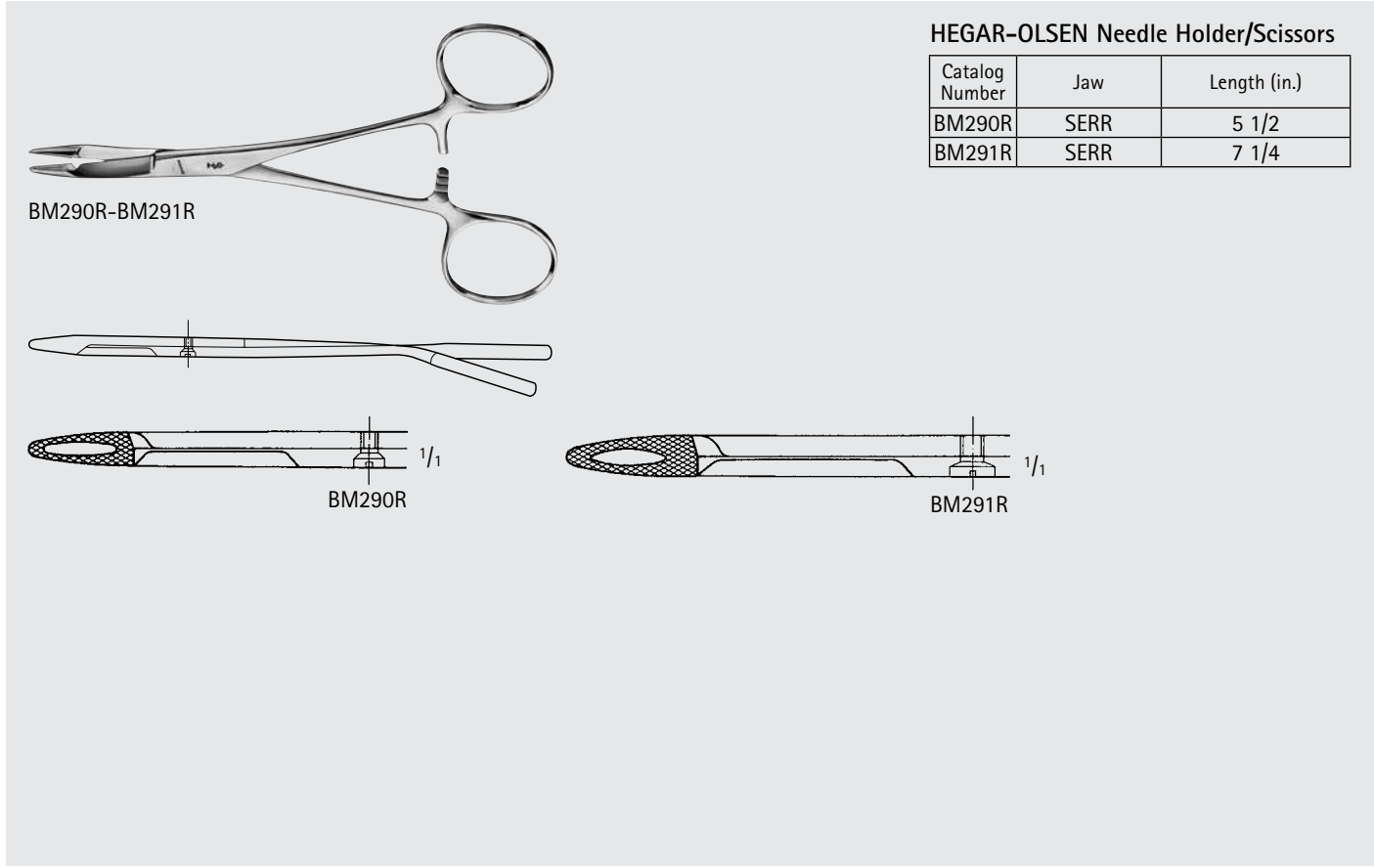

BM290R-BM291R

### HEGAR-OLSEN Needle Holder/Scissors

Catalog Number	Jaw	Length (in.)
BM290R	SERR	5 1/2
BM291R	SERR	7 1/4

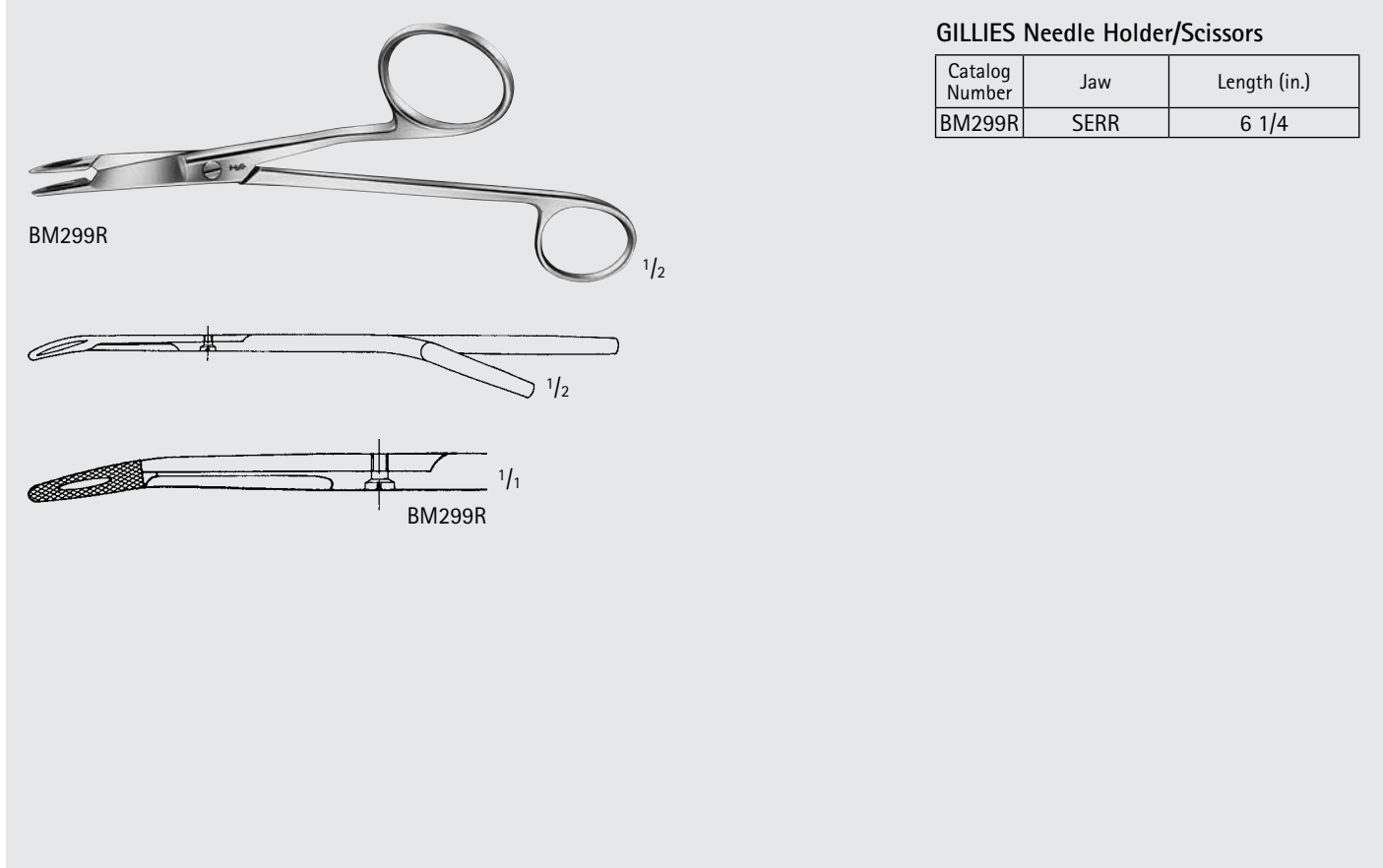

BM299R

### GILLIES Needle Holder/Scissors

Catalog Number	Jaw	Length (in.)
BM299R	SERR	6 1/4

# General Surgery

## DUROGRIP™ TC Needle Holders

Aesculap features Needle Holders with Tungsten Carbide (TC) inserts. A smooth jaw and three different serration patterns are available, depending on the size of the suture needle.

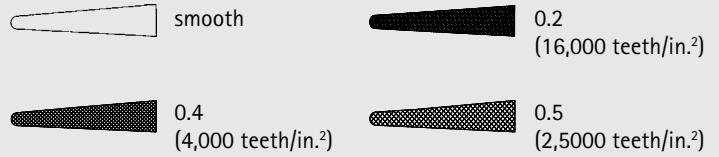
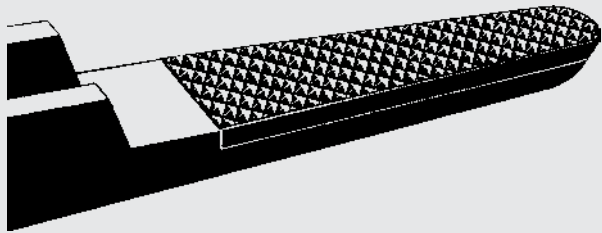

We recommend carbide inserts as follows:

Jaw Surface	Suture Material
Smooth	9/0 - 11/0
0.2 mm pitch of serration	6/0 - 10/0
0.4 mm pitch of serration	4/0 - 6/0
0.5 mm pitch of serration	up to 3/0



**DUROGRIP TC HELLBERG-KUPKA Needle Holder W/ Ergonomic Handle**

Catalog Number	Jaw	Length (in.)
BM320R	SERR	8 1/4

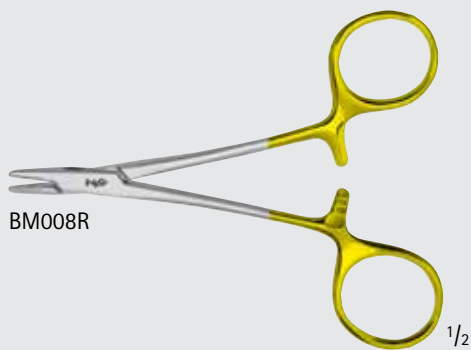
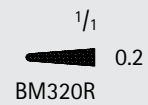

**DUROGRIP TC DERF Needle Holder**

Catalog Number	Jaw	Length (in.)
BM008R	SERR	4 3/4

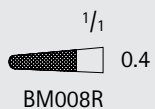

INCHES

# General Surgery

## DUROGRIP™ TC Needle Holders

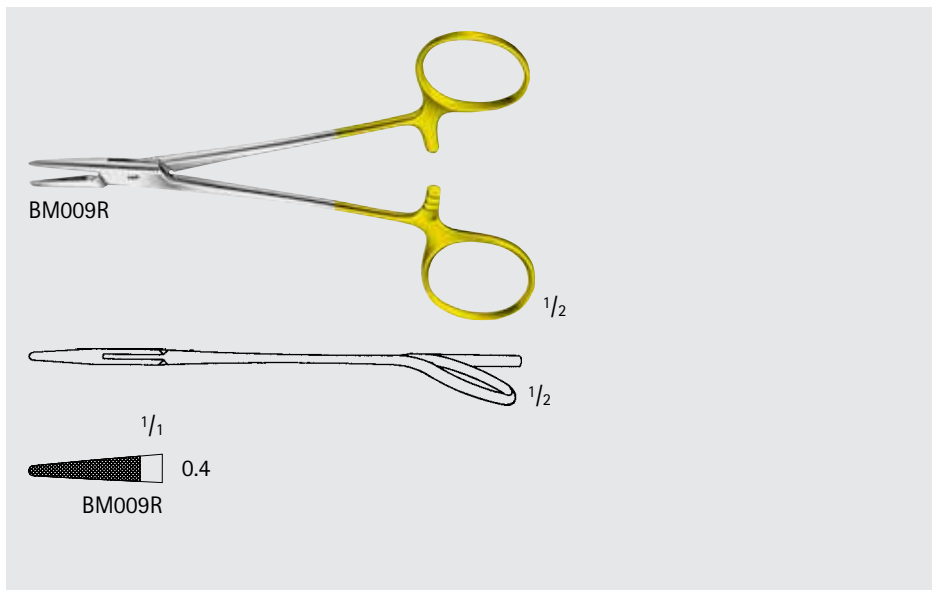

**DUROGRIP TC MASING Needle Holder**

Catalog Number	Jaw	Length (in.)
BM009R	SERR	5 1/8

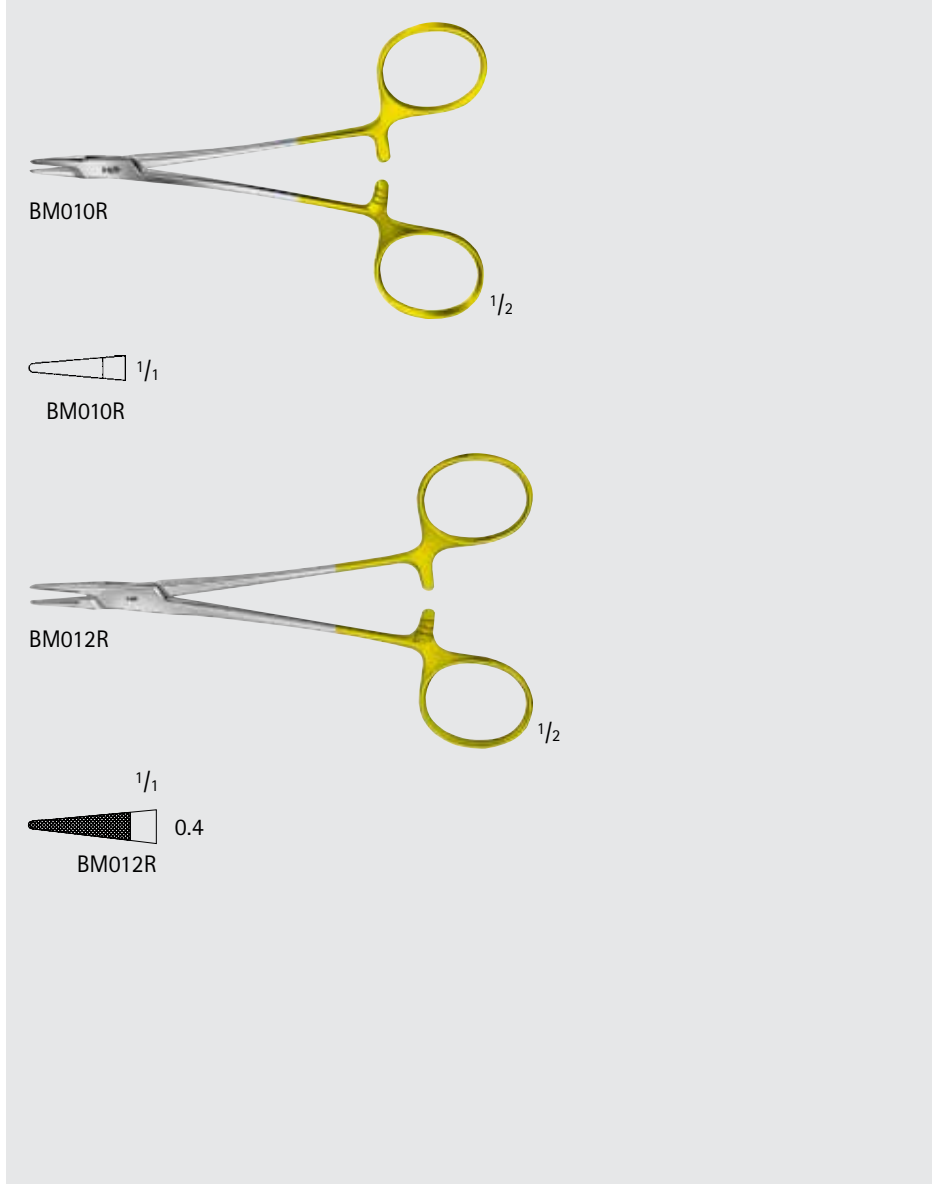

**DUROGRIP TC HALSEY Needle Holder**

Catalog Number	Jaw	Length (in.)
BM010R	SMOOTH	4 3/4
BM012R	SERR	5 1/8

**DUROGRIP TC CONVERSE Needle Holder**

Catalog Number	Jaw	Length (in.)
BM011R	SERR	5 1/8



BM011R

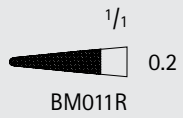

**DUROGRIP TC WEBSTER Needle Holder**

Catalog Number	Jaw	Length (in.)
BM014R	SMOOTH	5 1/8
BM024R	SERR	5 1/8

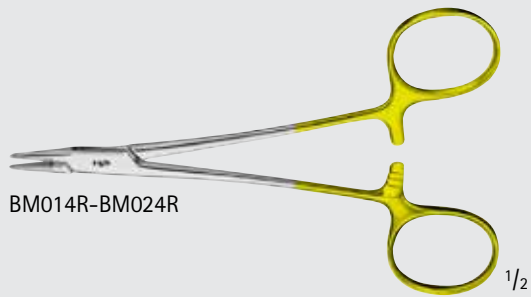

BM014R-BM024R

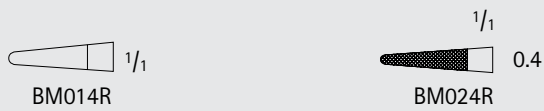

**DUROGRIP TC BAUMGARTNER Needle Holder**

Catalog Number	Jaw	Length (in.)
BM015R	SERR	5 3/4

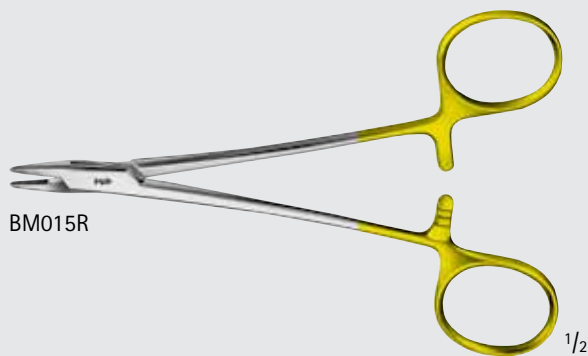

BM015R

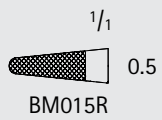

# General Surgery

## DUROGRIP™ TC Needle Holders

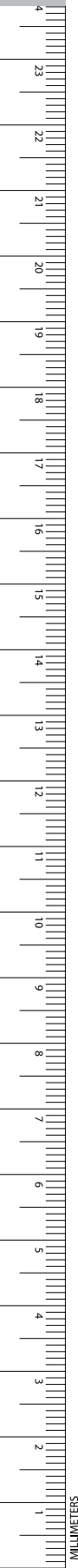

MG522R

1/2

1/1  
MG522R

DUROGRIP TC NEW ORLEANS Needle Holder		
Catalog Number	Jaw	Length (in.)
MG522R	SERR	7

BM020R-BM023R

1/1 0.4  
BM020R

1/1 0.4  
BM023R

DUROGRIP TC SAROT Needle Holder		
Catalog Number	Jaw	Length (in.)
BM020R	SERR	7
BM023R	SERR	10 1/4

BM013R

1/2

1/1 0.4  
BM013R

DUROGRIP TC Baby CRILE-WOOD Needle Holder		
Catalog Number	Jaw	Length (in.)
BM013R	SERR	6

General Surgery  
DUROGRIP™ TC Needle Holders

GENERAL SURGERY

DUROGRIP TC CRILE-WOOD Needle Holder

Catalog Number	Jaw	Length (in.)
BM016R	SERR	5 3/4
BM017R	SERR	7 1/4
BM019R	SERR	7 7/8
BM030R	SERR	10 5/8
BM021R	SERR	12
MB604R	SERR	14
BM029R	SMOOTH	6



BM016R, BM021R, MB604R

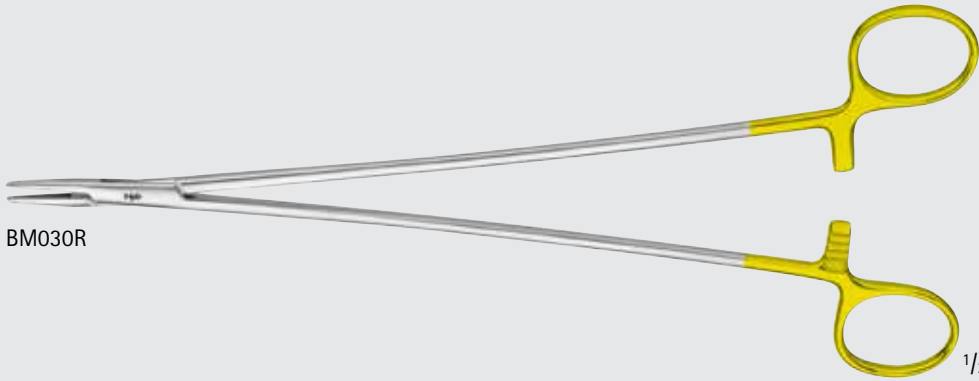
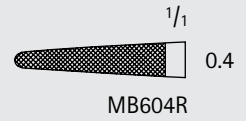
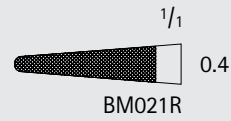
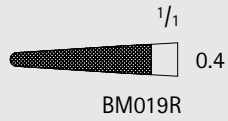
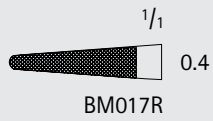
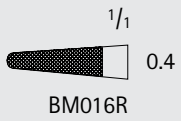

BM030R

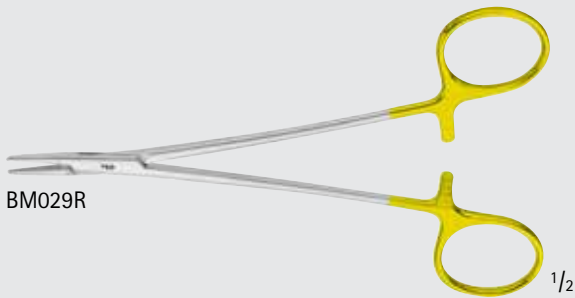
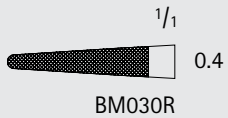

BM029R

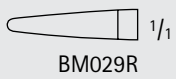

INCHES

# General Surgery

## DUROGRIP™ TC Needle Holders

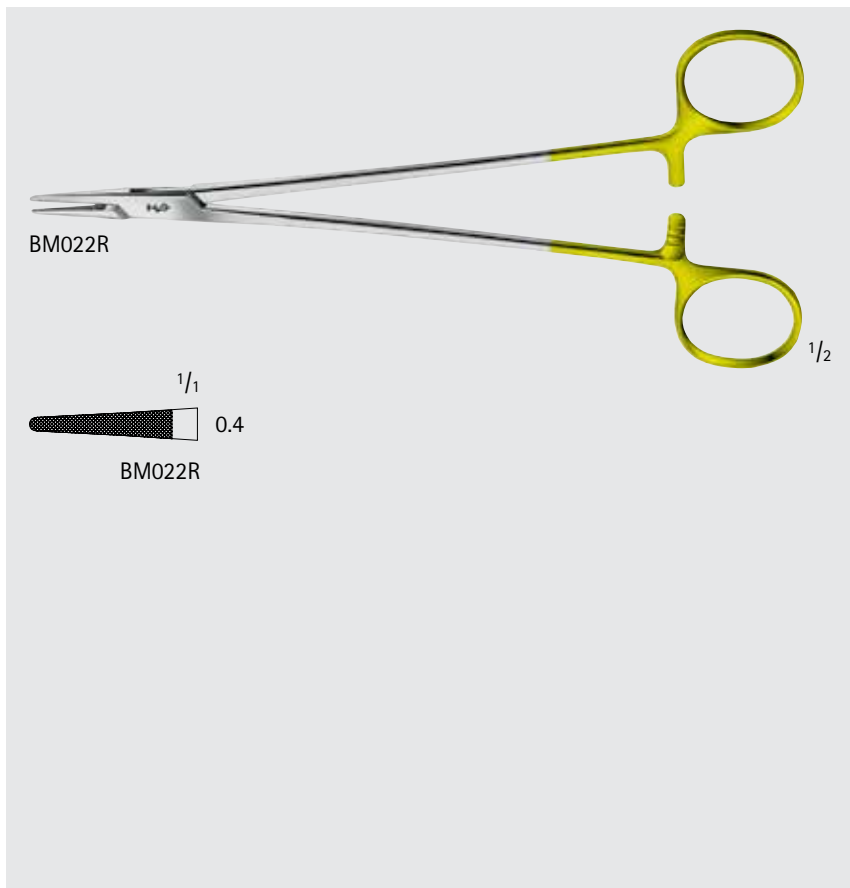

**DUROGRIP TC MAYO-HEGAR-SEELEY Needle Holder**

Catalog Number	Jaw	Length (in.)
BM022R	SERR	8

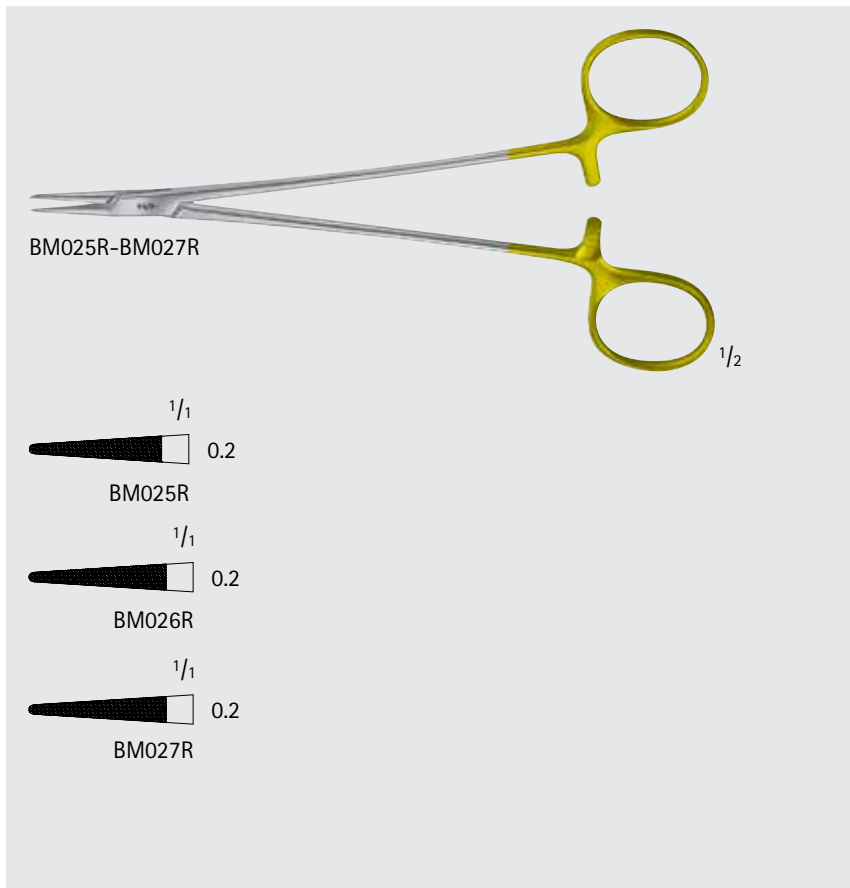

**DUROGRIP TC Fine Needle Holder**

Catalog Number	Tip	Jaw	Length (in.)
BM025R	X-DEL	SERR	7
BM026R	X-DEL	SERR	7 7/8
BM027R	X-DEL	SERR	9

DUROGRIP TC DEBAKEY Needle Holder

Catalog Number	Tip	Jaw	Length (in.)
BM032R	DEL	SERR	6
BM033R	DEL	SERR	6 1/2
BM035R	DEL	SERR	7
BM034R	DEL	SERR	8 1/4
BM036R	DEL	SERR	9
BM037R	DEL	SERR	10 1/4
BM038R	DEL	SERR	12
BM063R	X-DEL	SERR	6 1/2
BM064R	X-DEL	SERR	8 1/4
BM040R	X-DEL	SERR	12

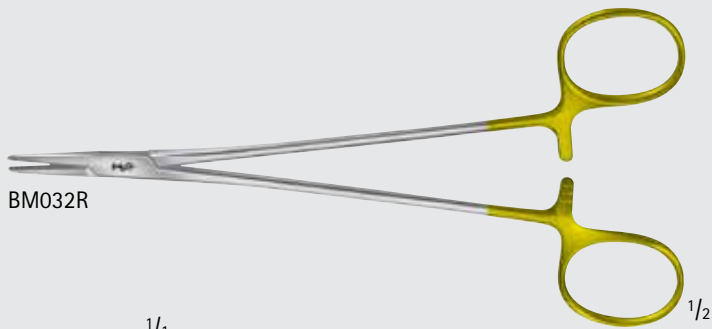

BM032R  
1/1  
0.4

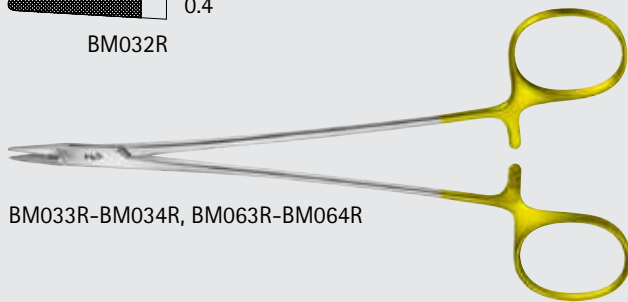

BM033R-BM034R, BM063R-BM064R

1/1  
0.4  
BM033R

1/1  
0.4  
BM034R

1/1  
0.2  
BM063R

1/1  
0.2  
BM064R

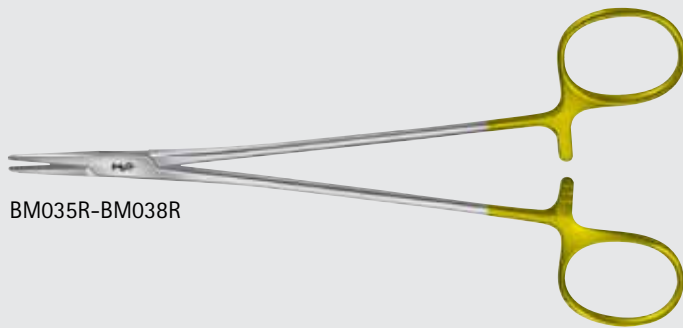

BM035R-BM038R

1/1  
0.4  
BM035R

1/1  
0.4  
BM036R

1/1  
0.4  
BM037R

1/1  
0.4  
BM038R

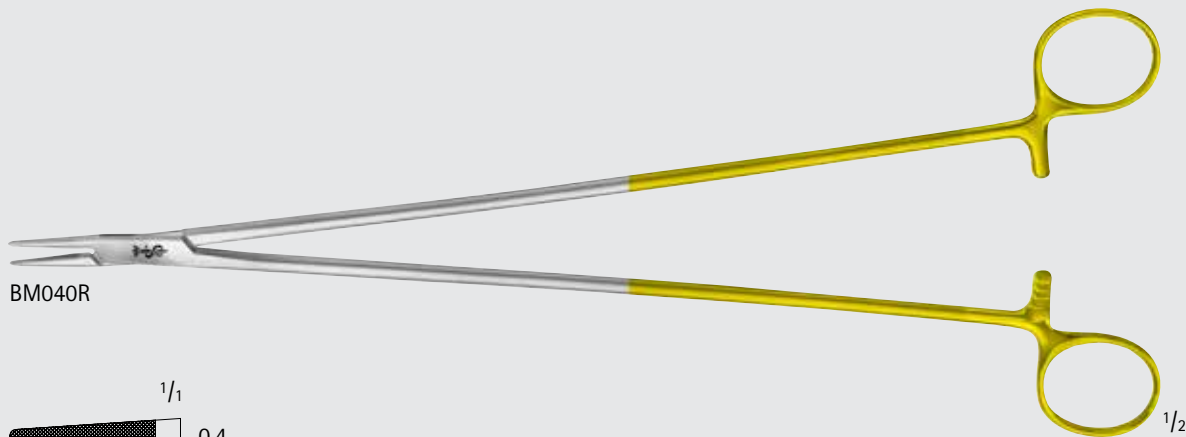

BM040R

1/1  
0.4  
BM040R



INCHES

# General Surgery

## DUROGRIP™ TC Needle Holders

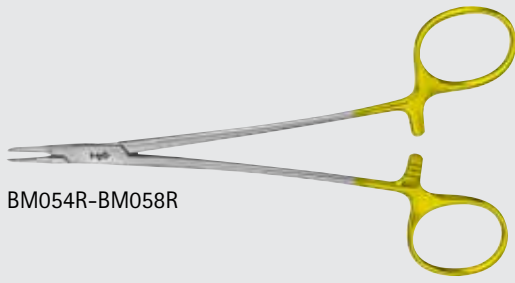

BM054R-BM058R

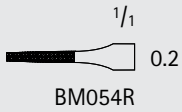

BM054R

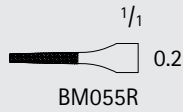

BM055R

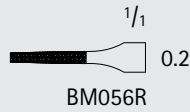

BM056R

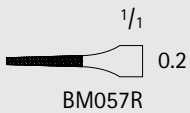

BM057R

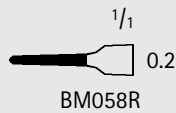

BM058R

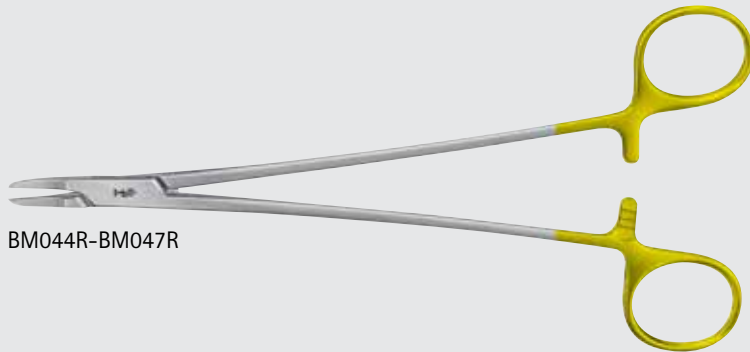

BM044R-BM047R



BM044R



BM045R

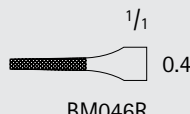

BM046R

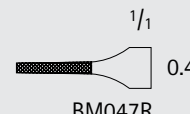

BM047R

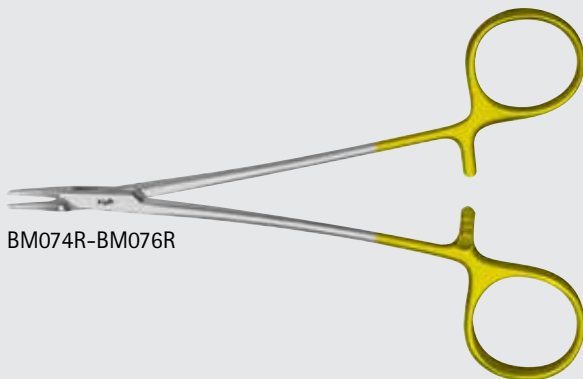

BM074R-BM076R



BM074R

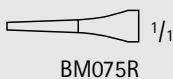

BM075R

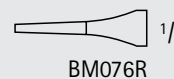

BM076R

### DUROGRIP TC RYDER Needle Holder

Catalog Number	Tip	Jaw	Length (in.)
BM054R	X-DEL	SERR	5 1/4
BM055R	X-DEL	SERR	6 1/8
BM056R	X-DEL	SERR	6 7/8
BM057R	X-DEL	SERR	8 1/4
BM058R	X-DEL	SERR	9
BM044R	DEL	SERR	5 1/4
BM045R	DEL	SERR	6 7/8
BM046R	DEL	SERR	7 3/4
BM047R	DEL	SERR	10 1/2
BM074R	DEL	SMOOTH	6
BM075R	DEL	SMOOTH	7
BM076R	DEL	SMOOTH	8 7/8

DUROGRIP TC FRENCH Eye Needle Holder

Catalog Number	Jaw	Length (in.)
MB606R	SERR	6 1/4
MB607R	SERR	7 1/4
MB611R	SERR	8
MB612R	SERR	9 1/4

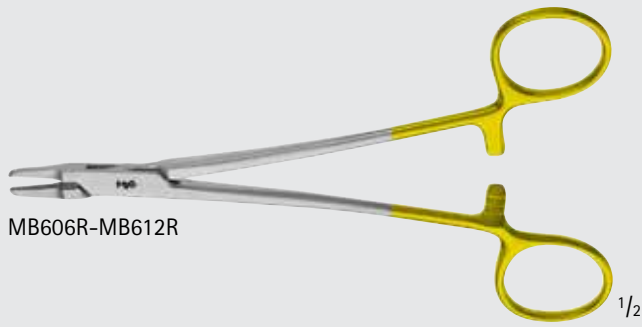

MB606R-MB612R

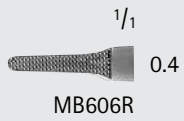

1/16

0.4

MB606R

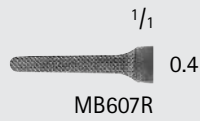

1/16

0.4

MB607R

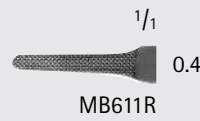

1/16

0.4

MB611R

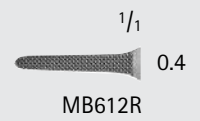

1/16

0.4

MB612R



INCHES

# General Surgery

## DUROGRIP™ TC Needle Holders



BM065R-BM070R

### DUROGRIP TC MAYO-HEGAR Needle Holder

Catalog Number	Jaw	Length (in.)
BM065R	SERR	6
BM066R	SERR	7 1/4
BM067R	SERR	8
BM068R	SERR	9 1/4
BM070R	SERR	10 1/2
BM069R	SERR	12
MB617R	SERR	14

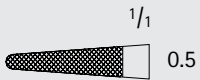

BM065R

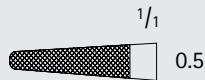

BM066R



BM067R



BM068R



BM070R

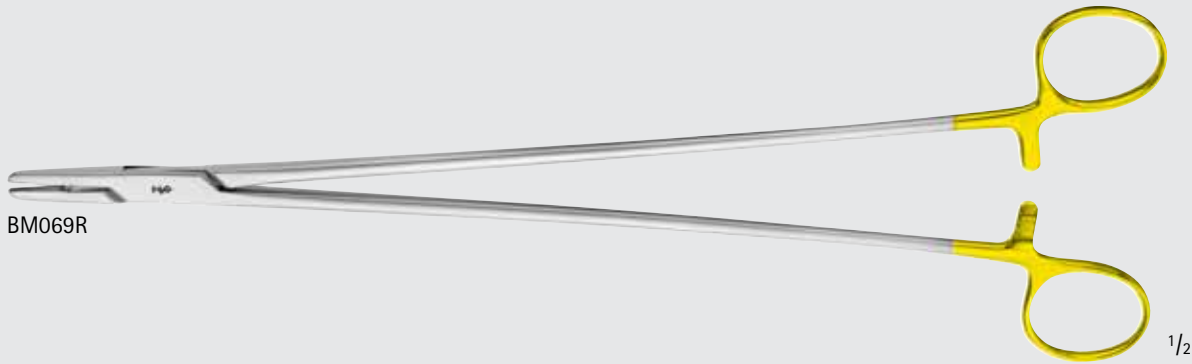

BM069R



BM069R

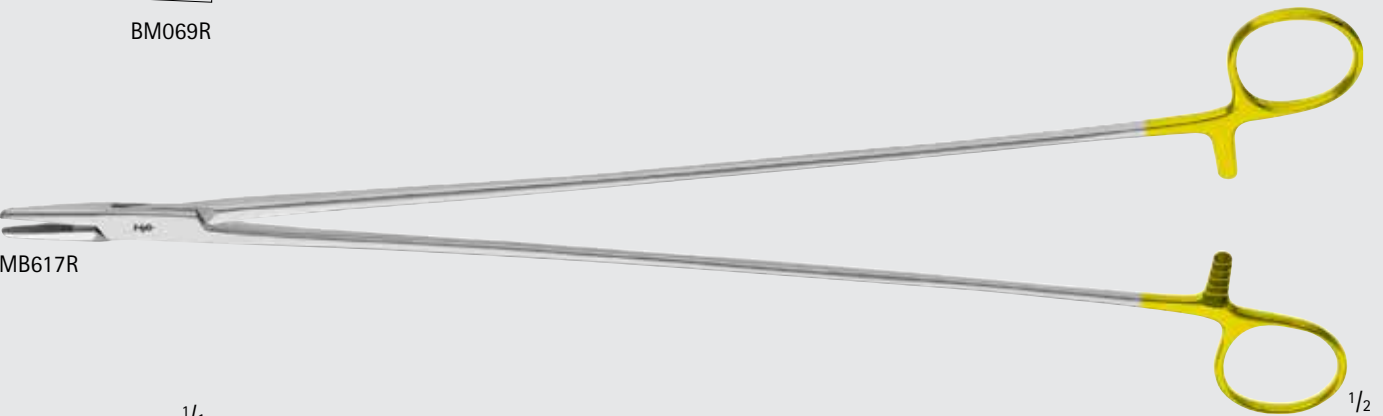

MB617R



MB617R

DUROGRIP TC HEGAR Needle Holder

Catalog Number	Tip	Jaw	Length (in.)
BM077R	HEAVY	SERR	8
BM078R	HEAVY	SERR	9 1/2

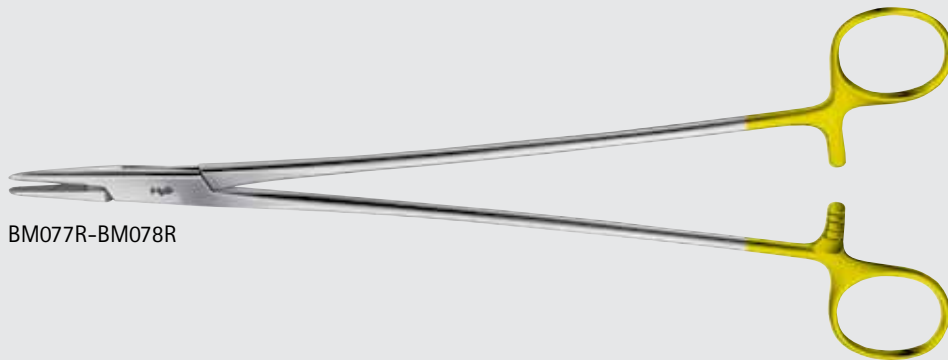

BM077R-BM078R

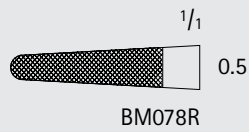
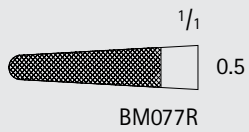

DUROGRIP TC WANGENSTEEN Needle Holder

Catalog Number	Jaw	Length (in.)
BM042R	SERR	10 3/4

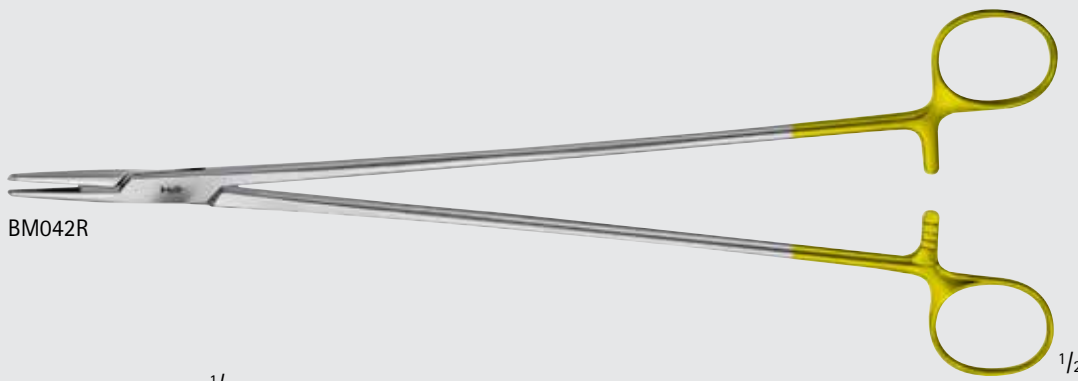

BM042R

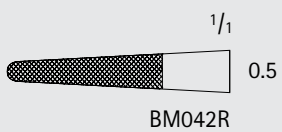

INCHES

# General Surgery

## DUROGRIP™ TC Needle Holders



### DUROGRIP TC MASSON Needle Holder

Catalog Number	Jaw	Length (in.)
BM090R	SERR	10 1/2

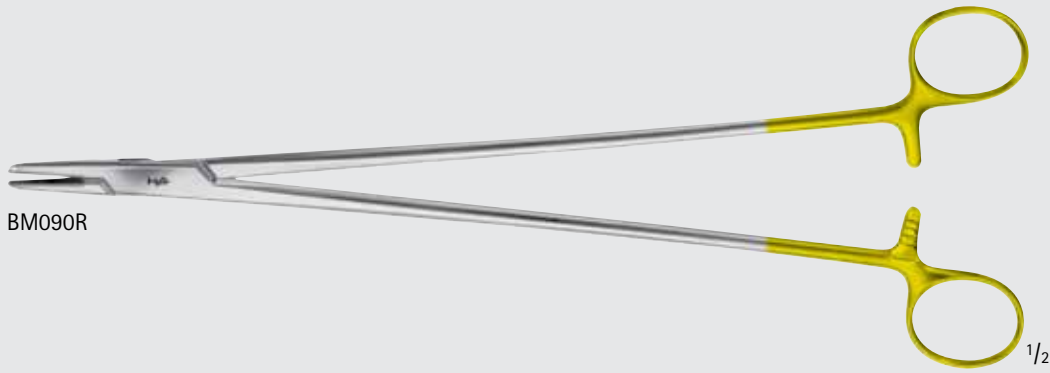

BM090R

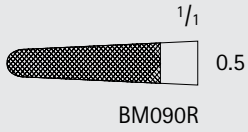

BM090R

### DUROGRIP TC MAYO-MASSON Needle Holder

Catalog Number	Jaw	Length (in.)
MB918R	SERR	16

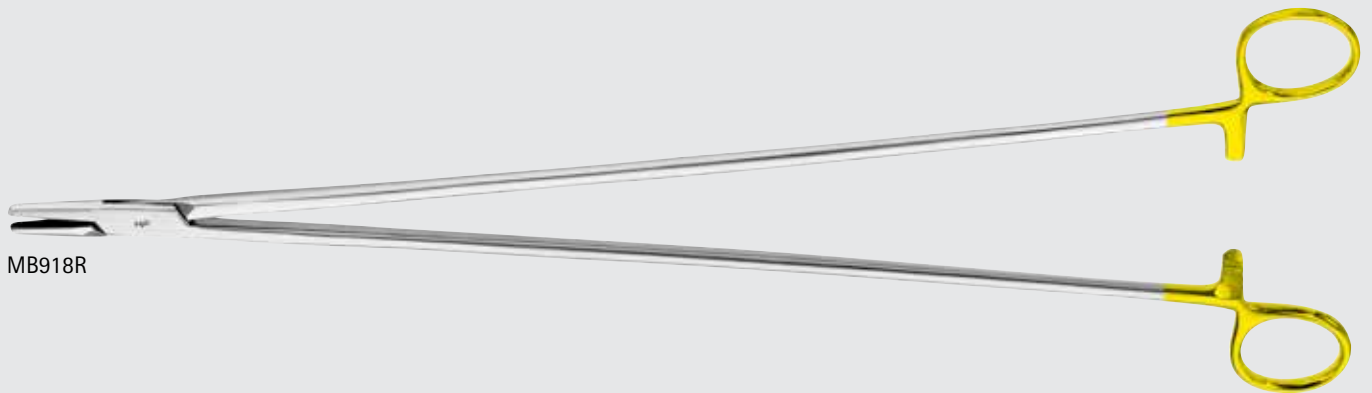

MB918R



MB918R

# General Surgery

## DUROGRIP™ TC Needle Holders

### DUROGRIP TC HEANEY Needle Holder

Catalog Number	Tip	Jaw	Length (in.)
BM081R	CVD	SERR	7 7/8
BM084R	CVD	SERR	10 1/4

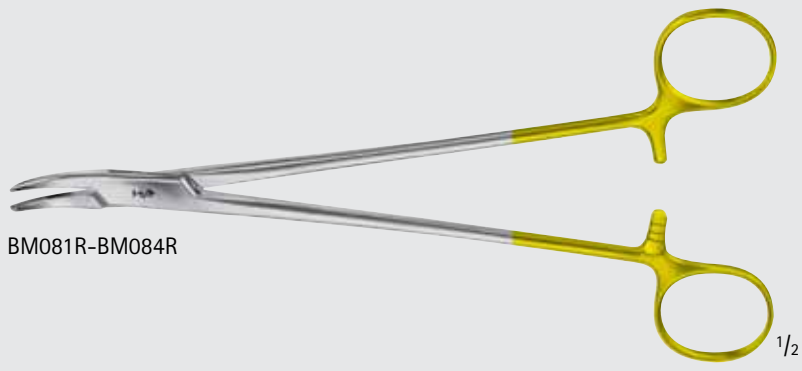

BM081R-BM084R

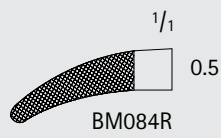
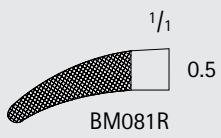

### DUROGRIP TC MUELLER Needle Holder

Catalog Number	Tip	Jaw	Length (in.)
BM089R	CVD	SERR	14 1/4

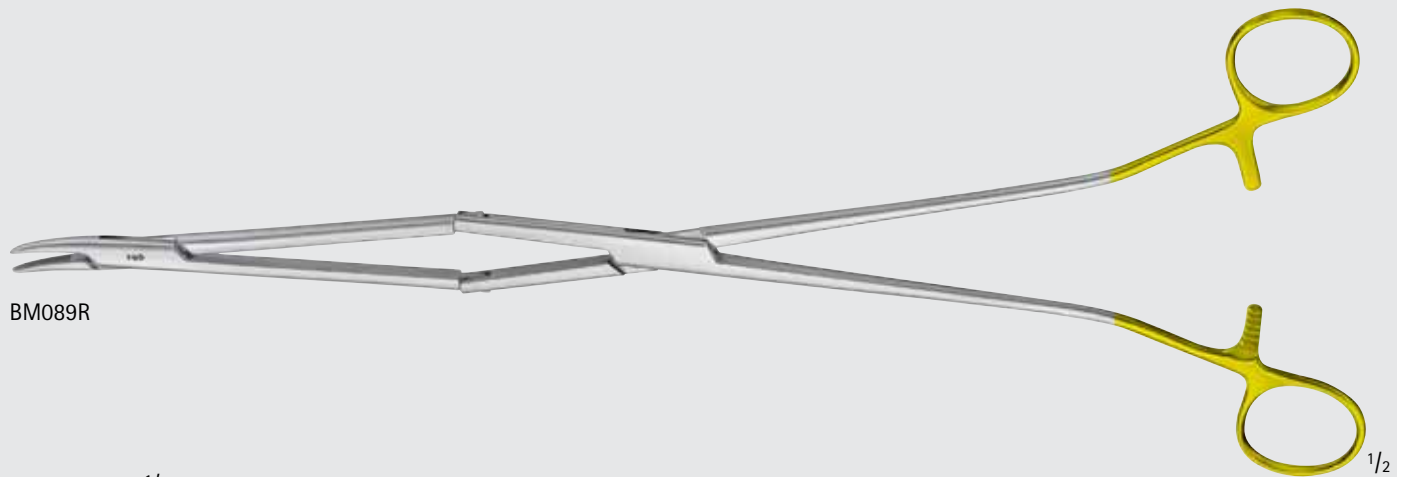

BM089R

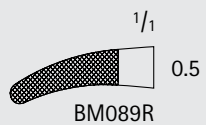

INCHES

# General Surgery

## DUROGRIP™ TC Needle Holders

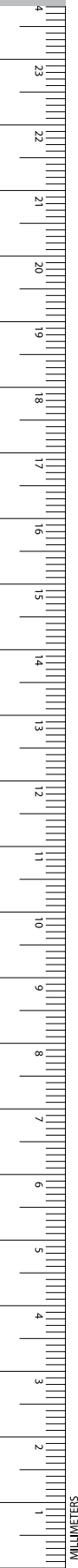

### DUROGRIP TC FINOCHIETTO Needle Holder

Catalog Number	Tip	Jaw	Length (in.)
BM092R	ANG	SERR	10 1/2

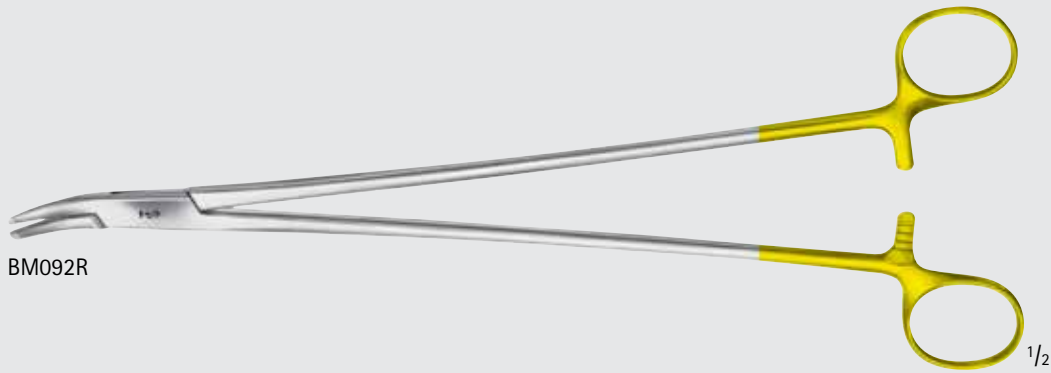

BM092R

1/2

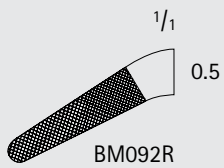

BM092R

### DUROGRIP TC STRATTE Needle Holder

Catalog Number	Tip	Jaw	Length (in.)
BM095R	CVD	SERR	8 1/4
BM096R	CVD	SERR	9

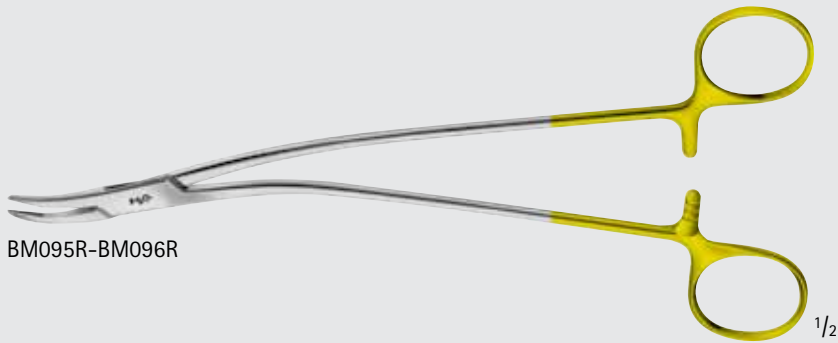

BM095R-BM096R

1/2

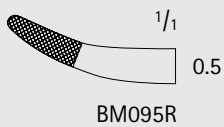

BM095R

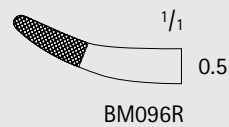

BM096R

DUROGRIP TC Wire Twister

Catalog Number	Tip	Jaw	Length (in.)
BM110R	ROUND	SERR	6 1/8
BM111R	SQUARE	SERR	6

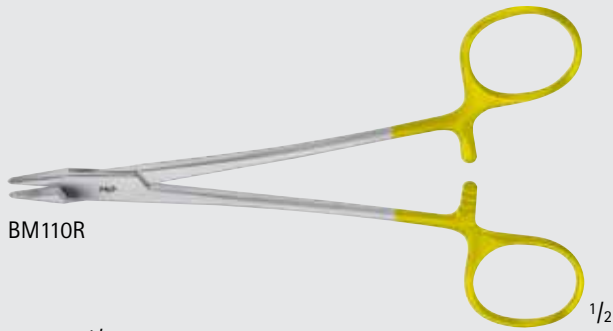

BM110R

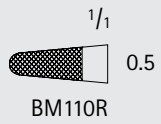

BM111R

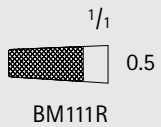

DUROGRIP TC BAUMGARTNER Wire Twister

Catalog Number	Tip	Jaw	Length (in.)
BM112R	SQUARE	SERR	7 7/8

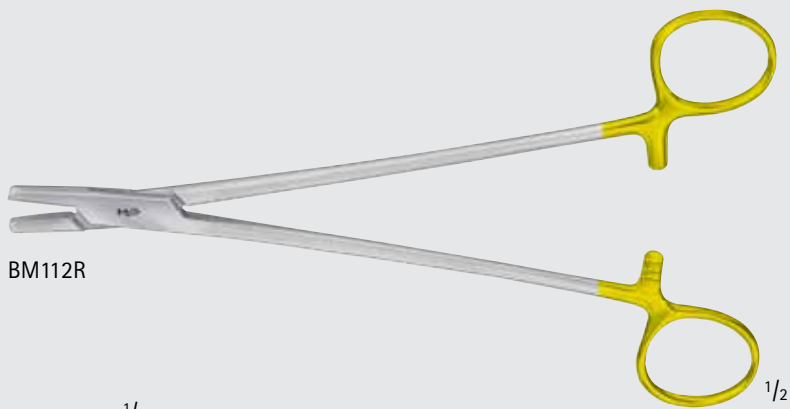

BM112R

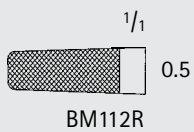

INCHES

# General Surgery

## DUROGRIP™ TC Needle Holders

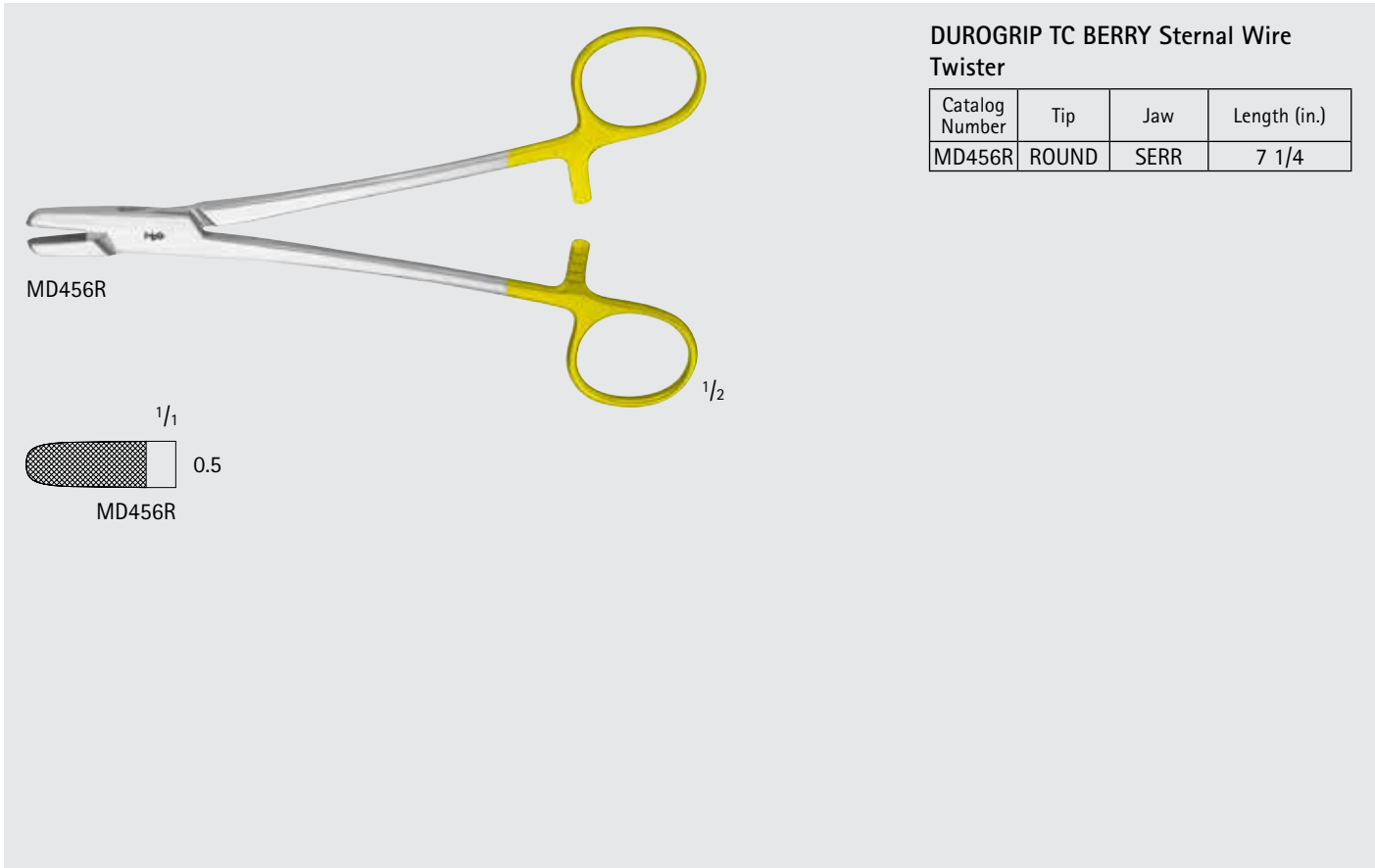

**DUROGRIP TC BERRY Sternal Wire Twister**

Catalog Number	Tip	Jaw	Length (in.)
MD456R	ROUND	SERR	7 1/4

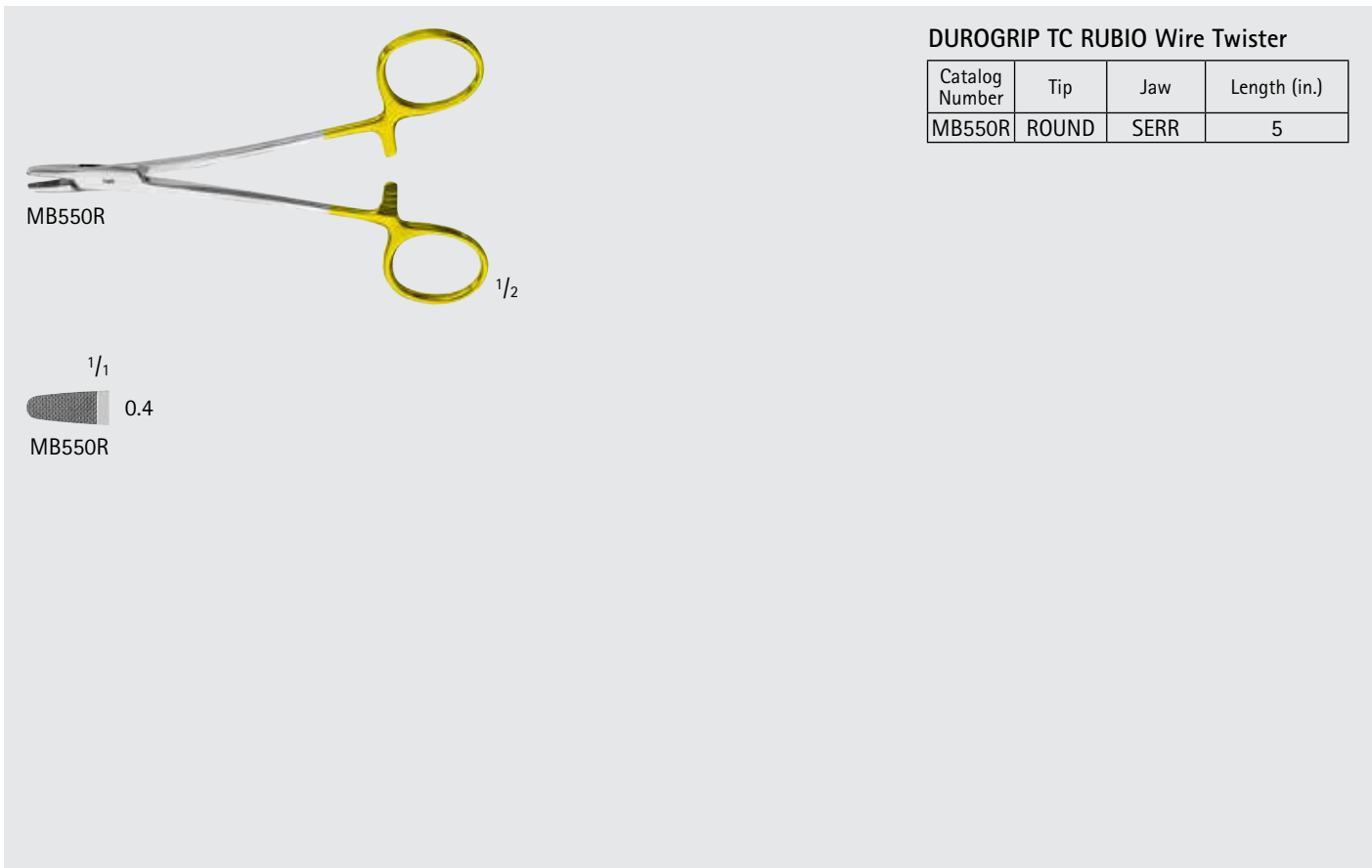

**DUROGRIP TC RUBIO Wire Twister**

Catalog Number	Tip	Jaw	Length (in.)
MB550R	ROUND	SERR	5

General Surgery  
DUROGRIP™ TC Needle Holders

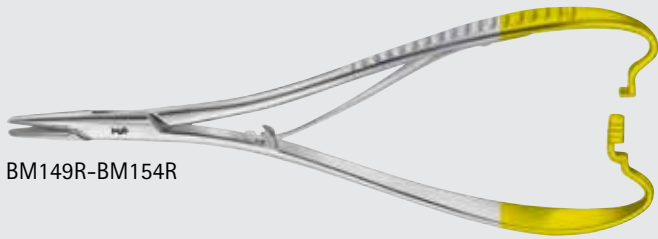

BM149R-BM154R

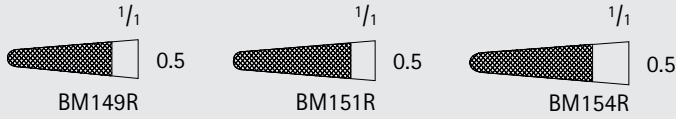

DUROGRIP TC MATHIEU Needle Holder

Catalog Number	Jaw	Length (in.)
BM149R	SERR	5 1/2
BM151R	SERR	6 1/2
BM154R	SERR	7 7/8

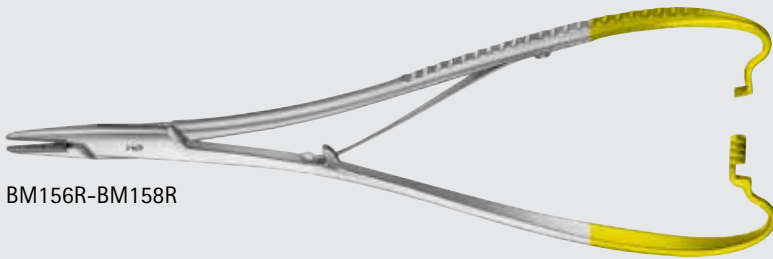

BM156R-BM158R



DUROGRIP TC MATHIEU Needle Holder, Heavy

Catalog Number	Jaw	Length (in.)
BM156R	SERR	7 7/8
BM158R	SERR	9 5/8



# General Surgery

## Needle Cases



BL907R

### Needle Case, Rectangle

Catalog Number	Dimensions (mm)
BL907R	70 x 53 x 9



BL930R-BL933R



BL931R-BL933R

### Needle Case, Round

Catalog Number	Item	Dimensions (mm)
BL930R	COMPLETE NEEDLE CASE W/ INTERIOR BOX	65 x 16
BL931R	INTERIOR BOX ONLY	62 x 12
BL933R	INTERIOR BOX ONLY	90 x 12



BL941R

### Needle Case, With 7 Sections

Catalog Number	Dimensions (mm)
BL941R	150 x 90 x 10

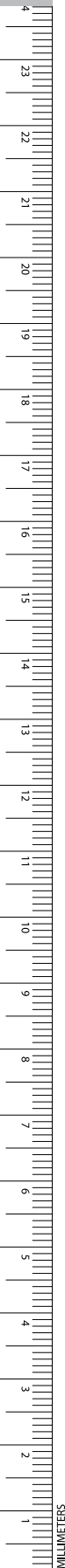

### DESCHAMPS Needle

Catalog Number	Hand Orientation	Tip	Length (in.)
BM822R	RIGHT	BLUNT, 3.5 MM	9 1/2
BM824R	RIGHT	BLUNT, 5 MM	11
BM781R	LEFT	SHARP, 2 MM	8 1/4
BM749R	LEFT	SHARP, 3.5 MM	8 1/2
BM809R	LEFT	BLUNT, 2.5 MM	8 1/4
BM807R	LEFT	BLUNT, 2.5 MM	8 1/2
BM811R	LEFT	BLUNT, 3.5 MM	8 1/2
BM813R	LEFT	STEEP, BLUNT, 2 MM	8 7/8



BM822R-BM824R

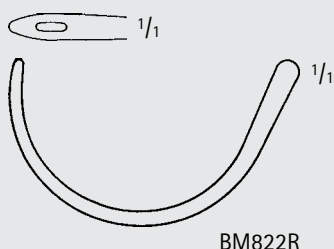

BM822R

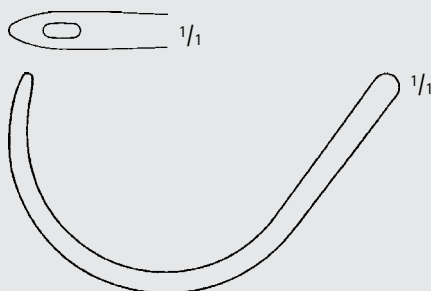

BM824R



BM749R, BM781R, BM807R, BM809R, BM811R, BM813R



BM781R

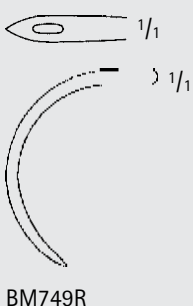

BM749R

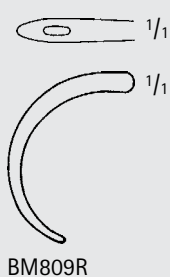

BM809R

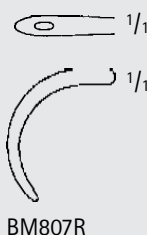

BM807R



BM811R

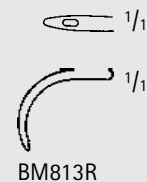

BM813R



INCHES

# General Surgery

## Ligature Needles



BM770R

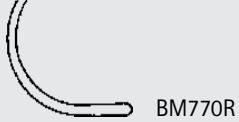
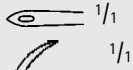

BM770R



BM771R

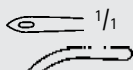

BM771R

### HURD Needle

Catalog Number	Hand Orientation	Tip	Length (in.)
BM770R	RIGHT	SHARP	8 1/4
BM771R	LEFT	SHARP	8 1/4



BM801R

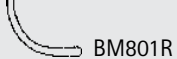

BM801R

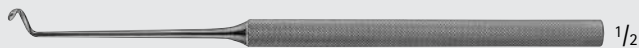

BM802R

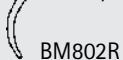

BM802R

### KRONECKER Needle

Catalog Number	Hand Orientation	Tip	Length (in.)
BM801R	RIGHT	BLUNT	6 1/8
BM802R	LEFT	BLUNT	6 1/8



BM855R

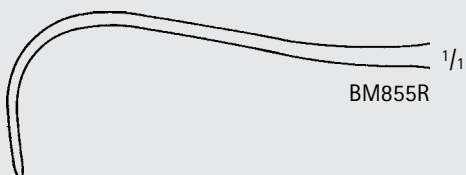

BM855R

### SYME Suture Needle

Catalog Number	Tip	Length (in.)
BM855R	BLUNT	6 3/4

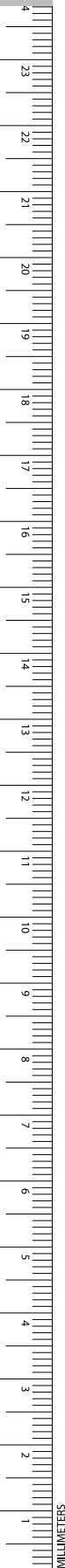

Monopolar Diathermi Forceps, Insulated

Catalog Number	Length (in.)
GK033R	13 3/4



GK033R



Dressing Forceps, Standard Patterns

Catalog Number	Tip	Length (in.)
BD043R	SERR	4 1/2
BD045R	SERR	5 1/8
BD047R	SERR	5 3/4
BD049R	SERR	6 1/4
BD050R	SERR	7
BD051R	SERR	7 7/8
BD052R	SERR	9 3/4
BD053R	SERR	11 3/4



BD043R-BD053R

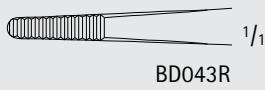

BD043R

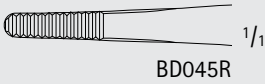

BD045R

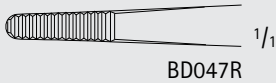

BD047R

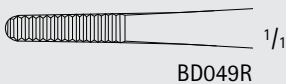

BD049R

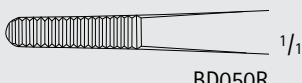

BD050R

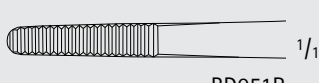

BD051R

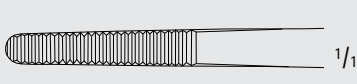

BD052R

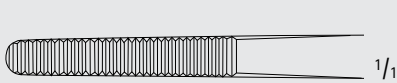

BD053R

Dressing Forceps, Extra Wide

Catalog Number	Tip	Length (in.)
BD077R	SERR	5 3/4



BD077R

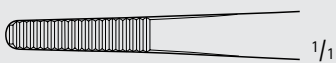

BD077R



INCHES

# General Surgery

## Dressing and Tissue Forceps



BD023R-BD033R

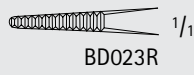

BD023R

1/1

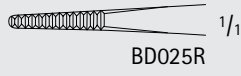

BD025R

1/1



BD027R

1/1



BD029R

1/1

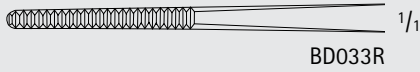

BD033R

1/1



BD035R-BD037R

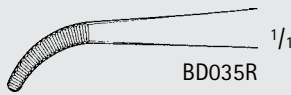

BD035R

1/1

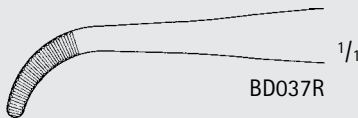

BD037R

1/1

### Dressing Forceps, Delicate

Catalog Number	Tip	Length (in.)
BD023R	STR, SERR	4 1/2
BD025R	STR, SERR	5 1/8
BD027R	STR, SERR	5 3/4
BD029R	STR, SERR	6 1/4
BD033R	STR, SERR	12
BD035R	CVD, SERR	5 1/8
BD037R	CVD, SERR	5 1/2



BD210R

1/2

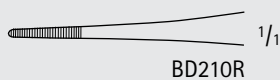

BD210R

1/1

### Dressing Forceps, Extra Delicate

Catalog Number	Tip	Length (in.)
BD210R	SERR	4 1/2

Tissue Forceps, Delicate

Catalog Number	Tip	Teeth	Length (in.)
BD533R	STR	1 x 2	4 1/2
BD535R	STR	1 x 2	5 1/8
BD537R	STR	1 x 2	5 3/4
BD539R	STR	1 x 2	6 1/4
BD540R	STR	1 x 2	7
BD541R	STR	1 x 2	7 7/8
BD542R	STR	1 x 2	9 3/4
BD543R	STR	1 x 2	11 3/4
MB803R	STR	2 x 3	4 1/2
BD575R	STR	2 x 3	5 1/8
BD577R	STR	2 x 3	5 3/4
BD579R	STR	2 x 3	6 1/4
BD580R	STR	2 x 3	7
BD581R	STR	2 x 3	7 7/8
BD587R	STR	3 x 4	5 3/4
BD589R	STR	3 x 4	6 1/4
BD591R	STR	3 x 4	7 7/8
BD527R	CVD	1 x 2	5 3/4

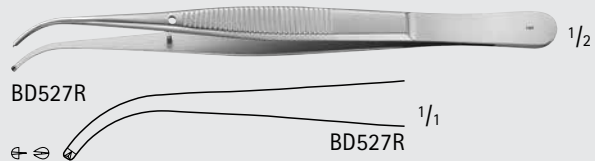
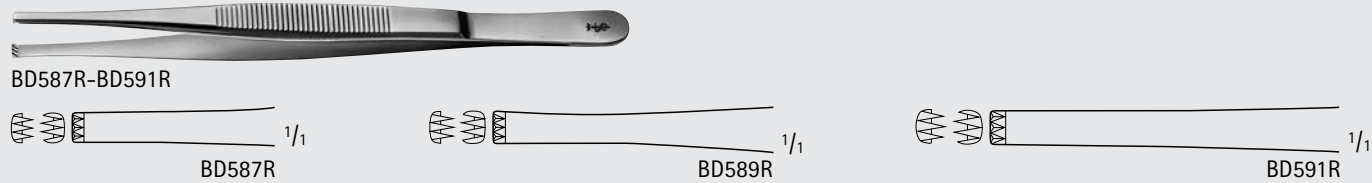
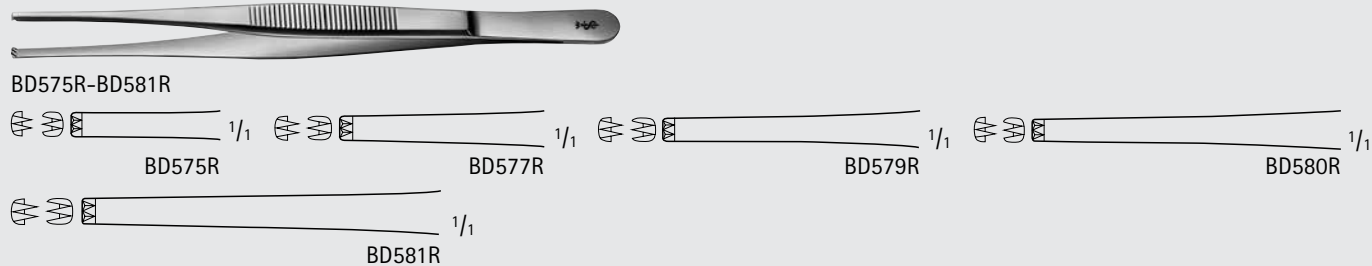
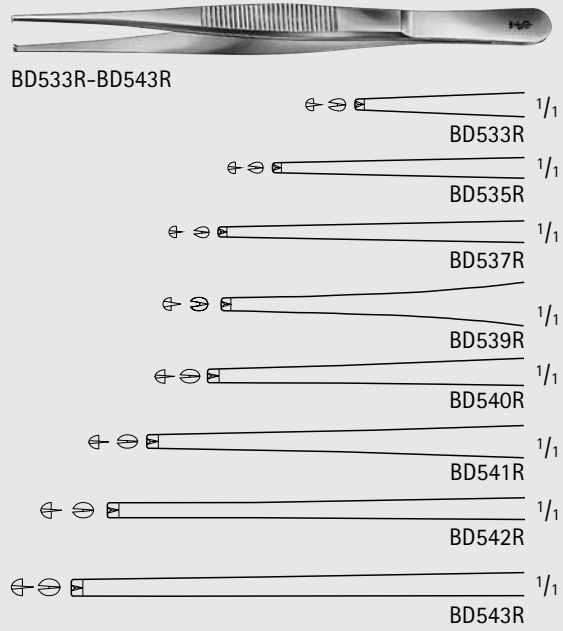

Tissue Forceps, Medium

Catalog Number	Teeth	Length (in.)
BD547R	1 x 2	5 3/4
BD549R	1 x 2	6 1/4

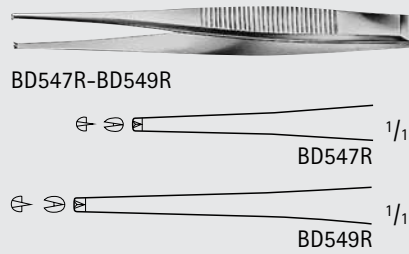

INCHES

# General Surgery

## Dressing and Tissue Forceps



BD553R-BD563R

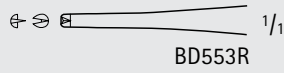

BD553R

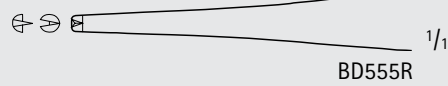

BD555R



BD557R



BD559R

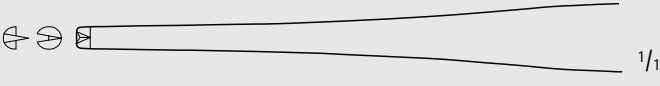

BD560R

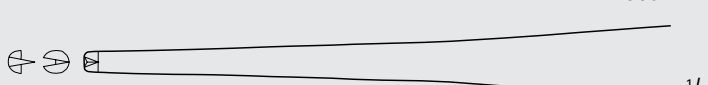

BD561R

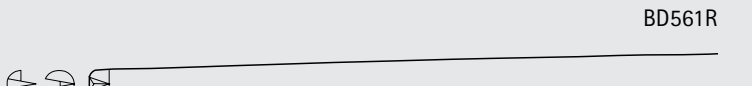

BD562R

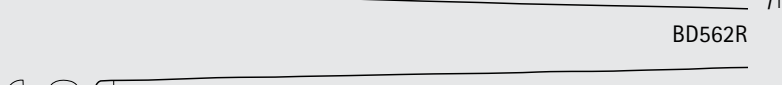

BD563R

Tissue Forceps, Standard Patterns

Catalog Number	Teeth	Length (in.)
BD553R	1 x 2	4 1/2
BD555R	1 x 2	5 1/8
BD557R	1 x 2	5 3/4
BD559R	1 x 2	6 1/4
BD560R	1 x 2	7
BD561R	1 x 2	7 7/8
BD562R	1 x 2	9 3/4
BD563R	1 x 2	11 3/4

# General Surgery

## Dressing and Tissue Forceps



BD690R-BD692R

### STRASSBURGER Tissue Forceps

Catalog Number	Tip	Teeth	Length (in.)
BD690R	X-SERR	1 x 2	6
BD692R	X-SERR	1 x 2	7 7/8



BD690R

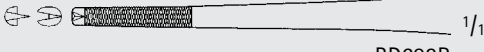

BD692R

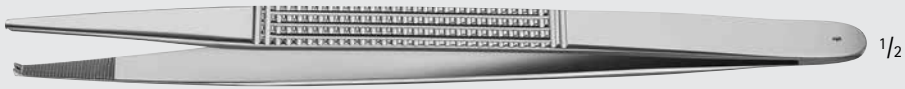

MG077R

### CURTIS Tissue Forceps

Catalog Number	Tip	Length (in.)
MG077R	SERR	8 3/4



MG077R



BD693R

### BONNEY Tissue Forceps

Catalog Number	Tip	Teeth	Length (in.)
BD693R	SERR	1 x 2	6 7/8
MG357R	SERR	2 x 3	6 3/4



BD693R



MG357R



MG357R



BD733R

### MARTIN Tissue Forceps

Catalog Number	Teeth	Length (in.)
BD733R	7 x 8	6 1/8

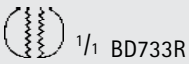

BD733R

# General Surgery

## Dressing and Tissue Forceps

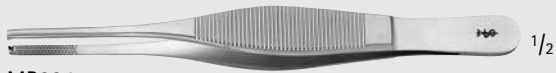

MB224



MB224

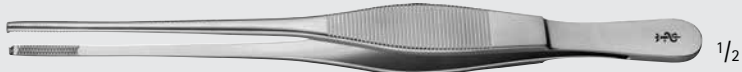

MG464R-MG465R



MG464R



MG465R

### HEANEY Tissue Forceps

Catalog Number	Tip	Teeth	Length (in.)
MG464R	X-SERR	1 x 2	7 1/4
MB224	X-SERR	2 x 3	5 1/2
MG465R	X-SERR	3 x 4	7 1/2



BD725R-BD727R

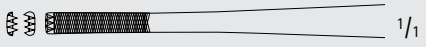

BD725R

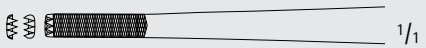

BD726R

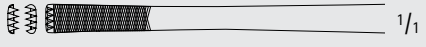

BD727R

### STILLE-BARRAYA CV Forceps

Catalog Number	Tip	Teeth	Length (in.)
BD725R	X-SERR	3 x 4	7
BD726R	X-SERR	3 x 4	7 7/8
BD727R	X-SERR	3 x 4	9 3/4



BD755R

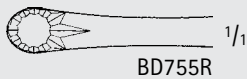

BD755R



BD760R-BD761R, MB921R-MB922R, XG006R



BD760R



BD761R, MB921R, MB922R

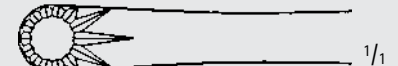

XG006R

### RUSSIAN Tissue Forceps

Catalog Number	Length (in.)
BD755R	6
BD760R	7 7/8
XG006R	9 3/4
BD761R	10 1/4
MB921R	12
MB922R	14



MB208R-MB923R



MAYO-RUSSIAN Tissue Forceps

Catalog Number	Tip	Length (in.)
MB208R	FENESTRATED	9
MB923R	FENESTRATED	14



BD750R

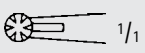

BD750R



MB795R



MB795R

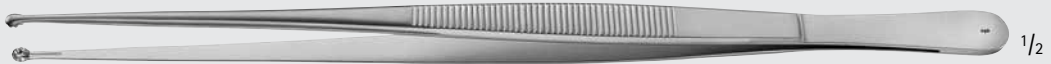

MG078R



MG078R

SELMAN Tissue Forceps

Catalog Number	Length (in.)
BD750R	6 1/8
MB795R	7 7/8
MG078R	9 3/4

# General Surgery

## Dressing and Tissue Forceps

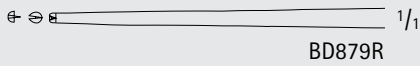
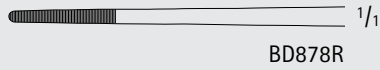

### LUCAE Bayonet Forceps

Catalog Number	Tip	Teeth	Length (in.)
BD878R	SERR	-	5 1/2
BD879R	SMOOTH	1 x 2	5 1/2

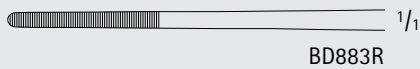

### GRUENWALD Bayonet Forceps

Catalog Number	Tip	Length (in.)
BD883R	SERR	7 7/8

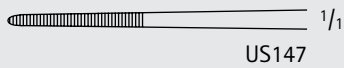

### CUSHING Bayonet Forceps

Catalog Number	Tip	Teeth	Length (in.)
US147	SERR	-	7 3/4
MB231	SMOOTH	1 x 2	7 1/4

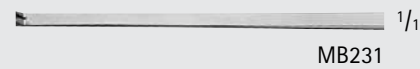

### BROWN-CUSHING Bayonet Forceps

Catalog Number	Teeth	Length (in.)
MB227	7 x 7	7 1/4

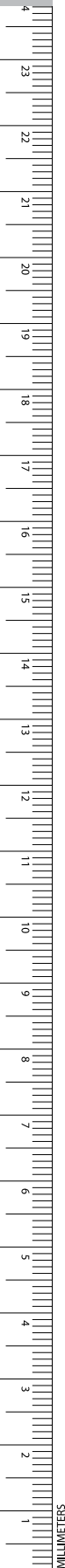

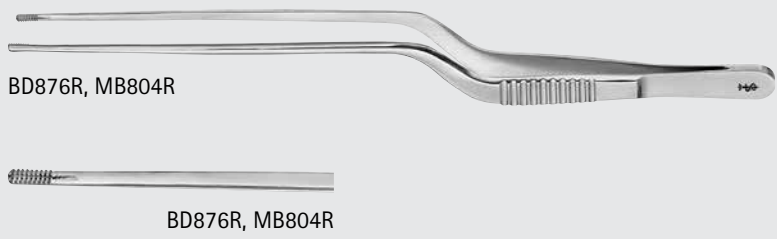

**BROWN-BAHNSON Bayonet Forceps**

Catalog Number	Tip	Length (in.)
BD876R	SERR	6 1/8
MB804R	SERR	8

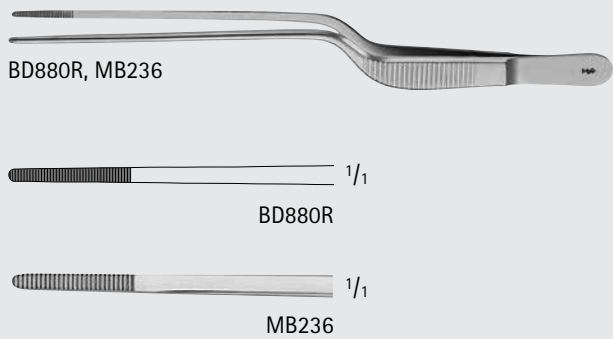

**JANSEN Bayonet Forceps**

Catalog Number	Tip	Length (in.)
BD880R	SERR	6 1/4
MB236	SERR	6 1/2

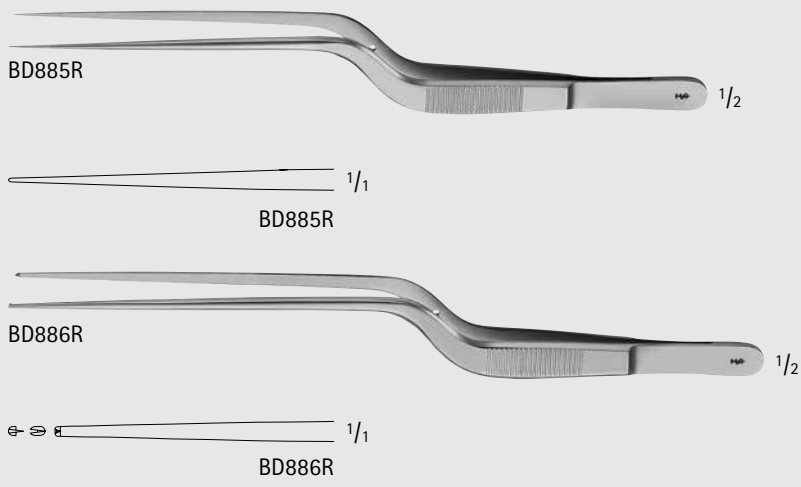

**Bayonet Forceps**

Catalog Number	Tip	Teeth	Length (in.)
BD885R	SMOOTH	-	7 1/4
BD886R	SMOOTH	1 x 2	7 7/8

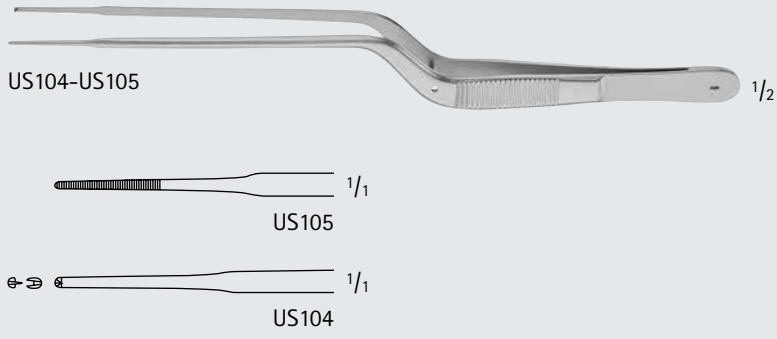

**GERALD Bayonet Forceps**

Catalog Number	Tip	Teeth	Length (in.)
US105	SERR	-	7 1/2
US104	SMOOTH	1 x 2	7 1/2

# General Surgery

## Dressing and Tissue Forceps

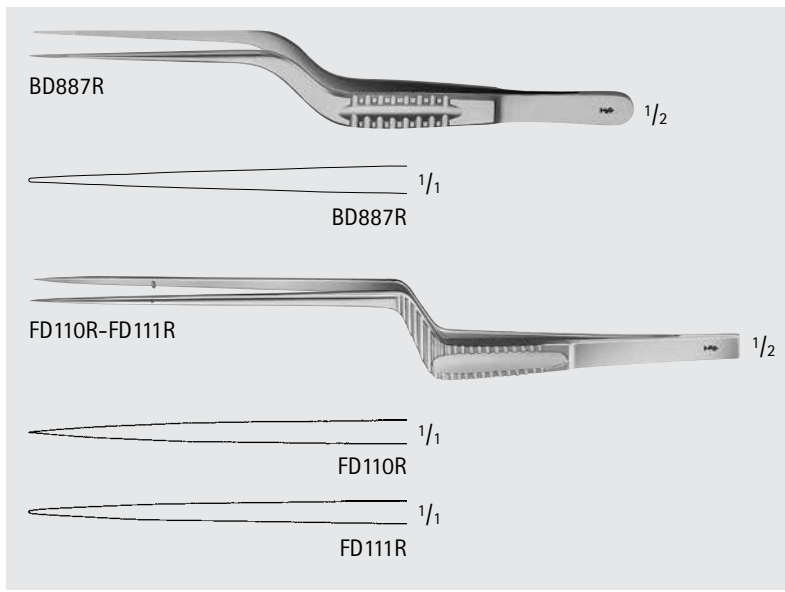

### Bayonet Forceps

Catalog Number	Tip	Length (in.)
BD887R		6 1/4
FD110R	FINE	7 1/4
FD111R	BROAD	7 1/4



### TROELTSCH Bayonet Forceps

Catalog Number	Tip	Length (in.)
BD900R	ANG/SERR	4
BD902R	ANG/SERR	4 1/2
BD910R	ANG/SERR	5 1/2
BD911R	ANG/SERR	6 3/4

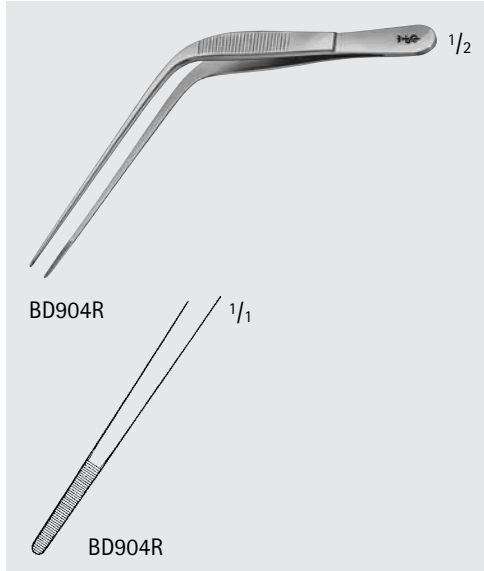
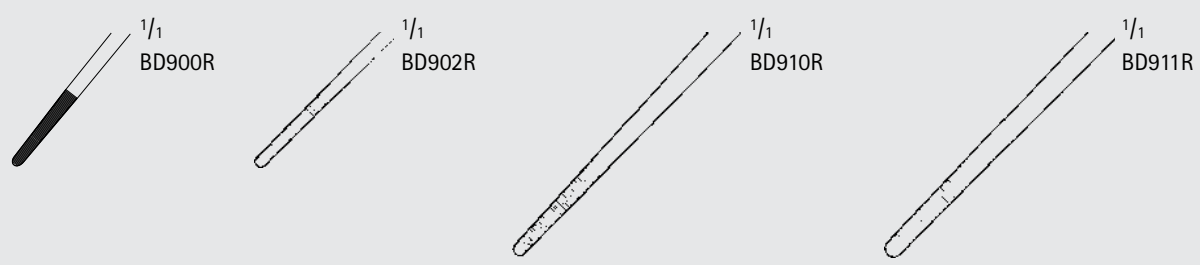

### WILDE Bayonet Forceps

Catalog Number	Tip	Length (in.)
BD904R	ANG/SERR	4 1/2

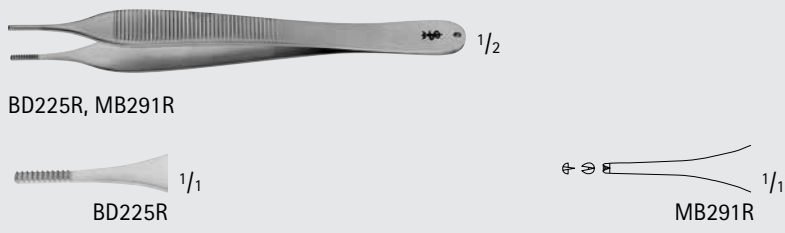

**HUDSON Forceps**

Catalog Number	Tip	Teeth	Length (in.)
BD225R	SERR	-	5
MB291R	SMOOTH	1 x 2	5

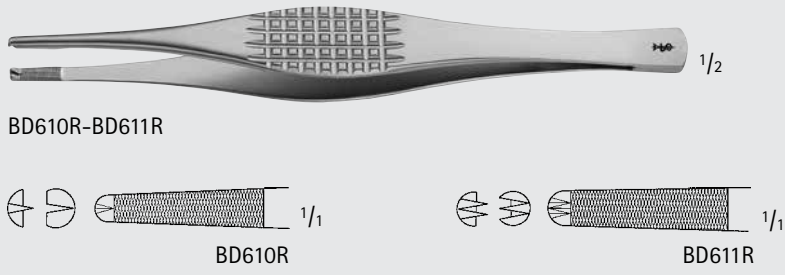

**FERRIS-SMITH Tissue Forceps**

Catalog Number	Tip	Teeth	Length (in.)
BD610R	X-SERR	1 x 2	6 7/8
BD611R	X-SERR	2 x 3	6 7/8



**SEMKEN Forceps, Delicate**

Catalog Number	Tip	Teeth	Length (in.)
BD215R	SERR	-	5
BD216R	SERR	-	6
BD665R	SMOOTH	1 x 2	5
BD667R	SMOOTH	1 x 2	6
BD666R	SMOOTH	2 x 3	5

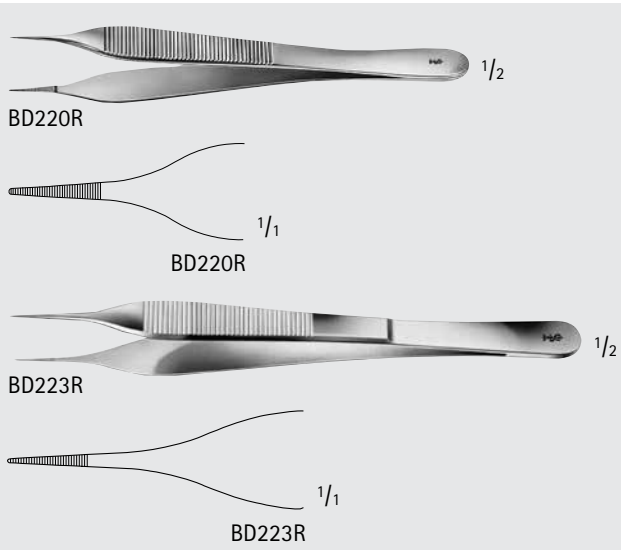
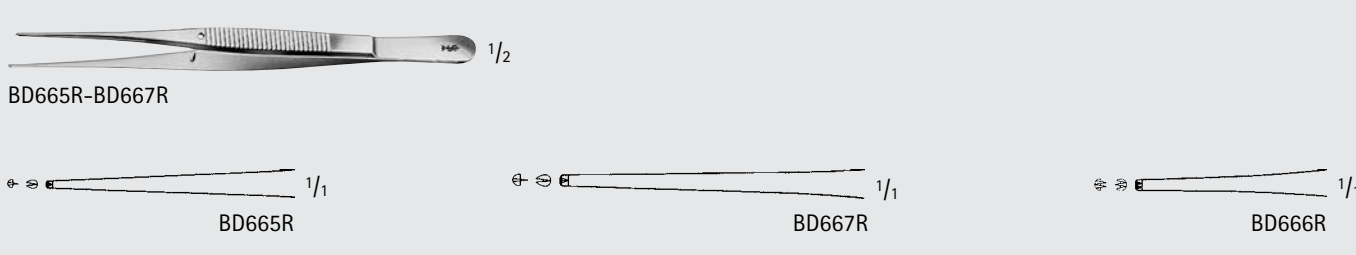

**Micro ADSON Forceps, Delicate**

Catalog Number	Tip	Length (in.)
BD220R	SERR, W/ PLATFORM	4 3/4
BD223R	SERR	6

# General Surgery

## Dressing and Tissue Forceps

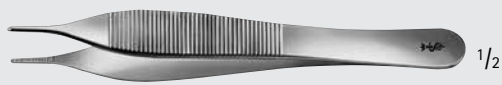

BD222R, MA156R

1/2



BD222R 1/1

MA156R 1/1



BD511R

1/2

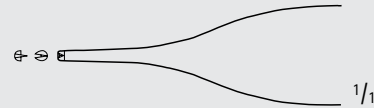

1/1



MG275R

1/2

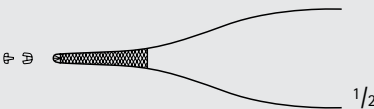

1/2



BD512R

1/2

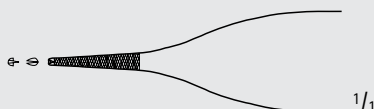

1/1



MA536R

1/2

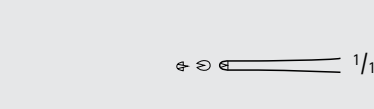

1/1

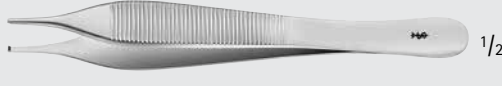

MB454R

1/2

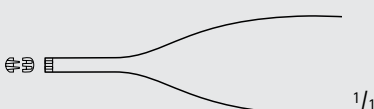

1/1

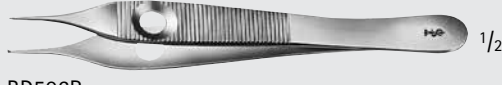

BD506R

1/2



1/1



BD507R

1/2



1/1



BD508R

1/2

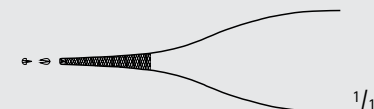

1/1



BD513R

1/2



1/1



BD521R

1/2



1/1

### ADSON Forceps, Delicate

Catalog Number	Tip	Teeth	Handle	Length (in.)
BD222R	SERR	-	-	4 3/4
MA156R	SERR, X-LONG	-	-	4 3/4
BD511R	SMOOTH	1 x 2	-	4 3/4
MG275R	SERR	1 x 2	-	4 3/4
BD512R	X-SERR W/ PLATFORM	1 x 2	-	4 3/4
MA536R	X-LONG	1 x 2	-	4 3/4
MB454R	SMOOTH	2 x 3	-	4 3/4
BD506R	SMOOTH	1 x 2	FENE-STRATED	4 3/4
BD507R	SMOOTH	1 x 2	FENE-STRATED	4 3/4
BD508R	SERR	1 x 2	FENE-STRATED	4 3/4
BD513R	X-SERR W/ PLATFORM	1 x 2	FENE-STRATED	4 3/4
BD521R	SMOOTH	1 x 2	FENE-STRATED	6

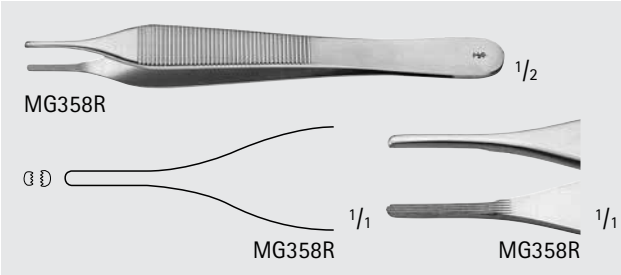

**MUSTARDE Suture Removal Forceps**

Catalog Number	Tip	Length (in.)
MG358R	LONGITUDINAL, SERR	5

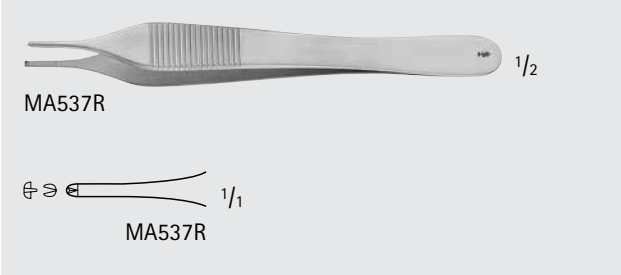

**CALLISON-ADSON Tissue Forceps, W/ Platform**

Catalog Number	Teeth	Length (in.)
MA537R	1 x 2	5

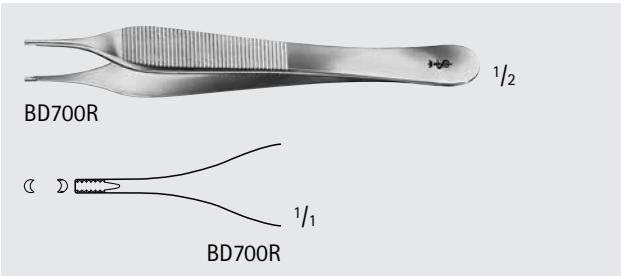

**ADSON-BROWN Tissue Forceps**

Catalog Number	Teeth	Length (in.)
BD700R	7 x 8	4 3/4

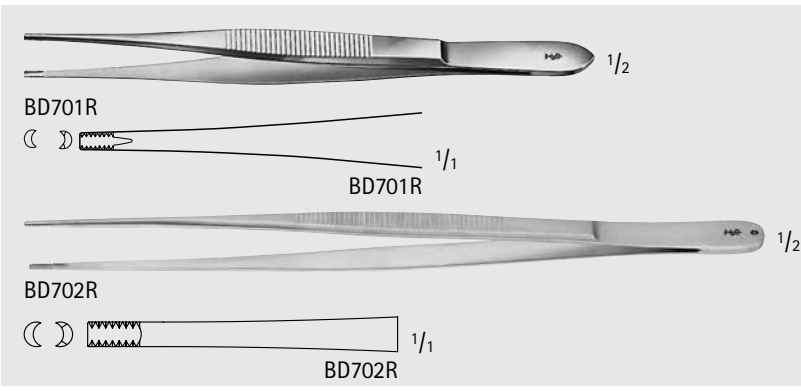

**BROWN Tissue Forceps**

Catalog Number	Teeth	Length (in.)
BD701R	7 x 8	6
BD702R	7 x 8	7 7/8

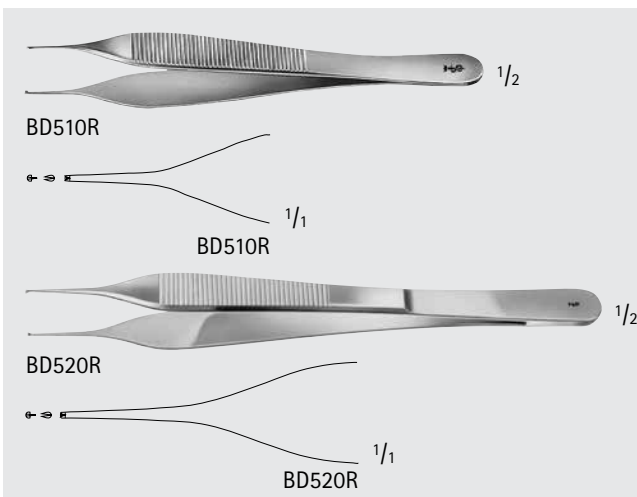

**MICRO ADSON Tissue Forceps, Delicate**

Catalog Number	Teeth	Length (in.)
BD510R	1 x 2	4 3/4
BD520R	1 x 2	6

# General Surgery

## Dressing and Tissue Forceps



BD662R-BD664R

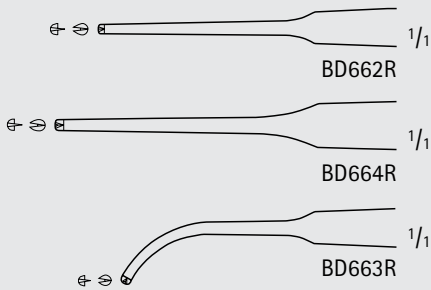

**GERALD Tissue Forceps, Delicate**

Catalog Number	Tip	Teeth	Length (in.)
BD662R	STR	1 x 2	6 7/8
BD664R	STR	1 x 2	9
BD663R	CVD	1 x 2	6 7/8



MG422R

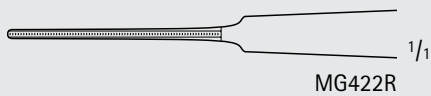

**GERALD-DEBAKEY Forceps, Narrow**

Catalog Number	Tip	Length (in.)
MG422R	SERR	9



BD522R

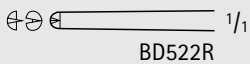

**ADSON Tissue Forceps, Delicate**

Catalog Number	Teeth	Length (in.)
BD522R	1 x 2	7



BD523R



**JEFFERSON Tissue Forceps, Delicate**

Catalog Number	Teeth	Length (in.)
BD523R	1 x 2	7



BD228R-BD230R

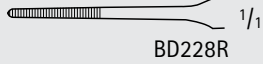

BD228R

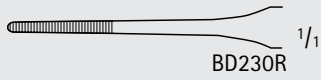

BD230R

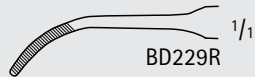

BD229R

**GERALD Dressing Forceps, Delicate**

Catalog Number	Tip	Length (in.)
BD228R	STR, SERR	6 7/8
BD230R	STR, SERR	9
BD229R	CVD, SERR	6 7/8



BD236R

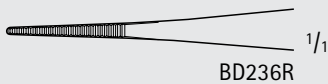

BD236R

**MCINDOE Thumb Forceps, Delicate**

Catalog Number	Tip	Length (in.)
BD236R	SERR	6



BD661R



BD661R

**MCINDOE Tissue Forceps, Delicate**

Catalog Number	Tip	Teeth	Length (in.)
BD661R	SERR	1 x 2	6



BD257R

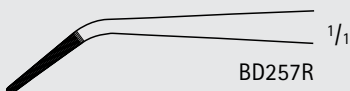

BD257R

**Delicate Forceps, Angled**

Catalog Number	Tip	Length (in.)
BD257R	SERR	7 7/8

# General Surgery

## Dressing and Tissue Forceps



BD238R-BD243R

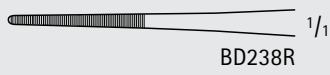

BD238R



BD239R

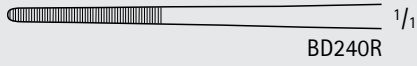

BD240R

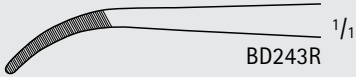

BD243R

### CUSHING Forceps, Delicate

Catalog Number	Tip	Length (in.)
BD238R	STR, SERR	7
BD239R	STR, SERR	7 7/8
BD240R	STR, SERR	9 3/4
BD243R	CVD, SERR	7 7/8



MD463

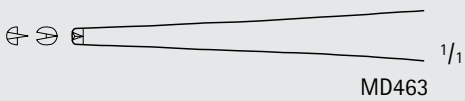

MD463

### CUSHING Tissue Forceps

Catalog Number	Teeth	Length (in.)
MD463	1 x 2	7



BD246R

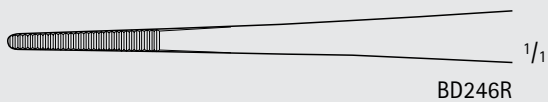

BD246R

### BROPHY Forceps, Delicate

Catalog Number	Tip	Length (in.)
BD246R	SERR	7 7/8

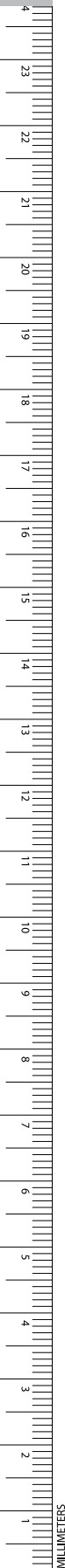

# General Surgery

## Dressing and Tissue Forceps



BD231R-BD232R

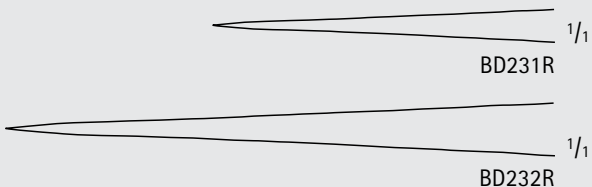

### Forceps, Delicate

Catalog Number	Tip	Length (in.)
BD231R	SMOOTH	7
BD232R	SMOOTH	7 7/8



BD301R-BD305R



### Micro Dressing Forceps

Catalog Number	Tip	Length (in.)
BD301R	STR, SERR	3 1/2
BD302R	STR, SERR	4 1/8
BD303R	STR, SERR	4 1/2
BD304R	STR, SERR	5 1/8
BD305R	STR, SERR	5 3/4
BD311R	CVD, SERR	3 1/2
BD312R	CVD, SERR	4 1/8
BD313R	CVD, SERR	4 1/2
BD314R	CVD, SERR	5 1/8
BD315R	CVD, SERR	5 3/4



BD311R-BD315R

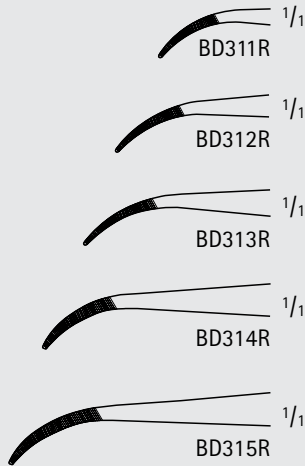

INCHES

# General Surgery

## Dressing and Tissue Forceps

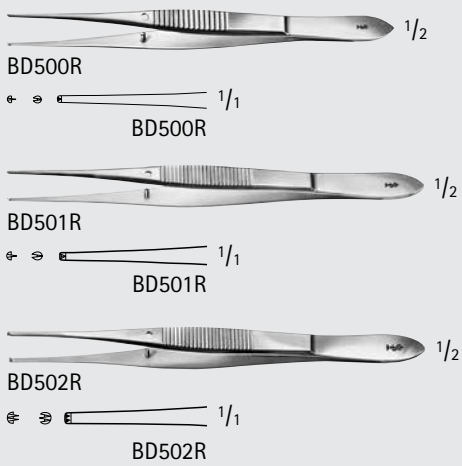

### Micro Tissue Forceps

Catalog Number	Teeth	Length (in.)
BD500R	1 x 2	4
BD501R	1 x 2	4 1/4
BD502R	2 x 3	4 1/4

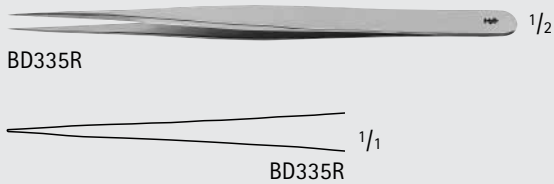

### Micro Forceps #3 Jewelers

Catalog Number	Tip Size (mm)	Length (in.)
BD335R	0.3	5 1/4

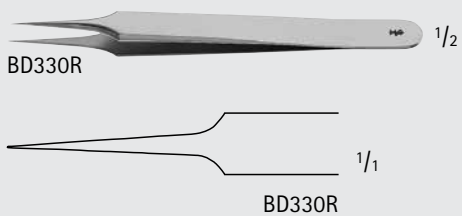

### Micro Forceps #4 Jewelers

Catalog Number	Tip Size (mm)	Length (in.)
BD330R	0.2	4 1/4

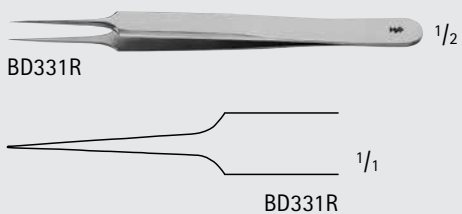

### Micro Forceps #5 Jewelers

Catalog Number	Tip Size (mm)	Length (in.)
BD331R	0.15	4 1/4

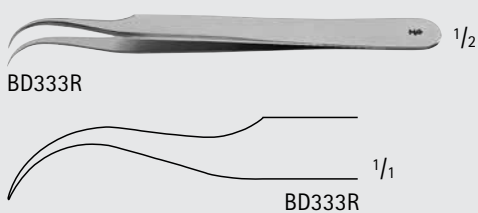

### Micro Forceps #7 Jewelers

Catalog Number	Tip Size (mm)	Length (in.)
BD333R	0.2	4 1/2

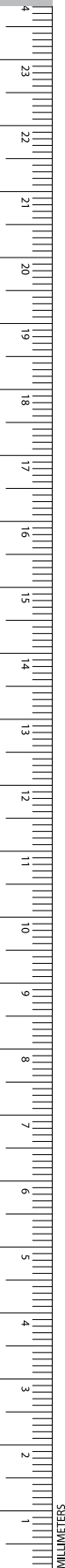



**GILLIES Tissue Forceps, Delicate**

Catalog Number	Tip	Teeth	Length (in.)
BD660R	X-SERR	1 x 2	6 1/8

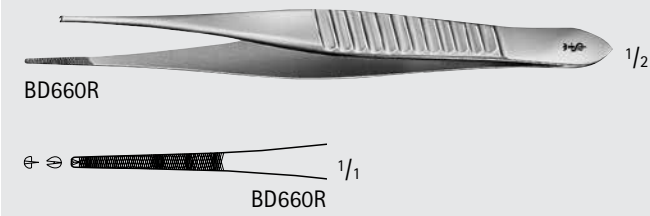

**SEMKEN Tissue Forceps, Delicate**

Catalog Number	Teeth	Length (in.)
BD669R	1 x 2	5 3/4

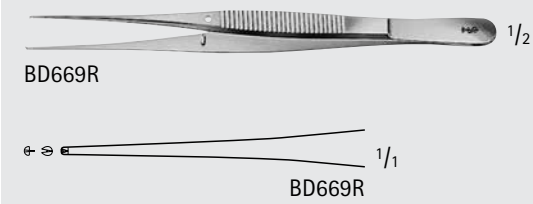

**WAUGH Tissue Forceps, Delicate**

Catalog Number	Tip	Teeth	Length (in.)
BD670R	X-SERR	1 x 2	7
BD671R	X-SERR	1 x 2	7 7/8
BD672R	X-SERR	1 x 2	9 3/4
BD679R	X-SERR	1 x 2	12

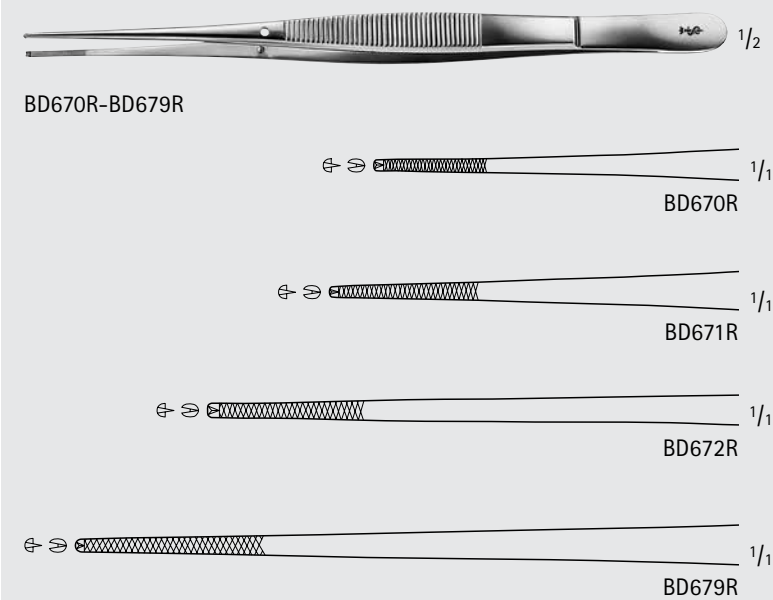

**DOCKTOR Forceps**

Catalog Number	Tip	Teeth	Length (in.)
MB211R	X-SERR	1 x 2	4 3/4

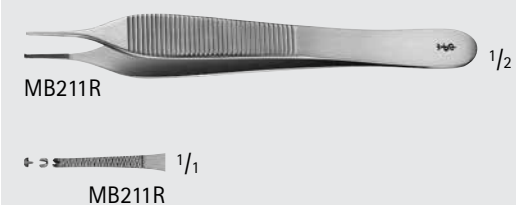

# General Surgery

## Dressing and Tissue Forceps



**DEBAKEY Atraumatic Ultra Light Forceps**

Catalog Number	Tip Size (mm)	Length (in.)
FC411R	1.2	6
FC412R	1.5	7 7/8
FC413R	1.5	9 1/2
FC418R	1.5	11 3/4

**DEBAKEY Atraumatic Vascular Tissue Forceps**

Catalog Number	Tip Size (mm)	Length (in.)
FB394R	1	6
FB395R	1	7 3/4
FB396R	1	9 1/2

**DEBAKEY Atraumatic Forceps**

Catalog Number	Tip Size (mm)	Length (in.)
FB411R	1.5	6
FB412R	1.5	7 7/8
FB418R	1.5	9 1/2
FB419R	1.5	11 3/4

DEBAKEY Atraumatic Forceps

Catalog Number	Tip Size (mm)	Length (in.)
FB400R	2	6
FB402R	2	7 7/8
FB404R	2	9 1/2
FB405R	2	11 3/4
FB414R	2.8	6
FB415R	2.8	7 7/8
FB416R	2.8	9 1/2
FB417R	2.8	11 3/4
FB406R	3.5	7 7/8
FB407R	3.5	9 1/2
FB408R	3.5	11 3/4
FB409R	3.5	13 3/4

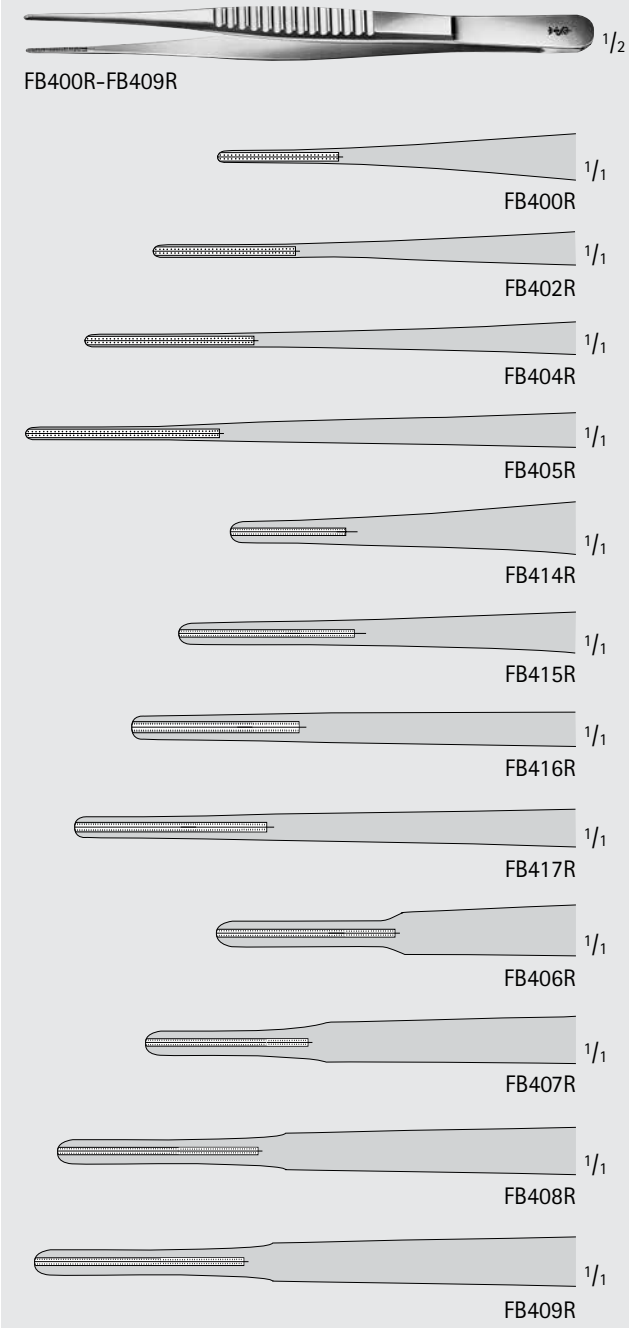

# General Surgery

## Dressing and Tissue Forceps

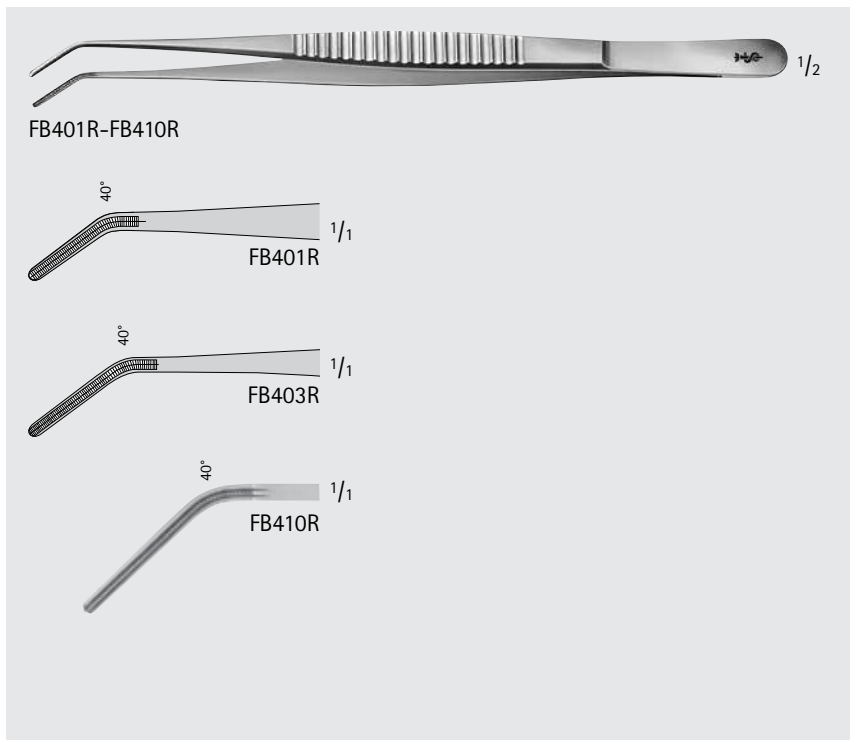

**DEBAKEY Atraumatic Forceps, Angled**

Catalog Number	Tip Size (mm)	Length (in.)
FB401R	2	6
FB403R	2	7 7/8
FB410R	2	9 1/2

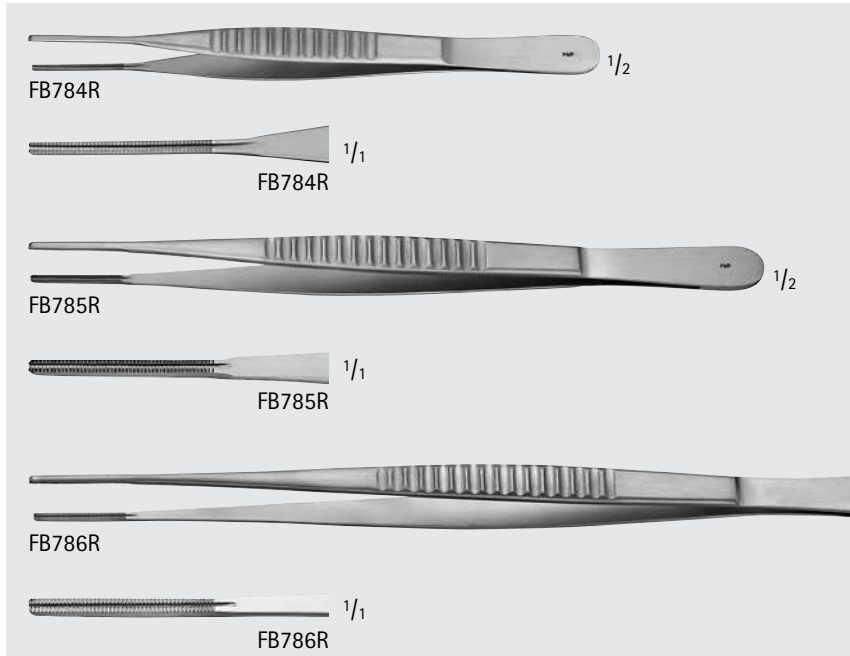

**COOLEY Atraumatic Vascular Tissue Forceps**

Catalog Number	Tip Size (mm)	Length (in.)
FB784R	1.5	6
FB785R	2.0	7 3/4
FB786R	2.3	9 1/2

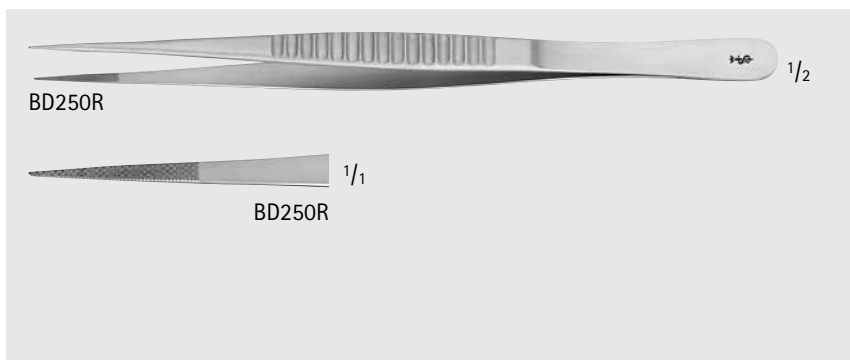

**COOLEY Vascular Tissue Forceps**

Catalog Number	Length (in.)
BD250R	7 7/8



BD770R

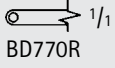

BD770R

**MILLS Mammary/Coronary Tissue Forceps**

Catalog Number	Length (in.)
BD770R	7



FB130R

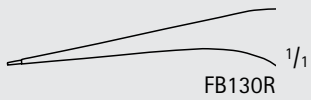

FB130R

**Dilator Forceps**

Catalog Number	Tip Size (mm)	Length (in.)
FB130R	0.2	4 1/2



BD980R

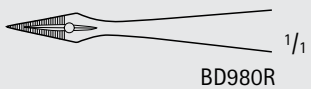

BD980R

**HUNTER Splinter Forceps**

Catalog Number	Length (in.)
BD980R	4 1/8

# General Surgery

## DUROGRIP™ TC Tissue Forceps

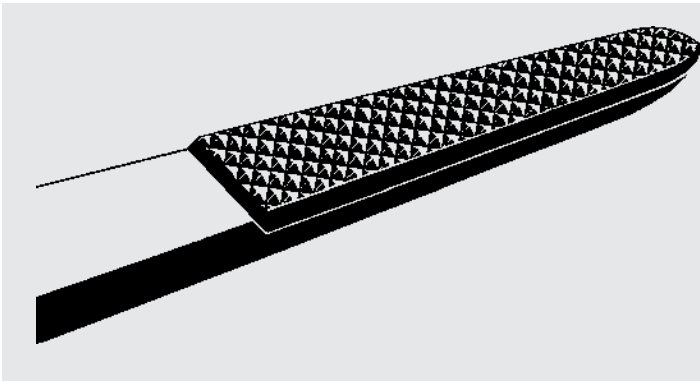

DUROGRIP Tungsten Carbide Tissue Forceps

- Cross-Serrated Platform tips for firm and non-traumatic grip
- Long working life
- Gold-plated end



BD151R

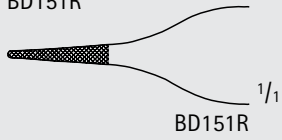

BD151R



US109-US110

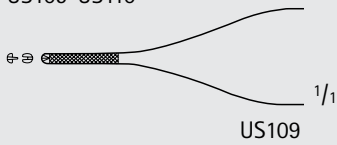

US109

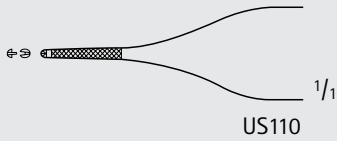

US110



MB484R-MB485R



MB484R



MB485R

### DUROGRIP TC ADSON Forceps

Catalog Number	Tip	Teeth	Length (in.)
BD151R	X-SERR	-	4 3/4
US109	X-SERR	1 x 2	4 3/4
US110	DEL, X-SERR	1 x 2	4 3/4
MB484R	X-SERR	1 x 2	6
MB485R	DEL, X-SERR	1 x 2	6



US112

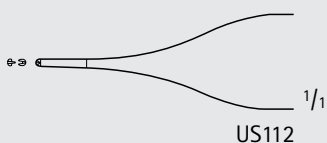

US112

### DUROGRIP TC GORNEY-ADSON Forceps

Catalog Number	Tip	Teeth	Length (in.)
US112	DEL, SMOOTH	1 x 2	4 3/4

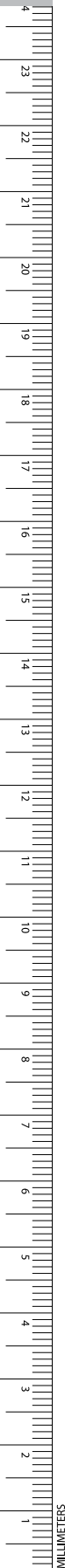

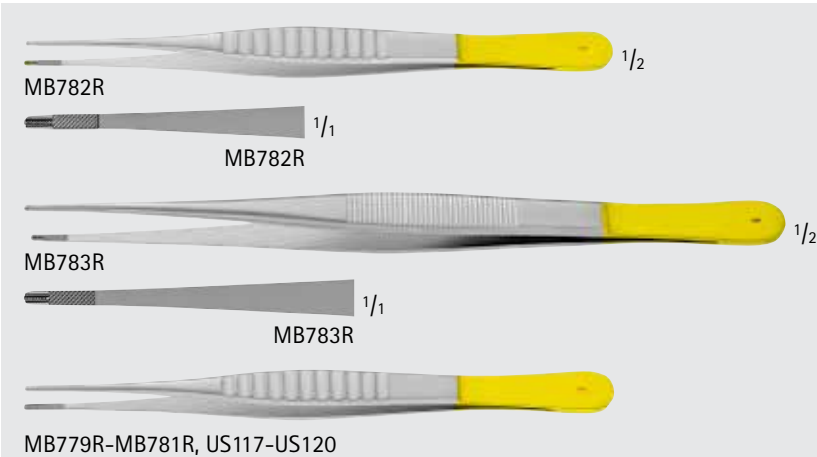

DUROGRIP TC DEBAKEY Needle Forceps

Catalog Number	Tip	Tip Size (mm)	Length (in.)
MB782R	-	1.5	6
MB783R	-	1.5	7 3/4
US119	NARROW	1.5	7 3/4
MB779R	-	2	6
MB780R	-	2	8
MB781R	-	2	10 1/2
US117	-	2	6
US118	-	2	8
US120	NARROW	2	9

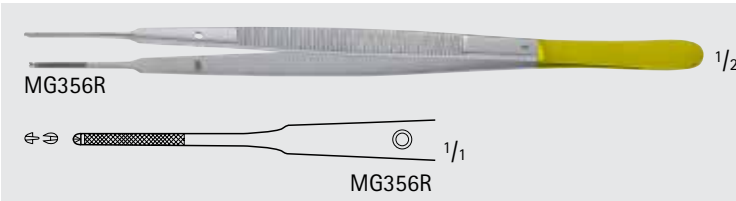
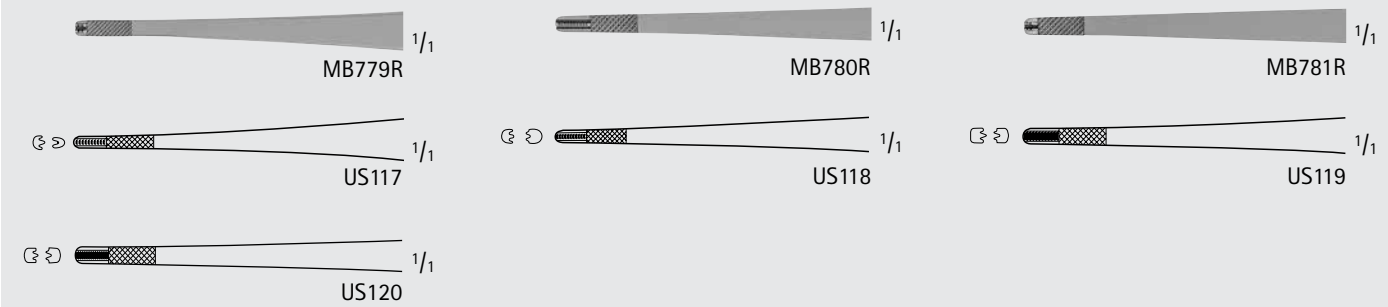

GERALD Needle Forceps

Catalog Number	Tip	Teeth	Length (in.)
MG356R	X-SERR	1 x 2	6 7/8

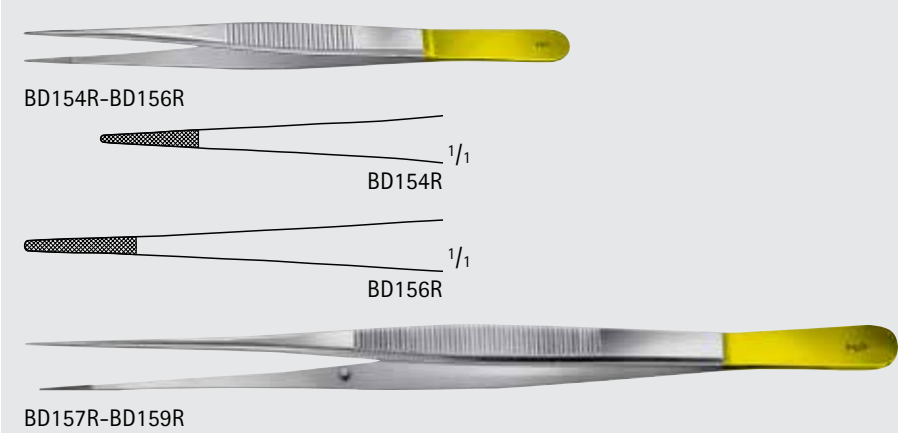

DUROGRIP TC (POTTS-SMITH) Thumb Forceps

Catalog Number	Tip	Length (in.)
BD154R	X-SERR	5 3/4
BD156R	X-SERR	7
BD157R	X-SERR	7 7/8
BD158R	X-SERR	9
BD159R	X-SERR	9 3/4

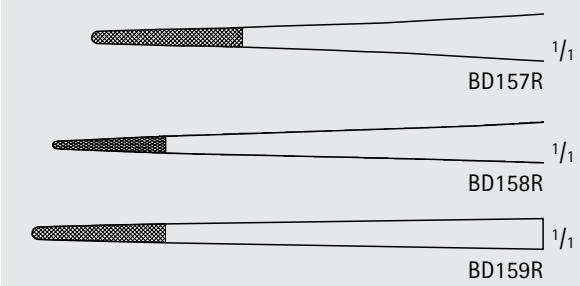

INCHES

# General Surgery

## DUROGRIP™ TC Tissue Forceps

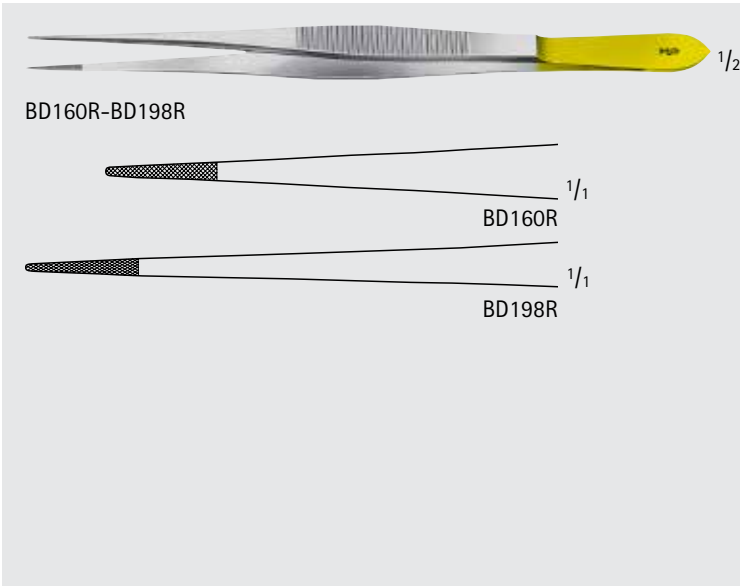

**DUROGRIP TC CUSHING Forceps, W/ Scraper End**

Catalog Number	Tip	Length (in.)
BD160R	X-SERR	7
BD198R	X-SERR	9 3/4

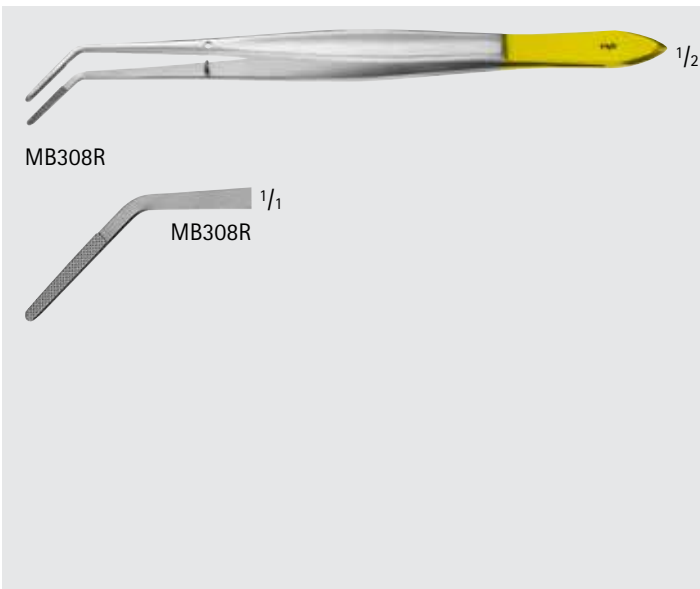

**DUROGRIP TC CUSHING Forceps**

Catalog Number	Tip	Length (in.)
MB308R	ANG, X-SERR	6 1/4

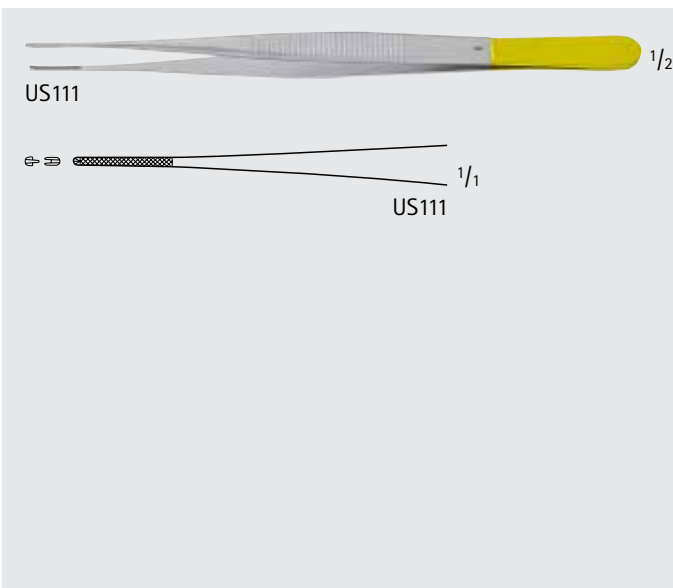

**DUROGRIP TC SEMKEN Forceps**

Catalog Number	Tip	Tip Size (mm)	Teeth	Length (in.)
US111	X-SERR	1	1 x 2	6 1/4



BD164R-BD166R

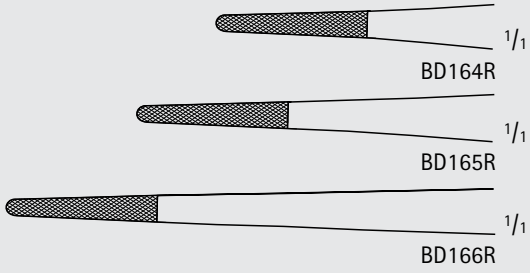

**DUROGRIP TC STANDARD Forceps**

Catalog Number	Tip	Length (in.)
BD164R	X-SERR	5 3/4
BD165R	X-SERR	7 7/8
BD166R	X-SERR	9 3/4



BD168R

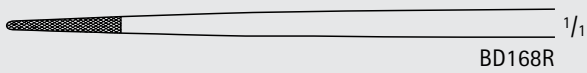

**DUROGRIP TC GRUENWALD Forceps**

Catalog Number	Tip	Length (in.)
BD168R	X-SERR	7 1/4



BD171R-BD173R

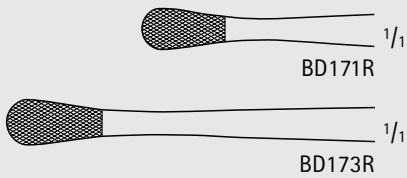

**DUROGRIP TC WANGENSTEEN Forceps**

Catalog Number	Tip	Length (in.)
BD171R	X-SERR	6
BD173R	X-SERR	9



INCHES

# General Surgery

## Abdominal and Intestinal Grasping Forceps

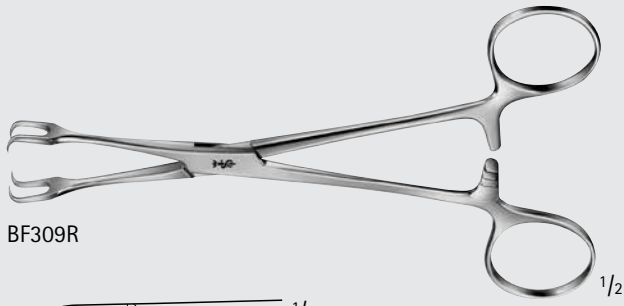

BF309R

1/2

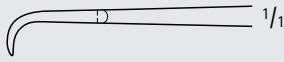

BF309R

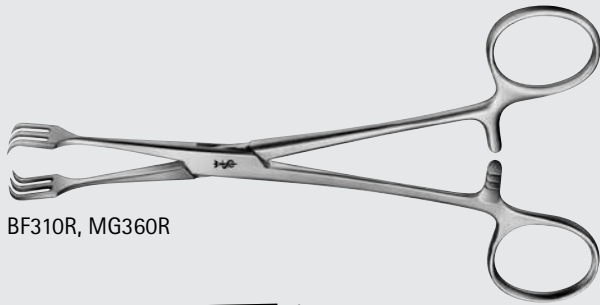

BF310R, MG360R

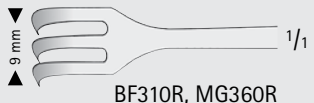
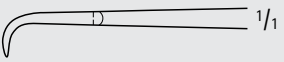

BF310R, MG360R

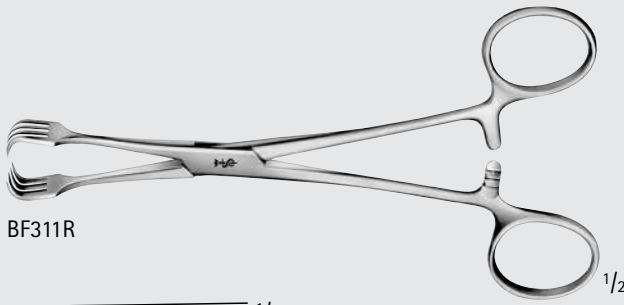

BF311R

1/2

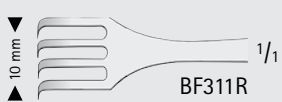
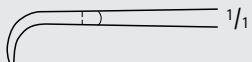

BF311R

### LAHEY Forceps

Catalog Number	Teeth	Length (in.)
BF309R	2 x 2	6 1/8
BF310R	3 x 3	6 1/8
MG360R	3 x 3	8
BF311R	4 x 4	6 1/8

# General Surgery

## Abdominal and Intestinal Grasping Forceps

GENERAL SURGERY



### BOYS-ALLIS Forceps

Catalog Number	Teeth	Length (in.)
EA010R	5 x 6	6 1/8

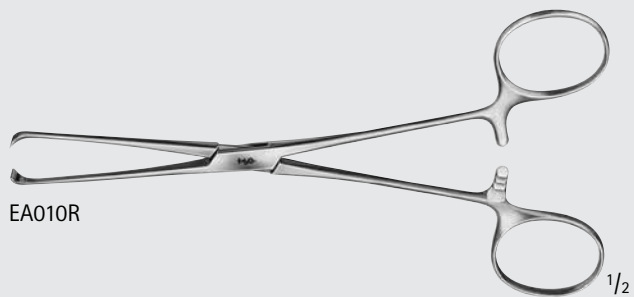

EA010R

1/2



1/1

EA010R

### Baby ALLIS Forceps

Catalog Number	Teeth	Length (in.)
EA012R	4 x 5	5 1/8

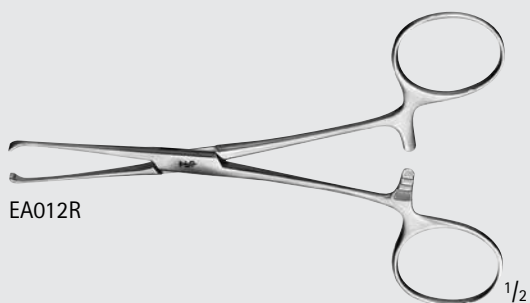

EA012R

1/2

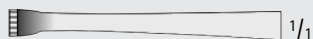

1/1

EA012R

### ALLIS Forceps

Catalog Number	Teeth	Length (in.)
EA015R	4 x 5	6 1/8
EA016R	5 x 6	6 1/8
EA017R	5 x 6	7 1/2
FB938R	5 x 6	8 3/4
EA018R	5 x 6	10
MB910R	5 x 6	16

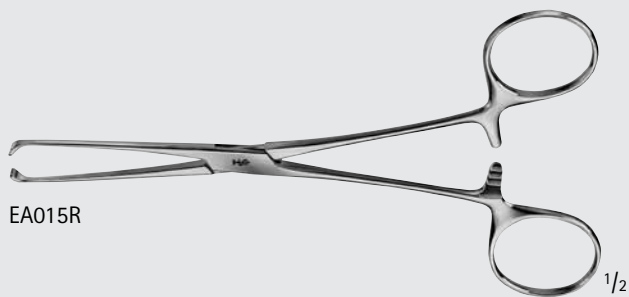

EA015R

1/2



1/1

EA015R

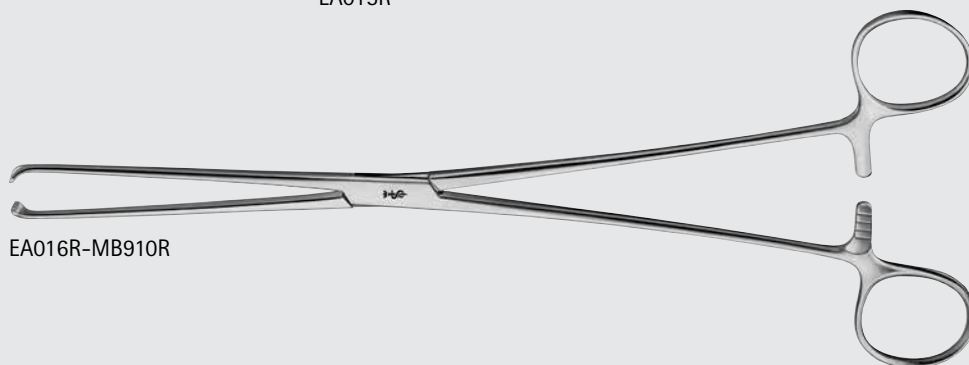

EA016R-MB910R



1/1

EA016R-MB910R

INCHES

# General Surgery

## Abdominal and Intestinal Grasping Forceps

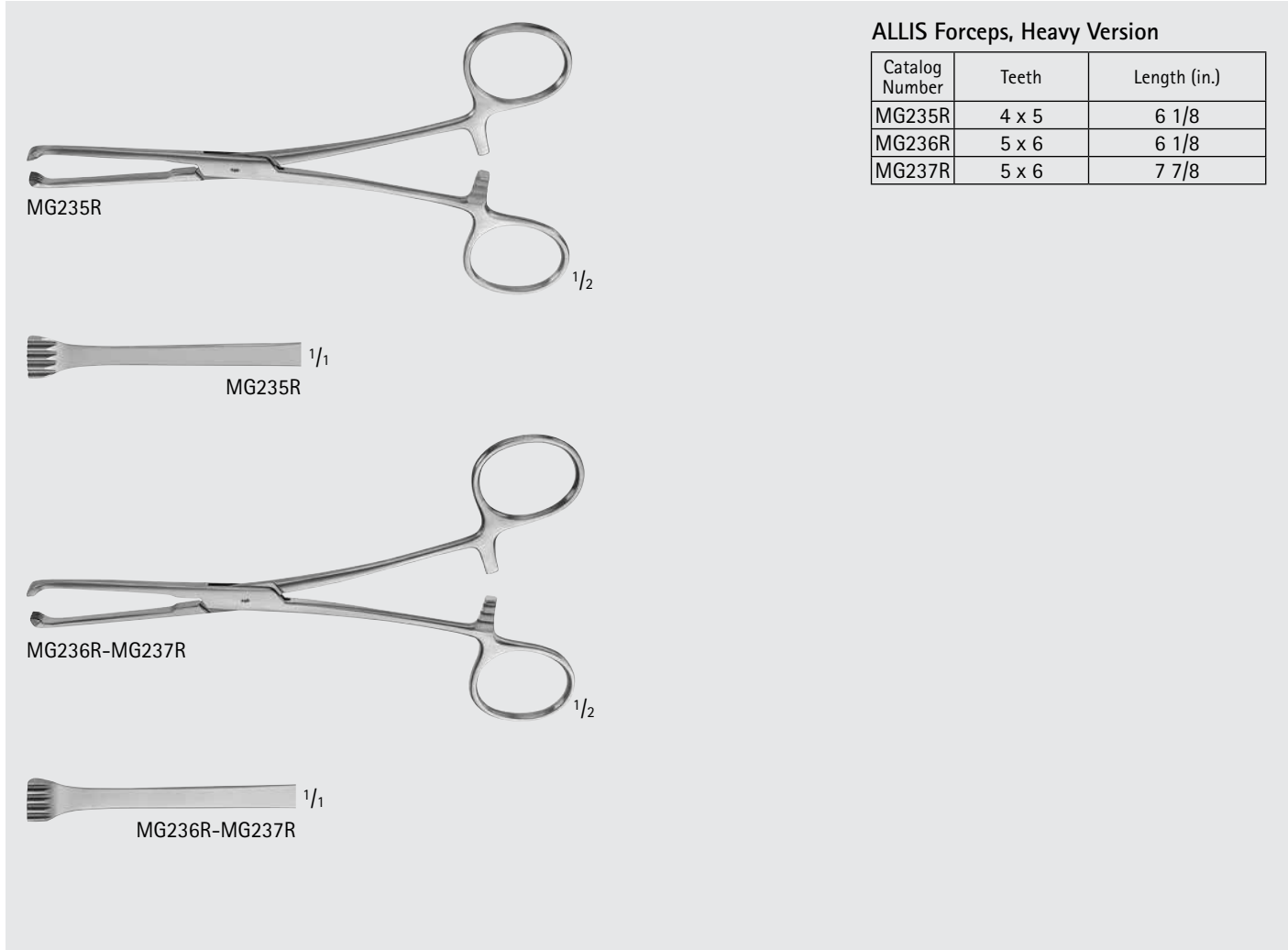

**ALLIS Forceps, Heavy Version**

Catalog Number	Teeth	Length (in.)
MG235R	4 x 5	6 1/8
MG236R	5 x 6	6 1/8
MG237R	5 x 6	7 7/8

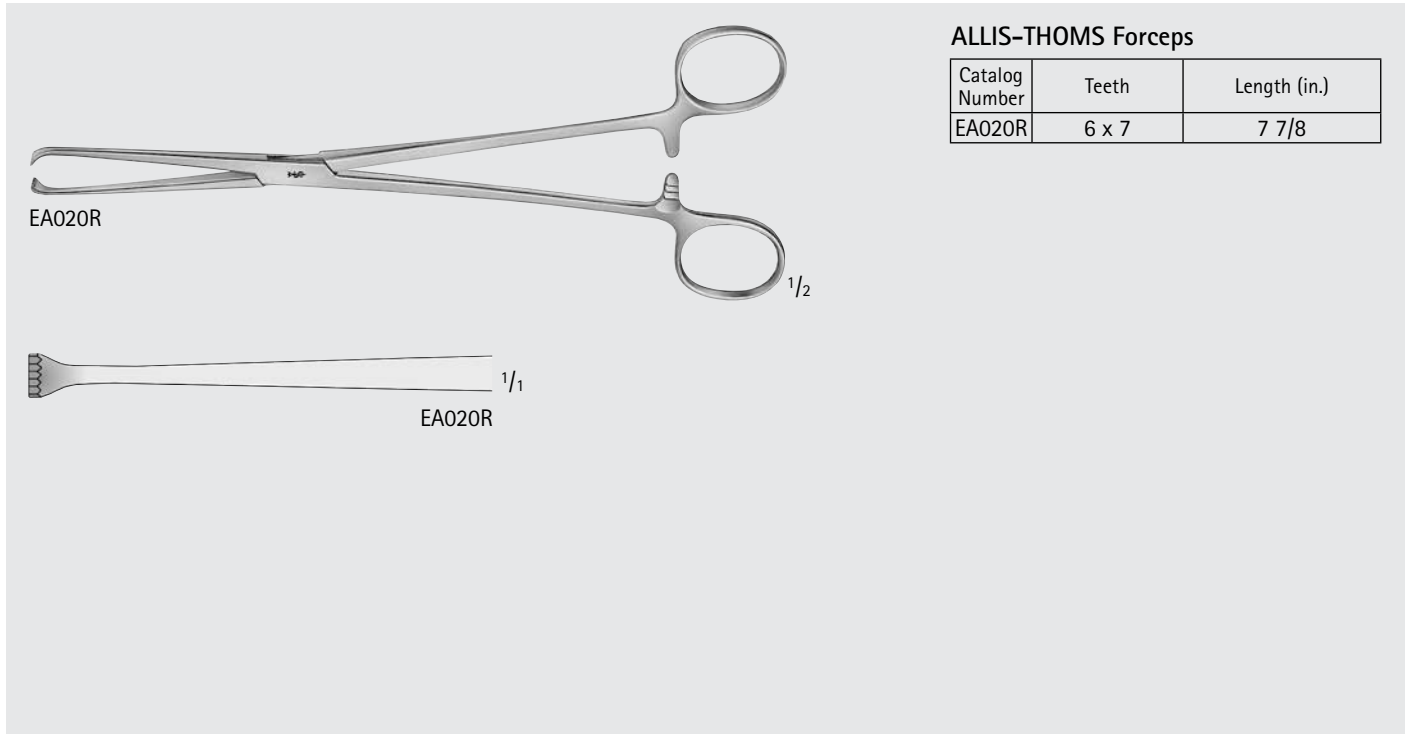

**ALLIS-THOMS Forceps**

Catalog Number	Teeth	Length (in.)
EA020R	6 x 7	7 7/8

# General Surgery

## Abdominal and Intestinal Grasping Forceps

GENERAL SURGERY



### JUDD-ALLIS Forceps

Catalog Number	Teeth	Length (in.)
EA025R	3 x 4	6 1/8
EA026R	3 x 4	7 7/8

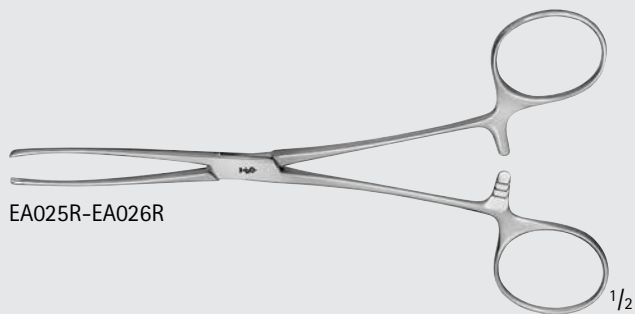

EA025R-EA026R

1/2

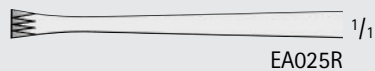

EA025R

1/1

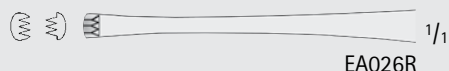

EA026R

1/1

### ALLIS-ADAIR Clamp

Catalog Number	Teeth	Length (in.)
MD568	9 x 10	6 1/4

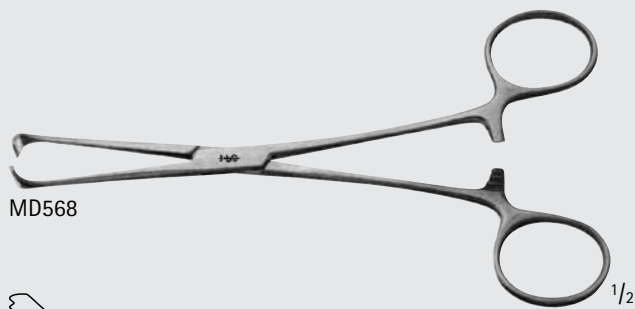

MD568

1/2



MD568

1/1

### LOCKWOOD-ALLIS Intestinal Clamp

Catalog Number	Teeth	Length (in.)
MG455R	4 x 5	6 1/2

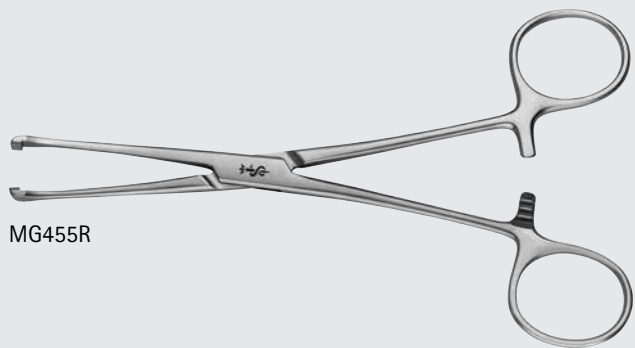

MG455R

1/2



MG455R

1/1

INCHES

# General Surgery

## Abdominal and Intestinal Grasping Forceps

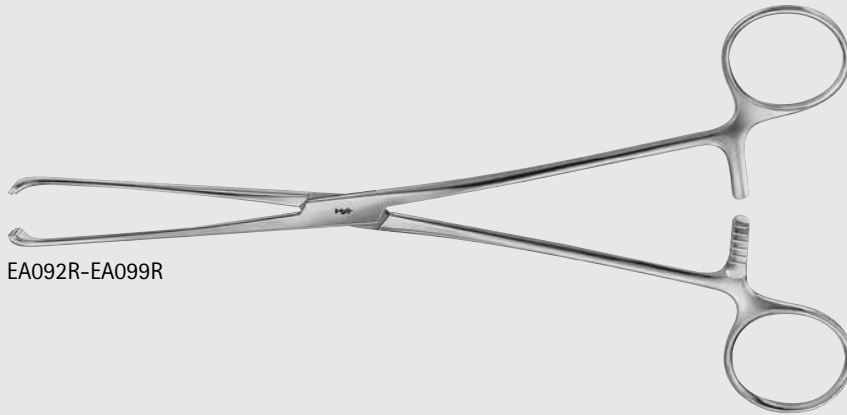

EA092R-EA099R

### ALLIS Atraumatic Forceps

Catalog Number	Length (in.)
EA092R	6 1/4
EA095R	7 7/8
EA096R	8 3/4
EA097R	10
EA100R	11 5/8
EA099R	11 3/4
EA101R	14

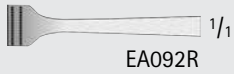

EA092R

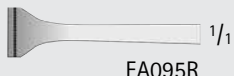

EA095R



EA096R

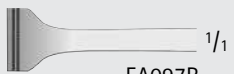

EA097R

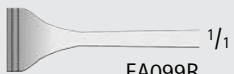

EA099R

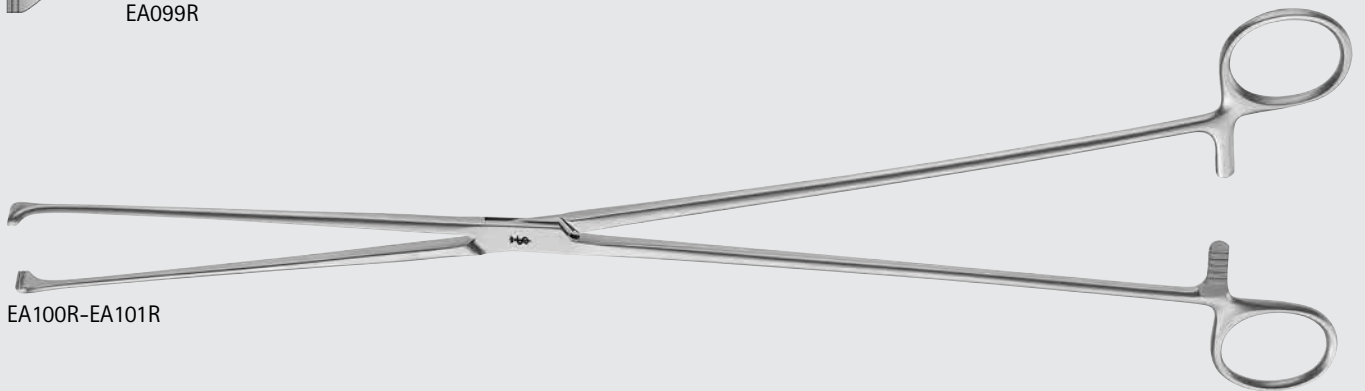

EA100R-EA101R

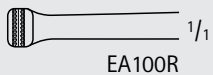

EA100R



EA101R

# General Surgery

## Abdominal and Intestinal Grasping Forceps

GENERAL SURGERY

### GLASSMAN-ALLIS Common Duct Forceps Non-Crushing

Catalog Number	Length (in.)
MG435R	8 1/2

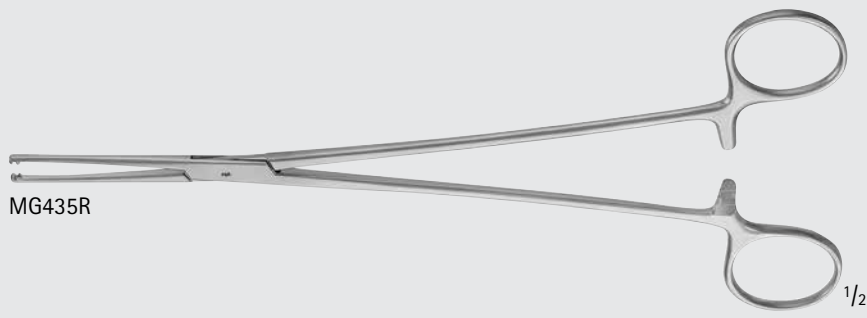

### BABCOCK Tissue Holding Forceps

Catalog Number	Length (in.)
MB136R	12
MB137R	14

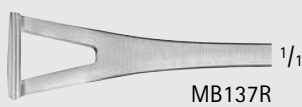

INCHES

# General Surgery

## Abdominal and Intestinal Grasping Forceps

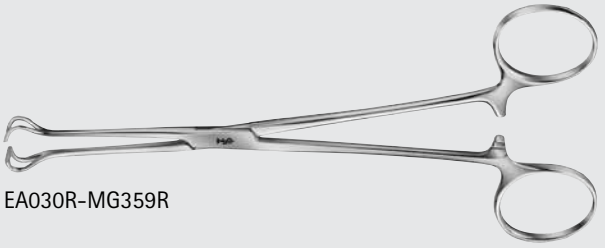

EA030R-MG359R



MG359R  $\frac{1}{1}$

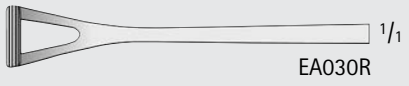

EA030R  $\frac{1}{1}$

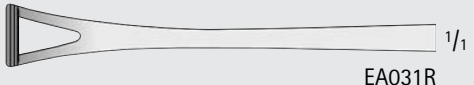

EA031R  $\frac{1}{1}$

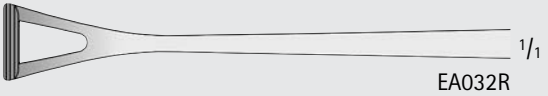

EA032R  $\frac{1}{1}$

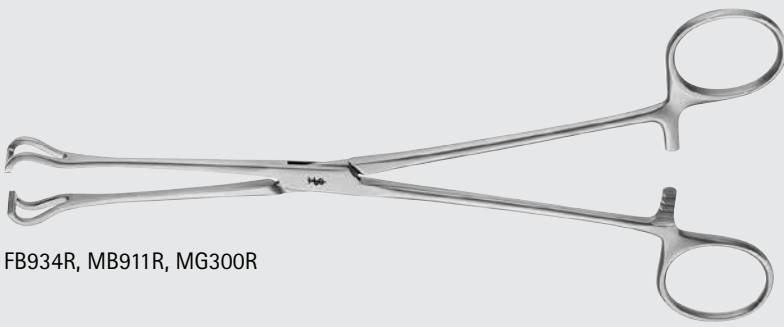

FB934R, MB911R, MG300R

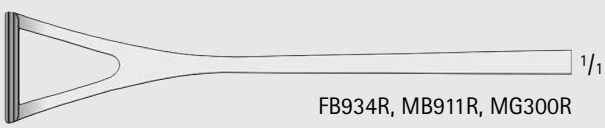

FB934R, MB911R, MG300R  $\frac{1}{1}$

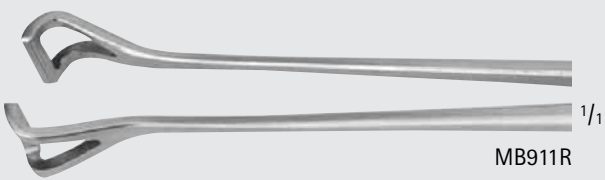

MB911R  $\frac{1}{1}$

### BABCOCK Forceps

Catalog Number	Tip	Length (in.)
MG359R	-	5 1/2
EA030R	-	6 1/8
EA031R	-	6 7/8
EA032R	-	8 1/2
FB934R	-	8 3/4
MB300R	-	14
MB911R	DEL, PETITE	16

# General Surgery

## Abdominal and Intestinal Grasping Forceps

### BABCOCK Atraumatic Forceps

Catalog Number	Length (in.)
EA050R	6 1/4
EA052R	8 1/2
FB936R	8 3/4
MD470	9 1/2

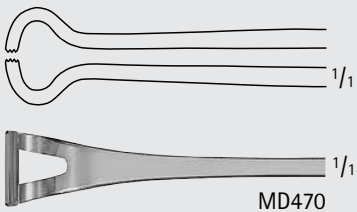
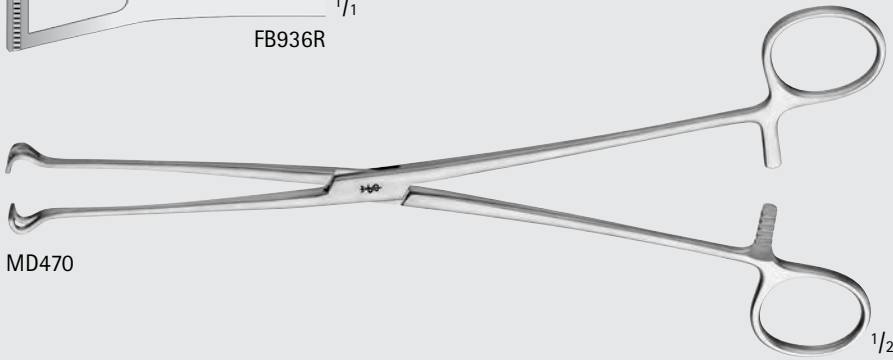
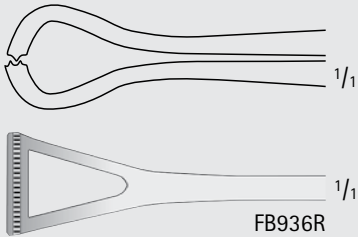
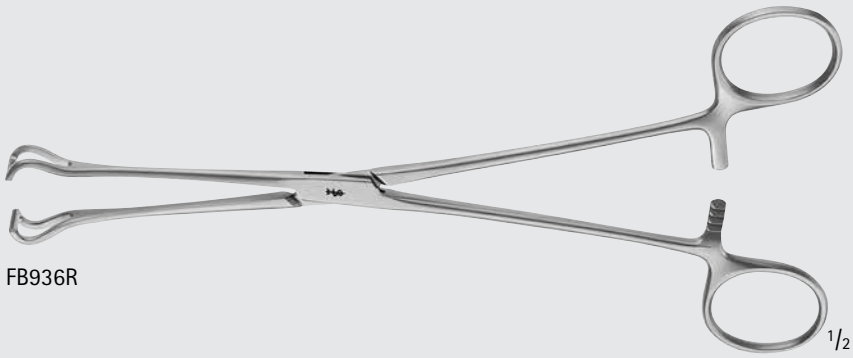
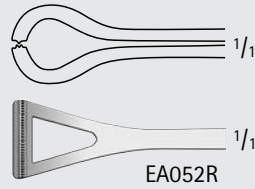
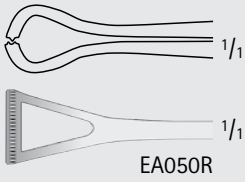
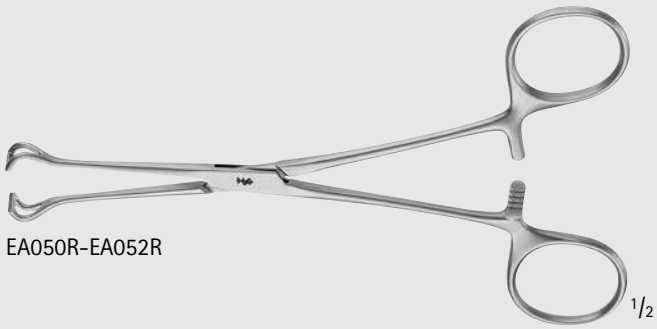

# General Surgery

## Abdominal and Intestinal Grasping Forceps

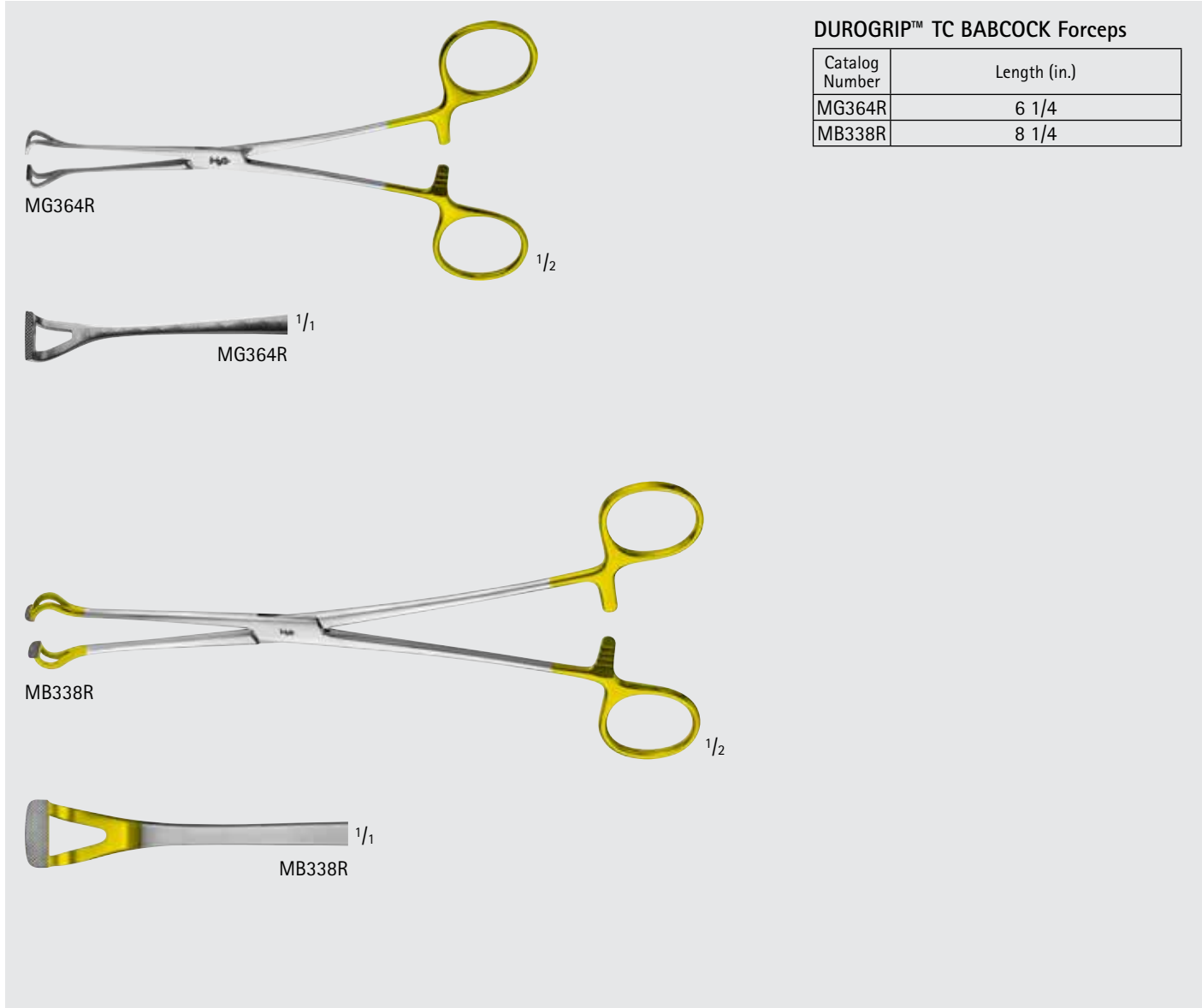
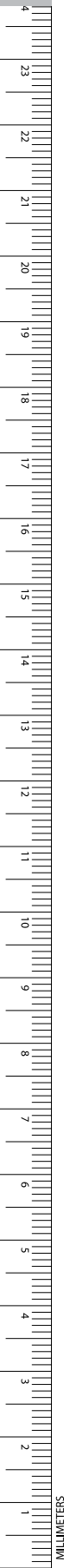

**DUROGRIP™ TC BABCOCK Forceps**

Catalog Number	Length (in.)
MG364R	6 1/4
MB338R	8 1/4

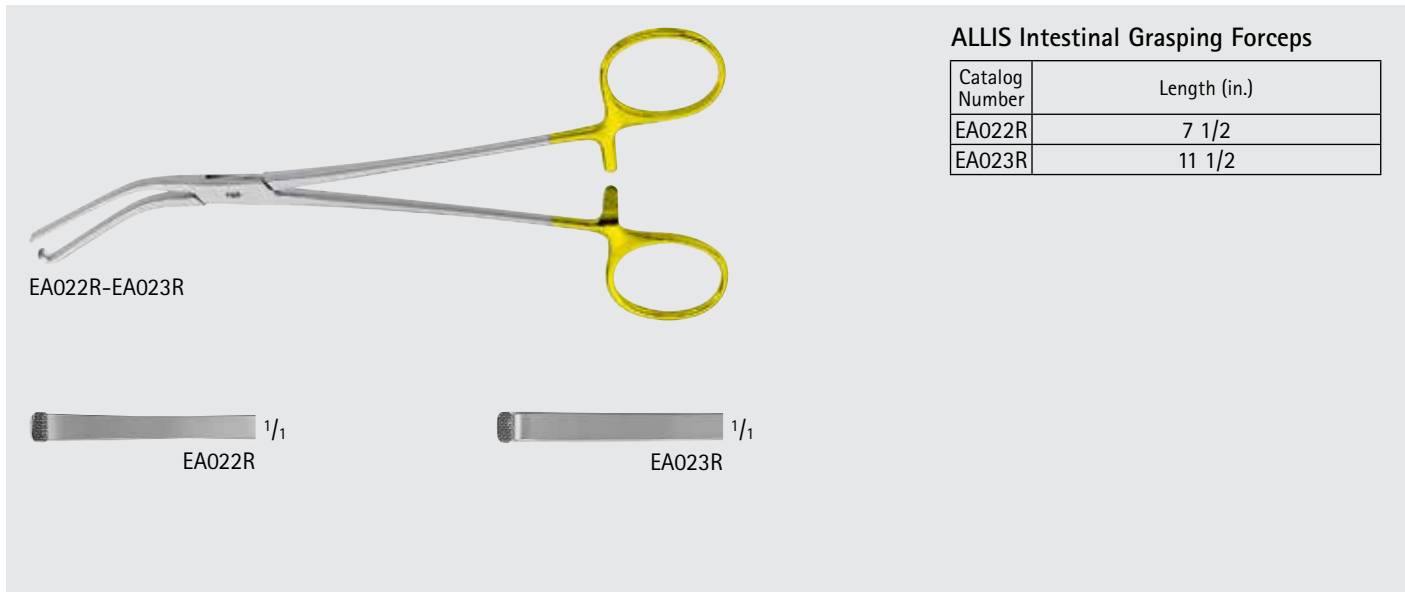

**ALLIS Intestinal Grasping Forceps**

Catalog Number	Length (in.)
EA022R	7 1/2
EA023R	11 1/2

**COLLIN Intestinal Forceps**

Catalog Number	Length (in.)
EA039R	5 1/2
EA040R	7

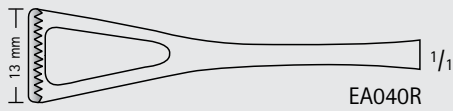
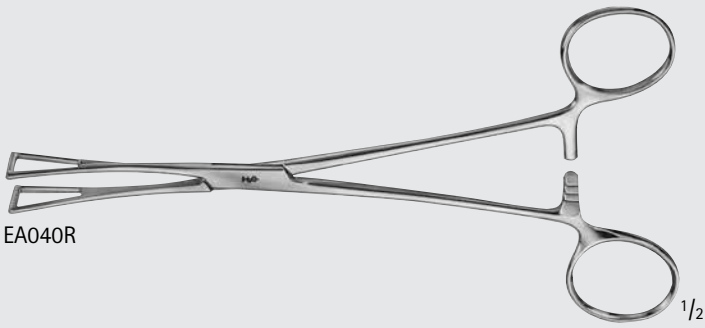
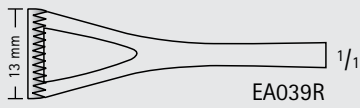
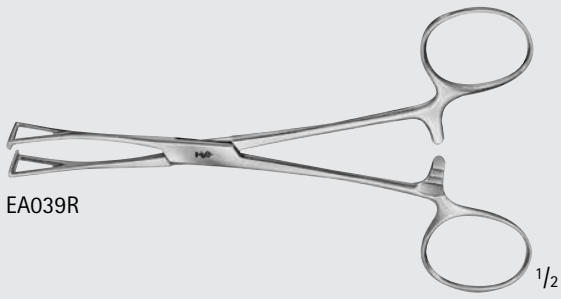

**COLLIN Atraumatic Forceps**

Catalog Number	Length (in.)
EA061R	7 3/4
EA062R	9

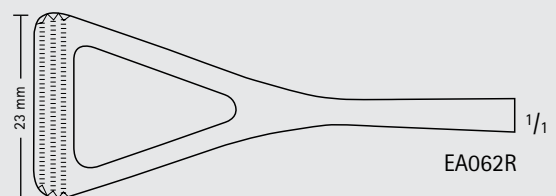
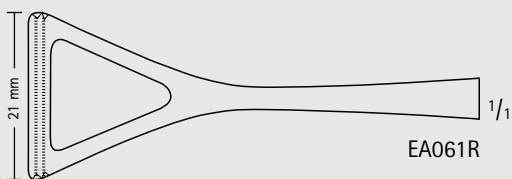
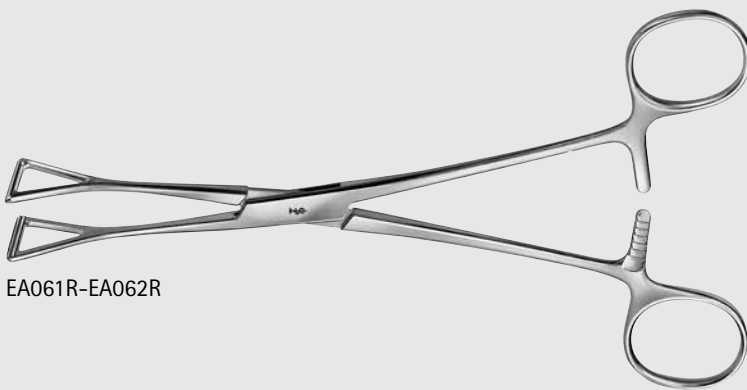

# General Surgery

## Abdominal and Intestinal Grasping Forceps



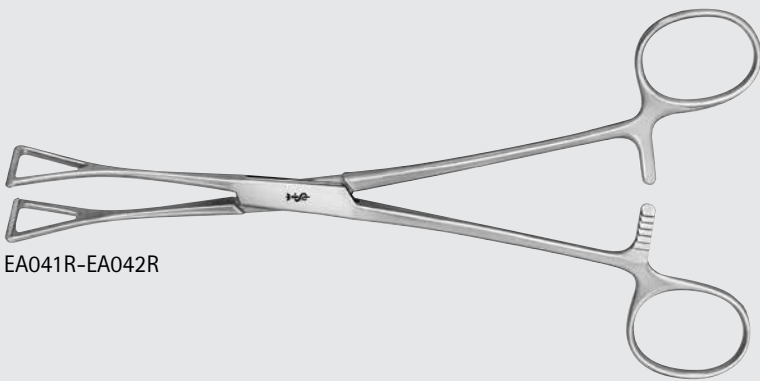

EA041R-EA042R

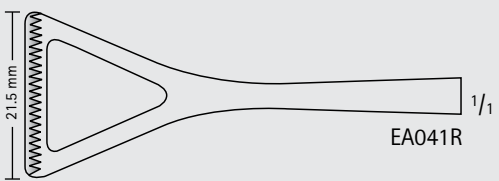

21.5 mm  
EA041R

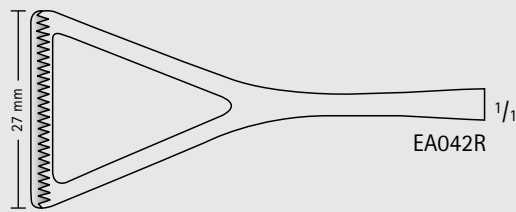

27 mm  
EA042R

**DUVAL-COLLIN Intestinal Forceps**

Catalog Number	Length (in.)
EA041R	7 3/4
EA042R	7 7/8

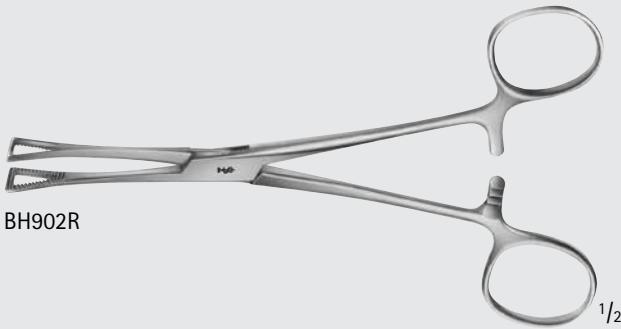

BH902R

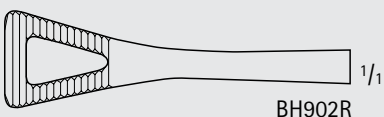

1/1  
BH902R

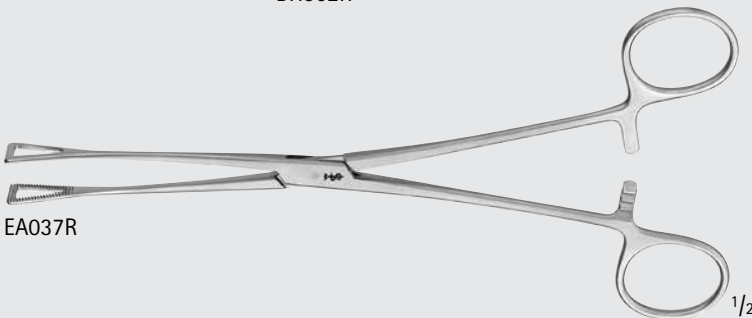

EA037R

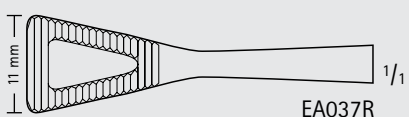

11 mm  
EA037R

**PENNINGTON Forceps**

Catalog Number	Length (in.)
BH902R	6 1/8
EA037R	7 7/8



**BAINBRIDGE Intestinal Forceps, Longitudinal Serrations**

Catalog Number	Jaw	Length (in.)
EA106R	STR	6 1/8
US114	STR	7 1/4
EA107R	CVD	6 1/8
US115	CVD	7 1/4

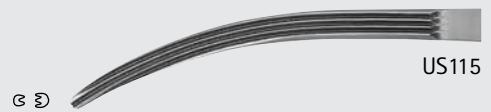
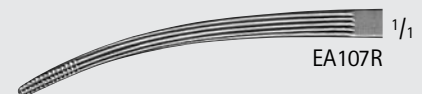
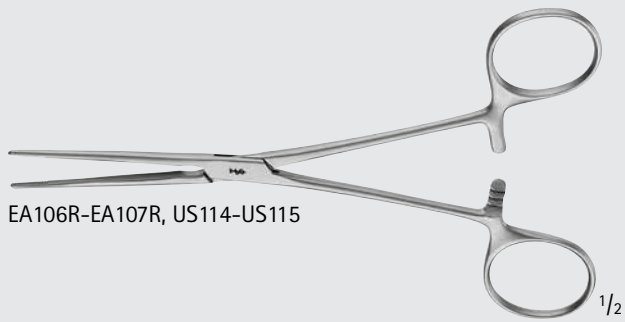

**ALLEN Intestinal Forceps, Longitudinal Serrated**

Catalog Number	Teeth	Length (in.)
EA114R	1 x 2	6 1/8
MB609R	1 x 2	7 7/8

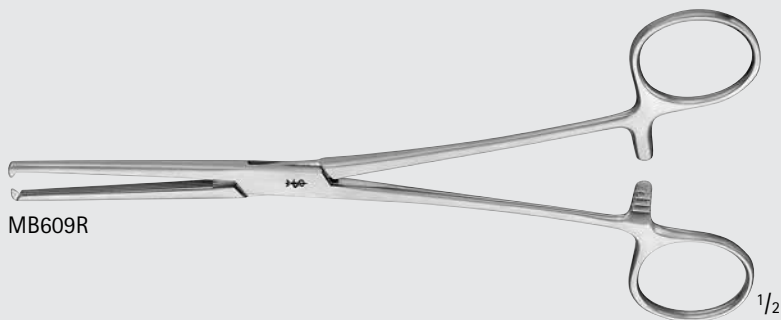
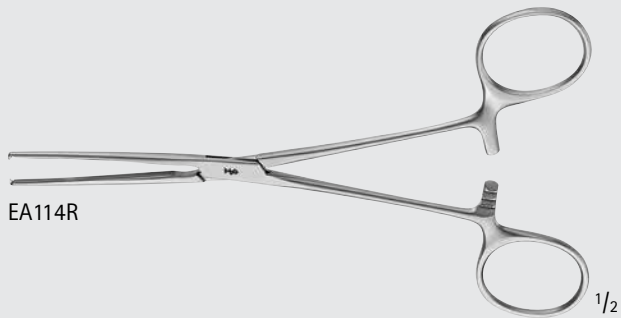

# General Surgery

## Abdominal and Intestinal Forceps

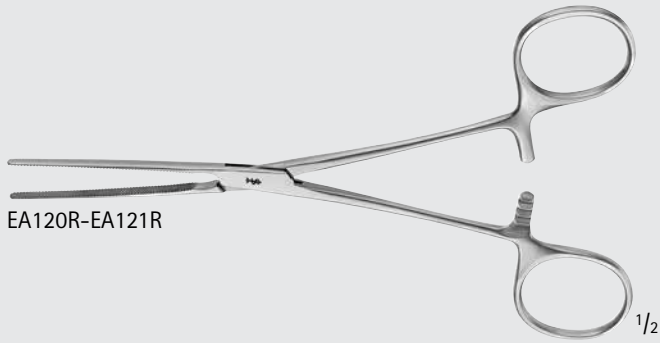

EA120R-EA121R



EA120R



EA121R

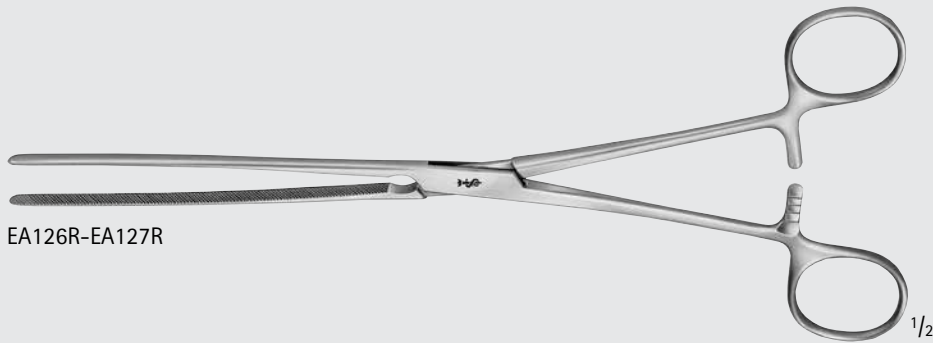

EA126R-EA127R

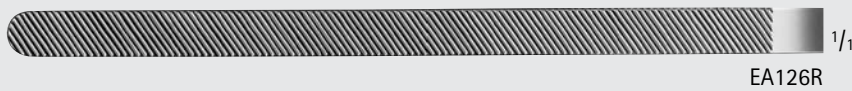

EA126R

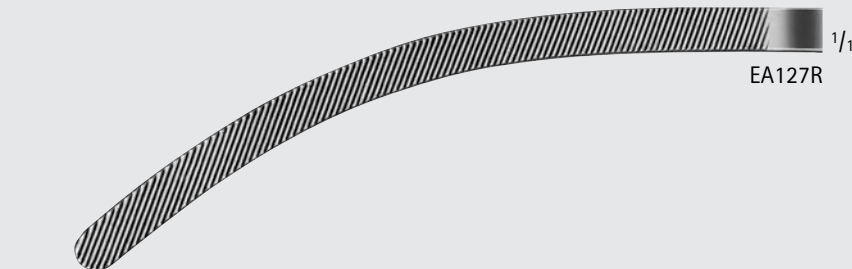

EA127R

### DOYEN Intestinal Forceps, Elastic Blades

Catalog Number	Jaw	Length (in.)
EA120R	STR	6 1/2
EA126R	STR	9 1/4
EA121R	CVD	6 1/2
EA127R	CVD	9 1/4

**DOYEN Intestinal Forceps, Elastic Blades, Longitudinal Serations**

Catalog Number	Jaw	Length (in.)
EA130R	STR	9 1/2
EA131R	CVD	9 1/2

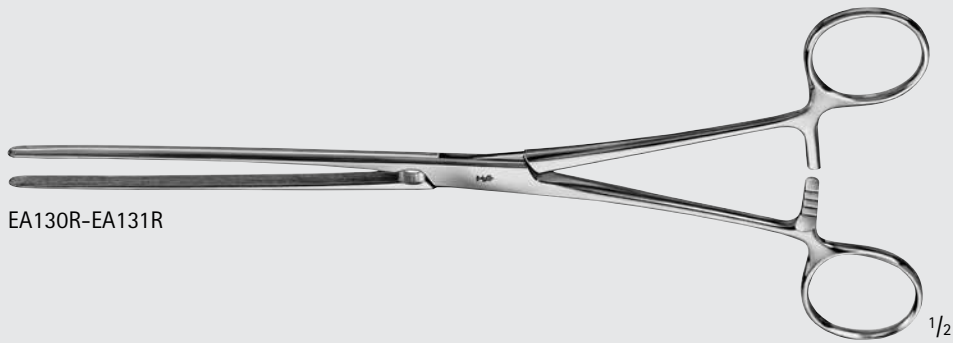

EA130R-EA131R



EA130R

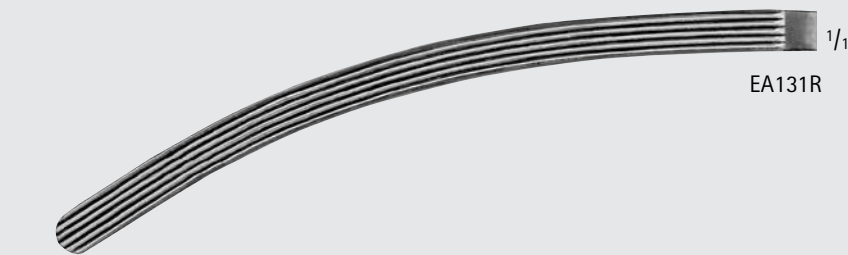

EA131R

**HARTMANN Intestinal Clamp, Elastic Blades**

Catalog Number	Jaw	Length (in.)
EA124R	STR	7 7/8
EA125R	CVD	7 7/8

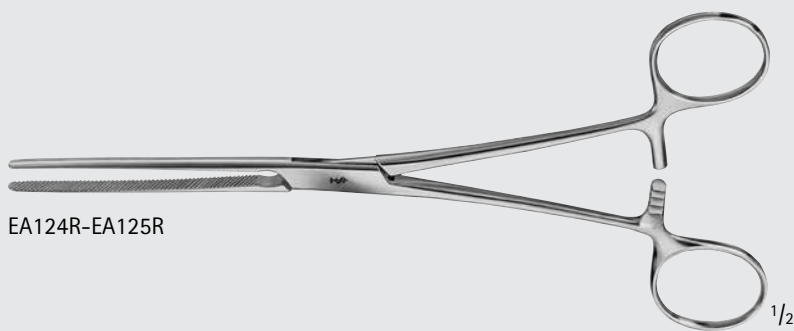

EA124R-EA125R



EA124R

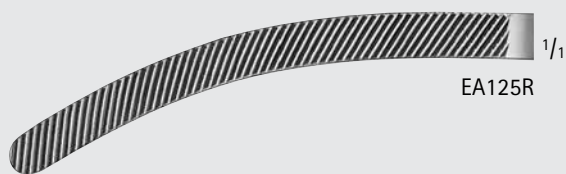

EA125R

# General Surgery

## Abdominal and Intestinal Forceps

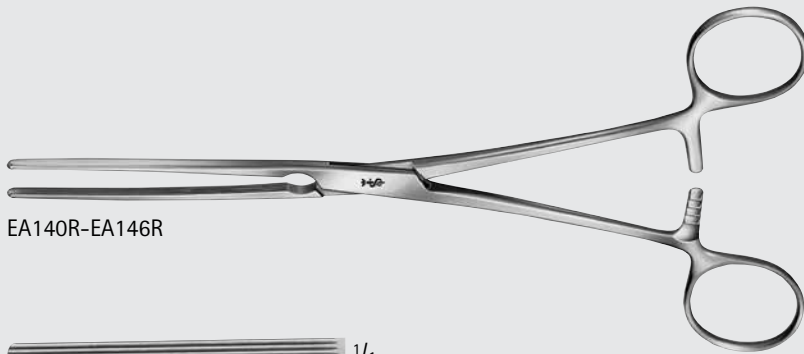

EA140R-EA146R



EA116R



EA140R



EA145R

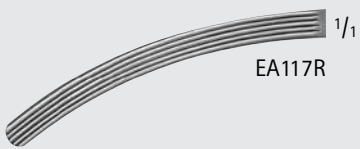

EA117R



EA141R

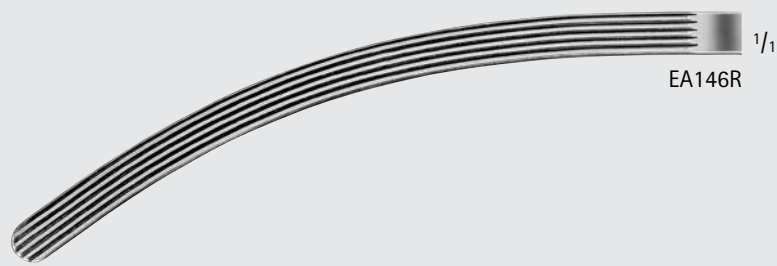

EA146R

### KOCHER Intestinal Forceps, Elastic Blades

Catalog Number	Jaw	Length (in.)
EA116R	STR	6 1/8
EA140R	STR	8 1/4
EA145R	STR	9
EA117R	CVD	5 1/4
EA141R	CVD	8 1/4
EA146R	CVD	9

KOCHER Intestinal Forceps, Elastic Blades

Catalog Number	Jaw	Length (in.)
EA150R	STR	8 3/4
EA151R	STR	9 3/4
EA152R	STR	11
EA155R	CVD	8 3/4
EA156R	CVD	9 3/4

EA150R-EA156R

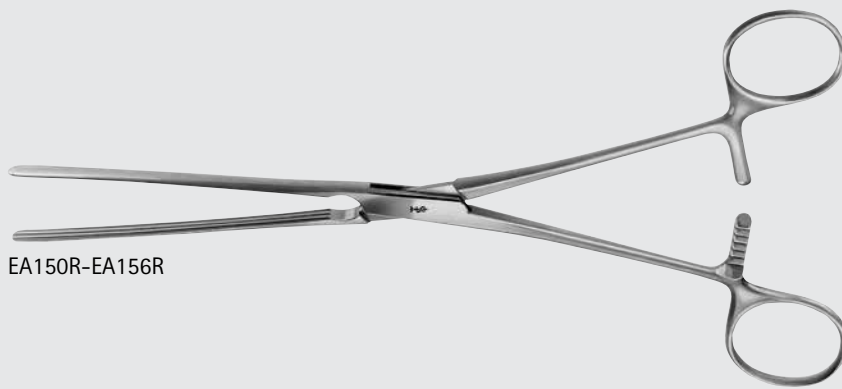

INCHES

# General Surgery

## Abdominal and Intestinal Forceps



MAYO-ROBSON Intestinal Forceps,  
Hard Elastic Blades

Catalog Number	Jaw	Length (in.)
EA170R	STR	9 3/4
EA171R	CVD	9 3/4

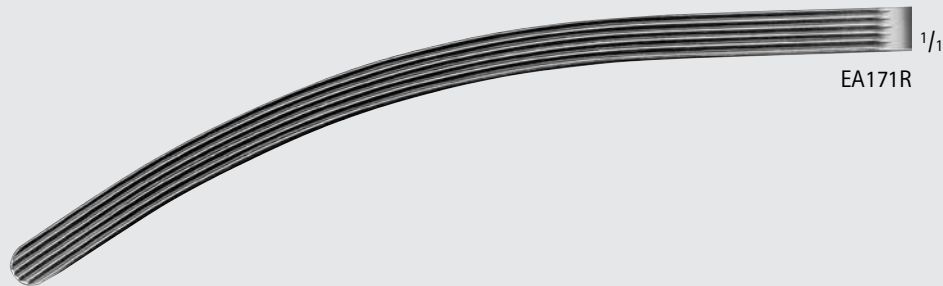
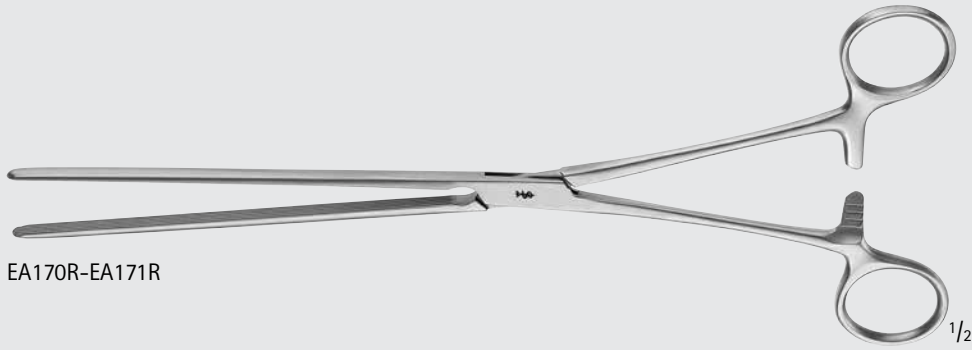

# General Surgery

## Abdominal and Intestinal Forceps

GENERAL SURGERY



EA305R-EA450R

### PAYR Intestinal Clamp

Catalog Number	Length (in.)
EA305R	7
EA306R	7 7/8
EA309R	10 3/4
EA450R	12 1/2

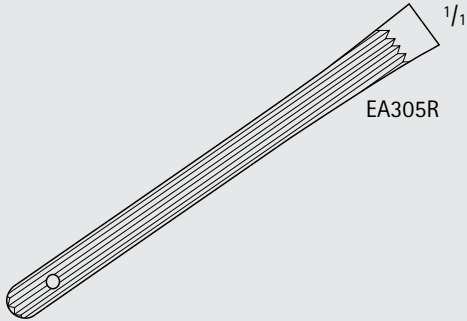

EA305R

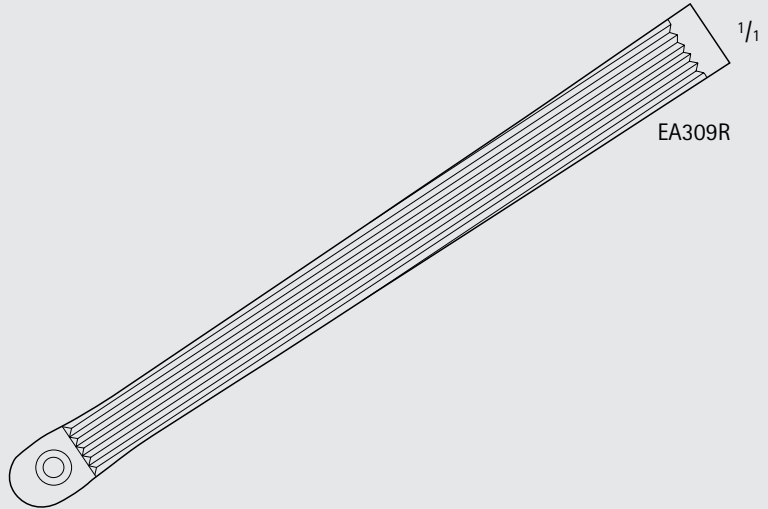

EA309R

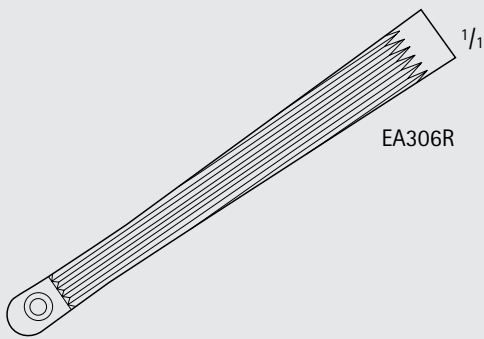

EA306R

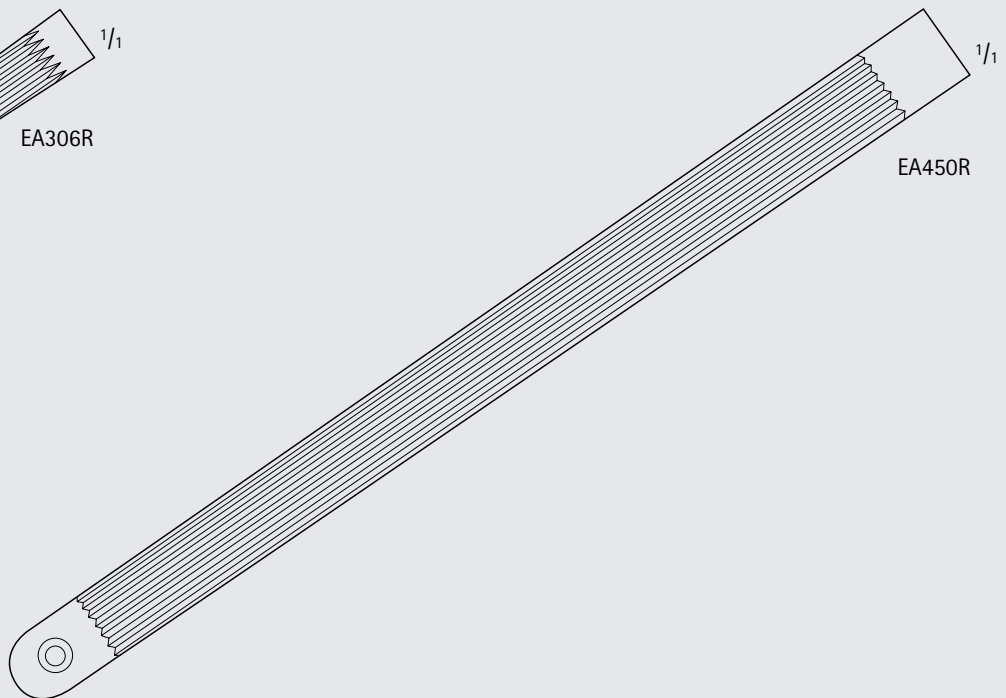

EA450R



# General Surgery

## Abdominal and Intestinal Forceps

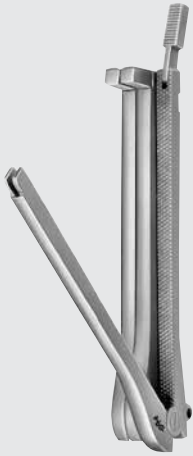

EA331R-EA332R

### DEMARTEL-WOLFSON Anastomosis Clamp

Catalog Number	Description	Length (in.)
EA331R	SET OF 3	4
EA332R	SET OF 3	4 3/4



EA334R

### Clamp Holder for Anastomosis Clamp

Catalog Number	Description	Length (in.)
EA334R	3" FOR USE WITH EA331R-EA332R	3 1/8

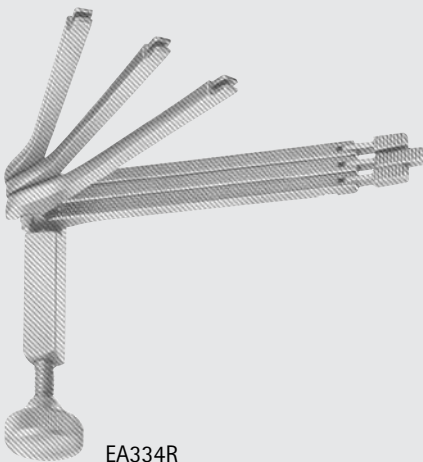

EA334R

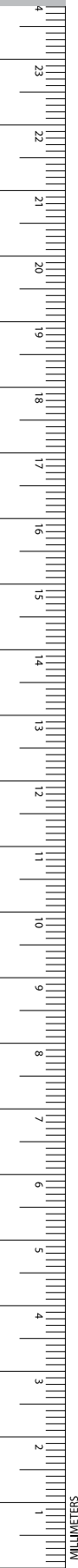

# General Surgery

## Abdominal and Intestinal Forceps

### KLEINSCHMIDT Appendectomy Forceps

Catalog Number	Jaw	Length (in.)
EA397R	CVD	5 1/8



### BENSON Pylorus Spreader

Catalog Number	Length (in.)
EA466R	6 1/8

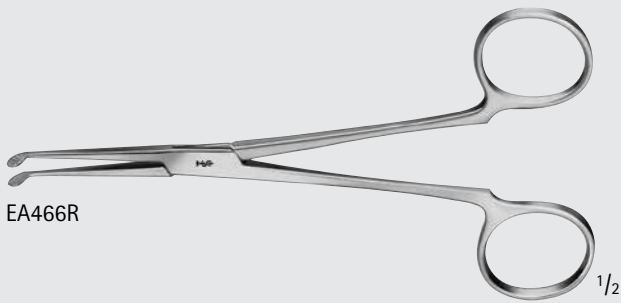

### TAUFIC Cholangiography Clamp

Catalog Number	Length (in.)
MG454R	8 1/2

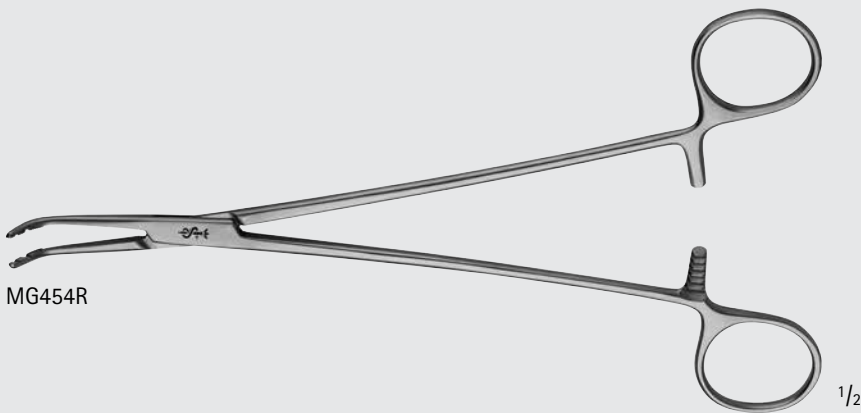

INCHES

# General Surgery

## Abdominal and Intestinal Forceps

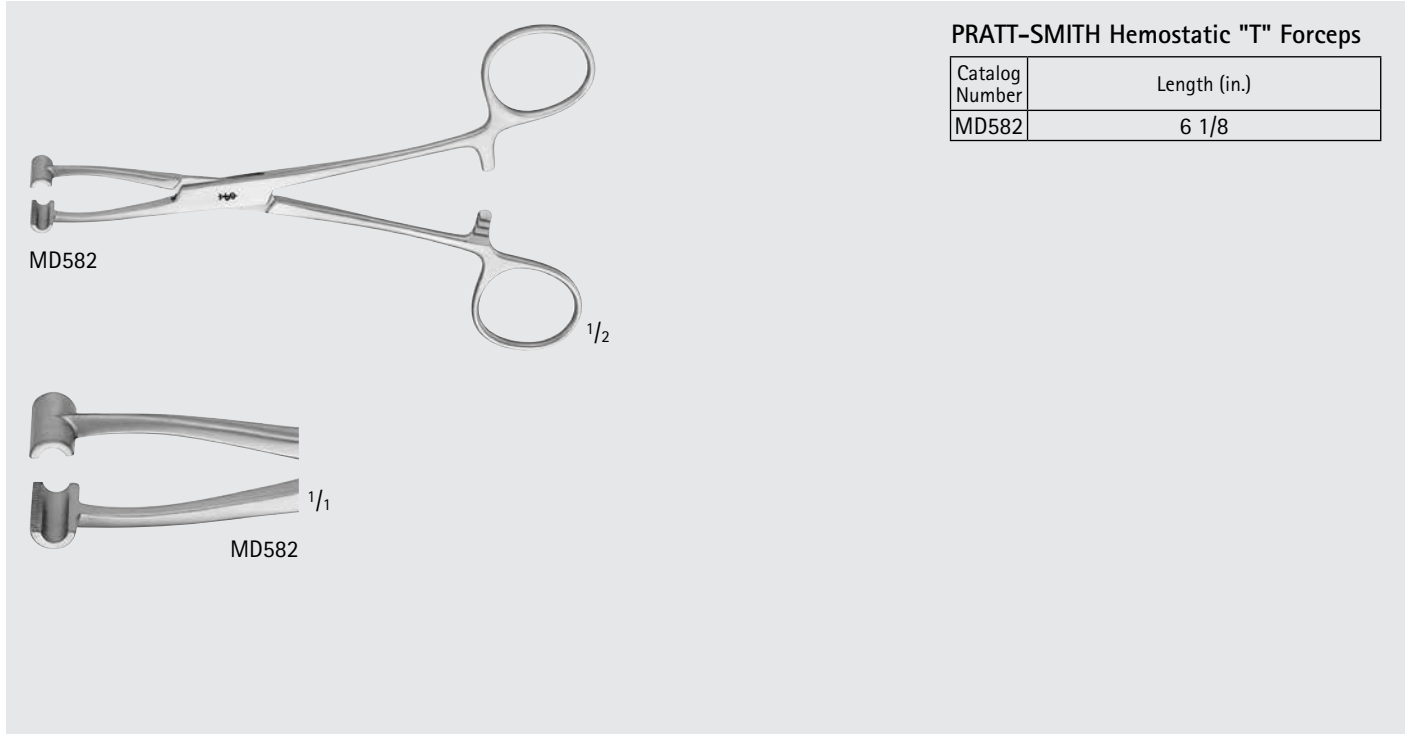

**PRATT-SMITH Hemostatic "T" Forceps**

Catalog Number	Length (in.)
MD582	6 1/8

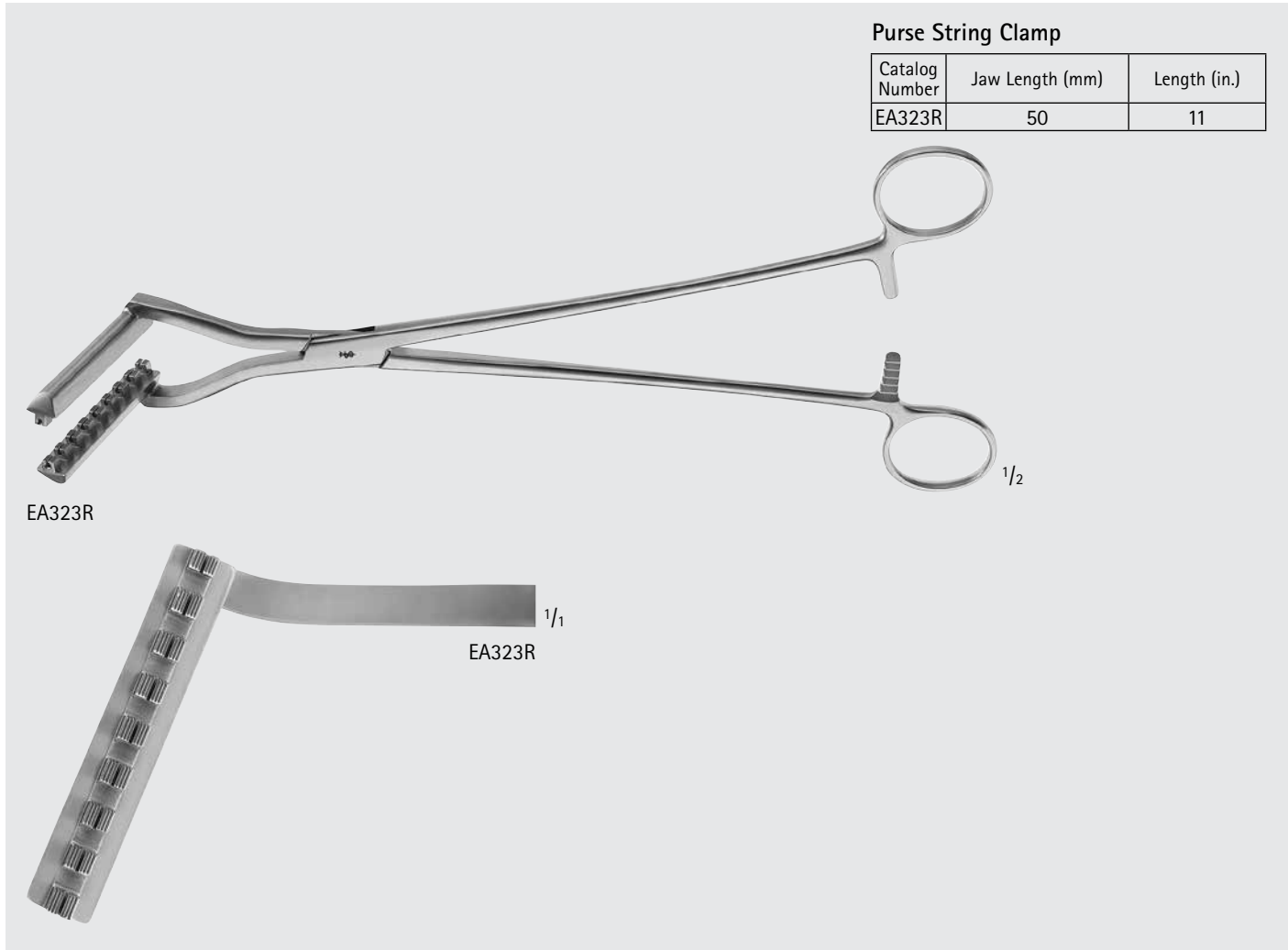

**Purse String Clamp**

Catalog Number	Jaw Length (mm)	Length (in.)
EA323R	50	11

# General Surgery

## Abdominal and Intestinal Forceps



### LOWER Gall Duct Forceps

Catalog Number	Jaw	Length (in.)
EB001R	HEAVY-CVD	7

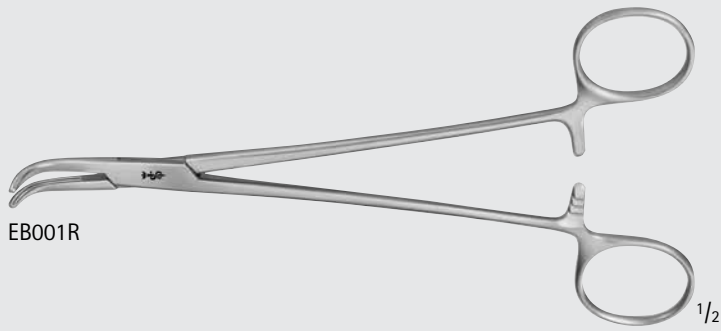

EB001R

7



EB001R

1/1

### LAHEY (SWEET) Gall Duct Forceps

Catalog Number	Jaw	Length (in.)
EB003R	CVD	7 7/8

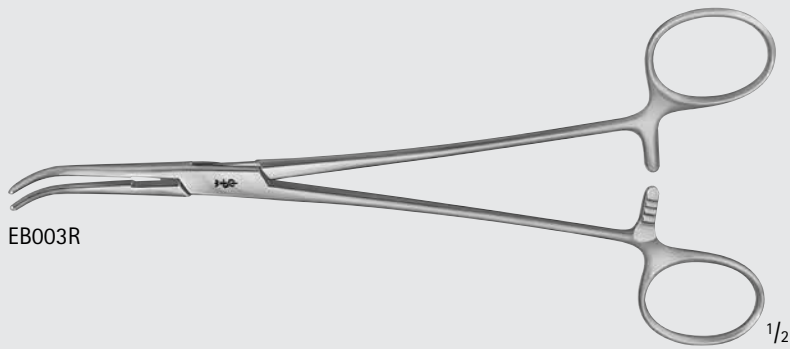

EB003R

7 7/8



EB003R

1/1

### DESJARDINS Gall Duct Forceps

Catalog Number	Jaw	Length (in.)
EB008R	HEAVY-CVD	8 3/4

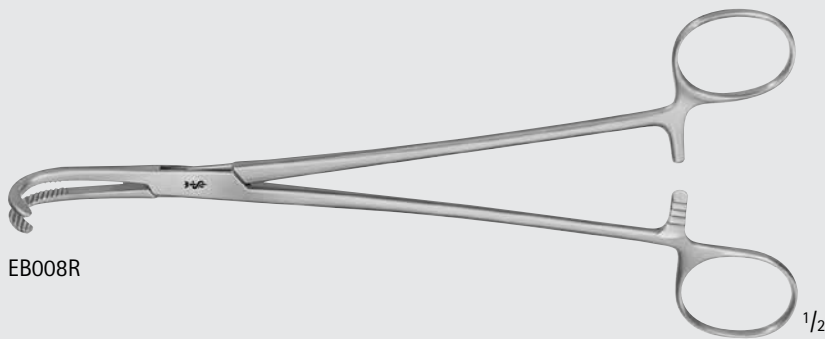

EB008R

8 3/4



EB008R

1/1

# General Surgery

## Abdominal and Intestinal Forceps

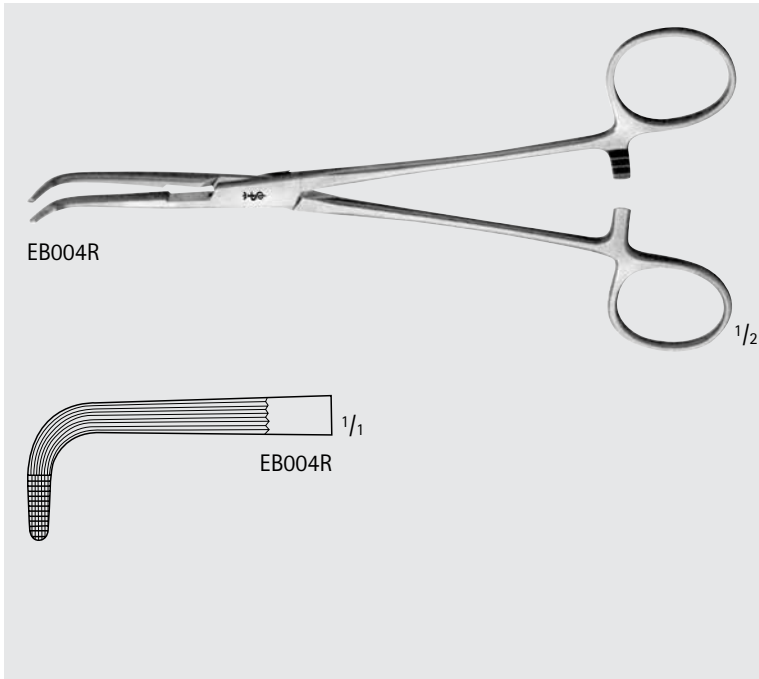
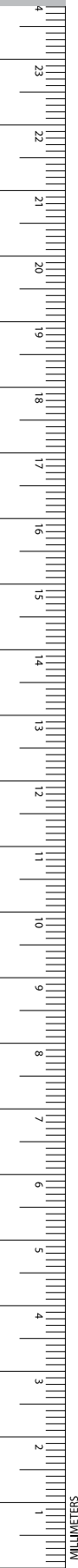

**LAHEY Gall Duct Forceps**

Catalog Number	Jaw	Length (in.)
EB004R	HEAVY-CVD	7 1/2

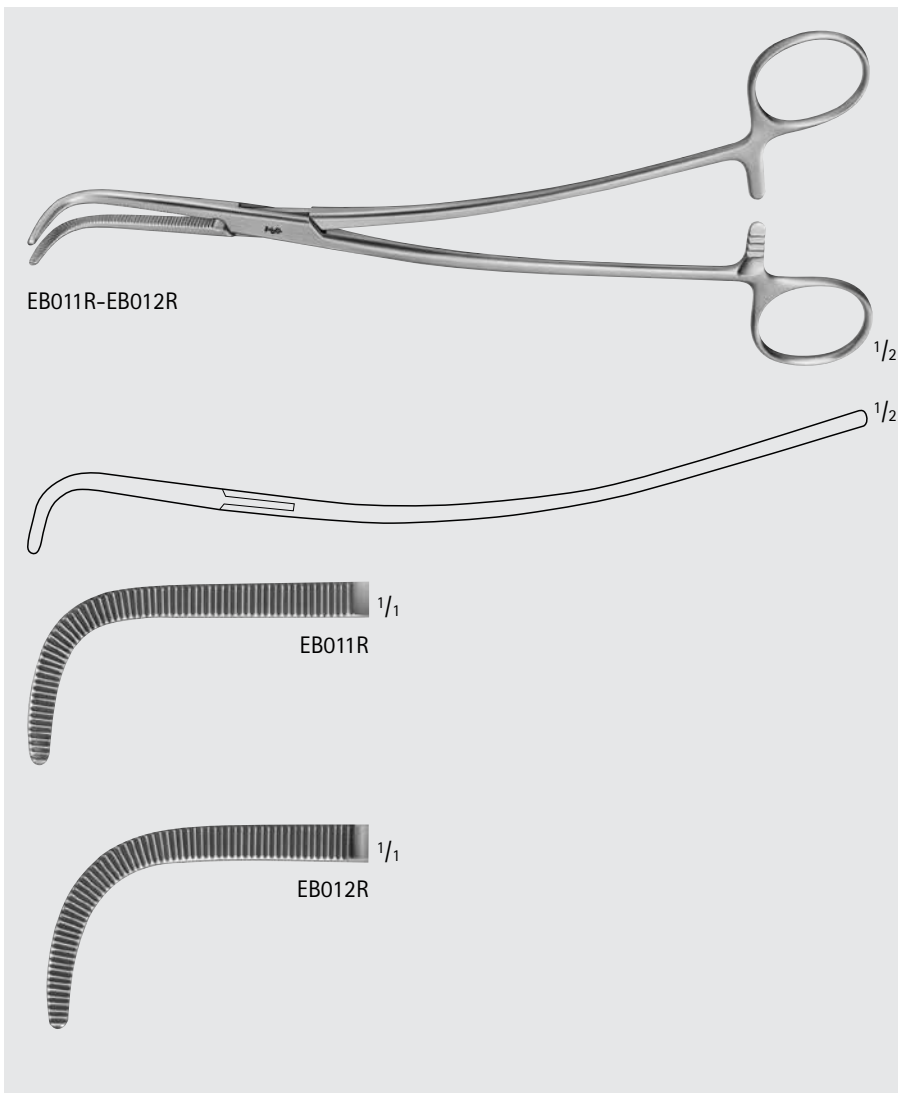

**GRAY Cystic Gall Duct Forceps**

Catalog Number	Jaw	Length (in.)
EB011R	SHORT, CVD	8 3/4
EB012R	LONG, CVD	8 3/4

MIXTER Gall Duct Forceps

Catalog Number	Jaw	Length (in.)
MB120R	HEAVY-CVD	6 1/4

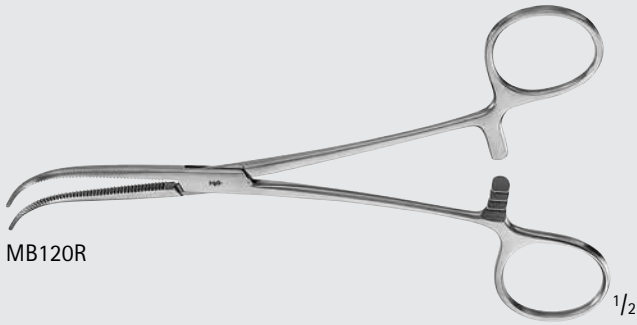

SHALLCROSS Cystic Duct Forceps

Catalog Number	Jaw	Length (in.)
MB126R	CVD	6 7/8
US152	FULL-CVD	8

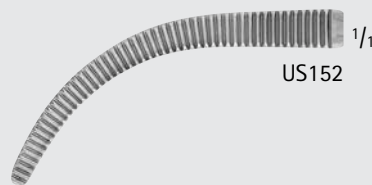
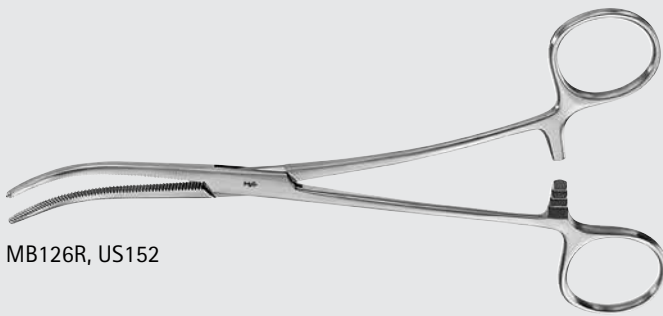

BLAKE Gall Stone Forceps

Catalog Number	Jaw	Length (in.)
EB220R	STR	8
EB221R	CVD	8

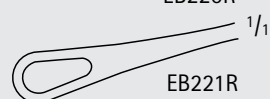
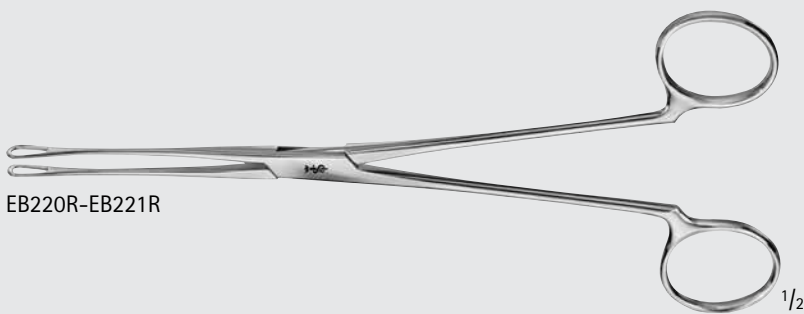

INCHES

# General Surgery

## Abdominal and Intestinal Forceps

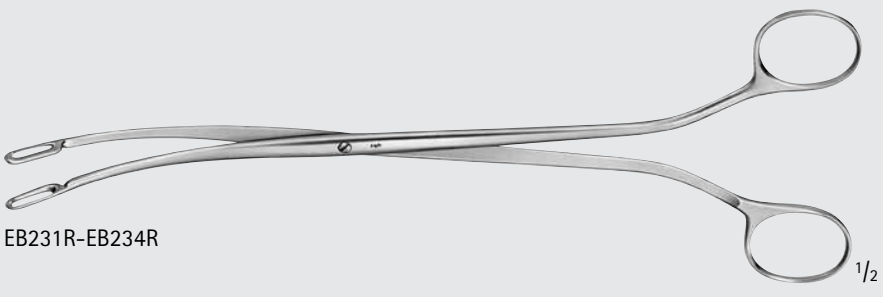

EB231R-EB234R

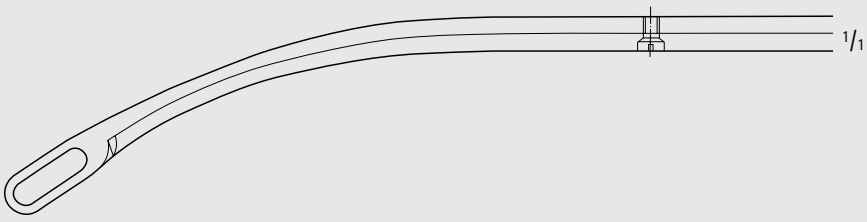

1/1



EB231R

1/1



EB232R

1/1



EB233R

1/1



EB234R

1/1

### DESJARDINS Gall Stone Forceps

Catalog Number	Tip	Length (in.)
EB231R	OVAL	8 7/8
EB232R	OVAL	8 7/8
EB233R	TAPERED	8 7/8
EB234R	TAPERED	8 7/8

**PARKER-KERR Forceps**

Catalog Number	Jaw	Length (in.)
EA365R	SLIGHT-CVD	9 3/4

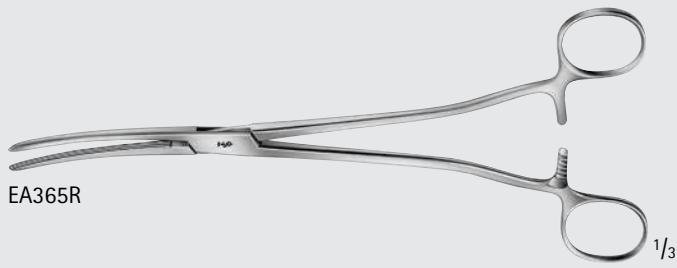

**HEIMING Kidney Stone Forceps**

Catalog Number	Jaw	Length (in.)
EF047R	SLIGHT-CVD	6 3/4
EF048R	HEAVY-CVD	6 1/4



# General Surgery

## Abdominal and Intestinal Forceps

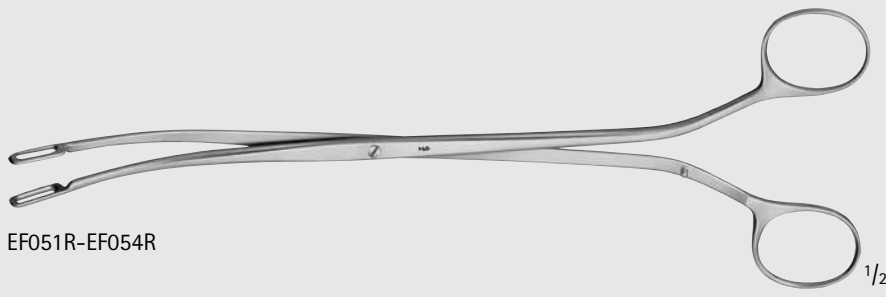

EF051R-EF054R

### RANDALL Kidney Stone Forceps

Catalog Number	Jaw	Length (in.)
EF051R	SLIGHT-CVD	8 7/8
EF052R	CVD	8 7/8
EF053R	HEAVY-CVD	8 7/8
EF054R	U-CVD	8 7/8



EF051R

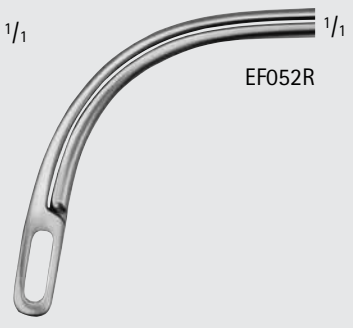

EF052R



EF053R

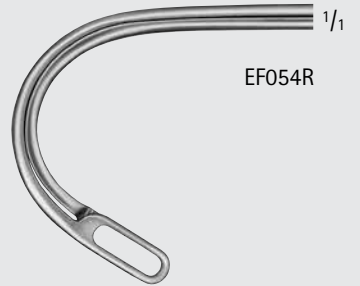

EF054R



1/1

RANDALL Kidney Stone Forceps  
(continued)

Catalog Number	Jaw	Length (in.)
EF055R	CVD	7 1/2
EF056R	HEAVY-CVD	7 1/2
EB244R	90° ANG	9 5/8
EB246R	HEAVY-CVD, DEL	9

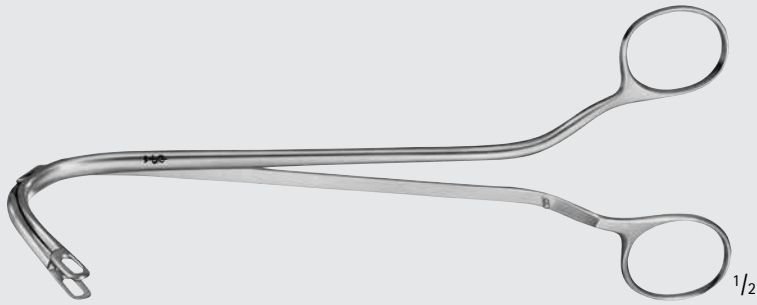

EF055R-EF056R

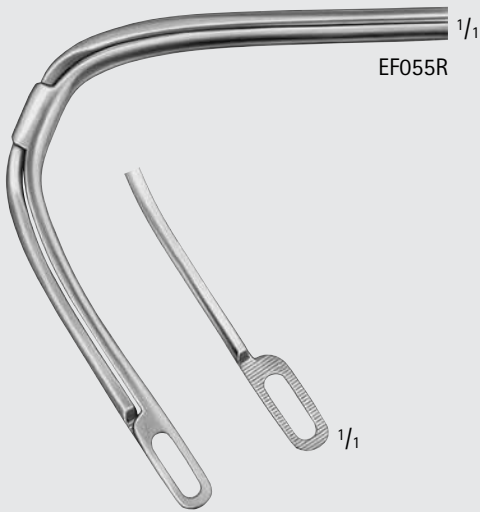

EF055R

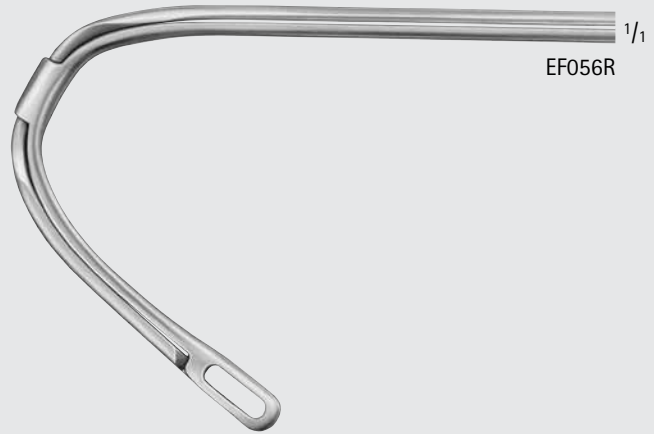

EF056R

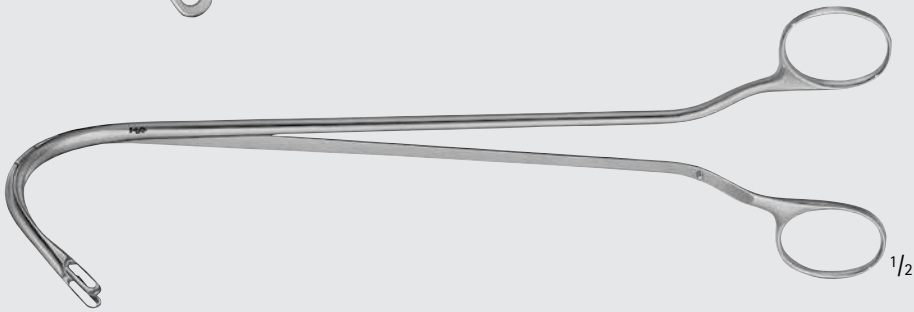

EB244R



EB244R



EB246R



INCHES

# General Surgery

## Atraumatic Intestinal Forceps and Clamps

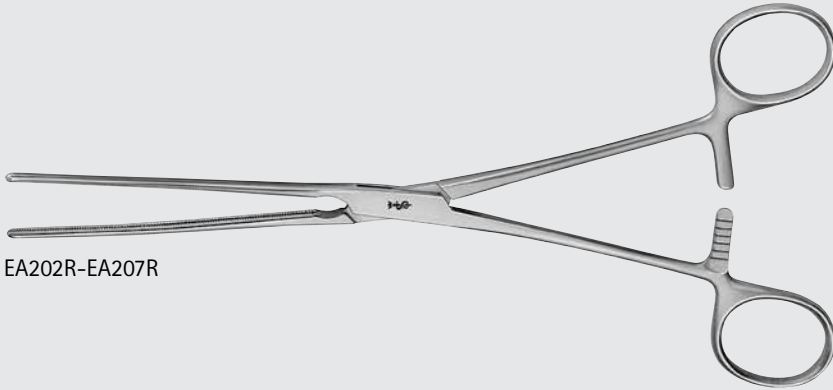

EA202R-EA207R

**KOCHER Atraumatic Forceps,  
Elastic Blades**

Catalog Number	Jaw	Length (in.)
EA202R	STR	8 3/4
EA204R	STR	9 3/4
EA206R	STR	11
EA203R	CVD	8 3/4
EA205R	CVD	9 3/4
EA207R	CVD	11



EA202R



EA204R



EA206R



EA203R



EA205R



EA207R

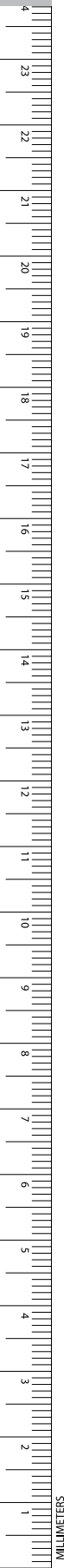

# General Surgery

## Atraumatic Intestinal Forceps and Clamps

### HARTMANN Atraumatic Forceps, Elastic Blades

Catalog Number	Jaw	Length (in.)
EA210R	STR	7 7/8
EA211R	CVD	7 7/8

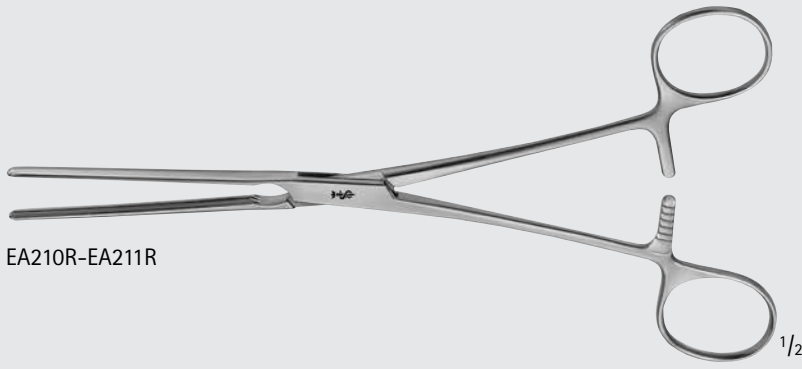

EA210R-EA211R

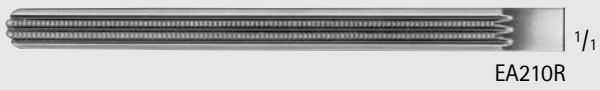

EA210R

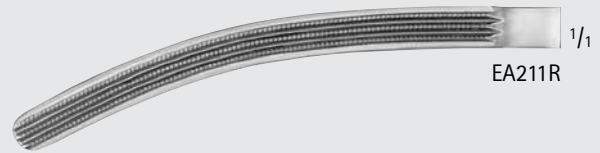

EA211R

### MAYO-ROBSON Atraumatic Forceps

Catalog Number	Jaw	Length (in.)
EA216R	STR	9 3/4
EA217R	CVD	9 3/4

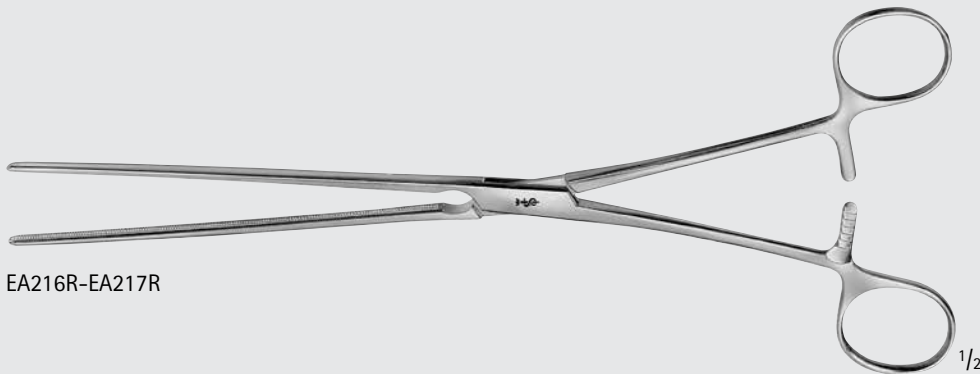

EA216R-EA217R



EA216R

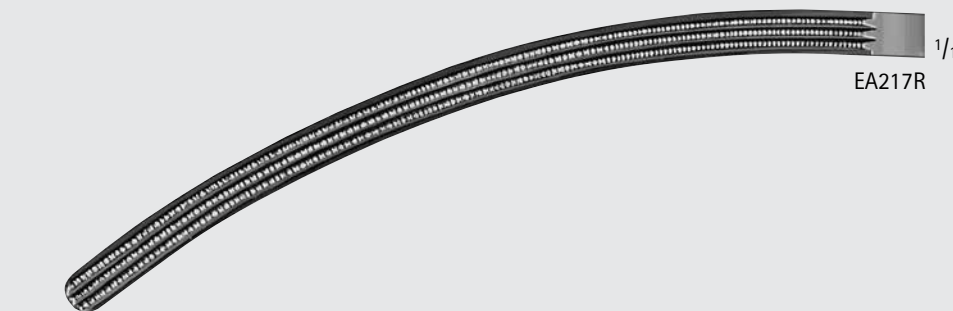

EA217R



INCHES

# General Surgery

## Atraumatic Intestinal Forceps and Clamps

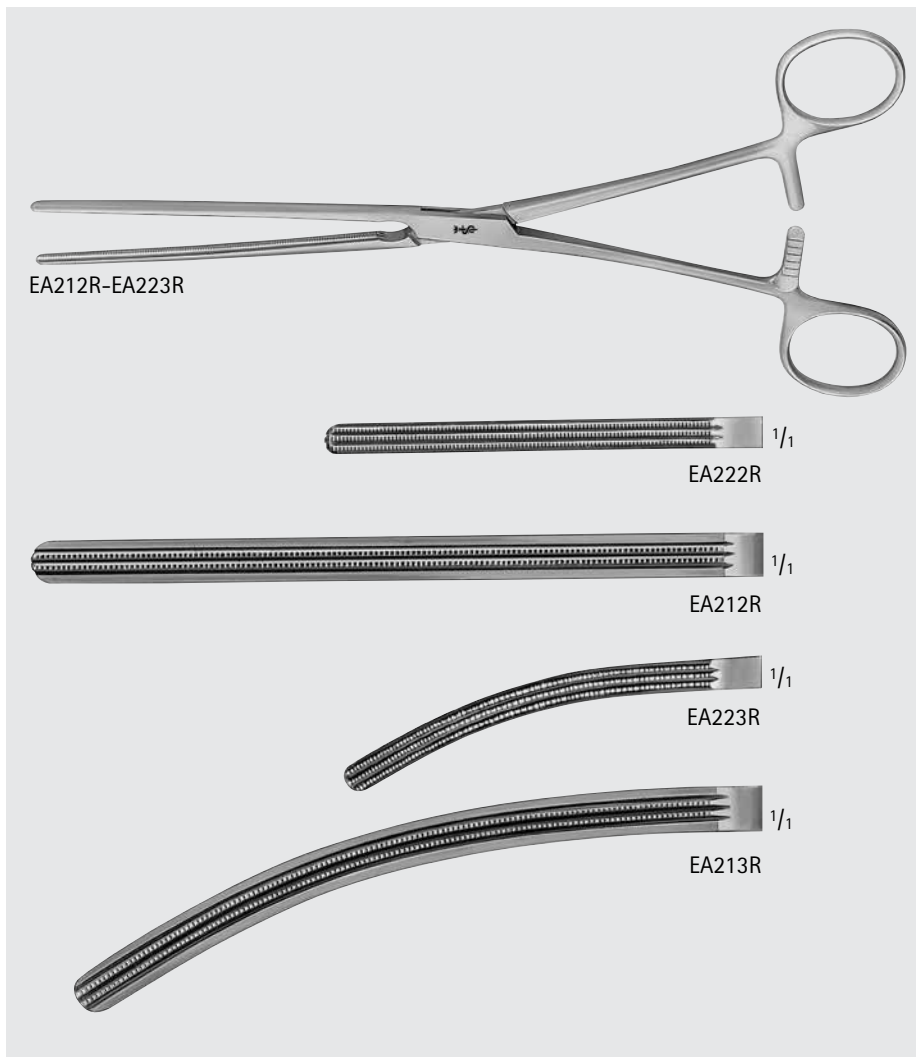

### DOYEN Atraumatic Forceps, Elastic Blades

Catalog Number	Jaw	Length (in.)
EA222R	STR	6 3/4
EA212R	STR	9
EA223R	CVD	6 3/4
EA213R	CVD	9

EA212R-EA223R

EA222R

EA212R

EA223R

EA213R

1/1

1/1

1/1

1/1

### SCUDDER Atraumatic Forceps

Catalog Number	Jaw	Length (in.)
EA240R	STR	13

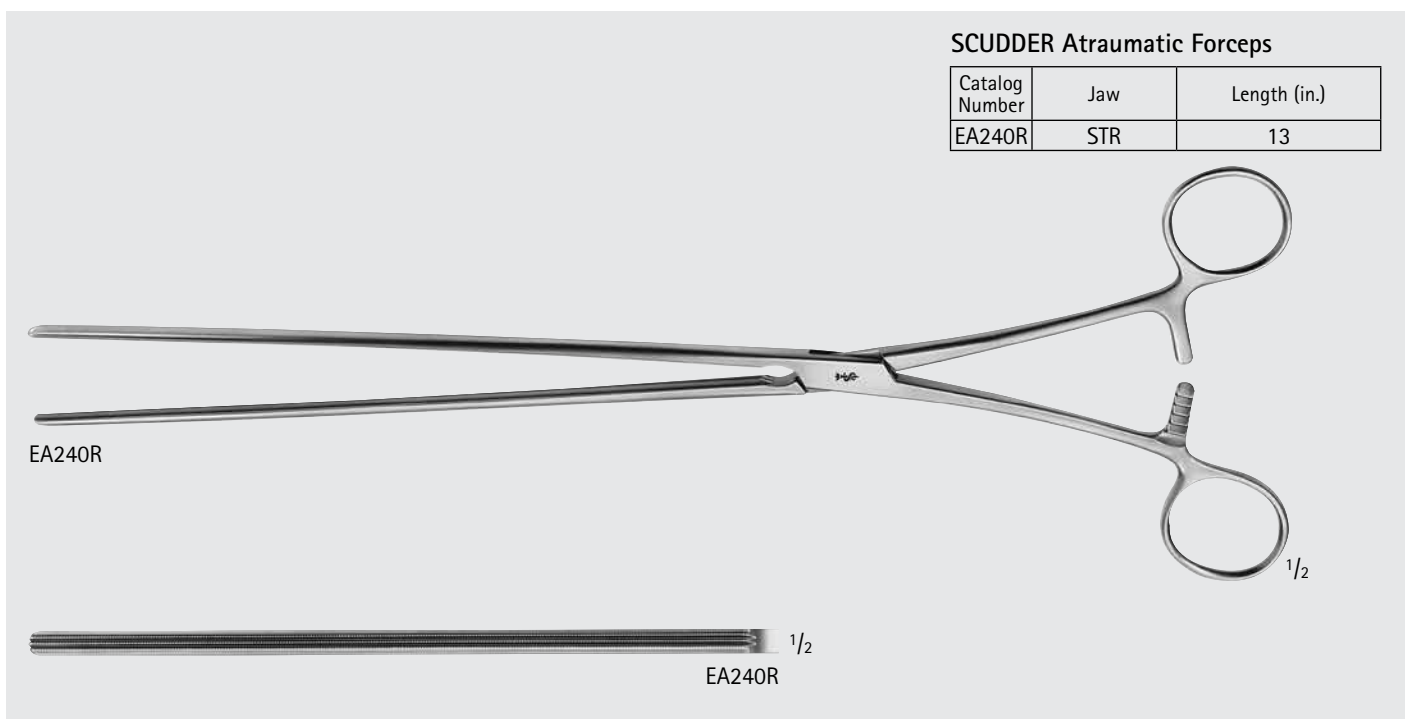

EA240R

EA240R

1/2

1/2

# General Surgery

## Atraumatic Intestinal Forceps and Clamps

GENERAL SURGERY

### GLASSMAN Anterior Resection Clamp

Catalog Number	Jaw	Jaw Length (mm)	Length (in.)
MB931R	90°, SERR	25	9 3/4
MB130R	90°, SERR	50	9 3/4
MB932R	90°, SERR	75	10

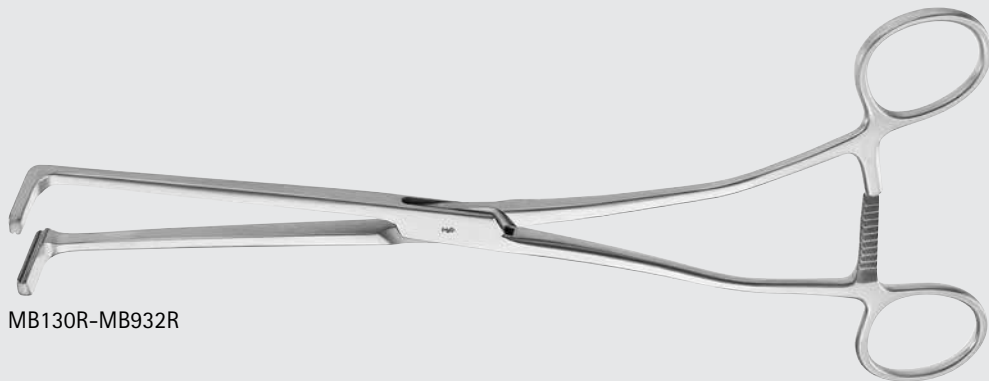

MB130R-MB932R



MB931R

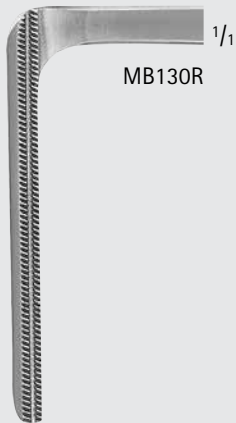

MB130R



MB932R

INCHES

# General Surgery

## Atraumatic Intestinal Forceps and Clamps

CARTER-GLASSMAN Resection Clamp

Catalog Number	Jaw	Jaw Length (mm)	Length (in.)
MG460R	STR	110	11
MG439R	45° ANG	103	10 1/4

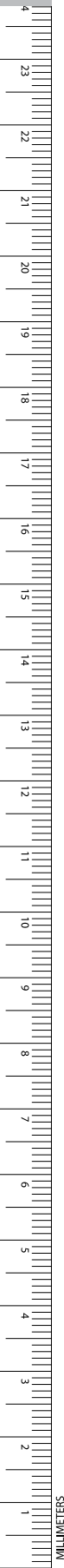
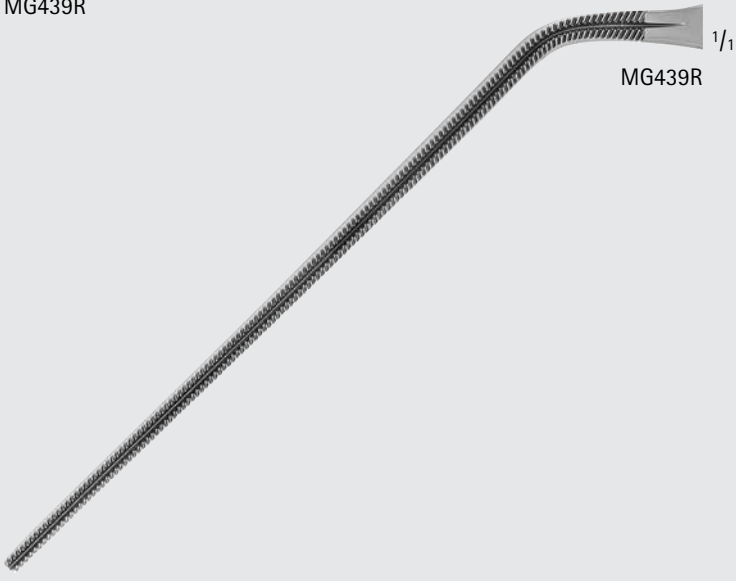
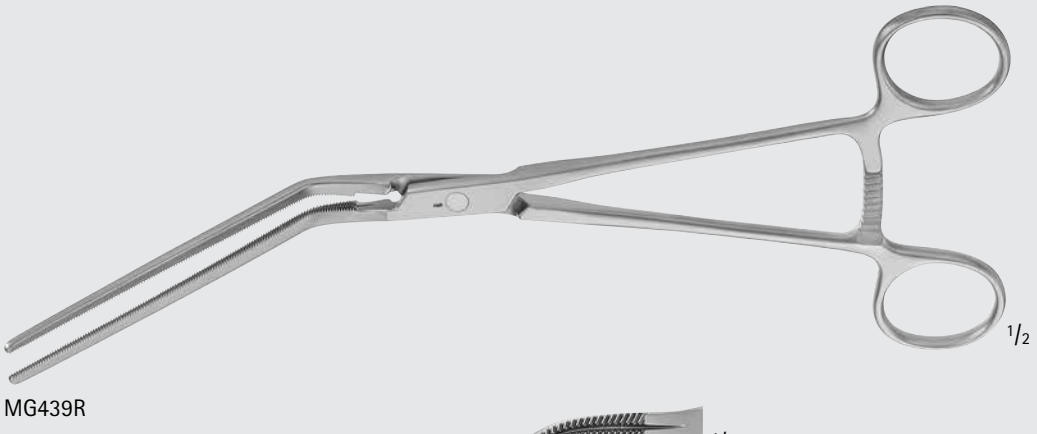

# General Surgery

## Atraumatic Intestinal Forceps and Clamps

### GLASSMAN Intestinal and Liver Holding Clamp, Non-Crushing

Catalog Number	Jaw	Length (in.)
MG436R	STR	9 3/4
MG437R	CVD	9 5/8
MG438R	FULL CVD	9

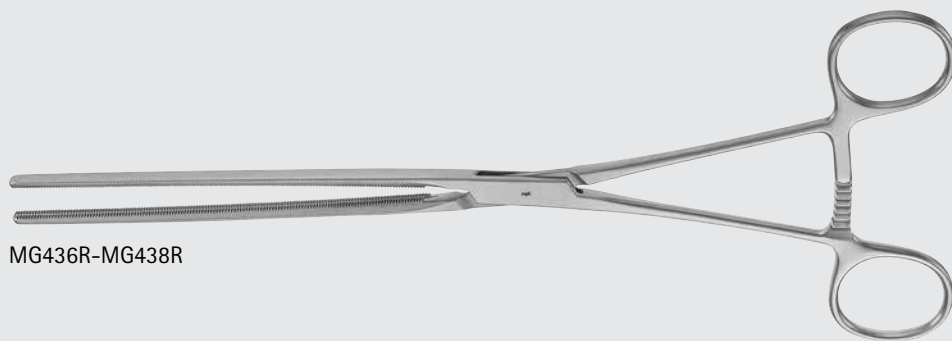

MG436R-MG438R



MG436R



MG437R



MG438R

# General Surgery

## Atraumatic Intestinal Forceps and Clamps

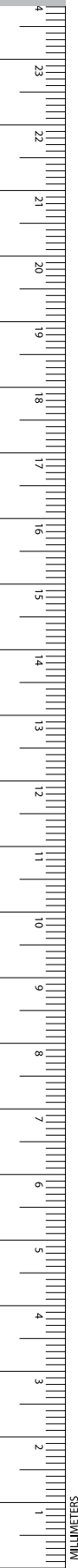

### GLASSMAN Gastroenterostomy Clamp

Catalog Number	Jaw	Jaw Length (mm)	Length (in.)
MG433R	STR	116	11 1/2
MG434R	ANG	115	11 1/2

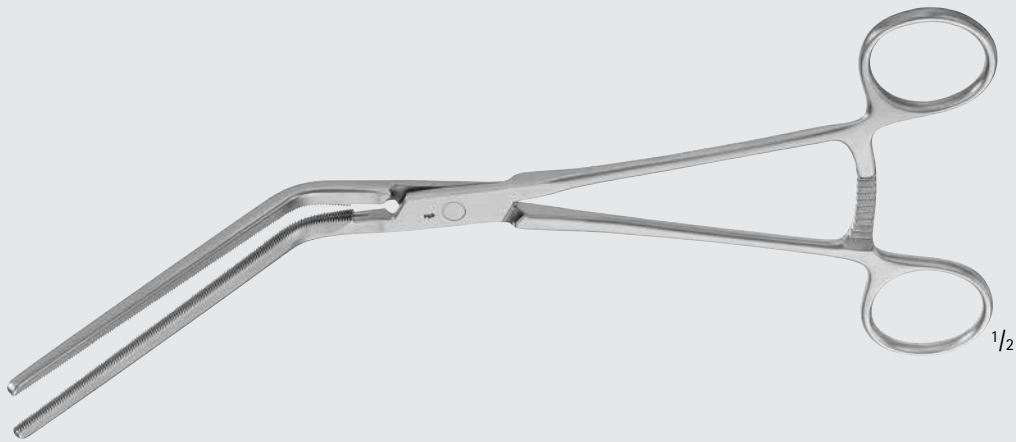

MG433R-MG434R



MG433R

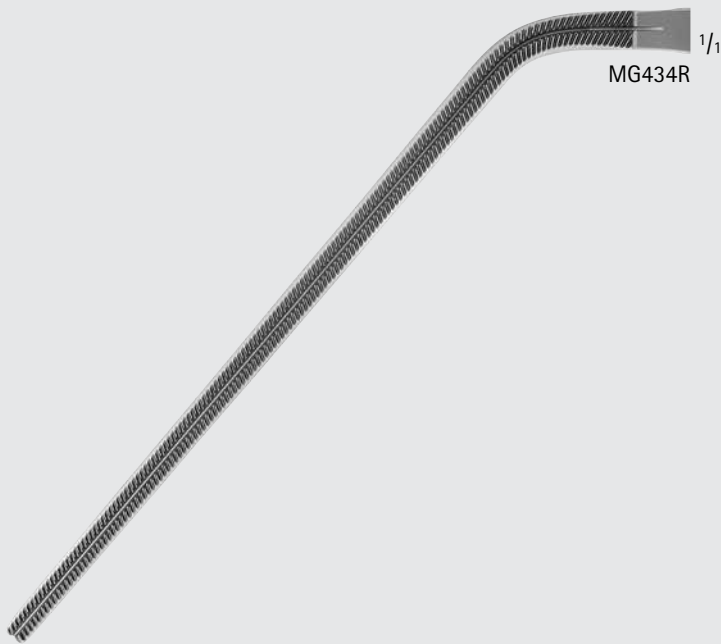

MG434R

**GLASSMAN Gastrointestinal Clamp, Non-Crushing**

Catalog Number	Jaw	Length (in.)
MB138R	STR	9 1/4
MB139R	ANG	9

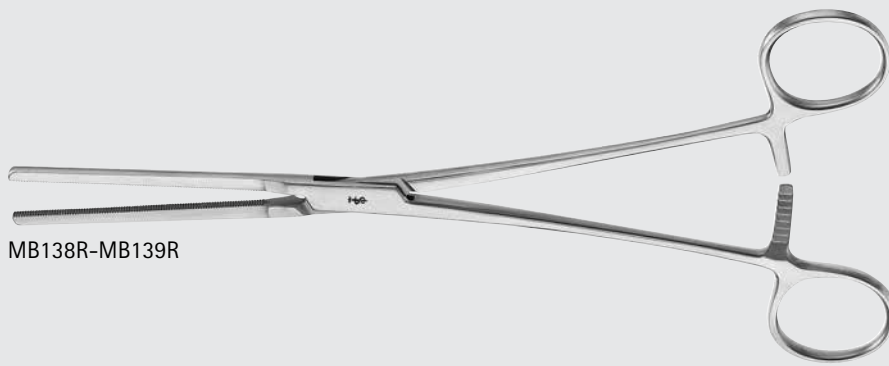

MB138R-MB139R

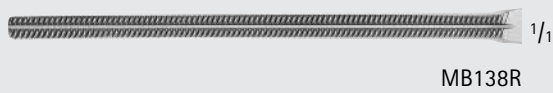

MB138R

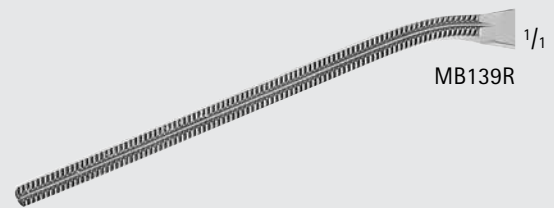

MB139R

**LISTER Sponge Forceps**

Catalog Number	Jaw	Length (in.)
BF004R	STR	5 1/4
BF006R	STR	6 1/4
BF008R	STR	7 1/4

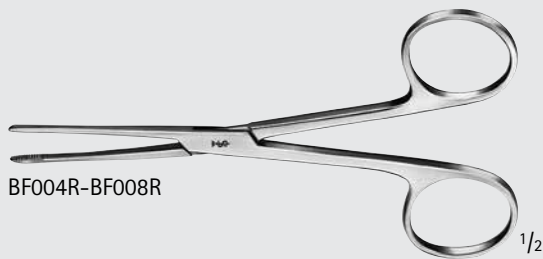

BF004R-BF008R

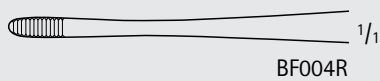

BF004R

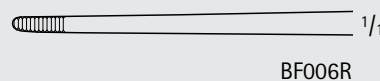

BF006R

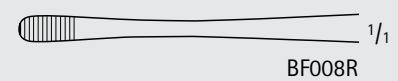

BF008R

**GROSS Forceps, W/ Ratchet**

Catalog Number	Jaw	Length (in.)
BF046R	STR	7 7/8
BF047R	CVD	7 7/8

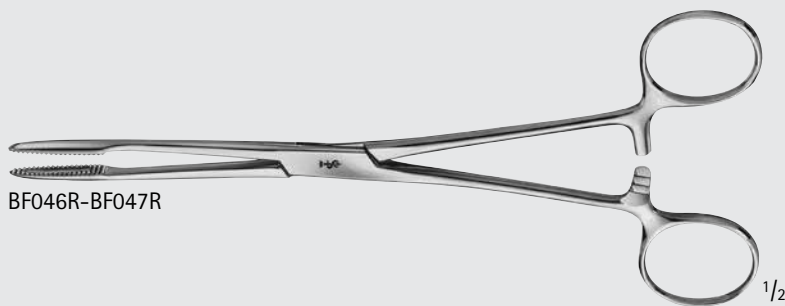

BF046R-BF047R

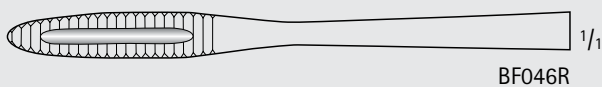

BF046R

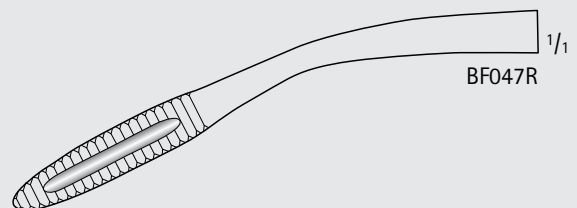

BF047R



INCHES

# General Surgery

## Dressing and Sponge Forceps

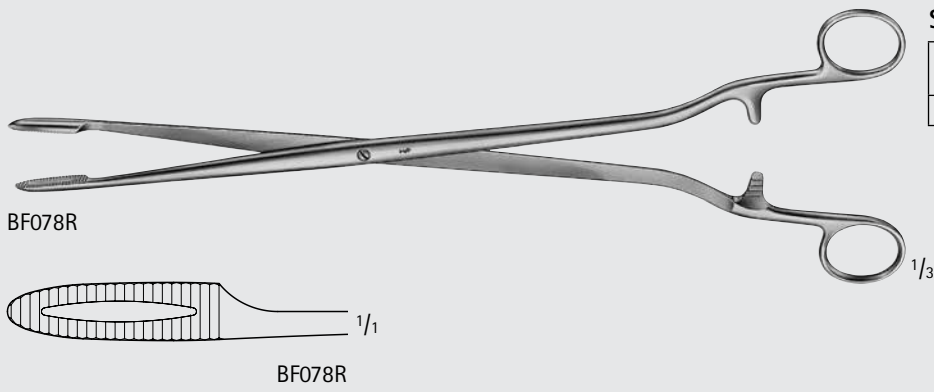

**SIMS-MAIER Sponge Forceps**

Catalog Number	Jaw	Length (in.)
BF078R	STR	13 3/4

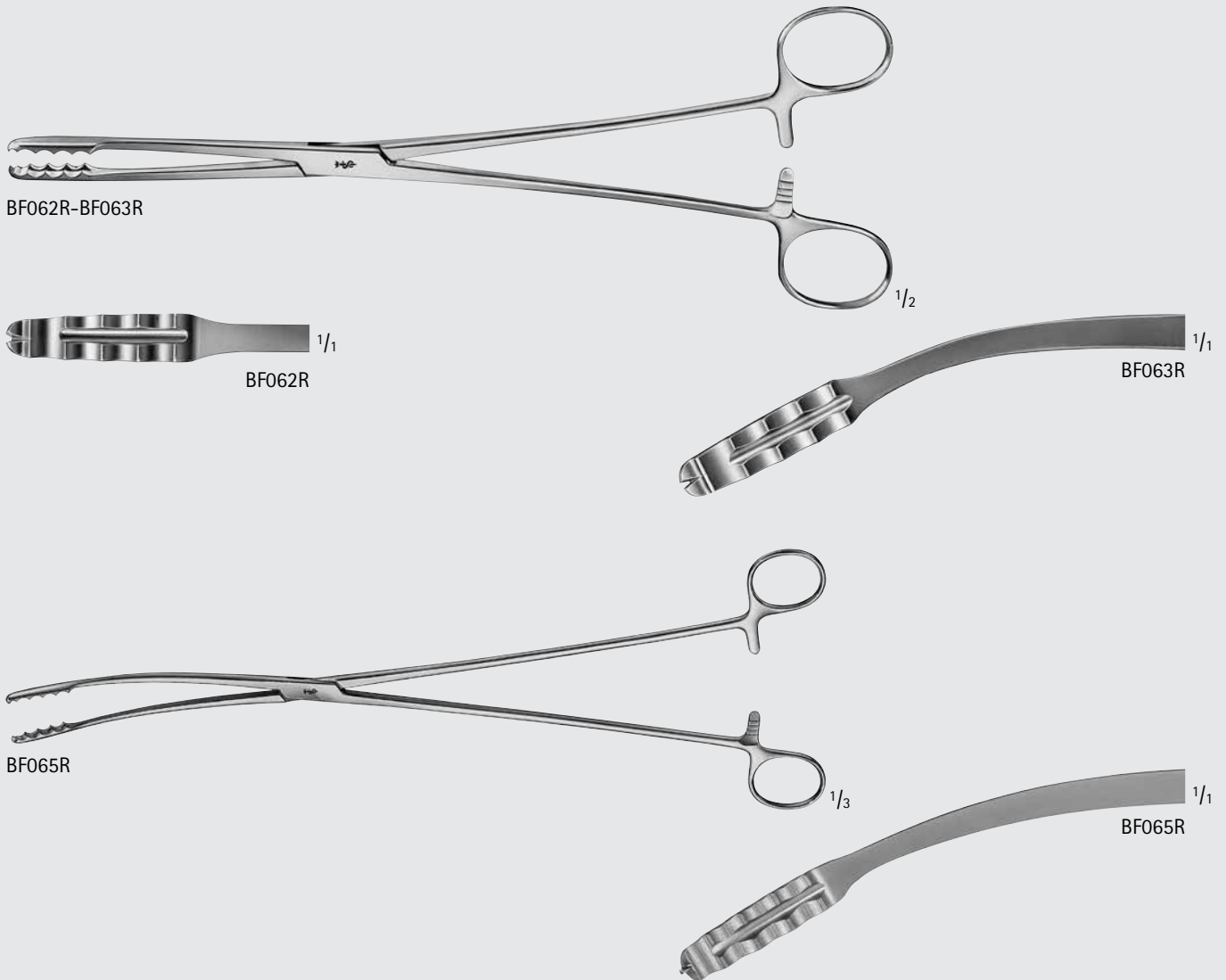

**ULRICH-AESCULAP Sponge Forceps**

Catalog Number	Jaw	Length (in.)
BF062R	STR	10 1/2
BF063R	CVD	10 1/2
BF065R	CVD	13 3/4

# General Surgery

## Dressing and Sponge Forceps

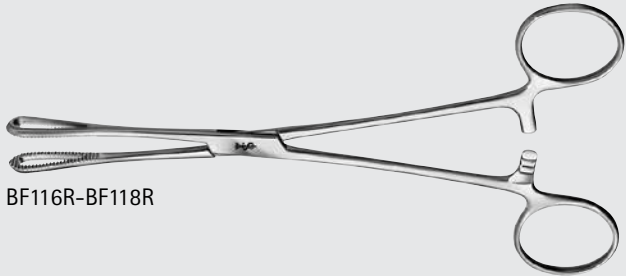

BF116R-BF118R

**RAMPLEY Sponge Forceps**

Catalog Number	Tip	Jaw	Length (in.)
BF116R	SERR	STR	7
BF118R	SERR	STR	9 3/4



BF116R

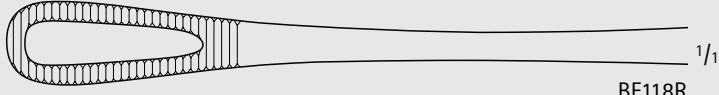

BF118R



INCHES

# General Surgery

## Dressing and Sponge Forceps



### FOERSTER Sponge Forceps

Catalog Number	Tip	Jaw	Length (in.)
MB098R	SERR	STR	12
MB099R	SERR	STR	14
MB904R	SERR	STR	16

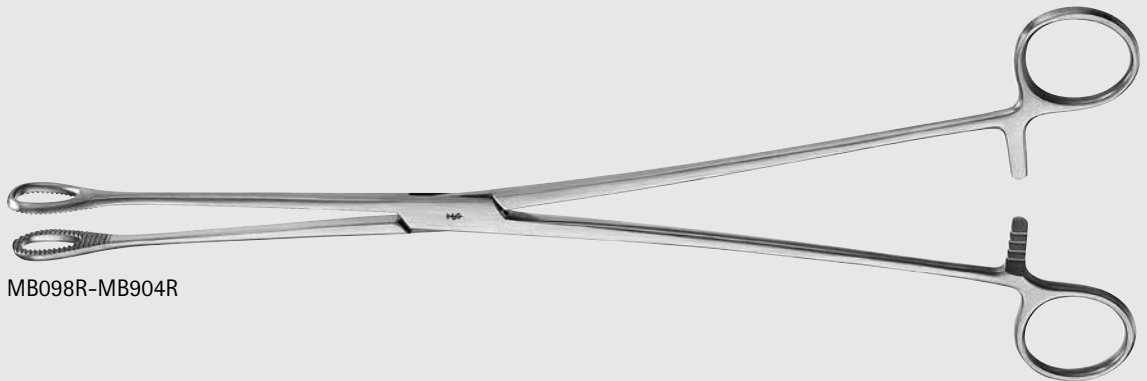

MB098R-MB904R



MB098R



MB099R



MB904R

FOERSTER-BALLENGER Sponge Forceps

Catalog Number	Tip	Jaw	Length (in.)
BF112R	SERR	STR	7
BF120R	SMOOTH	STR	9 5/8
BF122R	SERR	STR	9 5/8
BF113R	SERR	CVD	7
BF121R	SMOOTH	CVD	9 5/8
BF123R	SERR	CVD	9 5/8

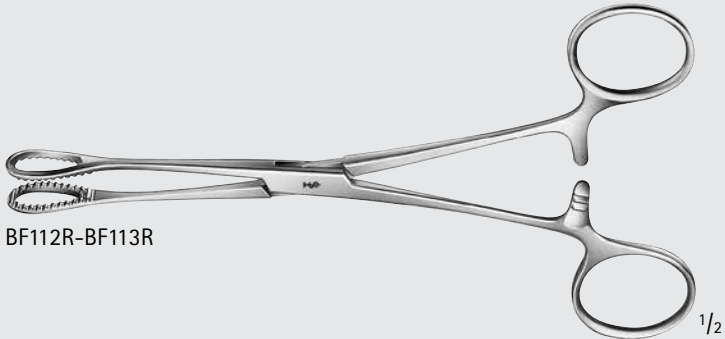

BF112R-BF113R

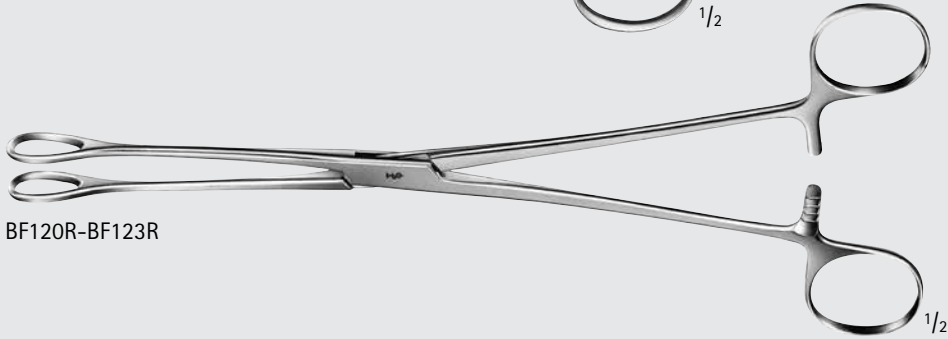

BF120R-BF123R



BF112R

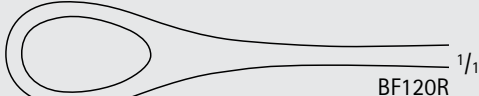

BF120R



BF122R



BF113R



BF121R



BF123R



INCHES

# General Surgery

## Dressing and Sponge Forceps

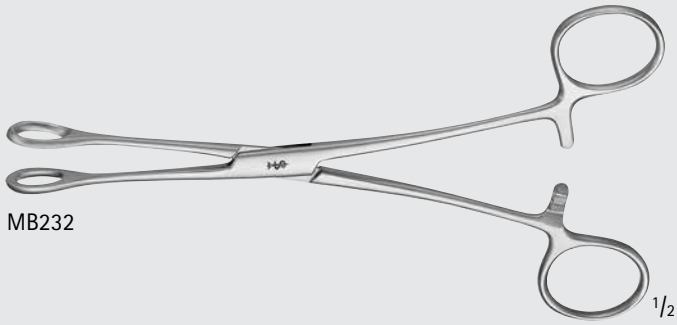

MB232

### BALLENGER Sponge Forceps

Catalog Number	Tip	Jaw	Length (in.)
MB232	SMOOTH	STR	7

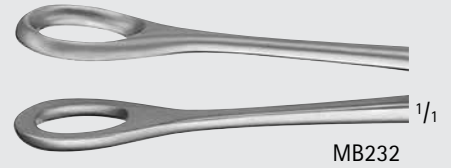

MB232

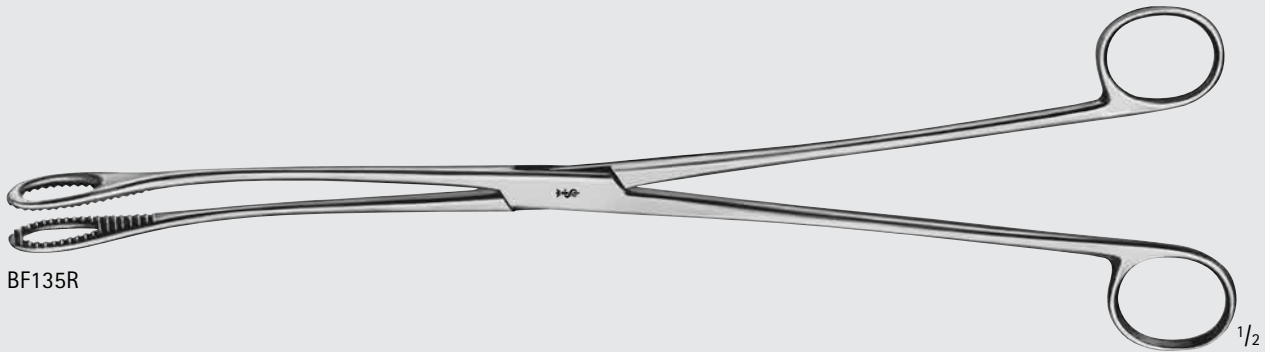

BF135R

### KELLY Sponge Forceps

Catalog Number	Tip	Jaw	Handle	Length (in.)
BF135R	SERR	CVD	W/ OUT RATCHET	12 1/2
BF136R	SERR	CVD	W/ RATCHET	12 1/2

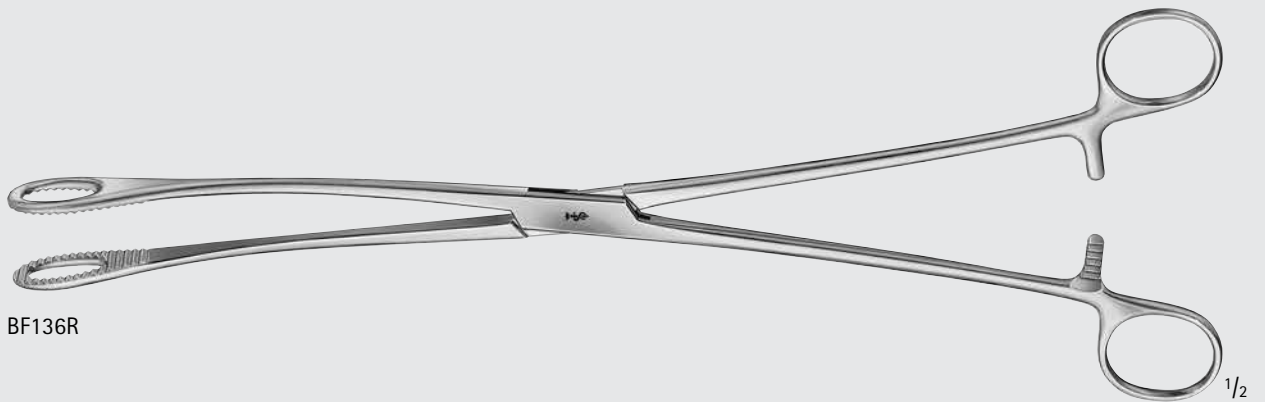

BF136R

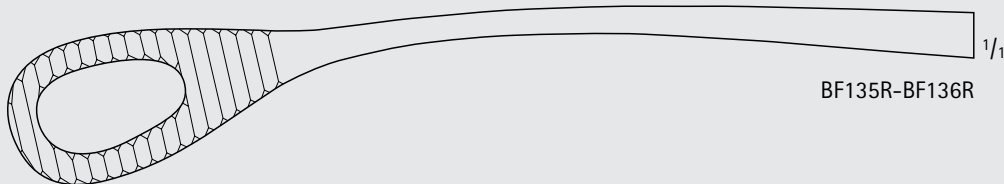

BF135R-BF136R

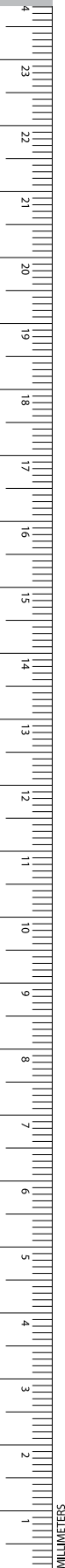

MAGILL Forceps

Catalog Number	Size	Length (in.)
AN379R	INFANT	6
AN380R	PEDIATRIC	7 7/8
AN381R	ADULT	9 3/4

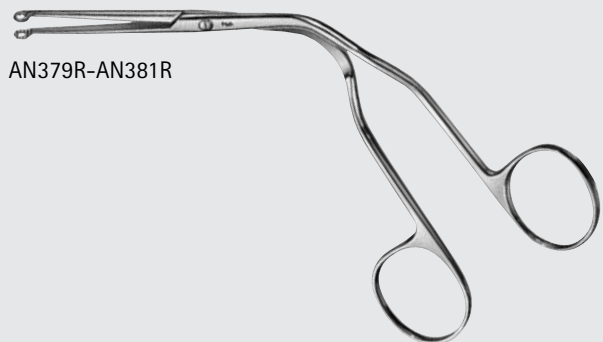

AN379R-AN381R



AN379R



AN380R



AN381R

COLLIN Forceps W/ Ratchet

Catalog Number	Jaw	Length (in.)
BH906R	OVAL	6 1/4
BH908R	TEARDROP	6 1/4

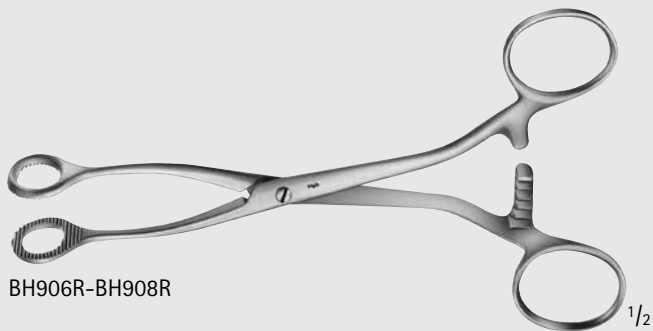

BH906R-BH908R

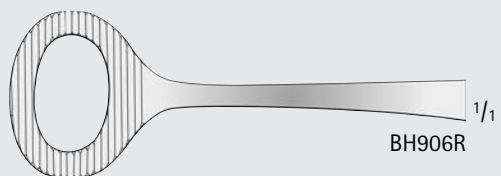

BH906R

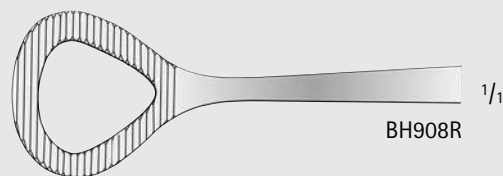

BH908R

# General Surgery

## Tongue Forceps

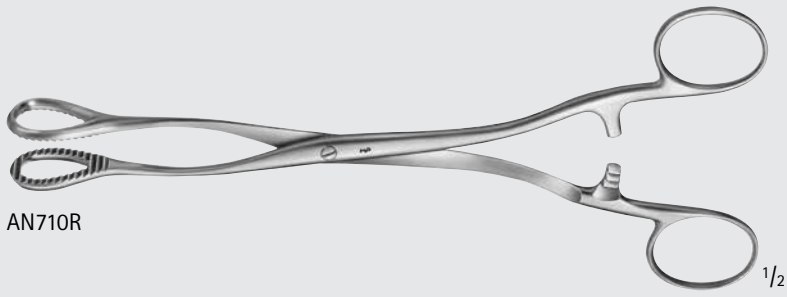

AN710R

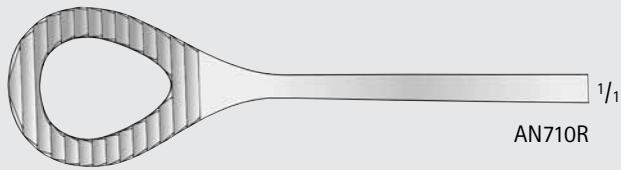

AN710R

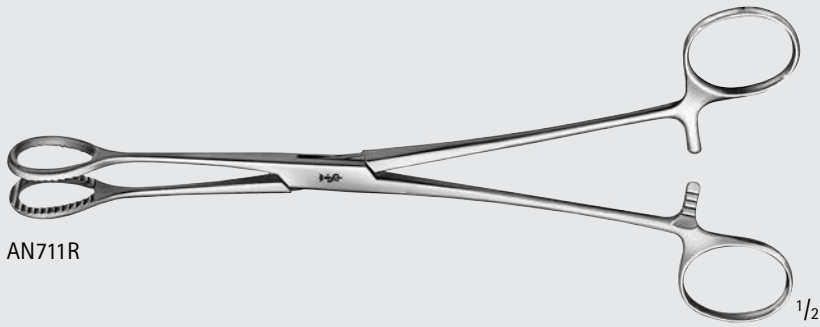

AN711R

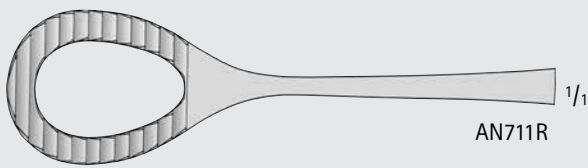

AN711R

### HEYWOOD-SMITH Forceps

Catalog Number	Tip	Length (in.)
AN710R	SERR	7 7/8
AN711R	SERR	8 1/4

YEOMAN Rectal Biopsy Forceps

Catalog Number	Tip Size (mm)	Shaft Length (in.)
EA903R	4	16 1/2

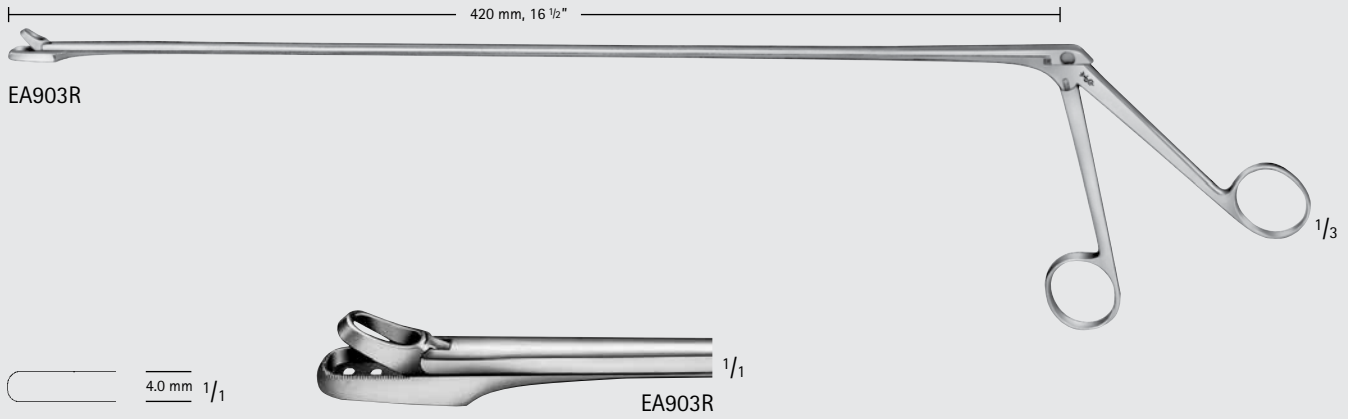

# General Surgery

## Biopsy Forceps



### AESCULAP Rectal Swab Holder

Catalog Number	Shaft Length (in.)
EA943R	15 3/4

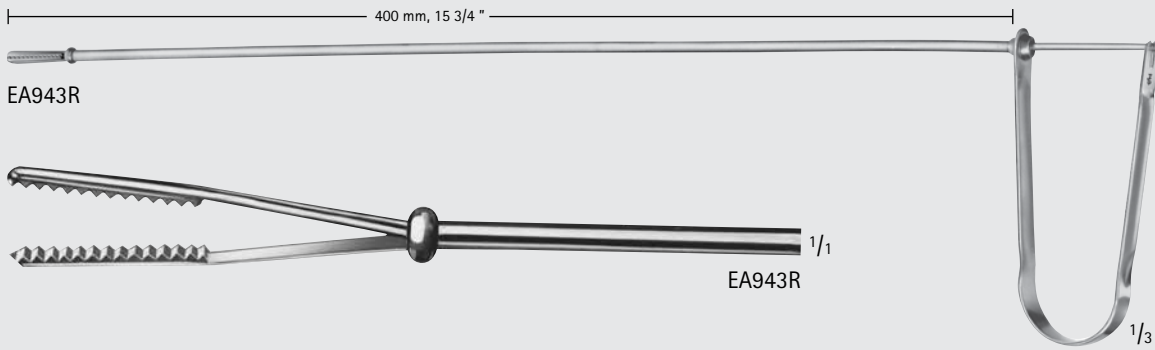

MB200R



MG098R

### PRICE Muscle Biopsy Clamp

Catalog Number	Jaw	Jaw Size (mm)	Length (in.)
MB200R	DOUBLE-PRONG	8	4
MG098R	DOUBLE-PRONG	15	4 3/8

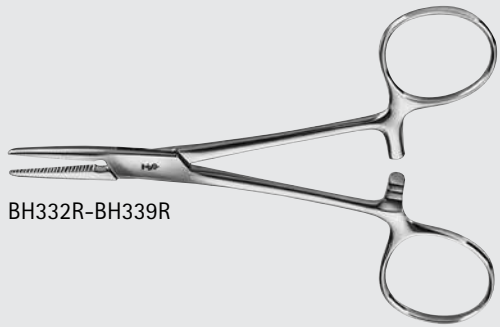

BH332R-BH339R

SPENCER-WELLS Forceps

Catalog Number	Jaw	Length (in.)
BH332R	STR	5 1/8
BH334R	STR	6
BH336R	STR	6 7/8
BH338R	STR	7 7/8
BH333R	CVD	5 1/8
BH335R	CVD	6
BH337R	CVD	6 7/8
BH339R	CVD	7 7/8



BH332R



BH333R



BH334R

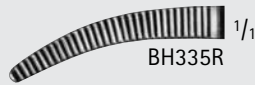

BH335R



BH336R

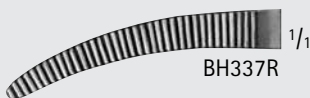

BH337R



BH338R



BH339R

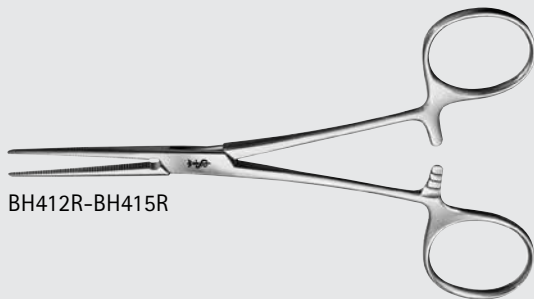

BH412R-BH415R

PEAN Forceps, Delicate

Catalog Number	Jaw	Length (in.)
BH412R	STR	5 1/8
BH414R	STR	5 1/2
BH413R	CVD	5 1/8
BH415R	CVD	5 1/2



BH412R



BH413R



BH414R



BH415R



INCHES

# General Surgery

## Hemostatic Forceps and Clamps

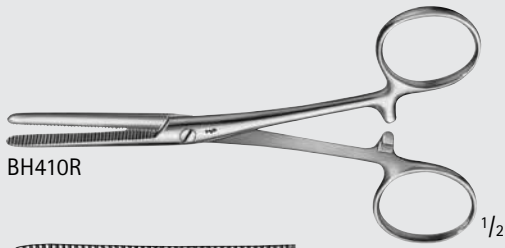

BH410R

1/2



1/1

BH410R

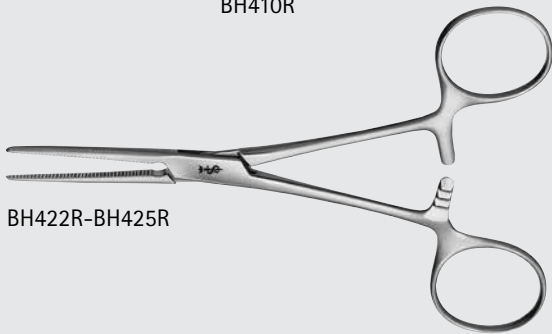

BH422R-BH425R



1/1

BH422R



1/1

BH424R



1/1

BH425R

### PEAN Forceps

Catalog Number	Jaw	Length (in.)
BH410R	STR	5
BH422R	STR	5 1/8
BH424R	STR	5 1/2
BH425R	CVD	5 1/2

### PEAN Artery Forceps

Catalog Number	Jaw	Length (in.)
MB180R	CVD	12
MB181R	CVD	14

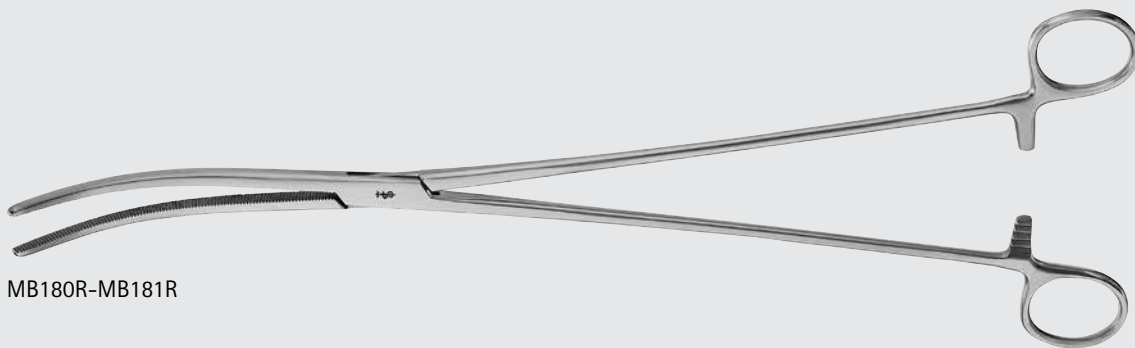

MB180R-MB181R

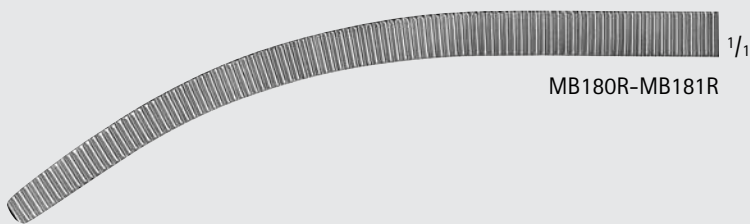

1/1

MB180R-MB181R

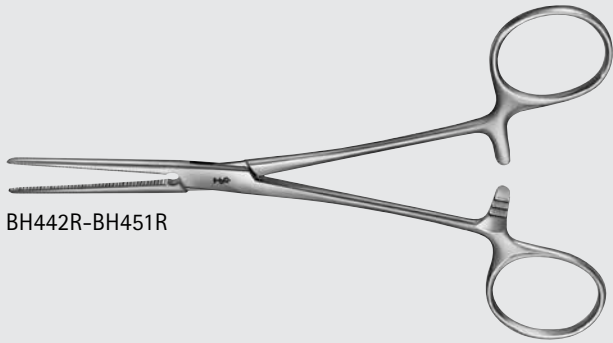

BH442R-BH451R

ROCHESTER-PEAN Forceps

Catalog Number	Jaw	Length (in.)
BH442R	STR	6 1/4
BH444R	STR	7 1/4
BH446R	STR	7 7/8
BH448R	STR	8 7/8
BH450R	STR	9 1/2
BH443R	CVD	6 1/4
BH445R	CVD	7 1/4
BH447R	CVD	7 7/8
BH449R	CVD	8 7/8
BH451R	CVD	9 1/2



BH442R



BH444R



BH446R



BH448R



BH450R



BH443R



BH445R



BH447R



BH449R

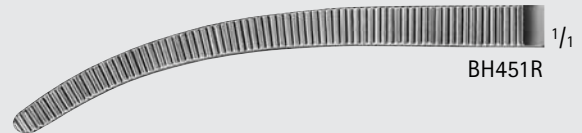

BH451R



INCHES

# General Surgery

## Hemostatic Forceps and Clamps

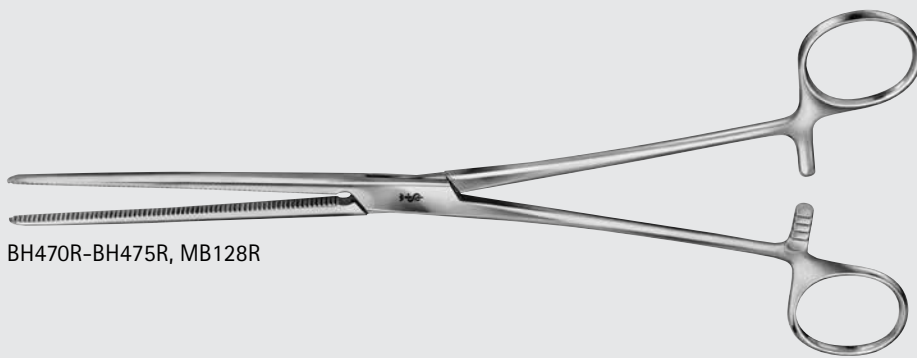

BH470R-BH475R, MB128R

PEAN Forceps, Long

Catalog Number	Jaw	Length (in.)
BH470R	STR	9 1/2
BH472R	STR	10 1/4
BH474R	STR	11
MB128R	STR	12
BH471R	CVD	9 1/2
BH473R	CVD	10 1/4
BH475R	CVD	11



BH470R



BH472R



BH474R



MB128R



BH471R



BH473R

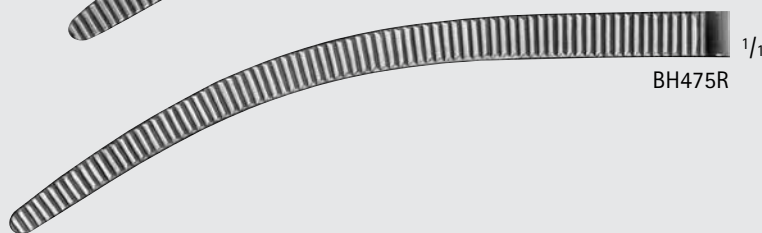

BH475R

KOCHER Forceps, Delicate

Catalog Number	Jaw	Teeth	Length (in.)
BH614R	STR	1 x 2	5 1/2
BH615R	CVD	1 x 2	5 1/2



BH614R-BH615R

1/2



BH614R

1/1



BH615R

1/1

KOCHER Forceps

Catalog Number	Jaw	Teeth	Length (in.)
BH630R	STR	1 x 2	6
BH631R	CVD	1 x 2	6

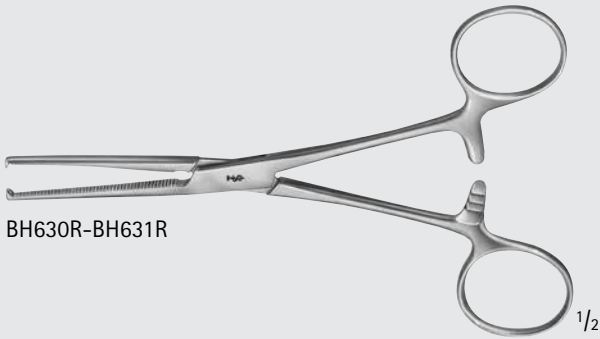

BH630R-BH631R

1/2



BH630R

1/1



BH631R

1/1

# General Surgery

## Hemostatic Forceps and Clamps

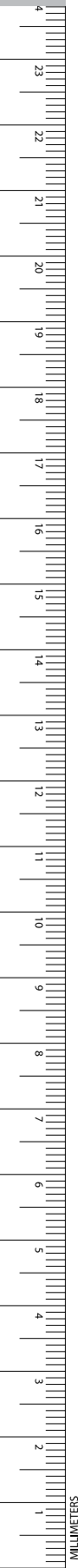

BH618R-BH619R  $\frac{1}{2}$

Catalog Number	Jaw	Teeth	Length (in.)
BH618R	STR	1 x 2	5 1/2
BH619R	CVD	1 x 2	5 1/2

BH618R  $\frac{1}{1}$

BH619R  $\frac{1}{1}$

MB172R  $\frac{1}{2}$

Catalog Number	Jaw	Teeth	Length (in.)
MB172R	STR	1 x 2	14

MB172R  $\frac{1}{1}$

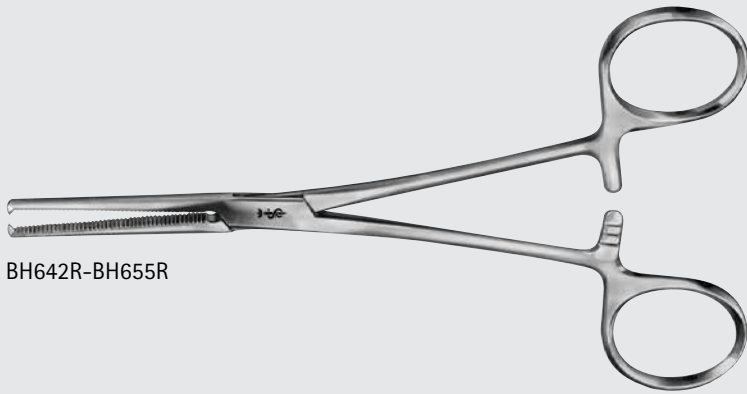

BH642R-BH655R

KOCHER-OCHSNER Forceps

Catalog Number	Jaw	Teeth	Length (in.)
BH642R	STR	1 x 2	6 1/4
BH644R	STR	1 x 2	7 1/4
BH646R	STR	1 x 2	7 7/8
BH648R	STR	1 x 2	8 7/8
BH650R	STR	1 x 2	9 1/2
BH652R	STR	1 x 2	10 1/4
BH654R	STR	1 x 2	11
BH643R	CVD	1 x 2	6 1/4
BH645R	CVD	1 x 2	7 1/4
BH647R	CVD	1 x 2	7 7/8
BH649R	CVD	1 x 2	8 7/8
BH651R	CVD	1 x 2	9 1/2
BH653R	CVD	1 x 2	10 1/4
BH655R	CVD	1 x 2	11



BH642R



BH644R



BH646R



BH648R



BH650R



BH652R



BH654R



BH643R



BH645R



BH647R



BH649R



BH651R



BH653R



BH655R



INCHES

# General Surgery

## Hemostatic Forceps and Clamps

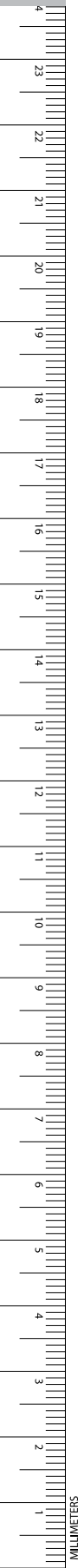

### ROCHESTER-OCHSNER Forceps

Catalog Number	Jaw	Teeth	Length (in.)
MB807R	STR	1 x 2	14
MB909R	STR	1 x 2	16
MB908R	CVD	1 x 2	13 3/4

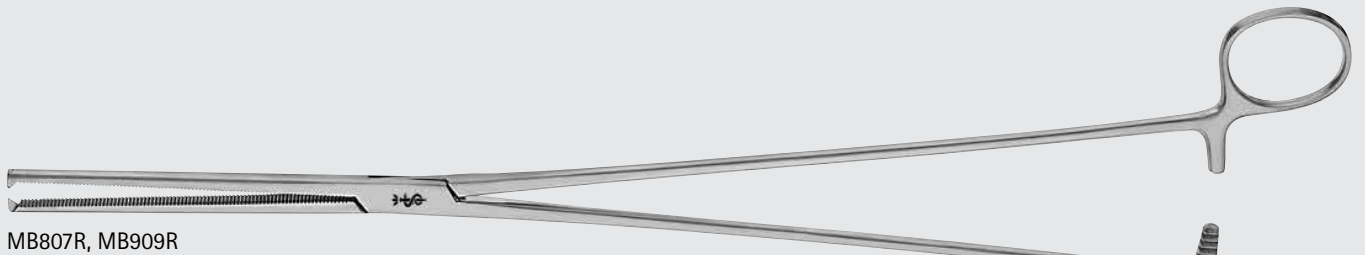

MB807R, MB909R



MB807R

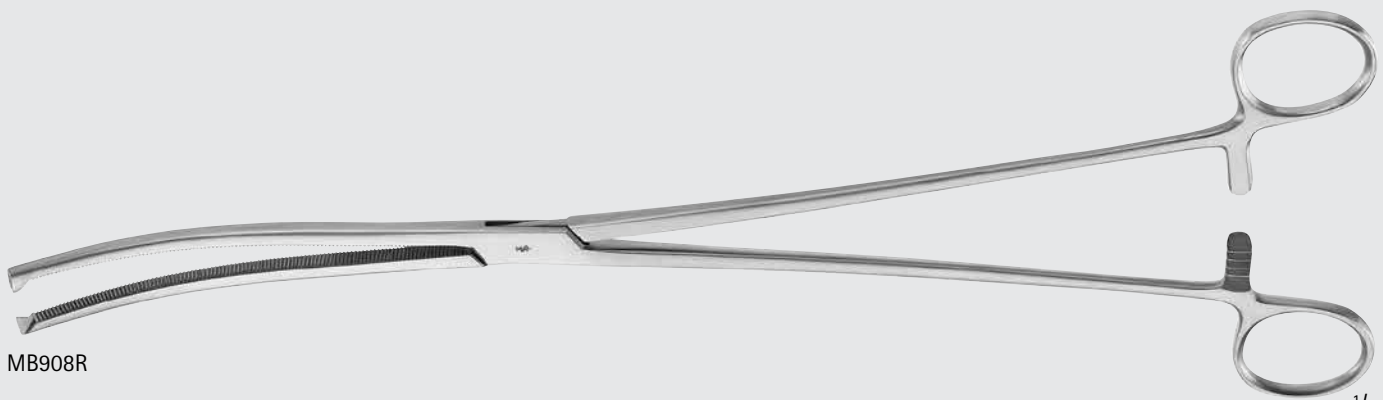

MB908R



MB908R

ROCHESTER-CARMALT Forceps

Catalog Number	Jaw	Length (in.)
BH800R	STR	6 1/4
BH804R	STR	7 7/8
MG196R	STR	9
MG431R	STR	10 1/4
BH801R	CVD	6 1/4
BH805R	CVD	7 7/8
MG197R	CVD	9
MG432R	CVD	10 1/4

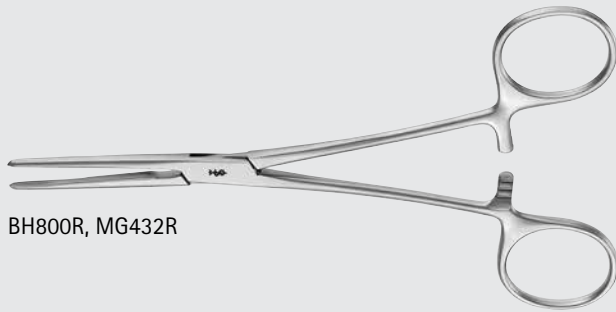

BH800R, MG432R



BH800R



BH804R



MG196R



MG431R



BH801R



BH805R



MG197R



MG432R

STOREY Forceps

Catalog Number	Tip	Length (in.)
MG353R	STRONG-CVD	8 3/4
MG354R	RIGHT-ANG	8 3/4

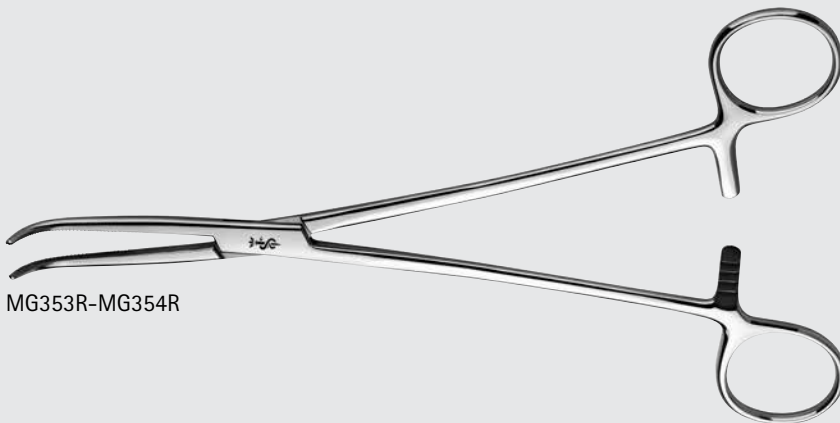

MG353R-MG354R

1/2



MG353R



MG354R



INCHES

# General Surgery

## Hemostatic Forceps and Clamps



The image shows a pair of Jones Hemostatic Forceps (MG426R) with a length of 5 inches. Below the main image is a detailed view of the jaw, labeled MG426R with a 1/1 magnification.

JONES Hemostatic Forceps		
Catalog Number	Jaw	Length (in.)
MG426R	STR	5

The image shows a pair of Moynihan Forceps (BH831R-BH833R) with a length of 9 inches. Below the main image are two detailed views of the jaws: BH831R (CVD) and BH833R (CVD), both with a 1/1 magnification.

MOYNIHAN Forceps		
Catalog Number	Jaw	Length (in.)
BH831R	CVD	9
BH833R	CVD	9 1/2

The image shows a pair of Negus Tonsil Forceps (BH951R-BH952R) with a length of 7 1/2 inches. Below the main image are two detailed views of the jaws: BH951R (HEAVY-CVD) and BH952R (U-CVD), both with a 1/1 magnification.

NEGUS Tonsil Forceps		
Catalog Number	Jaw	Length (in.)
BH951R	HEAVY-CVD	7 1/2
BH952R	U-CVD	7 1/2

**CARMALT Artery Forceps, Longitudinal Serrations**

Catalog Number	Jaw	Length (in.)
MB182R	SLIGHT-CVD	12

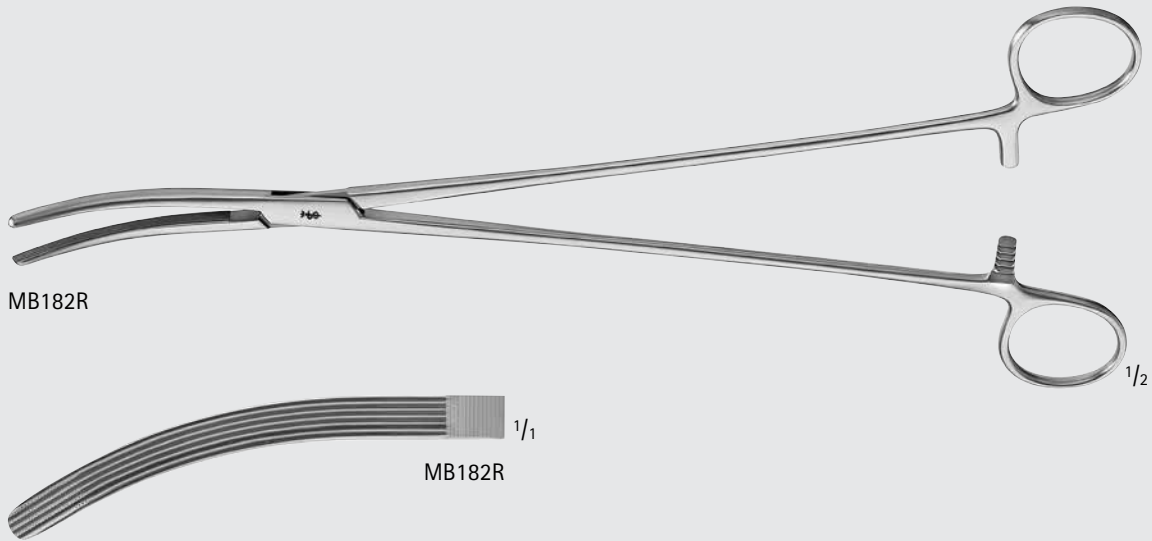

**SCHNIDT Tonsil Clamp**

Catalog Number	Ring Handle	Jaw	Length (in.)
MA172R	OPEN RING	STR	7 1/2
BH961R	OPEN-RING	SLIGHT-CVD	7 1/4
BH963R	OPEN-RING	CVD	7 1/4
BH957R	CLOSED-RING	SLIGHT-CVD	7 1/4
BH959R	CLOSED-RING	CVD	7 1/4

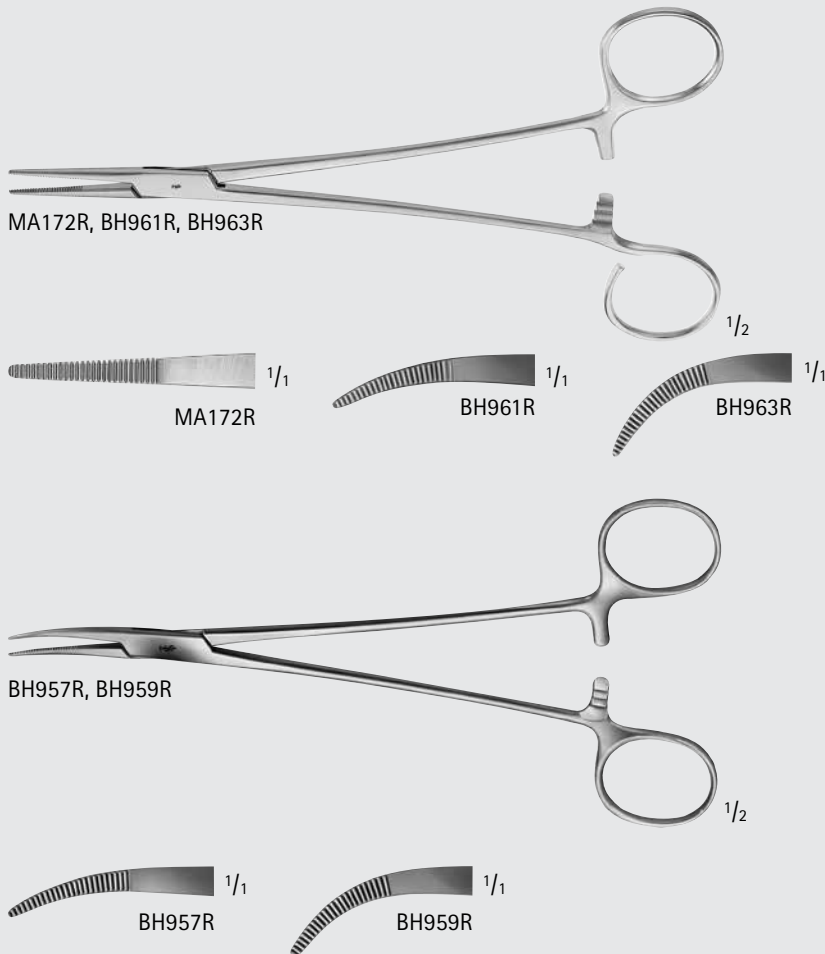

INCHES

# General Surgery

## Hemostatic Forceps and Clamps



**OCHSNER-DIXON Artery Forceps**

Catalog Number	Jaw	Teeth	Length (in.)
MD450	STR	1 x 2	6 1/4

**Baby HARTMANN Mosquito Artery Forceps**

Catalog Number	Jaw	Teeth	Length (in.)
BH104R	STR	-	4
BH114R	STR	1 x 2	4
BH105R	CVD	-	4
BH115R	CVD	1 x 2	4

**Micro HALSTED Mosquito Forceps, Delicate**

Catalog Number	Jaw	Teeth	Length (in.)
BH108R	STR	-	5
BH118R	STR	1 x 2	5
BH109R	CVD	-	5
BH119R	CVD	1 x 2	5

HALSTED Mosquito Forceps, Delicate

Catalog Number	Jaw	Teeth	Length (in.)
BH110R	STR	-	5
BH120R	STR	1 x 2	5
BH210R	STR	-	7 7/8
BH214R	STR	1 x 2	7 7/8
BH111R	CVD	-	5
BH121R	CVD	1 x 2	5
BH211R	CVD	-	7 7/8
BH215R	CVD	1 x 2	7 7/8

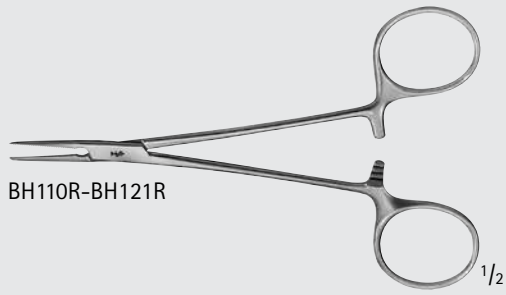

BH110R-BH121R



BH110R



BH111R



BH120R



BH121R

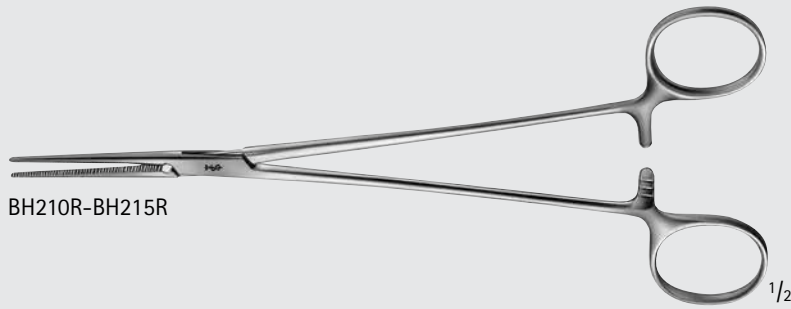

BH210R-BH215R



BH210R



BH211R



BH214R



BH215R

JACOBSON Mosquito Forceps

Catalog Number	Jaw	Length (in.)
BH106R	STR	5 1/8
MB229R	CVD	5

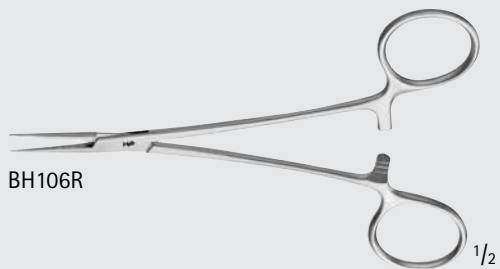

BH106R



BH106R

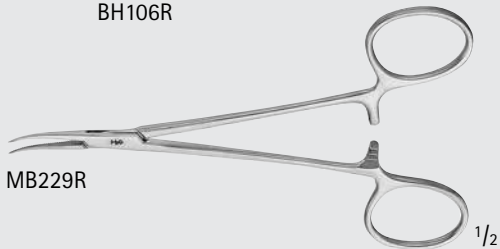

MB229R



MB229R



# General Surgery

## Hemostatic Forceps and Clamps

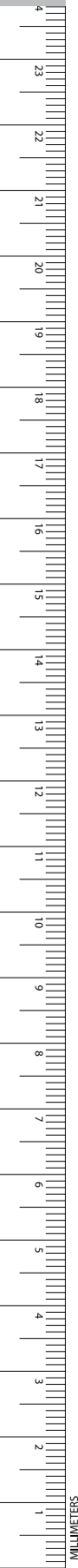

MG085R  $\frac{1}{2}$

MG085R  $\frac{1}{1}$

Catalog Number	Jaw	Length (in.)
MG085R	DEL, CVD.	6

BJ002R  $\frac{1}{2}$

BJ002R  $\frac{1}{1}$

Catalog Number	Tip	Jaw	Length (in.)
BJ002R	SMOOTH	STR	3 $\frac{3}{4}$

BH187R  $\frac{1}{2}$

BH187R  $\frac{1}{1}$

BH189R  $\frac{1}{2}$

BH189R  $\frac{1}{1}$

Catalog Number	Jaw	Length (in.)
BH187R	SLIGHT-CVD	7 $\frac{1}{2}$
BH189R	HEAVY-CVD	7 $\frac{1}{2}$

ADSON Hemostatic Forceps

Catalog Number	Jaw	Length (in.)
BH205R	CVD	8 1/2

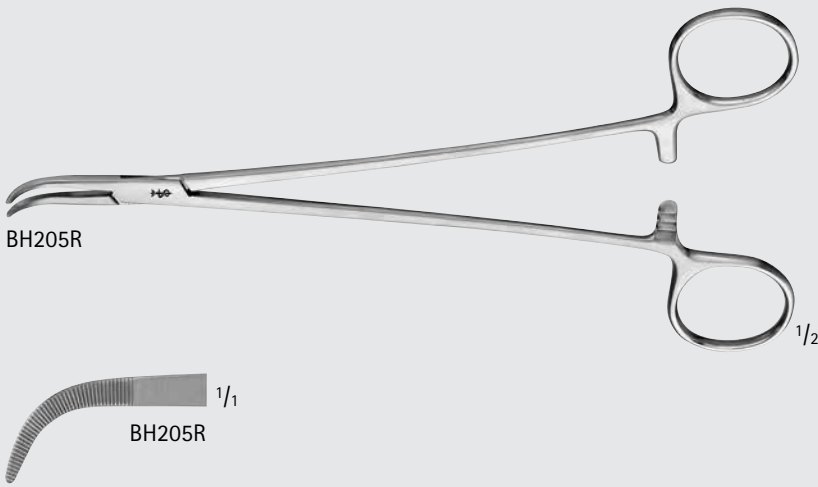

HALSTED Forceps Delicate

Catalog Number	Jaw	Teeth	Length (in.)
BH202R	STR	-	7 1/4
BH212R	STR	1 x 2	7 1/4
BH203R	CVD	-	7 1/4
BH213R	CVD	1 x 2	7 1/4

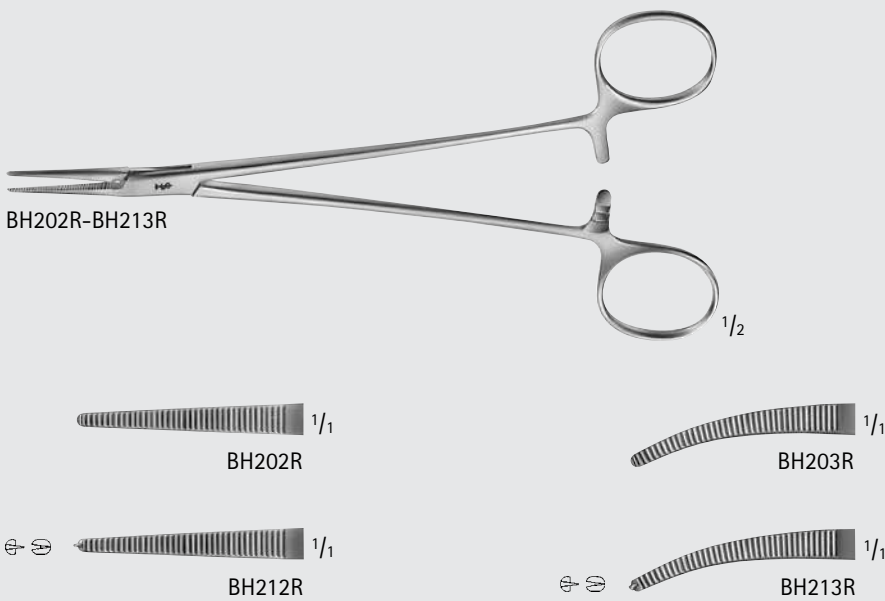

PROVIDENCE Hospital Forceps, Delicate

Catalog Number	Jaw	Length (in.)
BH130R	STR	5 1/2
BH131R	CVD	5 1/2

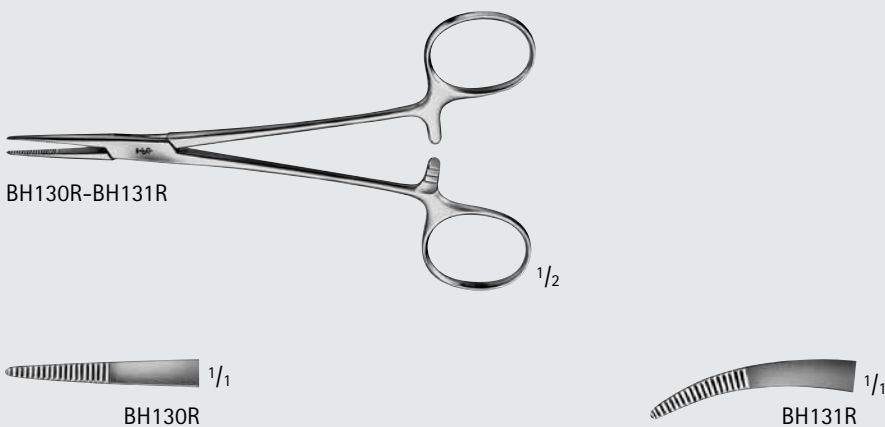

# General Surgery

## Hemostatic Forceps and Clamps

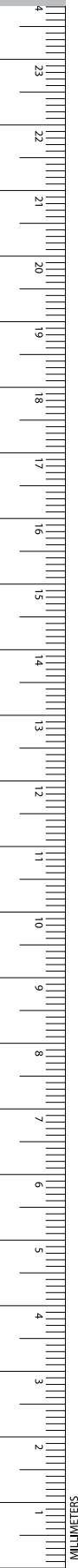

BH134R-BH135R 1/2

BH134R 1/1

BH135R 1/1

### KELLY Forceps

Catalog Number	Jaw	Length (in.)
BH134R	STR	5 1/2
BH135R	CVD	5 1/2

BH140R-BH141R 1/2

BH140R 1/1

BH141R 1/1

BH150R-BH151R 1/2

BH150R 1/1

BH151R 1/1

### Baby CRILE Forceps

Catalog Number	Jaw	Teeth	Length (in.)
BH140R	STR	-	5 1/2
BH150R	STR	1 x 2	5 1/2
BH141R	CVD	-	5 1/2
BH151R	CVD	1 x 2	5 1/2

CRILE Forceps

Catalog Number	Jaw	Teeth	Length (in.)
BH144R	STR	-	5 1/2
BH154R	STR	1 x 2	5 1/2
BH166R	STR	-	6 1/4
BH176R	STR	1 x 2	6 1/4
BH145R	CVD	-	5 1/2
BH155R	CVD	1 x 2	5 1/2
BH167R	CVD	-	6 1/4
BH177R	CVD	1 x 2	6 1/4



BH144R-BH155R

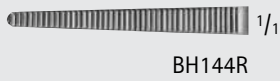

BH144R

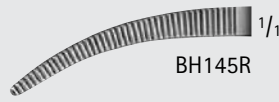

BH145R



BH154R



BH155R

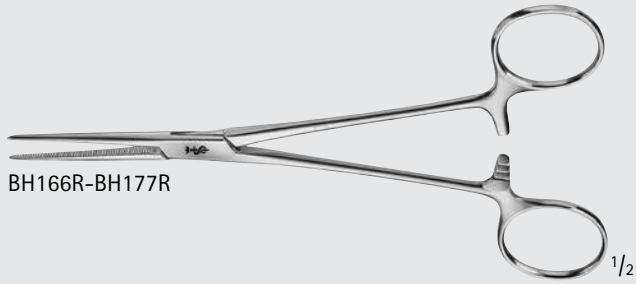

BH166R-BH177R



BH166R

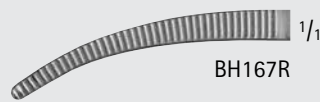

BH167R



BH176R

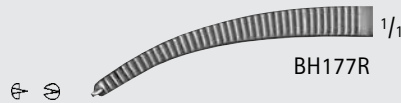

BH177R



# General Surgery

## Hemostatic Forceps and Clamps

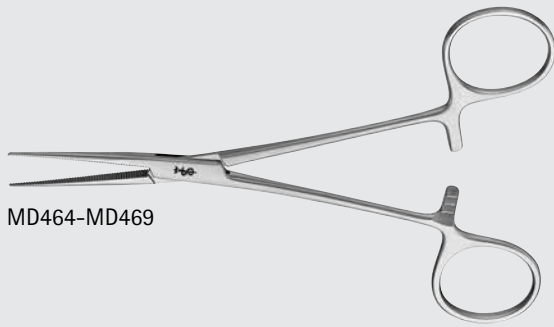

MD464-MD469



MD464



MD466R



MD468



MD465R



MD467R



MD469

### COLLER Artery Forceps

Catalog Number	Jaw	Length (in.)
MD464	STR	5 3/4
MD466R	STR	6 1/2
MD468	STR	7
MD465R	CVD	5 3/4
MD467R	CVD	6 1/2
MD469	CVD	7

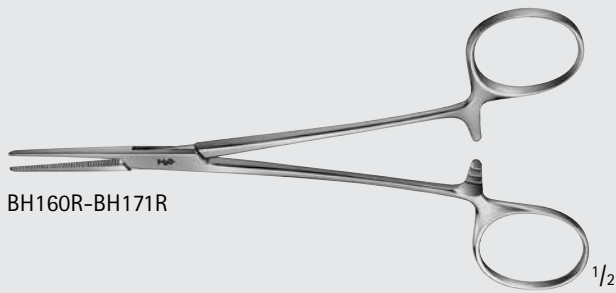

BH160R-BH171R



BH160R



BH170R

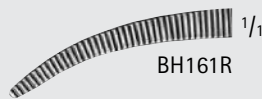

BH161R



BH171R

### LERICHE Forceps, Delicate

Catalog Number	Jaw	Teeth	Length (in.)
BH160R	STR	-	6
BH170R	STR	1 x 2	6
BH161R	CVD	-	6
BH171R	CVD	1 x 2	6

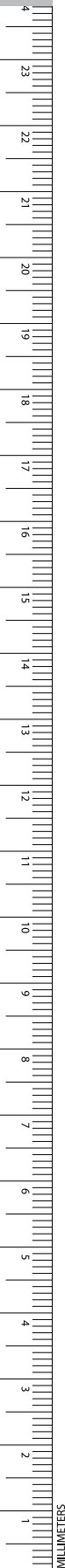

**RANKIN Forceps, Delicate**

Catalog Number	Jaw	Length (in.)
BH164R	STR	6 1/4
BH165R	CVD	6 1/4

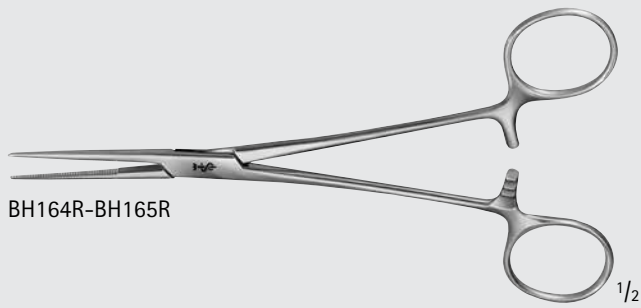

**BIRKETT Hemostatic Forceps**

Catalog Number	Jaw	Length (in.)
BH197R	CVD	7 1/4

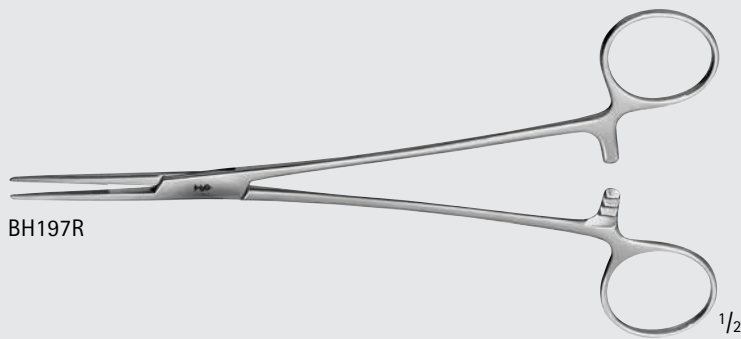

**NISSEN Tonsil Forceps, Delicate**

Catalog Number	Jaw	Length (in.)
BH199R	CVD	7 1/4

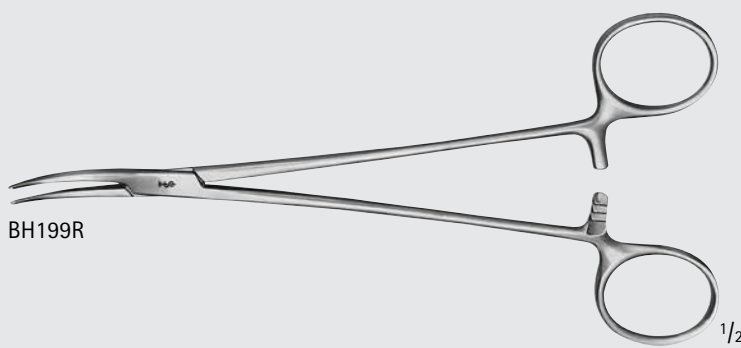

# General Surgery

## Hemostatic Forceps and Clamps



BH200R-BH201R

BH200R 1/1

BH201R 1/1

1/2

**ADSON Tonsil Forceps, Delicate**

Catalog Number	Jaw	Length (in.)
BH200R	STR	7 1/4
BH201R	CVD	7 1/4

BH206R-BH217R

BH206R 1/1

BH207R 1/1

BH216R 1/1

BH217R 1/1

BH209R 1/1

**HEISS Forceps, Delicate**

Catalog Number	Jaw	Teeth	Length (in.)
BH206R	STR	-	7 7/8
BH216R	STR	1 x 2	7 7/8
BH207R	CVD	-	7 7/8
BH217R	CVD	1 x 2	7 7/8
BH209R	HVY-CVD	-	7 3/4

**BENGOLEA Forceps, Delicate**

Catalog Number	Jaw	Length (in.)
BH228R	STR	9 5/8
BH229R	CVD	9 5/8

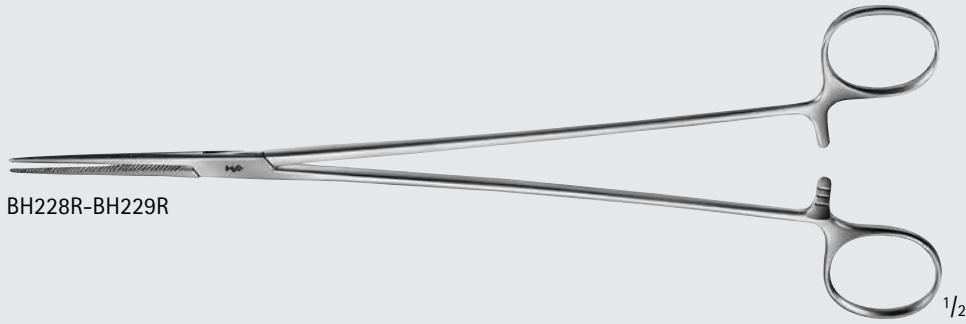

BH228R-BH229R



BH228R



BH229R

**BRIDGE Forceps, Delicate**

Catalog Number	Jaw	Length (in.)
BH230R	STR	10 3/4
BH231R	CVD	10 3/4

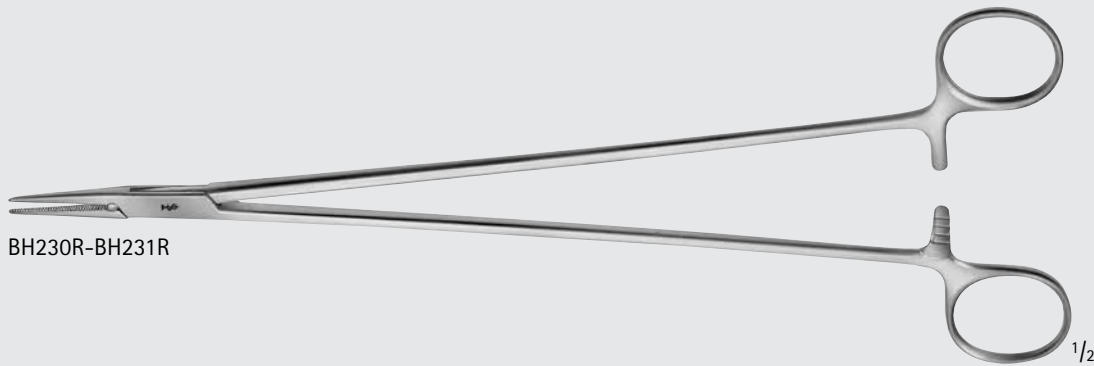

BH230R-BH231R



BH230R



BH231R



INCHES

# General Surgery

## Dissecting and Right Angle Forceps



**GEMINI Right Angle Forceps**

Catalog Number	Length (in.)
BJ100R	5 1/2
BJ102R	7
BJ103R	7 7/8
BJ104R	9
BJ106R	11

BJ100R-BJ106R

**HOLLE Forceps, Delicate**

Catalog Number	Length (in.)
BJ037R	5 3/4
BJ038R	7 1/4
BJ039R	9 1/4

BJ037R-BJ039R

# General Surgery

## Dissecting and Right Angle Forceps

### KANTROWITZ Right Angle Forceps

Catalog Number	Length (in.)
MB058R	6 3/8
BJ057R	7 7/8
BJ058R	9 5/8
BJ059R	10 3/4
MB061R	12

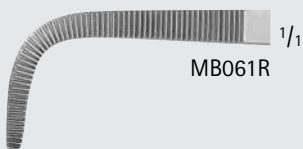
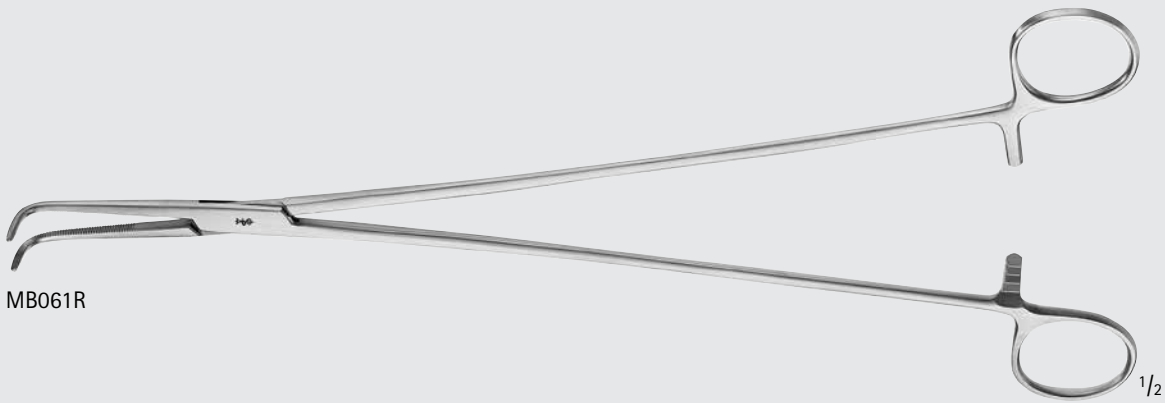
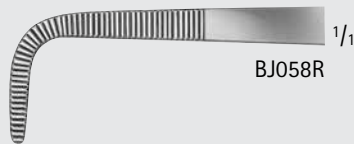
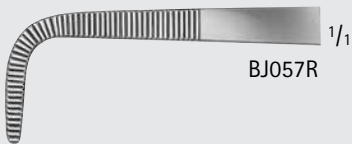
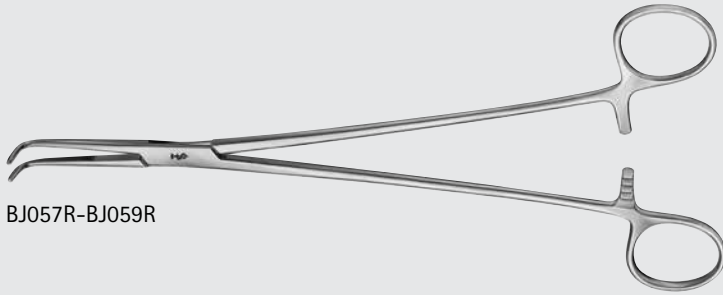
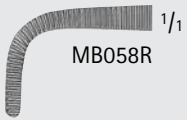
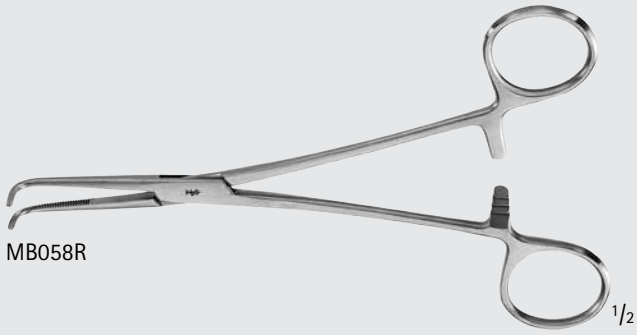

# General Surgery

## Dissecting and Right Angle Forceps



BJ013R-BJ014R

BJ013R  $\frac{1}{1}$

BJ014R  $\frac{1}{1}$

**Baby ADSON Forceps**

Catalog Number	Length (in.)
BJ013R	5 1/2
BJ014R	7

BJ008R

BJ008R  $\frac{1}{1}$

**Micro ADSON Suture Forceps**

Catalog Number	Length (in.)
BJ008R	5 1/2

MD569-MD570R

MD569  $\frac{1}{1}$

MD570R  $\frac{1}{1}$

**MIXTER (MEEKER) Right Angle Forceps**

Catalog Number	Length (in.)
MD569	5 1/2
MD570R	7

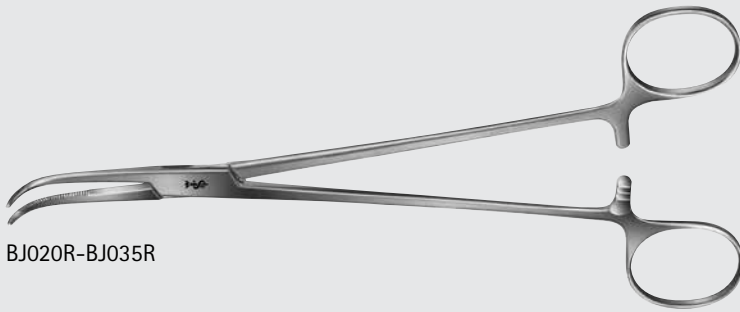

BJ020R-BJ035R

OVERHOLT-GEISSENDOERFER Forceps

Catalog Number	Jaw Curve (#)	Length (in.)
BJ020R	0	7 3/4
BJ021R	1	8
BJ022R	2	8 3/4
BJ023R	3	8 7/8
BJ024R	4	8 3/4
BJ025R	5	9
BJ026R	6	8 7/8
BJ031R	1	10 1/4
BJ032R	2	10 5/8
BJ033R	3	10 3/4
BJ034R	4	10 5/8
BJ035R	5	11

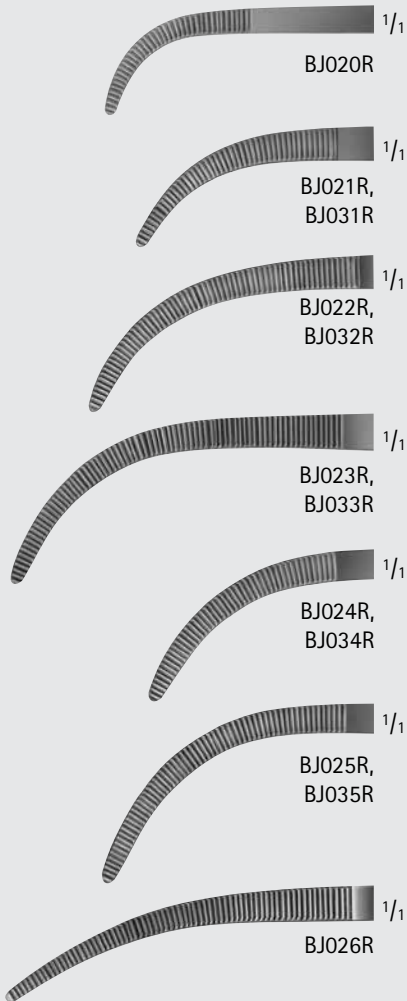

# General Surgery

## Dissecting and Right Angle Forceps

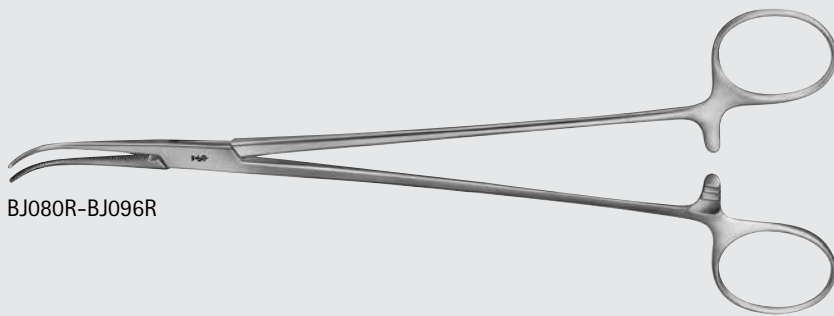

BJ080R-BJ096R



BJ080R

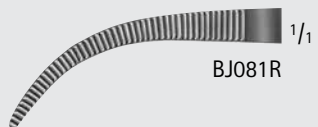

BJ081R

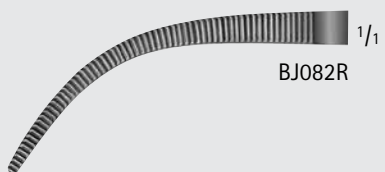

BJ082R



BJ083R



BJ086R



BJ090R

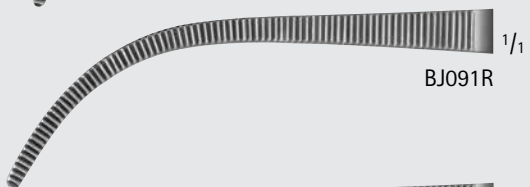

BJ091R

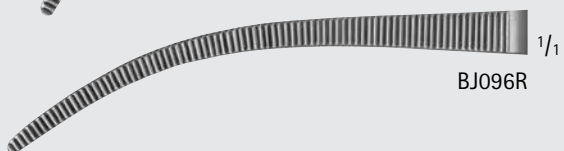

BJ096R

### OVERHOLT Forceps

Catalog Number	Jaw Curve (#)	Length (in.)
BJ080R	0	8 1/2
BJ081R	1	8 1/4
BJ082R	2	8 3/4
BJ083R	3	8 7/8
BJ086R	6	8 7/8
BJ090R	0	11 5/8
BJ091R	1	11 5/8
BJ096R	6	11 3/4

# General Surgery

## Dissecting and Right Angle Forceps

### MEEKER Forceps

Catalog Number	Length (in.)
MB459R	11

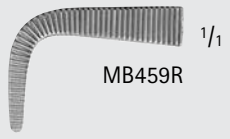
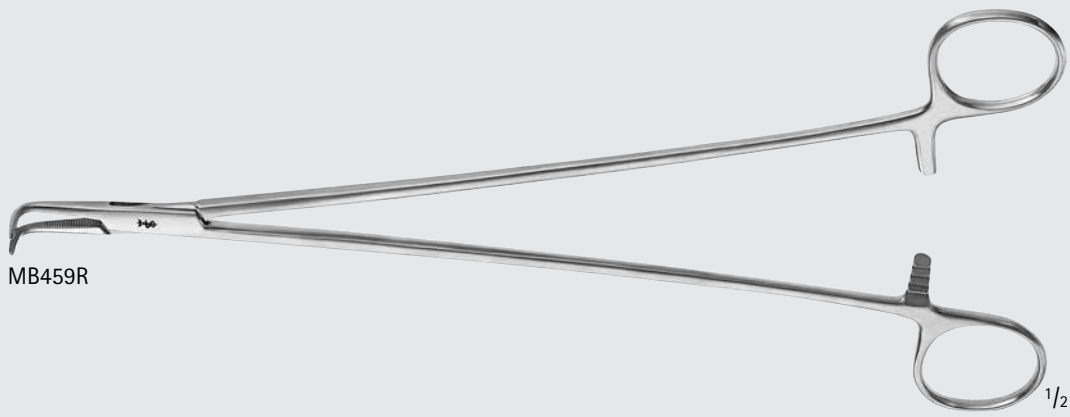

INCHES

# General Surgery

## Dissecting and Right Angle Forceps

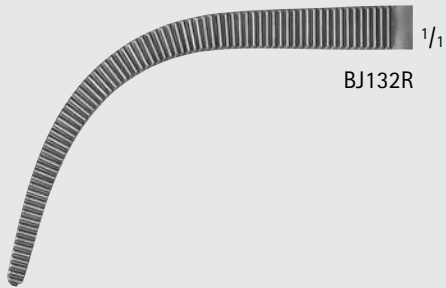
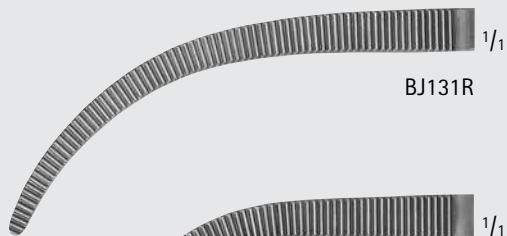
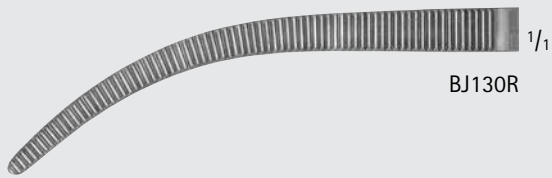
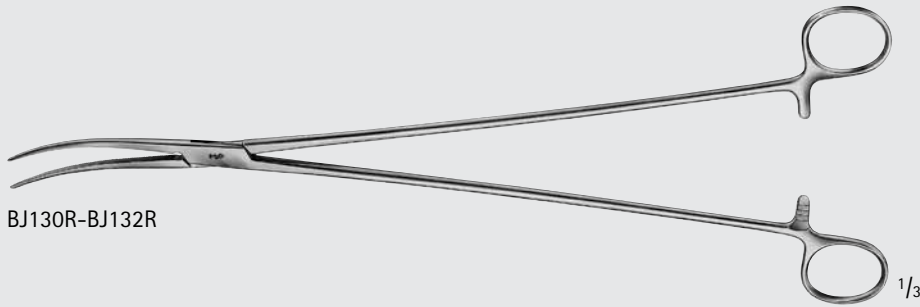
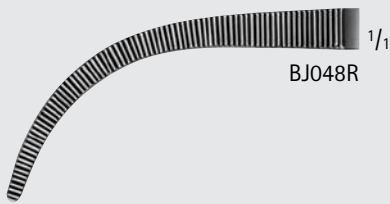
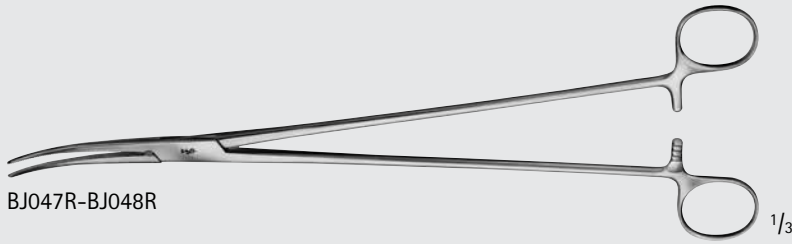

### ZENKER Ligature Forceps

Catalog Number	Jaw	Length (in.)
BJ047R	SLIGHT-CVD	11 3/4
BJ048R	HEAVY-CVD	11 1/2
BJ130R	SLIGHT-CVD	13 3/4
BJ131R	CVD	13 3/4
BJ132R	HEAVY-CVD	13 3/4



# General Surgery

## Dissecting and Right Angle Forceps

### MIXTER-O'SHAUGNESSY Forceps

Catalog Number	Length (in.)
BJ050R	7 1/2



BJ050R

1/2



BJ050R

1/1

### FINOCHIETTO Forceps

Catalog Number	Length (in.)
BJ052R	9 5/8

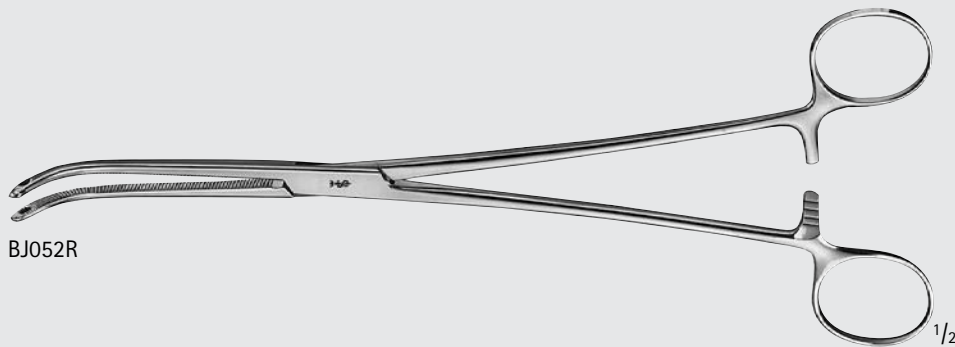

BJ052R

1/2



BJ052R

1/1

# General Surgery

## Dissecting and Right Angle Forceps

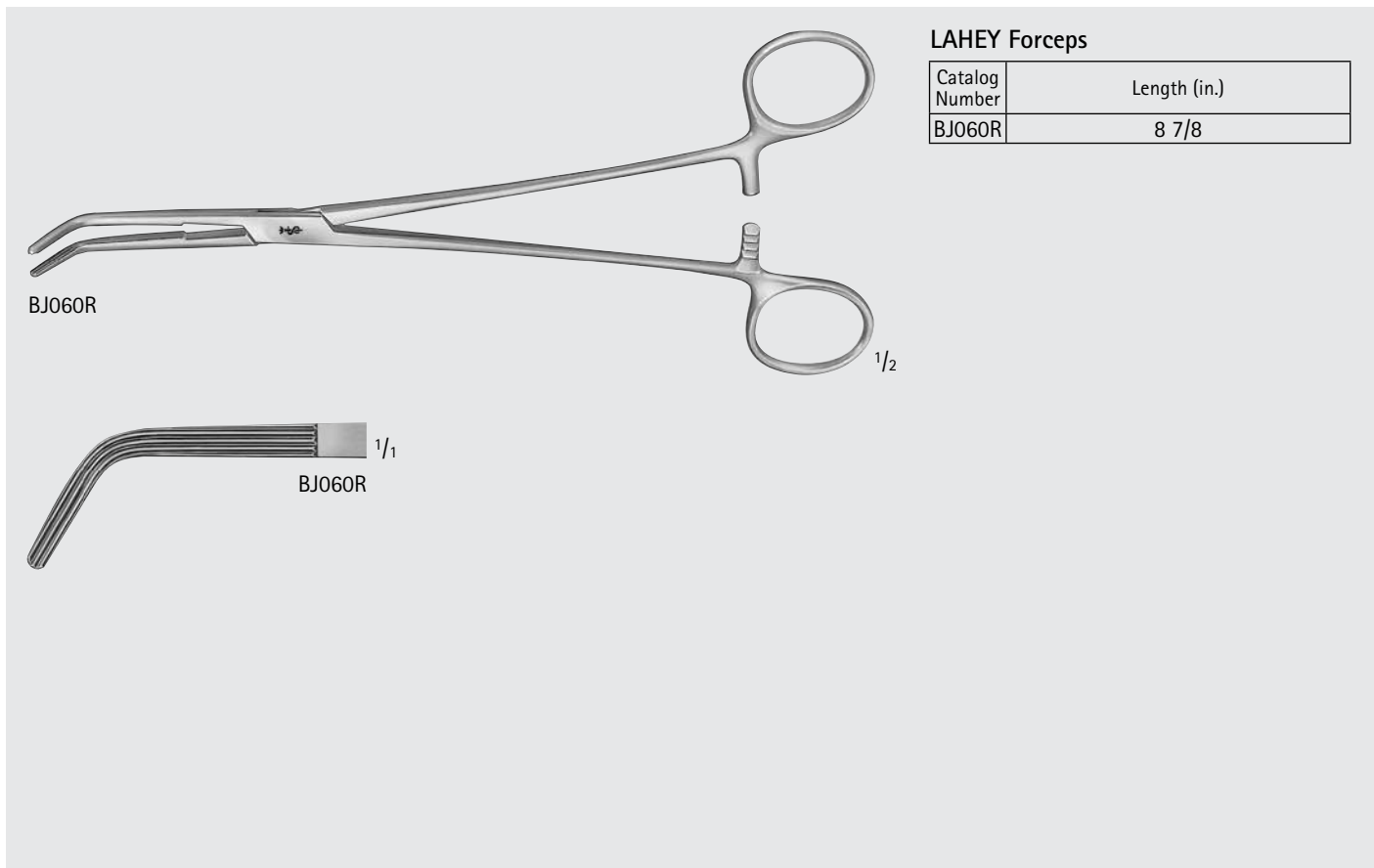

**LAHEY Forceps**

Catalog Number	Length (in.)
BJ060R	8 7/8

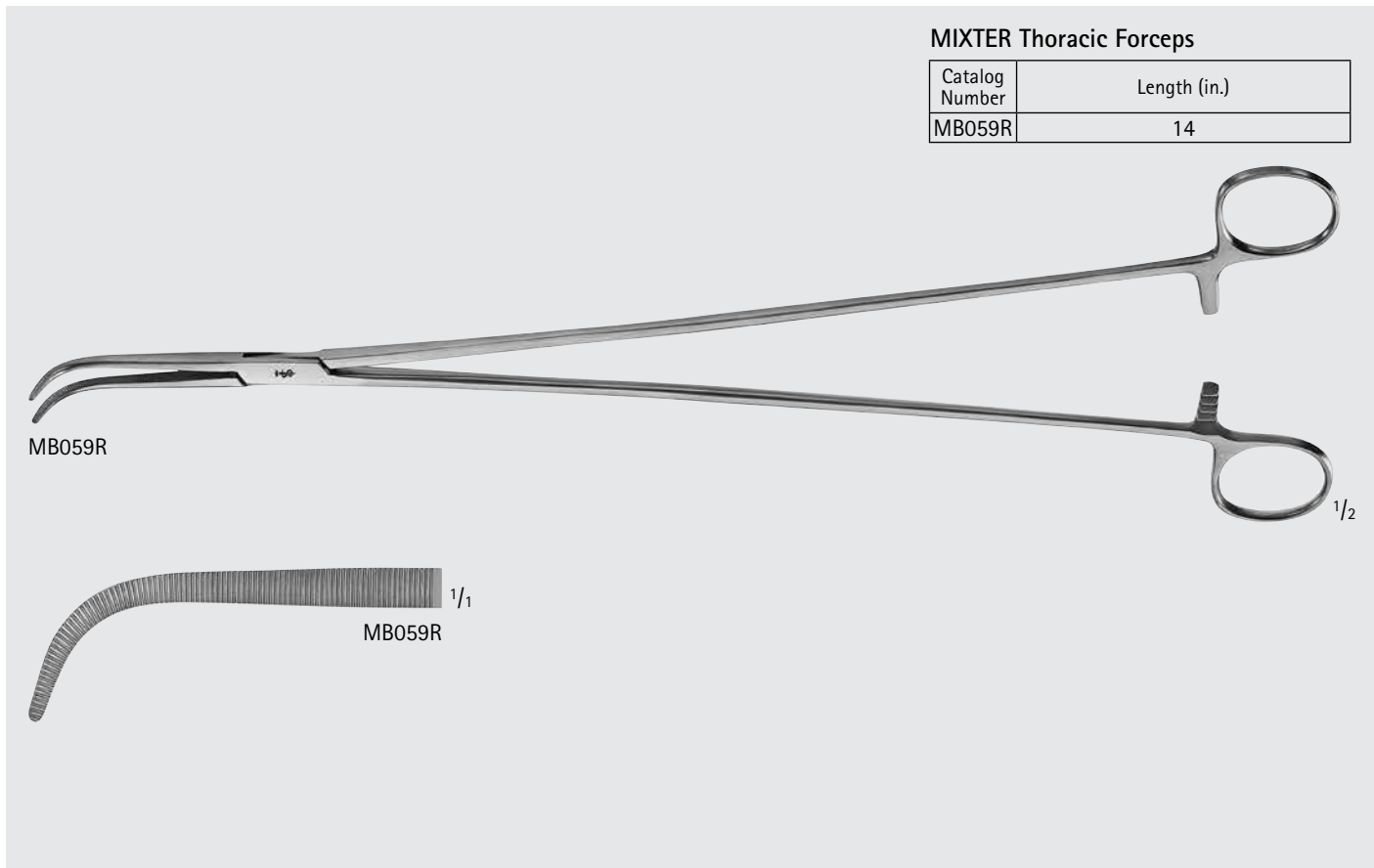

**MIXTER Thoracic Forceps**

Catalog Number	Length (in.)
MB059R	14

# General Surgery

## Dissecting and Right Angle Forceps

GENERAL SURGERY

### MIXTER Forceps, Longitudinal Serrations

Catalog Number	Length (in.)
BJ061R	8 3/4
BJ062R	9 3/4
BJ073R	11 1/2

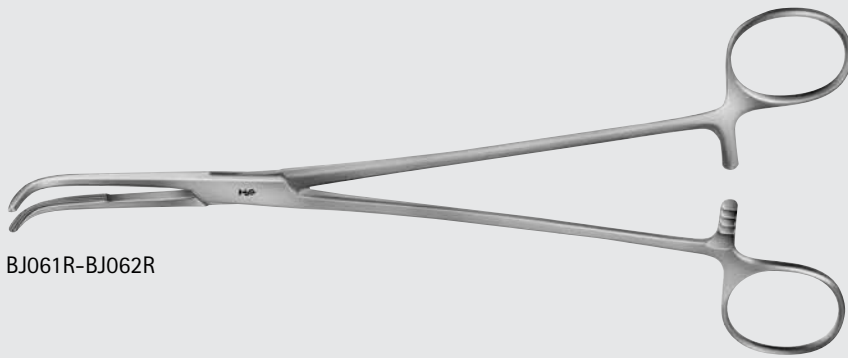

BJ061R-BJ062R



BJ061R



BJ062R

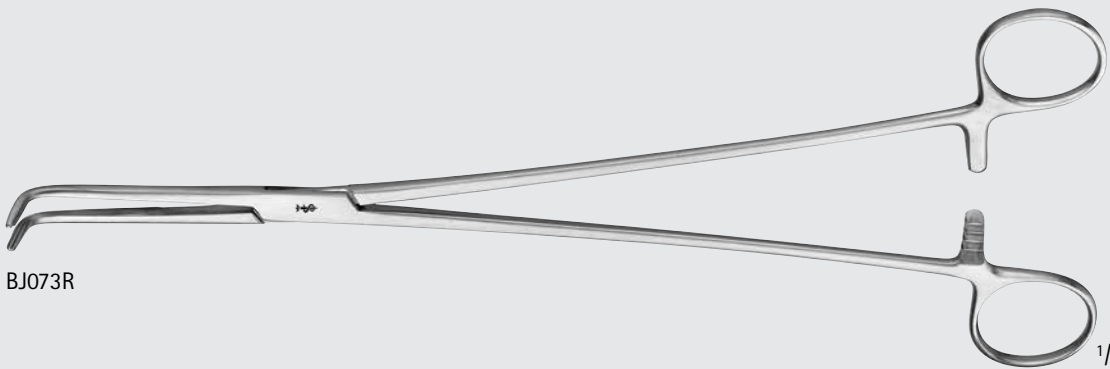

BJ073R

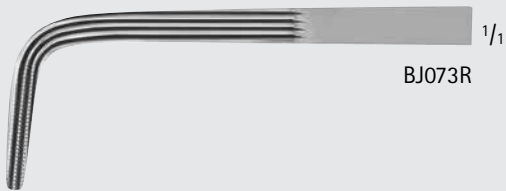

BJ073R



INCHES

# General Surgery

## Dissecting and Right Angle Forceps

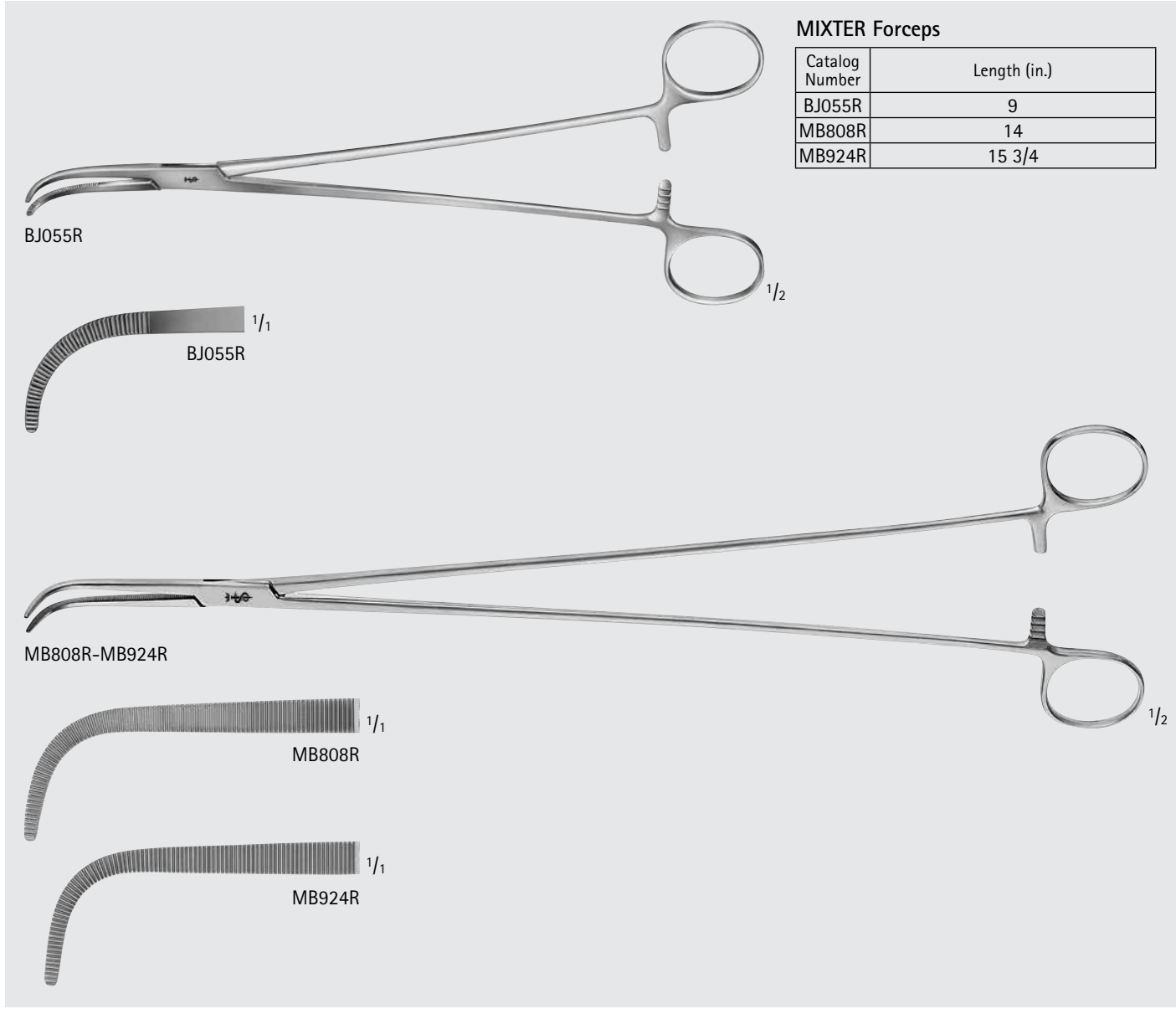
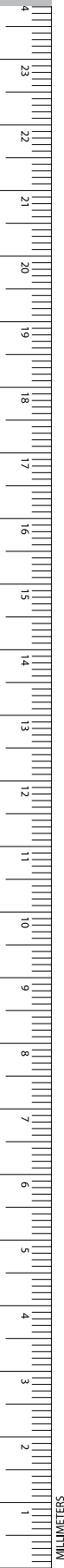

### MIXTER Forceps

Catalog Number	Length (in.)
BJ055R	9
MB808R	14
MB924R	15 3/4

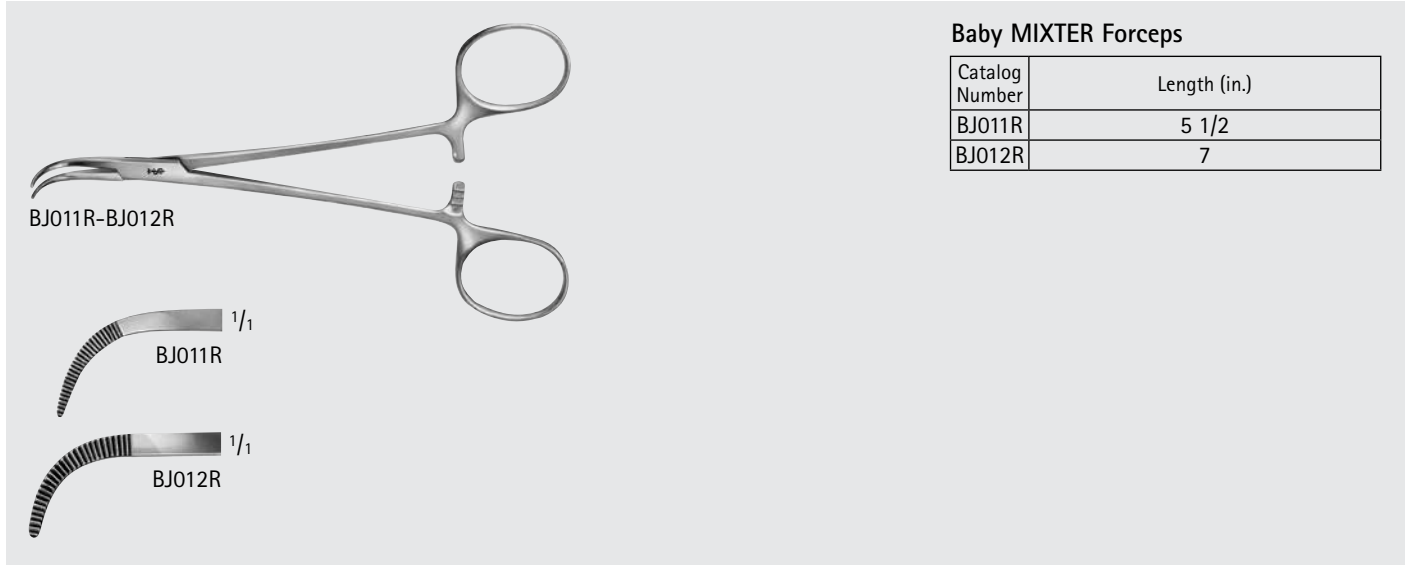

### Baby MIXTER Forceps

Catalog Number	Length (in.)
BJ011R	5 1/2
BJ012R	7

# General Surgery

## Dissecting and Right Angle Forceps

### HARRINGTON-MIXTER Forceps, Longitudinal Serrations

Catalog Number	Length (in.)
BJ072R	12 1/2

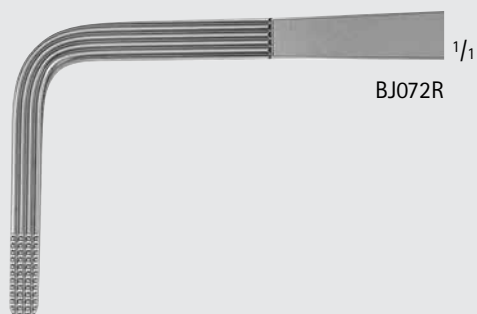
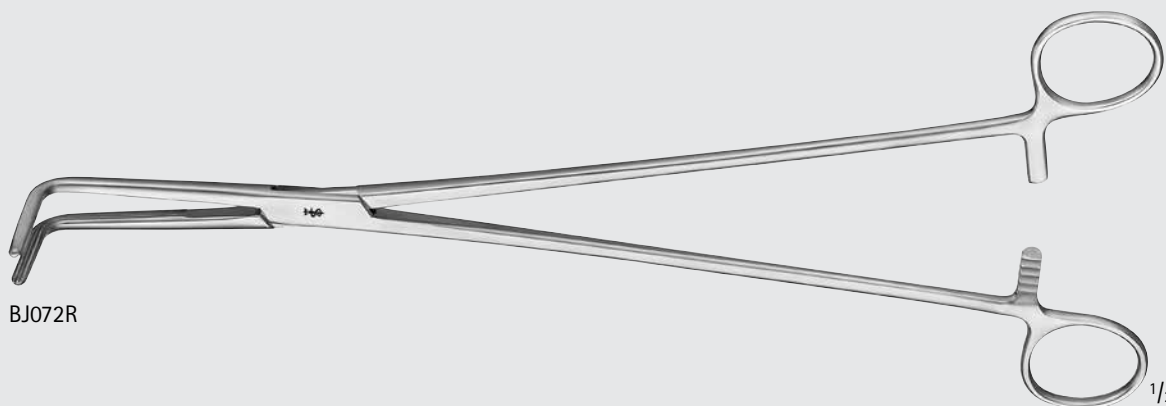

### WIKSTROEM Forceps

Catalog Number	Length (in.)
BJ051R	8

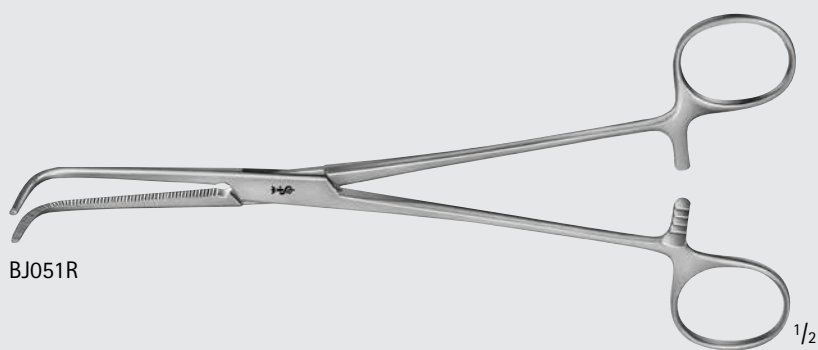

# General Surgery

## Dissecting and Right Angle Forceps



### LAWRENCE Forceps

Catalog Number	Length (in.)
BJ070R	10 5/8

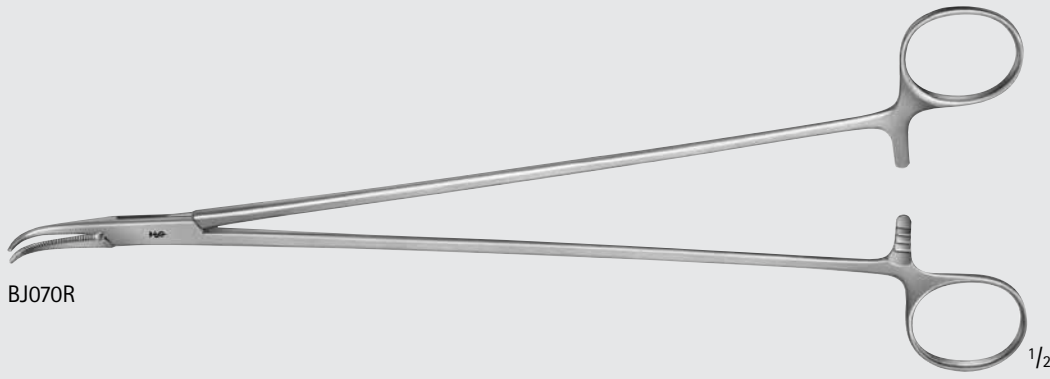

BJ070R

1/2



BJ070R

1/1

### REINHOFF Swan Neck Clamp

Catalog Number	Tip	Jaw	Handle	Length (in.)
US116	SERR	CVD	CVD	10 1/4

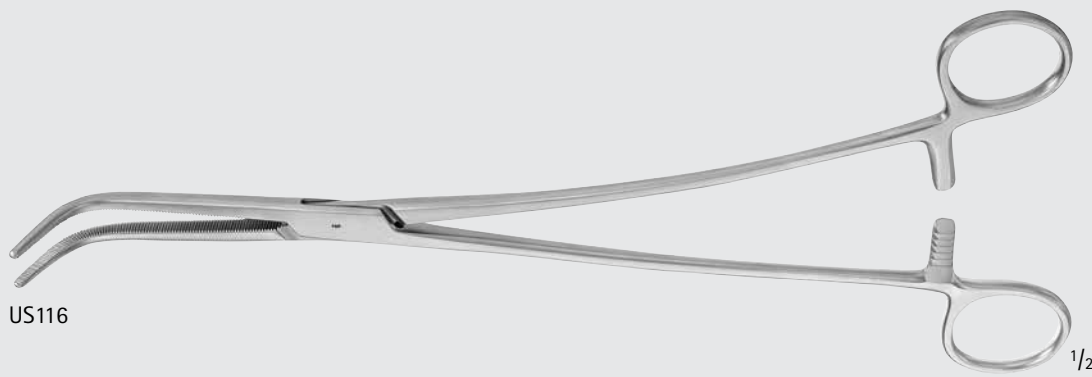

US116

1/2



US116

1/1

# General Surgery

## Dissecting and Right Angle Forceps

### KIEBACK Forceps

Catalog Number	Jaw	Length (in.)
BJ075R	CVD, LONGITUDINAL SERR	9 1/4

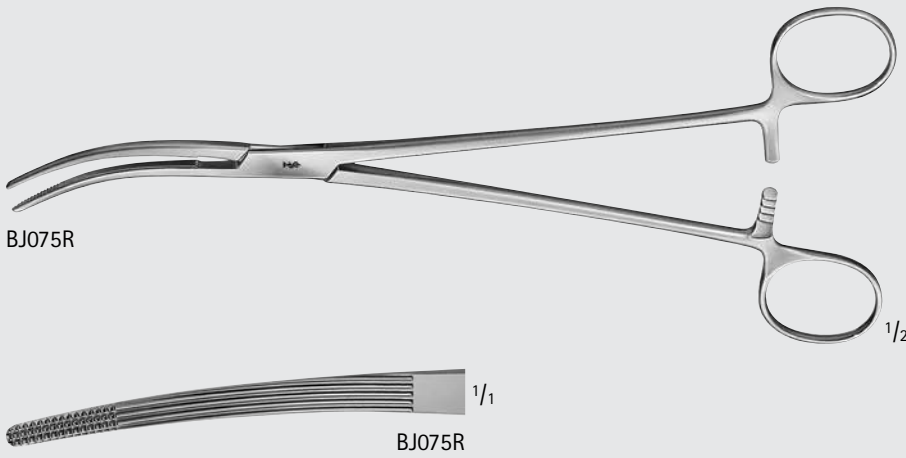

### COLLIER-ANDERSON Forceps

Catalog Number	Jaw	Length (in.)
MB897R	CVD, LONGITUDINAL SERR	10
MB898R	CVD, LONGITUDINAL SERR	11

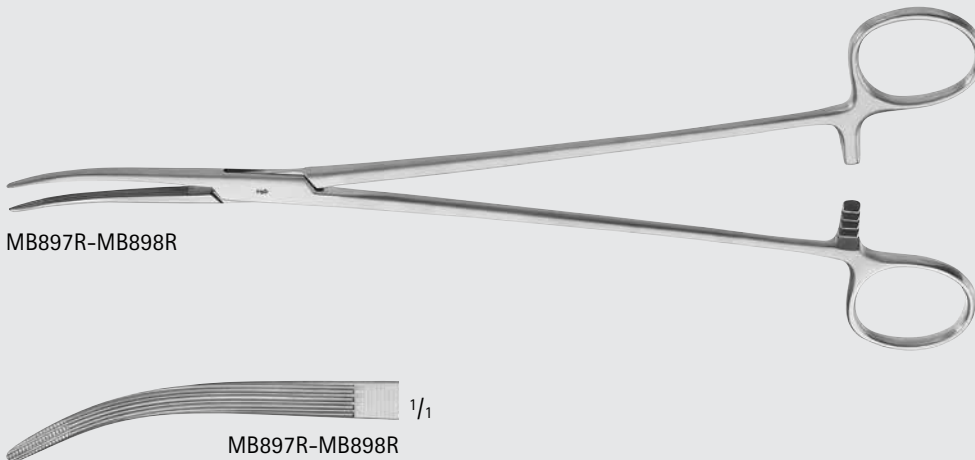

### DEBAKEY-COLLIER Forceps

Catalog Number	Jaw	Length (in.)
MB899R	CVD, SERR	8

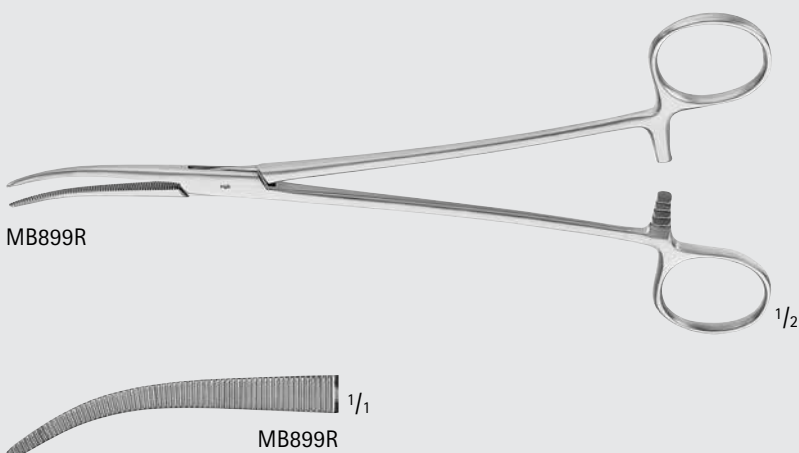

# General Surgery

## Towel and Tubing Clamps



BF407R

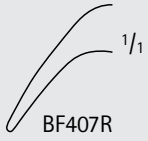

BF407R

### JONES Towel Clamp

Catalog Number	Length (in.)
BF407R	3 1/4

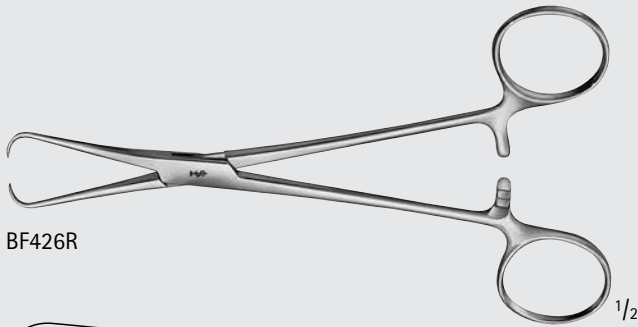

BF426R

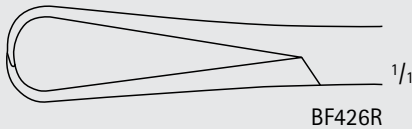

BF426R

### BERNHARD Towel Clamp

Catalog Number	Length (in.)
BF426R	6 1/4



BF431R-BF433R



BF431R

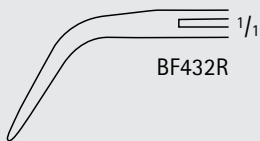

BF432R

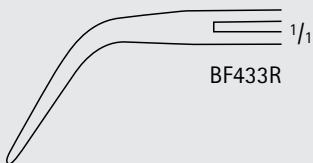

BF433R

### BACKHAUS Towel Clamp

Catalog Number	Length (in.)
BF431R	3 1/2
BF432R	4 1/4
BF433R	5 1/4

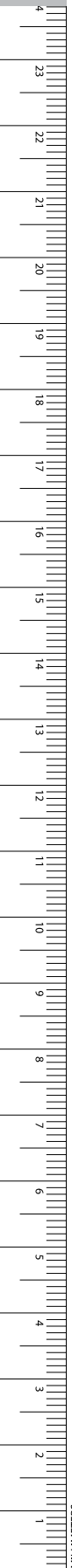

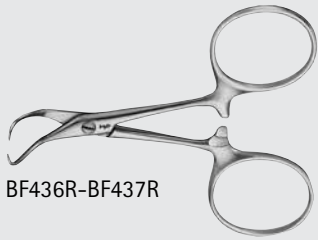

BF436R-BF437R

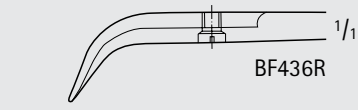

BF436R

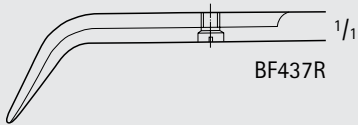

BF437R

**BACKHAUS Towel Clamp, W/ Screw**

Catalog Number	Length (in.)
BF436R	3 1/8
BF437R	4 1/8

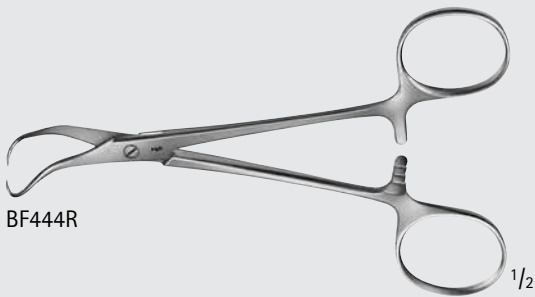

BF444R

1/2

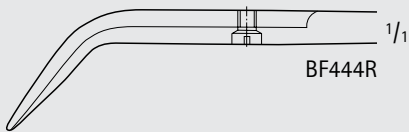

BF444R

**BACKHAUS-KOCHER Towel Clamp, W/ Screw**

Catalog Number	Length (in.)
BF444R	5 1/4



BF448R

1/2

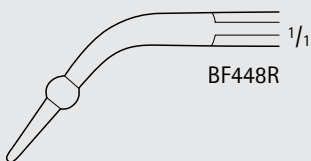

BF448R

**ROEDER Towel Clamp, W/ Ball On Jaws**

Catalog Number	Length (in.)
BF448R	5 1/4



INCHES

# General Surgery

## Towel and Tubing Clamps

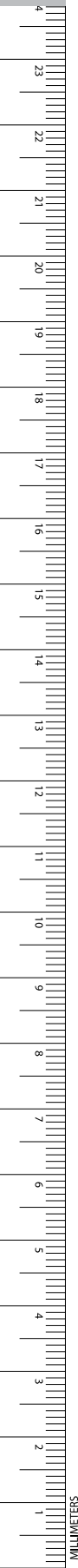

BF464R

1/2



BF464R

1/1

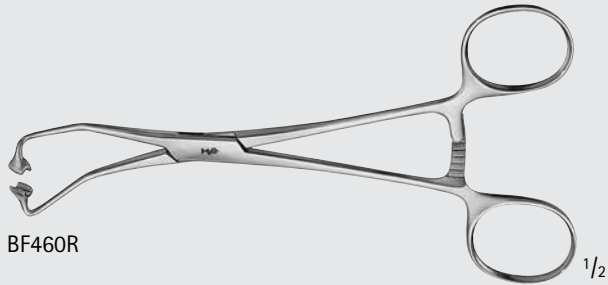

BF460R

1/2

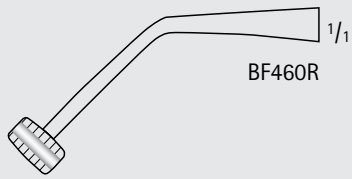

BF460R

1/1

### Towel Clamp, Paper Drape

Catalog Number	Length (in.)
BF464R	5 1/2
BF460R	6

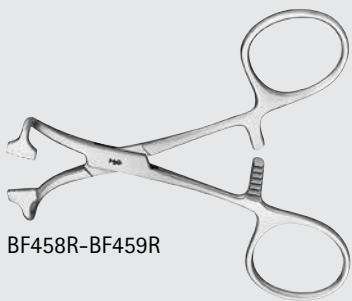

BF458R-BF459R

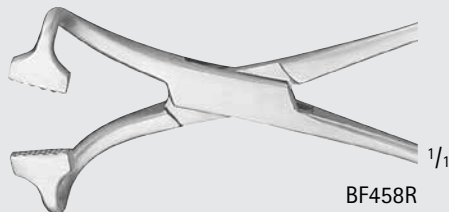

BF458R

1/1

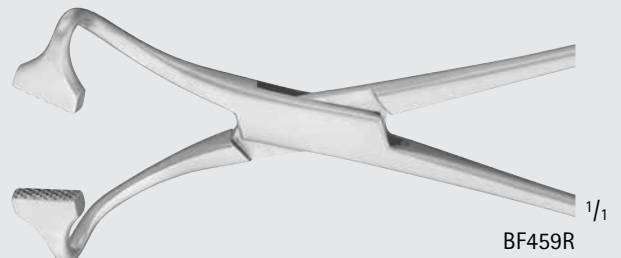

BF459R

1/1

### Non-Perforating Towel Forceps

Catalog Number	Length (in.)
BF458R	4
BF459R	5 1/2

# General Surgery

## Towel and Tubing Clamps

### LORNA Non-Perforating Towel Clamp

Catalog Number	Length (in.)
BF461R	3 3/4
BF463R	5 1/8

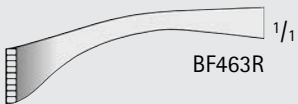
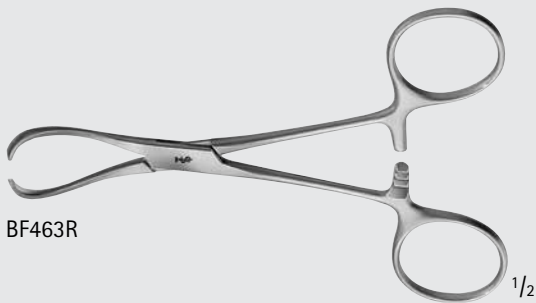

### Tubing Clamp, W/ Guard

Catalog Number	Jaw	Length (in.)
MD652	SERR	6
MD653	SERR	7
MD654	SERR	7 7/8

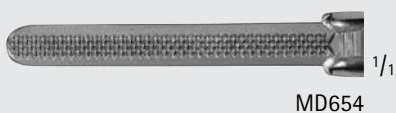
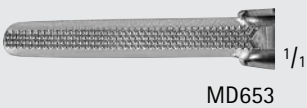
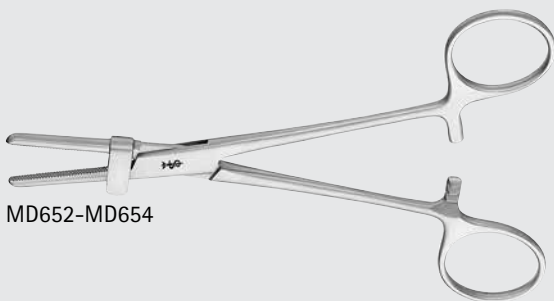

# General Surgery

## Skin Hooks

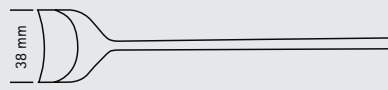
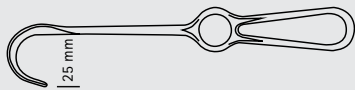

Dimensions for blade size of retractors  
 1st number = depth      Example: 25 x 38 mm  
 2nd number = width



OL620R, MA185R, OL622R-OL624R, MD581

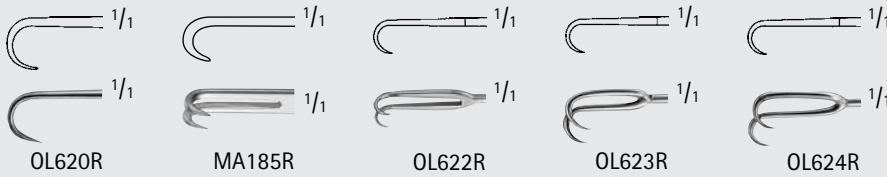

### JOSEPH Skin Hook

Catalog Number	Tip	Prongs	Tip Size (mm)	Length (in.)
OL620R	SHARP	1	-	6 1/2
MA185R	SHARP	2	2	6 1/4
OL622R	SHARP	2	3	6 1/2
OL623R	SHARP	2	6	6 1/2
OL624R	SHARP	2	8	6 1/2
MD581	SHARP	2	10	6 1/2



OL621R

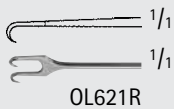

### FREER Double Hook

Catalog Number	Tip	Tip Size (mm)	Length (in.)
OL621R	SHARP	2.0 x 3.2	6



OA332R-OA333R

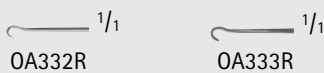

### GRAEFE Hook

Catalog Number	Tip	Length (in.)
OA332R	SHARP	5
OA333R	BLUNT	5



OA334R-OA335R

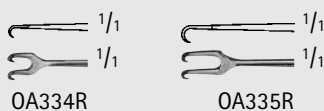

### GUTHRIE Double Hook

Catalog Number	Tip	Length (in.)
OA334R	SHARP	5
OA335R	SHARP	5 1/8

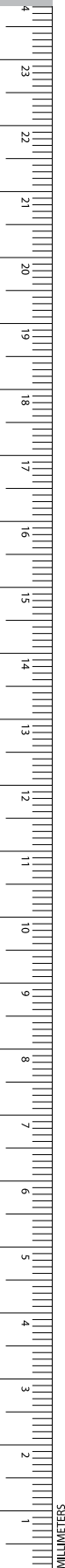



OA336R-OA338R



**ROLLET Hook Retractor**

Catalog Number	Tip	Blade End	Tip Size (mm)	Length (in.)
OA336R	SHARP	2 PRONGS	2.2 x 4.5	5 1/8
OA337R	SHARP	4 PRONGS	2.5 x 7.0	5 1/4
OA338R	BLUNT	4 PRONGS	2.2 x 7.0	5 1/4



OL615R

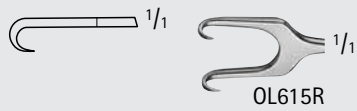

**MCINDOE Hook**

Catalog Number	Tip	Blade End	Tip Size (mm)	Length (in.)
OL615R	SHARP	2 PRONGS	9	6



OA340R

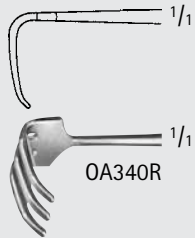

**PAUL Tendon Hook**

Catalog Number	Tip	Blade End	Tip Size (mm)	Length (in.)
OA340R	BLUNT	3 PRONGS	11 x 8	4 3/4



OA351R

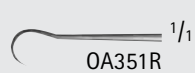

**JAEGER Hook Retractor, Fine**

Catalog Number	Tip	Length (in.)
OA351R	SHARP	5 1/4



OL610R

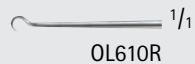

**KILNER Skin Hook**

Catalog Number	Tip	Length (in.)
OL610R	SHARP	6 1/4



OL611R-OL612R



**GILLIES Skin Hook**

Catalog Number	Tip	Hook End	Length (in.)
OL611R	SHARP	SMALL	7
OL612R	SHARP	LARGE	7

# General Surgery

## Skin Hooks

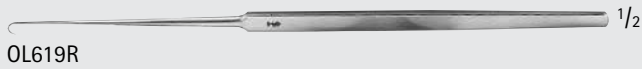

### COTTLE Hook

Catalog Number	Tip	Hook End	Length (in.)
OL617R	SHARP	ANG	6 1/4
OL619R	SHARP	HVY-CVD	6 1/4



### KLEINERT-KUTZ Skin Hook

Catalog Number	Size	Tip	Tip Size (mm)	Length (in.)
OL601R	1	SHARP	2.5	6 1/4
OL602R	2	SHARP	4.2	6 1/4
OL603R	3	SHARP	4.8	6 1/4



### Prong Micro Hooks

Catalog Number	Tip	Tip Size (mm)	Length (in.)
MB885R	SHARP	1	5 5/8
MB886R	SHARP	2	5 5/8
MB887R	BLUNT	2	5 5/8
MB888R	SHARP	2	5 5/8
MB889R	SHARP	5	5 5/8
MB890R	SHARP	7	5 5/8
MB891R	SHARP	10	5 5/8



BT075R

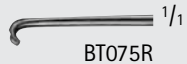

BT075R

**BROM Vein Hook**

Catalog Number	Length (in.)
BT075R	6 3/4



BT100R

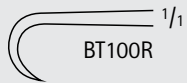

BT100R

**BERGMANN Hook**

Catalog Number	Tip	Tip Size (mm)	Length (in.)
BT100R	SHARP	7	5 1/2



BT161R

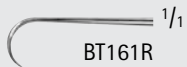

BT161R

**EMMET Fistula Hook**

Catalog Number	Tip	Length (in.)
BT161R	SHARP	8 3/4



BT166R

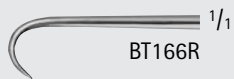

BT166R



BT167R

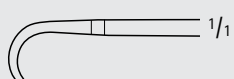

BT167R

**SIMON Fistula Hook**

Catalog Number	Tip	Blade End	Length (in.)
BT166R	SHARP	1 PRONG	8 3/4
BT167R	SHARP	2 PRONGS	8 3/4

# General Surgery

## Hand Held Retractors

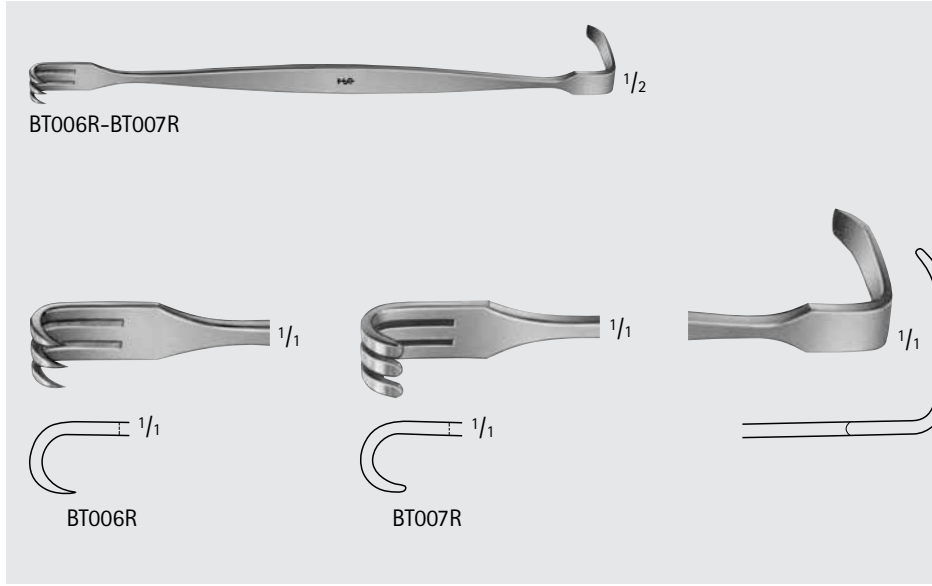

**Baby SENN-MILLER Retractor, Flat Handle**

Catalog Number	Tip	Blade End	Blade Size (mm)	Length (in.)
BT006R	SHARP	3 PRONGS	8 x 7 / 22 x 7	6 1/8
BT007R	BLUNT	3 PRONGS	8 x 7 / 22 x 7	6 1/8

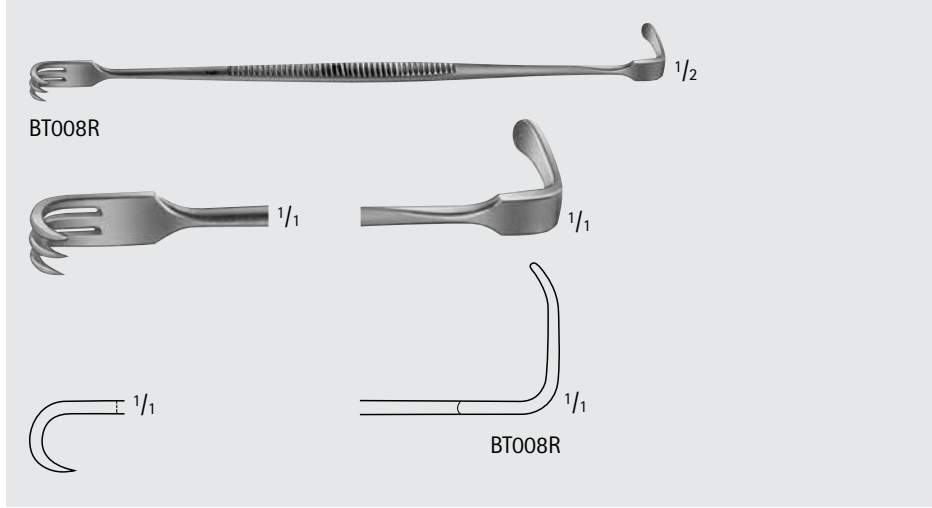

**SENN-MILLER Retractor**

Catalog Number	Tip	Blade End	Blade Size (mm)	Length (in.)
BT008R	SHARP	3 PRONGS	8 x 7 / 18 x 5.5	6 1/2

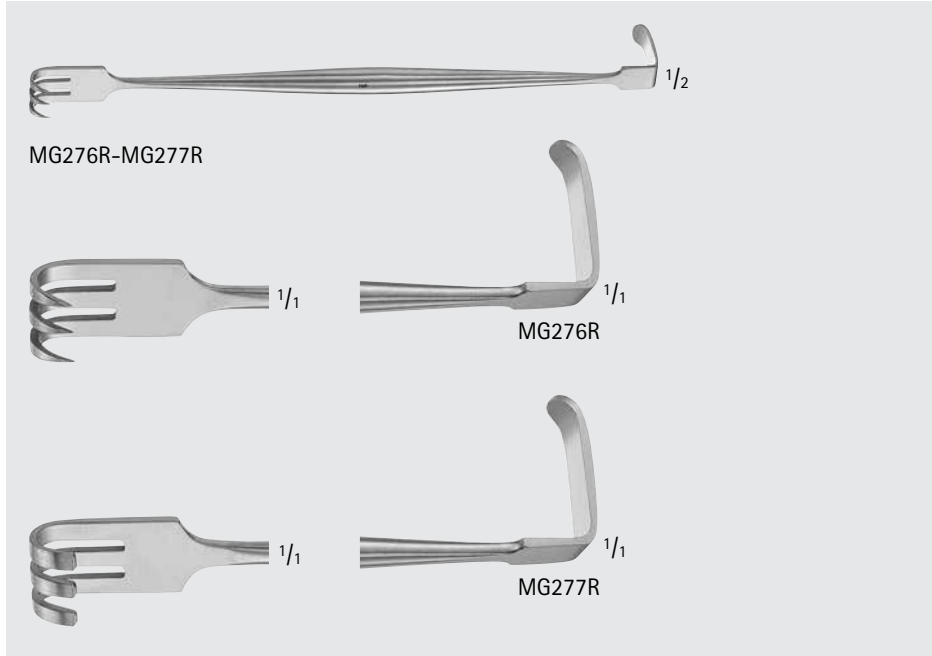

**SENN Retractor, Round Tapered Handle**

Catalog Number	Tip	Blade End	Blade Size (mm)	Length (in.)
MG276R	SHARP	3 PRONGS	9 x 10 / 22 x 7	6 1/4
MG277R	BLUNT	3 PRONGS	9 x 10 / 22 x 7	6 1/4



**RAGNELL Retractor**

Catalog Number	Blade Size (mm)	Length (in.)
BT004R	3 x 5 / 6.3 x 14	6
MG274R	3 x 11 / 5.4 x 17	6

**DAVIS Double Ended Retractor**

Catalog Number	Blade Size (mm)	Length (in.)
MG475R	19 x 9 / 23 x 6.4	6

**Double Ended Retractor**

Catalog Number	Blade Size (mm)	Length (in.)
BT187R	20 x 15 / 20 x 19	8

**GOELET Retractor**

Catalog Number	Blade Size (mm)	Length (in.)
MD497	30 x 32 / 35 x 40	7 1/2

# General Surgery

## Hand Held Retractors

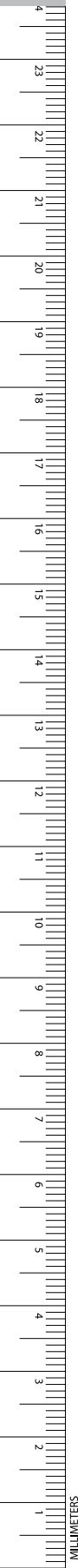

BT010R

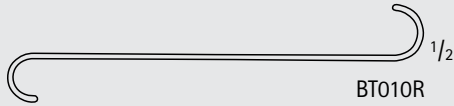

BT010R

### LUER Retractor

Catalog Number	Blade Size (mm)	Length (in.)
BT010R	10 x 8 / 12 x 11	4 1/4



BT020R

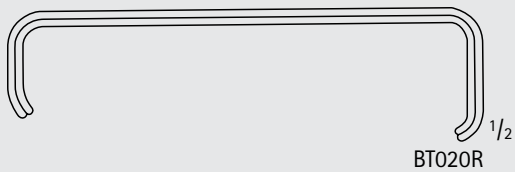

BT020R



BT021R

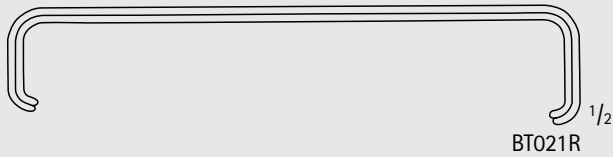

BT021R

### FARABEUF Retractor, 2/Set

Catalog Number	Blade Size (mm)	Length (in.)
BT020R	25 x 10 / 32 x 12 22 x 10 / 29 x 12	5
BT021R	23 x 16 / 28 x 16 19 x 16 / 24 x 16	6



MB984R

### MAYO-COLLINS Retractor, 2/Set

Catalog Number	Blade Size (mm)	Length (in.)
MB984R	31 x 20 / 30 x 18 28 x 19 / 26 x 17	5 7/8



BT022R

1/2

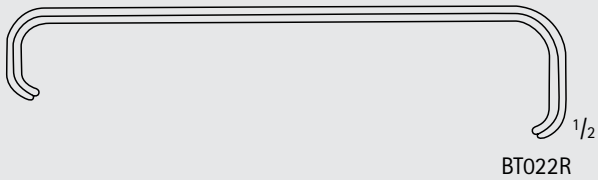

BT022R

1/2

**COLLIN Retractor, 2/Set**

Catalog Number	Blade Size (mm)	Length (in.)
BT022R	21 x 14 / 32 x 16 17 x 14 / 28 x 16	6



BT012R

1/2

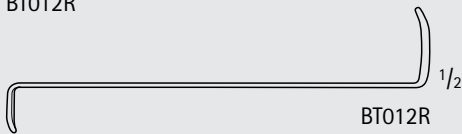

BT012R

1/2

**CRILE Retractor**

Catalog Number	Blade Size (mm)	Length (in.)
BT012R	11 x 4 / 19 x 6	4 1/4

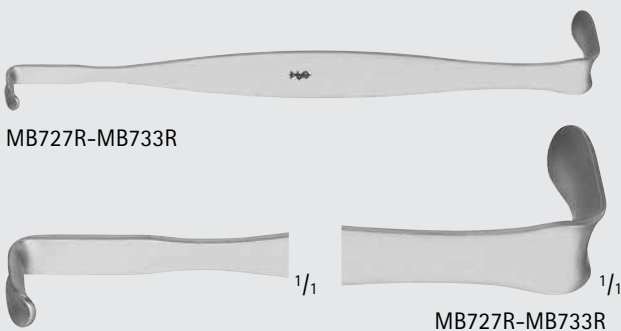

MB727R-MB733R

1/1

MB727R-MB733R

1/1

**CRILE Retractor**

Catalog Number	Size	Blade Size (mm)	Length (in.)
MB727R	1	3 x 11 / 6 x 21	4 1/4
MB728R	2	6 x 13 / 10 x 21	6 1/8
MB729R	3	16 x 25 / 17 x 35	6 1/4
MB730R	4	22 x 29 / 29 x 44	7
MB731R	5	29 x 41 / 35 x 51	7
MB732R	6	32 x 64 / 35 x 70	7 7/8
MB733R	7	41 x 76 / 51 x 79	8 7/8



INCHES

# General Surgery

## Hand Held Retractors



BT011R

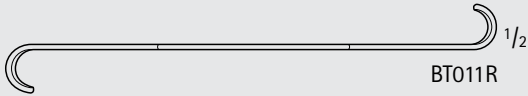

BT011R

### ROSE Tracheal Retractor

Catalog Number	Blade Size (mm)	Length (in.)
BT011R	10 x 12 / 11 x 15	5 1/8



MG474R

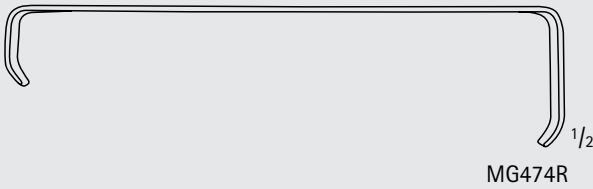

MG474R

### Children's Hospital Retractor

Catalog Number	Blade Size (mm)	Length (in.)
MG474R	11 x 22 / 14 x 35	4 1/2



BT025R

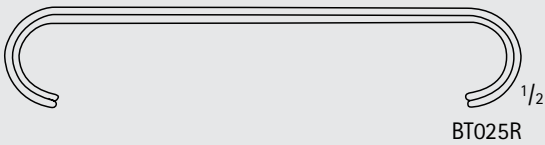

BT025R



BT026R

### PARKER Retractor, 2/Set

Catalog Number	Blade Size (mm)	Length (in.)
BT025R	22 x 15 / 22 x 15 18 x 15 / 18 x 15	5 1/4
BT026R	31 x 25 / 27 x 25 31 x 25 / 27 x 25	7



BT034R-BT036R

ROUX Retractor

Catalog Number	Blade Size (mm)	Length (in.)
BT034R	20 x 22 / 25 x 29	6
BT035R	25 x 26 / 30 x 38	6 1/4
BT036R	28 x 29 / 33 x 44	6 3/4



BT034R

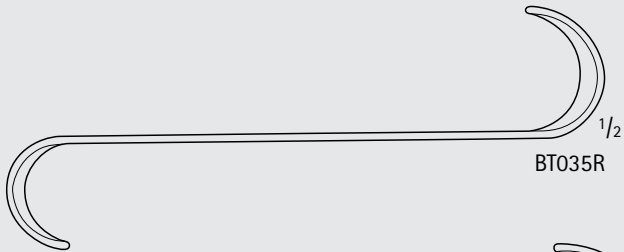

BT035R



BT036R



INCHES

General Surgery  
Hand Held Retractors



BT030R-BT033R

BT031R 1/2

BT032R 1/2

BT033R 1/2

ROUX Retractor

Catalog Number	Blade Size (mm)	Length (in.)
BT030R	COMPLETE SET BT031R-BT033R	-
BT031R	21 x 22 / 27 x 28	5 3/4
BT032R	26 x 26 / 32 x 26	6 1/8
BT033R	30 x 30 / 36 x 44	6 1/2

MB584R-MB585R

MB584R 1/2

MB585R 1/2

ROUX Retractor

Catalog Number	Blade Size (mm)	Length (in.)
MB584R	25 x 26 / 30 x 37	6 1/2
MB585R	28 x 28 / 29 x 40	6 1/2

BT029R

BT029R 1/2

ROUX Retractor, Long

Catalog Number	Blade Size (mm)	Length (in.)
BT029R	28 x 28 / 46 x 28	7 1/2

# General Surgery

## Hand Held Retractors

GENERAL SURGERY



BT040R

### MATHIEU Retractor, 2/Set

Catalog Number	Blade Size (mm)	Length (in.)
BT040R	42 x 13 / 41 x 13 45 x 25 / 40 x 25	7 7/8

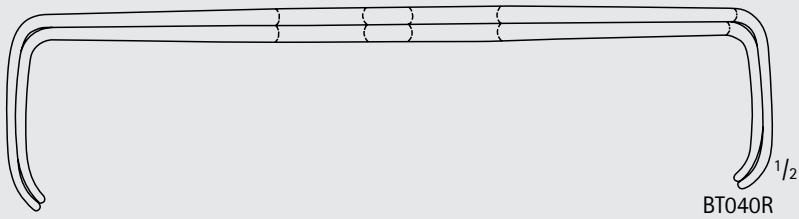

BT040R



BT041R

### US Army Retractor, 2/Set

Catalog Number	Blade Size (mm)	Length (in.)
BT041R	26 x 15 / 22 x 15 43 x 15 / 39 x 15	8 3/4

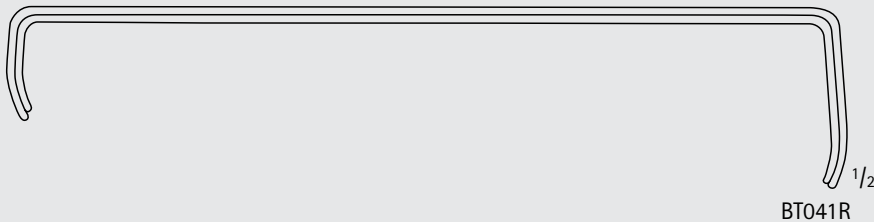

BT041R



INCHES

# General Surgery

## Hand Held Retractors

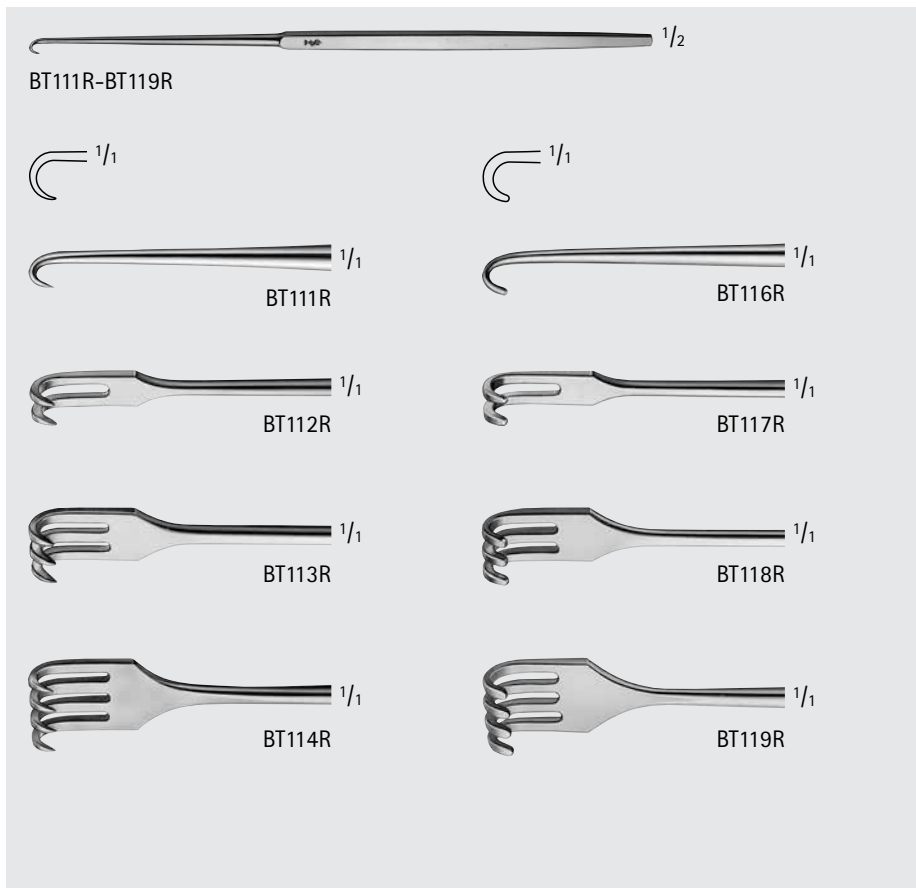

### Hook, Small Curve

Catalog Number	Tip	Blade End	Blade Size (mm)	Length (in.)
BT111R	SHARP	1 PRONG	-	6 1/2
BT112R	SHARP	2 PRONGS	5.0 x 4.2	6 1/2
BT113R	SHARP	3 PRONGS	5.0 x 7.0	6 1/2
BT114R	SHARP	4 PRONGS	5.0 x 9.5	6 1/2
BT116R	BLUNT	1 PRONG	-	6 1/2
BT117R	BLUNT	2 PRONGS	4.5 x 4.2	6 1/2
BT118R	BLUNT	3 PRONGS	4.5 x 7.0	6 1/2
BT119R	BLUNT	4 PRONGS	4.5 x 9.0	6 1/2

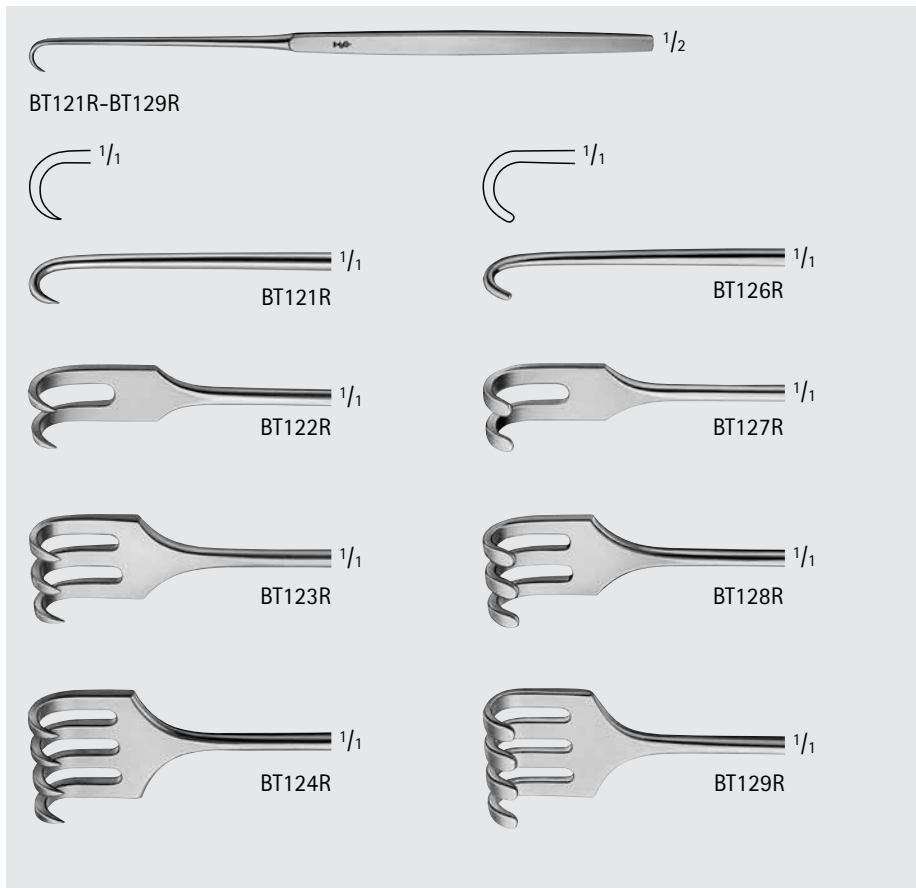

### Hook, Large Curve

Catalog Number	Tip	Blade End	Blade Size (mm)	Length (in.)
BT121R	SHARP	1 PRONG	-	6 1/2
BT122R	SHARP	2 PRONGS	7.5 x 7.5	6 1/2
BT123R	SHARP	3 PRONGS	7.5 x 10.0	6 1/2
BT124R	SHARP	4 PRONGS	7.5 x 14.0	6 1/2
BT126R	BLUNT	1 PRONG	-	6 1/2
BT127R	BLUNT	2 PRONGS	6.8 x 7.5	6 1/2
BT128R	BLUNT	3 PRONGS	6.8 x 10.0	6 1/2
BT129R	BLUNT	4 PRONGS	6.8 x 14.0	6 1/2

**CRILE Hook and Dissector**

Catalog Number	Length (in.)
MB060R	11 3/4



**KLAPP Tendon Hook**

Catalog Number	Tip	Blade End	Blade Size (mm)	Length (in.)
BT172R	BLUNT	4 PRONGS	15 x 11	6 7/8

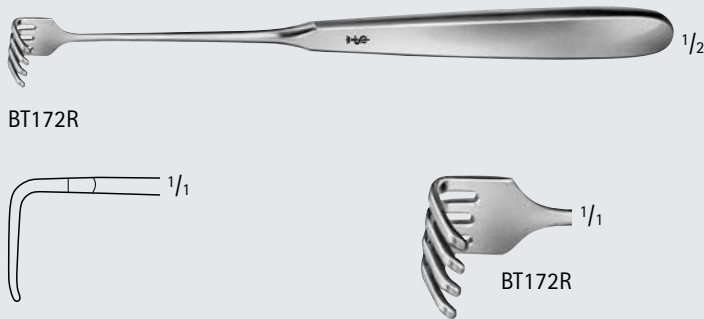

**Vein Retractor**

Catalog Number	Blade Size (mm)	Length (in.)
BT179R	10 x 13	6 1/4



**KOENIG Vein Retractor**

Catalog Number	Blade Size (mm)	Length (in.)
BT182R	13 x 13	7
BT183R	12 x 16	7

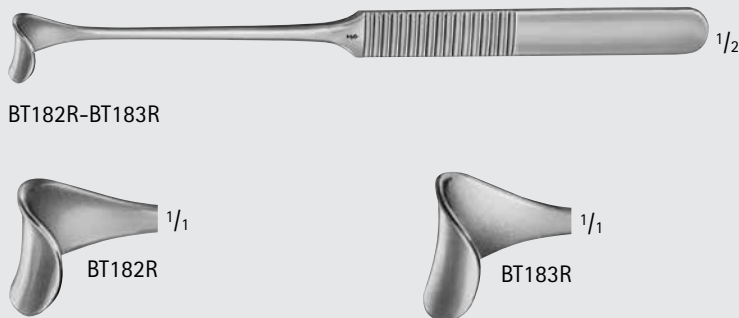

INCHES

# General Surgery

## Hand Held Retractors

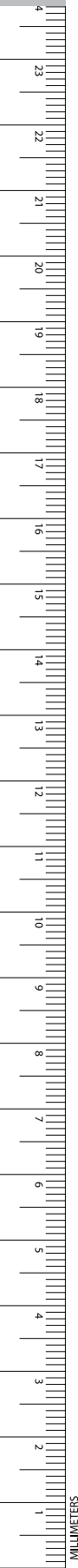

BT193R-BT198R

### MEYERDING Thumb Retractor

Catalog Number	Blade Size	Size (#)	Blade Size (mm)	Length (in.)
BT193R	A	1	18 x 7	7
BT194R	B	2	16 x 5	7
BT195R	C	3	7 x 4	7
BT196R	D	4	5 x 10	7
BT197R	E	5	11 x 4	7
BT198R	F	6	6 x 4	7

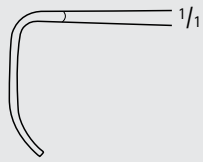

BT193R

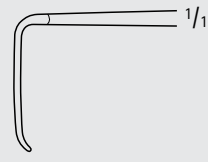

BT194R

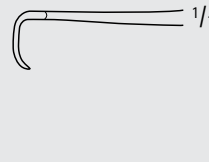

BT195R



BT196R



BT197R

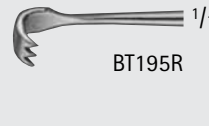

BT198R

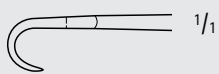

BT190R

### CUSHING-KOCHER Retractor

Catalog Number	Blade Size (mm)	Length (in.)
BT190R	10 x 10	6 7/8



BT190R



BT184R-BT185R

### CUSHING Vein Retractor

Catalog Number	Blade Size (mm)	Length (in.)
BT184R	10 x 13	8
BT185R	14 x 18	8



BT184R



BT185R

**CUSHING Vein Retractor  
(continued)**

Catalog Number	Blade Size (mm)	Length (in.)
BT200R	14 x 11	9 3/4
BT202R	22 x 15	9 3/4



BT200R-BT202R



BT200R



BT202R

**CUSHING Vein Retractor**

Catalog Number	Blade Size (mm)	Length (in.)
MB912R	14	12 1/2
MB913R	14	14
MB914R	14	16



MB912R-MB914R



MB912R-MB914R

**GIL VERNET Retractor, Malleable**

Catalog Number	Blade Size (mm)	Length (in.)
MB766R	9	11 1/4
MB767R	11	11 1/4
MB768R	13	11 1/4
MB769R	18	11 1/4



MB766R-MB769R



MB766R-MB769R



INCHES

# General Surgery

## Hand Held Retractors



BT221R

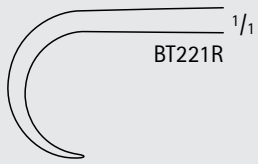

BT221R



BT222R-BT230R

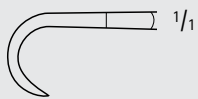

1/1

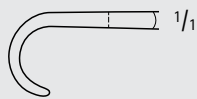

1/1



BT222R



BT227R



BT223R



BT228R



BT224R



BT229R



BT225R



BT230R

### VOLKMANN Retractor

Catalog Number	Tip	Blade End	Blade Size (mm)	Length (in.)
BT221R	SHARP	1 PRONG	8.5 x 8	8 3/4
BT222R	SHARP	2 PRONGS	9 x 8	8 7/8
BT223R	SHARP	3 PRONGS	9 x 13	8 7/8
BT224R	SHARP	4 PRONGS	9 x 19	8 7/8
BT225R	SHARP	6 PRONGS	9 x 29	8 7/8
BT227R	BLUNT	2 PRONGS	8.5 x 12	8 7/8
BT228R	BLUNT	3 PRONGS	8.5 x 13	8 7/8
BT229R	BLUNT	4 PRONGS	8.5 x 19	8 7/8
BT230R	BLUNT	6 PRONGS	8.5 x 29	8 7/8

**VOLKMANN Retractor, Small**

Catalog Number	Tip	Blade End	Blade Size (mm)	Length (in.)
BT240R	SHARP	1 PRONG	-	8 3/4
BT241R	BLUNT	1 PRONG	-	8 3/4
BT242R	SHARP	2 PRONGS	9 x 8	8 3/4
BT243R	SHARP	3 PRONGS	9 x 13	8 3/4
BT244R	SHARP	4 PRONGS	9 x 19	8 3/4
BT246R	SHARP	6 PRONGS	9 x 29	8 3/4
BT248R	SHARP	8 PRONGS	9 x 40	8 3/4
BT257R	SEMI-S	2 PRONGS	8.5 x 8	8 3/4
BT259R	SEMI-S	3 PRONGS	8.5 x 13	8 3/4
BT260R	SEMI-S	4 PRONGS	8.5 x 19	8 3/4
BT261R	SEMI-S	6 PRONGS	8.5 x 29	8 3/4
BT265R	SEMI-S	8 PRONGS	8.5 x 40	8 3/4
BT252R	BLUNT	2 PRONGS	8 x 8	8 3/4
BT253R	BLUNT	3 PRONGS	8 x 13	8 3/4
BT254R	BLUNT	4 PRONGS	8 x 19	8 3/4
BT256R	BLUNT	6 PRONGS	8 x 29	8 3/4
BT258R	BLUNT	8 PRONGS	8 x 40	8 3/4



BT240R-BT241R

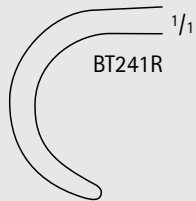
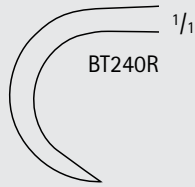

BT242R-BT265R

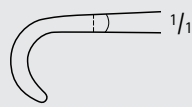
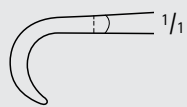
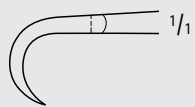

INCHES

# General Surgery

## Hand Held Retractors

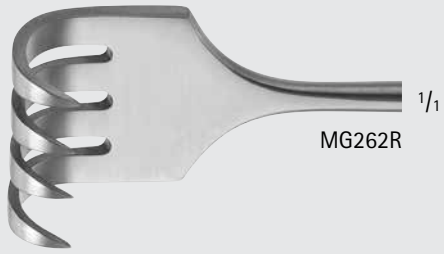
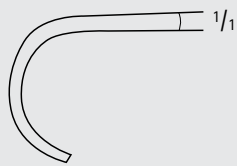
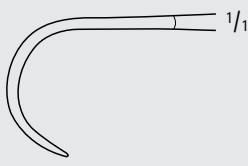
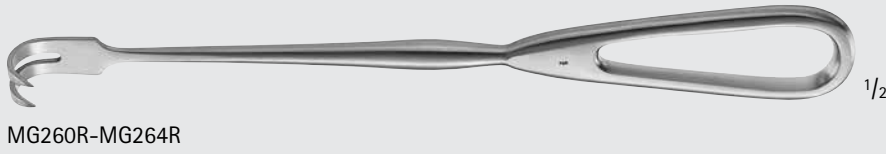

**VOLKMANN Retractor, US Version**

Catalog Number	Tip	Blade End	Blade Size (mm)	Length (in.)
MG260R	SHARP	2 PRONGS	20 x 11	8 3/4
MG261R	SHARP	3 PRONGS	20 x 18	8 3/4
MG262R	SHARP	4 PRONGS	20 x 26	8 3/4
MG264R	SHARP	6 PRONGS	20 x 40	8 3/4
MG265R	BLUNT	2 PRONGS	20 x 11	8 3/4
MG266R	BLUNT	3 PRONGS	20 x 18	8 3/4
MG267R	BLUNT	4 PRONGS	20 x 26	8 3/4
MG269R	BLUNT	6 PRONGS	20 x 40	8 3/4



BT262R-BT276R

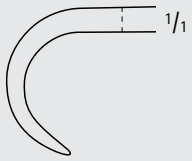

BT262R



BT263R



BT264R



BT266R

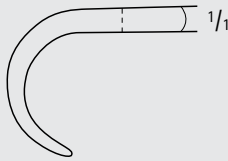

BT272R



BT273R



BT274R



BT276R

**KOCHER Retractor, Large**

Catalog Number	Tip	Blade End	Blade Size (mm)	Length (in.)
BT262R	SEMI-S	2 PRONGS	16 x 9	8 3/4
BT263R	SEMI-S	3 PRONGS	16 x 14	8 3/4
BT264R	SEMI-S	4 PRONGS	16 x 20	8 3/4
BT266R	SEMI-S	6 PRONGS	16 x 30	8 3/4
BT272R	BLUNT	2 PRONGS	15.5 x 9	8 3/4
BT273R	BLUNT	3 PRONGS	15.5 x 14	8 3/4
BT274R	BLUNT	4 PRONGS	15.5 x 20	8 3/4
BT276R	BLUNT	6 PRONGS	15.5 x 30	8 3/4



BT278R-BT279R

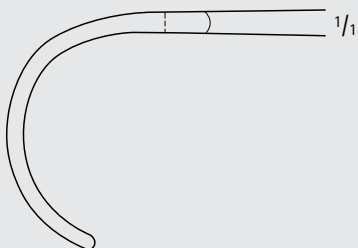

BT279R



BT278R

**KOERTE Retractor**

Catalog Number	Tip	Blade End	Blade Size (mm)	Length (in.)
BT279R	SEMI-S	8 PRONGS	26 x 40	9 1/2
BT278R	BLUNT	8 PRONGS	26 x 40	9 1/2



INCHES

# General Surgery

## Hand Held Retractors



### ISRAEL Retractor

Catalog Number	Tip	Blade End	Blade Size (mm)	Length (in.)
BT284R	BLUNT	4 PRONGS	39 x 40	10
BT285R	BLUNT	5 PRONGS	47 x 51	10
BT286R	BLUNT	6 PRONGS	53 x 62	10
BT287R	BLUNT	6 PRONGS	70 x 70	10



BT284R-BT287R

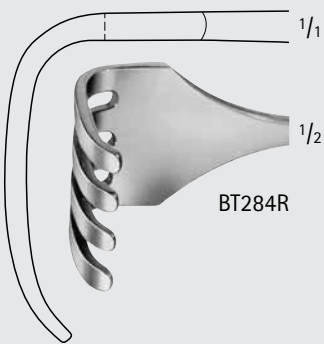

BT284R

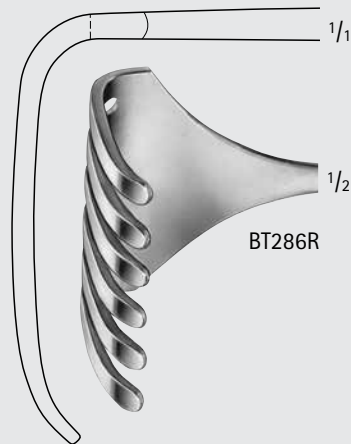

BT286R

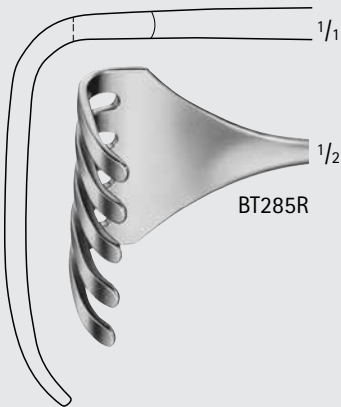

BT285R

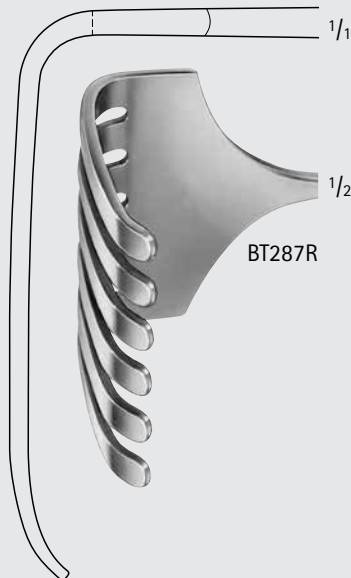

BT287R



ISRAEL Retractor, T-Handle

Catalog Number	Tip	Blade End	Blade Size (mm)	Length (in.)
MG284R	BLUNT	4 PRONGS	46 x 40	7 1/2



MG284R

1/2



MG284R

1/2

MURPHY Retractor

Catalog Number	Tip	Blade End	Length (in.)
BT293R	SHARP	3 PRONGS	7 3/4
BT294R	SHARP	4 PRONGS	7 3/4
BT296R	BLUNT	4 PRONGS	7 3/4



BT293R-BT296R

1/2



BT293R

1/1

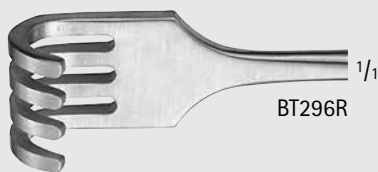

BT296R

1/1



BT294R

1/1

KOERTE-WAGNER Retractor

Catalog Number	Tip	Blade End	Blade Size (mm)	Length (in.)
BT290R	SEMI-S	8 PRONGS	28 x 40	11

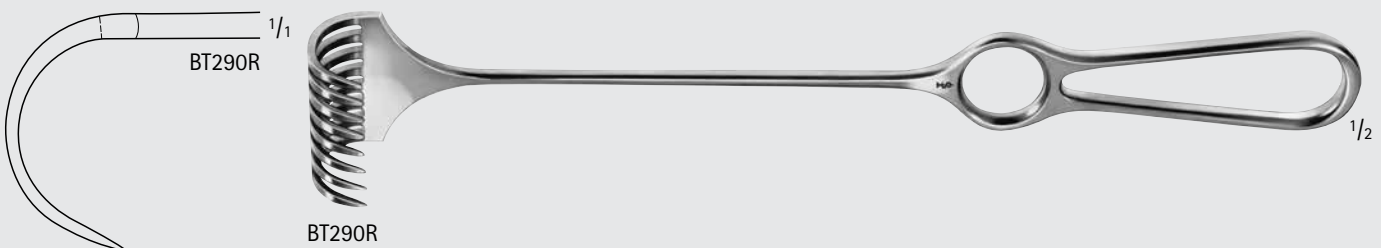

BT290R

1/1

BT290R

1/2

# General Surgery

## Hand Held Retractors



### LANGENBECK Retractor

Catalog Number	Blade Size (mm)	Length (in.)
BT311R	30 x 10	9
BT315R	40 x 10	9
BT316R	43 x 13	9

BT311R-BT316R

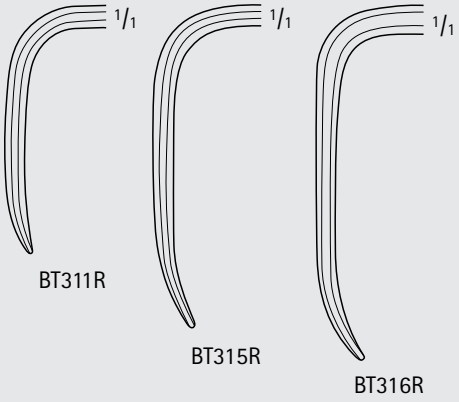

BT311R

BT315R

BT316R



### SAUERBRUCH Retractor

Catalog Number	Blade Size (mm)	Length (in.)
BT351R	46 x 16	8 7/8
BT352R	55 x 22	8 7/8
BT353R	72 x 19	8 7/8

BT351R-BT353R

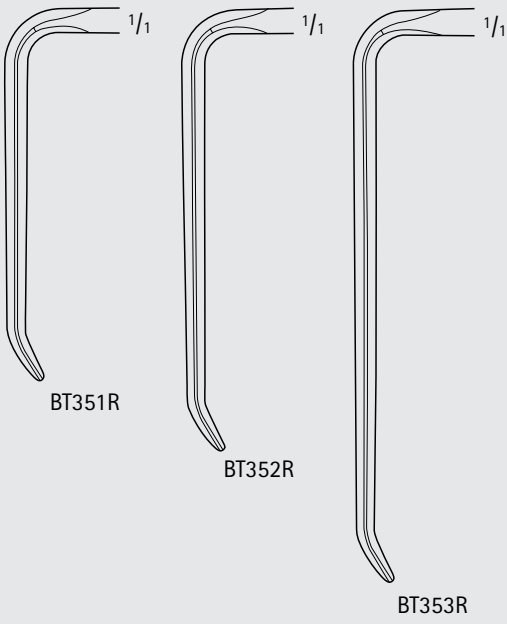

BT351R

BT352R

BT353R

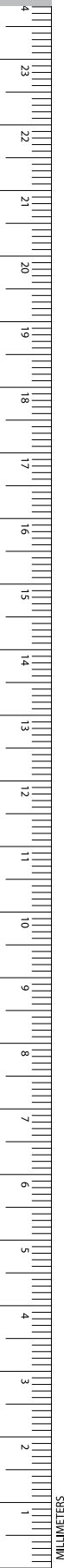



BT354R-BT365R

**KOCHER-LANGENBECK Retractor**

Catalog Number	Blade Size (mm)	Length (in.)
BT354R	25 x 6	8 1/2
BT356R	35 x 8	8 1/2
BT357R	35 x 11	8 1/2
BT358R	35 x 15	8 1/2
BT359R	41 x 11	8 1/2
BT361R	55 x 11	8 1/2
BT363R	70 x 14	8 1/2
BT364R	80 x 12	8 1/2
BT365R	80 x 16	8 1/2

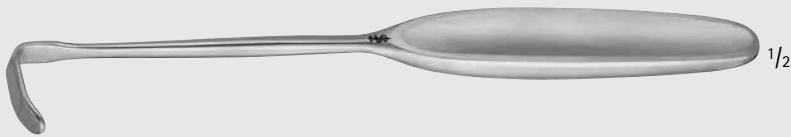
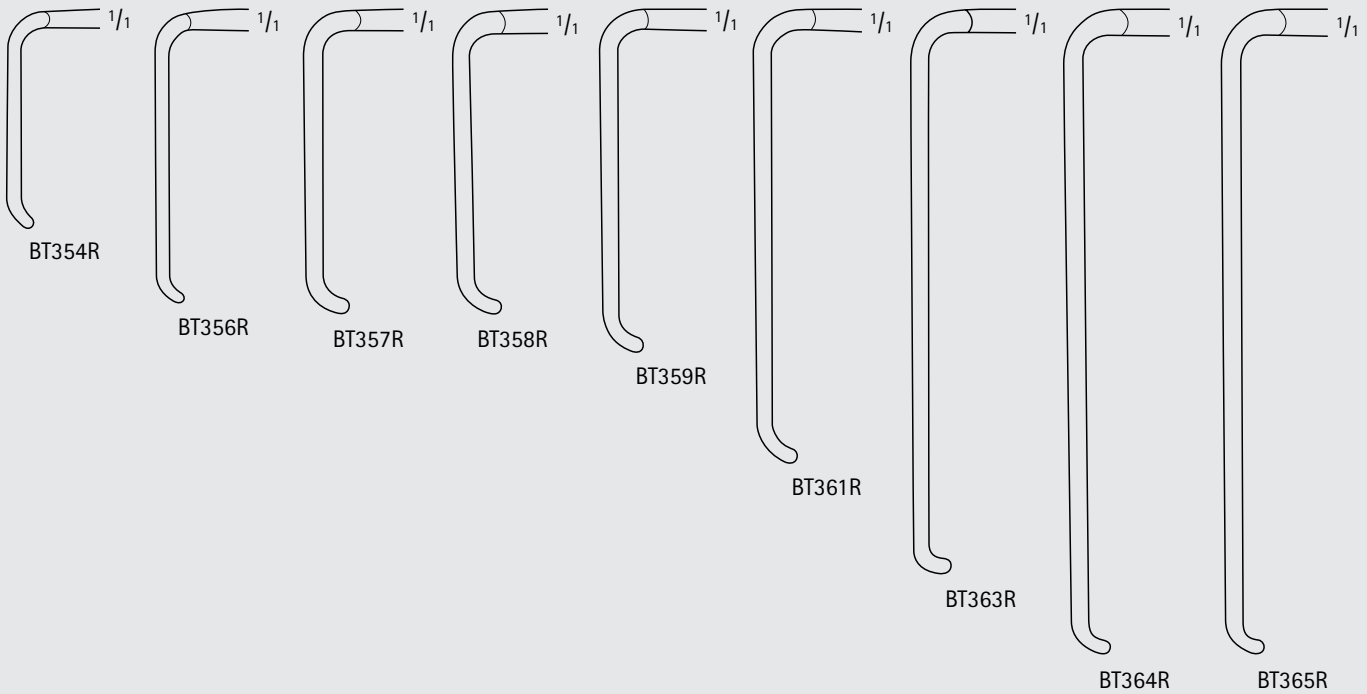

MB785R

**LAHEY Goiter Retractor**

Catalog Number	Blade Size (mm)	Length (in.)
MB785R	24 x 8	7 7/8



MB785R



INCHES

# General Surgery

## Hand Held Retractors



MB748R

### MCBURNEY Thyroid Retractor

Catalog Number	Blade Size (mm)	Length (in.)
MB748R	20 x 10	7 1/2



MB748R



BT404R-BT406R

### MIDDELDORPF Retractor

Catalog Number	Blade Size (mm)	Length (in.)
BT404R	15 x 15	8 3/4
BT405R	20 x 22	8 1/2
BT406R	28 x 28	9 1/4



BT404R

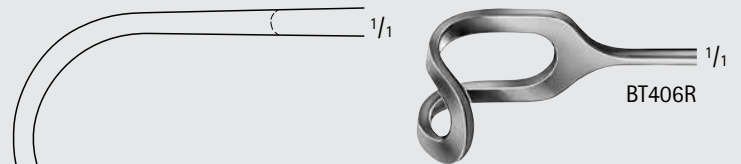

BT406R

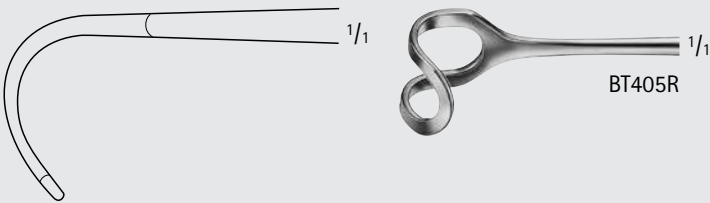

BT405R



BT408R

### GREENE Retractor

Catalog Number	Blade Size (mm)	Length (in.)
BT408R	28 x 22	8 7/8

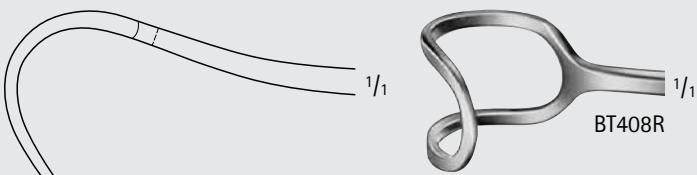

BT408R

# General Surgery

## Hand Held Retractors

GENERAL  
SURGERY



### DOCKHORN Cheek Retractor

Catalog Number	Blade Size (mm)	Length (in.)
D0438R	40 x 12	8 1/4
D0439R	55 x 14	8 1/4

D0438R-D0439R



D0438R



D0439R



INCHES

# General Surgery

## Abdominal Retractors



### HOESEL Retractor

Catalog Number	Blade Size (mm)	Length (in.)
BT442R	100 x 30	9 3/4
BT446R	220 x 40	9 3/4

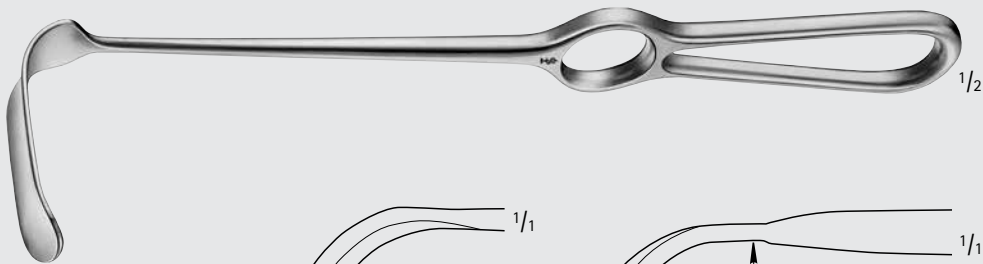

BT442R-BT446R

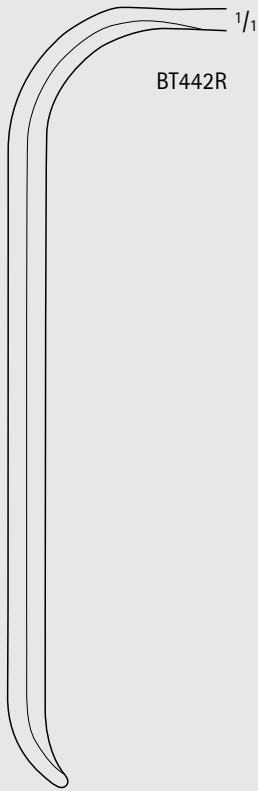

BT442R

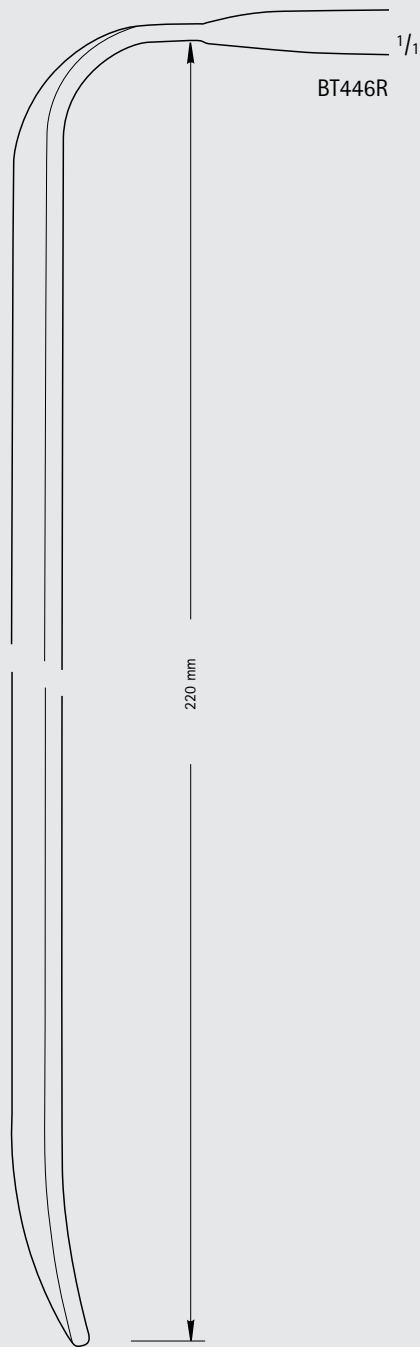

BT446R

220 mm

KOCHER Retractor

Catalog Number	Blade Size (mm)	Length (in.)
BT461R	80 x 42	9 3/4
BT462R	80 x 50	9 3/4
BT463R	80 x 60	9 3/4



BT461R-BT463R

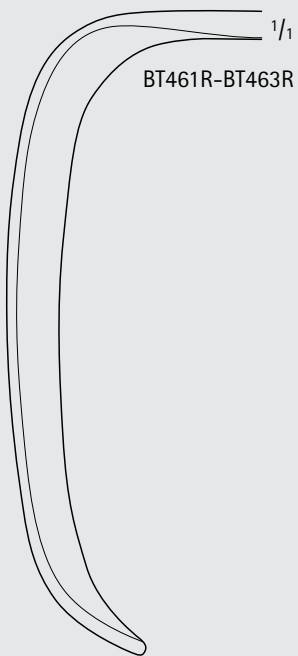

INCHES

# General Surgery

## Abdominal Retractors



BT464R

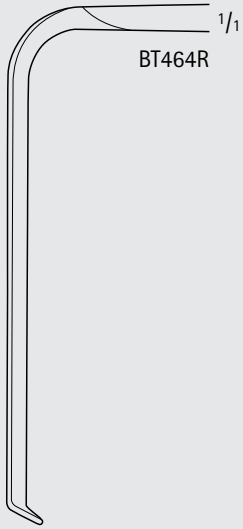

### KRAEMER Retractor

Catalog Number	Blade Size (mm)	Length (in.)
BT464R	66 x 10	8 1/4



BT465R



### CASPAR Retractor

Catalog Number	Blade Size (mm)	Length (in.)
BT465R	67 x 17	8 1/4



BT450R-BT469R

**MIASPAS® Mini ALIF LANGENBECK Retractor**

Catalog Number	Blade Size (mm)	Length (in.)
BT450R	125 x 20	8 1/4
BT451R	125 x 35	8 1/4
BT466R	80 x 20	8 1/4
BT467R	110 x 20	8 1/4
BT468R	80 x 35	8 1/4
BT469R	110 x 35	8 1/4

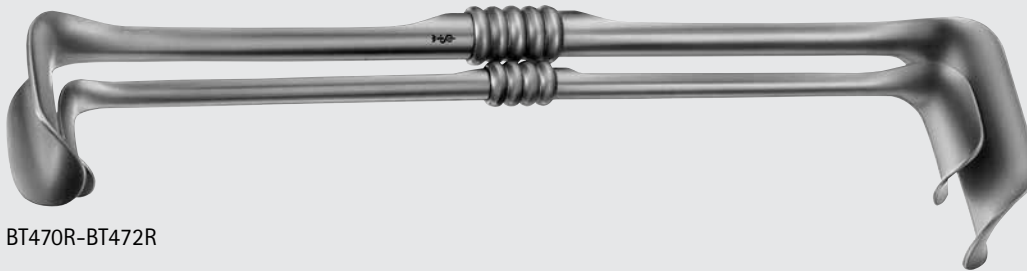

BT470R-BT472R

**RICHARDSON-EASTMAN Retractor**

Catalog Number	Description	Tip	Length (in.)
BT470R	2/SET (BT471R, BT472R)	-	-
BT471R	-	SM	9 3/4
BT472R	-	LRG	10 5/8

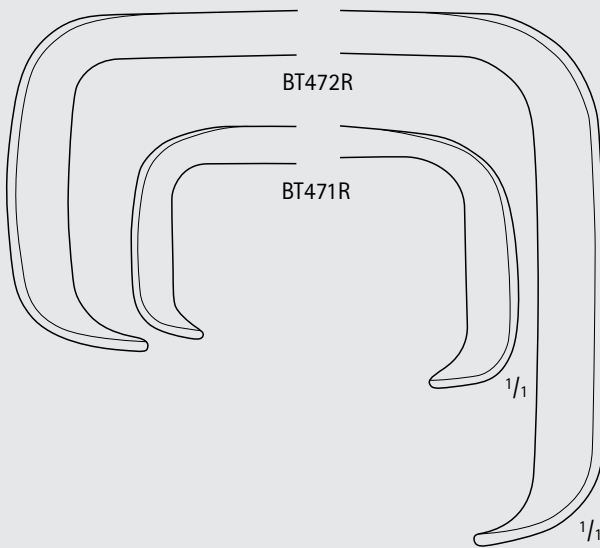

# General Surgery

## Abdominal Retractors



BT475R-BT477R

### RICHARDSON Retractor

Catalog Number	Blade Size (mm)	Blade Size (in.)	Length (in.)
BT475R	23 x 20	1 x 3/4	9 1/2
BT476R	30 x 29	1 1/4 x 1 1/8	9 1/2
BT477R	37 x 37	1 1/2 x 1 1/2	9 1/2
BT478R	47 x 21	2 x 3/4	9 1/2

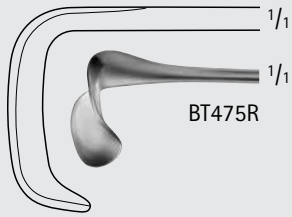

BT475R

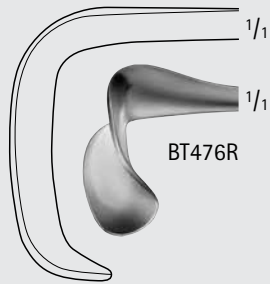

BT476R

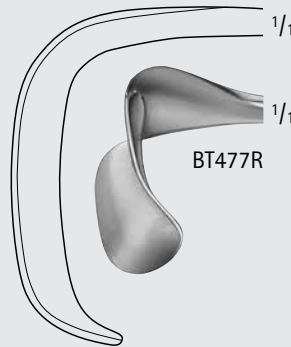

BT477R

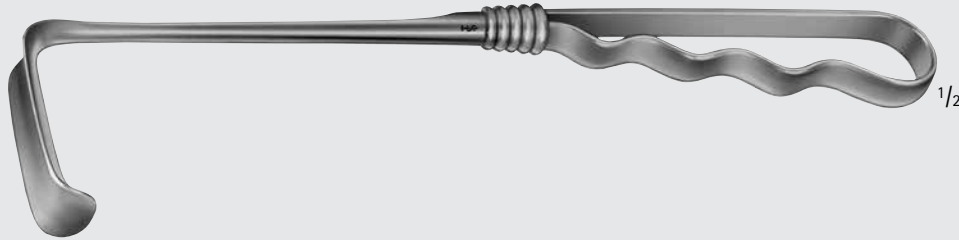

BT478R

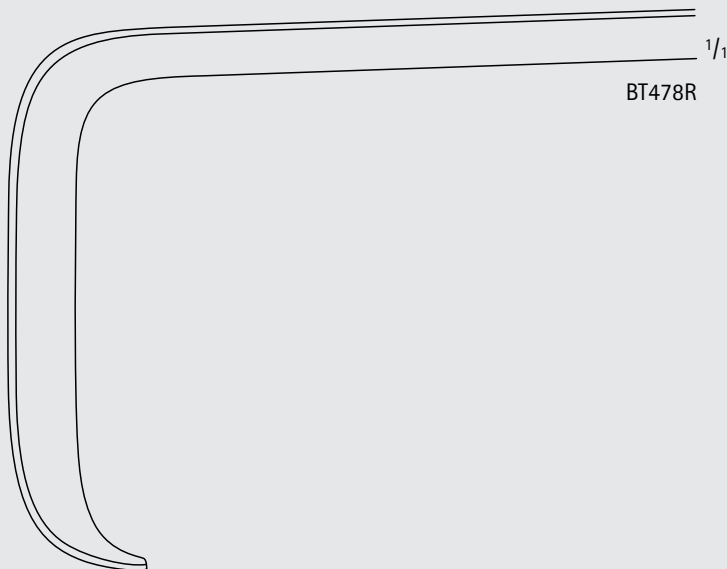

BT478R

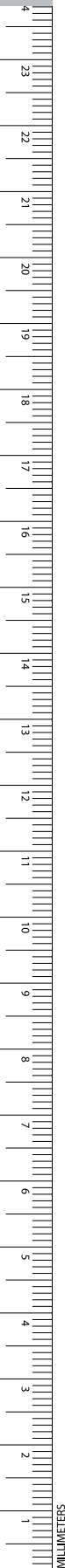

# General Surgery

## Abdominal Retractors

### RICHARDSON Retractor

Catalog Number	Blade Size (mm)	Blade Size (in.)	Length (in.)
BT479R	65 x 41	2 1/2 x 1 5/8	9 3/4

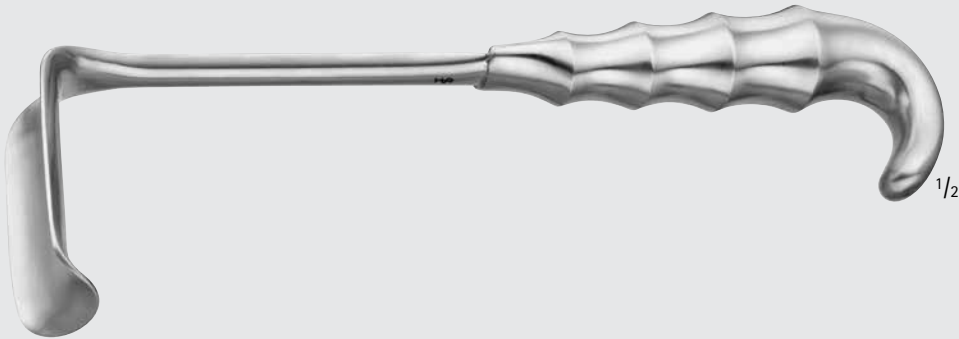

BT479R

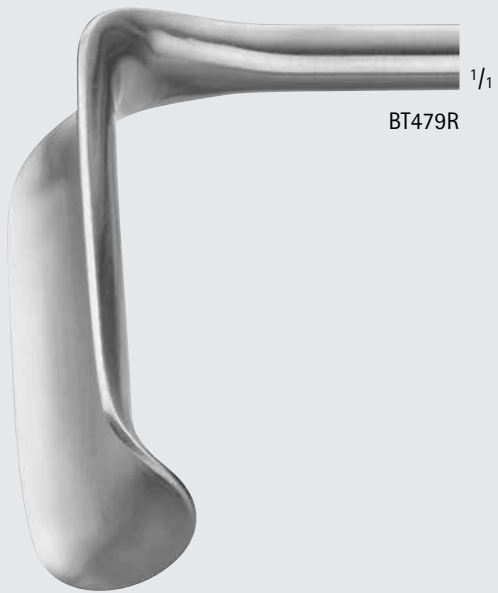

BT479R



General Surgery  
Abdominal Retractors

KELLY Retractor

Catalog Number	Blade Size (mm)	Blade Size (in.)	Length (in.)
BT481R	50 x 40	2 x 1 1/2	10 1/4
BT482R	64 x 54	2 1/2 x 2	10 1/4
BT483R	70 x 65	2 3/4 x 2 1/2	10 1/4
BT484R	90 x 76	3 1/2 x 3	10 1/4

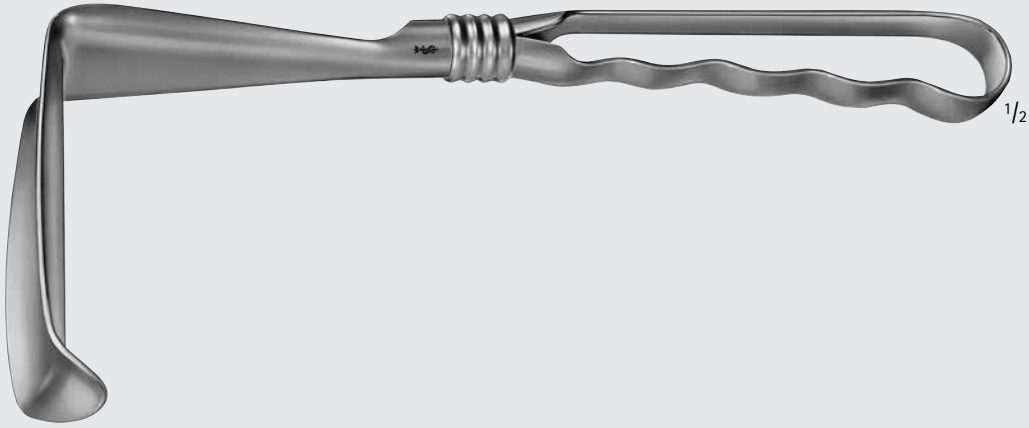

BT481R-BT484R



BT481R

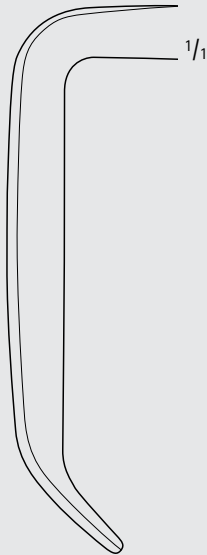

BT482R

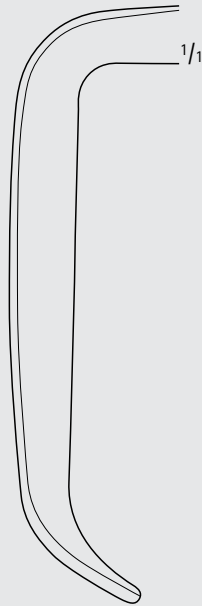

BT483R

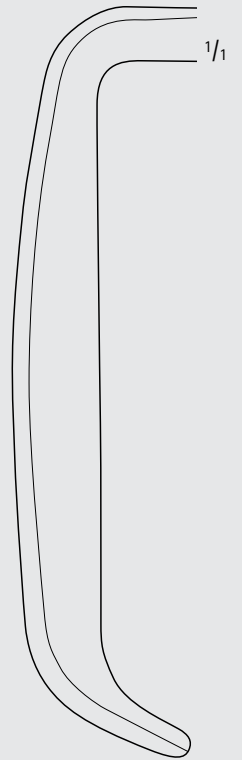

BT484R

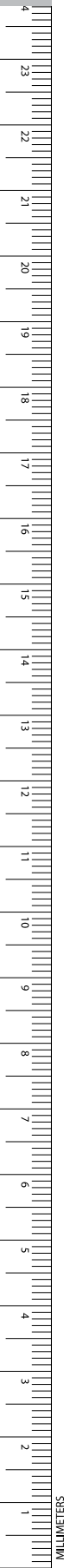

# General Surgery

## Abdominal Retractors

SAUERBRUCH Retractor, Open

Catalog Number	Blade Size (mm)	Length (in.)
BT514R	130 x 38	10 1/4

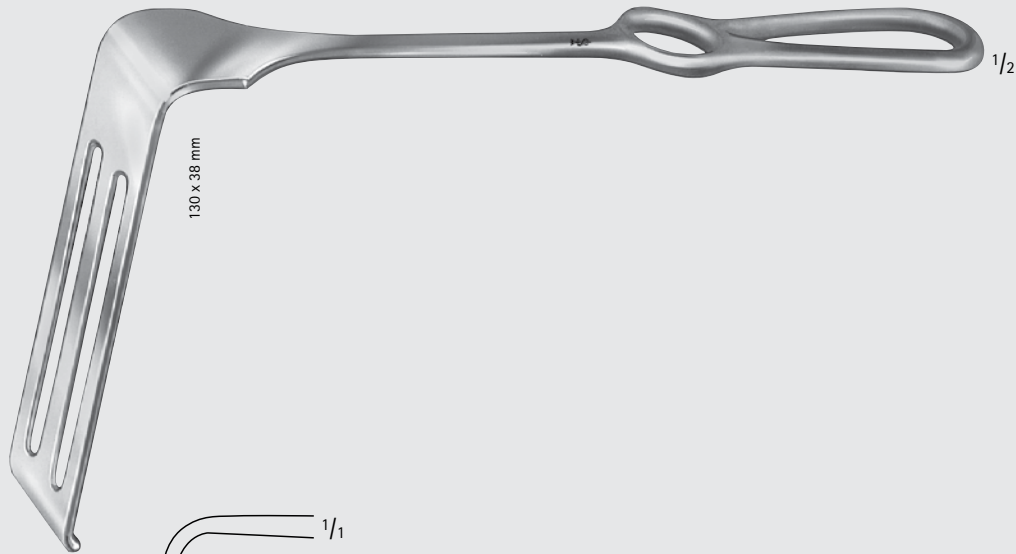

BT514R



BT514R



INCHES

General Surgery  
Abdominal Retractors

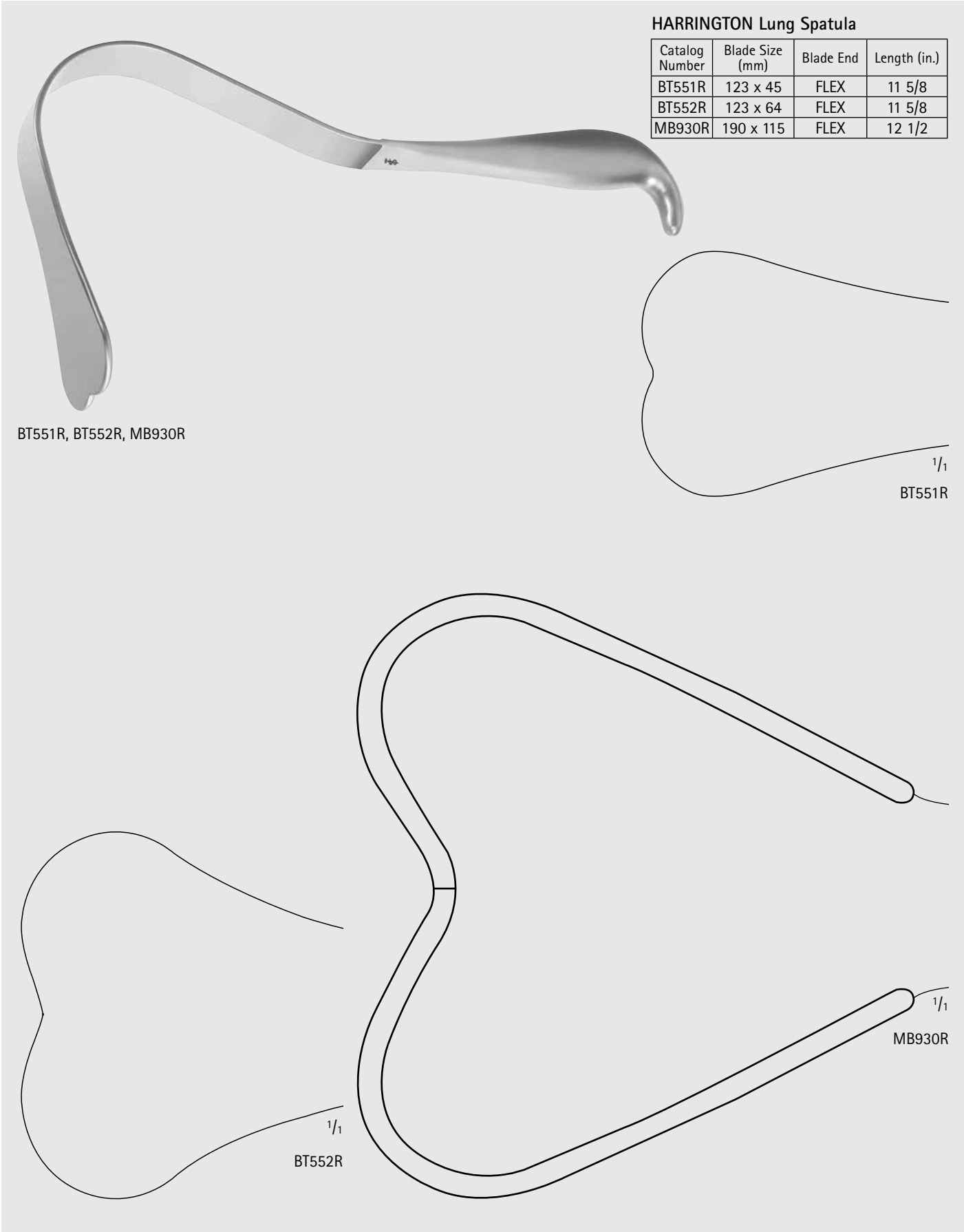
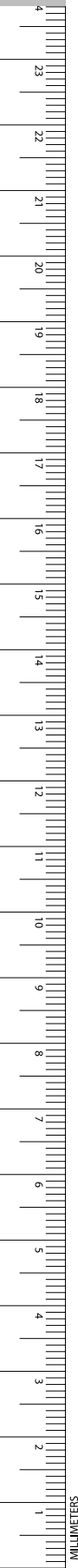

HARRINGTON Lung Spatula

Catalog Number	Blade Size (mm)	Blade End	Length (in.)
BT551R	123 x 45	FLEX	11 5/8
BT552R	123 x 64	FLEX	11 5/8
MB930R	190 x 115	FLEX	12 1/2

BT551R, BT552R, MB930R

BT551R

MB930R

BT552R

# General Surgery

## Abdominal Retractors

HARRINGTON Retractor, Large Blade

Catalog Number	Blade Size (mm)	Blade End	Length (in.)
MG472R	195 x 115	FLEX	14 3/8



MG472R

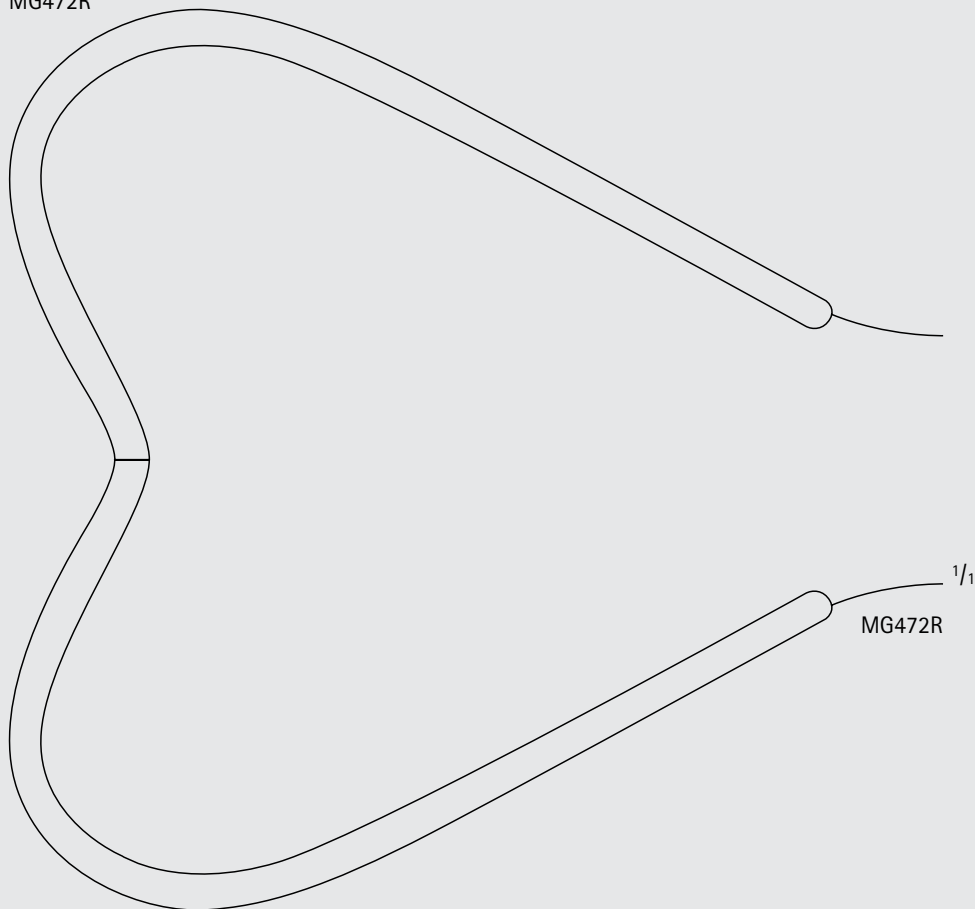

INCHES

# General Surgery

## Abdominal Retractors



### HARRINGTON-PEMBERTON Lung Spatula

Catalog Number	Blade Size (mm)	Blade End	Length (in.)
BT553R	175 x 64	FLEX	11 5/8



BT553R

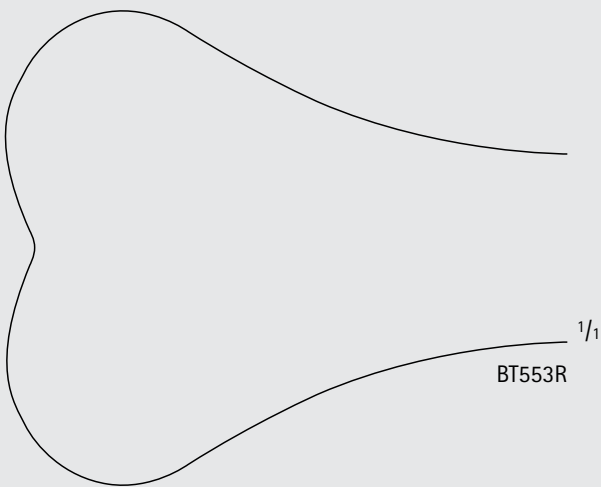

BT553R

ZENKER Retractor

Catalog Number	Blade Size (mm)	Length (in.)
BT594R	36 x 8	9 1/2
BT595R	60 x 12	10
BT596R	75 x 12	10 5/8
BT597R	120 x 12	11 1/2



BT594R-BT597R

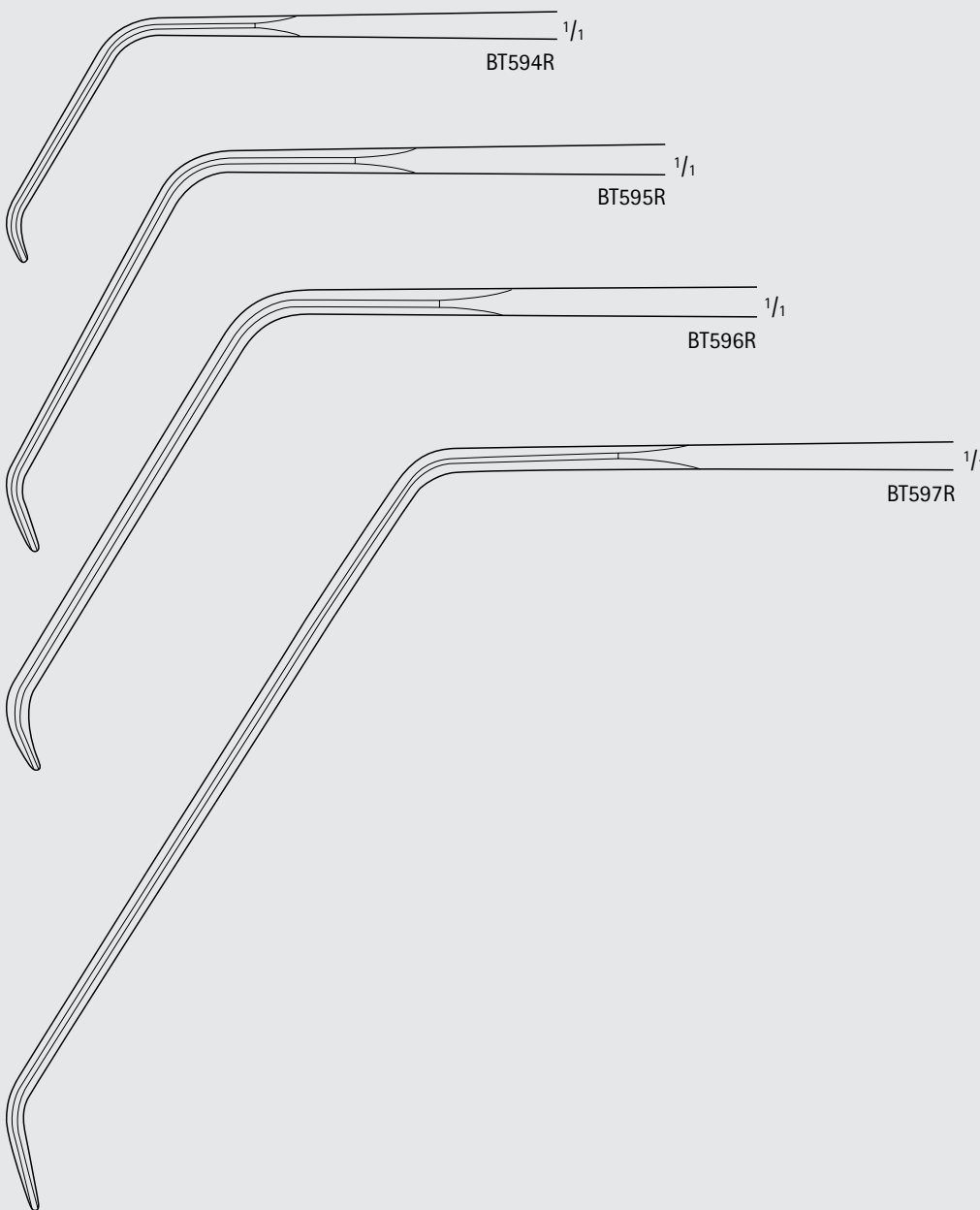

INCHES

# General Surgery

## Abdominal Retractors



BT600R

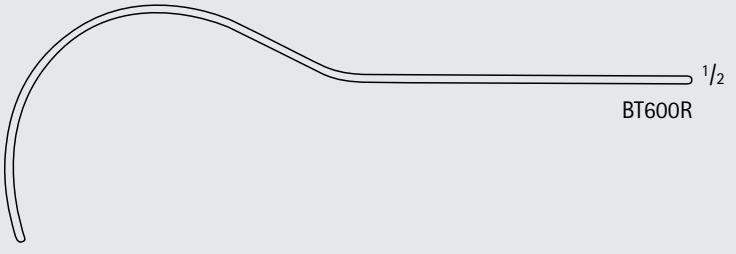

BT600R

### DEAVER Retractor

Catalog Number	Blade Size (mm)	Blade Size (in.)	Length (in.)
BT600R	19	3/4	7

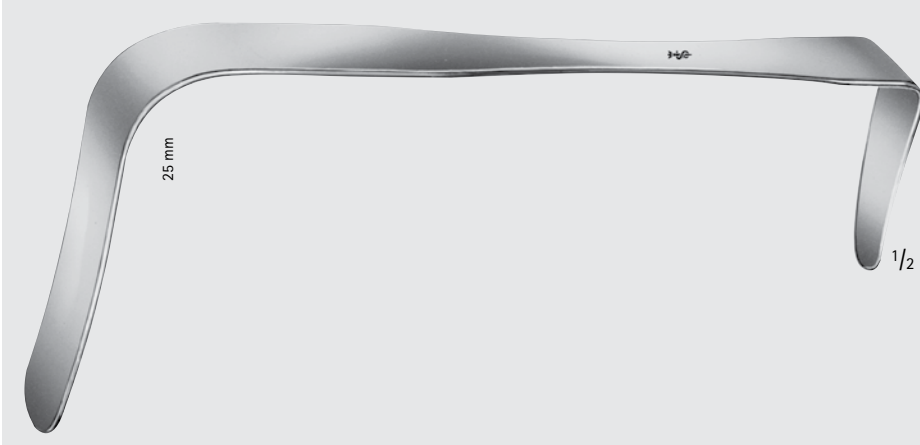

BT606R



BT606R

### DEAVER Retractor, Double Ended

Catalog Number	Blade Size (mm)	Blade Size (in.)	Length (in.)
BT606R	25	1	9 1/4

DEAVER Retractor

Catalog Number	Blade Size (mm)	Blade Size (in.)	Length (in.)
BT601R	22	7/8	8 1/2
BT602R	25	1	11 3/4
BT603R	25	1	12 3/8



BT601R

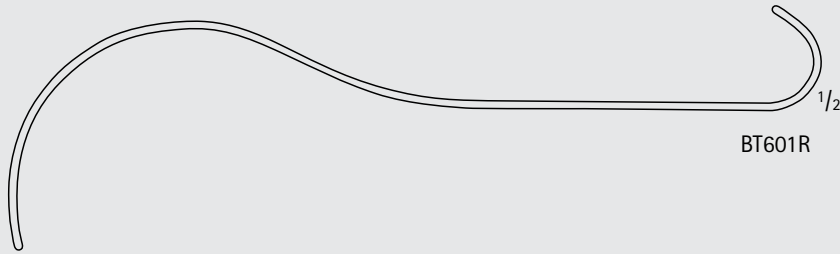

BT601R



BT602R-BT603R

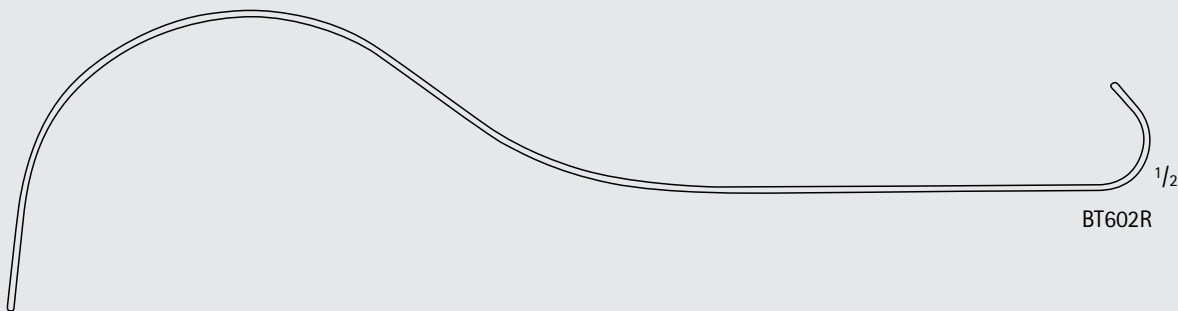

BT602R

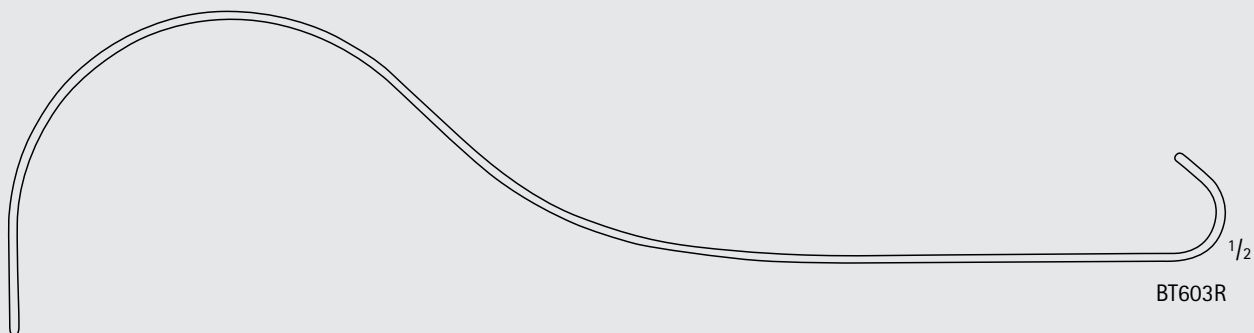

BT603R



INCHES

General Surgery  
Abdominal Retractors



DEAVER Retractor  
(continued)

Catalog Number	Blade Size (mm)	Blade Size (in.)	Length (in.)
BT604R	38	1 1/2	11 3/4



BT604R

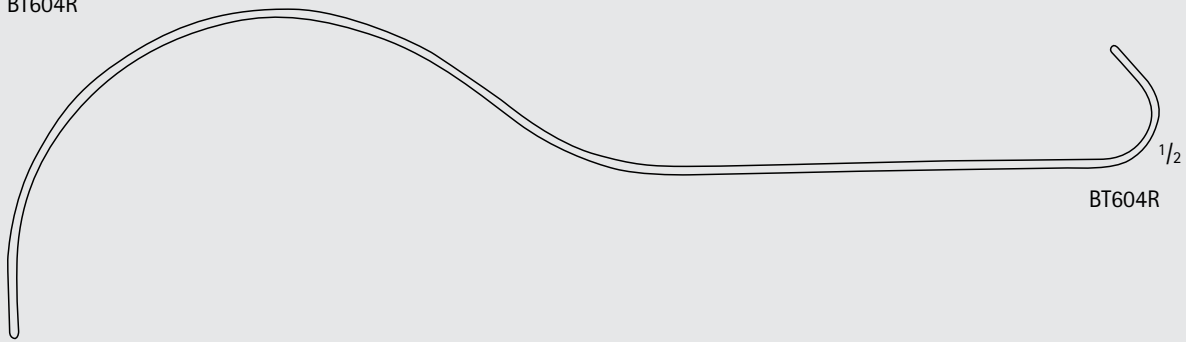

BT604R

DEAVER Retractor  
(continued)

Catalog Number	Blade Size (mm)	Blade Size (in.)	Length (in.)
BT605R	50	2	12 1/4
BT607R	25	1	14 3/8

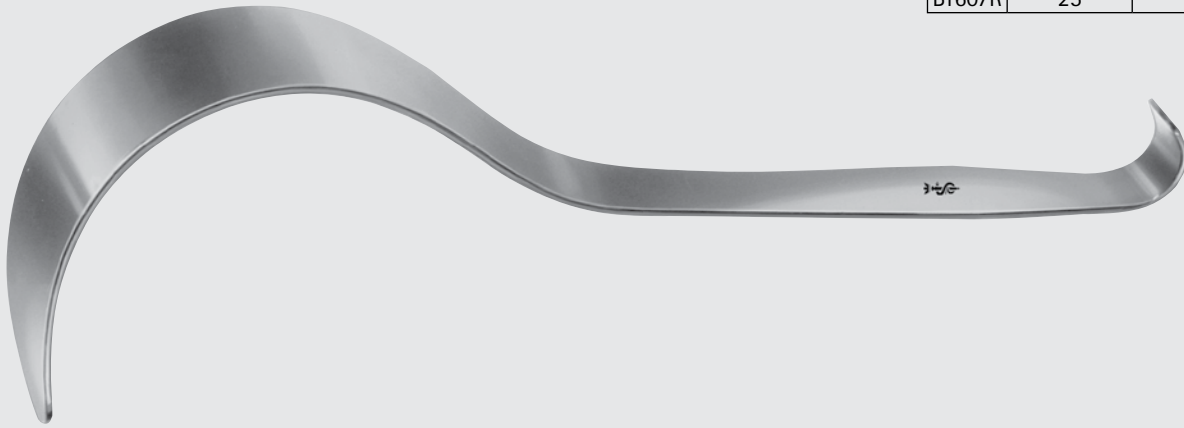

BT605R-BT607R

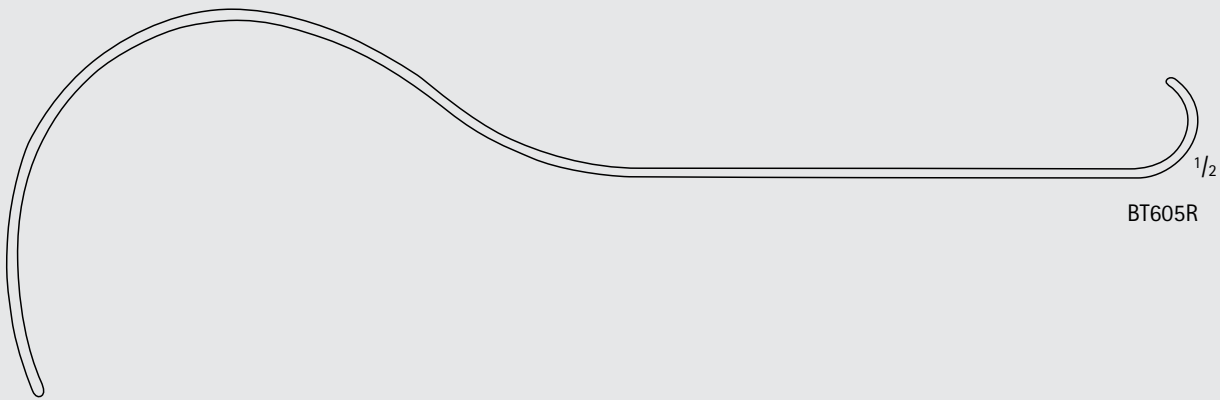

BT605R

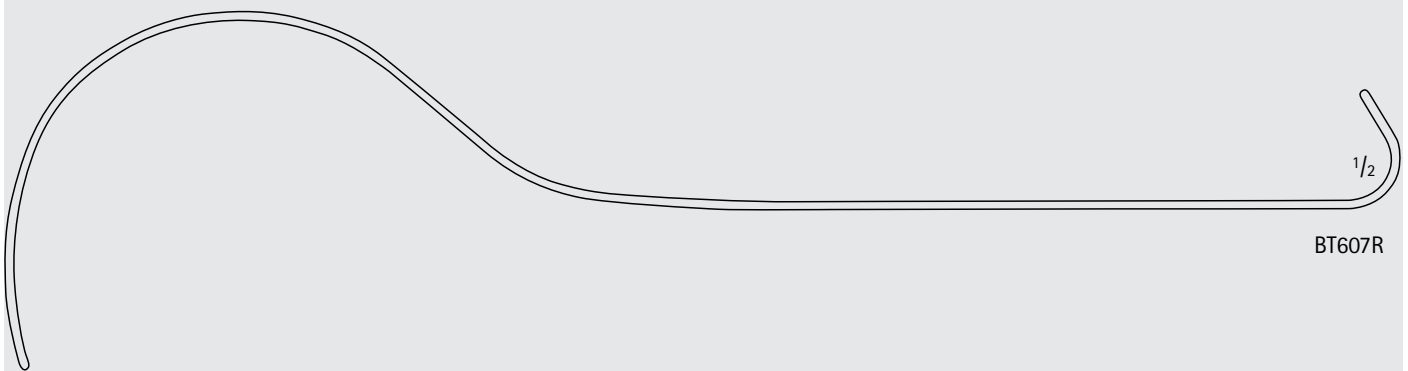

BT607R



INCHES

General Surgery  
Abdominal Retractors

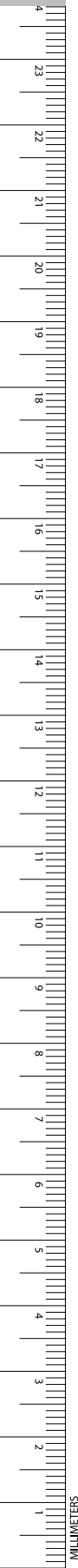

DEAVER Retractor  
(continued)

Catalog Number	Blade Size (mm)	Blade Size (in.)	Length (in.)
BT608R	75	3	12 1/2

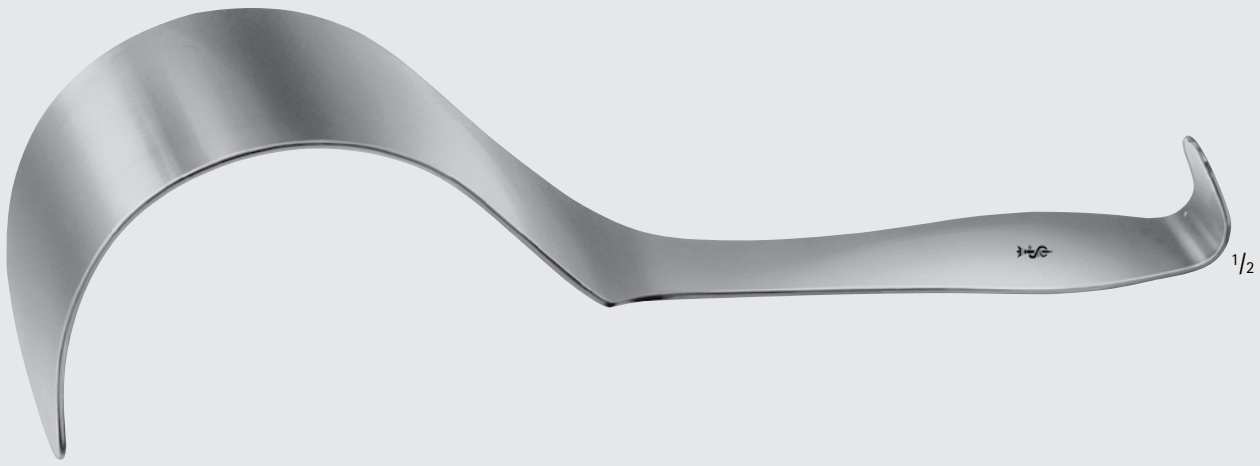

BT608R

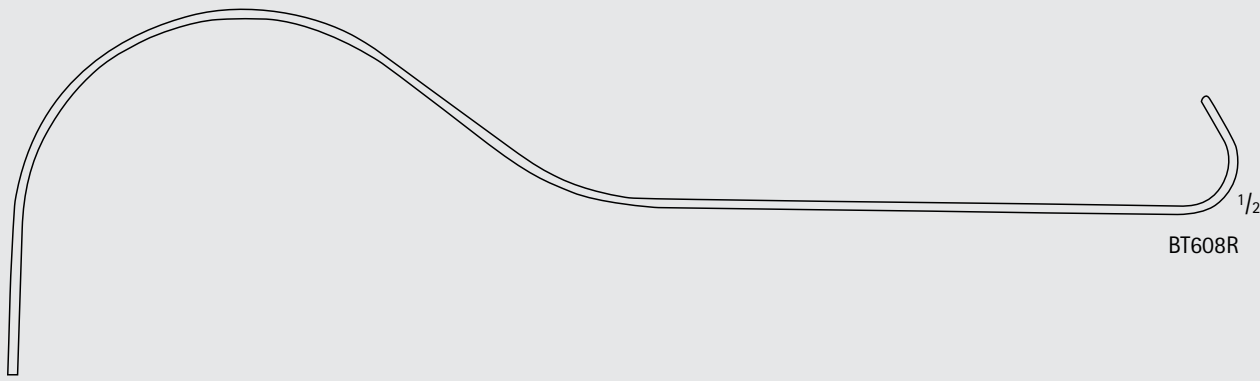

BT608R

DEAVER Retractor, W/ Grip

Catalog Number	Blade Size (mm)	Blade Size (in.)	Length (in.)
BT611R	25	1	12 1/4
BT613R	38	1 1/2	12 1/4
BT614R	50	2	12
BT615R	75	3	12 1/4



BT611R-BT615R

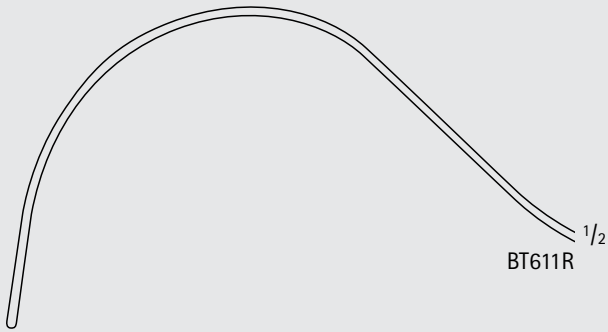

BT611R

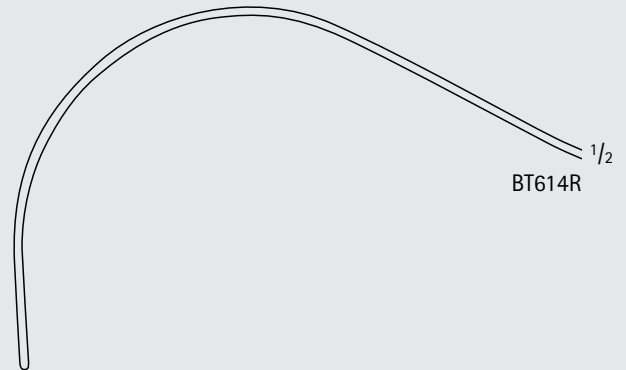

BT614R

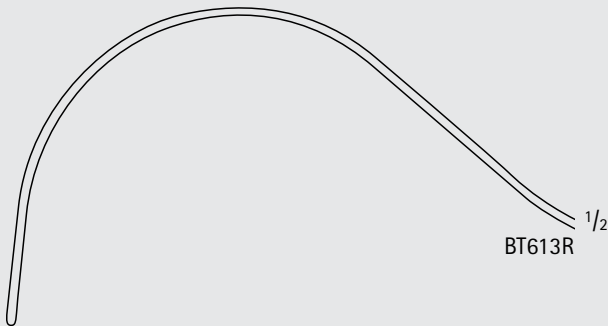

BT613R

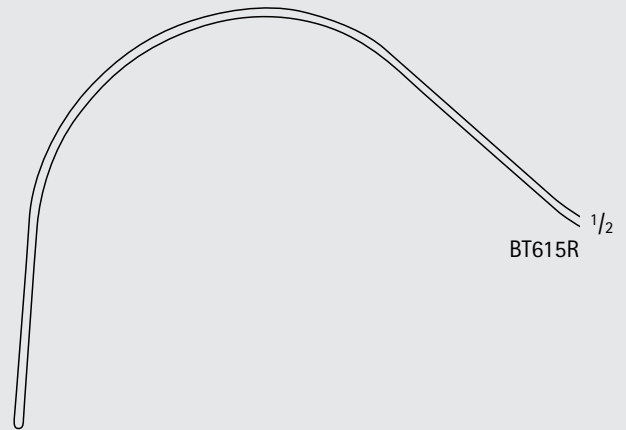

BT615R



# General Surgery

## Abdominal Retractors

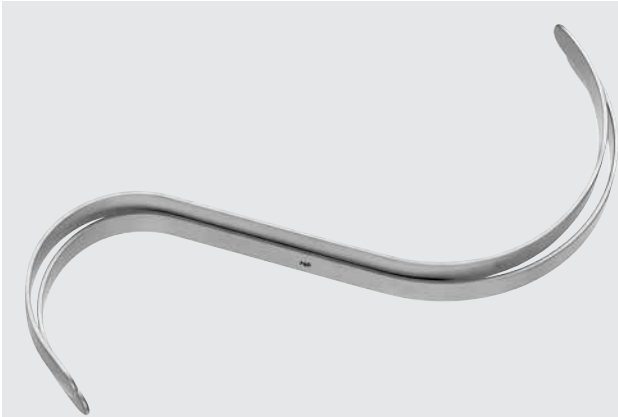

MD071R-MD076

### HASSON "S" Retractor, 2/Set

Catalog Number	Blade	Blade Size (mm)	Length (in.)
MD076	MALLEABLE	10	6 1/4
MD077	MALLEABLE	13	7
MD071R	RIGID	10	7 1/8
MD072R	RIGID	13	7 1/8

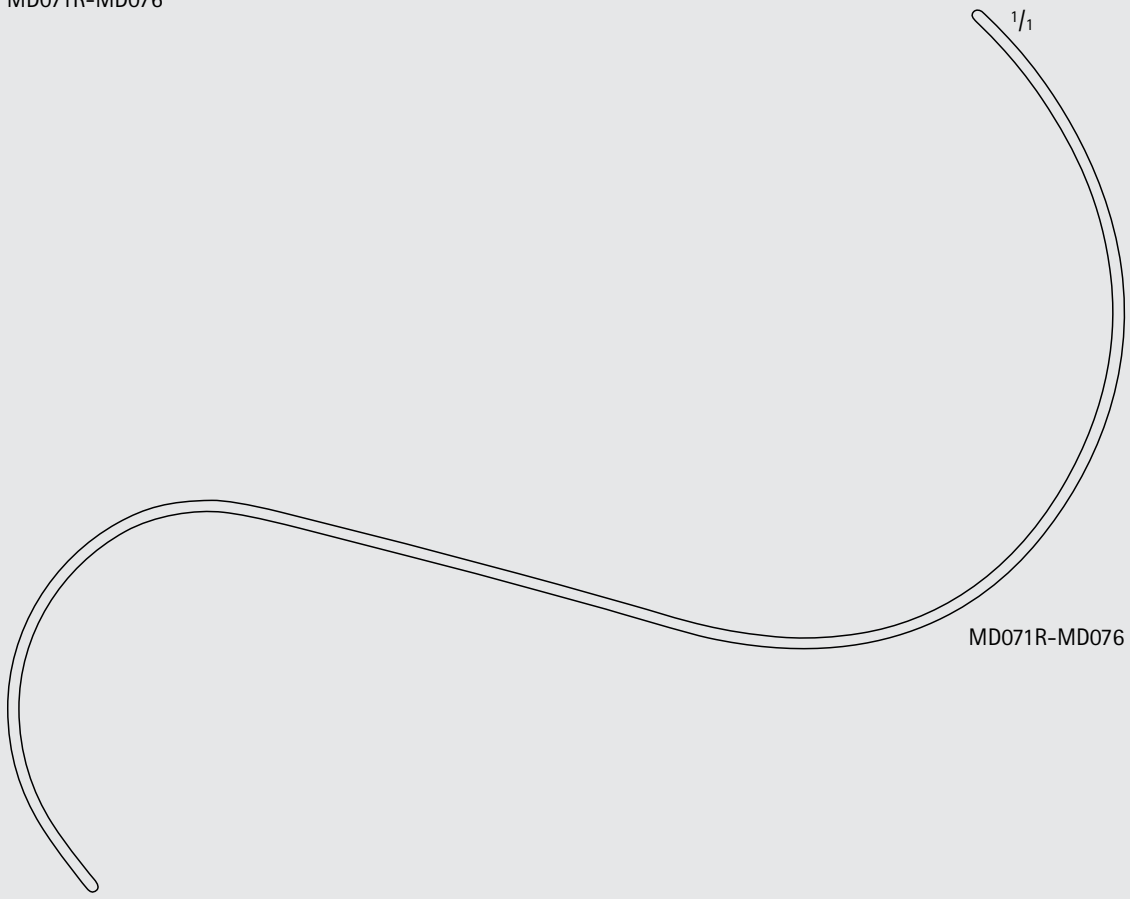

MD071R-MD076



BT750R

**TUFFIER Spatula, Malleable**

Catalog Number	Blade Size (mm)	Blade Size (in.)	Length (in.)
BT750R	17 / 25	3/4 / 1	7 7/8



BT751R-BT763R, MD498, MG480R-MG484R

**Ribbon Spatula, Malleable**

Catalog Number	Blade Size (mm)	Blade Size (in.)	Length (in.)
MG480R	5	1/8	8
BT751R	12	1/2	7 7/8
BT752R	17	3/4	7 7/8
MG481R	25	1	8
BT755R	25	1	9 3/4
MD498	75	3	13
MG482R	20	3/4	13
BT756R	25	1	13
BT761R	30	1 1/4	13
BT762R	40	1 1/2	13
BT763R	50	2	13
MG483R	65	2 1/2	13
MG484R	100	4	13



BT758R

**HABERER Spatula, Malleable**

Catalog Number	Blade Size (mm)	Blade Size (in.)	Length (in.)
BT758R	40 / 50	1 1/2 / 2	12



MG374R



MG374R

**Spatula and Packer, Double Ended**

Catalog Number	Length (in.)
MG374R	5 3/4



INCHES

General Surgery  
Abdominal Retractors

DOYEN Abdominal Retractor

Catalog Number	Blade Size (mm)	Length (in.)
BT667R	53 x 80	9 3/4
BT669R	72 x 82	10 1/4



BT667R



BT669R

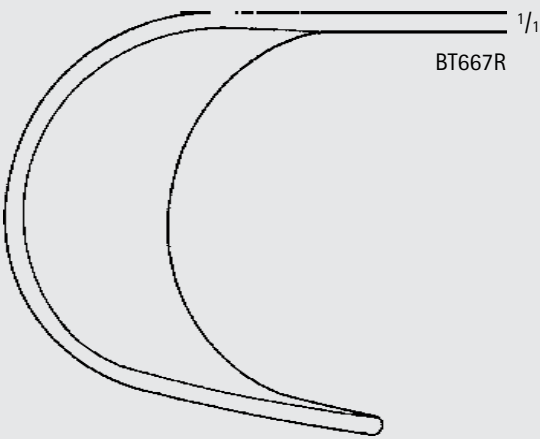

BT667R

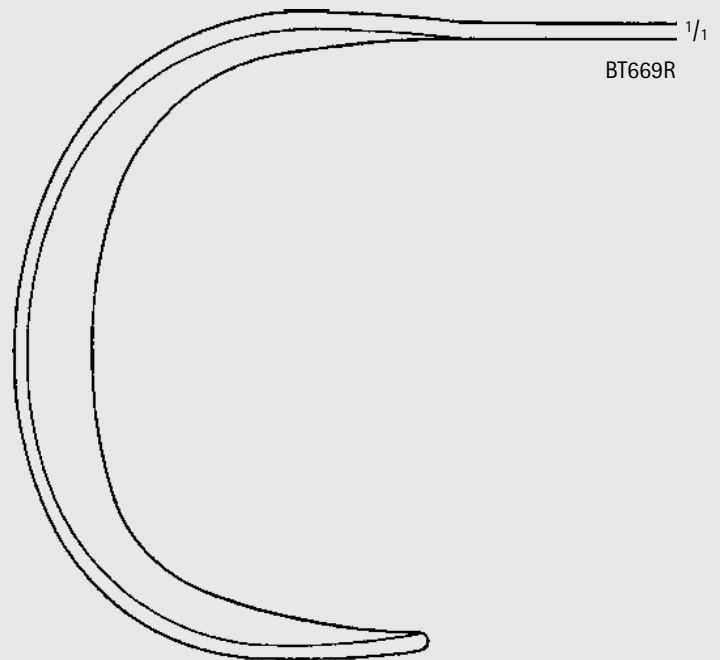

BT669R

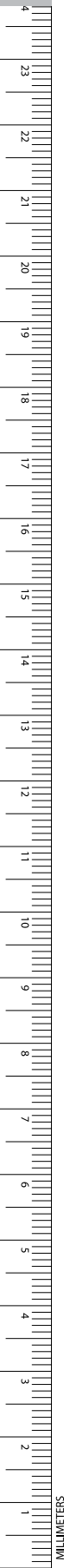

# General Surgery

## Abdominal Retractors

GENERAL  
SURGERY

### WEINBERG Vagotomy Retractor, Joe's Hoe

Catalog Number	Blade Size (mm)	Length (in.)
MG491R	47 x 57 / 93 x 157	9



MG491R



General Surgery  
Abdominal Retractors

ST. MARKS Pelvis Retractor

Catalog Number	Blade Size (mm)	Length (in.)
BT670R	124 x 60	11 1/2
BT672R	174 x 60	13

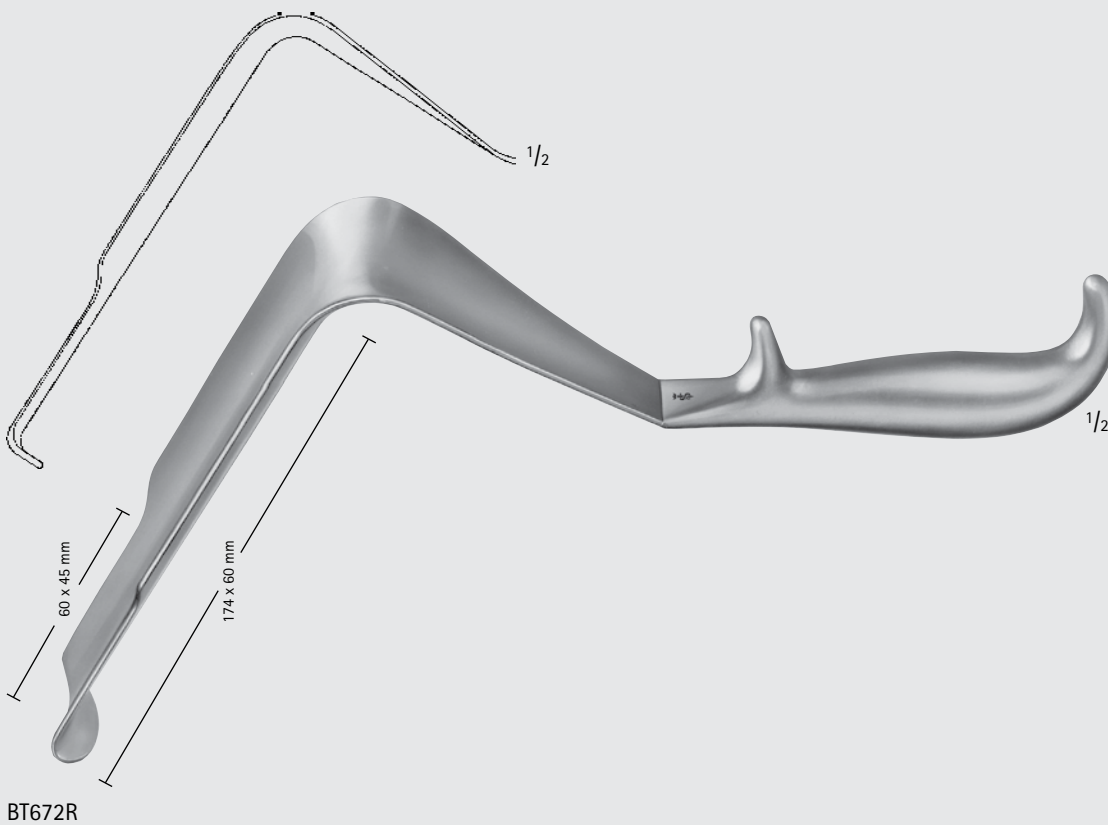
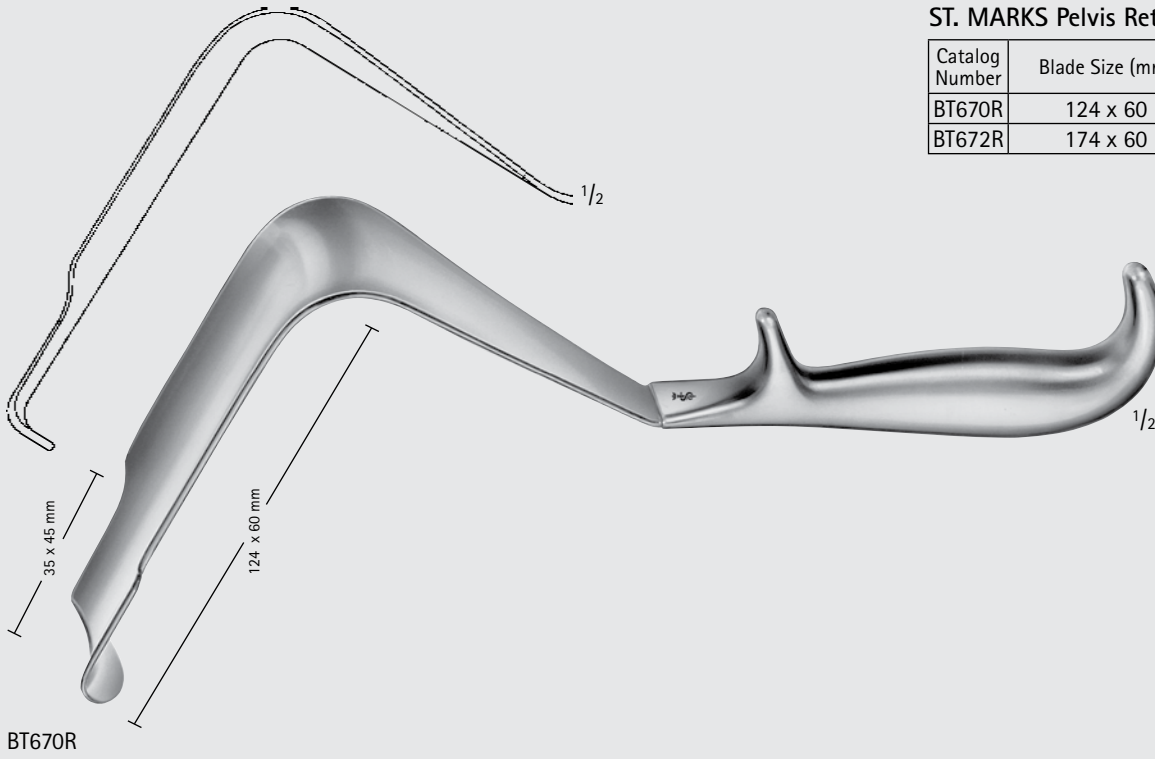

ST. MARKS Pelvis Retractor  
(continued)

Catalog Number	Blade Size (mm)	Length (in.)
BT674R	178 x 60	13

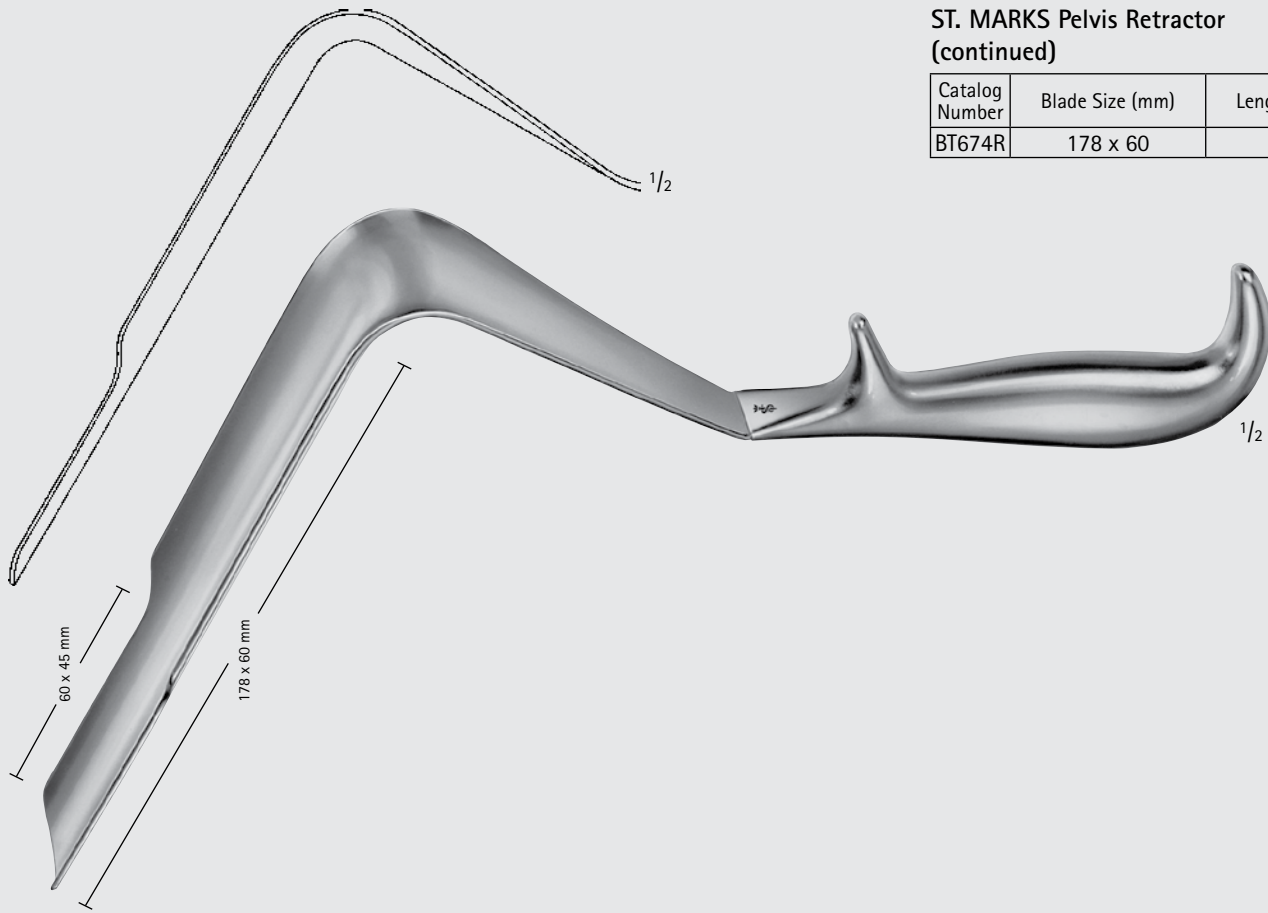

BT674R



General Surgery  
Abdominal Retractors

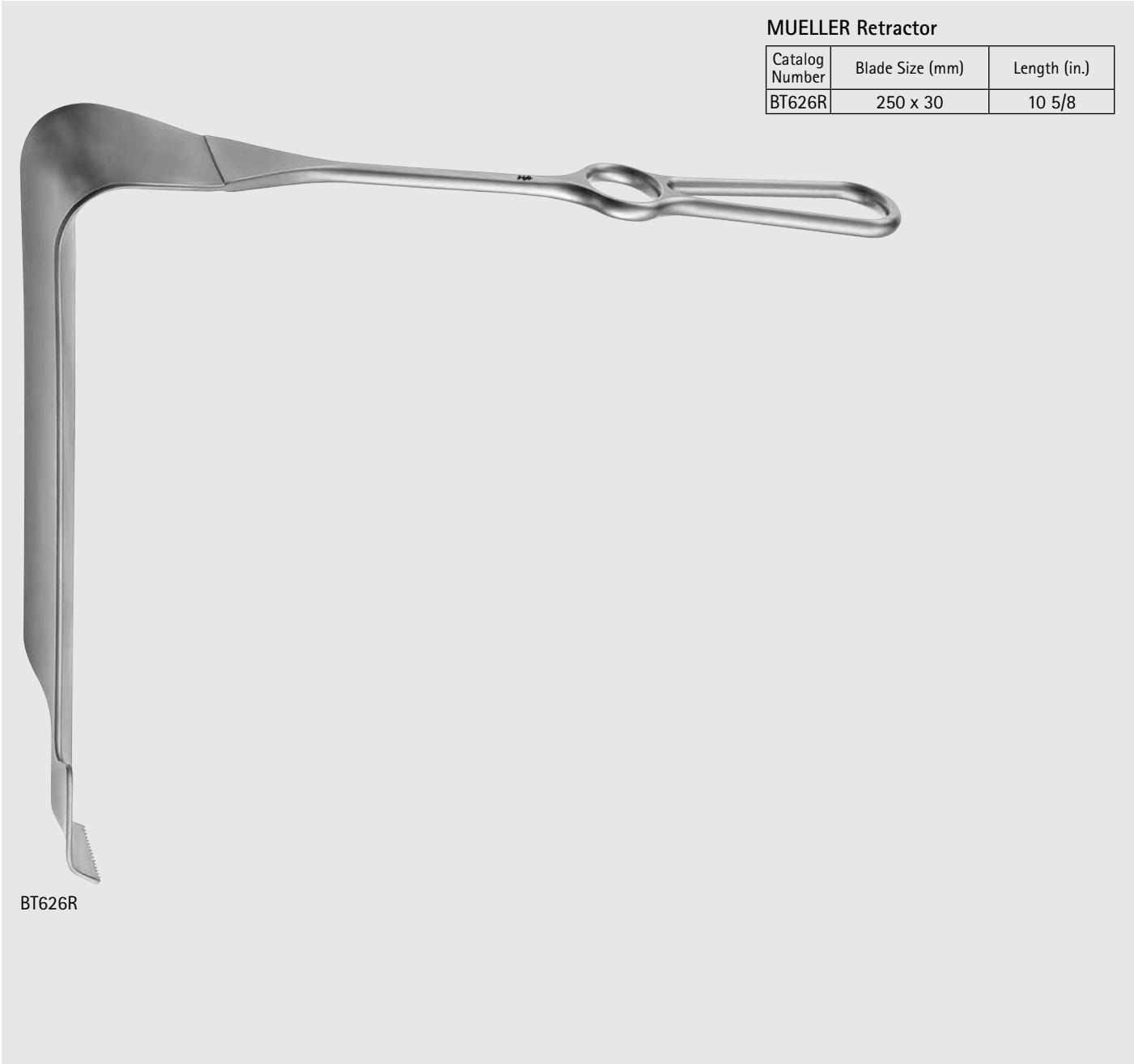
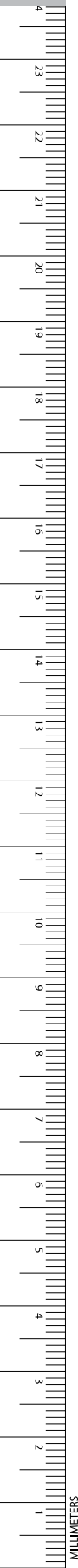

MUELLER Retractor

Catalog Number	Blade Size (mm)	Length (in.)
BT626R	250 x 30	10 5/8

BT626R



MAYO-COLLINS Appendectomy Retractor

Catalog Number	Length (in.)
MB129R	6 3/4

MB129R

1/2

# General Surgery

## Abdominal Retractors

### ROCHARD Retractor Mounting Frame, F/ BT711R-BT715R

Catalog Number	Mounting Arms
BT708R	DOUBLE
BT709R	SINGLE

Mounting frame for fastening to the lateral bars of the operating tables, can be dismantled for decontamination and sterilization.

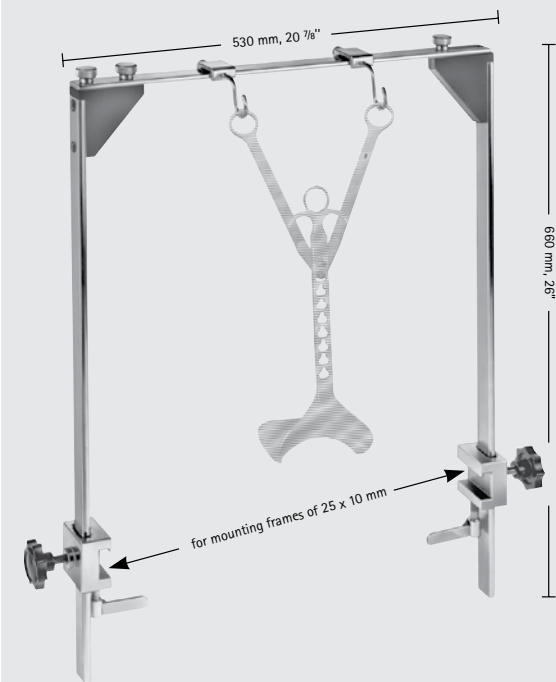

BT708R-BT709R

### ROCHARD Fixation Device, F/ BT711R-BT715R

Catalog Number	Length (mm)	Length (in.)
BT710R	190	7 1/2

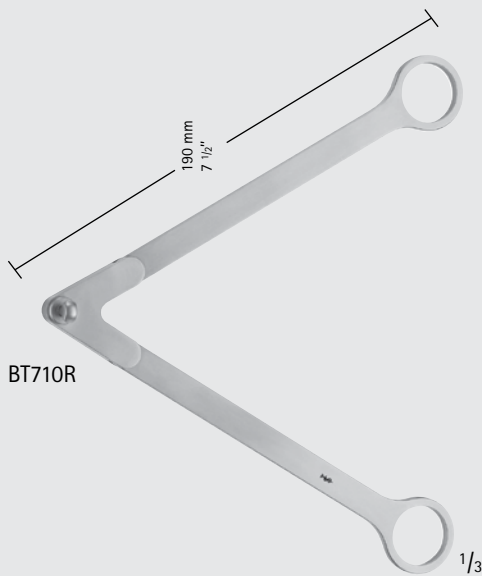

BT710R

### ROCHARD Blades

Catalog Number	Blade Size (mm)	Length (in.)
BT711R	48 x 90	12 1/4
BT712R	48 x 105	12 1/4
BT713R	48 x 120	12 1/4
BT714R	48 x 135	12 1/4
BT715R	48 x 155	12 1/4

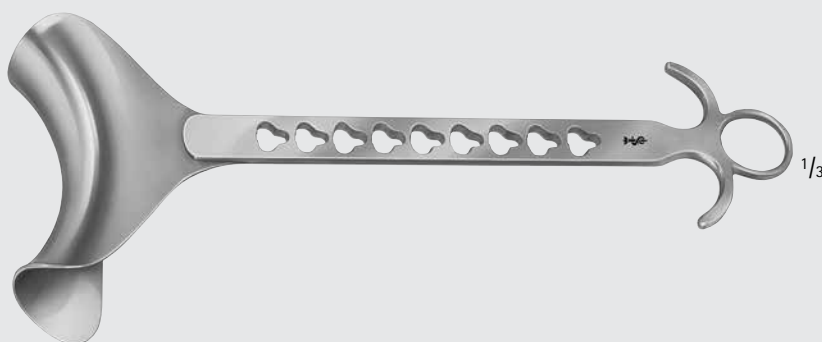

BT711R-BT715R



General Surgery  
Abdominal Retractors

Abdominal Retractor, Malleable, W/ Handle

Catalog Number	Blade Size (mm)	Blade Size (in.)	Length (in.)
BT773R	30	1 1/4	16 1/8
BT774R	40	1 1/2	16 1/8
BT775R	50	2	16 1/8
BT776R	60	2 1/2	16 1/8
BT777R	70	2 3/4	16 1/8



BT773R-BT777R

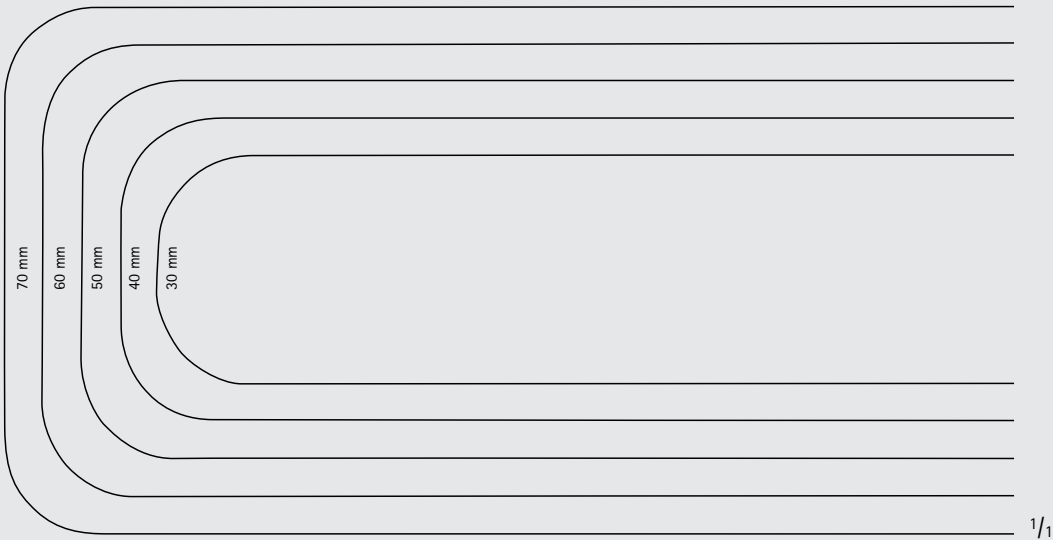

BT773R-BT777R

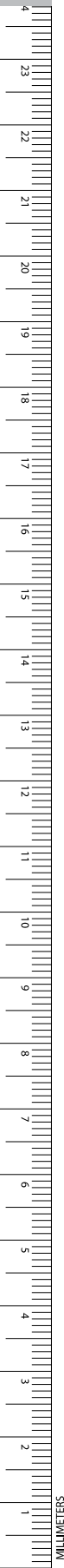



MB226, MG582R-MG586R

Laparotomy Ring

Catalog Number	Diameter (in.)
MG582R	1 1/2
MG585R	1 3/4
MB226	2
MG586R	3

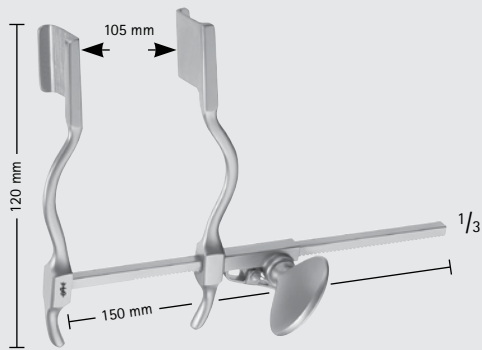

BV512R

HERTZLER Abdominal Retractor

Catalog Number	Blade Size (mm)
BV512R	20 x 25



INCHES

General Surgery  
Abdominal Retractors

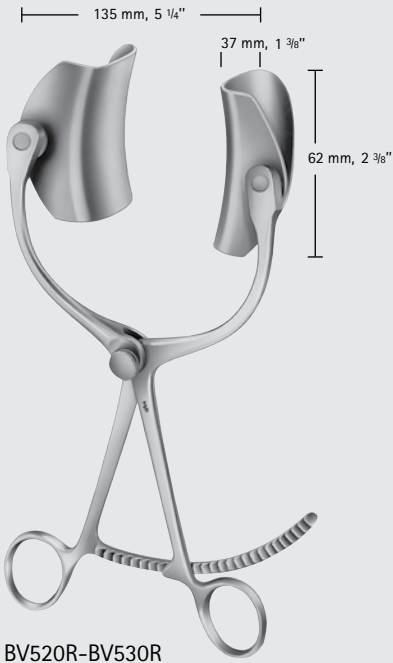

BV520R-BV530R



BV551R

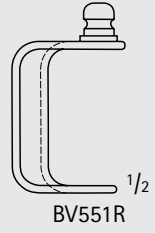

BV551R 1/2

**COLLIN Abdominal Retractor W/ Ball Snap Closure**

Catalog Number	Description
BV530R	SET COMPLETE
BV520R	SPREADER ONLY
BV551R	LATERAL BLADES, Pair, 37 x 62 MM



BV399R

**Blade Ejector**

Catalog Number	Description	Length (in.)
BV399R	FOR CHANGING BLADES WITH BALL SNAP CLOSURE	4 1/2

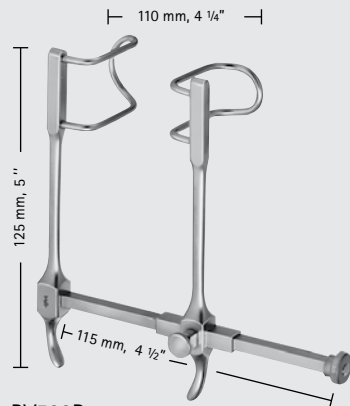

BV500R

GOSSET Abdominal Retractor, Small

Catalog Number	Blade Depth (mm)
BV500R	38

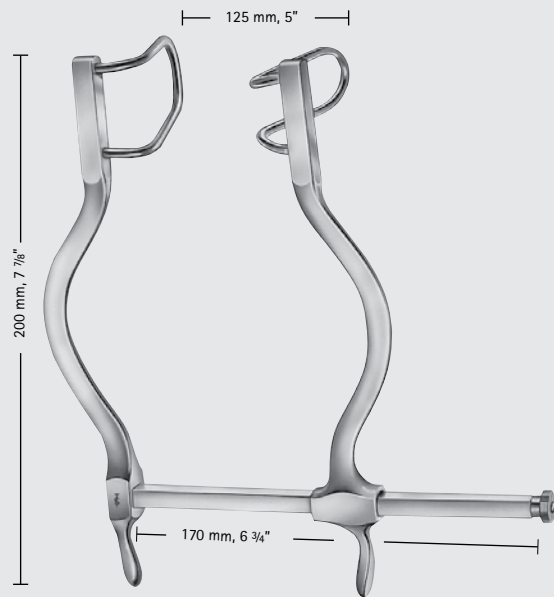

BV502R

GOSSET Abdominal Retractor, Medium

Catalog Number	Blade Depth (mm)
BV502R	55



# General Surgery

## Abdominal Retractors

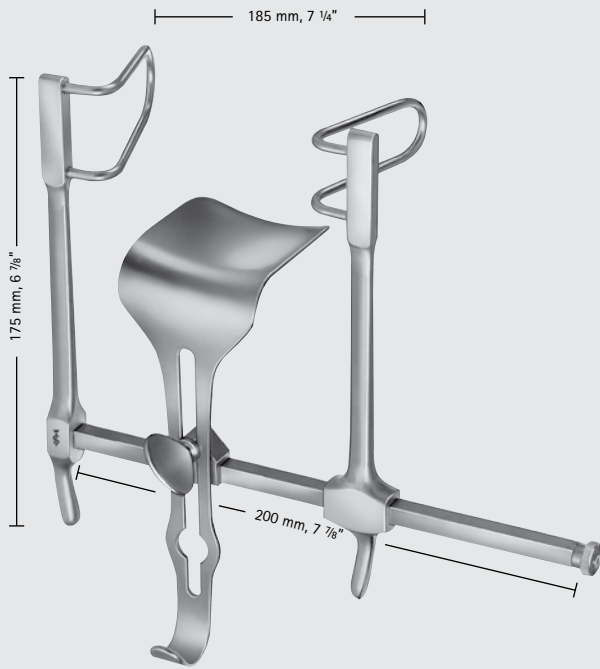

BV505R-BV506R

### GOSSET Abdominal Retractor, Large

Catalog Number	Description
BV505R	SET COMPLETE
BV506R	CENTER BLADE ONLY 59 x 57 MM

BV505R Includes:  
1 Center Blade BV506R

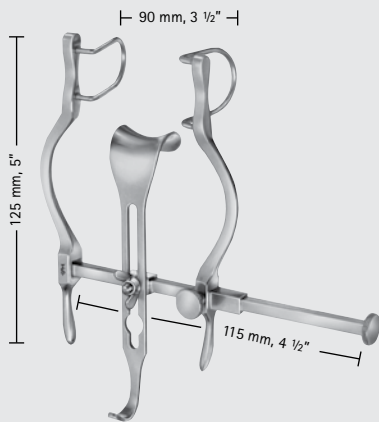

BV601R-BV602R

### BALFOUR Baby Abdominal Retractor

Catalog Number	Description
BV601R	SET COMPLETE
BV602R	CENTER BLADE ONLY, 21 x 24 MM

BV601R Includes:  
1 Center Blade BV602R

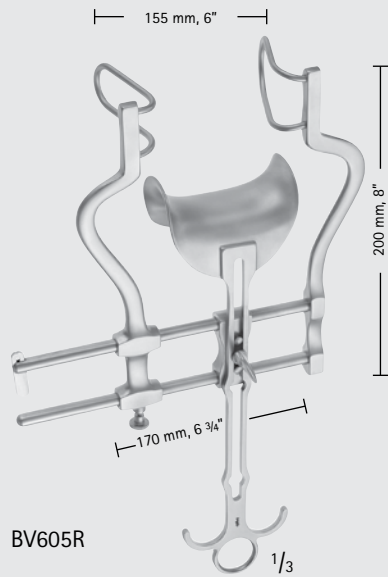

**BALFOUR Abdominal Retractor**

Catalog Number	Description	Lateral Blades Depth (mm)
BV605R	BALFOUR RETRACTOR, 200 x 155 MM	60
BV608R	BALFOUR RETRACTOR, 200 x 235 MM	60
BV610R	BALFOUR RETRACTOR, 200 x 265 MM	90
BV606R	CENTER BLADE, 47 x 80 MM	-
BV609R	CENTER BLADE, 62 x 76 MM	-
BV611R	CENTER BLADE, 80 x 80 MM	-

BV605R includes BV606R  
 BV608R includes BV609R  
 BV610R includes BV611R

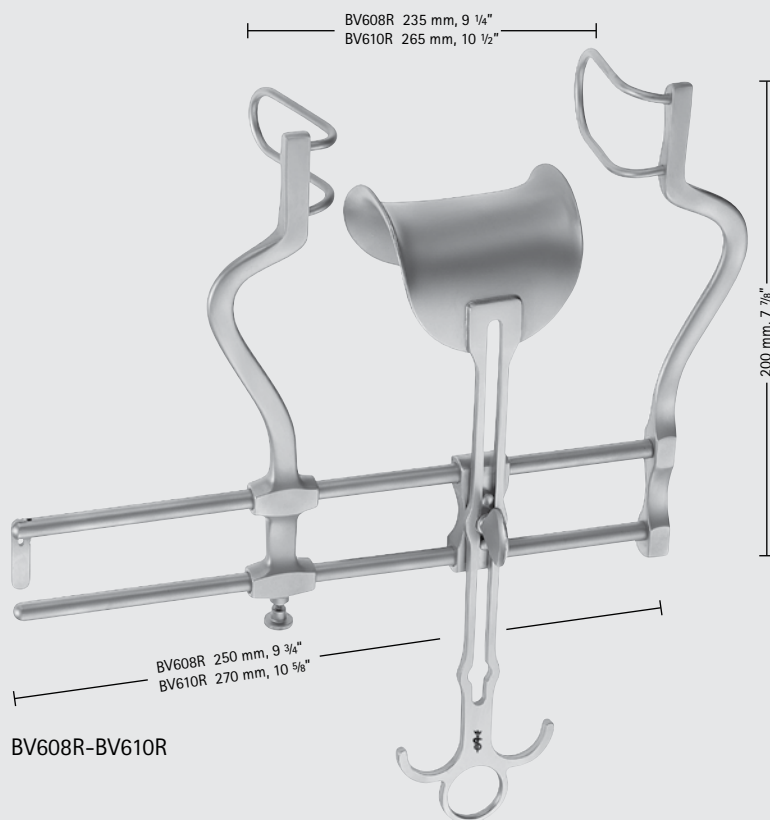

# General Surgery

## Abdominal Retractors

GENERAL SURGERY

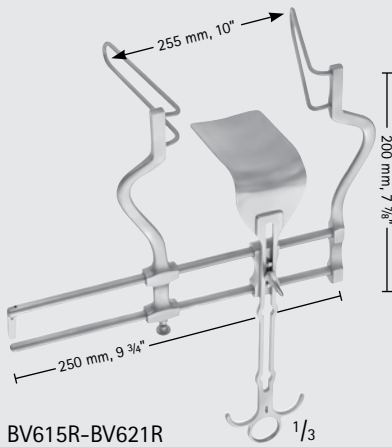
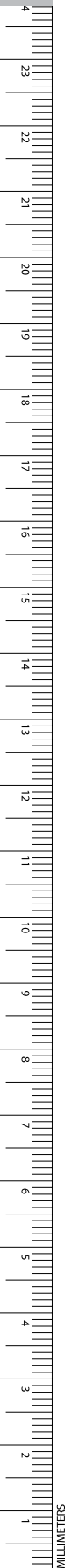

BV615R-BV621R

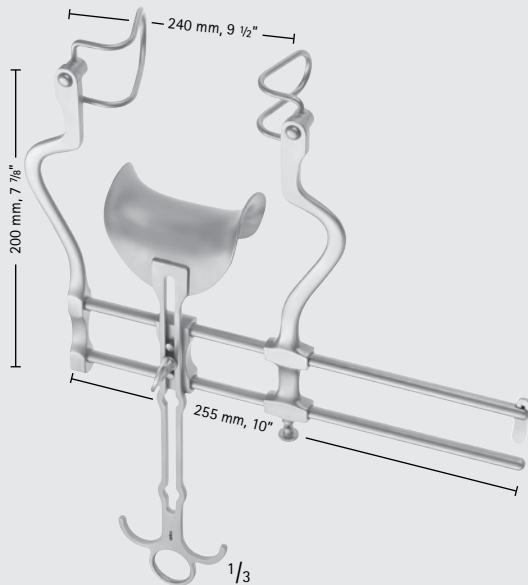

BV632R-BV638R

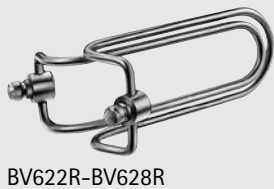

BV622R-BV628R

### BALFOUR Abdominal Retractor (continued)

Catalog Number	Description
BV615R	BALFOUR RETRACTOR, 200 x 255 MM COMPLETE W/ BV616R
BV632R	BALFOUR RETRACTOR, COMPLETE W/ BV606R, BV621R, BV622R
BV634R	BALFOUR RETRACTOR, COMPLETE W / BV609R, BV621R, BV624R
BV636R	BALFOUR RETRACTOR, COMPLETE W/ BV611R, BV621R, BV626R
BV638R	BALFOUR RETRACTOR, COMPLETE W/ BV611R, BV621R, BV628R
BV616R	CENTER BLADE, 107 x 59 MM
BV621R	SPREADER ONLY, 200 x 250 MM
BV622R	LATERAL BLADE, PAIR 50 MM
BV624R	LATERAL BLADE, PAIR 60 MM
BV626R	LATERAL BLADE, PAIR 75 MM
BV628R	LATERAL BLADE, PAIR 90 MM

# General Surgery

## Abdominal Retractors

GENERAL SURGERY

### BALFOUR Side Blade Solid F/ Retractor MB221R, MB222R

Catalog Number	Description
MB637R	PAIR, 2 1/2" (64 MM) DEEP
MB638R	PAIR, 3 1/2" (89 MM) DEEP
MB639R	PAIR, 4" (102 MM) DEEP



MB637R



MB638R



MB639R

### BALFOUR Side Blade Wire F/ Retractor MB221R, MB222R

Catalog Number	Description
MB577R	PAIR, 2 1/2" (64 MM) DEEP
MB578R	PAIR, 3 1/2" (89 MM) DEEP
MB579R	PAIR, 4" (102 MM) DEEP



MB577R



MB578R

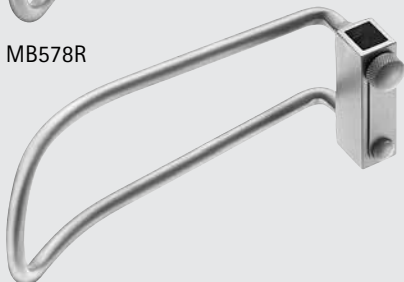

MB579R



INCHES

General Surgery  
Abdominal Retractors

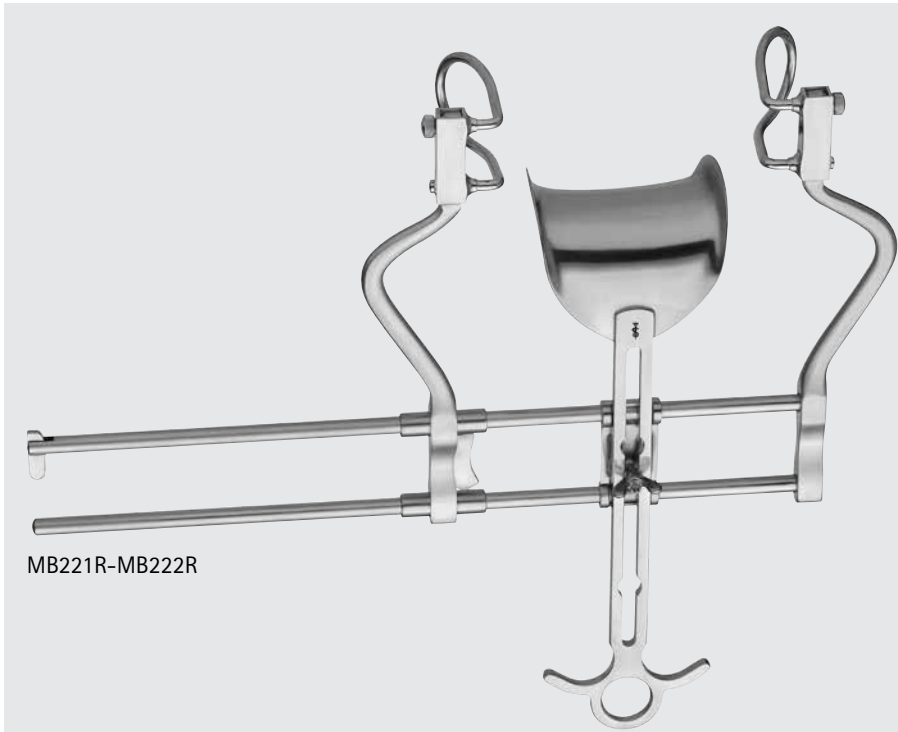

MB221R-MB222R

**BALFOUR Retractor W/ Exchangeable Lateral Blades**

Catalog Number	Total Width (in.)	Opening Width (in.)	Description
MB221R	16	10 1/2	2 PAIRS OF DETACHABLE BLADES 2 1/2" AND 3 1/2", 1 CENTER BLADE 2 3/4" x 3 1/4"
MB222R	16	8 1/2	2 PAIRS OF DETACHABLE BLADES 2 1/2" AND 3 1/2", 1 CENTER BLADE 2 1/2" x 2 1/2"



MB225

**BALFOUR Retractor**

Catalog Number	Total Width (in.)	Opening Width (in.)	Description
MB225	13	11	2 LATERAL BLADES 2" x 2" AND 1 1/4" x 2", 1 CENTER BLADE 3" x 10 1/2"

1/3



MB573R-MB574R

**DIXON Center Blade**

Catalog Number	Blade	Blade Size (mm)
MB573R	MALLEABLE	171 x 51
MB574R	MALLEABLE	267 x 57



BV617R

**BALFOUR Center Blade For All  
BALFOUR Retractors**

Catalog Number	Blade Size (mm)
BV617R	54 x 80



BV618R

**Center Blade F/ BV615R**

Catalog Number	Blade Size (mm)
BV618R	75 x 80



INCHES

General Surgery  
Abdominal Retractors

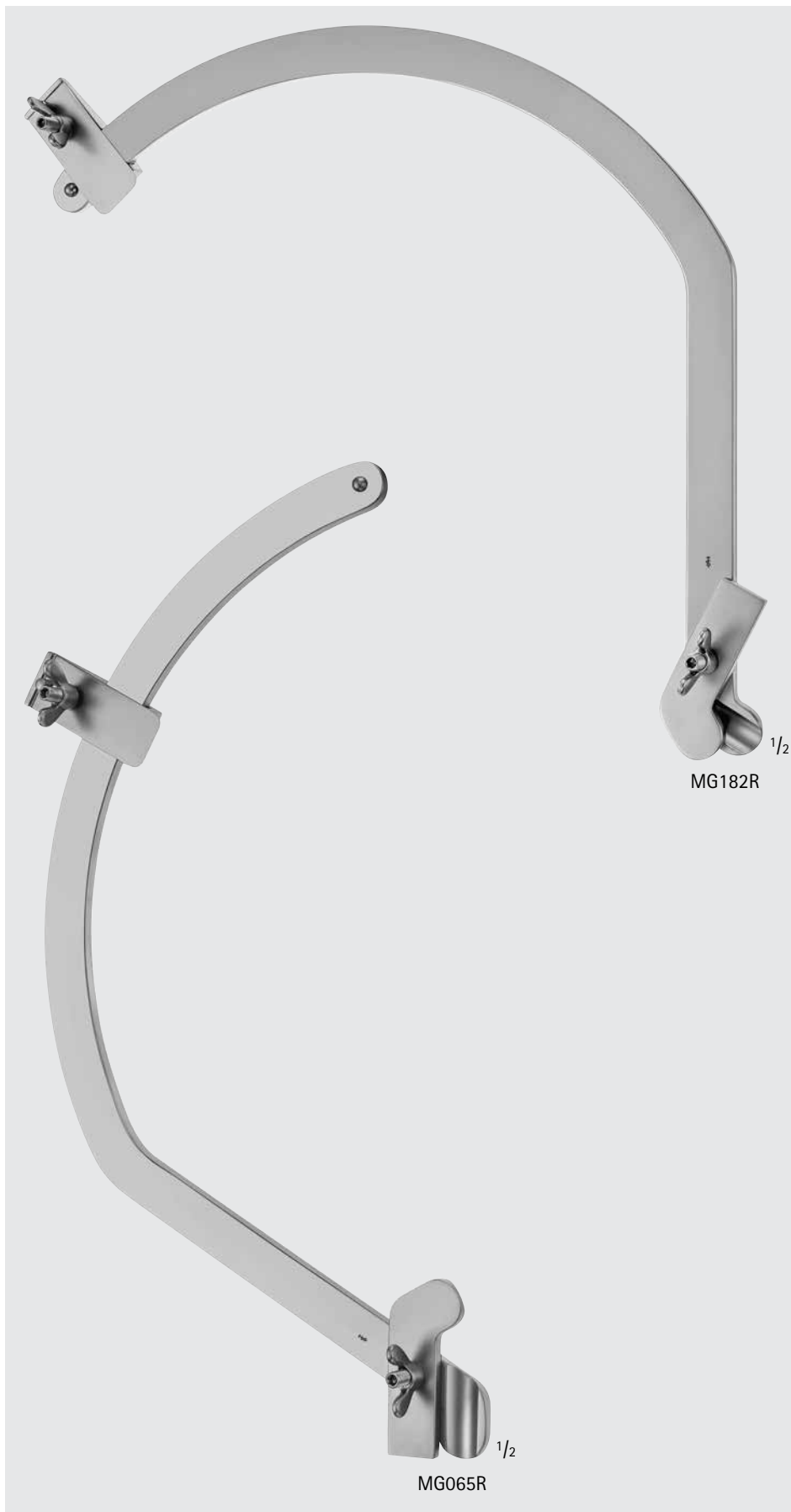

**BALFOUR Retractor Extension Arm**

Catalog Number	Description	Length (in.)
MG065R	ADULT ABDOMINAL, 4" BLADE F/ RIGHT ARM	9 1/2
MG182R	ADULT ABDOMINAL, 4" BLADE F/ LEFT ARM	9 1/2

MG182R

MG065R

# General Surgery

## Abdominal Retractors

### DENIS-BROWNE Abdominal Retractor

Catalog Number	Description
BV650R	COMPLETE SET
BV648R	2 BLADES ONLY, 40 x 30 MM
BV649R	2 BLADES ONLY, 40 x 40 MM
BV646R	BLADE ONLY, 20 x 30 MM

BV650R Includes:

1 Frame

2 Blades of each BV648R and BV649R

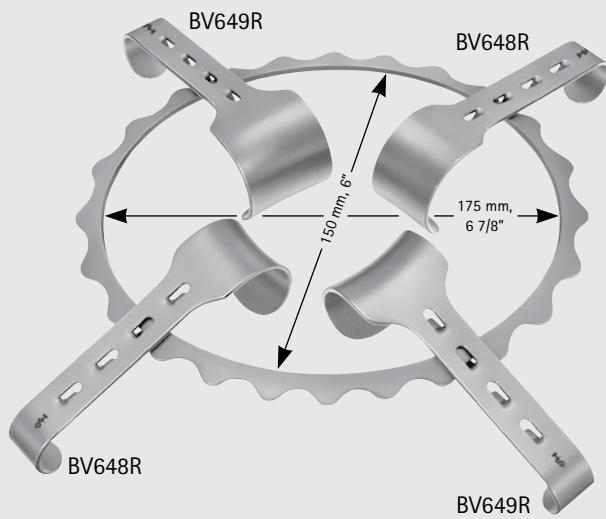

BV646R

General Surgery  
Abdominal Retractors

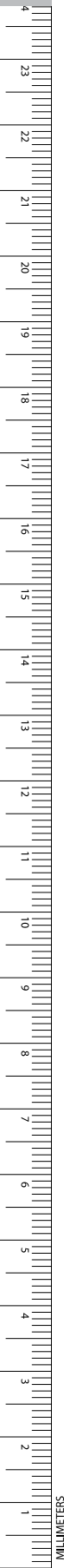

SEMM Abdominal Retractor

Catalog Number	Description	Blade Size (mm)		
BV654R	COMPLETE SET	-		
BV653R	FRAME	-		
BV655R	2 BLADES	46 x 64		
BV656R	BLADE	53 x 54		
BV657R	BLADE	82 x 97		
BV658R	BLADE <tr <td>BV659R</td> <td>BLADE</td> <td>107 x 36</td>	BV659R	BLADE	107 x 36

BV654R Includes:  
 1 Frame BV653R  
 1 Blade of each BV656R, BV657R,  
 BV658R and BV659R  
 2 Blades BV655R

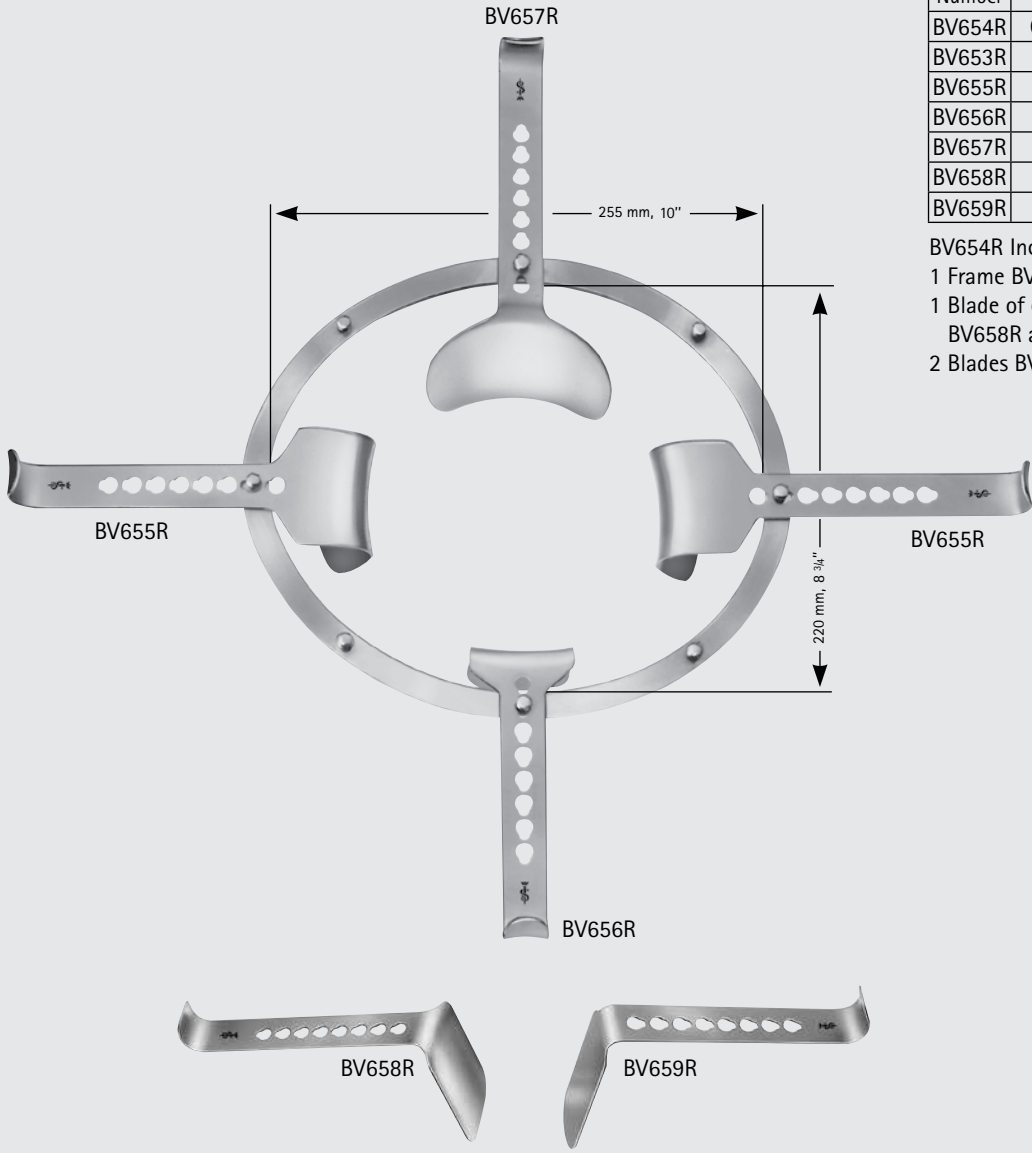

■ For more information about Universal Ring Retractor System see our brochure number DOC380.

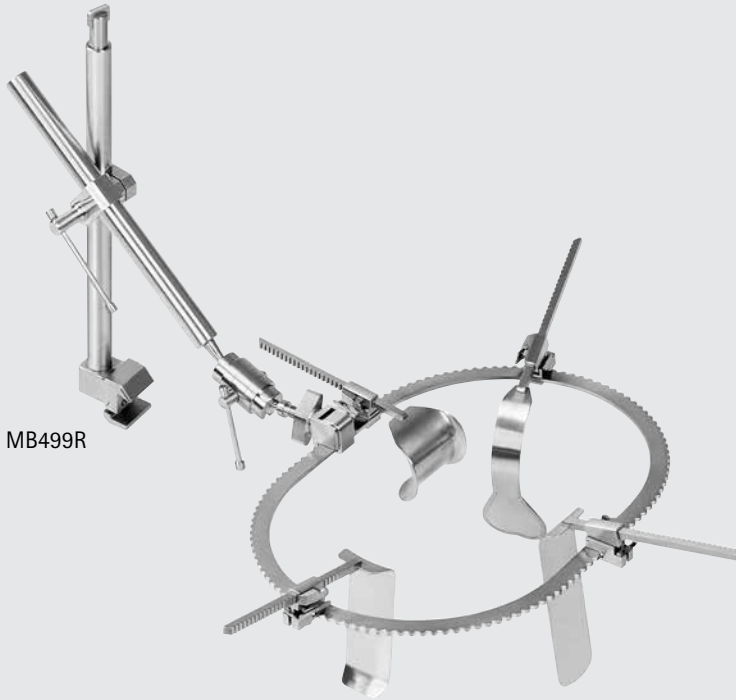

MB499R

### Universal Ring Retractor System

Catalog Number	Description
MB499R	COMPLETE SET

#### Complete System Includes:

MB497	Segmented Medium Oval Ring
MB516	Medium Oval Ring
MB506	Standard Table Clamp 18"
MB488R	Horizontal Flex Bar w/ 360° Rotation 19 1/4"
MB487R	Horizontal Fixed Bar 15 1/2"
MB504	Post Clamp for 1" Bar
MB503	Non-Tilting Blade Clamp (2 each)
MB510	Tilting Blade Clamp (6 each)
MB524	KELLY Retractor Blade 2" x 3" (2 each)
MB525	KELLY Retractor Blade 2" x 4"
MB526	KELLY Retractor Blade 2" x 5"
MB527	KELLY Retractor Blade 2" x 6"
MB529	Malleable Retractor Blade 1 1/2" x 6"
MB530	Malleable Retractor Blade 2" x 6"
MB532	Malleable Retractor Blade 3" x 6"
MB534	BALFOUR Bladder Blade 3" x 2 1/2"
MB544	HARRINGTON Sweetheart Blade 2 1/2" x 5"
MB546	GELPI Point Retractor Blade



MB515-MB517

### Oval Ring

Catalog Number	Size	Width x Length (in.)
MB515	SMALL	8 1/2 x 12
MB516	MEDIUM	10 1/2 x 15
MB517	LARGE	12 1/2 x 18 1/2

# General Surgery

## Universal Ring Retractor System

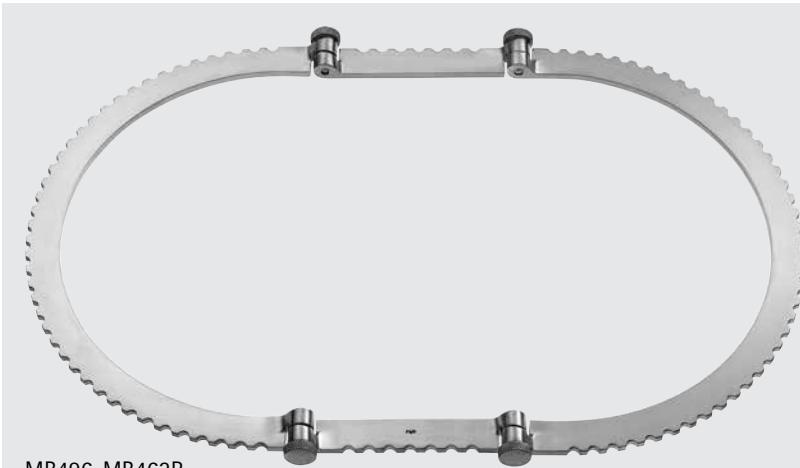

MB496-MB462R

### Segmented Oval Ring

Catalog Number	Size	Description	Width x Length (in.)
MB496	SMALL	INCLUDES REMOVABLE 4" SEGMENTS	8 1/2 x 14
MB497	MEDIUM	INCLUDES REMOVABLE 8" SEGMENTS	10 1/2 x 19 1/2
MB498	LARGE	INCLUDES REMOVABLE 6" SEGMENTS	12 1/2 x 19 1/2
MB462R	X-LARGE	INCLUDES REMOVABLE 6" SEGMENTS	16 x 22



MB471R-MB473R

### Segments for Segmented Oval Ring, Pair

Catalog Number	Length (in.)
MB471R	4
MB472R	6
MB473R	8



MB564

### URRS Segmented Ring Screw

Catalog Number
MB564

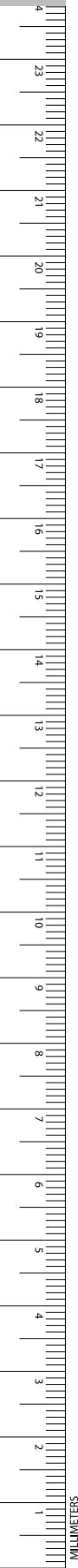

# General Surgery

## Universal Ring Retractor System

### Round Ring

Catalog Number	Size	Diameter (in.)
MB519	SET	-
MB520	SMALL	8 1/2
MB521	MEDIUM	10 1/2
MB522	LARGE	12 1/2

MB519 Includes:  
1 Ring of each MB520-MB522

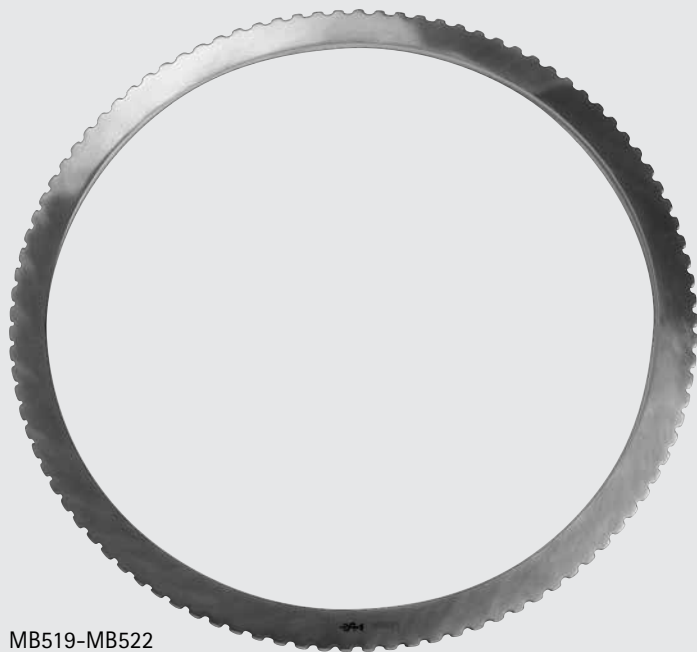

MB519-MB522

### Segmented Round Ring

Catalog Number	Size	Diameter (in.)
MB825R	SMALL	8 1/2
MB826R	MEDIUM	10 1/2
MB827R	LARGE	12 1/2
MB828R	X-LARGE	16

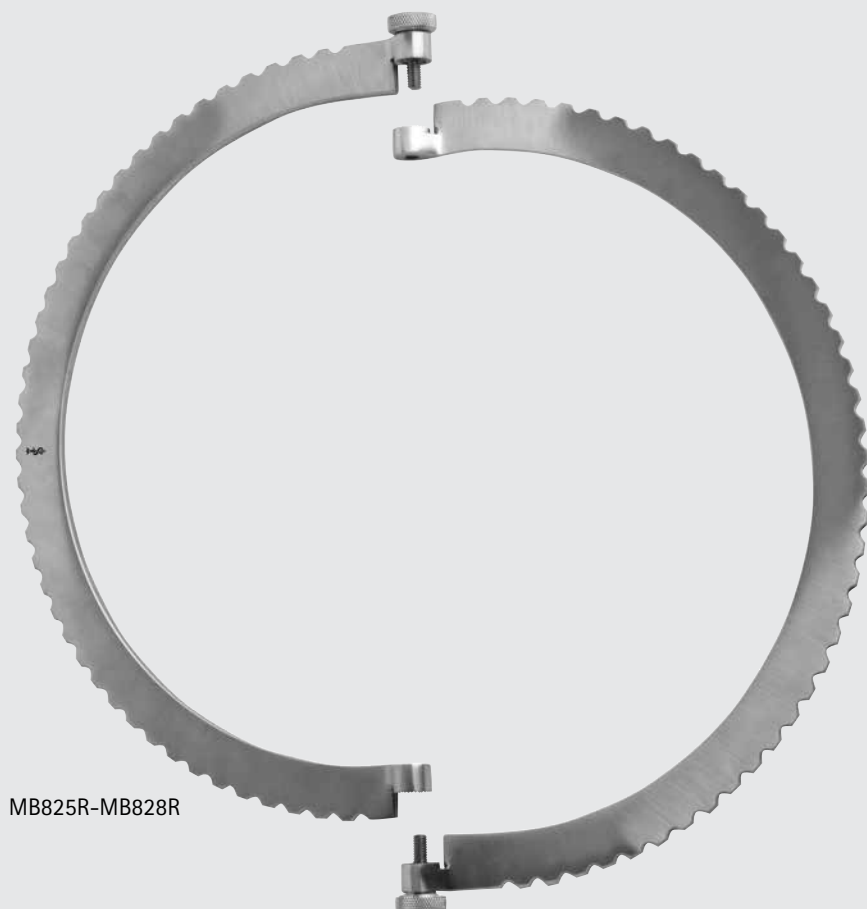

MB825R-MB828R



INCHES

# General Surgery

## Universal Ring Retractor System

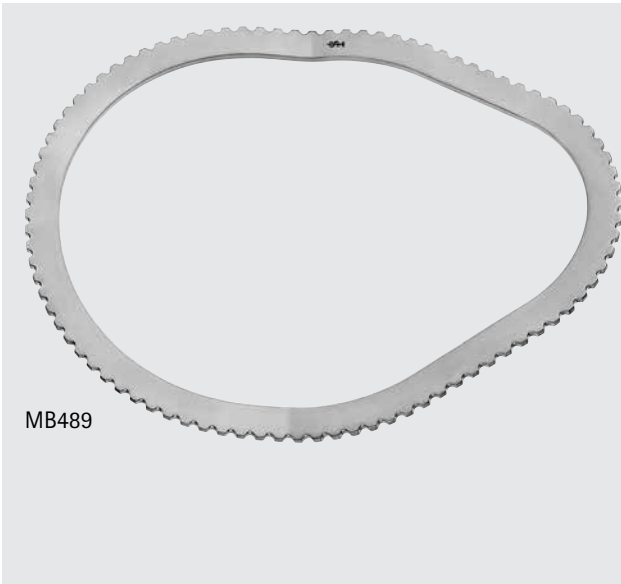

MB489

### Vaginal Ring

Catalog Number	Description	Width x Length (in.)
MB489	20° ANGLE	8 x 10 1/2



MG511R

1/2

### Tilt and Swivel Clamp

Catalog Number
MG511R

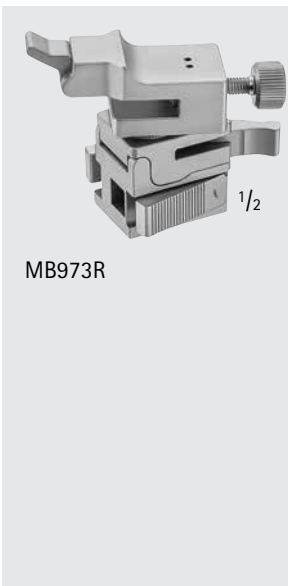

MB973R

1/2

### Multi Directional Blade Clamp

Catalog Number
MB973R



MB503

Non-Tilting Blade Clamp

Catalog Number
MB503



MB510

Tilting Blade Clamp

Catalog Number
MB510

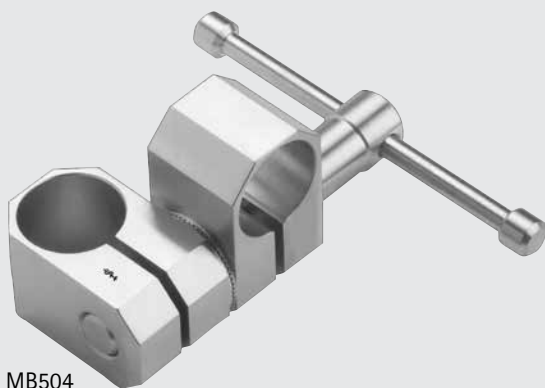

MB504

Post Clamp

Catalog Number
MB504



# General Surgery

## Universal Ring Retractor System



MB460R-MB506

### Table Clamp

Catalog Number	Working Length (in.)	Length (in.)
MB506	15	18
MB460R	21	24

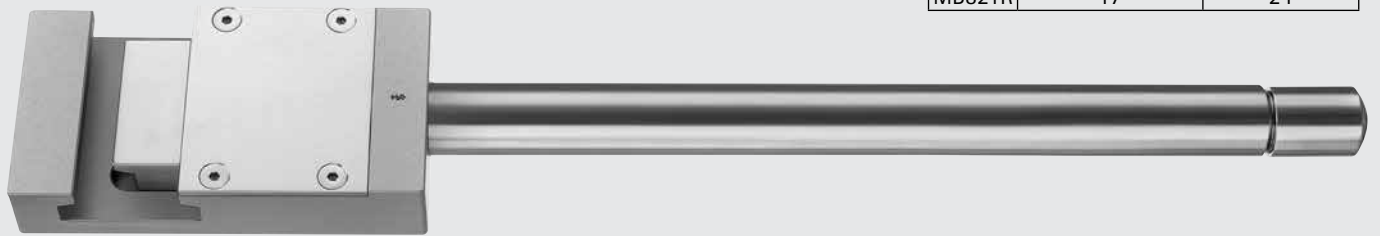

MB670R-MB821R

### Flat Table Clamp

Catalog Number	Working Length (in.)	Total Length (in.)
MB670R	11 1/2	18
MB821R	17	24



MB487R-MB823R

### Horizontal Fixed Bar

Catalog Number	Length (in.)
MB487R	15 1/2
MB823R	22

Horizontal Flex Bar W/ 360° Rotation

Catalog Number	Length (in.)
MB488R	19
MB824R	22 1/2



MB488R-MB824R

Vertical Extension Bar

Catalog Number	Length (in.)
MB508	12
MB822R	14



MB508-MB822R

Adapter For Attaching Handheld Retractors

Catalog Number
MB509



MB509



INCHES

# General Surgery

## Universal Ring Retractor System

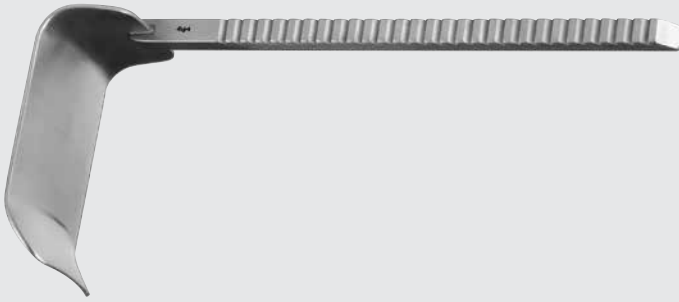

MB469R-MB555

### KELLY Retractor Blade

Catalog Number	Description	Width x Depth (in.)
MB555	-	1 x 1 1/2
MB556	-	1 x 2 1/2
MB936R	-	2 x 1 1/2
MB937R	-	2 x 2 1/2
MB524	-	2 x 3
MB525	-	2 x 4
MB526	-	2 x 5
MB527	-	2 x 6
MB469R	BARIATRIC	2 x 8



MB938A-MB943A

### Aluminum KELLY Retractor Blade

Catalog Number	Description	Width x Depth (in.)
MB938A	-	2 x 2 1/2
MB939A	-	2 x 3
MB940A	-	2 x 4
MB941A	-	2 x 5
MB942A	-	2 x 6
MB943A	BARIATRIC	2 x 8





MB467R-MB860R

Malleable Retractor Blade

Catalog Number	Description	Width x Depth (in.)
MB860R	-	3/4 x 2
MB861R	-	3/4 x 3
MB862R	-	1 x 1
MB863R	-	1 x 4
MB864R	-	1 x 5
MB865R	-	1 1/2 x 3
MB866R	-	1 1/2 x 4
MB529	-	1 1/2 x 6
MB867R	-	1 1/2 x 8
MB530	-	2 x 6 1/2
MB531	-	2 x 8
MB463R	BARIATRIC	2 x 10
MB532	-	3 x 6
MB464R	BARIATRIC	3 x 10
MB466R	BARIATRIC	3 x 12
MB869R	BARIATRIC	4 x 8
MB465R	BARIATRIC	4 x 10
MB467R	BARIATRIC	4 x 12

Aluminum Malleable Retractor Blade,  
Flat

Catalog Number	Description	Width x Depth (in.)
MB954A	-	1 1/2 x 6
MB955A	-	2 x 6
MB956A	-	2 x 8
MB957A	-	3 x 6
MB958A	BARIATRIC	2 x 10
MB959A	BARIATRIC	3 x 10



MB954A-MB959A



INCHES

# General Surgery

## Universal Ring Retractor System



MB557-MB559

### RICHARDSON Retractor

Catalog Number	Width x Depth (in.)
MB557	3/4 x 1
MB558	3/4 x 2
MB559	1 x 1 1/4



MB470R-MB534

### BALFOUR Bladder Blade

Catalog Number	Description	Width x Depth (in.)
MB534	-	3 x 2 1/2
MB535	-	3 x 3 1/4
MB470R	BARIATRIC	3 x 3 1/2

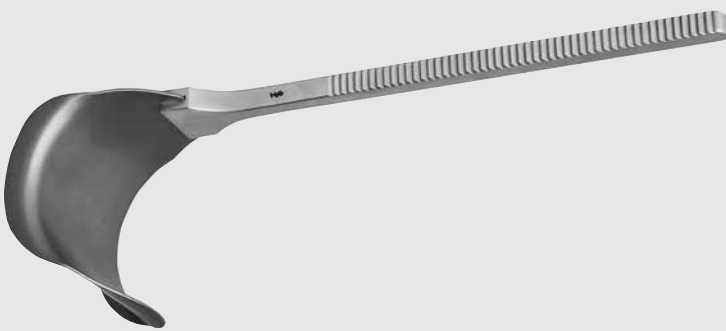

MB829A-MB830A

### Aluminum BALFOUR Bladder Blade

Catalog Number	Width x Depth (in.)
MB829A	2 x 2 3/8
MB830A	3 x 2 1/2

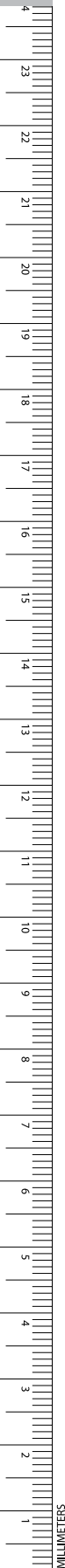

# General Surgery

## Universal Ring Retractor System

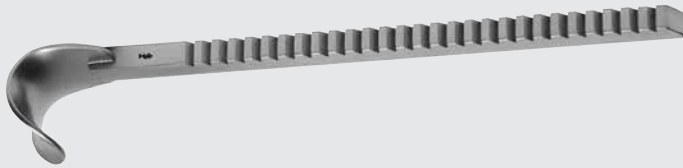

MB968R-MB969R

### MAYO Retractor Blade

Catalog Number	Width x Depth (in.)
MB968R	1 1/4 x 1 1/4
MB969R	2 x 2

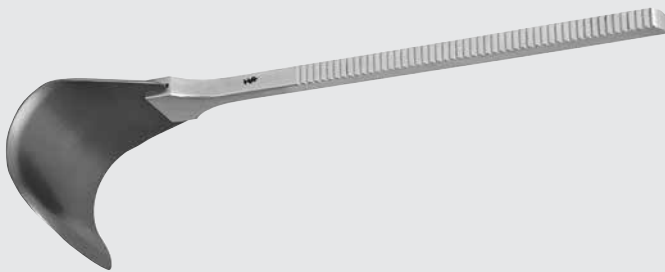

MB970A

### Aluminum MAYO Retractor Blade

Catalog Number	Width x Depth (in.)
MB970A	2 3/4 x 2



MB537-MB539

### DEEVER Retractor Blade

Catalog Number	Width x Depth (in.)
MB537	1 x 4 1/2
MB538	1 1/2 x 4 1/2
MB539	2 x 4 1/2



MB492-MB493

### DEEVER Vaginal Retractor Blade

Catalog Number	Description	Width x Depth (in.)
MB492	SMALL	1 x 3 1/2
MB493	LARGE	1 x 5



INCHES

# General Surgery

## Universal Ring Retractor System



MB490

**Vaginal Retractor Posterior Blade**

Catalog Number	Width x Depth (in.)
MB490	1 x 4 1/2



MB491

**Vaginal Retractor Lateral Blade**

Catalog Number	Width x Depth (in.)
MB491	1 x 3



MB871R

**ST. MARK'S Deep Pelvic Retractor Blade**

Catalog Number	Width x Depth (in.)
MB871R	2 3/8 x 7 1/2



MB494-MB495

**Rectal Blade**

Catalog Number	Description	Width x Depth (in.)
MB494	SMALL	7/8 x 2 7/8
MB495	LARGE	7/8 x 3 7/8

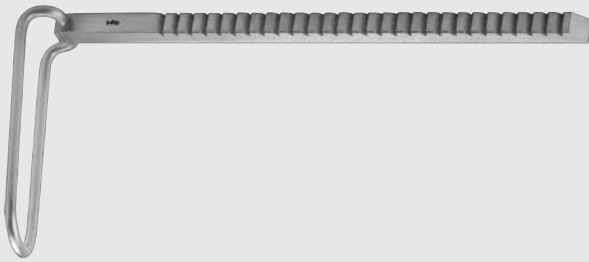

MB541

**Skin Incision Blade**

Catalog Number	Width x Depth (in.)
MB541	1 1/8 x 3 1/4



# General Surgery

## Universal Ring Retractor System



MB543-MB832R

### HARRINGTON Sweetheart Blade

Catalog Number	Description	Width x Depth (in.)
MB543	-	1 1/2 x 5
MB544	-	2 1/2 x 5 5/8
MB468R	BARIATRIC	3 1/2 x 10
MB832R	BARIATRIC	4 1/2 x 10

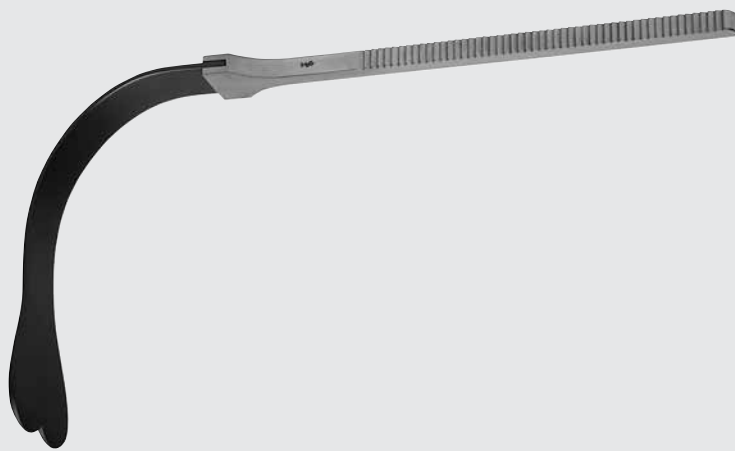

MB833A-MB835A

### Aluminum HARRINGTON Sweetheart Blade

Catalog Number	Description	Width x Depth (in.)
MB833A	-	2 1/2 x 4
MB834A	-	3 1/2 x 8
MB835A	BARIATRIC	3 1/2 x 10



MB546

### GELPI Point Retractor Blade

Catalog Number
MB546



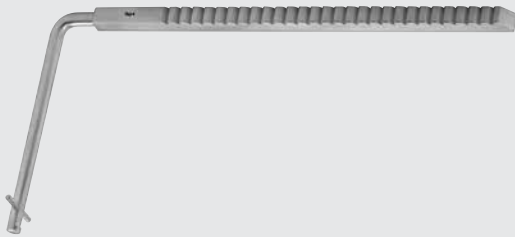

MB548-MB549

**SCOVILLE Hook Retractor Blade**

Catalog Number	Description	Depth (in.)
MB549	SMALL	2
MB548	LARGE	3 1/4



MB566-MB568

**Rake Retractor**

Catalog Number	Description	Width x Depth (in.)
MB566	3 PRONGS	2/3 x 3/4
MB567	4 PRONGS	3/4 x 1/3
MB568	6 PRONGS	1 x 1/3



MB551-MB553

**MEYERDING Retractor Blade**

Catalog Number	Width x Depth (in.)
MB551	1 x 3 1/3
MB552	2 x 3 3/4
MB553	2/3 x 2 1/3



# General Surgery

## Universal Ring Retractor System

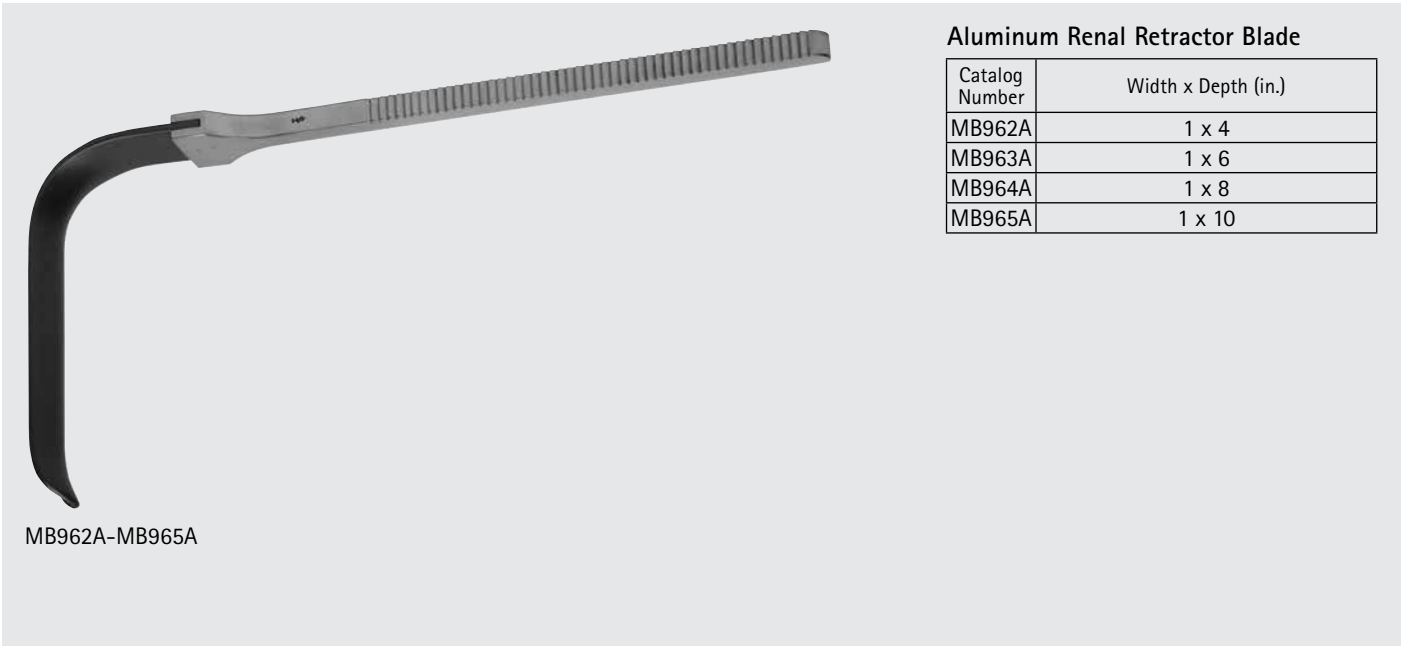

MB962A-MB965A

### Aluminum Renal Retractor Blade

Catalog Number	Width x Depth (in.)
MB962A	1 x 4
MB963A	1 x 6
MB964A	1 x 8
MB965A	1 x 10

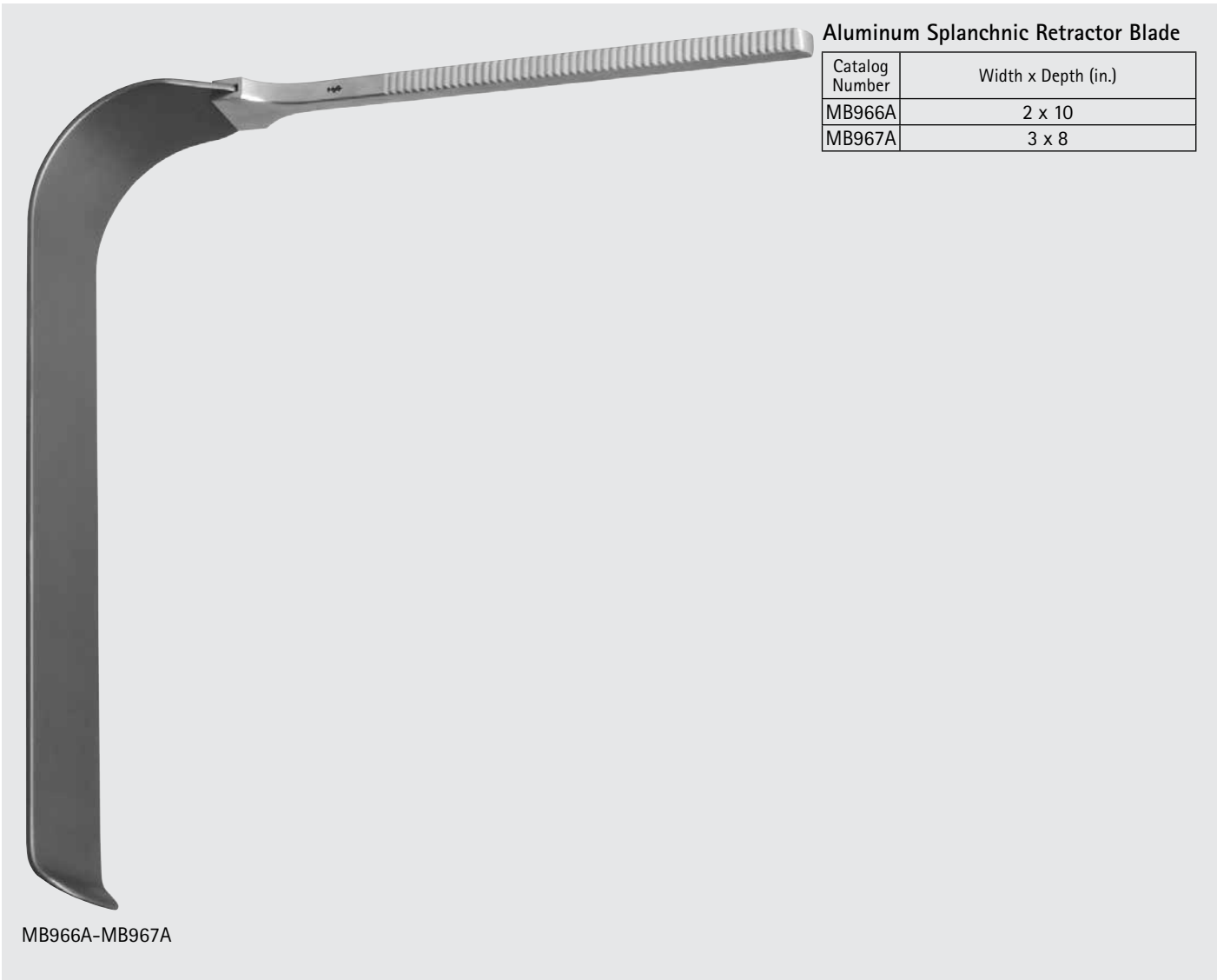

MB966A-MB967A

### Aluminum Splanchnic Retractor Blade

Catalog Number	Width x Depth (in.)
MB966A	2 x 10
MB967A	3 x 8

Perforated Super Malleable Retractor  
 Blade

Catalog Number	Width x Depth (in.)
MB960R	2 x 9
MB961R	3 x 9

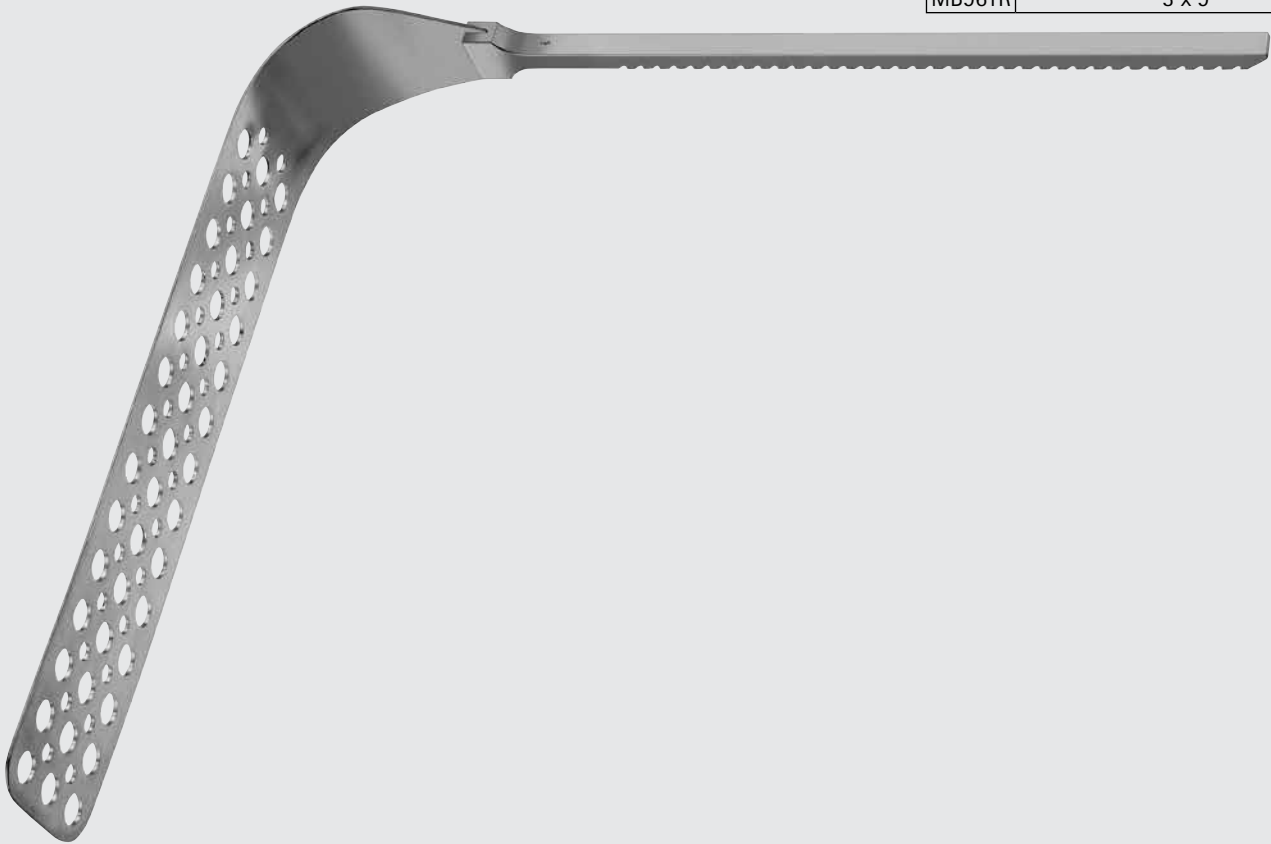

MB960R-MB961R

YU-HOLTGREWE Malleable Retractor  
 Blade

Catalog Number	Width x Depth (in.)
MB870R	2 1/2 x 6

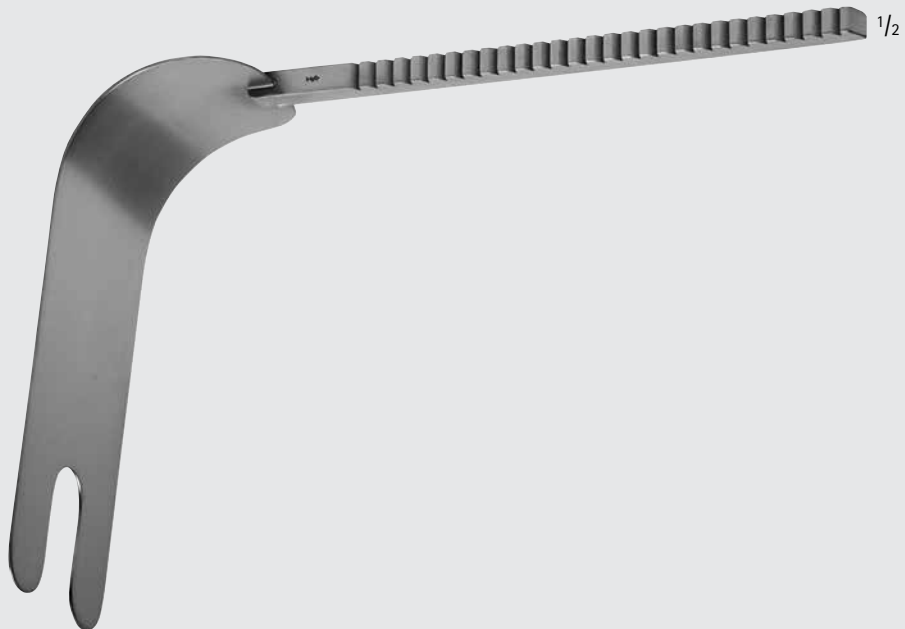

MB870R



# General Surgery

## Self Retaining Retractors



BV001R

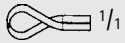

BV001R

### FINSEN Retractor

Catalog Number	Tip	Blade End	Length (in.)
BV001R	SHARP	2 x 3 PRONGS	2



BV002R

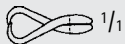

BV002R

### FINSEN Retractor

Catalog Number	Tip	Blade End	Length (in.)
BV002R	SHARP	3 x 4 PRONGS	2 3/4



BV003R



BV003R

### FINSEN Modified Retractor

Catalog Number	Tip	Blade End	Length (in.)
BV003R	BLUNT	2 x 3 PRONGS	3



BV005R



BV005R

### FINSEN Retractor

Catalog Number	Tip	Blade End	Length (in.)
BV005R	SHARP	3 x 4 PRONGS	2 3/4



BV014R

### PARSONNET Epicardial Retractor

Catalog Number	Tip	Blade End	Length (in.)
BV014R	SHARP	3 x 3 PRONGS	2





BV006R-BV007R



BV006R

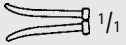

BV007R

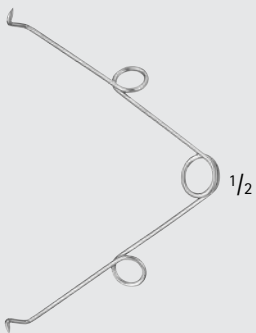

MD471

Spring Wire Retractor

Catalog Number	Tip	Prongs	Length (in.)
BV006R	BLUNT	3 x 3	1 3/4
BV007R	BLUNT	3 x 3	2 1/4
MD471	SHARP	1 x 1	3

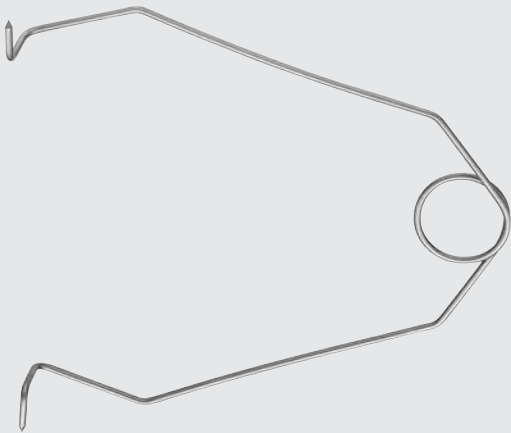

MB196R-MB777R

Spring Wire Retractor

Catalog Number	Size	Length (in.)
MB777R	SMALL	5
MB778R	MEDIUM	5 1/8
MB196R	LARGE	9



INCHES

# General Surgery

## Self Retaining Retractors



BV010R-BV011R



BV010R



BV011R

### ALM Retractor

Catalog Number	Tip	Blade End	Length (in.)
BV010R	SHARP	4 x 4 PRONGS	2 3/4
BV011R	SHARP	4 x 4 PRONGS	4



BV008R-BV015R



BV008R



BV015R

### HEISS Self-Retaining Retractor

Catalog Number	Tip	Blade End	Length (in.)
BV015R	SHARP	4 x 4 PRONGS	4
BV008R	BLUNT	4 x 4 PRONGS	4

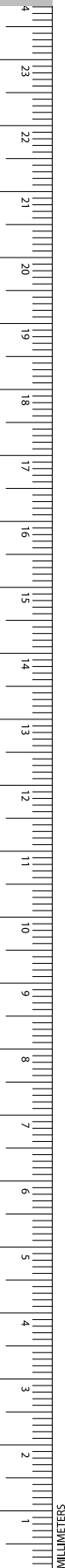

WEITLANER Retractor

Catalog Number	Tip	Blade End	Length (in.)
BV073R	BLUNT	2 x 3 PRONGS	4 1/4
MA438R	BLUNT	3 x 3 PRONGS	4 1/4
BV074R	BLUNT	3 x 4 PRONGS	5 1/8
BV075R	BLUNT	3 x 4 PRONGS	6 1/2
BV104R	BLUNT/ DEEP	3 x 4 PRONGS	5 1/8

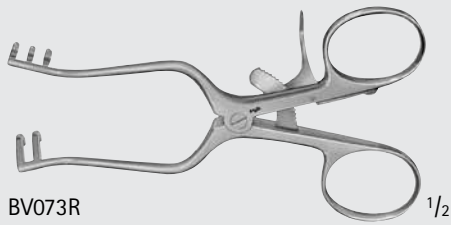

BV073R 1/2



MA438R 1/2

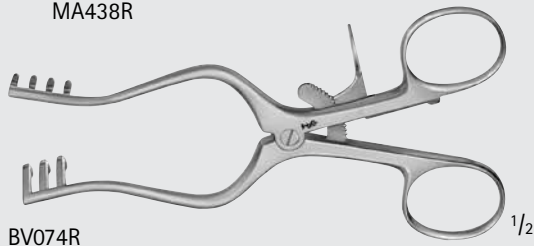

BV074R 1/2

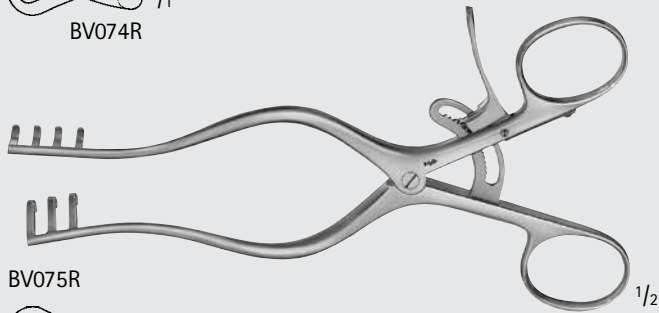
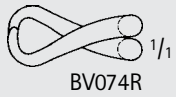

BV075R 1/2

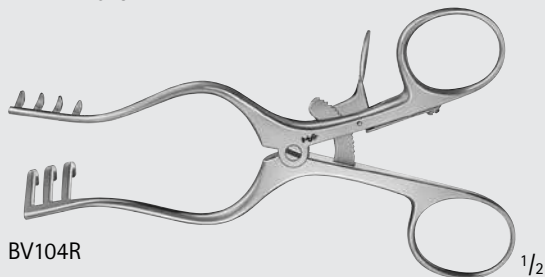
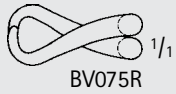

BV104R 1/2

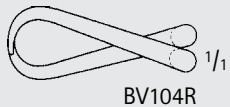

INCHES

# General Surgery

## Self Retaining Retractors

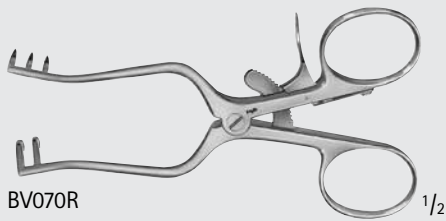

BV070R  $\frac{1}{2}$



BV070R  $\frac{1}{1}$

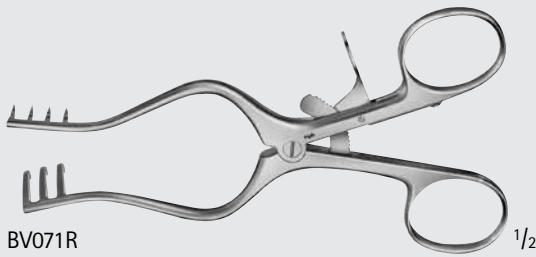

BV071R  $\frac{1}{2}$

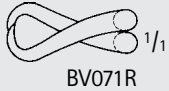

BV071R  $\frac{1}{1}$

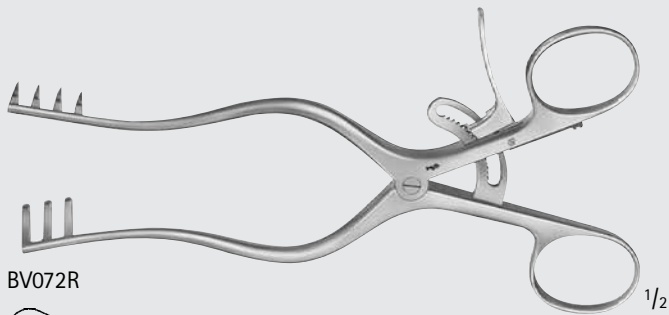

BV072R  $\frac{1}{2}$

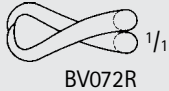

BV072R  $\frac{1}{1}$

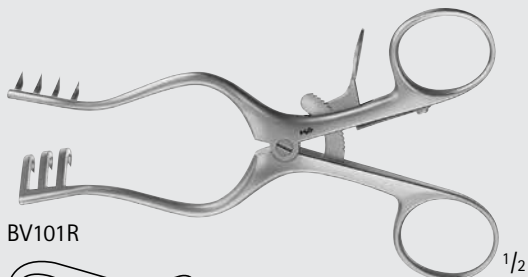

BV101R  $\frac{1}{2}$

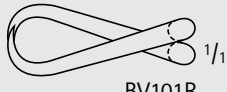

BV101R  $\frac{1}{1}$

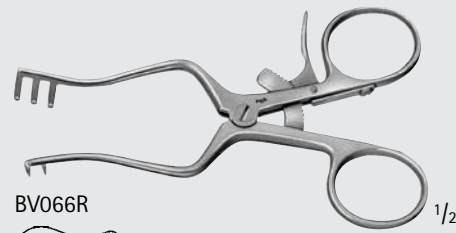

BV066R  $\frac{1}{2}$

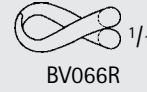

BV066R  $\frac{1}{1}$

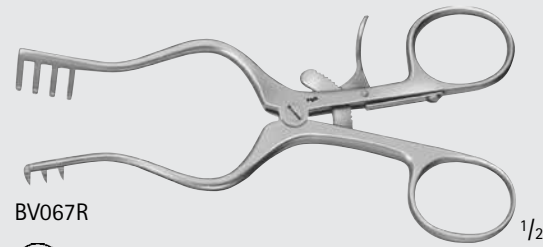

BV067R  $\frac{1}{2}$



BV067R  $\frac{1}{1}$

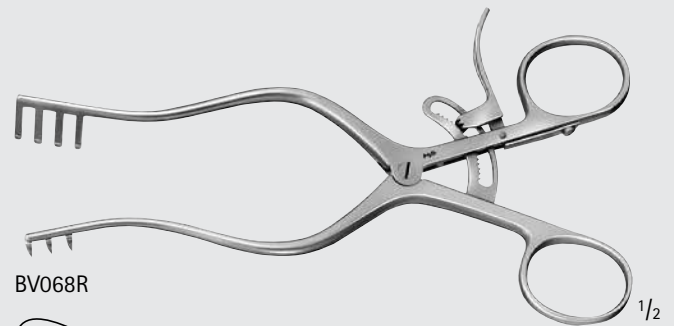

BV068R  $\frac{1}{2}$

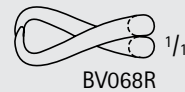

BV068R  $\frac{1}{1}$

### WEITLANER Retractor

Catalog Number	Tip	Blade End	Length (in.)
BV070R	SHARP	2 x 3 PRONGS	4 1/4
BV071R	SHARP	3 x 4 PRONGS	5 1/8
BV072R	SHARP	3 x 4 PRONGS	6 1/2
BV101R	SHARP/DEEP	3 x 4 PRONGS	5 1/8
BV066R	SEMI-S	2 x 3 PRONGS	4 1/4
BV067R	SEMI-S	3 x 4 PRONGS	5 1/8
BV068R	SEMI-S	3 x 4 PRONGS	6 1/2

WULLSTEIN Retractor

Catalog Number	Tip	Blade End	Length (in.)
BV076R	SHARP	3 x 3 PRONGS	5
BV077R	BLUNT	3 x 3 PRONGS	5

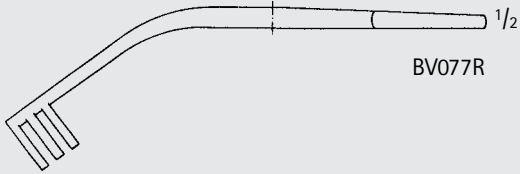
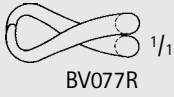
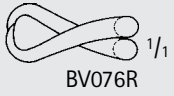

Baby ADSON Retractor, Hinged

Catalog Number	Tip	Blade End	Length (in.)
BV085R	SEMI-S	3 x 4 PRONGS	5 1/2
BV094R	SEMI-S	3 x 4 PRONGS	6 1/2

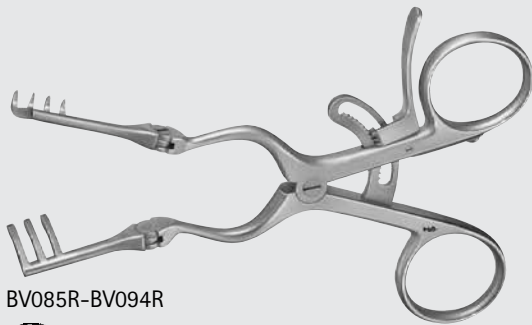

Baby ADSON Retractor, Angled

Catalog Number	Tip	Blade End	Length (in.)
MG007R	BLUNT	4 x 4 PRONGS	7 1/2

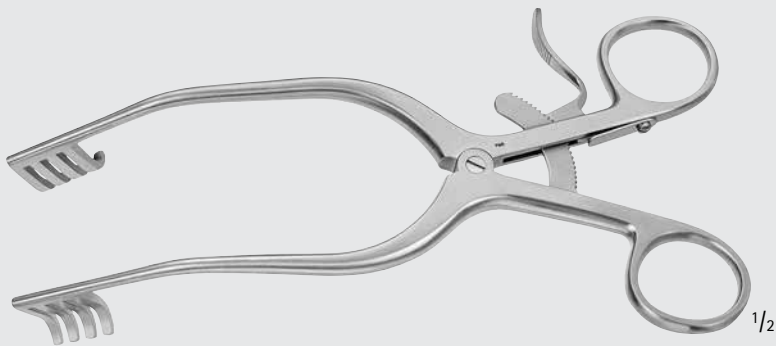

MG007R



INCHES

# General Surgery

## Self Retaining Retractors

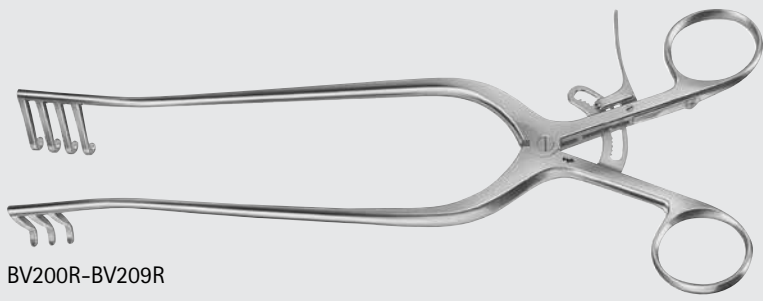

BV200R-BV209R

### WEITLANER Retractor

Catalog Number	Tip	Blade End	Length (in.)
BV200R	SHARP	3 x 4 PRONGS	7 7/8
BV206R	SHARP	3 x 4 PRONGS	9 1/2
BV208R	SHARP	5 x 6 PRONGS	10
BV201R	BLUNT	3 x 4 PRONGS	7 7/8
BV207R	BLUNT	3 x 4 PRONGS	9 1/2
BV209R	BLUNT	5 x 6 PRONGS	10

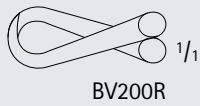

BV200R

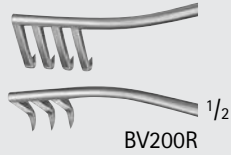

BV200R

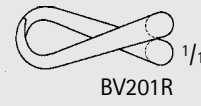

BV201R

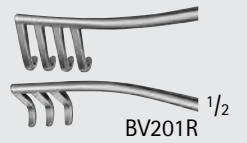

BV201R

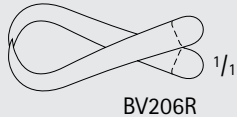

BV206R

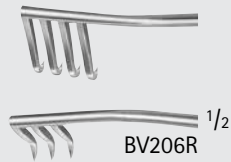

BV206R

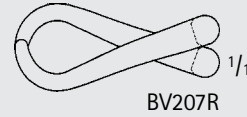

BV207R

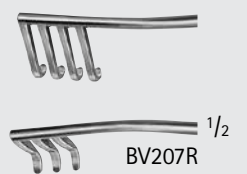

BV207R

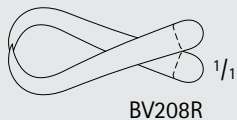

BV208R

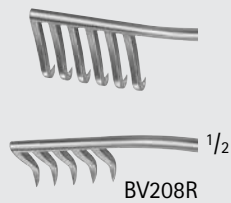

BV208R

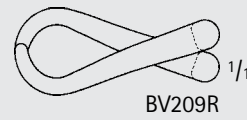

BV209R

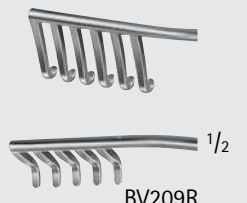

BV209R

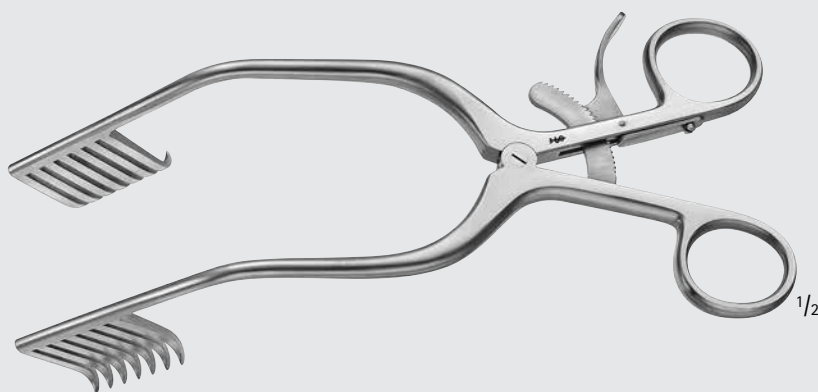

MB476R

### MISKIMON Cerebellar Retractor

Catalog Number	Tip	Blade End	Length (in.)
MB476R	SHARP	7 x 7 PRONGS	7 7/8

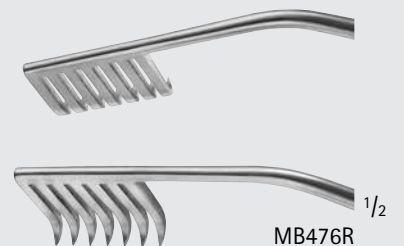

MB476R

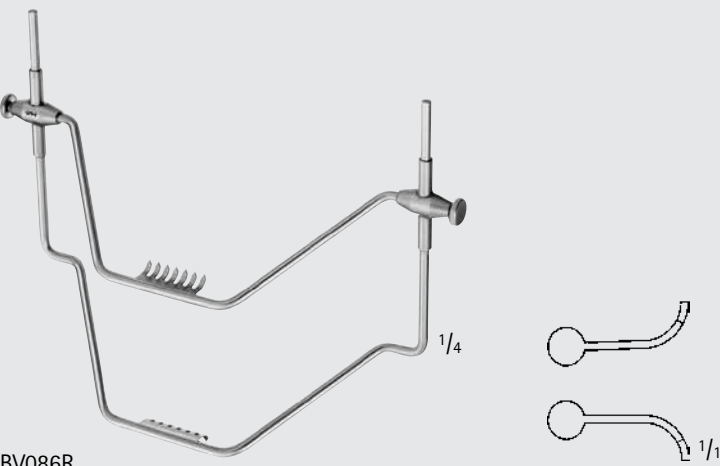
The image shows a Thyroid Retractor (BV086R) in two views. The main view is a perspective drawing of the retractor, which consists of two long, curved arms joined at the top by a central hinge mechanism. Each arm has a series of small, rounded prongs along its inner curve. A label '1/4' is placed near the bottom of the right arm. To the right of the main view are two smaller diagrams showing the curved arms in profile, with a label '1/1' and 'BV086R' below them.

**Thyroid Retractor**

Catalog Number	
	BV086R

BV086R

BV086R

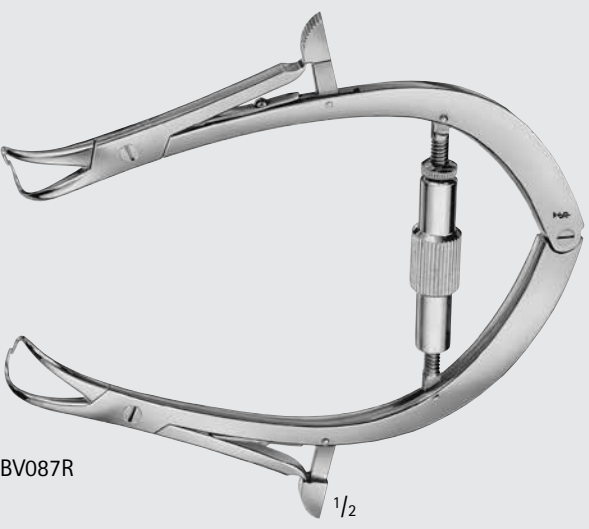

The image shows a JOLL (FRIEDMANN) Thyroid/Vaginal Retractor (BV087R). It is a large, C-shaped retractor with two curved arms. The arms are joined at the top by a central hinge mechanism. Each arm has a series of small, rounded prongs along its inner curve. A label '1/2' is placed near the bottom of the right arm.

**JOLL (FRIEDMANN) Thyroid/Vaginal Retractor**

Catalog Number	Length (in.)
BV087R	6 1/8

BV087R

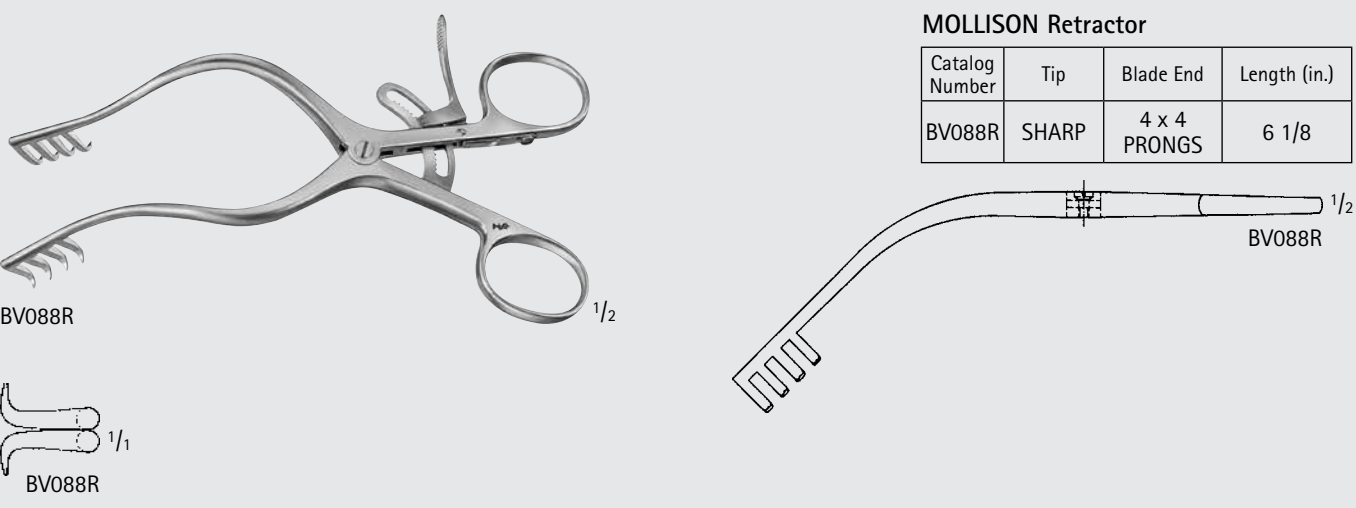

The image shows a MOLLISON Retractor (BV088R) in two views. The main view is a perspective drawing of the retractor, which consists of two long, curved arms joined at the top by a central hinge mechanism. Each arm has a series of small, rounded prongs along its inner curve. A label '1/2' is placed near the bottom of the right arm. To the right of the main view is a smaller diagram showing the curved arm in profile, with a label '1/2' and 'BV088R' below it. Below the main view are two smaller diagrams showing the curved arms in profile, with a label '1/1' and 'BV088R' below them.

**MOLLISON Retractor**

Catalog Number	Tip	Blade End	Length (in.)
BV088R	SHARP	4 x 4 PRONGS	6 1/8

BV088R

BV088R

BV088R

# General Surgery

## Self Retaining Retractors

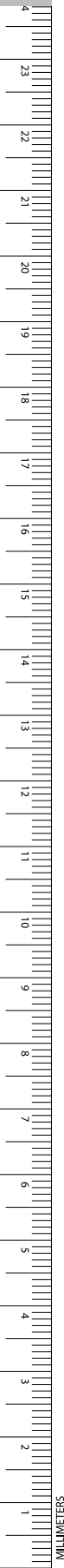

**MAYO-ADAMS Retractor**

Catalog Number	Length (in.)
BV112R	6 1/2

BV112R <sup>1/2</sup>

BV112R <sup>1/1</sup>

**WILSTE-GELPI Retractor**

Catalog Number	Tip	Tip Size (mm)	Length (in.)
MB929R	SHARP	70	11

MB929R <sup>1/2</sup>

MB929R <sup>1/1</sup>

**GELPI Perineal Retractor**

Catalog Number	Tip	Length (in.)
MB199R	SHARP WITH BALL STOPS	7

MB199R <sup>1/2</sup>

MB199R <sup>1/1</sup>

# General Surgery

## Self Retaining Retractors

GENERAL SURGERY

### GELPI Vaginal Retractor

Catalog Number	Tip	Length (in.)
MG176R	SHARP	3 1/2
BV996R	SHARP	5 1/4
BV997R	SHARP	6 7/8
MD651	SHARP	7 1/4
MG177R	BLUNT	4 1/2

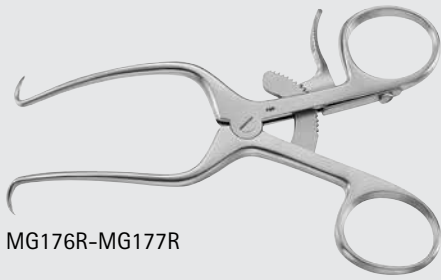

MG176R-MG177R

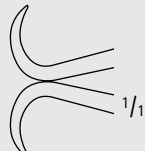

MG176R



MG177R



BV996R

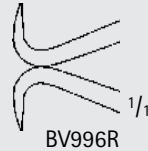

BV996R

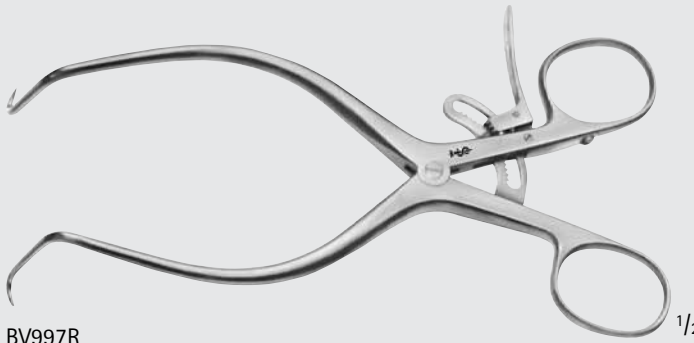

BV997R

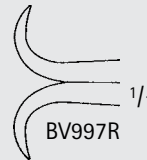

BV997R

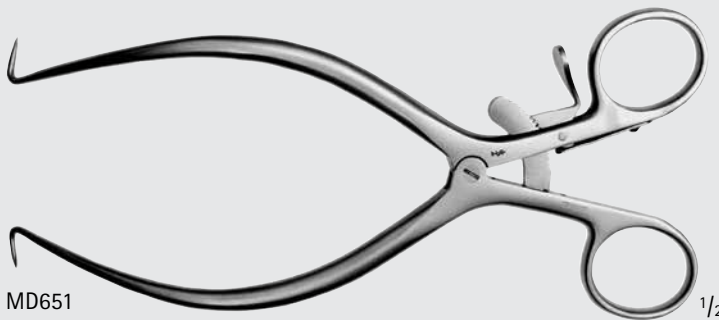

MD651

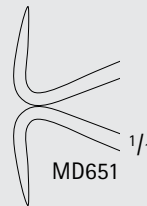

MD651



INCHES

# General Surgery

## Self Retaining Retractors

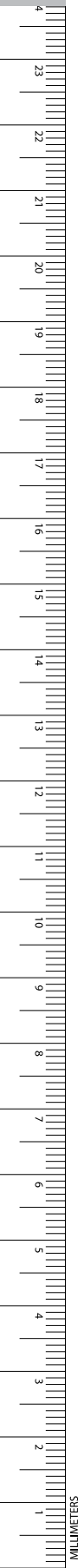

BV998R

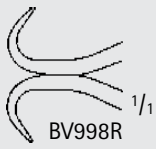

BV998R

### DEBAKEY Femur Retractor for Children

Catalog Number	Tip	Length (in.)
BV998R	SHARP	4

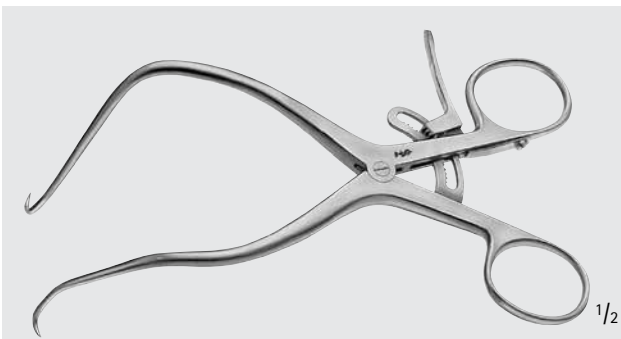

BV999R

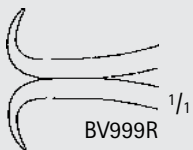

BV999R

### DEBAKEY Femur Retractor for Adults

Catalog Number	Tip	Length (in.)
BV999R	SHARP	5 1/2

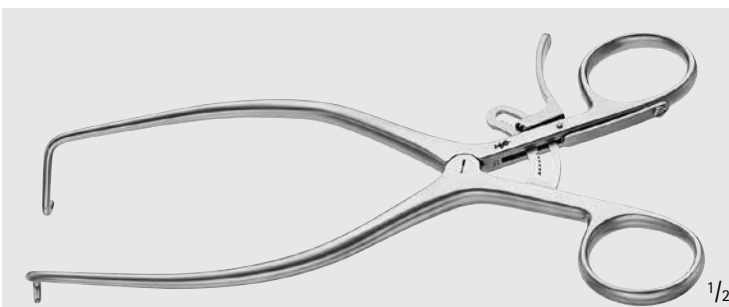

BV993R

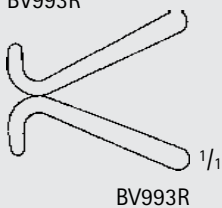

BV993R

### JACKSON-BURROWS Retractor

Catalog Number	Tip	Length (in.)
BV993R	BLUNT	7

# General Surgery

## Self Retaining Retractors



### HENLY Retractor

Catalog Number	Description	Blade Size (mm)	Blade Size (in.)	Length (in.)
BV120R	COMPLETE SET	-	-	7
MB842R	CENTER BLADE, SMALL	19 x 16	3/4 x 5/8	-
MB843R	CENTER BLADE, MEDIUM	25 x 16	1 x 5/8	-
MB844R	CENTER BLADE, LARGE	32 x 16	1 1/4 x 5/8	-
MB848R	CENTER BLADE, X-LARGE	76 x 16	3 x 5/8	-
MB845R	SIDE BLADE, PAIR (4 PRONGS)	25 x 25	1 x 1	-
MB846R	SIDE BLADE, PAIR (4 PRONGS)	51 x 25	2 x 1	-
MB847R	SIDE BLADE, PAIR (4 PRONGS)	76 x 22	3 x 1	-
MB849R	FRAME ONLY	-	-	7

BV120R Complete Set Includes:

- 1 Frame,
- 1 each of 4 Center Blades,
- 1 Pair of each of 3 Side Blades

Materials in set sold separately: MB842R-MB849R

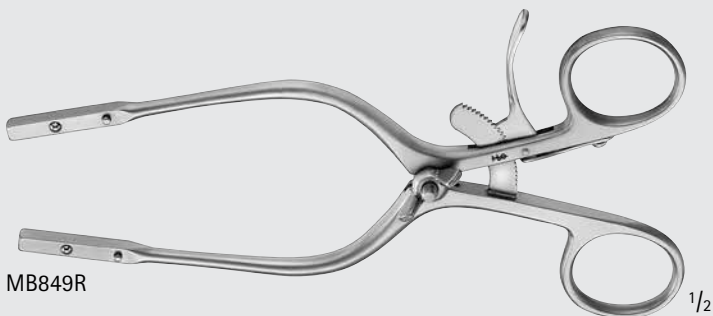
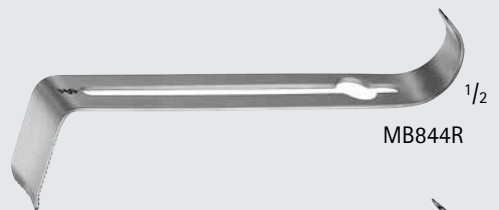
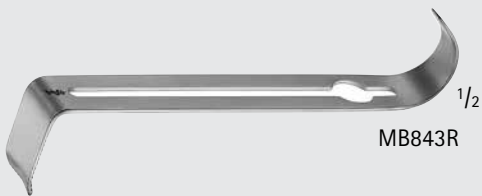
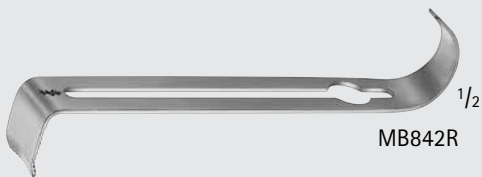

# General Surgery

## Rectal Specula Instruments

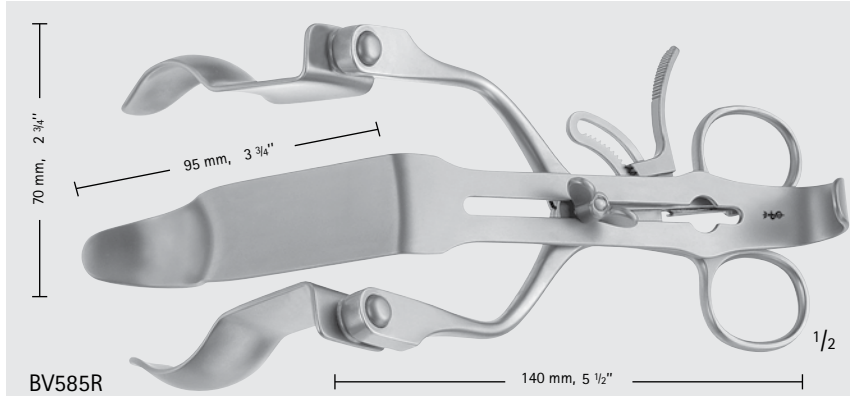

BV585R

### PARKS Rectal Spreader

Catalog Number	Item	Length (mm)
BV585R	COMPLETE SET	-
BV581R	SPREADER ONLY	-
BV582R	CENTER BLADE	-
BV583R	SIDE BLADE, PAIR	70
BV586R	SIDE BLADE, PAIR	90
BV584R	SIDE BLADE, PAIR	93
BV589R	SIDE BLADE, PAIR	150

Set Includes:

- 1 Spreader BV581R
- 1 Center Blade BV582R
- 2 Blades of each BV583R and BV584R

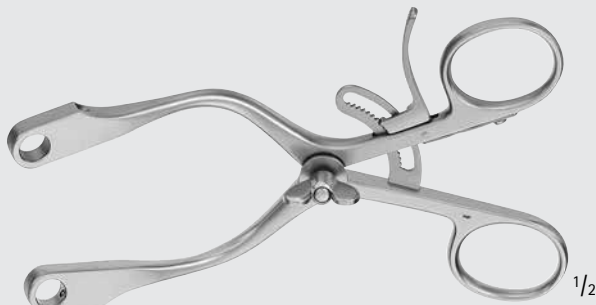

BV581R

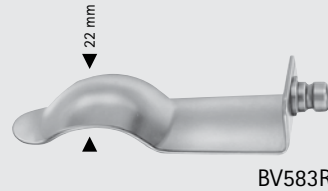

BV583R

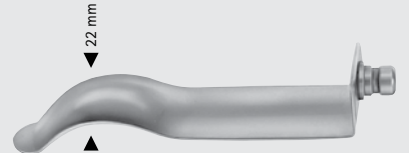

BV586R

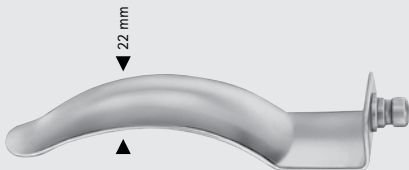

BV584R



BV589R

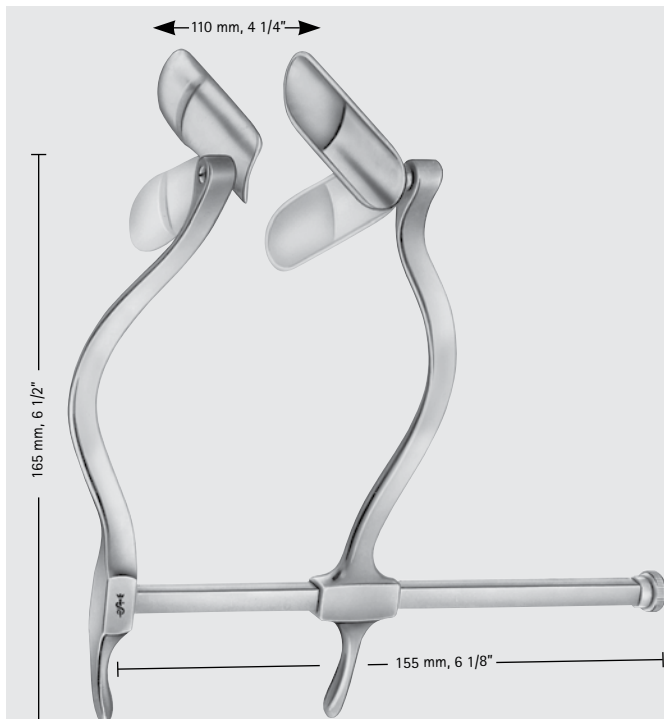

BV906R

### SMITH-BUIE Rectal Retractor

Catalog Number	Blade Size (mm)
BV906R	58 x 23

# General Surgery

## Rectal Specula Instruments

### ST. MARKS MODIFIED GIRONA Perineal Retractor

Catalog Number
BV907R

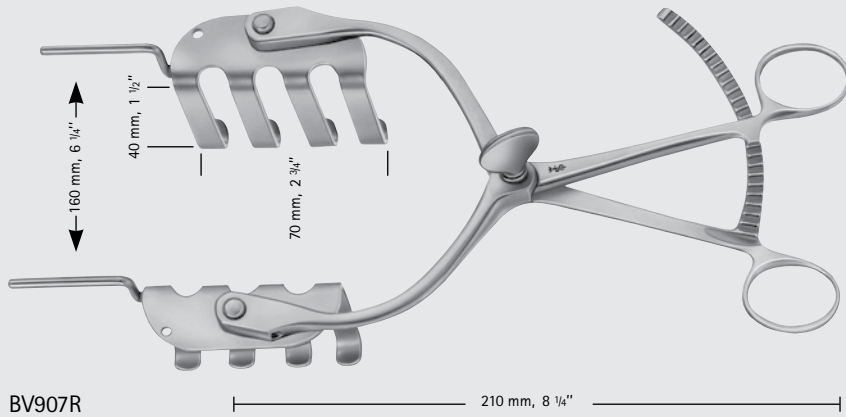

### CZERNY Rectal Speculum

Catalog Number	Length (in.)
EA800R	8 7/8

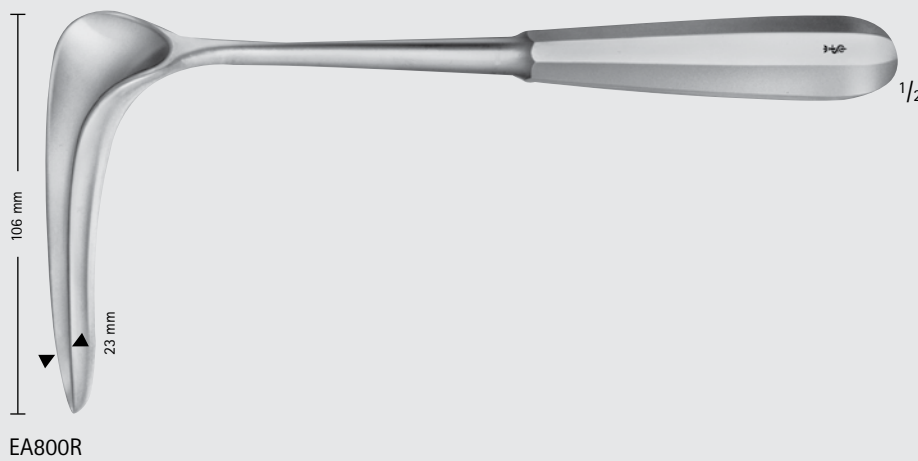

### SAWYER Retractor

Catalog Number	Size	Blade Size (mm)	Length (in.)
MB773R	SMALL	70 x 19	10 3/4
MB772R	MEDIUM	82 x 29	10 3/4
MG178R	LARGE	97 x 38	11 5/8



MB772R-MG178R



INCHES

# General Surgery

## Rectal Specula Instruments

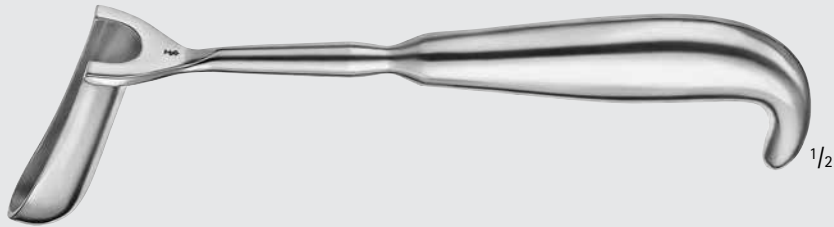

MB774R-MB776R

### HILL-FERGUSSON Rectal Retractor

Catalog Number	Blade Size (mm)	Length (in.)
MB775R	64 x 24	8 1/4
MB774R	76 x 35	8 1/4
MB776R	76 x 32	8 1/4



EA820R

### SIMS Rectal Speculum

Catalog Number	Blade	Length (in.)
EA820R	SOLID	6 1/4
EA821R	FENESTRATED	6 1/4



EA821R

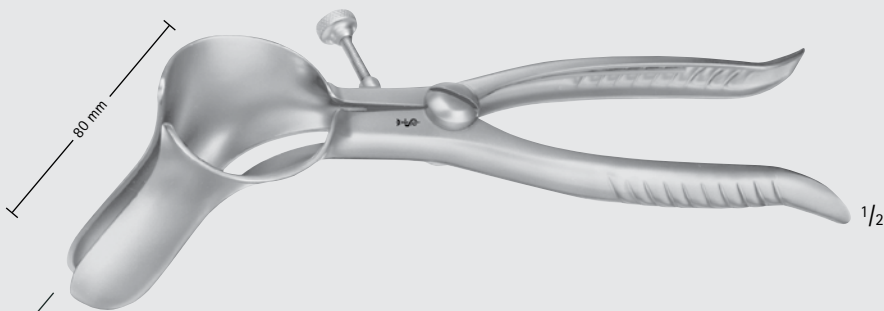

EA831R

### PRATT Rectal Speculum

Catalog Number	Length (in.)
EA831R	8

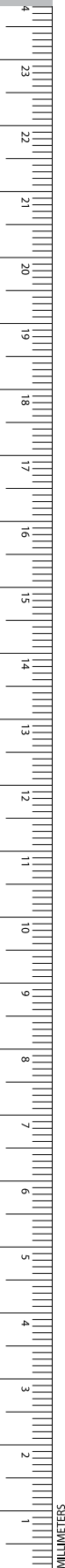

# General Surgery

## Rectal Specula Instruments

GENERAL SURGERY

### MATHIEU Rectal Speculum

Catalog Number	Length (in.)
EA843R	8 1/2

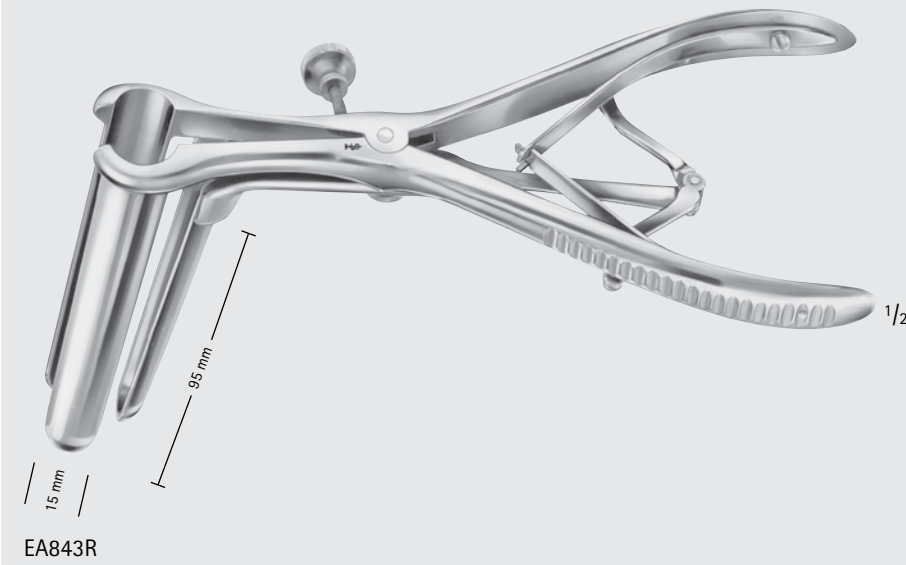

### IVES-FANSLER Anuscope

Catalog Number	Length (in.)
EA880R	5 3/4



### Rectal Speculum

Catalog Number	Length (in.)
MB274R	2 3/8



INCHES

# General Surgery

## Rectal Specula Instruments

GENERAL SURGERY

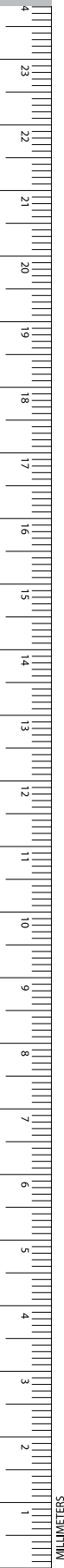

MG160R

### CHELSEA-EATON Anal Speculum

Catalog Number	Size	Diameter (mm)	Finish	Length (in.)
MG160R	SMALL	30	MIRROR FINISH	2 1/2



MB179R, MB203R, MB288R

### HIRSCHMANN Rectal Speculum

Catalog Number	Size	Blade Size (mm)
MB203R	SMALL	60 x 16
MB288R	MEDIUM	72 x 19
MB179R	LARGE	89 x 23

# General Surgery

## Rectal Specula Instruments

### BRINKERHOFF Rectal Speculum

Catalog Number	Size	Diameter (in.)	Length (in.)
MG162R	SMALL	1/2 x 1	3 3/4
MG163R	MEDIUM	5/8 x 1	3 3/4
MB284R	LARGE	3/4 x 1 1/4	4 1/2



MB284R, MG162R-MG163R

### KELLY Sphincteroscope

Catalog Number	Diameter (mm)	Working Length (mm)	Length (in.)
EA882R	21	54	6 1/4
EA887R	22	140	5 1/2
EA883R	25	50	6 1/4



Working Length

EA882R-EA887R



INCHES

# General Surgery

## Rectal Specula Instruments

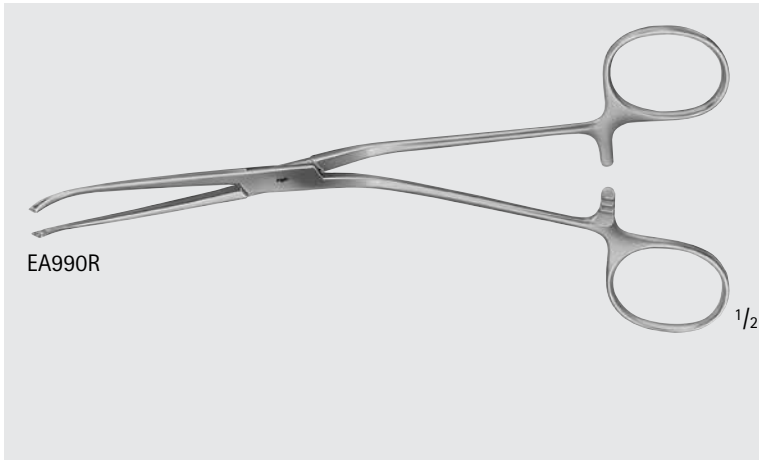

**MCGIVNEY Hemorrhoidal Forceps**

Catalog Number	Length (in.)
EA990R	7 1/4

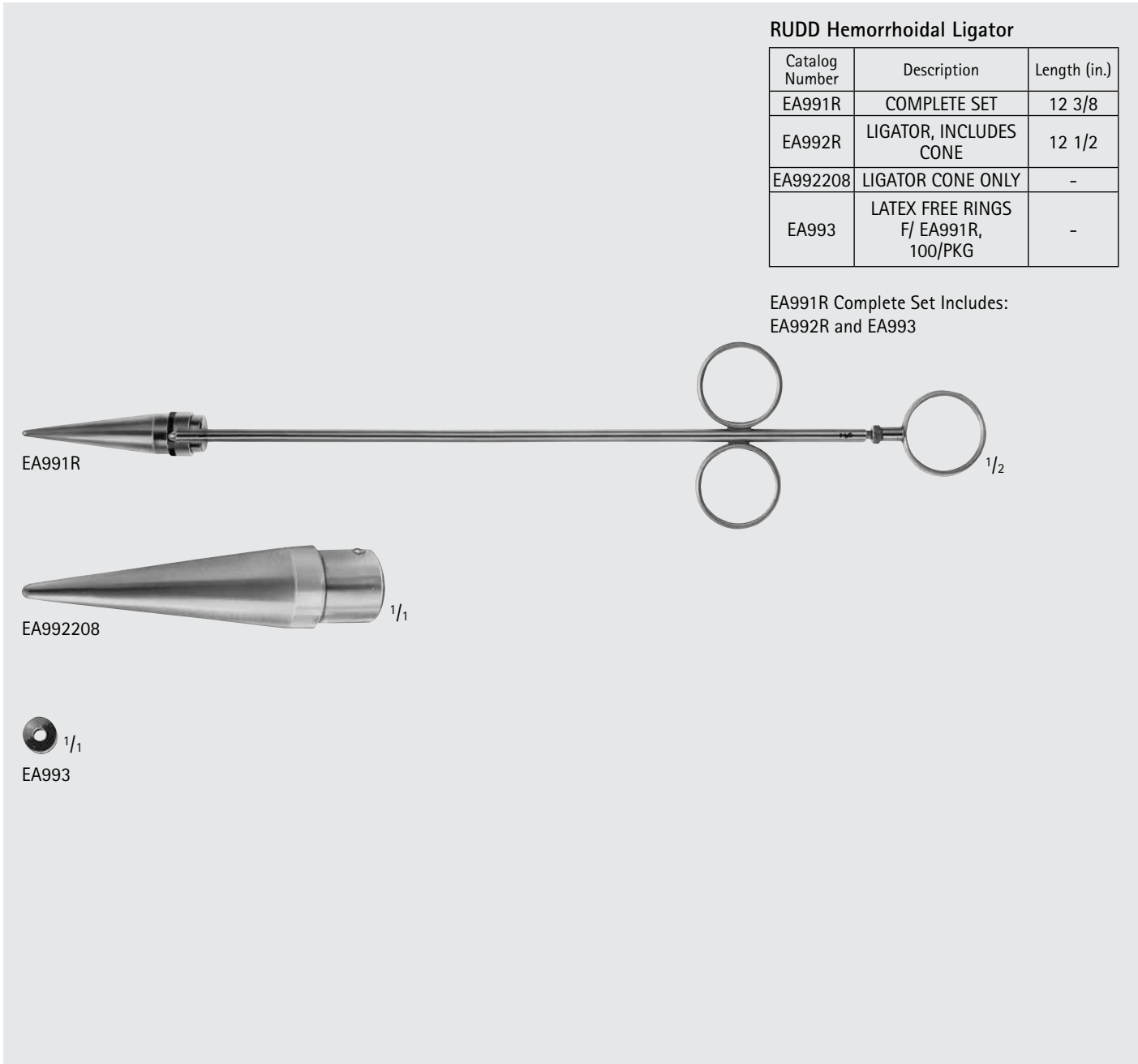

**RUDD Hemorrhoidal Ligator**

Catalog Number	Description	Length (in.)
EA991R	COMPLETE SET	12 3/8
EA992R	LIGATOR, INCLUDES CONE	12 1/2
EA992208	LIGATOR CONE ONLY	-
EA993	LATEX FREE RINGS F/ EA991R, 100/PKG	-

EA991R Complete Set Includes:  
EA992R and EA993

General Surgery  
Rectal Specula Instruments



MB892R

STEWART Crypt Hook

Catalog Number	Length (in.)
MB892R	9



MB892R



# General Surgery

## Probes, Dilators and Scoops



### BAKES Bile-Duct Dilator

Catalog Number	Tip Size (mm)	Length (in.)
EB061R	1	12 3/8
EB062R	2	12 3/8
EB063R	3	12 3/8
EB064R	4	12 3/8
EB065R	5	12 3/8
EB066R	6	12 1/2
EB067R	7	12 1/2
EB068R	8	12 1/2
EB069R	9	12 1/2
EB070R	10	12 1/2
EB071R	11	12 1/2
EB072R	12	12 1/2
EB073R	13	12 1/2
EB074R	SET, 3-11 mm	-



EB061R-EB074R

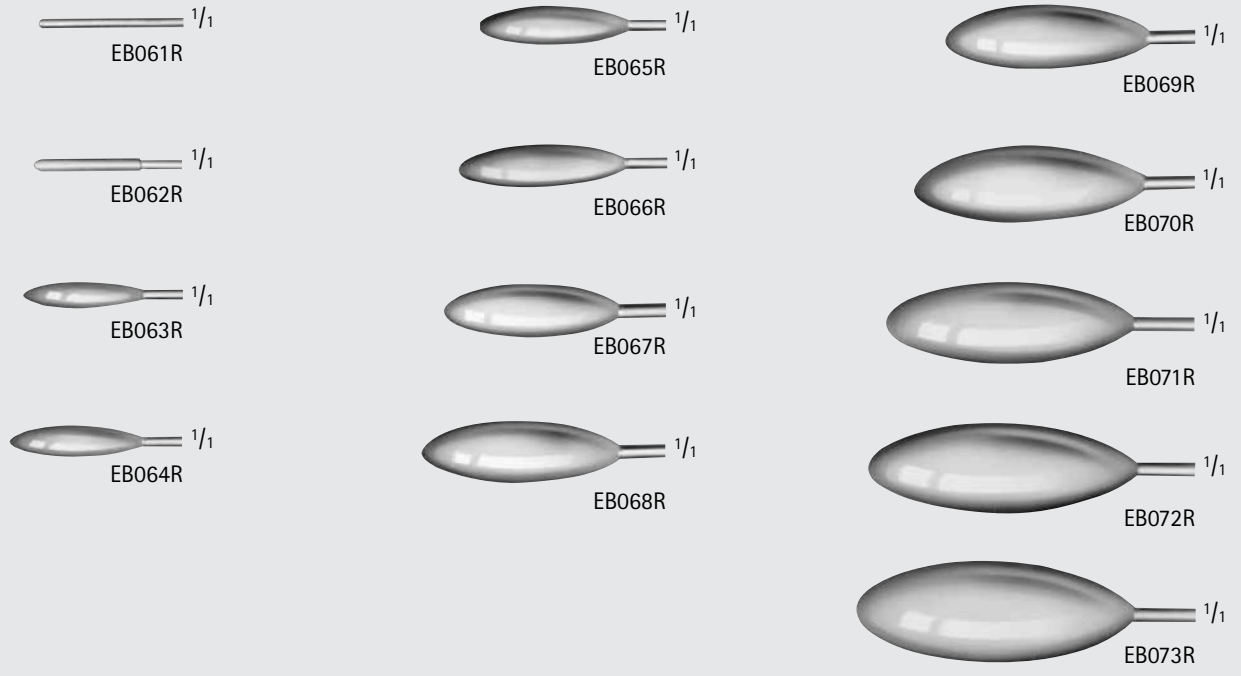

LUER-KOERTE Scoops, Malleable Shaft

Catalog Number	Tip Size (mm)	Length (in.)
EB168R	2.8	12 3/4
EB169R	3.4	12 3/4
EB170R	4.3	12 3/4
EB171R	5.5	12 3/4
EB172R	6.7	12 3/4
EB173R	8.0	12 3/4
EB174R	11.0	12 3/4
EB175R	15.0	12 3/4



EB168R-EB175R

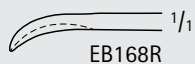

EB168R

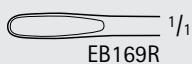

EB169R



EB170R

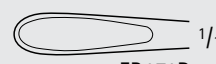

EB171R



EB172R

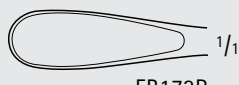

EB173R



EB174R



EB175R



BN003R-BN006R



BN003R-BN006R

Director W/ Tongue

Catalog Number	Blade Shape	Length (in.)
BN003R	STR	5 1/8
BN004R	STR	5 3/4
BN006R	STR	6 1/4



BN010R

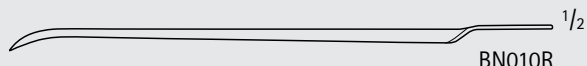

BN010R

DOYEN Director W/ Tongue

Catalog Number	Blade Shape	Length (in.)
BN010R	CVD	5 3/4

# General Surgery

## Probes, Dilators and Scoops



MB336R

### Grooved Director W/ Tongue

Catalog Number	Length (in.)
MB336R	4 1/2

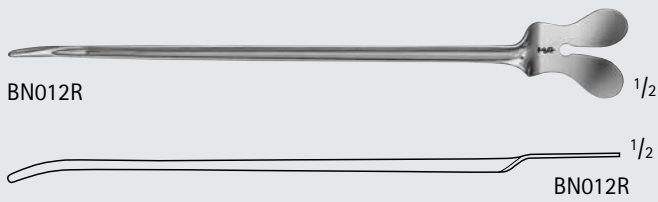

BN012R

BN012R

### NELATON Director

Catalog Number	Blade Shape	Length (in.)
BN012R	CVD	6 1/4

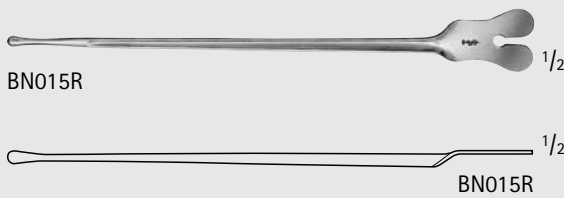

BN015R

BN015R

### Director, W/ Probe Tip & Tongue

Catalog Number	Diam. of Tip (mm)	Blade Shape	Length (in.)
BN015R	3.3	STR	5 1/2

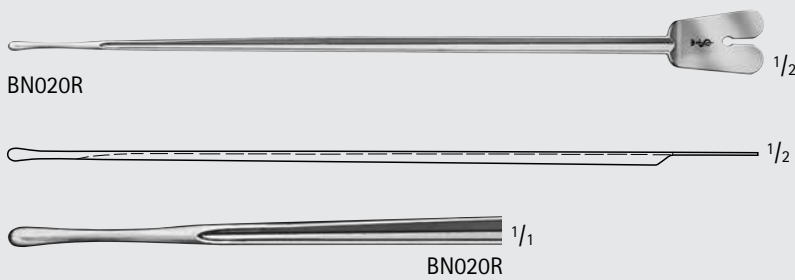

BN020R

BN020R

### BRODIE Director, W/ Probe Tip & Tongue

Catalog Number	Diam. of Tip (mm)	Blade Shape	Length (in.)
BN020R	3.5	STR	7 7/8

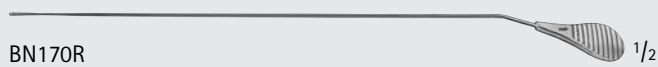

BN170R

### Probe

Catalog Number	Diam. of Tip (mm)	Length (in.)
BN170R	1.4	6 1/4

LOCKHART-MUMMERY Fistula Probe

Catalog Number	Blade Shape	Length (in.)
BN021R	#1-STR	6 1/2
BN022R	#2-SLT-CVD	6 1/2
BN023R	#3-CVD	6 1/2
BN024R	#4-HVY-CVD	6 1/2

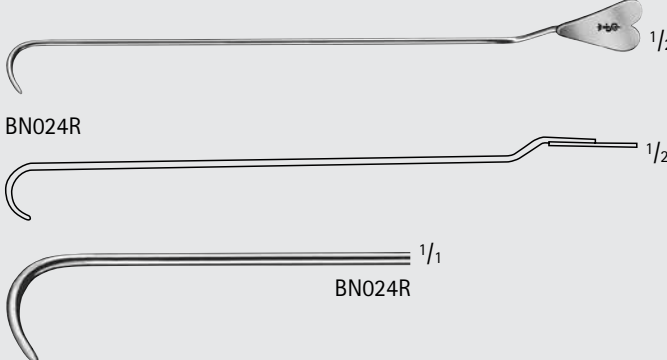
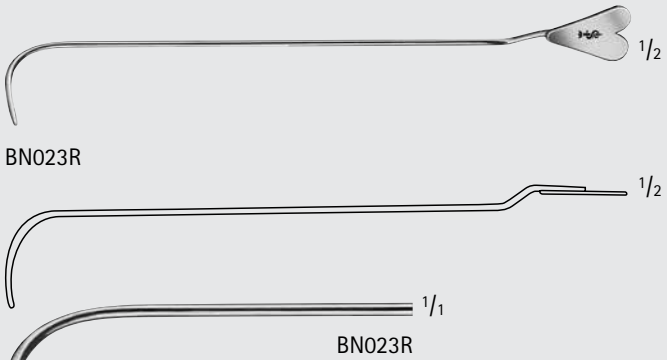
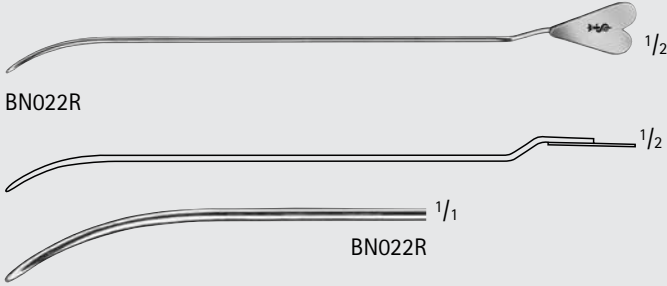
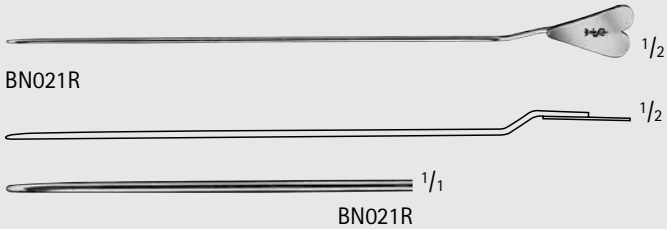

# General Surgery

## Probes, Dilators and Scoops

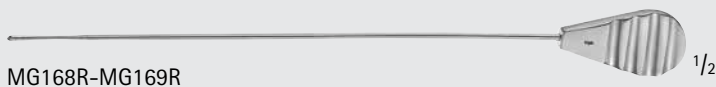

MG168R-MG169R

### BUIE Fistula Probe

Catalog Number	Description	Length (in.)
MG168R	LIGHT	6 1/2
MG169R	HEAVY	6 1/2



BN034R-BN040R, MB603R

### Probe W/ Eye

Catalog Number	Tip Size (mm)	Length (in.)
MB603R	1.5	5
BN034R	2.5	5 3/4
BN036R	2.5	6 1/4
BN040R	3	7 7/8



MG571

### Probe W/ Eye, Silver

Catalog Number	Tip Size (mm)	Length (in.)
MG571	1.75	4 1/2



BN054R



BN063R-BN070R

### Myrtle Leaf Probe

Catalog Number	Tip Size (mm)	Length (in.)
BN054R	1.5	5 3/4
BN063R	2	5 1/8
BN064R	2	5 3/4
BN066R	2	6 1/4
BN068R	2	7
BN070R	2	7 7/8

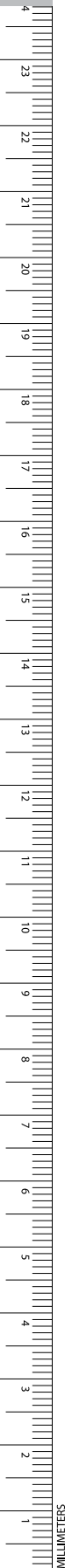

BN104R-BN150R



**Double Ended Probe**

Catalog Number	Tip Size (mm)	Length (in.)
BN104R	1.0	5 3/4
BN113R	1.5	5 1/8
BN114R	1.5	5 3/4
BN116R	1.5	6 1/4
BN118R	1.5	7
BN120R	1.5	7 7/8
BN125R	1.5	9 3/4
BN134R	2.0	5 3/4
BN136R	2.0	6 1/4
BN138R	2.0	7
BN140R	2.0	7 7/8
BN150R	2.0	11 3/4

BN090R

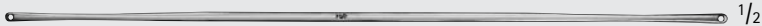

**Double Ended Probe W/ Eye, Malleable**

Catalog Number	Tip Size (mm)	Length (in.)
BN090R	3.0	7 1/2
BN095	3.5	9 3/4
BN096	3.5	11 3/4

BN095-BN096



**PRATT Rectal Probe, Malleable**

Catalog Number	Tip Size (mm)	Length (in.)
MB486	2.0	10

MB486

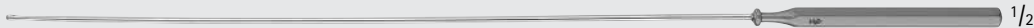

**Probe**

Catalog Number	Tip Size (mm)	Length (in.)
BN101R	2.0	11 3/4

BN101R

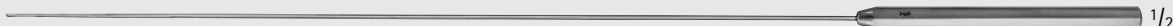

INCHES

# General Surgery

## Probes, Dilators and Scoops



### FERGUSSON Gall Stone Scoop, Double Ended

Catalog Number	Size	Length (in.)
MB697R	SMALL	9 1/2
MB698R	MEDIUM	9 1/2
MB699R	LARGE	9 1/2



MB697R-MB699R



MB697R-MB699R

### BARR Fistula Probe, Double Ended

Catalog Number	Length (in.)
MG170R	6 5/8



MG170R

### PRATT Fistula Probe, Crypt Hook

Catalog Number	Length (in.)
EA890R	9 1/2



EA890R



**ROSSER Crypt Hook**

MG165R 1/2

MG165R 1/1

Catalog Number	Length (in.)
MG165R	6 5/8

**DESJARDINS Gall Duct Probe, Flexible**

EB101R-EB103R 1/2

EB101R 1/1

EB102R 1/1

EB103R 1/1

Catalog Number	Tip Size (mm)	Length (in.)
EB101R	3.8	11 1/4
EB102R	4.3	11 1/4
EB103R	6.8	11 1/4

**DESJARDINS Gall Stone Scoop**

EB111R-EB114R 1/2

6 mm 1/1

EB111R

7 mm 1/1

EB112R

8 mm 1/1

EB113R

9 mm 1/1

EB114R

Catalog Number	Tip Size (mm)	Length (in.)
EB111R	6	11 3/4
EB112R	7	11 3/4
EB113R	8	11 3/4
EB114R	9	11 3/4

**MAYO Gall Duct Probe**

E0005R 1/2

Catalog Number	Tip Size (mm)	Tip	Length (in.)
E0005R	5	MALLEABLE	13

# General Surgery

## Scalpel Handles



### Micro Scalpel Handle

Catalog Number	Size	Length (in.)	Handle
MB104R	3H	4	Hexagonal
MB141R	3HL	6	Hexagonal
MB280R	3KM	3	Round Knurled
MB997R	3K	4	Round Knurled
MB281R	3KD	5	Round Knurled
BB046R	3K	5 1/4	Round Knurled
MB271R	3KL	6	Round Knurled
BB048R	3KL	6 1/8	Round Knurled
MG221R	3	7	Round Knurled
BB054R	3	7 7/8	Round Knurled
MG222R	3	8	Round Knurled
BB060R	3	17 3/4	Round Knurled
MB475R	COLLET		



MB104R



MB141R



MB280R



MB997R



MB281R



BB046R



MB271R



BB048R

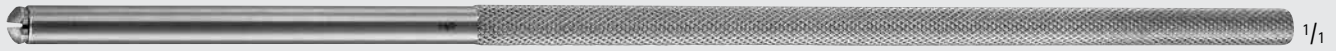

MG221R



BB054R



MG222R



BB060R



MB475R

MB475R

Replacement collet for MB104R, MB141R, MB271R, MB280R, MB281R and MB997R

CORWIN Knife Handle

Catalog Number	Length (in.)
MA203R	5 1/2



MA203R

CASPAR Scalpel Handle

Catalog Number	Length (in.)
BB052R	7

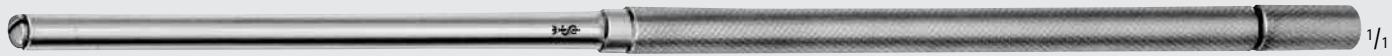

BB052R

LANDOLT Scalpel Handle,  
F/ Microsurgery Blades

Catalog Number	Length (in.)
BB053R	8 1/4
BB057R	9 3/4



BB053R



1/1



1/1

BB053R

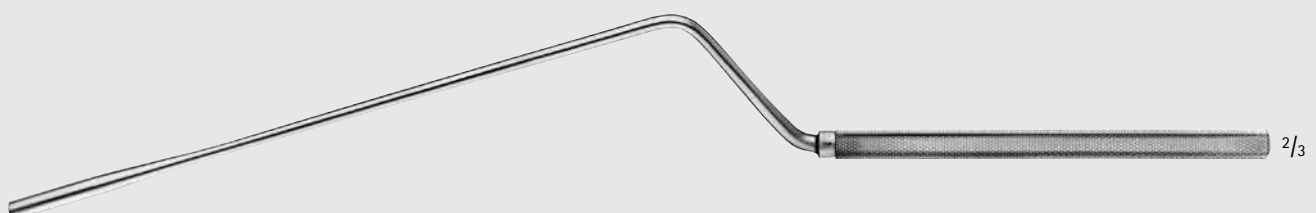

BB057R

YASARGIL Arachnoid Blades  
F/ LANDOLT Scalpel Handles

Catalog Number	Tip Size (mm)	Packaging
BB331R	1.5	10/BOX
BB332R	2.5	10/BOX



BB331R



BB332R



INCHES

# General Surgery

## Scalpel Handles

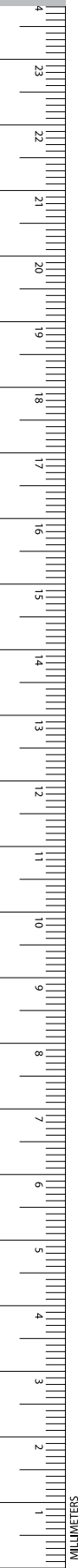

### Transsphenoidal Scalpel Handle, Bayonet, F/ Vertical and Lateral Blades

Catalog Number	Length (in.)
BB071R	8 1/4

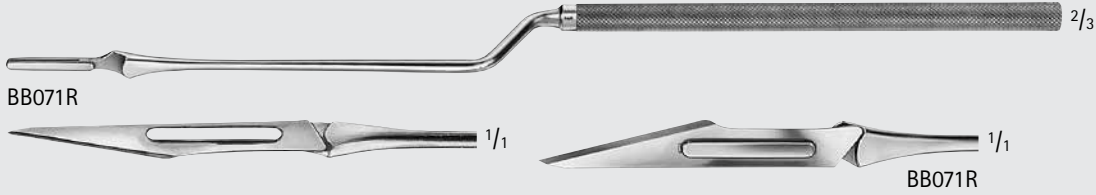

BB361R



BB362R



BB363R



BB364R



BB365R

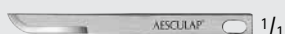

BB367R



BB368R

### Sterile Microsurgery Blades

Catalog Number	Tip	Packaging
BB361R	SMALL CHISEL #61	10/BOX
BB362R	WIDE CHISEL #62	10/BOX
BB363R	SPEAR #63	1 EACH
BB364R	ROUND #64	10/BOX
BB365R	SMALL, SHARP #65	10/BOX
BB367R	CURVED, POINTED #67	10/BOX
BB368R	SMALL SICKLE #68	10/BOX

### BARRON Scalpel Handle #3 F/ Blades nos. 10-15, 40, 42

Catalog Number	Length (in.)
BB068R	5 1/8



BB068R

### Scalpel Handle #3, F/ Blades nos. 10-15, 40, 42

Catalog Number	Length (in.)
BB070R	6 1/8

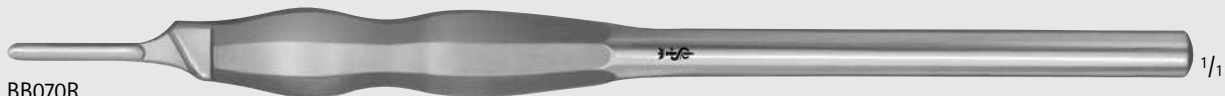

BB070R

# General Surgery

## Scalpel Handles

### Scalpel Handle #3, F/ Blades nos. 10-15, 40, 42

Catalog Number	Size	Length (in.)
BB074R	#3	5
BB075R	#3L	8 1/4
BB175R	#3XL	9 3/4
MB917R	#3	16



### Scalpel Handle #3L, F/ Blades nos. 10-15, 40, 42

Catalog Number	Blade Shape	Length (in.)
MB127R	ANG	8



### Scalpel X-Long Handle, #3, F/ Blades nos. 10-15, 40, 42

Catalog Number	Blade Shape	Length (in.)
BB078R	STR	8 7/8



# General Surgery

## Scalpel Handles

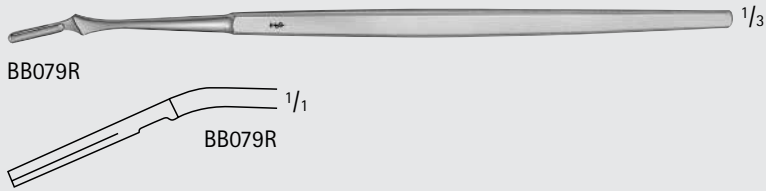

BB079R

BB079R

Scalpel X-Long Handle, #3, F/ Blades nos. 10-15, 40, 42

Catalog Number	Blade Shape	Length (in.)
BB079R	ANG	8 7/8



BB080R

Scalpel Handle #4, F/ Blade nos. 18-36

Catalog Number	Length (in.)
BB080R	8 7/8

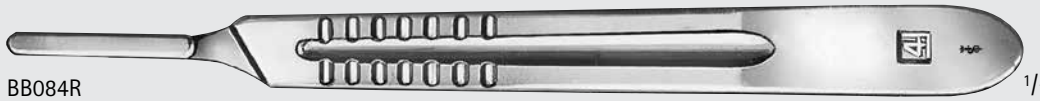

BB084R

Scalpel Handle #4, F/ Blades nos. 18-36

Catalog Number	Length (in.)
BB084R	5 1/4



BB085R

Scalpel Handle #4L, F/ Blades nos. 18-36

Catalog Number	Length (in.)
BB085R	8 1/2

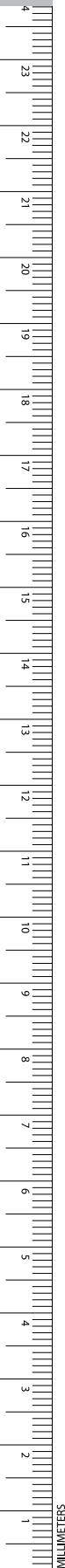

# General Surgery

## Scalpel Handles

GENERAL SURGERY

Scalpel Handle #4XL, F/ Blades nos. 18-36

Catalog Number	Length (in.)
BB087R	9 3/4



BB087R

2/3

Scalpel Handle #7, F/ Blades nos. 10-15, 40, 42

Catalog Number	Length (in.)
BB077R	6 1/4



BB077R

1/1

Scalpel Handle #9XL, F/ Blades nos. 18-36

Catalog Number	Length (in.)
MA202R	4 5/8
BB089R	5 3/4



MA202R

1/1



BB089R

1/1

INCHES

# General Surgery

## Scalpel Blades



BB510, 16600495



BB515, 16600525



BB511, 16600509



BB540 double cutting



BB512, 16600517



BB542 double cutting

### Sterile Scalpel Blade, For #3 Handle

Catalog Number		Blade Number	Packaging
Carbon	Stainless Steel		
BB510	16600495	#10	100/BOX
BB511	16600509	#11	100/BOX
BB512	16600517	#12	100/BOX
BB515	16600525	#15	100/BOX
BB540	-	#40	100/BOX
BB542	-	#42	100/BOX



BB520, 16600550



BB521, 16600568



BB522, 16600576



BB523, 16600584



BB524, 16600592



BB525, 16616634



BB536, 16615522

### Sterile Scalpel Blade, For #4 Handle

Catalog Number		Blade Number	Packaging
Carbon	Stainless Steel		
BB520	16600550	#20	100/BOX
BB521	16600568	#21	100/BOX
BB522	16600576	#22	100/BOX
BB523	16600584	#23	100/BOX
BB524	16600592	#24	100/BOX
BB525	16616634	#25	100/BOX
BB536	16615522	#36	100/BOX



BB500, 16600487

### Sterile Stitch Cutter Blade #3 Handle

Catalog Number		Packaging
Carbon	Stainless Steel	
BB500	16600487	100/BOX

GENERAL SURGERY

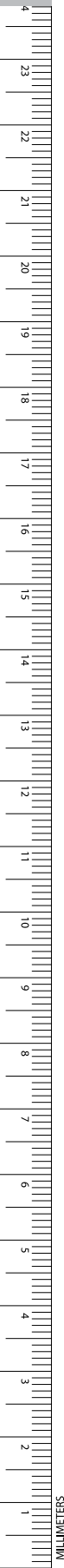

# General Surgery

## Sterile Scalpels With Plastic Handle

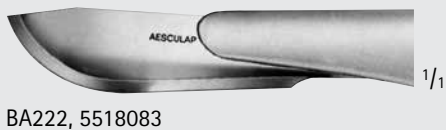
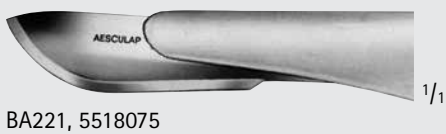
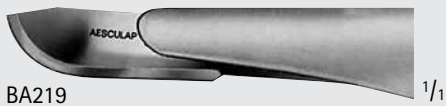

### Sterile Scalpels W/ Plastic Handle and Blade Protector

Carbon	Catalog Number		Size	Packaging
	Carbon	Stainless Steel		
	BA210	5518059	10	10/BOX
	BA211	5518040	11	10/BOX
	BA212	5518105	12	10/BOX
	BA215	5518032	15	10/BOX
	BA218	-	18	10/BOX
	BA219	-	19	10/BOX
	BA220	5518067	20	10/BOX
	BA221	5518075	21	10/BOX
	BA222	5518083	22	10/BOX
	BA223	5518016	23	10/BOX
	BA224	5518091	24	10/BOX



# General Surgery

## Amputation and Autopsy Instruments



### LISTON Amputating Knife

Catalog Number	Blade Length (mm)	Blade Size (in.)
FH100R	130	5 1/8
FH101R	160	6 1/4
FH102R	190	7 1/2
FH103R	220	8 3/4



FH100R-FH103R

### CATLIN Amputating Knife, Double Cutting

Catalog Number	Blade Length (mm)	Blade Size (in.)
FH116R	160	6 1/4



FH116R

1/2

# General Surgery

## Amputation and Autopsy Instruments



### CHARRIÈRE Amputation Saw, 2 Blades

Catalog Number	Item	Blade Size (in.)	Blade Width (mm)	Total Length (in.)
FH300R	SAW COMPLETE W/2 BLADES	8 1/2	-	14
FH301C	CARBON STEEL BLADE	8 1/2	12	-
FH302C	CARBON STEEL BLADE	8 1/2	18	-



FH300R



FH301C-FH302C

### CHARRIÈRE Amputation Saw

Catalog Number	Item	Blade Size (in.)	Total Length (in.)
FH320R	SAW COMPLETE	7 1/4	10 1/2



FH320R

### SATTERLEE Amputation Saw

Catalog Number	Item	Total Length (in.)
FH325R	SAW COMPLETE	11 1/2
FH326R	CARBON STEEL BLADE F/ FH325R	-

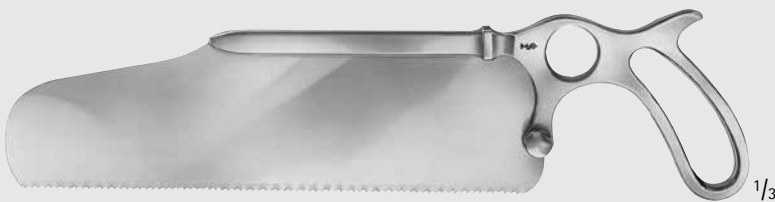

FH325R-FH326R

# General Surgery

## Amputation and Autopsy Instruments



**LANGENBECK Metacarpal Saw**

Catalog Number	Length (in.)
FH335R	9 1/4

FH335R 1/2

**GIGLI Wire Saw**

Catalog Number	Diameter (mm)	Wires	Sales Unit	Length (in.)
FH414	1.4	6	BOX OF 5	15 3/4
FH415	1.4	6	BOX OF 5	19 3/4
FH430R	1.8	4	BOX OF 5	19 3/4

FH414-FH415, FH430R 5/1

FH414-FH415, FH430R

**GIGLI Saw Handle**

Catalog Number	Packaging
MB986R	2/SET

MB986R

**GIGLI Hook Handle, F/ Wire Saws**

Catalog Number	Packaging
FH480R	2/SET

FH480R 1/2

### POOLE Suction Tube

Catalog Number	Handle	Tip Size (FR)	Hole in Tip Inner/Outer	Tube Diameter Inner/Outer	Length (in.)
MG272R	STR	30	YES/YES	5 mm/10 mm	8 1/2
GF862R	STR	30	YES/NO	5 mm/10 mm	8 7/8
MB927R	STR	30	YES/YES	4 mm/10 mm	14
MB928R	STR	30	YES/YES	4 mm/10 mm	16
MG271R	CVD	24	YES/NO	4 mm/8 mm	8 3/4
GF860R	CVD	21	YES/YES	4 mm/8 mm	8 7/8



MG272R



GF862R



MB927R-MB928R



MB927R



MB928R



MG271R



GF860R



INCHES

# General Surgery

## Suction Tubes

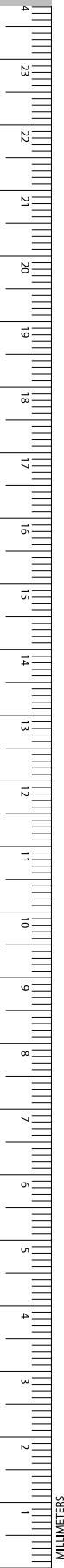

Diam. 4 mm

Olive Diam. 9 mm

1/2

GF917R

Catalog Number	Tip Size (mm)	Tip Size (FR)	Length (in.)
GF917R	4	11	7 1/2

Olive Diam. 6 - 9 mm

1/2

GF919R

Catalog Number	Tip Size (mm)	Length (in.)
GF919R	5	7

Diam. 8 mm Outer Tube

Olive Diam. 9 - 11 mm

1/2

GF821R

Catalog Number	Tip Size (mm)	Length (in.)
GF821R	8.0	13 1/4

COOLEY Suction Tube W/ Detachable Tip

Catalog Number	Tip Size (mm)	Shaft	Length (in.)
GF822R	8.0	SLT-CVD	12 1/4
GF823R	9.0	CVD	11 5/8
GF824R	8.0	ANG	12 1/2
GF825R	9.0	90°	10 1/2



GF822R

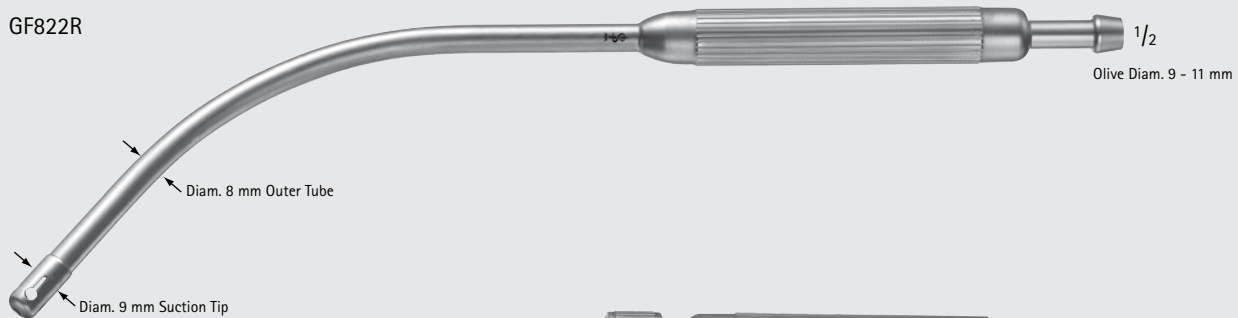

GF823R



GF824R

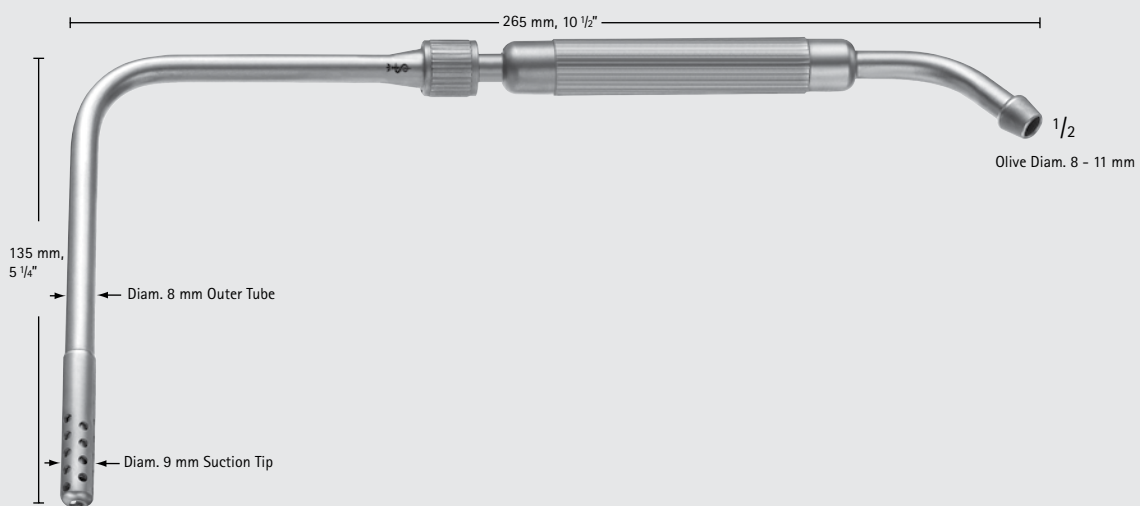

GF825R



INCHES

# General Surgery

## Suction Tubes

### Grafting Suction Tube

Catalog Number	Tip Size (mm)	Length (in.)
MB286R	3	9 1/2
MB287R	4	9 1/2



MB286R-MB287R

### DEBAKEY Suction Tube

Catalog Number	Tip Size (mm)	Length (in.)
GF946R	3	10 3/4
GF947R	5	6 1/4
GF948R	5	10 5/8
GF946205	REPLACEMENT TIP FOR GF946R	-



GF946R



Diam. 9 mm

GF946R



GF947R

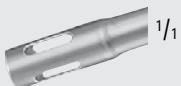

Diam. 5 mm

GF947R

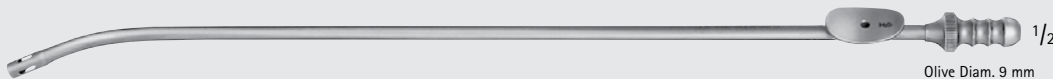

GF948R



Diam. 5 mm

GF948R

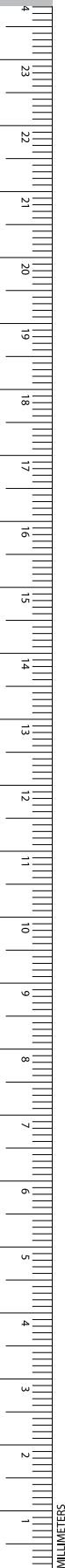

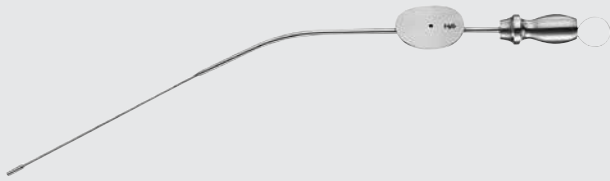

MF333R-MF347R

Atraumatic Suction Tube

Catalog Number	Tip Size (FR)	Working Length (in.)	Length (in.)
MF333R	3	3	6 1/4
MF334R	5	3	6 1/4
MF335R	7	3	6 1/4
MF336R	10	3	6 1/4
MF337R	12	3	6 1/4
MF338R	3	4	7 1/4
MF339R	5	4	7 1/4
MF340R	7	4	7 1/4
MF341R	10	4	7 1/4
MF342R	12	4	7 1/4
MF343R	3	5	8 1/4
MF344R	5	5	8 1/4
MF345R	7	5	8 1/4
MF346R	10	5	8 1/4
MF347R	12	5	8 1/4

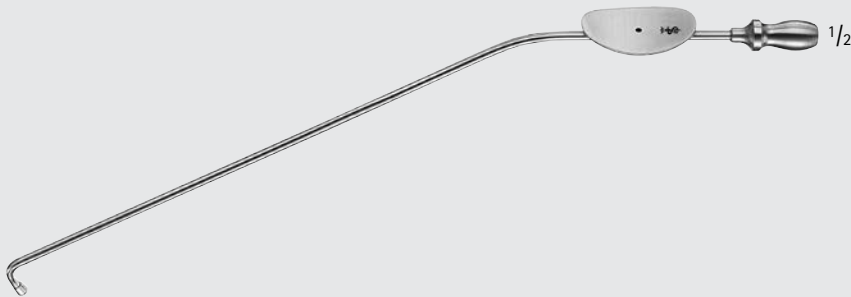

MF106R-MF111R

Atraumatic Suction Tube

Catalog Number	Tip	Tip Size (FR)	Length (in.)
MF106R	90° DOWN	5	8 1/2
MF107R	90° DOWN	7	8 1/2
MF108R	90° DOWN	10	8 1/2
MF109R	90° UP	5	8 1/2
MF110R	90° UP	7	8 1/2
MF111R	90° UP	10	8 1/2



MF106R-MF108R



MF109R-MF111R



INCHES

# General Surgery

## Suction Tubes

### YANKAUER Suction Tube

Catalog Number	Description	Tip Opening (mm)	Length (in.)
GF944R	-	2.0	11 1/4
OM671R	-	4.8	11 1/4
MB919R	-	2.0	12
MG092R	W/ VALVE	2.0	13 1/4
MB051R	-	2.0	14
MB920R	W/ VALVE	2.0	16
GF944200	REPLACEMENT TIP F/ GF944R	-	-
OM671200	REPLACEMENT TIP F/ OM671R	-	-
MB051200	REPLACEMENT TIP F/ MB051R, MB053R, MG919R, MG920R	-	-
MG092200	REPLACEMENT TIP F/ MG092R	-	-

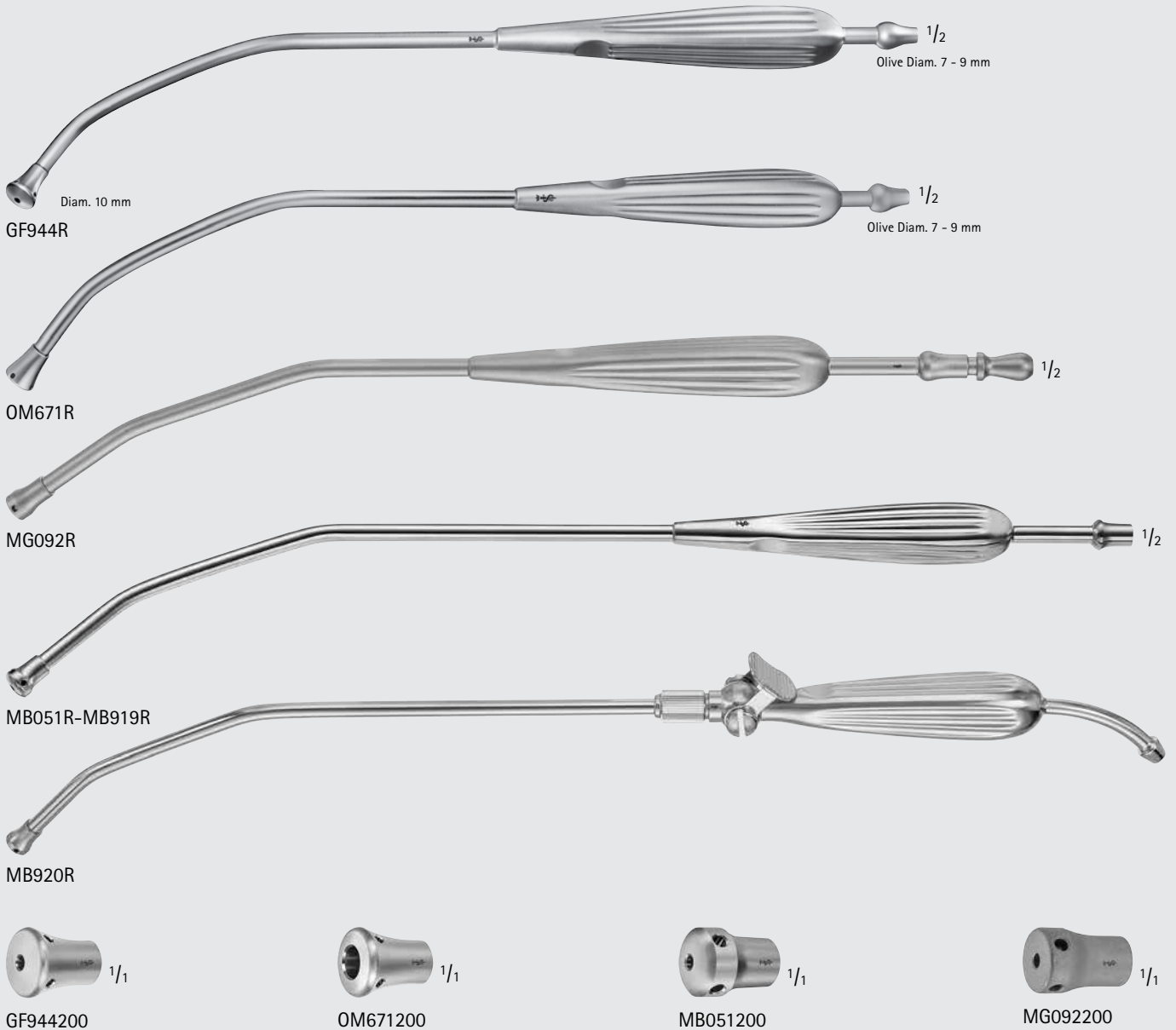



MB052R

**YANKAUER Suction W/ Thumb Control**

Catalog Number	Description	Length (in.)
MB052R	HANDLE W/ THUMB CONTROL	6 7/8
MB053R	SUCTION TUBE, CHROME PLATED	6 5/8

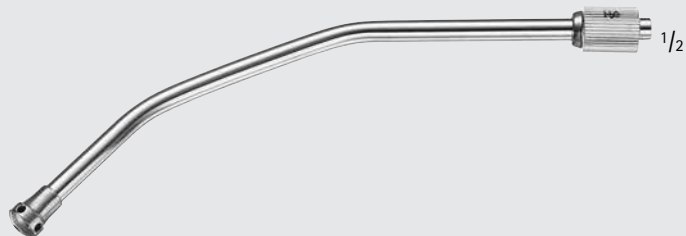

MB053R

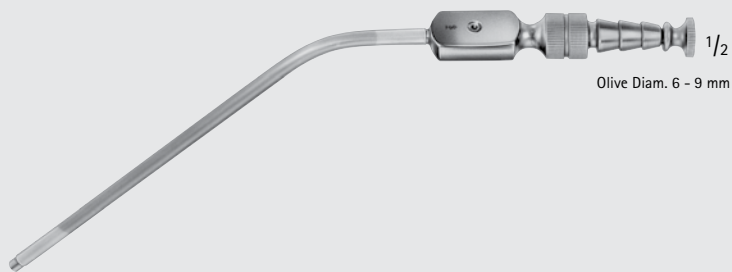

GF933R

**FERGUSON Suction Tube**

Catalog Number	Tip	Tip Size (mm)	Length (in.)
GF933R	ROUND	4	7

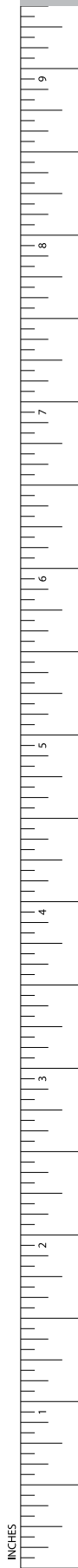

INCHES

# General Surgery

## Suction Tubes

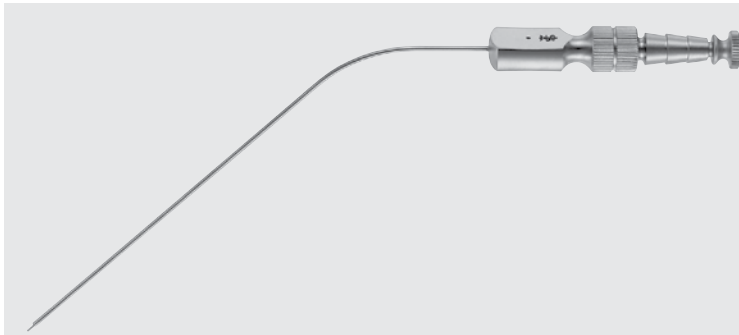

GF350R-GF385R

### FERGUSSON Suction Tube, Luer Hub

Catalog Number	Diameter (mm)	Working Length (in.)	Length (in.)
GF350R	1.5	4 1/4	7 3/4
GF351R	2.0	4 1/4	7 3/4
GF352R	2.5	4 1/4	7 3/4
GF353R	3.0	4 1/4	7 3/4
GF354R	4.0	4 1/4	7 3/4
GF355R	5.0	4 1/4	7 3/4
GF360R	1.5	5 1/8	8 1/2
GF361R	2.0	5 1/8	8 1/2
GF362R	2.5	5 1/8	8 1/2
GF363R	3.0	5 1/8	8 1/2
GF364R	4.0	5 1/8	8 1/2
GF365R	5.0	5 1/8	8 1/2
GF370R	1.5	6 1/4	9 5/8
GF371R	2.0	6 1/4	9 5/8
GF372R	2.5	6 1/4	9 5/8
GF373R	3.0	6 1/4	9 5/8
GF374R	4.0	6 1/4	9 5/8
GF375R	5.0	6 1/4	9 5/8
GF380R	1.5	7 7/8	11
GF381R	2.0	7 7/8	11
GF382R	2.5	7 7/8	11
GF383R	3.0	7 7/8	11
GF384R	4.0	7 7/8	11
GF385R	5.0	7 7/8	11

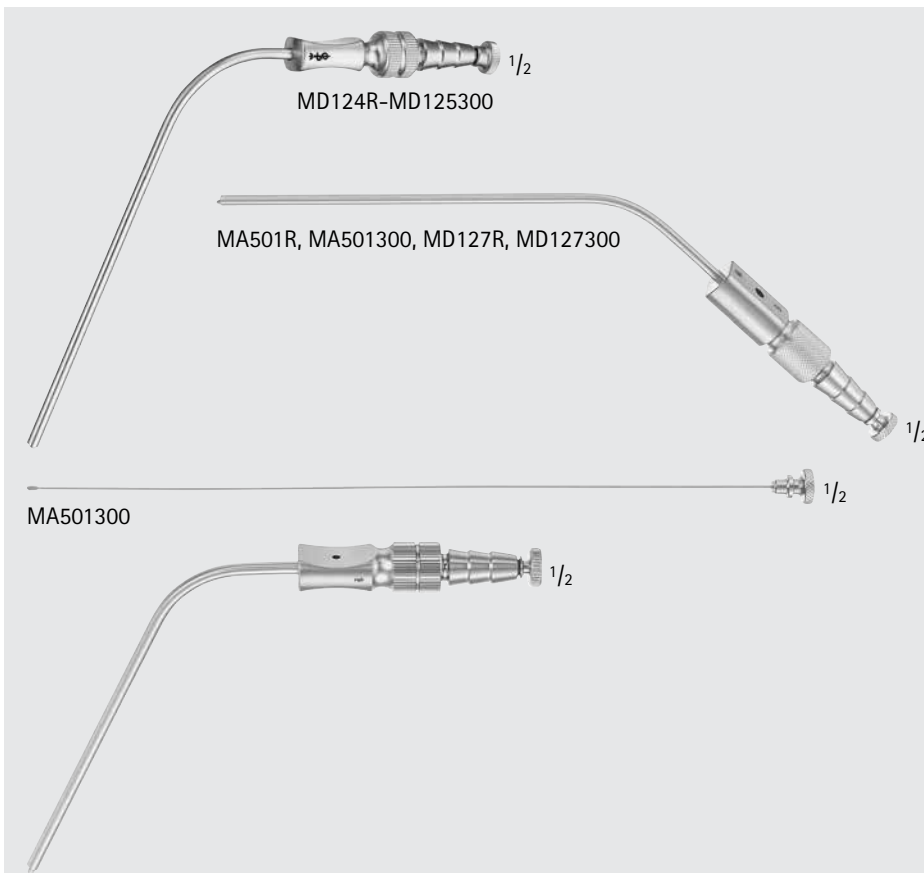

MD124R-MD125300

MA501R, MA501300, MD127R, MD127300

MA501300

MA499R, MA499300, MD129R, MD129300

### FRAZIER Suction Tube

Catalog Number	Tip Size (FR)	Description	Working Length (in.)
MD124R	7		4 1/4
MD124300	7	SUCTION STYLET W/ OLIVE TIP FOR MD124R	
MD125R	7		4 1/4
MD125300	8	SUCTION STYLET W/ OLIVE TIP FOR MD125R	
MA501R	9		4 1/4
MA501300		SUCTION STYLET W/ OLIVE TIP FOR MA501R	
MD127R	10		4 1/4
MD127300	10	SUCTION STYLET W/ OLIVE TIP FOR MD127R	
MA499R	11		4 1/4
MA499300	11	SUCTION STYLET W/ OLIVE TIP FOR MA499R	
MD129R	12		4 1/4
MD129300	12	SUCTION STYLET W/ OLIVE TIP FOR MD129R	



MF479R-MF489R, MF499R-MF508R

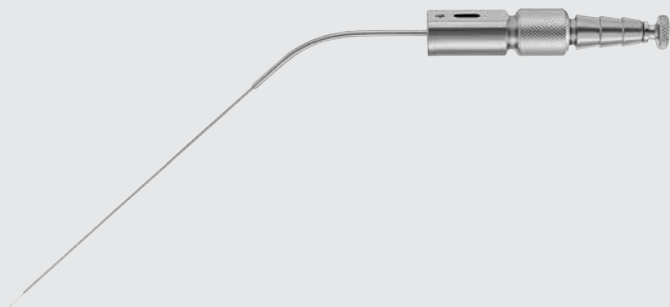

MF489R-MF498R, MF509R-MF518R

FRAZIER Slotted Suction Tube

Catalog Number	Tip Size (FR)	Shaft	Length (in.)
MF479R	3	STR	5 1/2
MF480R	4	STR	5 1/2
MF481R	5	STR	5 1/2
MF482R	6	STR	5 1/2
MF483R	7	STR	5 1/2
MF484R	8	STR	5 1/2
MF485R	9	STR	5 1/2
MF486R	10	STR	5 1/2
MF487R	11	STR	5 1/2
MF488R	12	STR	5 1/2
MF499R	3	STR	7
MF500R	4	STR	7
MF501R	5	STR	7
MF502R	6	STR	7
MF503R	7	STR	7
MF504R	8	STR	7
MF505R	9	STR	7
MF506R	10	STR	7
MF507R	11	STR	7
MF508R	12	STR	7
MF489R	3	ANG	5 1/2
MF490R	4	ANG	5 1/2
MF491R	5	ANG	5 1/2
MF492R	6	ANG	5 1/2
MF493R	7	ANG	5 1/2
MF494R	8	ANG	5 1/2
MF495R	9	ANG	5 1/2
MF496R	10	ANG	5 1/2
MF497R	11	ANG	5 1/2
MF498R	12	ANG	5 1/2
MF509R	3	ANG	7
MF510R	4	ANG	7
MF511R	5	ANG	7
MF512R	6	ANG	7
MF513R	7	ANG	7
MF514R	8	ANG	7
MF515R	9	ANG	7
MF516R	10	ANG	7
MF517R	11	ANG	7
MF518R	12	ANG	7



INCHES

# General Surgery

## Suction Tubes

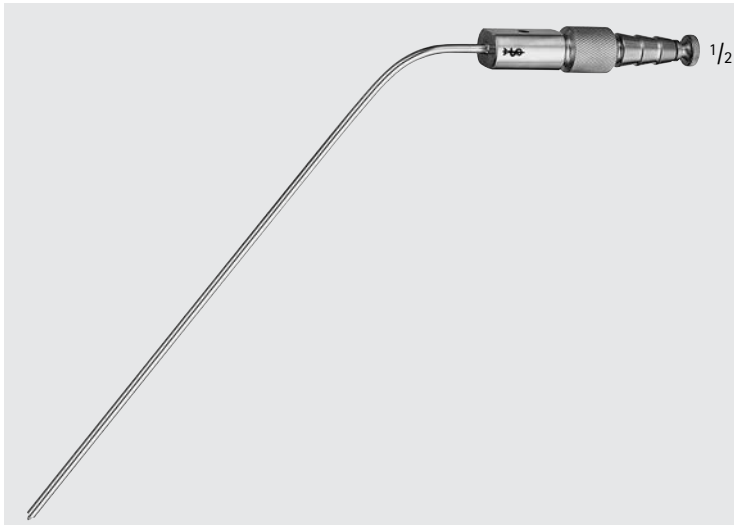

MD091-MD099

### FRAZIER Long-Suction Tube

Catalog Number	Tip Size (FR)	Length (in.)
MD091	3	6 1/2
MD092	5	6 1/2
MD093	6	6 1/2
MD094	7	6 1/2
MD095	8	6 1/2
MD096	9	6 1/2
MD097	10	6 1/2
MD098	11	6 1/2
MD099	12	6 1/2



GF923R-GF925R

### FRAZIER Suction Tube W/ Luer Hub

Catalog Number	Tip Size (FR)	Length (in.)
GF923R	9	7
GF925R	15	7

- Teardrop shaped thumb control for a very precise suction regulation
- Malleable material for individual forming of the suction hose
- Conical design of the tube prevents plugging
- Delivered with stylet

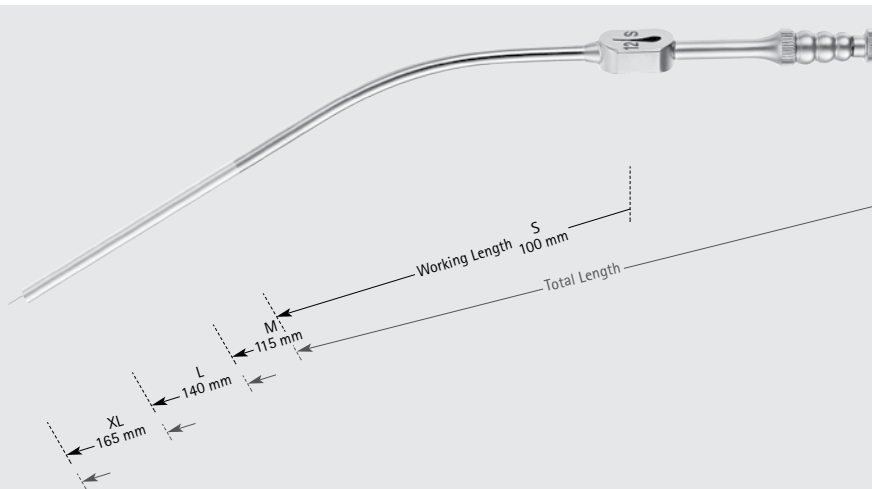

GF391R-GF429R

Suction Tube, Fukushima Style, W/ Tapered Teardrop Control

Catalog Number	Size	Tip Size (mm)	Tip Size (FR)	Working Length (in.)	Length (in.)
GF401R	S	1.0	3	4	6 1/2
GF402R	S	1.4	4	4	6 1/2
GF403R	S	1.7	5	4	6 1/2
GF404R	S	2.0	6	4	6 1/2
GF405R	S	2.3	7	4	6 1/2
GF406R	S	2.7	8	4	6 1/2
GF407R	S	3.0	9	4	6 1/2
GF408R	S	3.3	10	4	6 1/2
GF409R	S	4.0	12	4	6 1/2
GF391R	M	1.0	3	4 1/2	7
GF392R	M	1.4	4	4 1/2	7
GF393R	M	1.7	5	4 1/2	7
GF394R	M	2.0	6	4 1/2	7
GF395R	M	2.3	7	4 1/2	7
GF396R	M	2.7	8	4 1/2	7
GF397R	M	3.0	9	4 1/2	7
GF398R	M	3.3	10	4 1/2	7
GF399R	M	4.0	12	4 1/2	7
GF411R	L	1.0	3	5 1/2	8
GF412R	L	1.4	4	5 1/2	8
GF413R	L	1.7	5	5 1/2	8
GF414R	L	2.0	6	5 1/2	8
GF415R	L	2.3	7	5 1/2	8
GF416R	L	2.7	8	5 1/2	8
GF417R	L	3.0	9	5 1/2	8
GF418R	L	3.3	10	5 1/2	8
GF419R	L	4.0	12	5 1/2	8
GF421R	XL	1.0	3	6 1/2	9
GF422R	XL	1.4	4	6 1/2	9
GF423R	XL	1.7	5	6 1/2	9
GF424R	XL	2.0	6	6 1/2	9
GF425R	XL	2.3	7	6 1/2	9
GF426R	XL	2.7	8	6 1/2	9
GF427R	XL	3.0	9	6 1/2	9
GF428R	XL	3.3	12	6 1/2	9
GF429R	XL	4.0	12	6 1/2	9



# General Surgery

## Suction Tubes



GF980R

olive diam. 6 - 9 mm

1/2

**LANDOLT Dissecting Suction Tube**

Catalog Number	Tip	Tip Size (mm)	Length (in.)
GF980R	ANG, SHARP	3.2	7 7/8

MB635R-MB636R

1/2

**SACHS Suction Tube**

Catalog Number	Tip Size	Length (in.)
MB635R	SMALL	8 1/2
MB636R	LARGE	8 1/2

US106-US107

1/2

**PRIBRAM Suction Tube with Thumb Control**

Catalog Number	Tip	Length (in.)
US106	16	5 1/2
US107	18	5 1/2

MG100R-MG110R

1/2

**OCHSNER Trocar**

Catalog Number	Tip Size (FR)	Length (in.)
MG100R	10	6
MG101R	12	6
MG102R	14	6
MG103R	16	6
MG104R	18	6
MG105R	20	6
MG106R	22	6
MG107R	24	6
MG108R	26	6
MG109R	27	6
MG110R	28	6



AA804R-AA806R

Steel Ruler, Graduated In Millimeters and Inches

Catalog Number	Length (in.)
AA804R	6
AA805R	11 3/4
AA806R	19 3/4

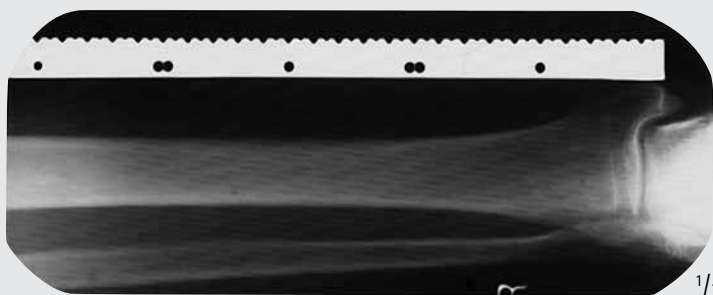

AA808R

Ruler, F/ X-Ray Work

Catalog Number	Length (in.)
AA808R	19 3/4

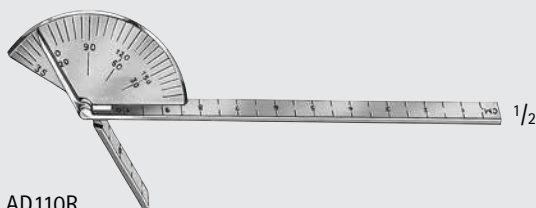

AD110R

Finger-Goniometer

Catalog Number	AD110R
----------------	--------

# General Surgery

## Accessories



MG001R-MG004R

### Surgical Spoon

Catalog Number	Size	Blade Size (mm)	Length (in.)
MG003R	SMALL	25	4 1/4
MG002R	MEDIUM	30	5 1/4
MG004R	MEDIUM-LARGE	35	6 1/4
MG001R	LARGE	40	7 1/2



783101-783102

1/2

### Staple Remover

Catalog Number	Description
783102	REUSABLE
783101	SINGLE USE (BOX OF 6)



MG377R-MG378R

### TAYLOR Percussion Hammer

Catalog Number	Size	Length (in.)
MG377R	SMALL	7
MG378R	LARGE	7 3/4

**Metal Sponge Bowl**

Catalog Number	Capacity (qts.)
US061	1
US060	1 1/2
US062	1 7/8



US060-US062

1/2

**Metal Cup**

Catalog Number	Item	Capacity (oz.)
US066	MEDICINE CUP	2
US063	IODINE CUP	6
US067	SOLUTION BASIN	12
US065	IODINE CUP	14
US064	GRADUATED MEASURE	32



US063-US067

1/2

**Kidney Tray**

Catalog Number	Length (in.)
JG504R	6 3/4
JG506R	9 3/4



JG504R-JG506R



INCHES

# General Surgery

GENERAL SURGERY

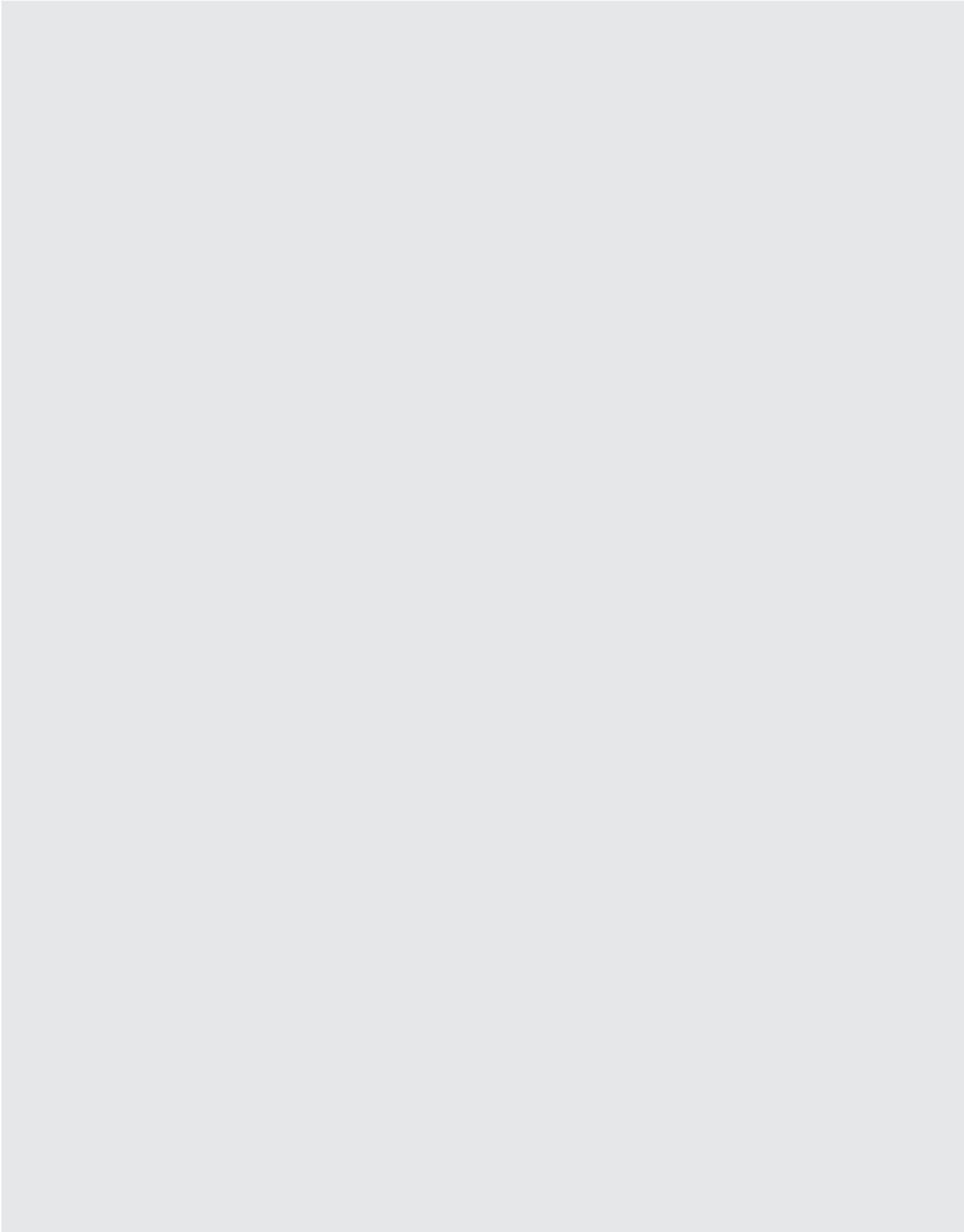
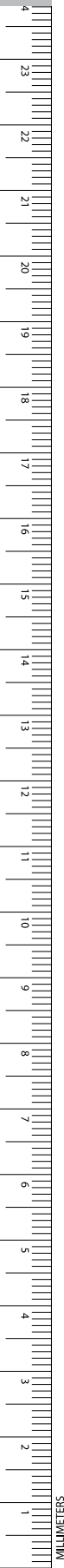



## ENT-EAR

Scissors .....	536
Needles .....	537 - 538
Tissue, Dressing and Sponge Forceps .....	539 - 542
Alligator Forceps .....	543 - 549
Nippers, Crimping Forceps and Snares .....	550 - 553
Hooks and Probes .....	554 - 555
Retractors .....	556 - 557
Picks .....	558 - 561
Specula .....	562 - 567
Cotton Applicators .....	568
Knives .....	569 - 575
Suction Irrigation .....	576 - 579
Dissectors, Chisels and Gouges .....	580 - 581
Elevators, Scrapers and Excavators .....	582 - 583
Augers, Measurers and Rasps .....	584
Curettes, Loops and Spoons .....	585 - 589
Rongeurs .....	590
Tuning Forks .....	591
Miscellaneous .....	592 - 593

# ENT-EAR

## Scissors

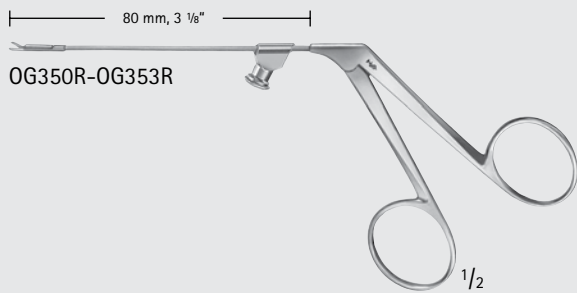

### BELLUCCI Micro Scissors

Catalog Number	Tip	Blade	Working Length (in.)	Length (in.)
OG350R	S/S	STR	3 1/8	5 1/4
OG352R	S/S	CVD-LEFT	3 1/8	5 1/4
OG353R	S/S	CVD-RIGHT	3 1/8	5 1/4
OG351R	B/B	ANG-UP	3 1/8	5 1/4

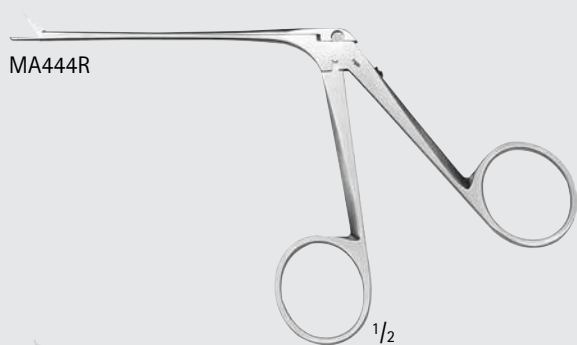

### BELLUCCI Scissors

Catalog Number	Tip	Blade	Blade Size (mm)	Working Length (in.)	Length (in.)
MA444R	B/B	STR	7	3	5 1/4
OG355R	S/S	CVD-UP	-	3 1/8	5 1/4

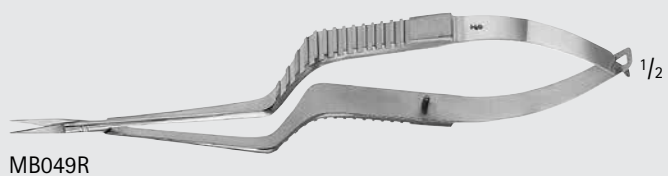
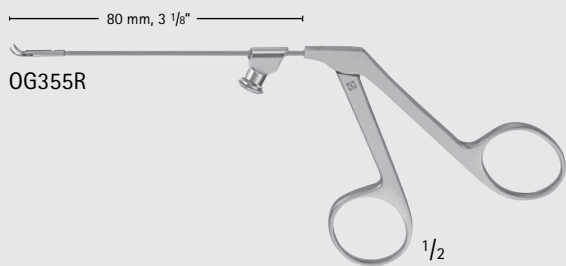
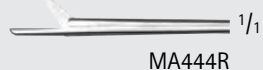

### WIET Ear Scissors, Bayonet-Shaped

Catalog Number	Tip	Blade	Length (in.)
MB049R	S/S	STR	6 1/2

ENT  
EAR

MILLIMETERS

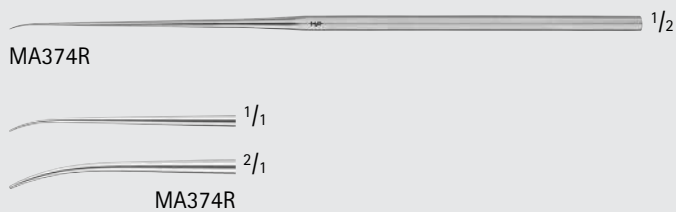
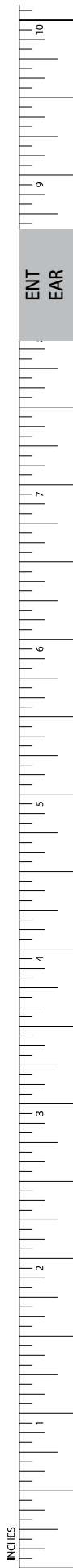

**HOUSE Needle**

Catalog Number	Tip	Blade Shape	Length (in.)
MA374R	DEL	CVD	6 1/2

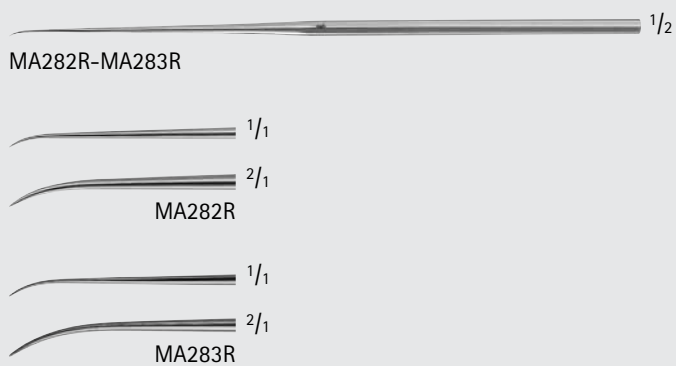

**HOUSE Needle, Malleable**

Catalog Number	Tip	Blade Angle	Length (in.)
MA282R	SEMI-SHARP	CVD	6 1/2
MA283R	W/ ROSEN POINT, SEMI-SHARP	CVD	6 1/2

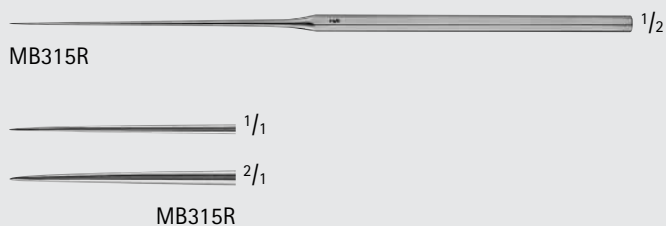

**HOUSE-BARBARA Needle**

Catalog Number	Tip	Blade Angle	Length (in.)
MB315R	SHARP	STR	6 1/2

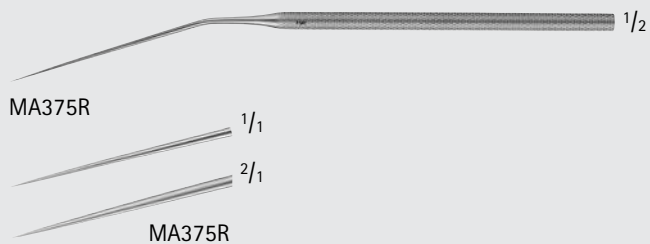

**MCGEE Perforating Needle**

Catalog Number	Tip	Blade Angle	Length (in.)
MA375R	SHARP	ANG 20°	6 3/8

# ENT-EAR

## Needles

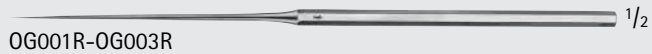

OG001R



OG002R

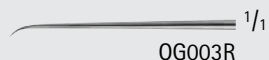

OG003R

### Micro Needles

Catalog Number	Tip	Blade Angle	Length (in.)
OG001R	SHARP-POINT	STR	6 1/4
OG002R	SHARP-POINT	CVD	6 1/4
OG003R	SHARP-POINT	HEAVY-CVD	6 1/4



MA376R



1/1



2/1

MA376R

### PAPARELLA Needle, Malleable, Heavy

Catalog Number	Tip Size (#)	Blade Angle	Working Length (in.)	Length (in.)
MA376R	6	STR	2 3/4	6 1/2

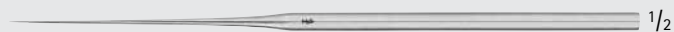

MA377R



1/1

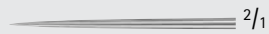

2/1

MA377R

### SAUNDERS-PAPARELLA Needle, Malleable, Fine

Catalog Number	Tip Size (#)	Blade Angle	Working Length (in.)	Length (in.)
MA377R	5	STR	2 3/4	6 1/2



MA378R



1/1  
MA378R

### WRIGHT Fascia Needle

Catalog Number	Tip	Tip Size (mm)	Length (in.)
MA378R	CVD	2	5 1/8

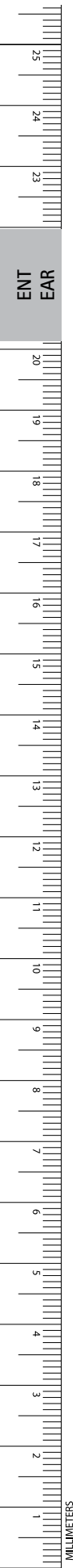



MA550R



MA550R

**SHEEHY Ossicle Holding Forceps**

Catalog Number	Length (in.)
MA550R	4 3/4

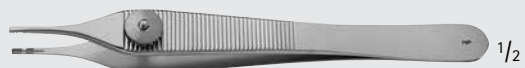

MA703R



MA703R

**DERLACKI Ossicle Holding Forceps**

Catalog Number	Tip	Length (in.)
MA703R	1 MM TEETH W/ VERTICAL AND HORIZONTAL GROOVE	5



OF405R



OF405R



OF403R



OF403R

**HARTMANN Tampon Forceps**

Catalog Number	Tip	Length (in.)
OF405R	HEAVY	5
OF403R	DELICATE	5 1/4

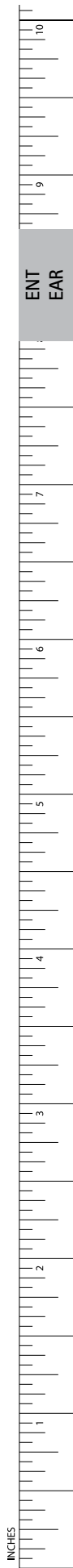

INCHES

# ENT-EAR

## Tissue/Dressing/Sponge Forceps

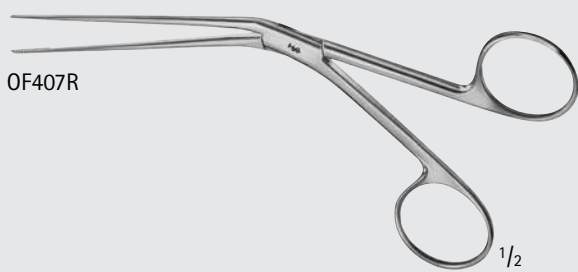

### TILLEY Ear Tampon Forceps

Catalog Number	Tip	Length (in.)
OF407R	X-DEL	5 1/2

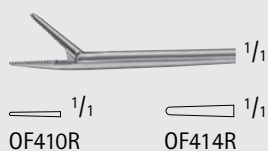
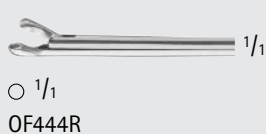
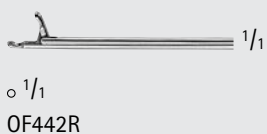
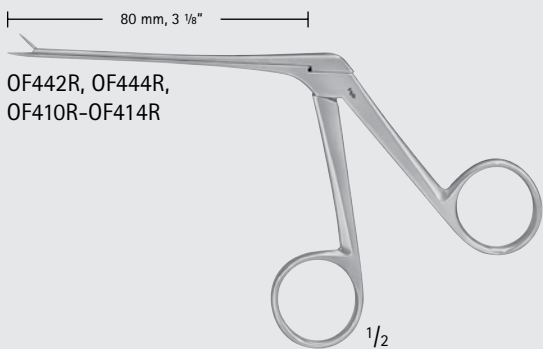

### HARTMANN-WULLSTEIN Ear Forceps

Catalog Number	Tip Size (mm)	Jaw	Working Length (in.)
OF442R	1	STR, CUP	3 1/8
OF444R	2	STR, CUP	3 1/8
OF410R	0.5 x 6	STR, SERR	3 1/8
OF414R	1 x 8	STR, SERR	3 1/8

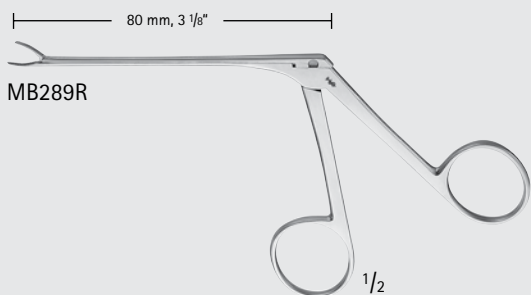

### WEINGARTNER Ear Forceps

Catalog Number	Jaw	Working Length (in.)
MB289R	SERR	3 1/8

ENT  
EAR

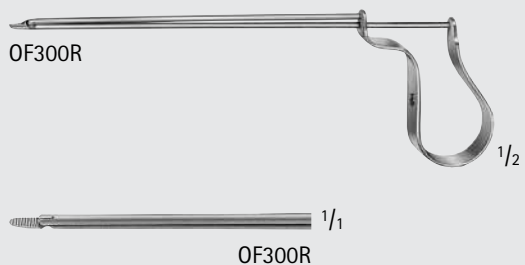
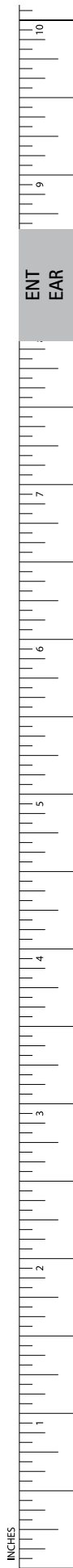

**QUIRE Foreign Body Forceps**

Catalog Number	Working Length (in.)	Length (in.)
OF300R	3 1/2	4 3/4

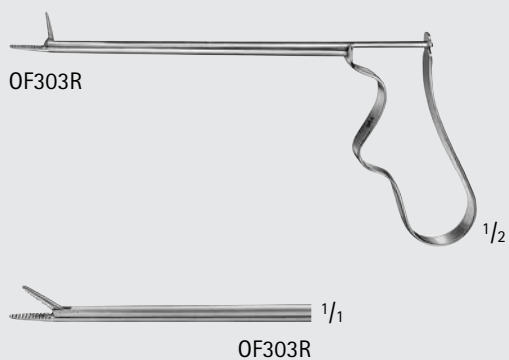

**BUCK Alligator Forceps**

Catalog Number	Working Length (in.)	Length (in.)
OF303R	1 7/8	3 1/2

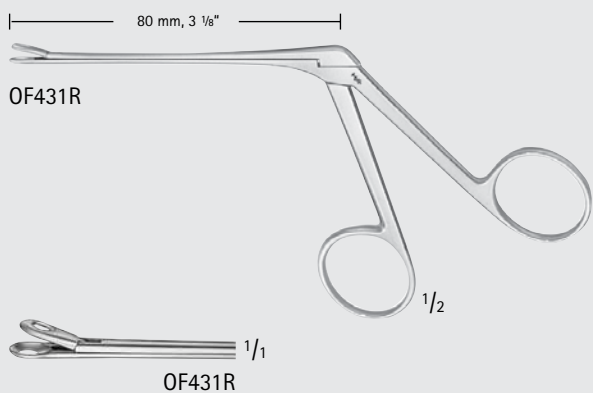

**HENCKEL Spoon Forceps**

Catalog Number	Tip Size (mm)	Jaw	Working Length (in.)
OF431R	3 x 5	FLAT, OVAL SPOON	3 1/8

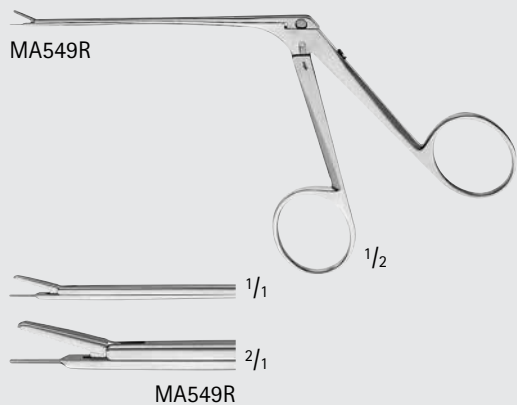

**LEIVERS Vent Tube Introducer Forceps**

Catalog Number	Working Length (in.)	Length (in.)
MA549R	2 7/8	5 3/8

# ENT-EAR

## Tissue/Dressing/Sponge Forceps

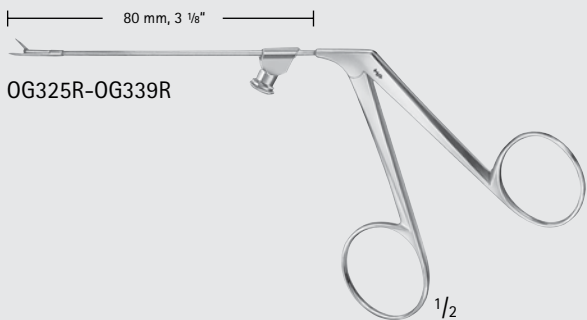
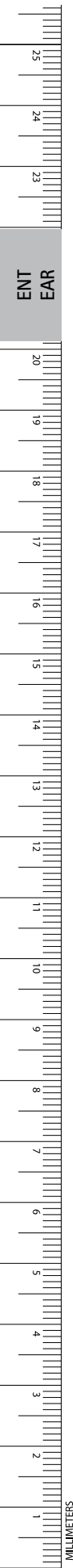

OG325R-OG339R

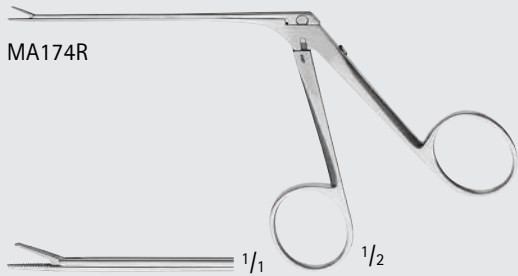

MA174R

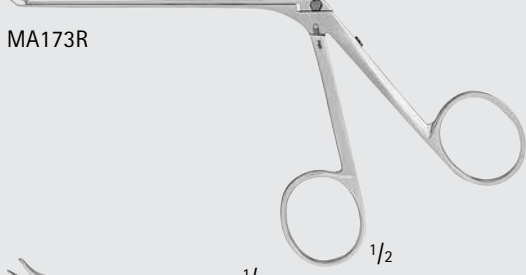

MA173R



### Alligator Forceps, Serrated

Catalog Number	Tip Size (mm)	Jaw	Working Length (in.)
OG330R	0.8 x 3.5	STR	3 1/8
OG335R	1 x 5	STR	3 1/8
OG325R	1.5 x 6.0	STR	3 1/8
MA174R	4	STR	3 1/8
OG338R	1 x 5	CVD-LEFT	3 1/8
OG339R	1 x 5	CVD-RIGHT	3 1/8
OG332R	0.8 x 3.5	ANG-DOWN 45°	3 1/8
OG331R	0.8 x 3.5	ANG-UP 55°	3 1/8
MA173R	4	ANG-UP	3

# ENT-EAR

## Alligator Forceps

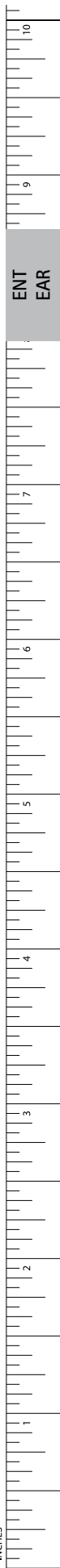

### BELLUCCI Alligator Ear Forceps

Catalog Number	Tip Size (mm)	Jaw	Working Length (in.)
MA159R	8	STR, SERR	3 1/4

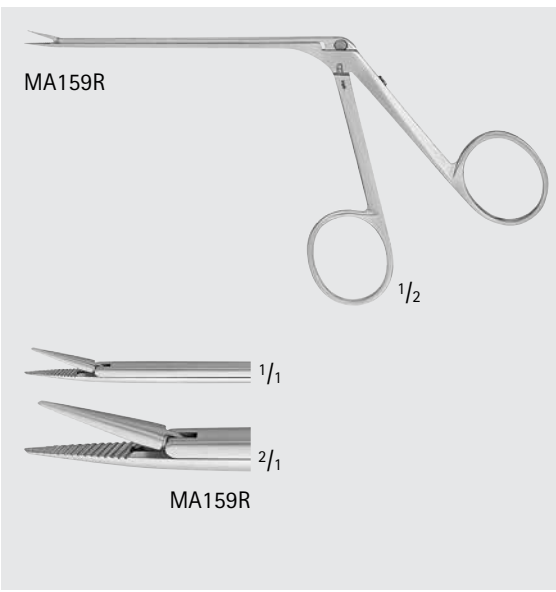

### Alligator Ear Forceps, Ebony

Catalog Number	Tip Size (mm)	Jaw	Working Length (in.)
MA659R	0.8 x 4.5	STR, SERR	3

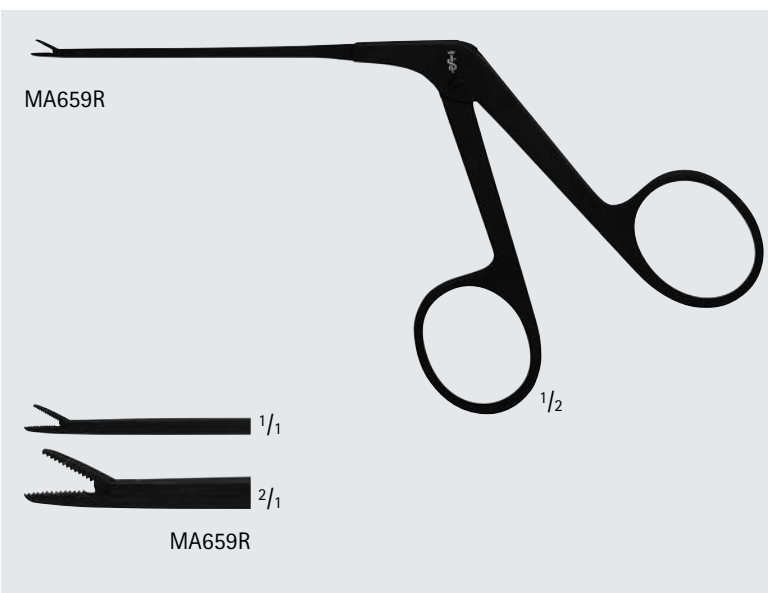

### HARTMANN Ear Forceps

Catalog Number	Tip Size (mm)	Jaw	Working Length (in.)
OF411R	1 x 8	STR, SERR	3 1/8
OF420R	1 x 8	STR, 1 x 2 TEETH	3 1/8

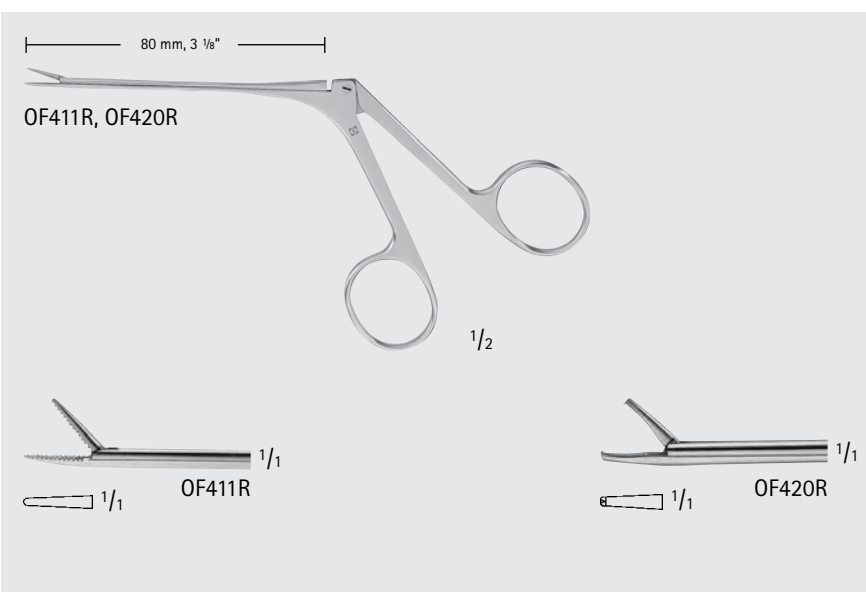

INCHES

# ENT-EAR

## Alligator Forceps

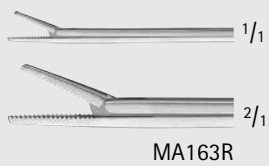
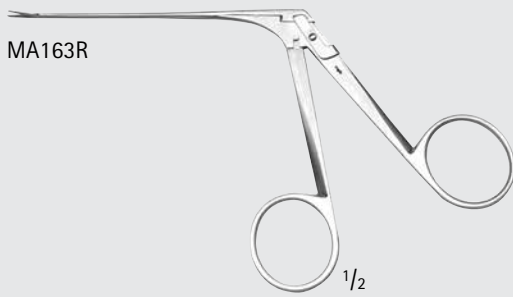

### HOUSE Alligator Ear Forceps, Horizontal Opening

Catalog Number	Tip Size (mm)	Jaw	Working Length (in.)
MA163R	6	SERR	3 1/8

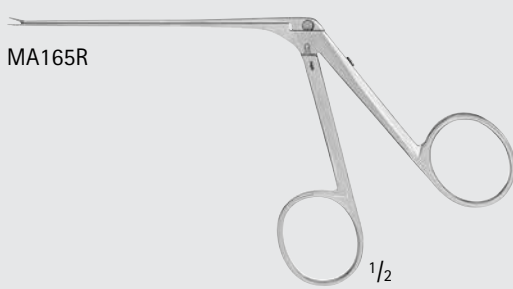

### HOUSE Miniature Alligator Ear Forceps, Delicate

Catalog Number	Tip Size (mm)	Jaw	Working Length (in.)
MA165R	4	SERR	3 1/8

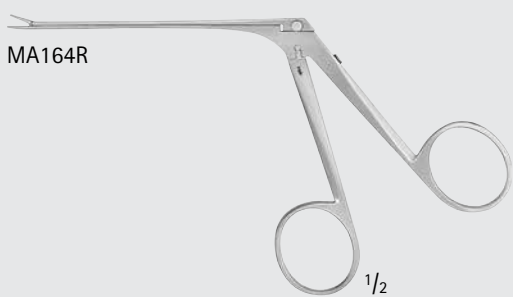

### HOUSE Strut Forceps

Catalog Number	Tip Size (mm)	Jaw	Working Length (in.)
MA164R	6	STR, SMOOTH	3 1/8

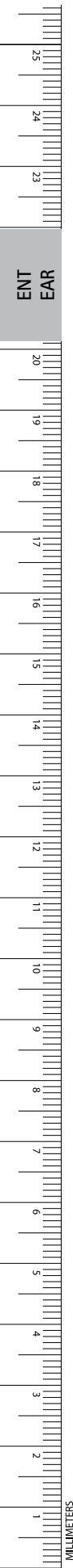

# ENT-EAR

## Alligator Forceps

### NOYES Ear Forceps

Catalog Number	Tip Size (mm)	Jaw	Working Length (in.)
MA168R	6	SERR	3
MA169R	7	SERR, 1 x 2 TEETH	3

MA168R-MA169R



1/2



1/1



2/1

MA168R



1/1



2/1

MA169R

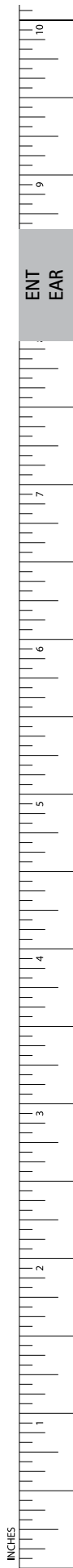

# ENT-EAR

## Alligator Cup and Punch Forceps

MA248R-MA249R

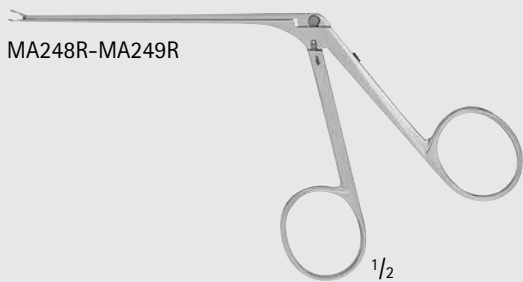

1/2



MA248R



MA249R

### Cup Forceps

Catalog Number	Jaw	Cup Size (mm)	Working Length (in.)
MA249R	FINE	0.7 x 1.0	2 3/4
MA248R	EXTRA FINE	0.9 x 2.0	2 3/4

MA240R-MA241R



3 1/8



MA240R



MA241R

MA242R

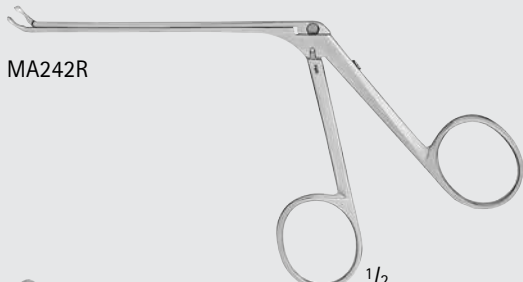

3 1/8



MA242R

### HARTMANN-HERZFELD Cup Forceps

Catalog Number	Jaw	Cup Size (mm)	Working Length (in.)
MA240R	STR	1.5	3 1/8
MA241R	STR	3.0	3 1/8
MA242R	UPBITE	2.0	3 1/8

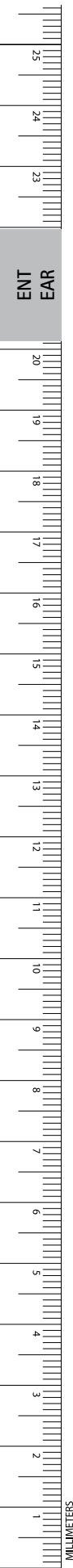

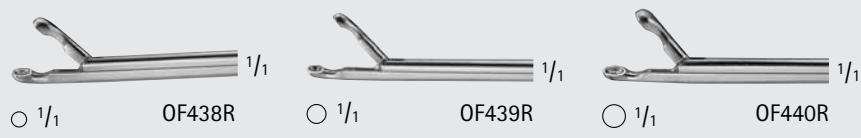
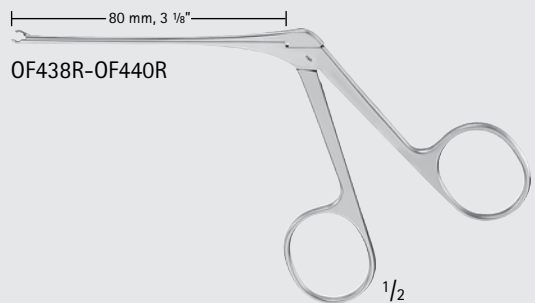

**HARTMANN Cup Forceps**

Catalog Number	Cup Size (mm)	Jaw	Working Length (in.)
OF438R	2.0	STR	3 1/8
OF439R	2.5	STR	3 1/8
OF440R	3.0	STR	3 1/8

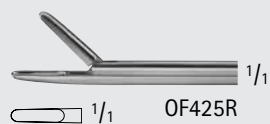
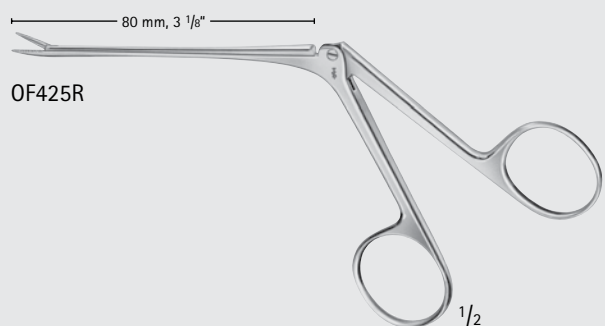

**HARTMANN Forceps, Oval**

Catalog Number	Cup Size (mm)	Jaw	Working Length (in.)
OF425R	2 x 7	STR	3 1/8

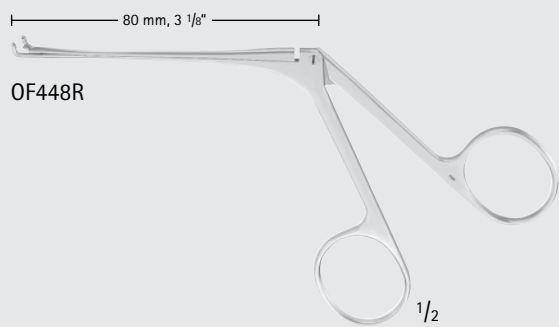

**HARTMANN-CITELLI Cup Forceps**

Catalog Number	Cup Size (mm)	Jaw	Working Length (in.)
OF448R	2.0	UPBITE	3 1/8

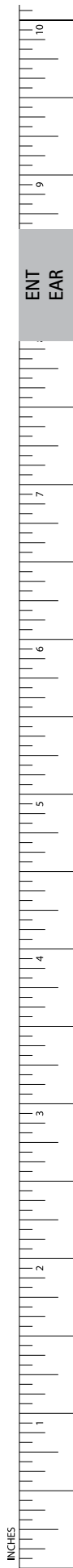

INCHES

# ENT-EAR

## Alligator Cup and Punch Forceps

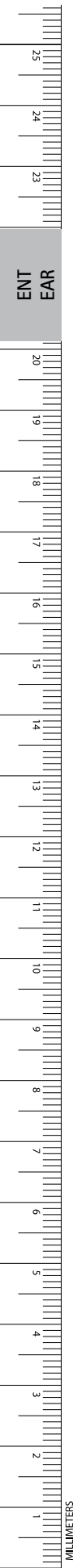

MA243R

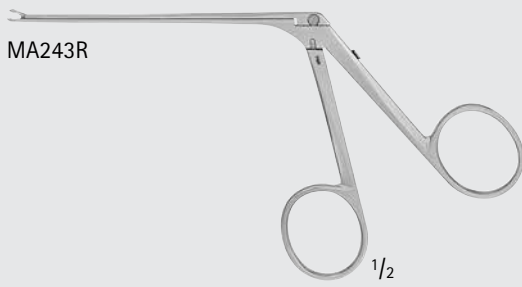

MA243R

MA244R-MA245R

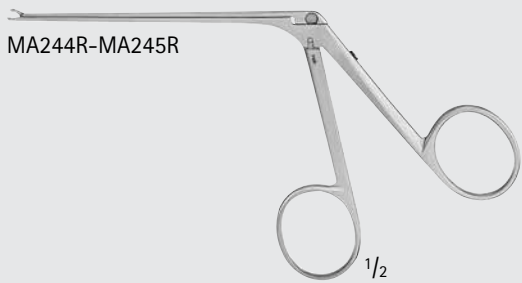

MA244R



MA245R

### HOUSE Cup Forceps, Miniature

Catalog Number	Cup Size (mm)	Jaw	Working Length (in.)
MA243R	0.6 x 1.0	STR	3 1/8
MA244R	0.6 x 1.0	ANG 15° LEFT	5 1/8
MA245R	0.6 x 1.0	ANG 15° RIGHT	5 1/8

MA246R-MA247R



MA246R



MA247R

### HOUSE Oval Cup Forceps

Catalog Number	Cup Size (mm)	Jaw	Working Length (in.)
MA247R	0.9	ANG 15° LEFT	2 3/4
MA246R	0.9	ANG 15° RIGHT	2 3/4

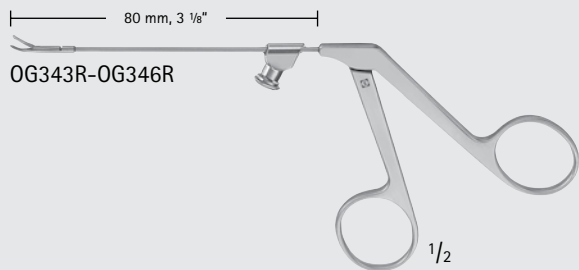

WULLSTEIN Micro Cup Forceps

Catalog Number	Cup Size (mm)	Jaw	Working Length (in.)
OG345R	0.8 x 1.3	STR	3 1/8
OG348R	1.7 x 2.5	STR	3 1/8
OG343R	0.8 x 1.3	CVD-LEFT	3 1/8
OG344R	0.8 x 1.3	CVD-RIGHT	3 1/8
OG346R	1.0	STR, ROUND	3 1/8

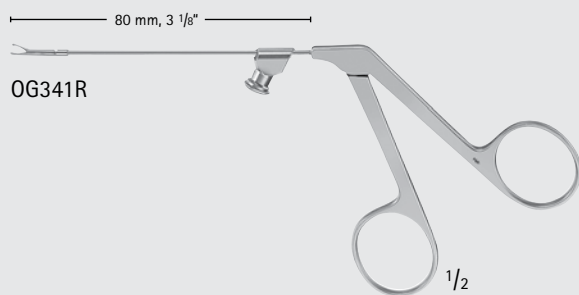
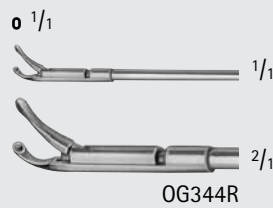
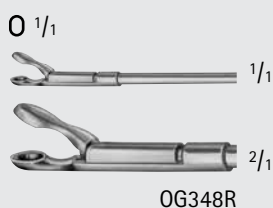
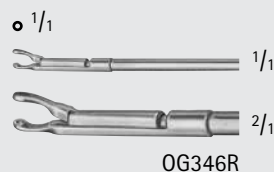
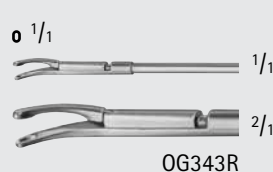
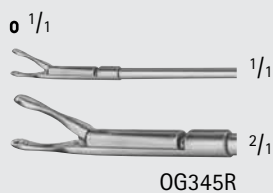

Micro Cup Forceps

Catalog Number	Cup Size (mm)	Jaw	Working Length (in.)
OG341R	0.9 x 1	STR	3 1/8
OG342R	0.9 x 1	CVD, UP	3 1/8

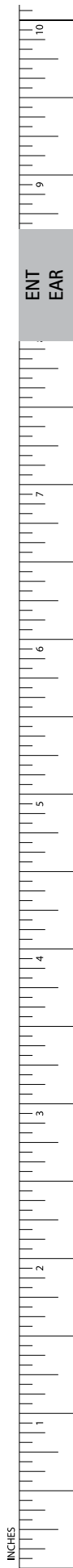
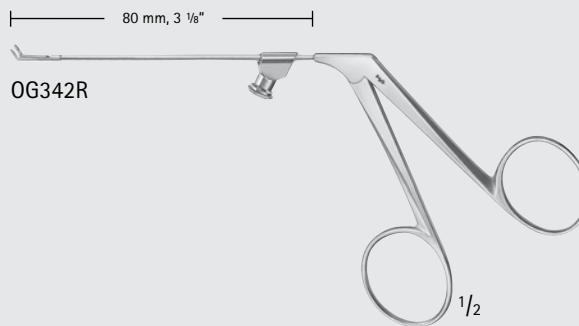

INCHES

# ENT-EAR

## Nippers/Crimping Forceps/Wire Guides/Cutters/Snares

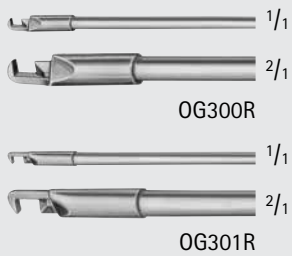
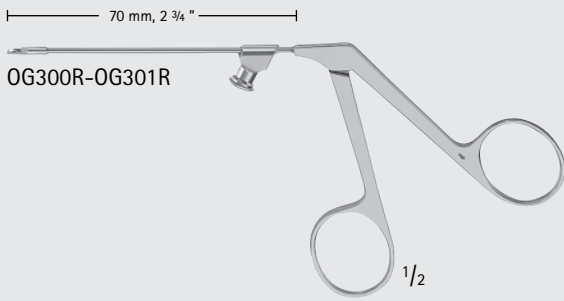

### DIETER Malleus Nipper

Catalog Number	Tip	Working Length (in.)
OG300R	UP BITE	2 3/4
OG301R	DOWN BITE	2 3/4

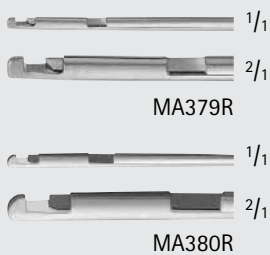
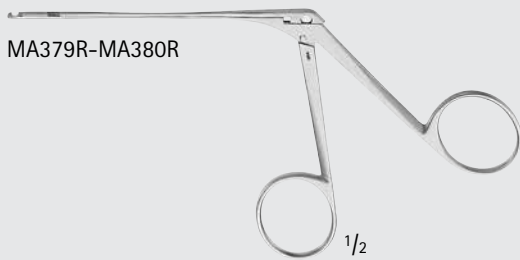

### HOUSE-DIETER Malleus Nipper

Catalog Number	Jaw Length (mm)	Working Length (in.)
MA379R	1.5	3 1/8
MA380R	2.0	3 1/8

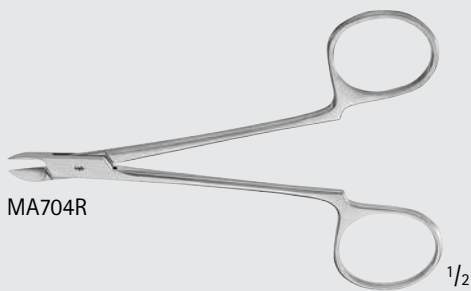

### LEMPERT Malleus Cutter

Catalog Number	Jaw Length (mm)	Length (in.)
MA704R	11	4 1/2

ENT  
EAR

1  
2  
3  
4  
5  
6  
7  
8  
9  
10  
11  
12  
13  
14  
15  
16  
17  
18  
19  
20  
23  
24  
25  
MILLIMETERS

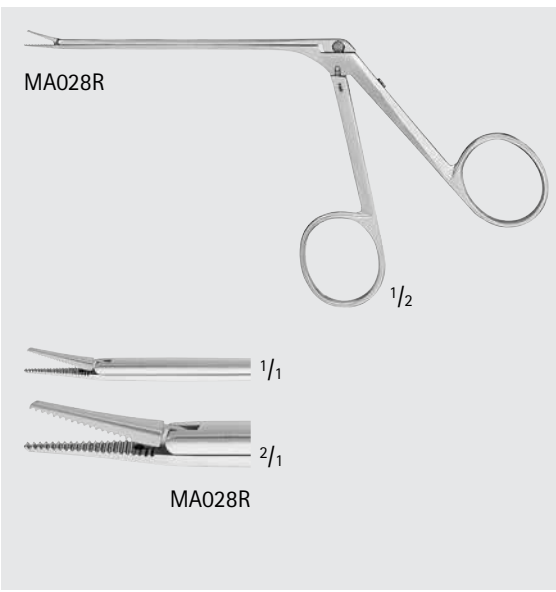
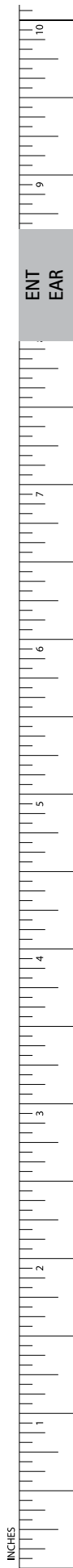

**HOUSE Alligator Crimper**

Catalog Number	Jaw Length (mm)	Tip	Working Length (in.)	Length (in.)
MA028R	8	SERR	2 7/8	5 1/8

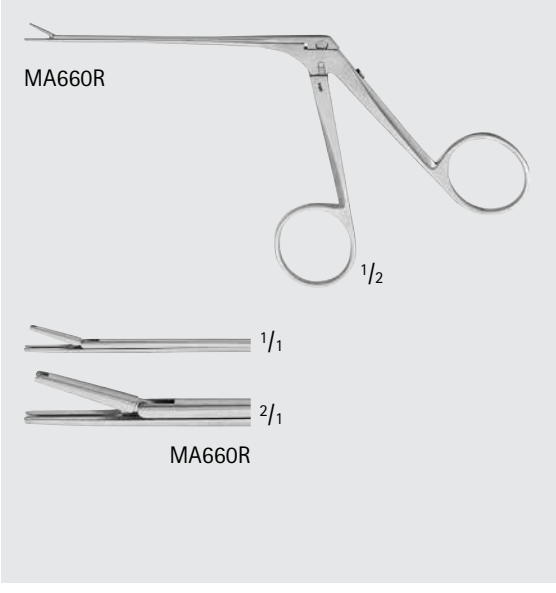

**SCHEER Wire Crimper**

Catalog Number	Jaw Length (mm)	Tip	Working Length (in.)	Length (in.)
MA660R	7	SMOOTH	3 1/4	5 1/8

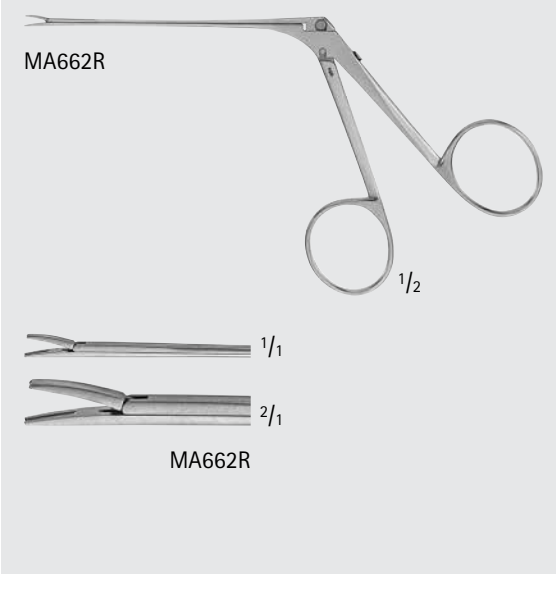

**SCHUKNECHT Wire Crimper**

Catalog Number	Jaw Length (mm)	Working Length (in.)	Length (in.)
MA662R	3	3 1/8	5 1/8

# ENT-EAR

## Nippers/Crimping Forceps/Wire Guides/Cutters/Snares

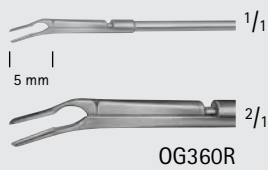
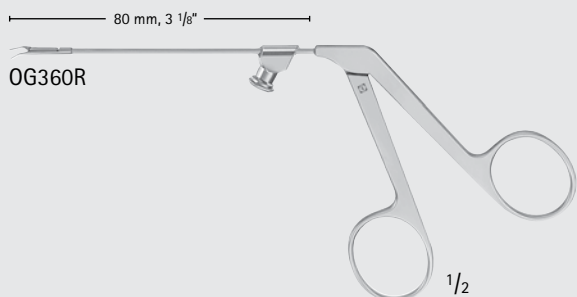
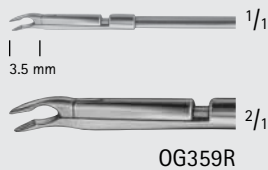
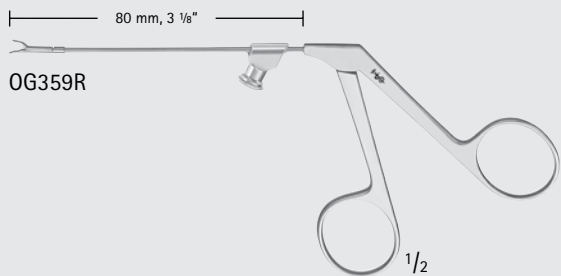

### MCGEE Wire Crimper

Catalog Number	Tip Size (mm)	Blade	Working Length (in.)
OG359R	3.5	CVD-DOWN	3 1/8
OG360R	5	CVD-DOWN	3 1/8

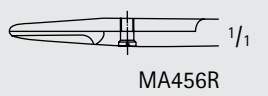
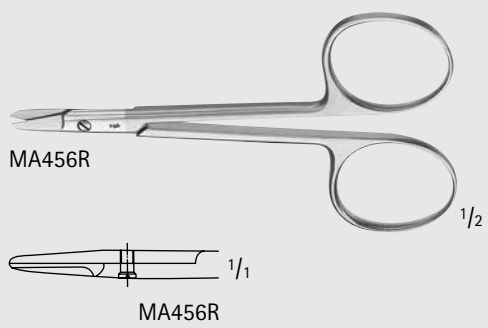

### GUILFORD-WRIGHT Wire Cutter

Catalog Number	Jaw	Length (in.)
MA456R	SERR	3 3/8

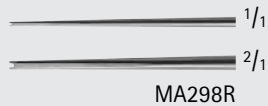
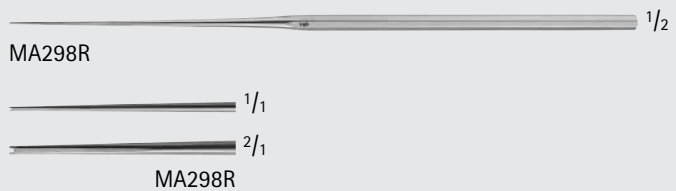

### HOUSE Strut Guide

Catalog Number	Tip Size (mm)	Tip	Length (in.)
MA298R	0.6	ANG	6 1/2



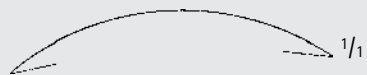

OF528R

Ear Snare Wire, Pkg/100

Catalog Number	Diameter (mm)
OF528R	0.2



OF505R

KRAUSE Ear Snare, Extra Delicate

Catalog Number	Length (in.)
OF505R	6 1/4

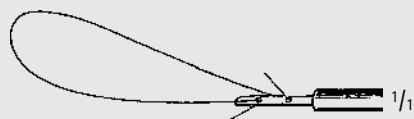

OF505R

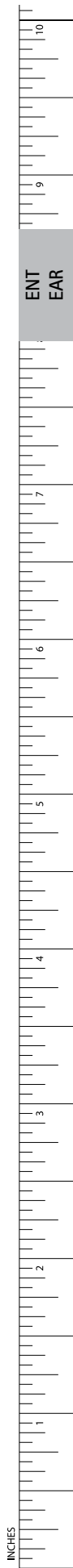

INCHES

# ENT-EAR

## Hooks and Probes

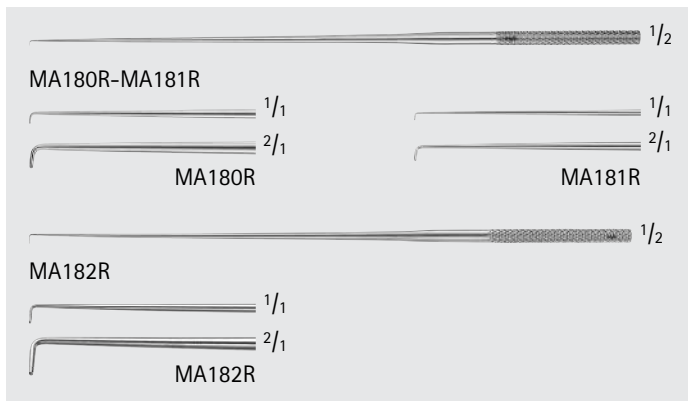
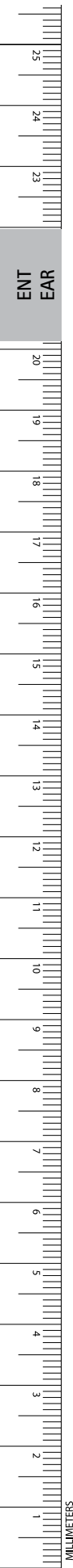

### DAY Ear Hook

Catalog Number	Size	Tip Size (mm)	Tip	Length (in.)
MA180R	X-SMALL	1.5	ANG 90°	6 1/4
MA181R	SMALL	2.0	ANG 90°	6 1/4
MA182R	LARGE	2.5	ANG 90°	6 1/4

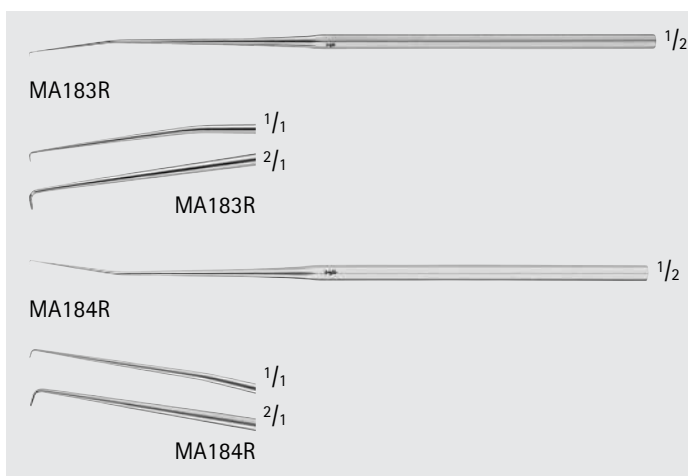

### HOUSE Hook Ear Hook

Catalog Number	Tip Size (mm)	Tip	Length (in.)
MA183R	1	ANG 90° LEFT	6 5/8
MA184R	1	ANG 90° RIGHT	6 5/8

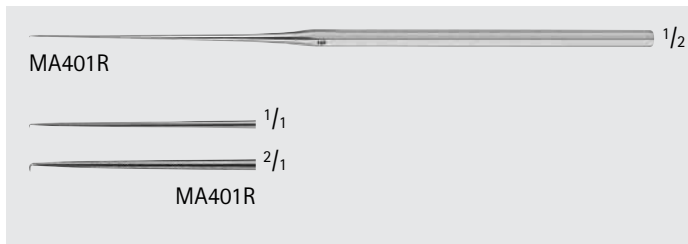

### SAUNDERS-PAPARELLA Stapes Hook

Catalog Number	Tip Size (mm)	Tip	Tip Size (#)	Length (in.)
MA401R	0.5	ANG 90°, MALLEABLE	9	6 1/2

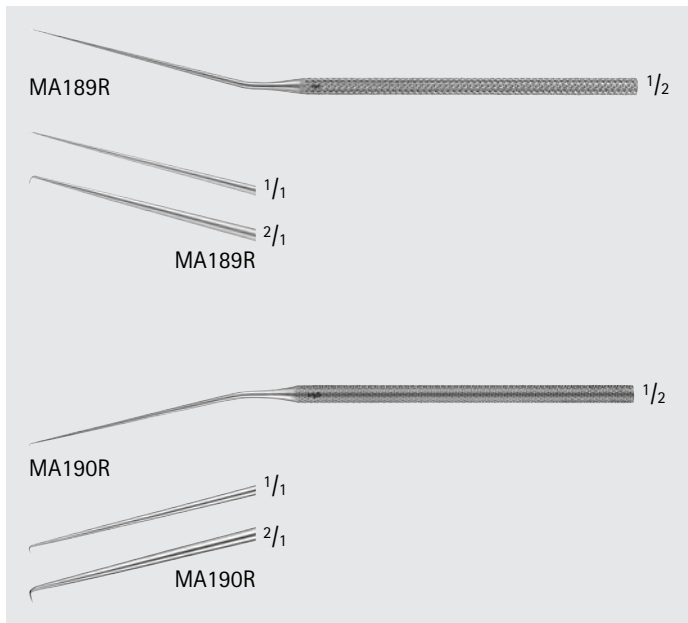

### SCHUKNECHT Hook

Catalog Number	Tip Size (mm)	Tip	Length (in.)
MA189R	0.4	ANG-UP, ANTERIOR	6 1/4
MA190R	0.6	ANG-DOWN, POSTERIOR	6 1/4



OG007R-OG014R

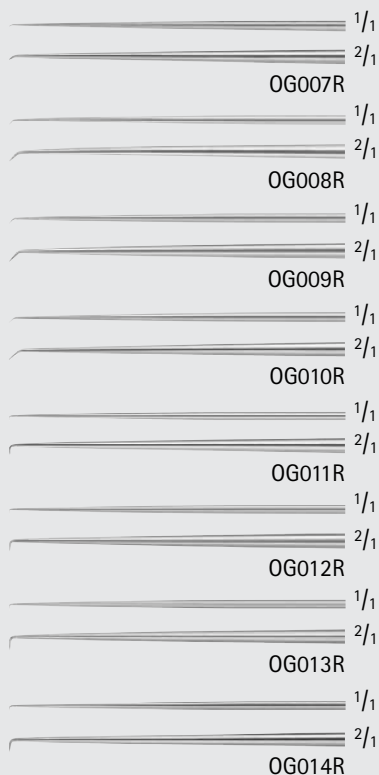

**SHAMBAUGH Fen Hook**

Catalog Number	Tip Size (mm)	Angle	Length (in.)
OG007R	0.4	45°	6 1/4
OG008R	0.6	45°	6 1/4
OG009R	0.8	45°	6 1/4
OG010R	1.0	45°	6 1/4
OG011R	0.4	90°	6 1/4
OG012R	0.6	90°	6 1/4
OG013R	0.8	90°	6 1/4
OG014R	1.0	90°	6 1/4



OF277R-OF279R

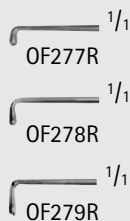

**LUCAE Ear Hook Button**

Catalog Number	Size	Length (in.)
OF277R	SMALL	5 1/2
OF278R	MEDIUM	5 1/2
OF279R	LARGE	5 1/2



OF282R-OF285R

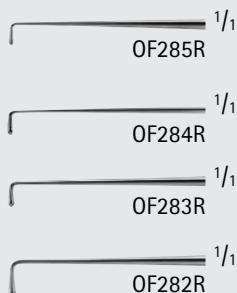

**WAGENER Nerve Hook Button**

Catalog Number	Size	Length (in.)
OF285R	X-SMALL	6
OF284R	SMALL	6
OF283R	MEDIUM	6
OF282R	LARGE	6



INCHES

# ENT-EAR

## Retractors

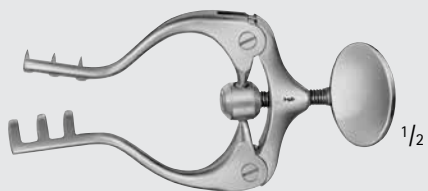

BV030R



BV030R



BV032R



BV032R



BV033R

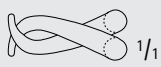

BV033R

### JANSEN Retractor

Catalog Number	Tip	Blade End	Length (in.)
BV030R	SHARP	3 x 3 PRONGS	4
BV032R	BLUNT	3 x 3 PRONGS	4
BV033R	BLUNT	3 x 4 PRONGS	4

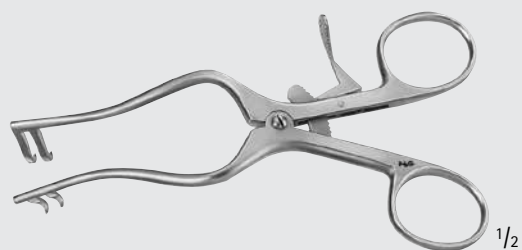

BV078R

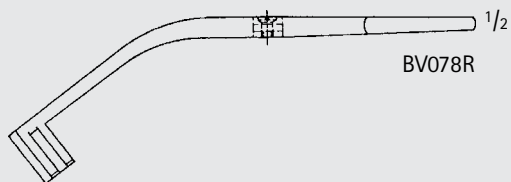

BV078R



1/1

### PLESTER-PAPARELLA-WEITLANER Retractor

Catalog Number	Tip	Blade End	Length (in.)
BV078R	SHARP	2 x 2 PRONGS	5 1/8

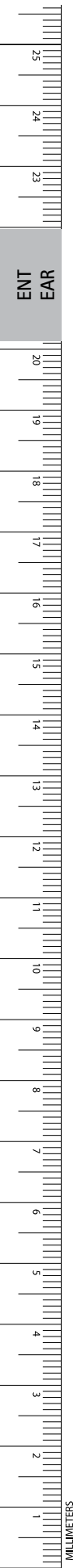

SCHUKNECHT Retractor

Catalog Number	Tip	Blade End	Length (in.)
MA433R	ANG, SHARP	3 x 3 PRONGS	5 1/8

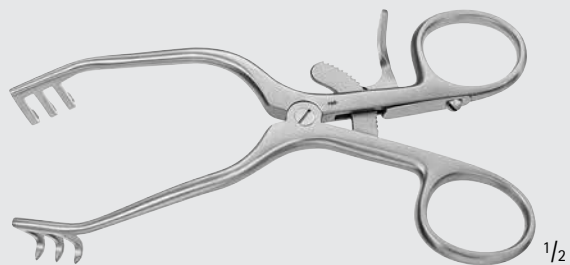

MA433R

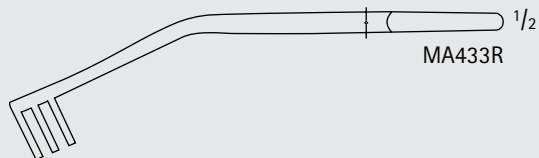

MA433R

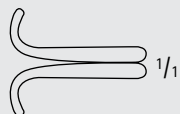

1/1

HOUSE Hand Retractor, Double Ended

Catalog Number	Blade Size (mm)	Length (in.)
MA432R	20 x 7 / 25 x 9	6

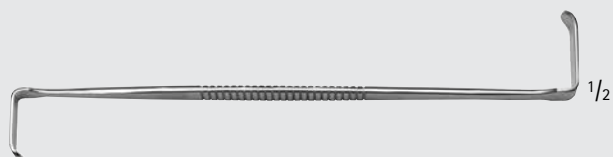

MA432R



1/1



1/1

MA432R

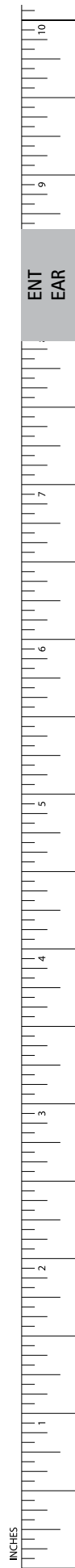

INCHES

# ENT-EAR

## Picks

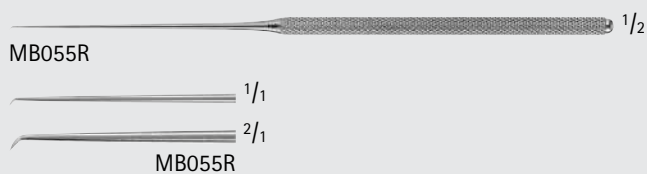

### AUSTIN Pick

Catalog Number	Tip Size (mm)	Tip	Length (in.)
MB055R	1.0	ANG 45°	6 1/4

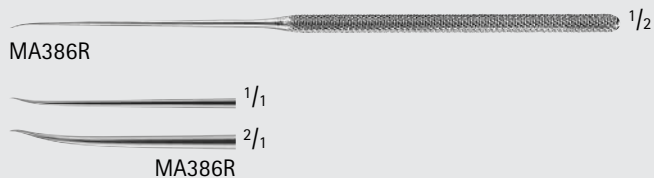

### BELLUCCI Pick

Catalog Number	Tip	Tip Size (mm)	Length (in.)
MA386R	CVD POINT, 4 MM FROM TIP	-	6 5/8
MA388R	ANG 90°	0.5	6 5/8

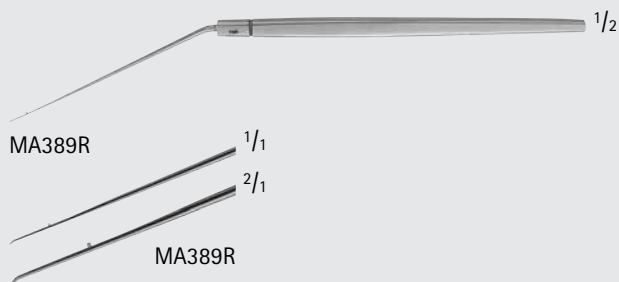
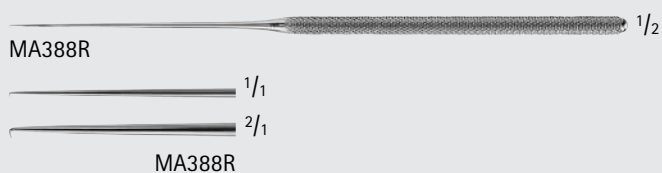

### FARRIOR Footplate Pick, with Notch

Catalog Number	Tip	Shaft	Length (in.)
MA389R	ANTERIOR, CVD-RIGHT	ANG	5 7/8
MA390R	POSTERIOR, CVD-LEFT	ANG	5 7/8

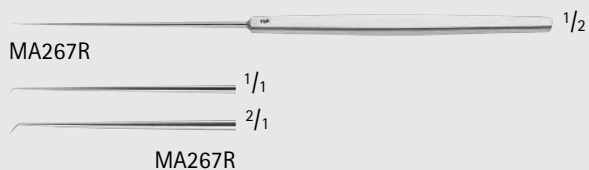
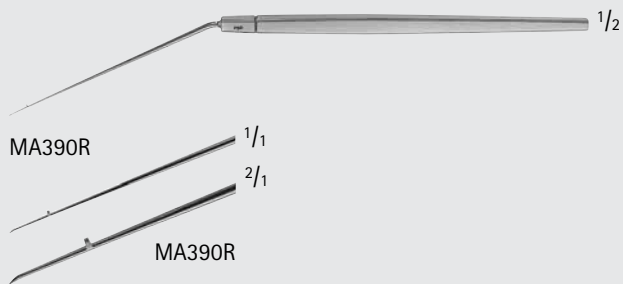

### GUILFORD-WRIGHT Footplate

Catalog Number	Tip Size (mm)	Tip	Length (in.)
MA267R	0.5	ANG 45°	5 1/2

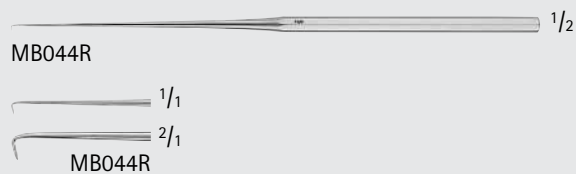

### GUILFORD-WRIGHT Stapes Pick, Heavy

Catalog Number	Tip	Length (in.)
MB044R	ANG 90°	5 1/2



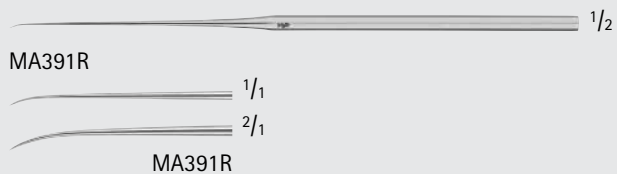
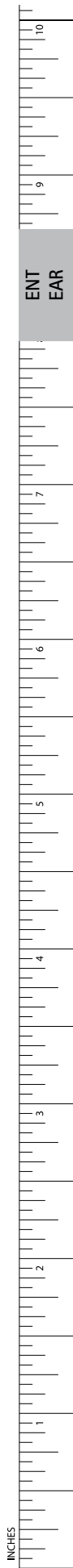

**HOUGH Footplate Pick**

Catalog Number	Tip	Length (in.)
MA391R	CVD	5 7/8

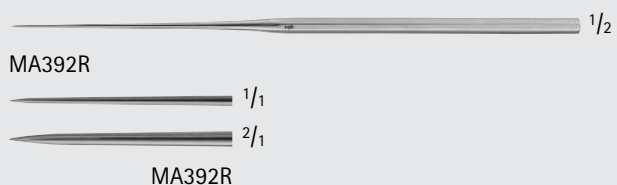

**HOUGH Pick**

Catalog Number	Tip	Length (in.)
MA392R	STR	5 7/8

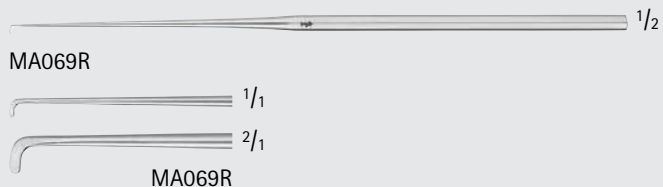

**HOUSE-CRABTREE Dissector Pick**

Catalog Number	Tip Size (mm)	Tip	Length (in.)
MA069R	2.5	ANG 90°	6 5/8

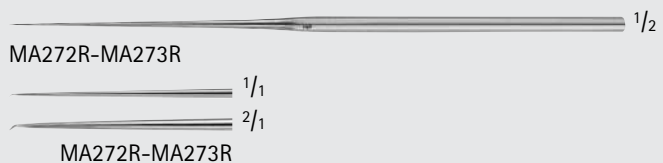

**HOUSE Oval Window Pick**

Catalog Number	Tip Size (mm)	Tip	Shaft	Length (in.)
MA272R	0.33	ANG 30°	-	6 1/2
MA273R	0.66	ANG 30°	-	6 1/2
MA284R	0.33	ANG 90°	FINE	6 1/2
MA393R	0.33	ANG 90°	MEDIUM	6 5/8

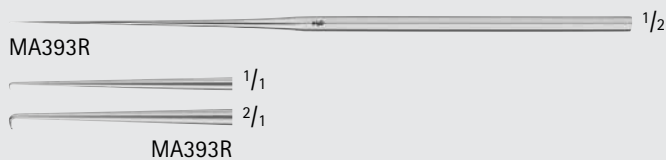
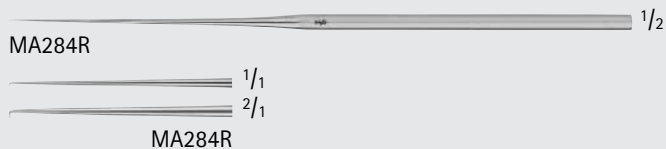

# ENT-EAR

## Picks

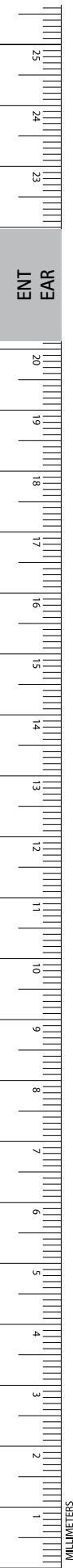

MA396R-MA397R  $\frac{1}{2}$

$\frac{1}{1}$

$\frac{2}{1}$

MA397R

$\frac{1}{1}$

$\frac{2}{1}$

MA396R

MA395R  $\frac{1}{2}$

$\frac{1}{1}$

$\frac{2}{1}$

MA395R

MA394R  $\frac{1}{2}$

$\frac{1}{1}$

$\frac{2}{1}$

MA394R

MA406R  $\frac{1}{2}$

$\frac{1}{1}$

$\frac{2}{1}$

MA406R

MA405R  $\frac{1}{2}$

$\frac{1}{1}$

$\frac{2}{1}$

MA405R

### HOUSE Strut Pick

Catalog Number	Tip Size (mm)	Tip	Length (in.)
MA397R	0.5	ANG 90°	6 1/2
MA396R	0.66	ANG 90°	6 1/2
MA395R	0.75	ANG 90°	6 1/2
MA394R	1.0	ANG 90°	6 1/2
MA406R	1.5	ANG 90°	6 1/2
MA405R	3.0	ANG 90°	6 1/2

MA251R  $\frac{1}{2}$

$\frac{1}{1}$

$\frac{2}{1}$

MA251R

### HOUSE-BARBARA Pick, Malleable

Catalog Number	Tip	Length (in.)
MA251R	STR	6 1/2

**KOS Pick, Bayonet-Shaped**

Catalog Number	Tip Size (mm)	Tip	Length (in.)
MA399R	85	STR	7
MA398R	-	ANG-UP 90°	7

**MCGEE Footplate Pick**

Catalog Number	Tip Size (mm)	Tip	Shaft	Length (in.)
MA261R	0.2	ANTERIOR	ANG-UP	6 1/2
MA402R	0.2	POSTERIOR	ANG-DOWN	6 1/2
MA263R	1.0	ANTERIOR	ANG-UP	6 1/2
MA264R	1.0	POSTERIOR	ANG-DOWN	6 1/2

**PAPARELLA Pick**

Catalog Number	Tip Size (#)	Tip	Length (in.)
MA403R	17	LEFT	6 1/2
MA404R	16	RIGHT	6 1/2

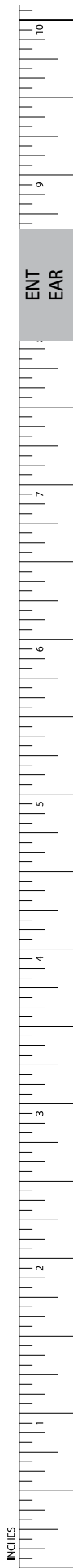

# ENT-EAR

## Specula and Holders

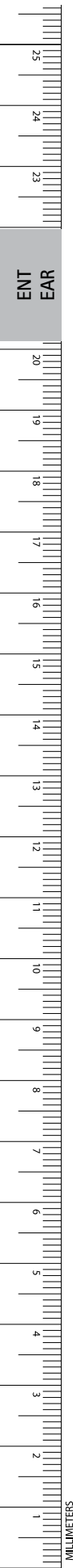

US101-US103



US101



US102



US103

### Ear Speculum, Oval, Ebony

Catalog Number	Tip Size (mm)
US101	4.5 x 5.5
US102	5.5 x 6.5
US103	6.5 x 7.5



OF102C-OF104C



OF102C



OF103C



OF104C

### POLITZER Ear Speculum, Round, Pediatric

Catalog Number	Tip Size (mm)
OF101C	SET OF 3 OF102C-OF104C
OF102C	2
OF103C	3
OF104C	4



OF121C-OF124C



OF121C



OF122C



OF123C



OF124C

### BOUCHERON Ear Speculum, Round, Adult

Catalog Number	Tip Size (mm)
OF120C	SET OF 4 OF121C-OF124C
OF121C	4.2
OF122C	5.2
OF123C	6.2
OF124C	7.2



MA077R-MA080R



MA077R



MA078R



MA079R



MA080R

### BOUCHERON Ear Speculum, Round, Large

Catalog Number	Tip Size (mm)
MA076R	SET OF 4 MA077R-MA080R
MA077R	5.5
MA078R	6.6
MA079R	7.5
MA080R	9.0



MA072R-MA075R

1/1



MA072R



MA073R



MA074R

**BOUCHERON Ear Speculum, Round, Small**

Catalog Number	Size (#)	Tip Size (mm)
MA071R	-	SET OF 4 MA072R-MA075R
MA072R	1	3.0
MA073R	2	4.0
MA074R	3	4.5
MA075R	4	5.0



MA075R



MA090R-MA096R,  
MA648R-MA649R

1/1



MA648R



MA649R



MA090R



MA091R



MA092R



MA093R



MA094R



MA095R

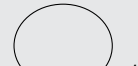

MA096R

**FARRIOR Ear Speculum, Oval, Oblique**

Catalog Number	Size (#)	Tip Size (mm)
MA648R	XX-SMALL	3 x 4
MA649R	X-SMALL	4 x 5
MA089R	-	SET OF 7 MA090R-MA096R
MA090R	1	5 x 6
MA091R	2	6 x 7
MA092R	3	7 x 8
MA093R	4	8 x 10
MA094R	5	9 x 11
MA095R	6	10 x 12
MA096R	7	11 x 13



MA097R-MA104R

1/1



MA098R



MA099R



MA100R



MA101R

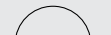

MA102R



MA103R



MA104R

**FARRIOR Ear Speculum, Round, Oblique**

Catalog Number	Size (#)	Tip Size (mm)
MA097R	-	SET OF 7 MA098R-MA104R
MA098R	1	6
MA099R	2	7
MA100R	3	8
MA101R	4	9
MA102R	5	10
MA103R	6	11
MA104R	7	12



# ENT-EAR

## Specula and Holders



MA082R-MA088R,  
MA646R-MA647R

### FARRIOR Ear Speculum, Oval, Regular

Catalog Number	Size (#)	Tip Size (mm)
MA646R	XX-SMALL	3 x 4
MA647R	X-SMALL	4 x 5
MA081R	-	SET OF 7 MA082R-MA088R
MA082R	1	4.5 x 6
MA083R	2	5.5 x 7
MA084R	3	6.5 x 8
MA085R	4	7.5 x 9
MA086R	5	8 x 10
MA087R	6	9 x 11.25
MA088R	7	10 x 12.5



MA646R



MA647R



MA082R



MA083R



MA084R



MA085R



MA086R



MA087R



MA088R



MA106R-MA112R

### FARRIOR Ear Speculum, Round, Regular

Catalog Number	Size (#)	Tip Size (mm)
MA105R	-	SET OF 7 MA106R-MA112R
MA106R	1	5.0
MA107R	2	6.0
MA108R	3	7.0
MA109R	4	8.0
MA110R	5	9.0
MA111R	6	10.0
MA112R	7	10.5



MA106R



MA107R



MA108R



MA109R



MA110R



MA111R



MA112R

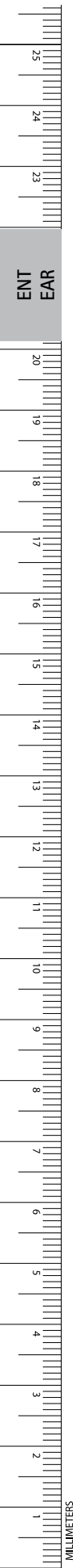



MB137R, MA650R-MA652R

**GRUBER Ear Speculum, Oval, Infant**

Catalog Number	Size (#)	Tip Size (mm)
MB242R	SMALL	2.0 x 2.5
MB243R	MEDIUM	2.5 x 3.0
MB244R	LARGE	3.0 x 4.0



MB242R



MB243R



MB244R



MA117R

**GRUBER Ear Speculum, Oval, Infant, Long**

Catalog Number	Tip Size (mm)
MA117R	4.5 x 5.0



MA117R



MA119R-MA121R

**GRUBER Ear Speculum, Oval, Light**

Catalog Number	Size (#)	Tip Size (mm)
MA118R	-	SET OF 3 MA119R-MA121R
MA119R	1	1.6 x 2.4
MA120R	2	2.4 x 3.2
MA121R	3	3.2 x 4.7



MA119R



MA120R



MA121R



MA114R-MA116R

**GRUBER Ear Speculum, Oval, Heavy, Long**

Catalog Number	Size (#)	Tip Size (mm)
MA114R	1	5 x 6
MA115R	2	6 x 7
MA116R	3	7 x 8



MA114R



MA115R



MA116R



ENT  
EAR

INCHES

# ENT-EAR

## Specula and Holders



MA125R-MA127R



MA125R



MA126R



MA127R

### GRUBER Ear Speculum, Round, Short, Light

Catalog Number	Size (#)	Tip Size (mm)
MA124R	-	SET OF 3 MA125R-MA127R
MA125R	1	3 x 33
MA126R	2	4 x 35
MA127R	3	5 x 37

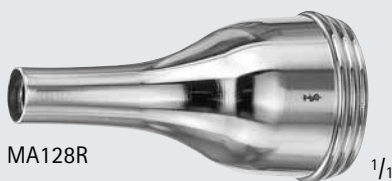

MA128R

### GRUBER Ear Speculum, Round, Long, Heavy

Catalog Number	Description
MA128R	SET OF 3



MA130R-MA136R



MA130R



MA136R

### HARTMANN Ear Speculum, Infant

Catalog Number	Tip	Tip Size (mm)
MA130R	ROUND	2.5
MA136R	OVAL	2.5 x 3



OF115C-OF117C



OF115C



OF116C



OF117C

### HARTMANN Ear Speculum, Infant

Catalog Number	Tip Size (mm)
OF115C	1.8
OF116C	3.2
OF117C	4.6



MA132R-MA135R



MA132R



MA133R



MA134R



MA135R

### HARTMANN Ear Speculum, Oval

Catalog Number	Size (#)	Tip Size (mm)
MA131R	-	SET OF 4 MA132R-MA135R
MA132R	1	4.5 x 5.5
MA133R	2	5.5 x 6
MA134R	3	6.5 x 7
MA135R	4	7.5 x 8

ENT  
EAR

MILLIMETERS



MA129R, MA650R-MA652R



MA650R



MA651R



MA137R



MA652R

**HARTMANN Ear Speculum, Round, Adult**

Catalog Number	Size (#)	Tip Size (mm)
MA129R	-	SET OF 4 MA137R, MA650R-MA652R
MA650R	1	4
MA651R	2	5
MA137R	3	6
MA652R	4	7



OF111C-OF114C



OF111C



OF112C



OF113C



OF114C

**HARTMANN Ear Speculum, Round**

Catalog Number	Tip Size (mm)
OF111C	3.5
OF112C	5.0
OF113C	6.5
OF114C	8.0



MA606R

**SHEA Speculum Holder**

Catalog Number	Length (in.)
MA606R	11 3/4



ENT  
EAR

INCHES

# ENT-EAR

## Applicators and Searchers



**LATHBURY-FARRELL Cotton Applicator, Triangular Serrated**

Catalog Number	Tip Size (mm)	Length (in.)
BN467R	0.9	5 1/2
BN465R	1.4	5 1/2
BN466R	1.2	6 1/4

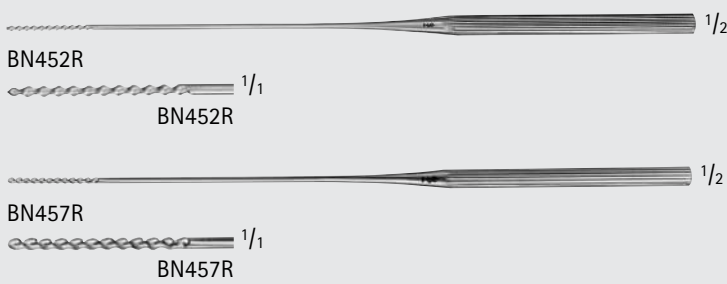

**Cotton Applicator, Spiral**

Catalog Number	Tip Size (mm)	Length (in.)
BN452R	1.5	7
BN457R	1.8	7

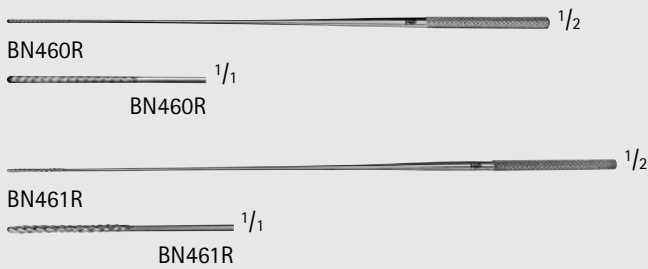

**FARRELL Cotton Applicator**

Catalog Number	Tip Size (mm)	Tip	Length (in.)
BN460R	1.2	ROUND-SERR	5 1/2
BN461R	1.2	SPIRAL	6 1/4

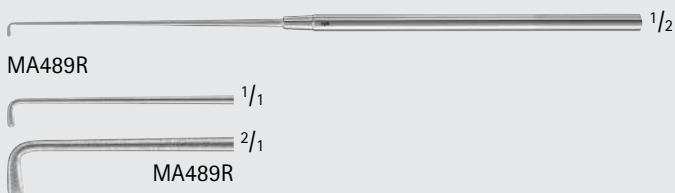

**ALLPORT Mastoid Searcher**

Catalog Number	Tip Size (mm)	Tip	Length (in.)
MA489R	3	ANG 90°	6 3/4

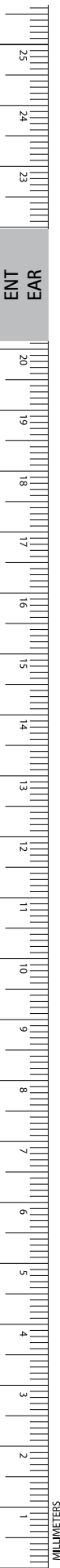

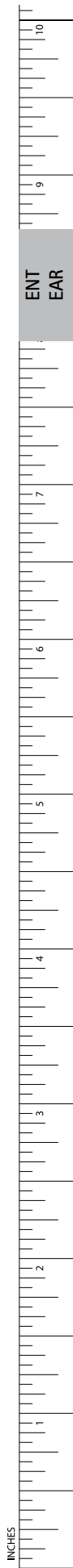

MA230R

Ear Knife Handle, for Myringotomy  
Blades with Round Ends

Catalog Number	Length (in.)
MA230R	3 5/8



MA204R

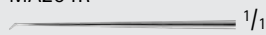

MA204R

AUSTIN Dissecting Knife

Catalog Number	Blade Size (mm)	Blade Shape	Length (in.)
MA204R	0.5	ANG 45°	6 1/4



MA210R

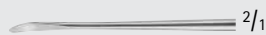

MA210R



MA209R

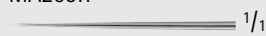

MA209R

DERLACKI Capsule Knife

Catalog Number	Blade Size (mm)	Blade Shape	Length (in.)
MA210R	0.25	ANG 20°	6 1/4
MA209R	0.5	SLIGHT CVD	6 1/4



OG100R



OG100R

Footplate Knife

Catalog Number	Blade Shape	Length (in.)
OG100R	STR	6 1/4

# ENT-EAR

## Knives

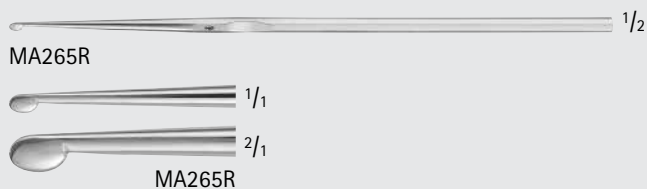

### GUILFORD-WRIGHT Flap Knife

Catalog Number	Blade Size (mm)	Length (in.)
MA265R	3.6 x 2.5	6 1/4

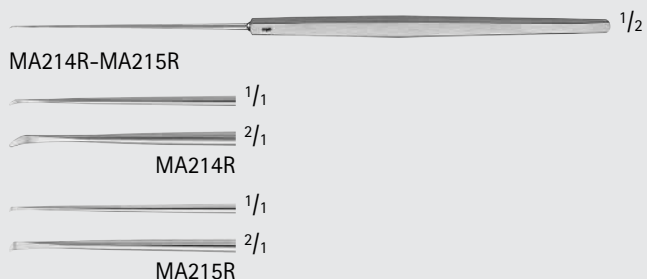

### HARRISON Knives

Catalog Number	Size	Blade Shape	Length (in.)
MA214R	SMALL	ANG 45°	6 1/8
MA215R	SMALL	ANG 90°	6 1/8

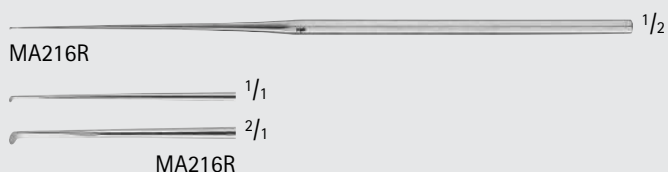

### HOUSE Incudostapedial Joint Knife

Catalog Number	Blade Size (mm)	Blade Shape	Length (in.)
MA216R	0.75	ANG 60°	6 5/8

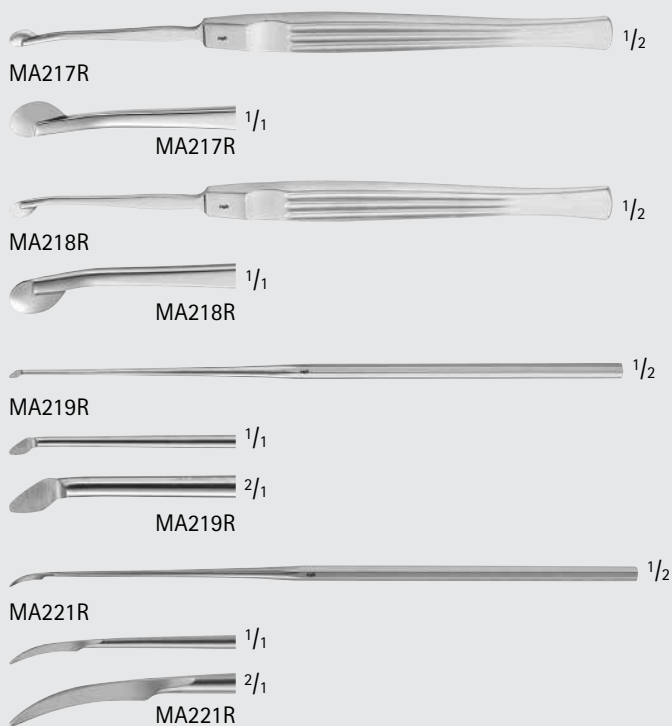

### HOUSE Knife

Catalog Number	Blade Size (mm)	Blade Shape	Length (in.)
MA217R	7.0	ANG LEFT	6 1/4
MA218R	7.0	ANG RIGHT	6 1/4
MA219R	2 x 3	ANG 45°	6 1/2
MA221R	7.5	ANG 45°	6 1/2





MA213R

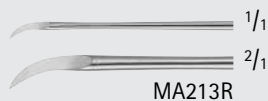

MA213R

**GHANDI Knife, Sickle Blade**

Catalog Number	Blade Size (mm)	Length (in.)
MA213R	4.0	5 1/8



MA208R



MA208R

**CULBERTSON Canal Knife**

Catalog Number	Tip Size (mm)	Length (in.)
MA208R	1.4	6 1/4



MA278R



MA278R

**JORDAN Canal Knife**

Catalog Number	Blade Size (mm)	Blade Shape	Length (in.)
MA278R	2 x 3	ANG 45°	6 1/2



MA222R



MA222R

**MCCABE Canal Knife**

Catalog Number	Blade Size (mm)	Blade Shape	Length (in.)
MA222R	2.5	ANG 45°	6 1/4

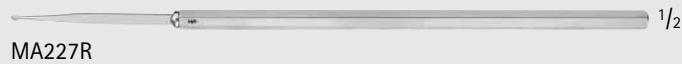

MA227R



MA227R



MA228R



MA228R

**PAPARELLA Canal Knife**

Catalog Number	Size (#)	Blade Size (mm)	Blade Shape	Length (in.)
MA227R	1	2	STR	6 1/2
MA228R	2	2	STR	6 1/2



MB282R-MB283R



MB282R

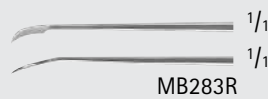

MB283R

**PAPARELLA Sickle Knife**

Catalog Number	Size (#)	Blade Size (mm)	Blade Shape	Length (in.)
MB282R	14	5	CVD RIGHT	6 1/2
MB283R	15	5	CVD LEFT	6 1/2



INCHES

# ENT-EAR

## Knives

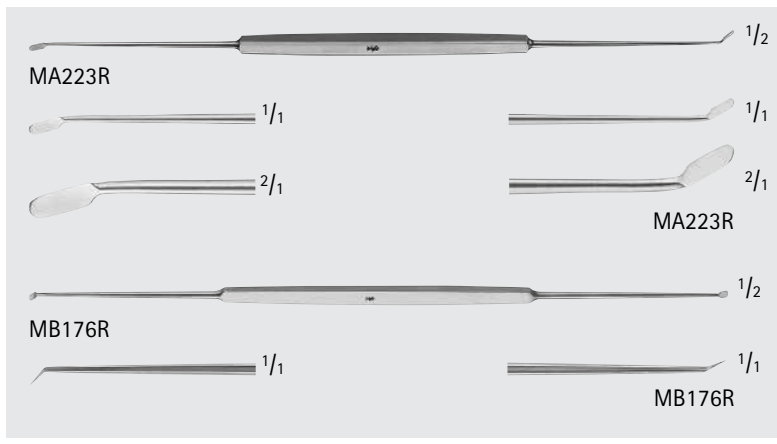
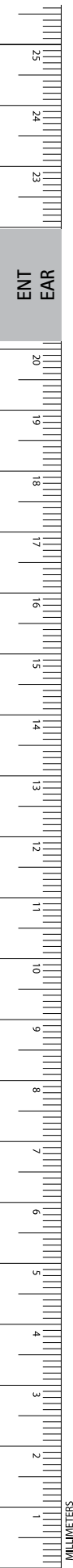

**MCCABE Knife Flap Dissector, Double Ended, Angled**

Catalog Number	Blade Shape	Length (in.)
MA223R	20° / 45°	7 1/4
MB176R	20° / 40°	7 1/4

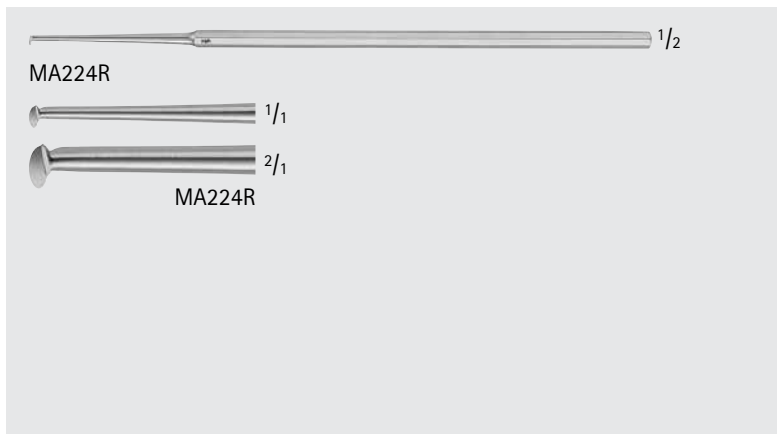

**MCHUGH Flap Knife**

Catalog Number	Blade Shape	Length (in.)
MA224R	OVAL	6 1/2

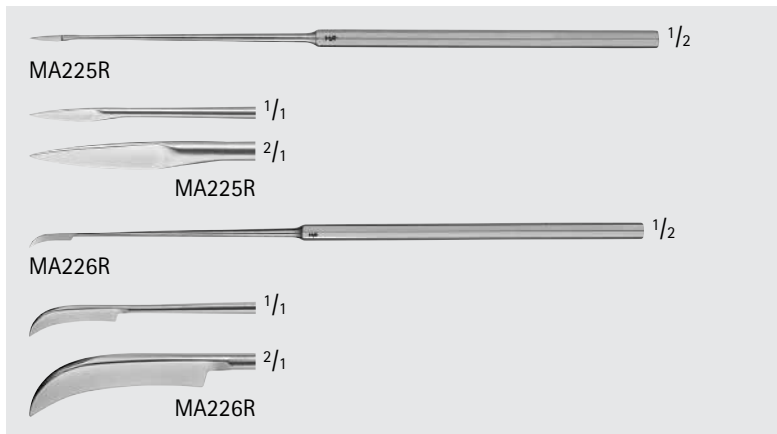

**Myringotomy Knife**

Catalog Number	Blade Size (mm)	Blade Shape	Length (in.)
MA225R	8	STR	6 1/2
MA226R	9	CVD	6 1/2

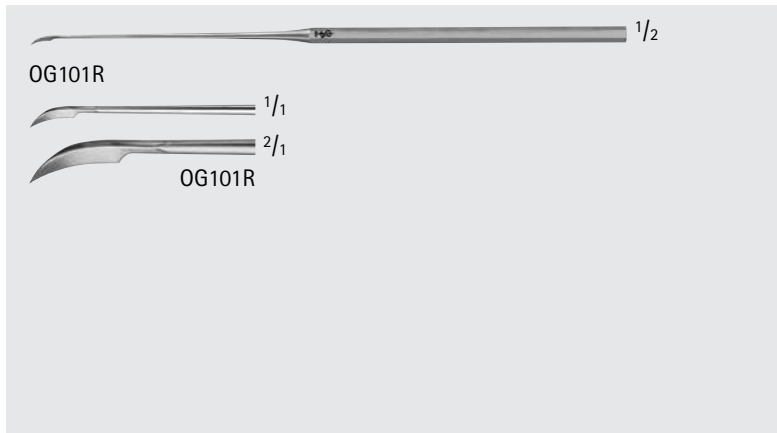

**PLESTER Knife, Sickle Knife**

Catalog Number	Blade Shape	Length (in.)
OG101R	CVD	6 1/4



OG110R, OG112R, OG133R, OG136R

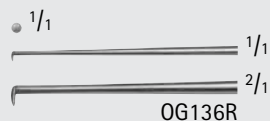
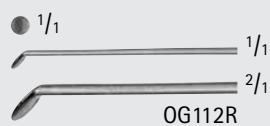
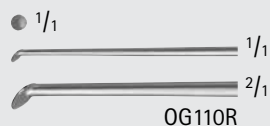
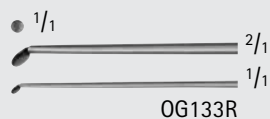

Round Cutting Knife

Catalog Number	Blade Size (mm)	Blade Shape	Length (in.)
OG133R	1.5	45°	6 1/4
OG110R	2.0	45°	6 1/4
OG112R	2.6	45°	6 1/4
OG136R	1.5	90°	6 1/4



OG108R

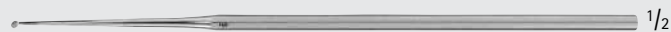
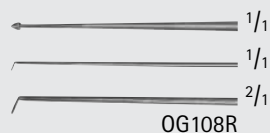

MA292R



ROSEN Knife

Catalog Number	Blade Size (mm)	Blade Shape	Length (in.)
OG108R	-	SPEAR	6 1/4
MA292R	2	45° UP ROUND	6 1/4



MA644R



ROYCE Ear Knife

Catalog Number	Blade	Blade Size (mm)	Shaft	Length (in.)
MA644R	DOWN-CUTTING	8	ANG	6 1/4

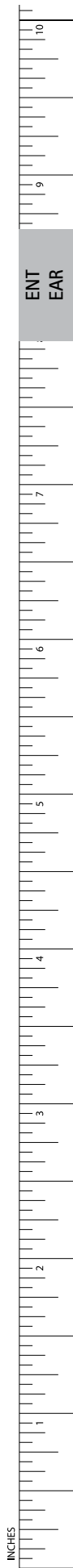

INCHES

# ENT-EAR

## Knives



OG123R-OG124R



OG123R



OG124R

### SCHUKNECHT Roller Knife

Catalog Number	Blade Shape	Length (in.)
OG123R	RIGHT-ANG	6 1/4
OG124R	STR	6 1/4



MA056R-MA057R



MA056R



MA057R

### SHEEHY Knife Curette

Catalog Number	Size	Blade Size (mm)	Blade Shape	Length (in.)
MA056R	SMALL	2.0	WEAPON	6 5/8
MA057R	LARGE	2.5	WEAPON	6 5/8



MA586R



MA586R



MA587R



MA587R

### Sickle Knife

Catalog Number	Blade Tip	Blade Size (mm)	Blade Shape	Length (in.)
MA586R	SHARP	10	CVD	7 1/2
MA587R	BLUNT	10	CVD	7 1/2

ENT  
EAR

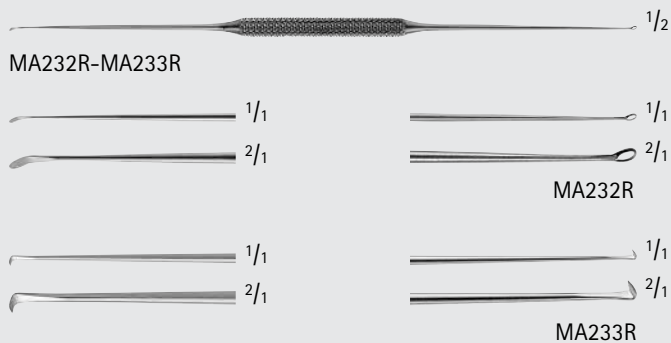

TABB Flap Knife, Double Ended, Angled

Catalog Number	Blade Size (mm)	Blade Shape	Length (in.)
MA232R	0.9 / 1.0	25° / 45°	6 1/2
MA233R	0.9 / 1.0	90° / 115°	6 1/2

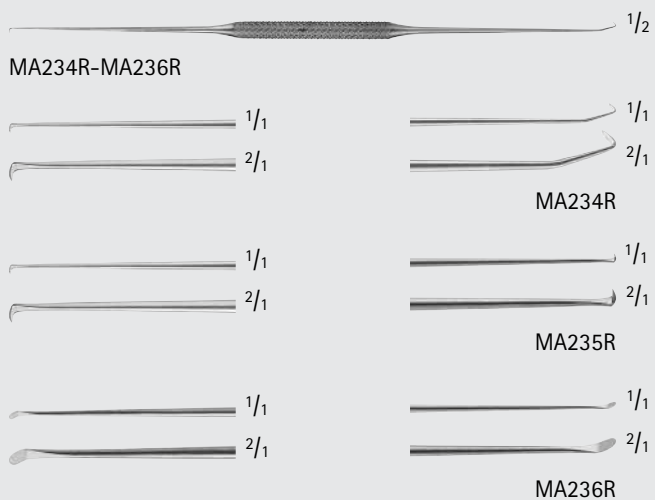

TABB Myringotomy Knife, Double Ended, Angled

Catalog Number	Blade Size (mm)	Blade Shape	Length (in.)
MA234R	1.0 / 1.0	90° / 120°	6 1/4
MA235R	1.3 / 1.3	90° / 115°	6 1/4
MA236R	1.1 / 1.1	25° / 45°	6 1/4

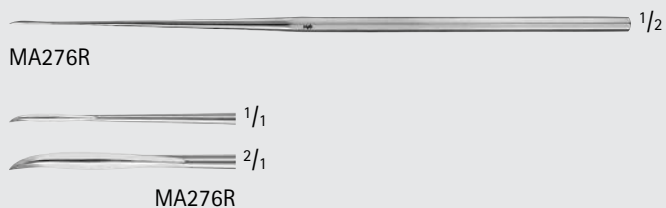

HOUSE Tympanoplasty Knife

Catalog Number	Blade Size (mm)	Blade Shape	Length (in.)
MA276R	7	CVD	6 1/2

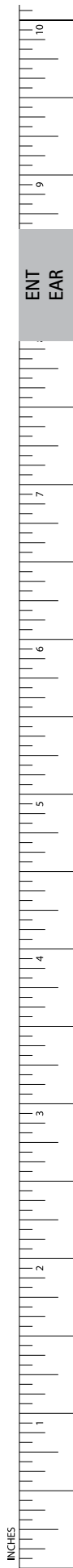

# ENT-EAR

## Suction Irrigation



MA717R-MA718R

### ANTHONY Suction Tube, Straight

Catalog Number	Tip Size (mm)	Length (in.)
MA717R	2 I.D.	6 1/8
MA718R	3 I.D.	6 1/8

MA494R

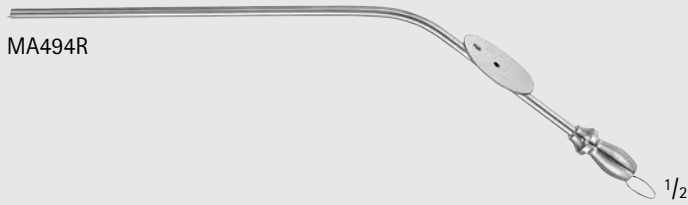

### BARNES Hospital Suction Tube

Catalog Number	Tip Size (FR)	Working Length (in.)	Length (in.)
MA494R	9	3 3/4	6 1/8

MB380R-MB382R

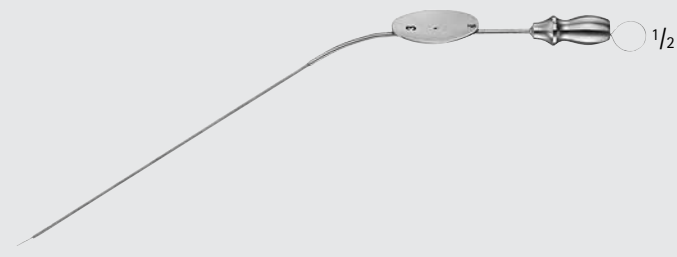

### BARON Suction Tube

Catalog Number	Tip Size (FR)	Working Length (in.)	Length (in.)
MB380R	3	4	4
MB381R	5	4	4
MB382R	7	4	4
MD887	3	2 3/4	5 1/2
MD888	5	2 3/4	5 1/2
MD889	7	2 3/4	5 1/2
MG375R	-	-	6

MG375R Stylet may be used with all  
BARON Suction Tubes

MD887-MD889



MG375R

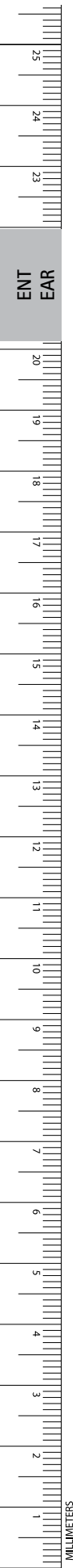

MA502R



MA503R



**HOUSE-BARON Suction Tube, Long**

Catalog Number	Tip Size (FR)	Working Length (in.)	Length (in.)
MA502R	3	3 5/8	5 1/2
MA503R	5	3 5/8	6 1/8

MA497R



MA498R



MA495R



MA496R



**BRACKMANN Suction Tube**

Catalog Number	Tip Size (FR)	Working Length (in.)	Length (in.)
MA497R	5	3	6
MA498R	7	3	6
MA495R	5	4 1/8	6
MA496R	7	4 1/8	6

MB614R-MB616R



**HOUSE Suction Tube, Straight**

Catalog Number	Tip	Length (in.)
MB614R	18 GA	4 1/8
MB615R	20 GA	4 1/8
MB616R	22 GA	4 1/8

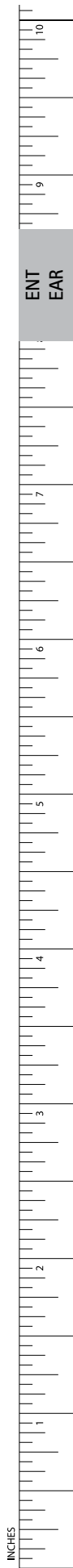

INCHES

# ENT-EAR

## Suction Irrigation

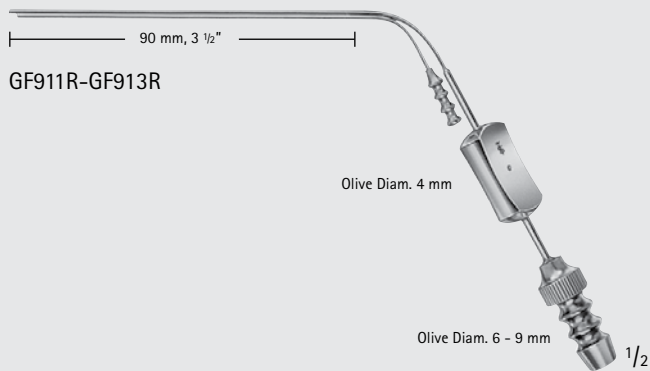

### HOUSE Suction Irrigation Cannula

Catalog Number	Tip Size (mm)	Working Length (in.)
GF911R	0.9 / 0.7	3 1/2
GF912R	1.2 / 0.9	3 1/2
GF913R	1.5 / 1.2	3 1/2

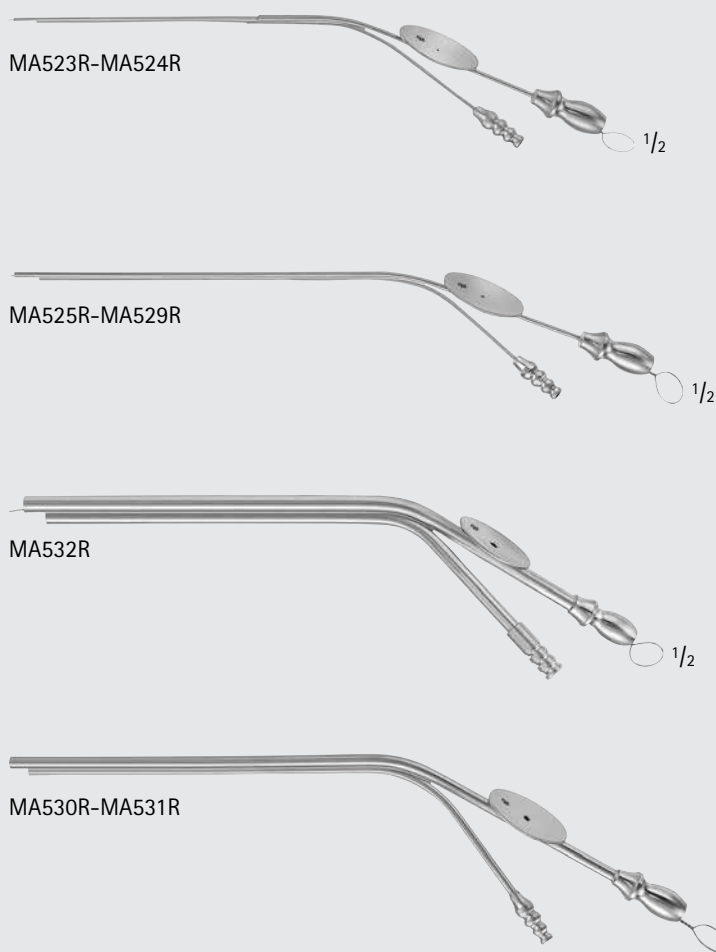

### WILLIAM-HOUSE Suction Irrigator

Catalog Number	Tip Size (FR)	Working Length (in.)	Length (in.)
MA524R	2.5 x 4	2 3/4	4 1/2
MA526R	4 x 5	3	4 1/2
MA525R	2.5 x 4	3	5 1/2
MA528R	5 x 7	3	5 1/2
MA529R	6 x 8	3	5 1/2
MA530R	7 x 10	3	5 1/2
MA531R	8 x 12	3	5 1/2
MA532R	12 x 14	3	5 1/2
MA523R	2 x 2.5	3 3/8	5 1/8

ENT  
EAR

MILLIMETERS

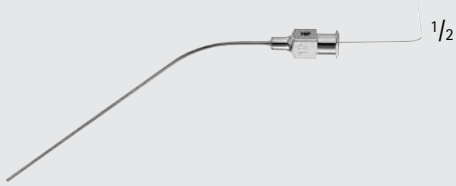
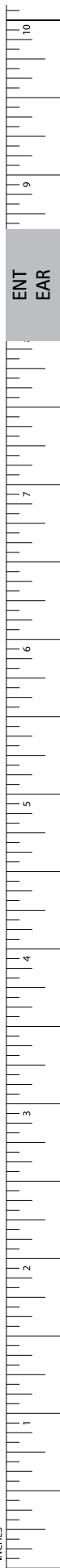

MB450R-MB453R

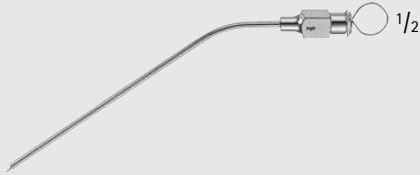

MA513R-MA522R

**ROSEN Suction Tube**

Catalog Number	Tip	Working Length (in.)	Length (in.)
MB450R	18 GA	2 3/8	3 1/2
MB451R	20 GA	2 3/8	3 1/2
MB452R	22 GA	2 3/8	3 1/2
MB453R	24 GA	2 3/8	3 1/2
MA513R	14 GA	2 3/8	4
MA514R	15 GA	2 3/8	4
MA515R	16 GA	2 3/8	4
MA516R	17 GA	2 3/8	4
MA518R	19 GA	2 3/8	4
MA522R	26 GA	2 3/8	4

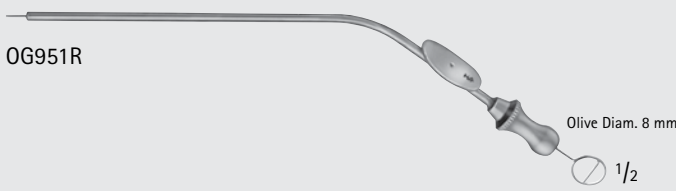

OG951R

Olive Diam. 8 mm

**BELLUCCI Suction Tube, Detachable Tips**

Catalog Number	Diameter (mm)	Description	Length (in.)
OG950R	-	SET	-
OG951R	8	SUCTION TUBE W/ FINGER CUT-OFF AND STYLET	6 1/8

OG950R Includes  
1 Suction Tube OG951R and Stylet

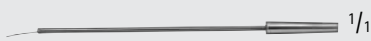

GF771R-GF775R

**ZOELLNER Suction, Tips Only for GF770R**

Catalog Number	Tip	Diameter (mm)
GF771R	18 GA	1.2
GF772R	20 GA	1.0
GF773R	22 GA	0.7
GF774R	24 GA	0.5
GF775R	26 GA	0.4

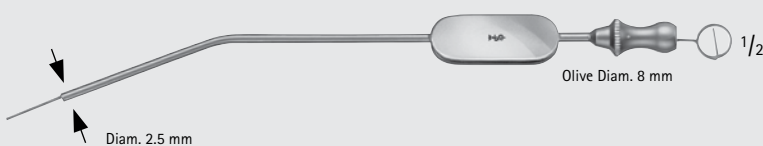

GF770R

Diam. 2.5 mm

Olive Diam. 8 mm

**ZOELLNER Suction Tube**

Catalog Number	Diameter (mm)	Length (in.)
GF770R	2.5	7



GF768R

Olive Diam. 7 mm

**HOUSE Cut-Off Adapter**

Catalog Number	Length (in.)
GF768R	2 1/4

# ENT-EAR

## Dissectors/Chisels/Gouges

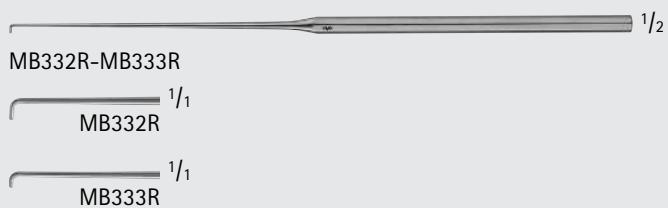

**CRABTREE "JIMMY" Dissector**

Catalog Number	Tip Size (mm)	Tip	Length (in.)
MB333R	1.3	SMALL	6 1/2
MB332R	2.0	LARGE	6 1/2

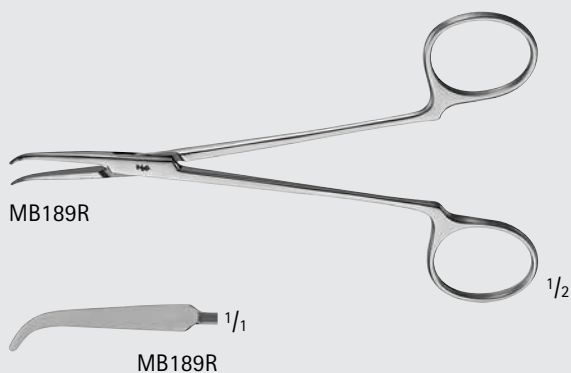

**MCCABE Facial Nerve Dissector**

Catalog Number	Tip Size (mm)	Jaw	Length (in.)
MB189R	25	ANG	5 1/2

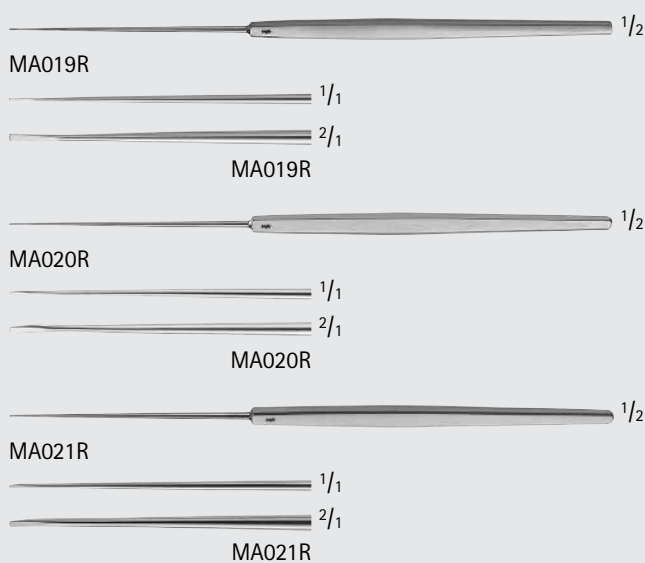

**DERLACKI Chisel**

Catalog Number	Tip Size (mm)	Blade Shape	Length (in.)
MA019R	0.5	STR	6 1/4
MA020R	0.5	ANG 10°	6 1/4
MA021R	0.5	ANG 20°	6 1/4

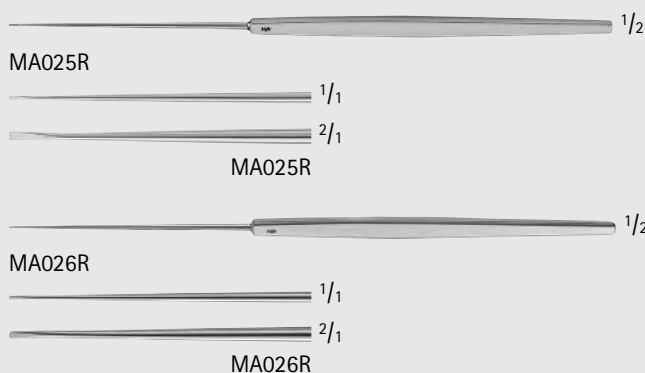

**HOUSE Footplate Chisel**

Catalog Number	Tip Size (mm)	Blade Shape	Length (in.)
MA025R	0.6	STR	6 1/4
MA026R	0.6	SLIGHT-CVD	6 1/4



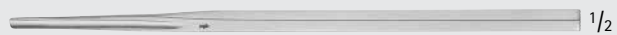

MA175R

1/2



MA176R

1/2

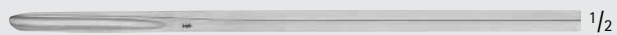

MA177R

1/2

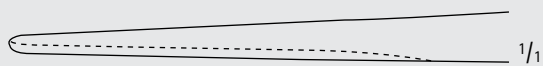

MA175R-MA177R

1/1

**BISHOP Mastoid Gouge**

Catalog Number	Tip Size (mm)	Length (in.)
MA175R	3	6
MA176R	4	6
MA177R	5	6



MA629R

1/2



MA629R

1/1



MB108R

1/2



MB108R

1/1

**PARKES Hump Gouge, Double Guarded**

Catalog Number	Tip Size (mm)	Length (in.)
MA629R	6	7
MB108R	10	7

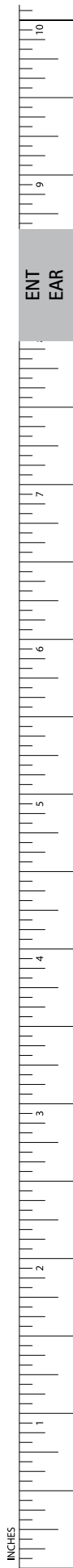

# ENT-EAR

## Elevators/Scrapers/Excavators

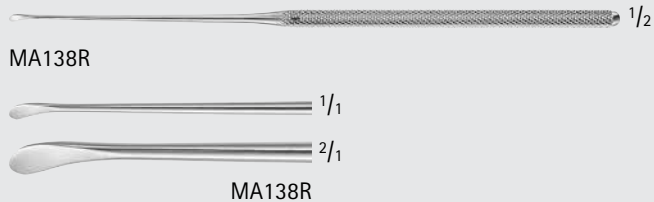

**AUSTIN Duckbill Elevator**

Catalog Number	Tip Size (mm)	Tip	Length (in.)
MA138R	2	CVD	6 1/4

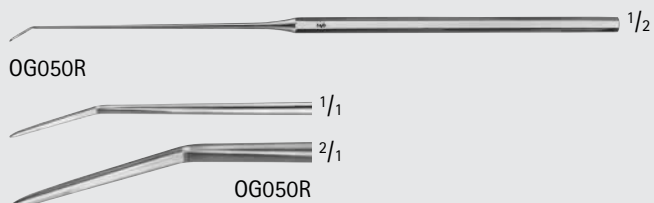

**HOUSE Elevator, Angled**

Catalog Number	Tip Size (mm)	Tip	Length (in.)
OG050R	1	ANG	6 1/4

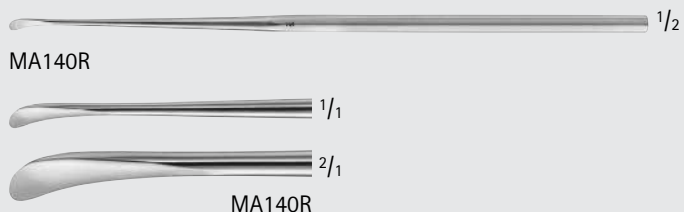

**PAPARELLA Duckbill Elevator**

Catalog Number	Tip Size (mm)	Size (#)	Length (in.)
MA140R	3	18	6 1/2

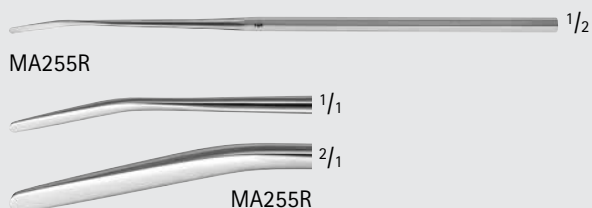

**GUILFORD-WRIGHT Drum Elevator, Angled**

Catalog Number	Tip Size (mm)	Length (in.)
MA255R	2	5 1/2

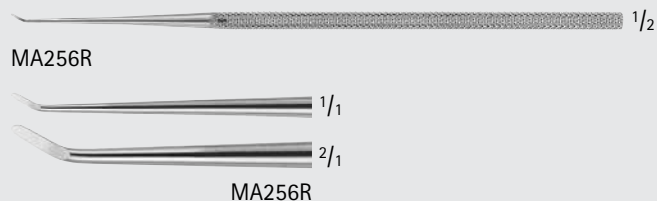

**HOUGH Drum Scraper**

Catalog Number	Tip Size (mm)	Tip	Length (in.)
MA256R	0.5	ANG 45°	6 1/4

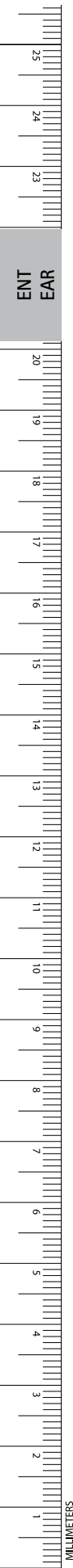

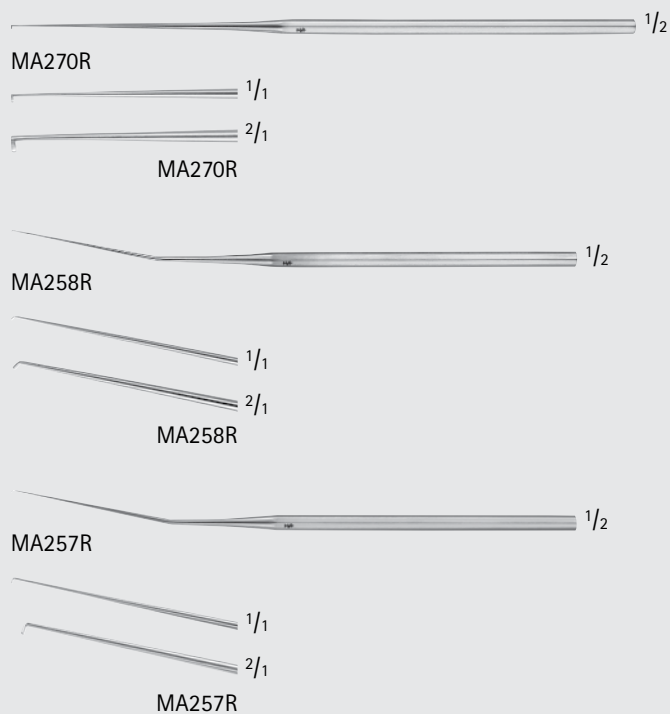

**HOUGH Excavator**

Catalog Number	Tip Size (mm)	Tip	Length (in.)
MA270R	0.33	ANG 30°	6 1/2
MA258R	0.33	ANG 45°	6
MA257R	0.33	ANG 90°	6

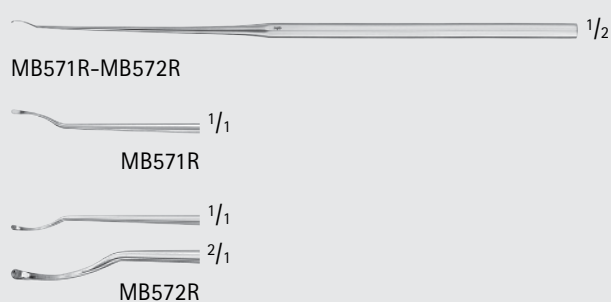

**HOUGH Whirlybird Excavator**

Catalog Number	Tip Size (mm)	Tip	Length (in.)
MB571R	0.7 x 3.0	CVD-LEFT	6
MB572R	0.7 x 3.0	CVD-RIGHT	6

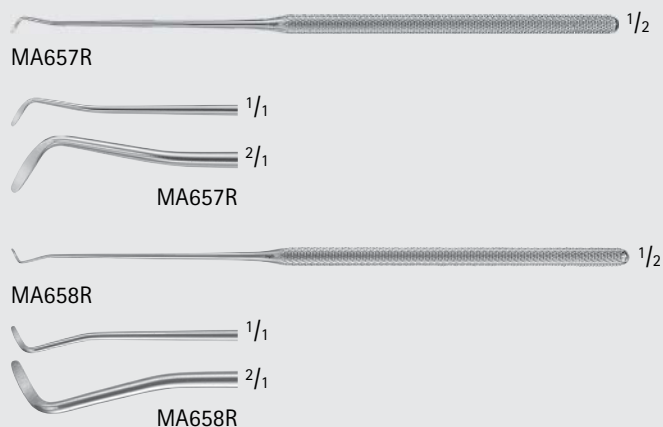

**AUSTIN Excavator**

Catalog Number	Tip Size (mm)	Tip	Length (in.)
MA657R	1	ANG LEFT	6 1/4
MA658R	1	ANG RIGHT	6 1/4

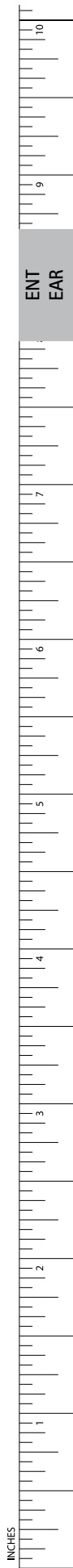

# ENT-EAR

## Augers/Measurers/Rasps

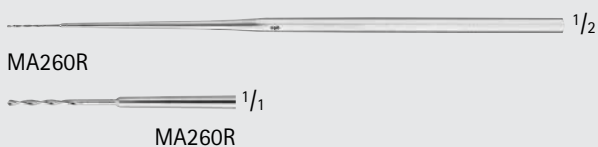

### HOUGH Footplate Auger Drill

Catalog Number	Tip Size (mm)	Tip	Length (in.)
MA260R	0.8 x 20.0	DRILL	5 7/8

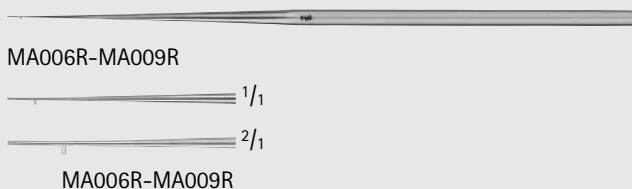

### HOUSE-STRUT Measuring Rod W/ Markers

Catalog Number	Tip Size (mm)	Description	Length (in.)
MA006R	3.5	MEASURING ROD 3.5 MM FROM MARKET TO TIP	6 1/2
MA007R	4.0	MEASURING ROD 4.0 MM FROM MARKET TO TIP	6 1/2
MA008R	4.5	MEASURING ROD 4.5 MM FROM MARKET TO TIP	6 1/2
MA009R	5.0	MEASURING ROD 5.0 MM FROM MARKET TO TIP	6 1/2

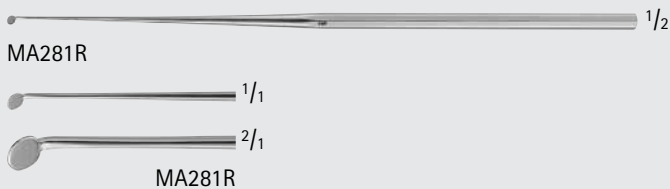

### Middle Ear Mirror

Catalog Number	Diameter (mm)	Tip	Length (in.)
MA281R	2	ANG 45°	6 1/2

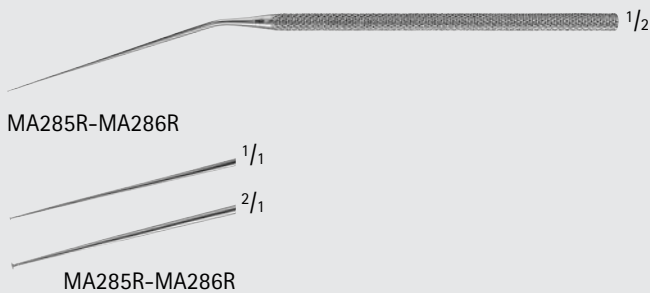

### MCGEE Oval Window Rasp

Catalog Number	Size	Length (in.)
MA285R	SMALL	6 3/8
MA286R	LARGE	6 3/8

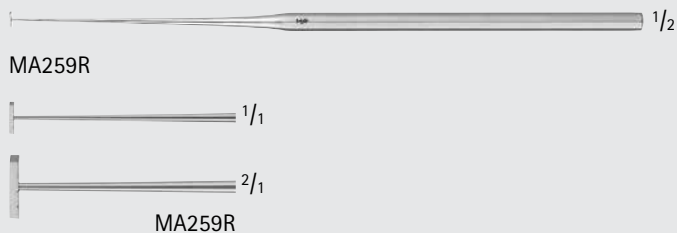

### PAPARELLA Fenestrometer

Catalog Number	Blade Size (mm)	Tip Size (#)	Length (in.)
MA259R	1 x 4	13	6 3/8

ENT  
EAR

20

19

18

17

16

15

14

13

12

11

10

9

8

7

6

5

4

3

2

1

MILLIMETERS

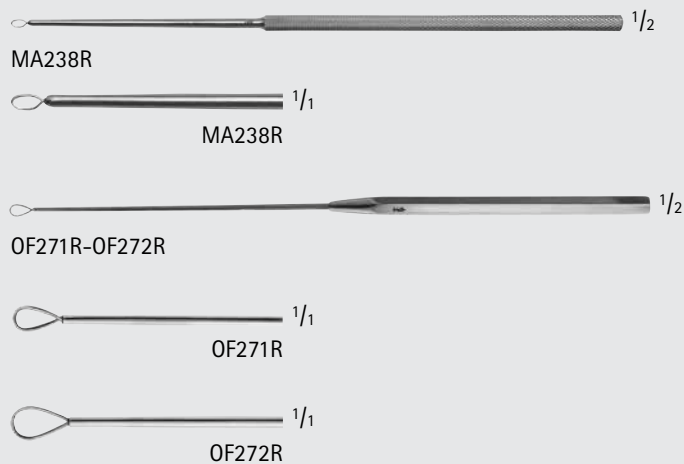

**BILLEAU Ear Loop**

Catalog Number	Tip Size (mm)	Tip	Length (in.)
MA238R	2	SMALL	6 3/8
OF271R	2	MEDIUM	6 1/4
OF272R	3	LARGE	6 1/4

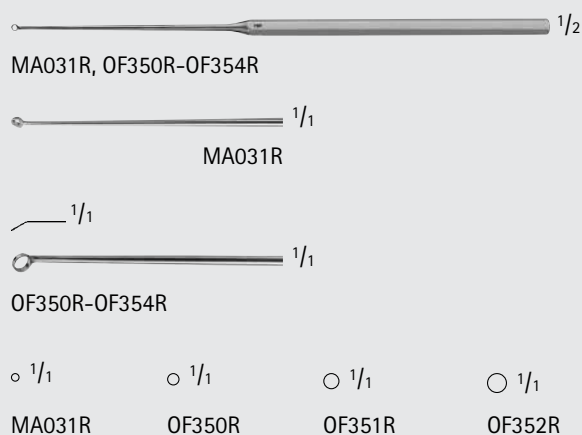

**BUCK Ear Curette, Sharp, Curved**

Catalog Number	Tip Size (#)	Cup Size (mm)	Length (in.)
MA031R	00	1.0	6
OF350R	00	1.5	6
OF351R	0	2.0	6
OF352R	1	2.5	6
OF353R	2	3.0	6
OF354R	3	4.0	6

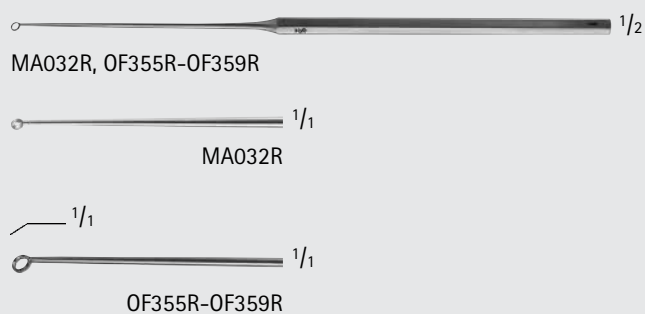

**BUCK Ear Curette, Blunt, Curved**

Catalog Number	Tip Size (#)	Cup Size (mm)	Length (in.)
MA032R	00	1.0	6
OF355R	00	1.5	6
OF356R	0	2.0	6
OF357R	1	2.5	6
OF358R	2	3.0	6
OF359R	3	4.0	6

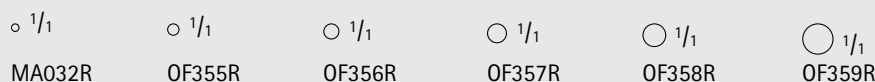

# ENT-EAR

## Curettes/Loops/Spoons



MA252R

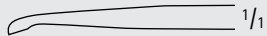

MA252R

### HOUGH Ear Curette

Catalog Number	Cup Size (mm)	Tip	Size	Length (in.)
MA252R	2.25 x 3 SERR	ANG 30°	LARGE	5 5/8



MB039R



MB039R



MA279R



MA279R

### GUILFORD-WRIGHT Ear Curette, Angled

Catalog Number	Cup Size (mm)	Size	Length (in.)
MB039R	2.4 x 1.4	SMALL	5 1/8
MA279R	2.5 x 3.0	MEDIUM	5 1/4



MA055R



MA055R

### SHEA Ear Curette, Round

Catalog Number	Cup Size (mm)	Blade	Length (in.)
MA055R	2	ANG	5 1/2



MA053R-MA054R



MA053R-MA054R

### SHAPLEIGH Ear Curette, Angled

Catalog Number	Tip Size (mm)	Tip	Size	Length (in.)
MA053R	1.5	SERR	SMALL	6 1/2
MA054R	2.0	SERR	LARGE	6 1/2

ENT  
EAR

MILLIMETERS



**FREIMUTH Ear Curette**

Catalog Number	Cup Size (mm)	Tip	Size	Length (in.)
MA653R	2.5 x 4	SERR	SMALL	6 1/4

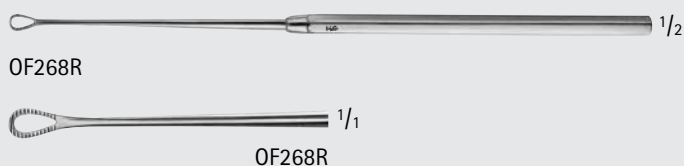

**SNELLEN Ear Curette**

Catalog Number	Tip	Blade	Length (in.)
OF268R	SERR	CVD	6 1/4



**Ear Curette, Pointed, Double Ended**

Catalog Number	Cup Size	Length (in.)
OG189R	LARGE	6 3/4

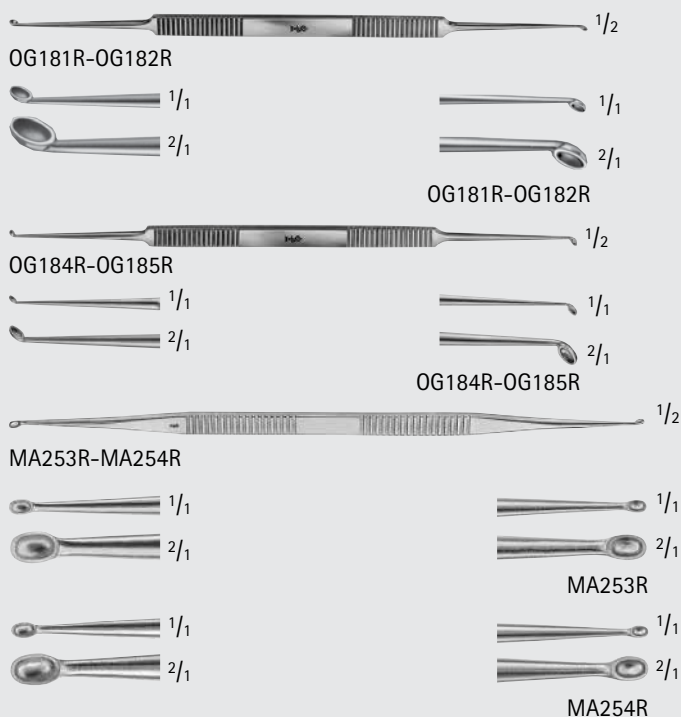

**HOUSE Ear Curette, Double Ended**

Catalog Number	Cup Size (mm)	Tip	Length (in.)
OG181R	1.0 / 1.2	ANG	6
OG182R	1.5 / 1.8	ANG	6
OG184R	1.0 / 1.2	STRONG ANG	6
OG185R	1.5 / 1.8	STRONG ANG	6
MA253R	2.0 / 1.7	LIGHT ANG	7
MA254R	2.0 / 2.25	STRONG ANG	7

# ENT-EAR

## Curettes/Loops/Spoons



MA035R

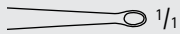
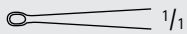

MA035R

### HOUSE-PAPARELLA Stapes Ear Curette, Double Ended

Catalog Number	Cup Size (mm)	Length (in.)
MA035R	1.6 x 3.0 / 2.0 x 3.5	6 1/4



MA036R



MA036R

### HOUSE Stapes Curette, Double Ended

Catalog Number	Cup Size (mm)	Length (in.)
MA036R	1.8 x 2.5 / 1.5 x 2.4	6



OG180R



OG180R

### SHEA Bone Curette, Oval

Catalog Number	Cup Size (mm)	Blade	Length (in.)
OG180R	1.5 x 2.5	STR	6 1/4

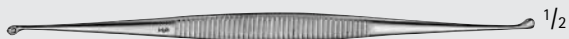

FK800R

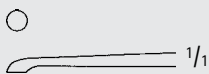

FK800R



FK801R



FK801R

### MARTINI Bone Curette, Double Ended

Catalog Number	Cup Size (mm)	Length (in.)
FK800R	3.0 / 3.2	5 1/2
FK801R	4.0 / 3.2	5 1/2

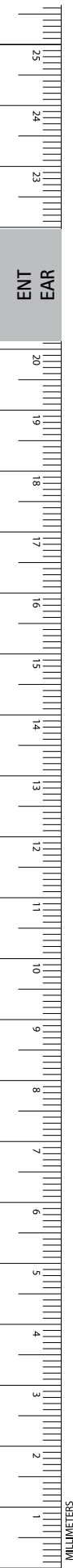



MA051R

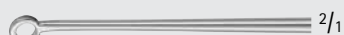

MA051R

**PAPARELLA Ring Curette**

Catalog Number	Cup Size (#)	Blade	Length (in.)
MA051R	12	ANG	6 1/2



MB117R



MB117R

**PRATT Ethmoid Curette, Double Ended**

Catalog Number	Blade	Length (in.)
MB117R	SOLID/FENESTRATED	9 1/4



MA188R



MA188R

**GROSS Ear Hook/Spoon, Double Ended**

Catalog Number	Hook	Spoon	Length (in.)
MA188R	90° BLUNT 2.6 MM	3.2 x 7.5 MM	5 1/4

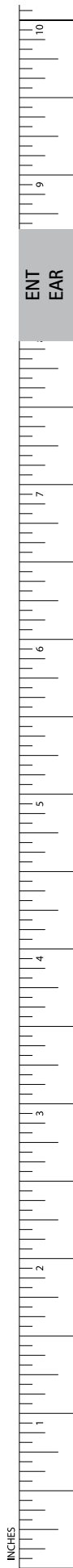

INCHES

# ENT-EAR

## Rongeurs



MA439R-MA442R

### KERRISON Mastoid Rongeur, 90° Up

Catalog Number	Tip Size (#)	Jaw Size (mm)	Working Length (in.)	Length (in.)
MA439R	0	3.5 x 9	4 1/8	6 3/4
MA440R	1	4.0 x 9	4 1/8	6 3/4
MA441R	2	4.5 x 9	4 1/8	6 3/4
MA442R	3	5.0 x 9	4 1/8	6 3/4



MA439R



MA440R



MA441R



MA442R

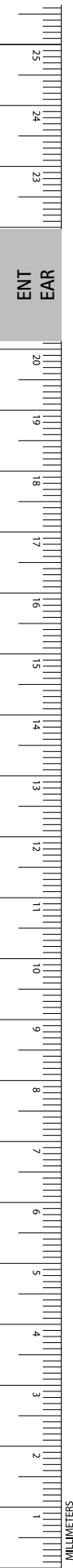

# ENT-EAR Tuning Forks



OF001N-OF006N

## HARTMANN Tuning Fork

Catalog Number	Frequency
MB575A	c 64
OF001N	c 128
OF002N	c1 256
OF003N	c2 512
OF004N	c3 1024
OF005N	c4 2048
OF006N	c5 4096



MB575A

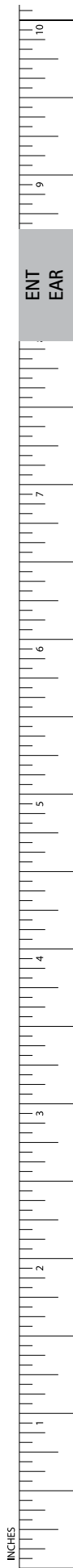

INCHES

# ENT-EAR

## Miscellaneous

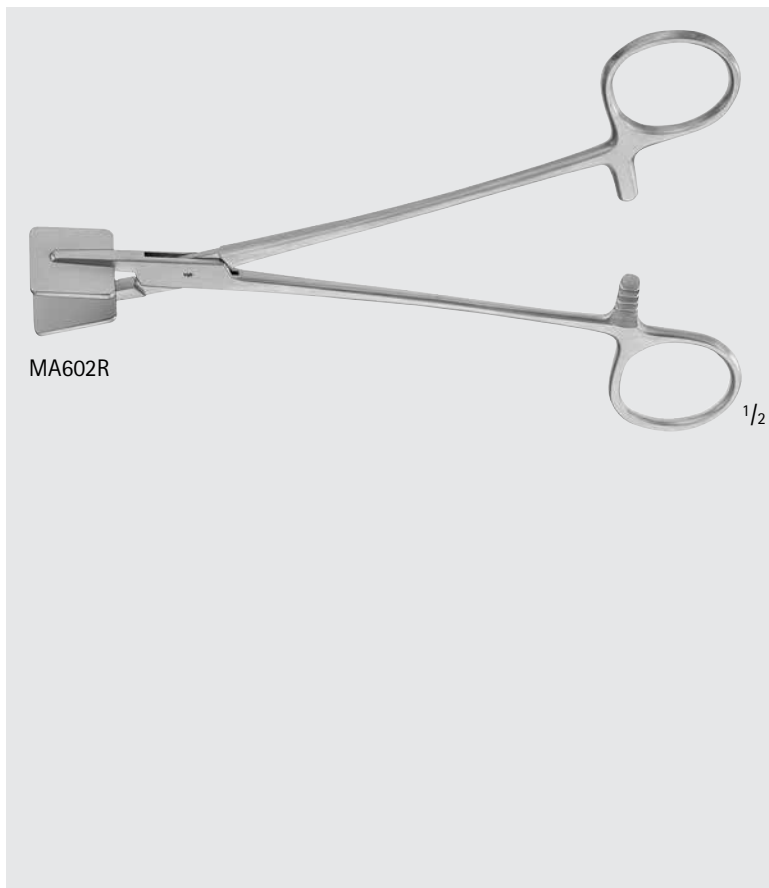
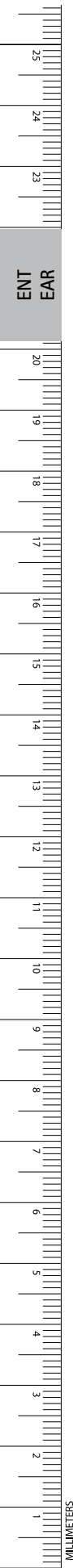

### SHEEHY Fascia Press

Catalog Number	Jaw Size (mm)	Jaw	Description	Length (in.)
MA602R	23 x 31	PLATE	W/ RATCHET BOX LOCK	7 1/2

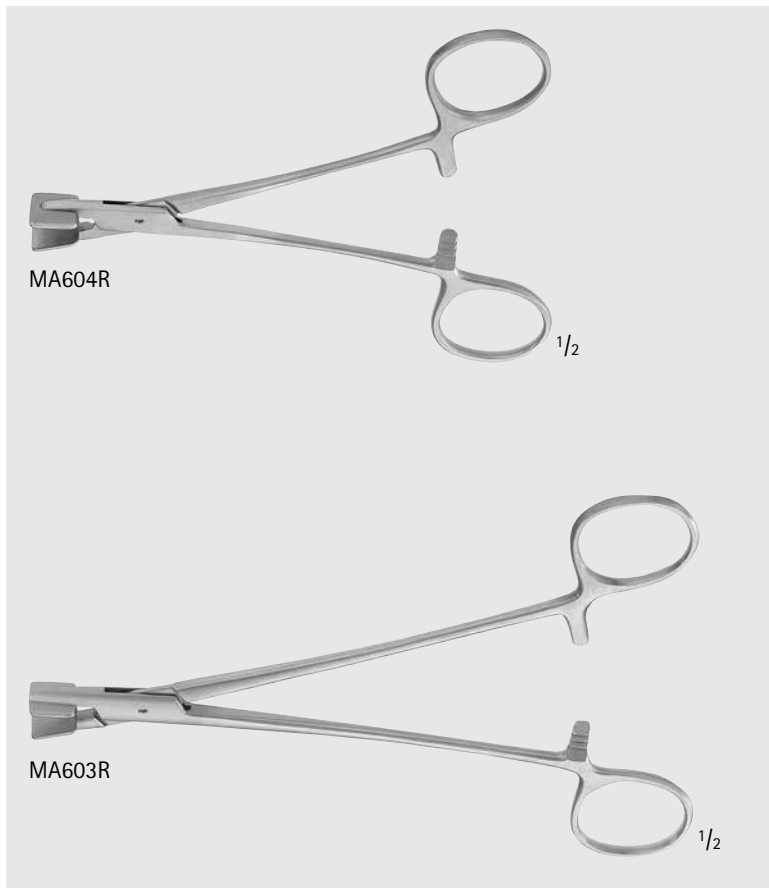

### HOUSE Gelfoam Press, with Ratchet

Catalog Number	Jaw Size (mm)	Jaw	Length (in.)
MA604R	12 x 15	PLATE	5 3/8
MA603R	12 x 16	PLATE	7



MA605R

HOUSE Cutting Block, Delrin

Catalog Number	Dimensions (mm)	Description	Length (in.)
MA605R	8 x 38	AUTOCLAVABLE	2 7/8



OG145R

Surgery Preparation Base W/ mm Scale

Catalog Number	Dimensions (mm)
OG145R	92 x 54

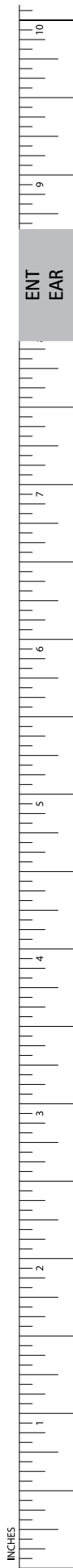

INCHES

ENT-EAR

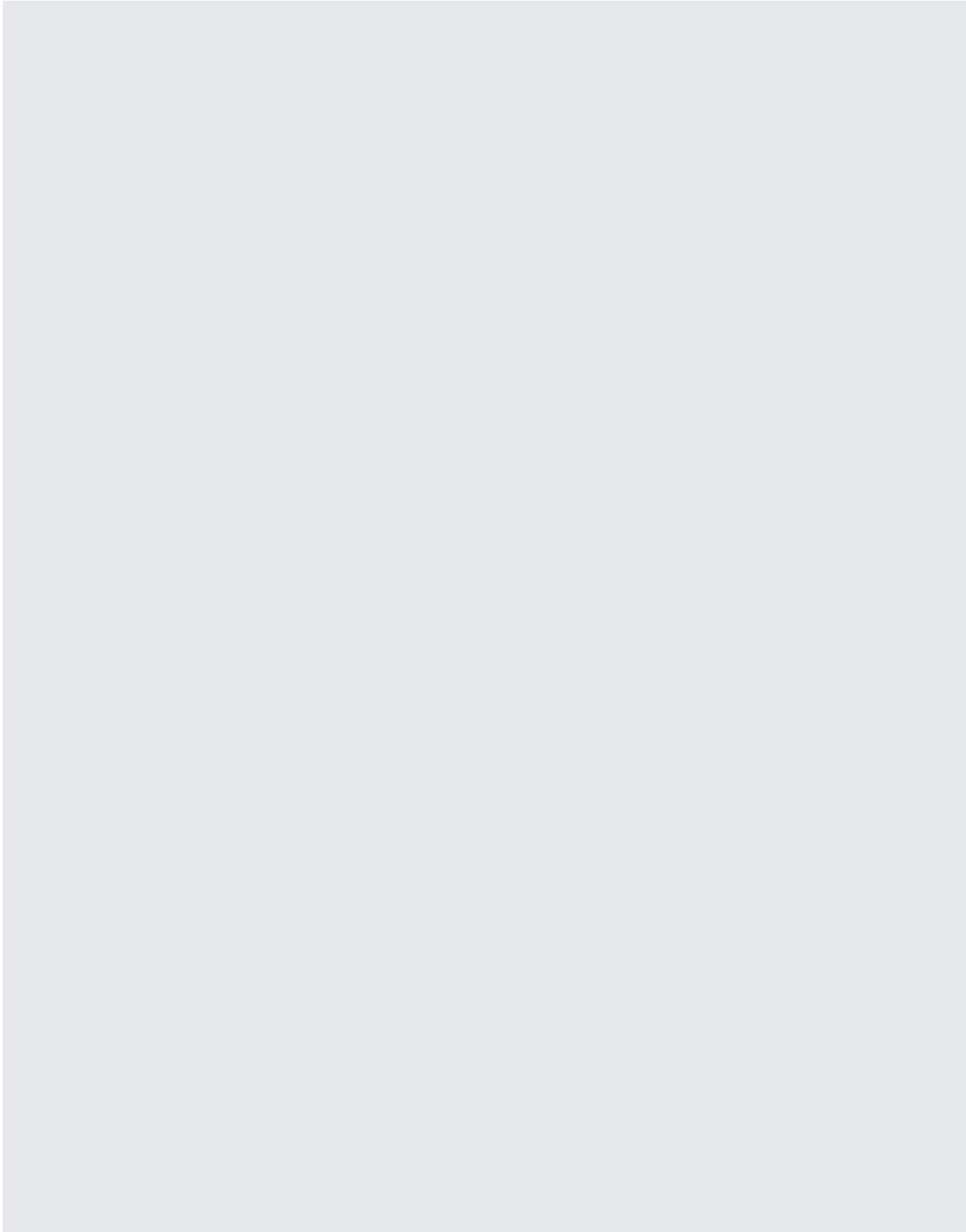
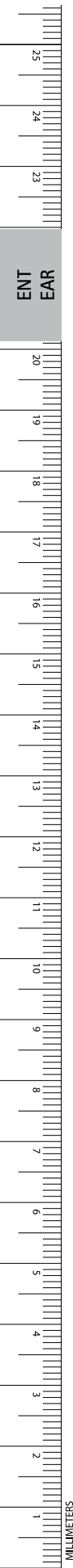



## ENT-Nasal

Scissors .....	596 - 614
Trocar, Needles and Needle Holders .....	615 - 617
Forceps .....	618 - 649
Nasal Snares and Wires .....	650
Hooks .....	651
Retractors .....	652 - 657
Elevators and Dissectors .....	658 - 664
Specula .....	665 - 673
Rasps, Files and Saws .....	674 - 677
Chisels and Gouges .....	678 - 679
Osteotomes .....	680 - 685
Applicators and Probes .....	686
Knives .....	687 - 688
Suction and Irrigation .....	689 - 692
Mallets, Hammers and Tamps .....	693 - 694
Curettes .....	695 - 698
Rongeurs .....	699 - 703

# ENT-NASAL

## Scissors



MA449R

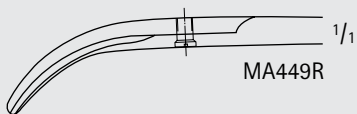

MA449R

### CINELLI Lower Lateral Scissors

Catalog Number	Blade	Length (in.)
MA449R	STRONG CVD	4 3/8

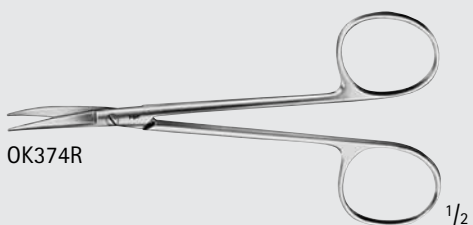

OK374R

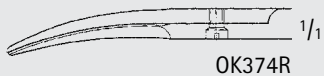

OK374R

### COTTLE Bulldog Scissors

Catalog Number	Tip	Blade	Length (in.)
OK374R	B/B	CVD	4 1/2

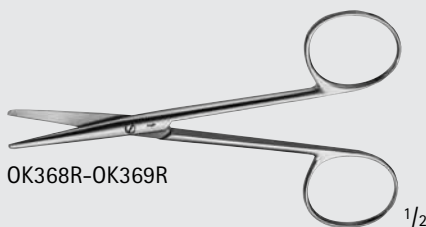

OK368R-OK369R

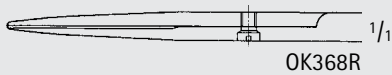

OK368R

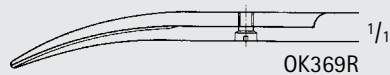

OK369R

### COTTLE-KNAPP Plastic Scissors

Catalog Number	Tip	Blade	Length (in.)
OK368R	B/B	STR	4 1/8
OK369R	B/B	CVD	4 1/8

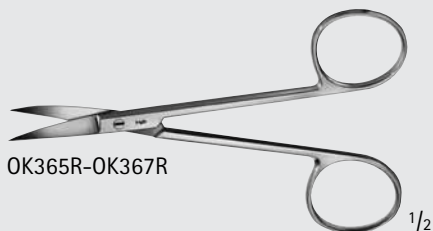

OK365R-OK367R

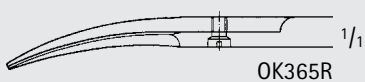

OK365R

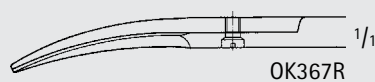

OK367R

### COTTLE-MASING Plastic Scissors

Catalog Number	Tip	Blade	Length (in.)
OK365R	S/S	CVD	4 1/8
OK367R	B/B	CVD	4 1/8

ENT  
NASAL

DAVIS Rhytidectomy Scissors

Catalog Number	Blade	Length (in.)
MA450R	CVD	6 3/4

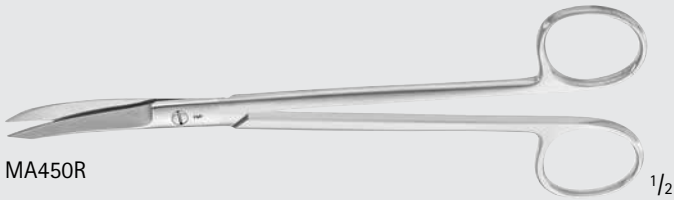

MA450R

1/2

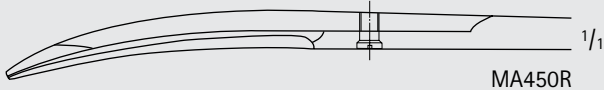

1/1

MA450R

Rhinoplasty Scissors

Catalog Number	Tip	Blade	Length (in.)
MG086R	B/B	FLAT, CVD	5 1/4

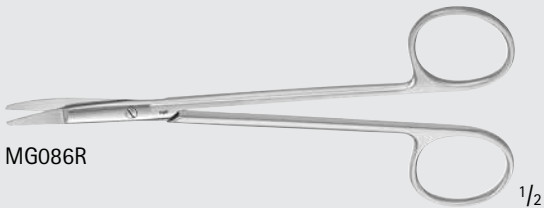

MG086R

1/2

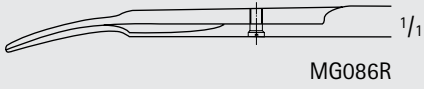

1/1

MG086R



ENT  
NASAL

INCHES

# ENT-NASAL

## Scissors

MA335R-MA337R



MA335R  $\frac{1}{1}$

MA336R  $\frac{1}{1}$

MA337R  $\frac{1}{1}$

### Nasal Scissors, Pediatric

Catalog Number	Blade	Blade Size (mm)	Length (in.)
MA335R	STR	6	4
MA336R	CVD-RIGHT	5.5	4
MA337R	CVD-LEFT	5.5	4

MA318R, MA600R, MA599R

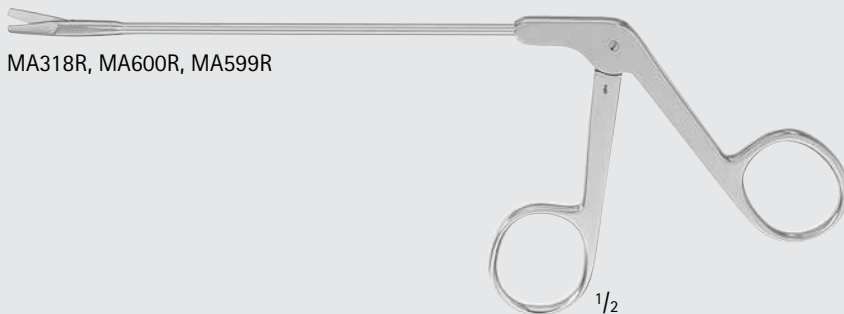

MA318R  $\frac{1}{1}$

MA600R  $\frac{1}{1}$

MA599R  $\frac{1}{1}$

### Nasal Scissors, Adult

Catalog Number	Blade	Blade Size (mm)	Working Length (in.)
MA318R	STR	11	5 1/8
MA600R	RIGHT	11	5 1/8
MA599R	LEFT	11	5 1/8

ENT  
NASAL

MILLIMETERS



MA609R

1/2

LAKESIDE Nasal Scissors

Catalog Number	Blade	Length (in.)
MA609R	STR	7 1/4

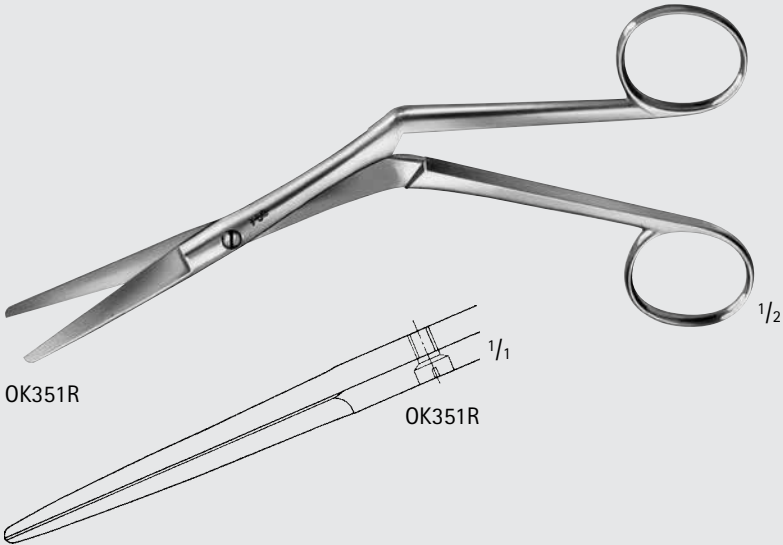

OK351R

OK351R

1/2

HEYMANN Nasal Scissors

Catalog Number	Tip	Blade	Length (in.)
OK351R	B/B	STR	7 1/2

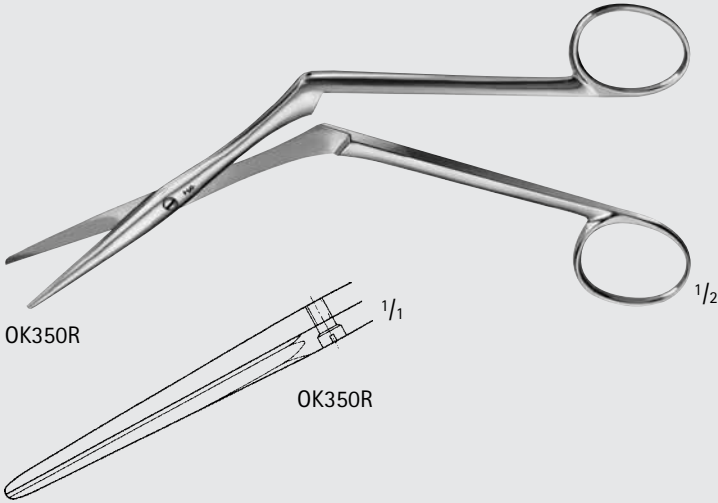

OK350R

OK350R

1/2

HEYMANN-KNIGHT Nasal Scissors

Catalog Number	Tip	Blade	Length (in.)
OK350R	B/B	STR	6 7/8



INCHES

# ENT-NASAL

## Scissors

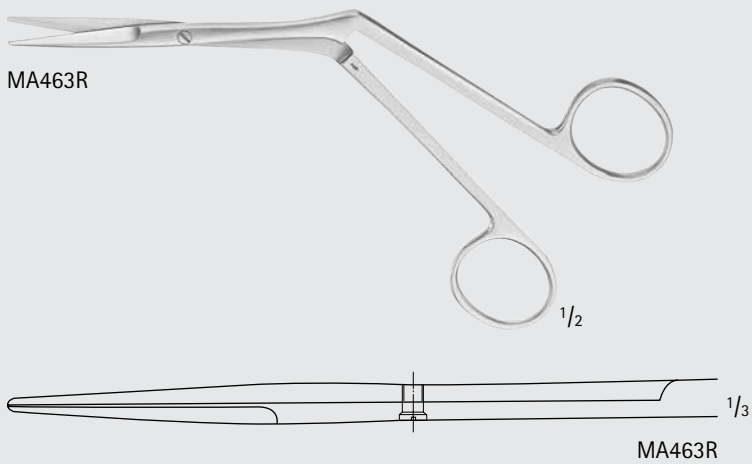

**KNIGHT Nasal Scissors, Lightweight, Delicate**

Catalog Number	Blade	Tip	Length (in.)
MA463R	STR	DEL	6 3/8

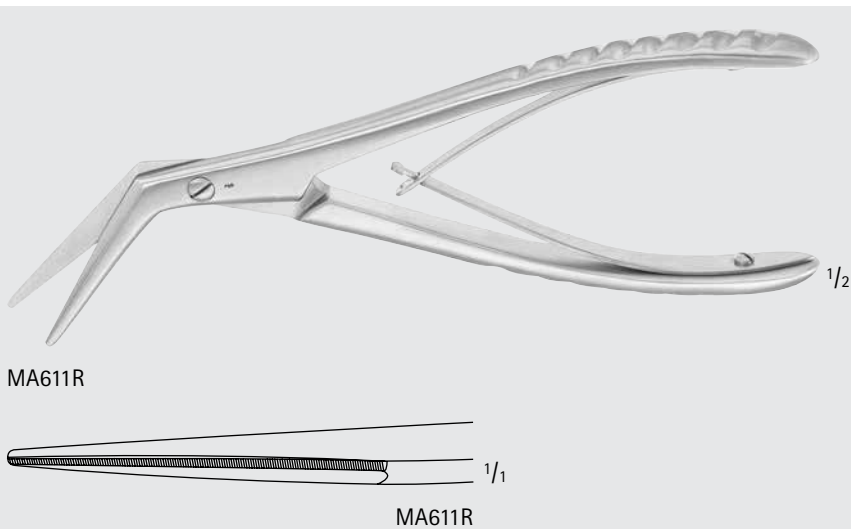

**JACKSON Nasal Bone Scissors**

Catalog Number	Blade	Length (in.)
MA611R	ANG	8 1/2

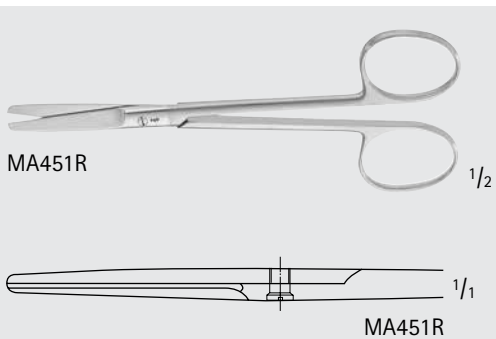

**Dorsal Scissors**

Catalog Number	Tip	Blade	Length (in.)
MA451R	BLUNT	STR	4 3/4

ENT  
NASAL

MILLIMETERS

FOMON Dorsal Scissors

Catalog Number	Tip	Blade	Handle	Length (in.)
MA452R	B/B	SERR	ANG	5 3/4
OK370R	B/B	SERR	ANG	5 3/4

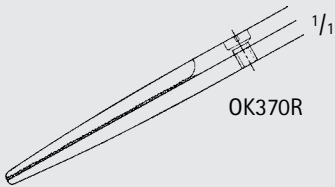
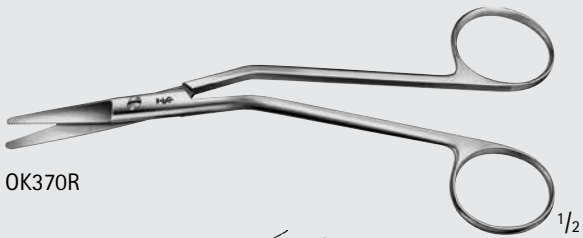
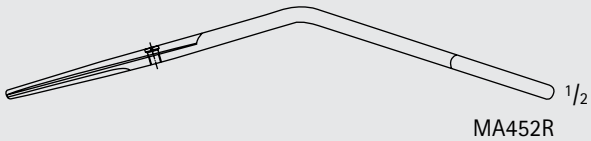

FOMON Lower Lateral Scissors

Catalog Number	Tip	Blade	Length (in.)
OK373R	B/B	HEAVY-CVD	4 1/2
OK372R	B/B	HEAVY-CVD	5 1/4

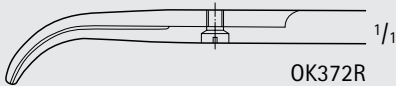
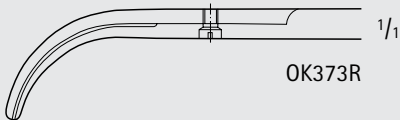
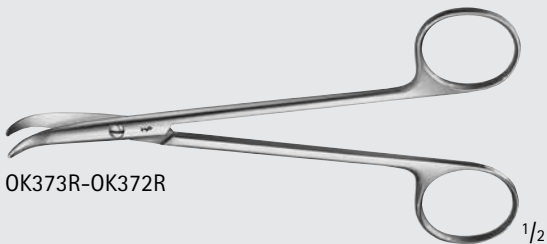

FOMON Saber-Back Scissors

Catalog Number	Tip	Blade	Length (in.)
MB140R	B/B	CVD, SERR	5



ENT  
NASAL

INCHES

# ENT-NASAL

## Scissors

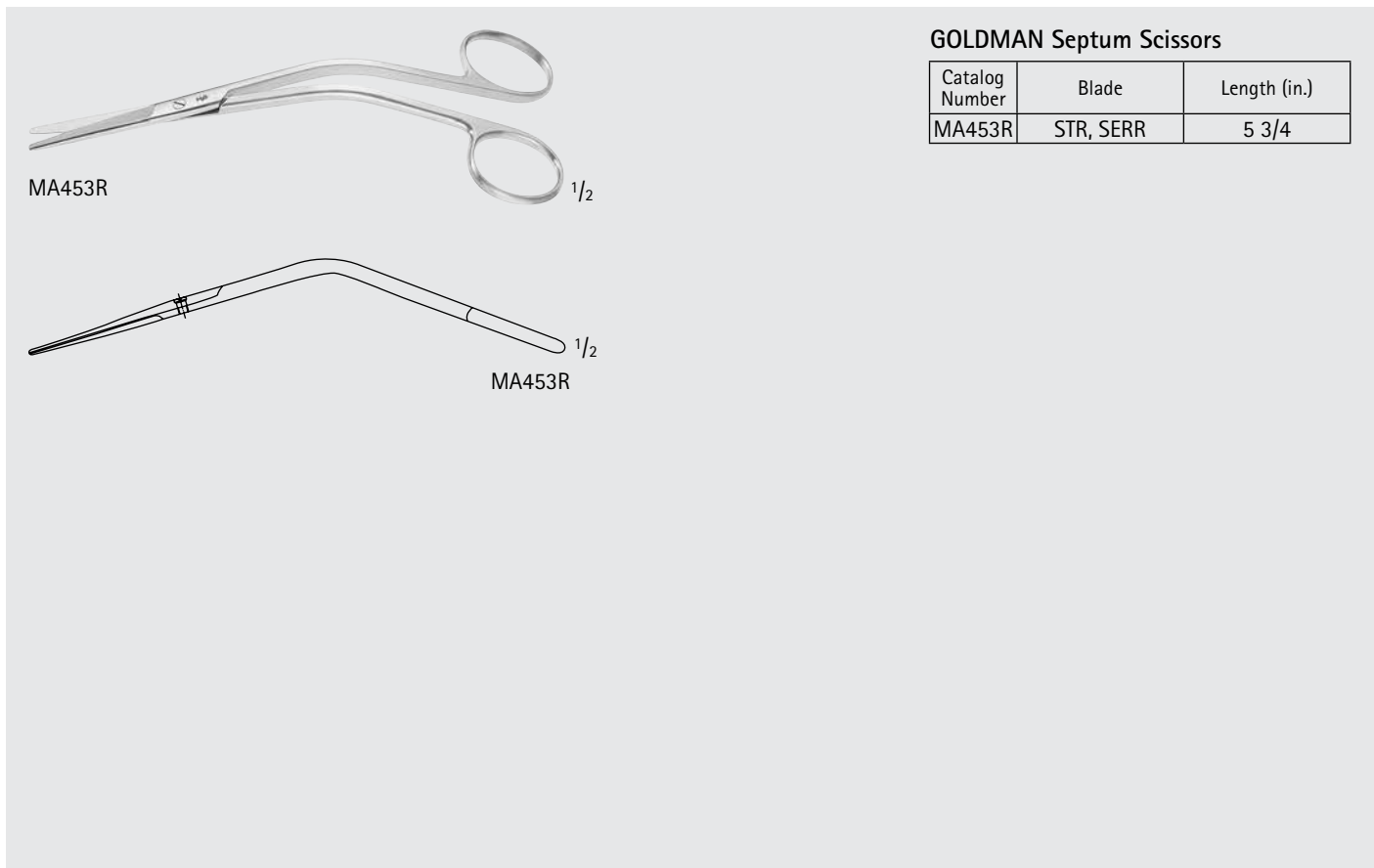
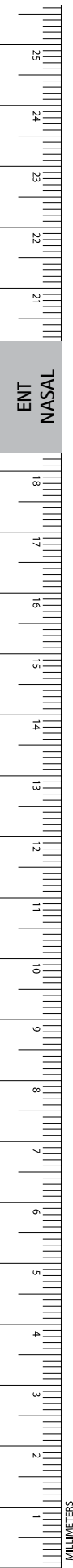

**GOLDMAN Septum Scissors**

Catalog Number	Blade	Length (in.)
MA453R	STR, SERR	5 3/4

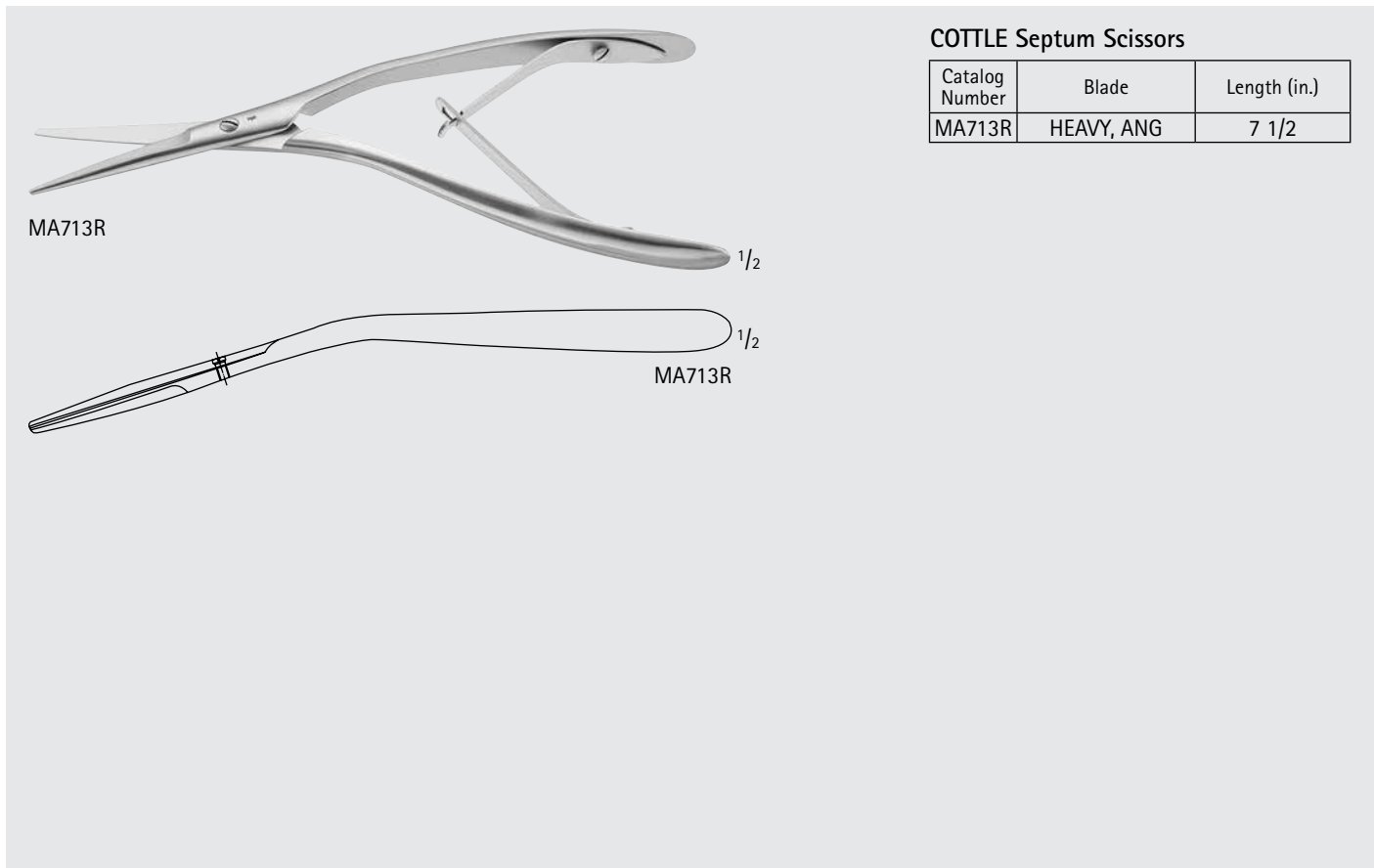

**COTTLE Septum Scissors**

Catalog Number	Blade	Length (in.)
MA713R	HEAVY, ANG	7 1/2

GORNEY Turbinate Scissors, Double Action

Catalog Number	Jaw	Length (in.)
MA455R	SERR	8

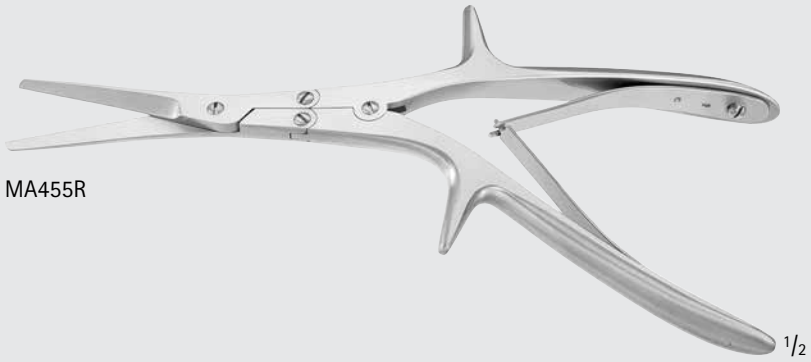

MA455R



MA455R

Becker Septum Scissors, Double Joint

Catalog Number	Blade	Length (in.)
OK353R	SERR	7

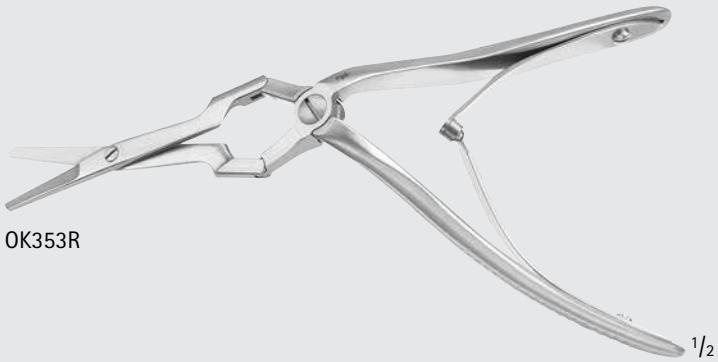

OK353R

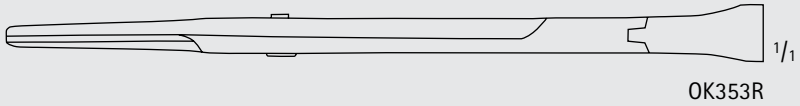

OK353R



# ENT-NASAL

## Scissors

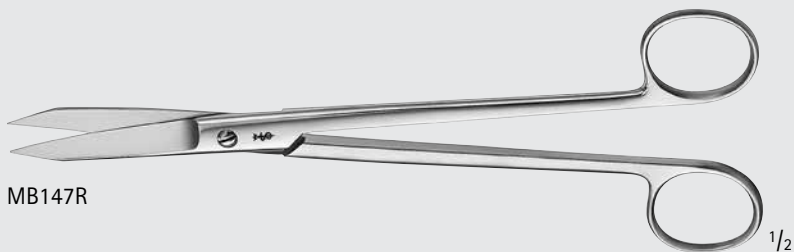

MB147R



MB147R

### MARTIN Cartilage Scissors

Catalog Number	Blade	Length (in.)
MB147R	CVD, SERR	8



MB150R

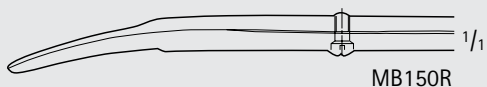

MB150R

### METZENBAUM-LIPSETT Scissors

Catalog Number	Tip	Blade	Length (in.)
MB150R	B/B	CVD	5 1/2



MA709R

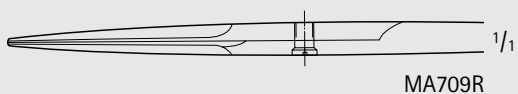

MA709R

### PECK-JOSEPH Scissors

Catalog Number	Blade	Tip Size (mm)	Length (in.)
MA709R	STR, SHARP	42	5 3/4

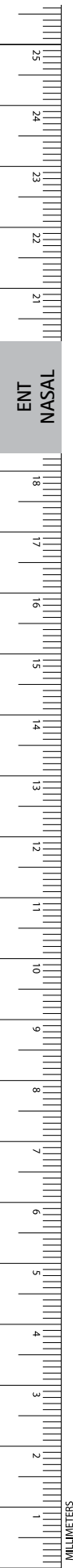

JOSEPH Scissors, Delicate

Catalog Number	Tip	Blade	Handle	Length (in.)
MB174R	S/S	STR, SERR	ROUND	5 1/2
MB175R	S/S	CVD, SERR	ROUND	5 1/2
BC156R	S/S	STR	ROUND	6
BC157R	S/S	CVD	ROUND	6
BC006R	S/S	STR	SQUARE	6
BC007R	S/S	CVD	SQUARE	6

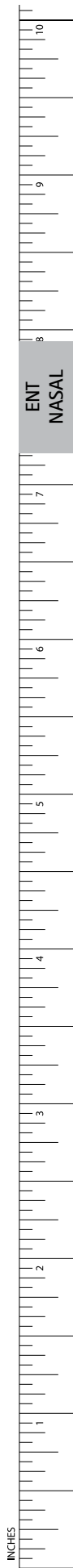
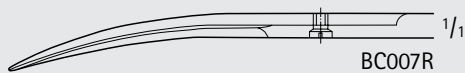
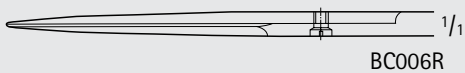
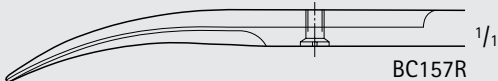
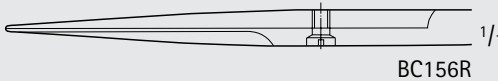
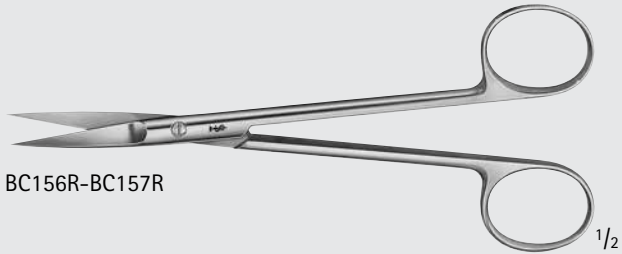
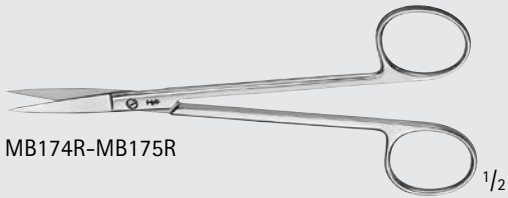

ENT  
NASAL

INCHES

# ENT-NASAL

## Scissors

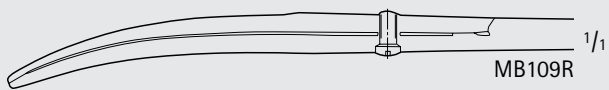
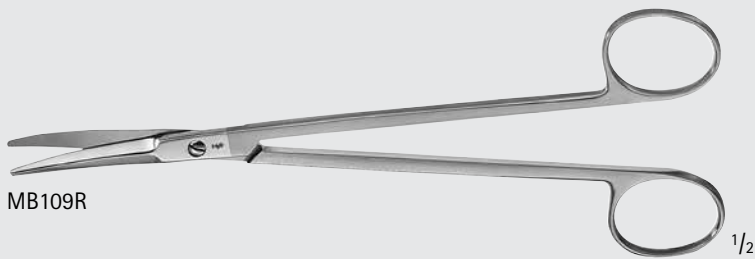
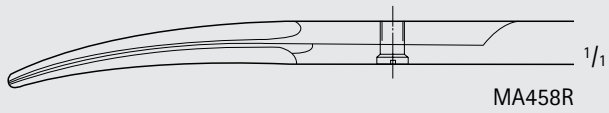
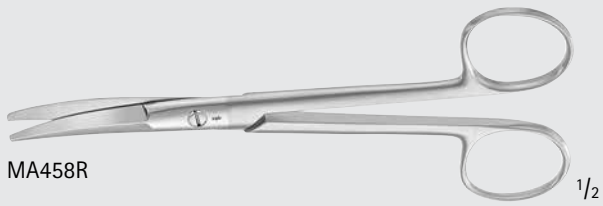

### KAYE Facelift Scissors

Catalog Number	Tip	Blade	Length (in.)
MA458R	SEMI-SHARP	CVD, SERR	6
MB109R	SEMI-SHARP	CVD, SERR	7 1/2

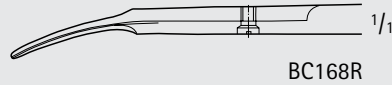
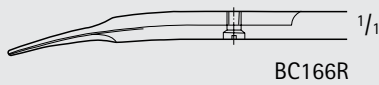
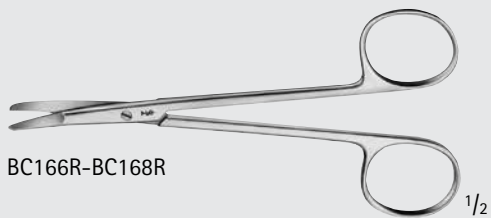

### KILNER Scissors

Catalog Number	Tip	Blade	Length (in.)
BC166R	FLAT	CVD	5
BC168R	FLAT	CVD	6

ENT  
NASAL

MILLIMETERS

JAMESON Tenotomy Scissors, Delicate

Catalog Number	Tip	Blade	Length (in.)
BC177R	B/B	CVD	6

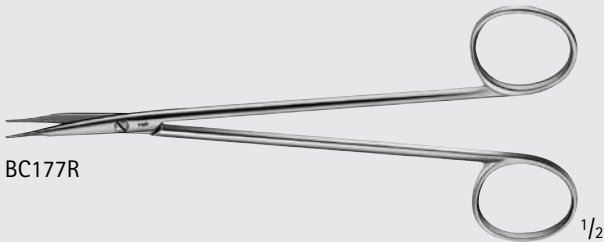

BC177R

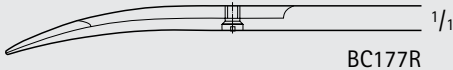

BC177R

REYNOLDS-JAMESON Tenotomy Scissors, Delicate

Catalog Number	Tip	Blade	Handle	Length (in.)
BC015R	B/B	CVD	SQUARE	5 1/2

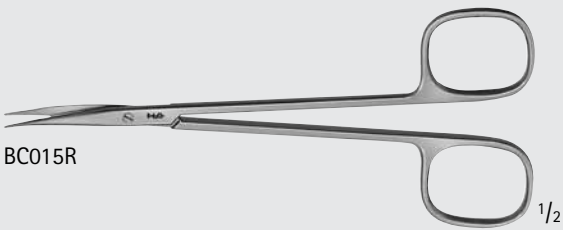

BC015R

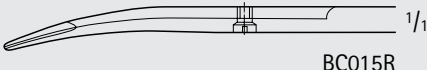

BC015R

REYNOLDS Tenotomy Scissors, Delicate

Catalog Number	Tip	Blade	Length (in.)
BC180R	B/B	CVD	5 3/4
BC181R	B/B	CVD	6 7/8

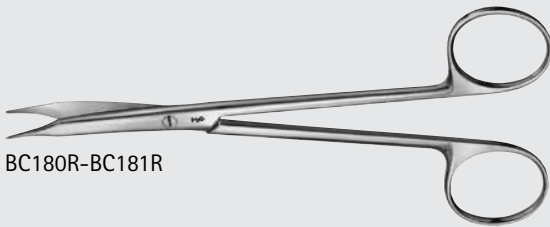

BC180R-BC181R

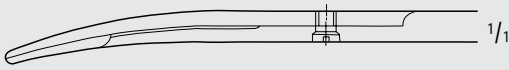

BC180R

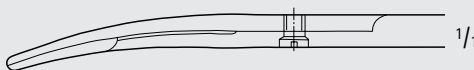

BC181R

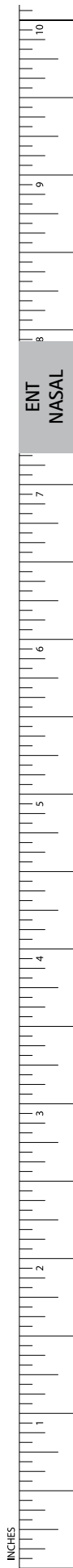

# ENT-NASAL

## Scissors

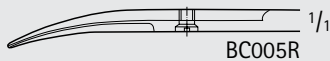
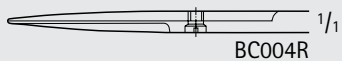
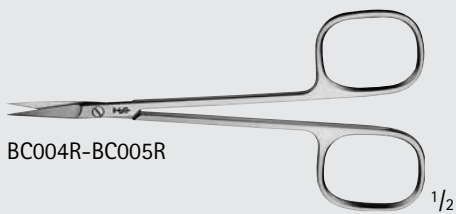

### Iris Scissors, Delicate

Catalog Number	Tip	Blade	Handle	Length (in.)
BC004R	S/S	STR	SQUARE	4 1/2
BC005R	S/S	CVD	SQUARE	4 1/2

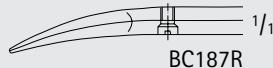
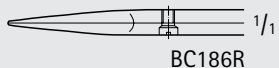
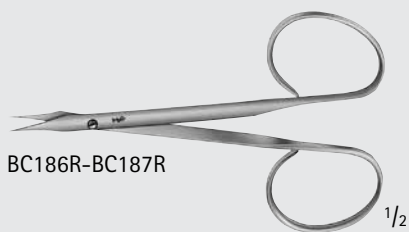

### STEVENS Tenotomy Scissors, Delicate

Catalog Number	Tip	Blade	Handle	Length (in.)
BC186R	S/S	STR	RIBBON	4
BC187R	S/S	CVD	RIBBON	4
OK366R	B/B	CVD	RIBBON	4 1/4

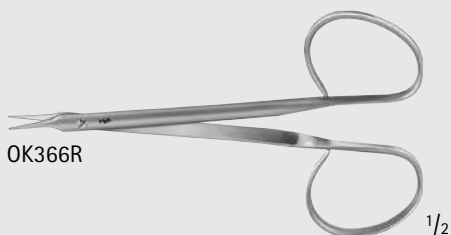

### STEVENS Tenotomy Scissors, Delicate

Catalog Number	Tip	Blade	Handle	Length (in.)
BC008R	S/S	STR	SQUARE	4 1/2
BC010R	B/B	STR	SQUARE	4 1/2
BC009R	S/S	CVD	SQUARE	4 1/2
BC011R	B/B	CVD	SQUARE	4 1/2

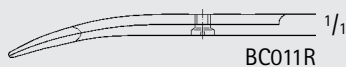
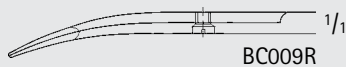
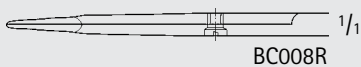
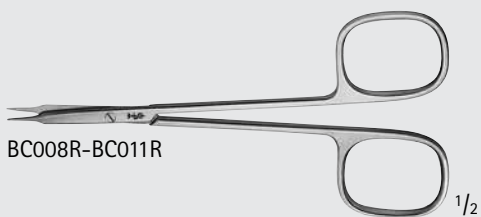

ENT  
NASAL

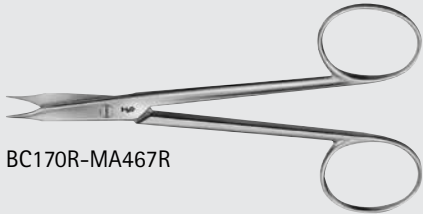

BC170R-MA467R



BC170R

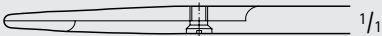

BC172R

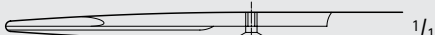

BC194R



MA467R



BC171R-MA466R



BC171R

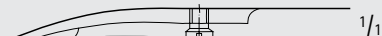

BC173R

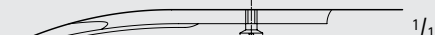

BC195R



MA466R

STEVENS Tenotomy Scissors

Catalog Number	Tip	Blade	Handle	Length (in.)
BC170R	S/S	STR	ROUND	4 1/4
BC172R	B/B	STR	ROUND	4 1/4
BC194R	B/B	STR	ROUND	5
MA467R	B/B	STR	ROUND	5 3/4
BC171R	S/S	CVD	ROUND	4 1/4
BC173R	B/B	CVD	ROUND	4 1/4
BC195R	B/B	CVD	ROUND	5
MA466R	B/B	CVD	ROUND	5 3/4



ENT NASAL

# ENT-NASAL

## Scissors

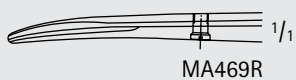
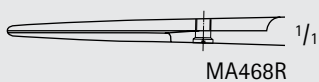
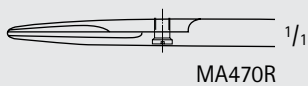

### STEVENS Tenotomy Scissors

Catalog Number	Tip	Blade	Handle	Weight	Length (in.)
MA470R	B/B	STR	RIBBON	LIGHT	3 3/4
MA468R	B/B	STR	RIBBON	HEAVY	3 7/8
MA469R	B/B	CVD	RIBBON	HEAVY	3 3/4

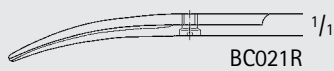
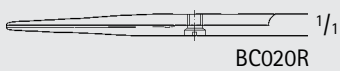
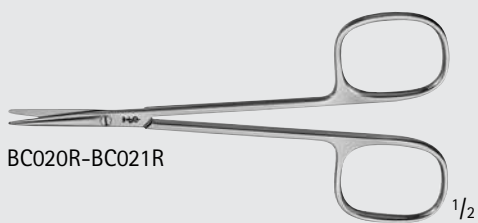

### Strabismus Scissors, Delicate

Catalog Number	Tip	Blade	Handle	Length (in.)
BC020R	B/B	STR	SQUARE	4 1/2
BC021R	B/B	CVD	SQUARE	4 1/2

ENT  
NASAL

MILLIMETERS

**DUROTIP Tungsten Carbide Scissors**

- Excellent cutting accuracy
- Long working life
- Gold-plated rings

**DUROTIP TC FOMON Dorsal Scissors**

Catalog Number	Tip	Blade Angle	Length (in.)
MB540R	B/B	30°	5 1/4

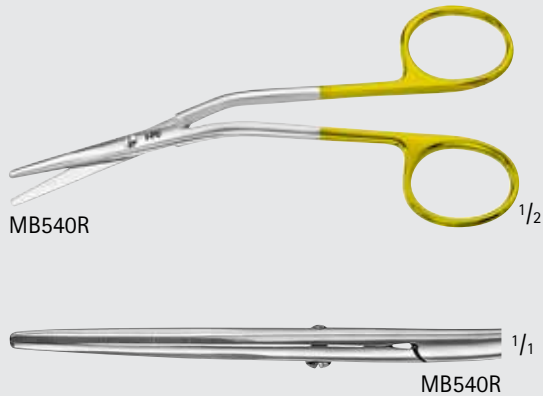

**DUROTIP TC Iris Scissors, Delicate**

Catalog Number	Tip	Blade	Length (in.)
BC210R	S/S	STR	4 1/4
BC211R	S/S	CVD	4 1/4

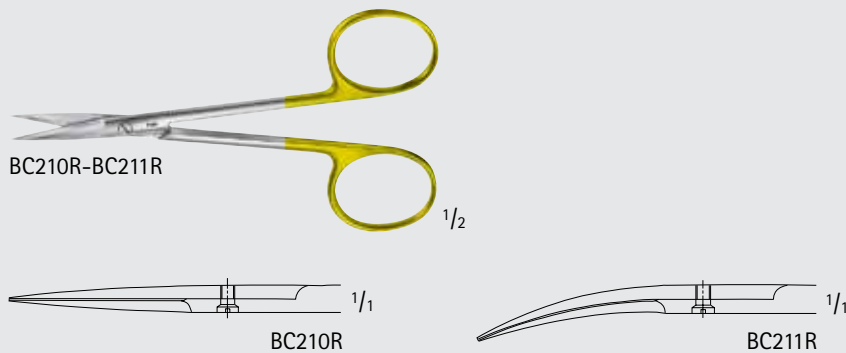

**Wavecut**

Wavecut scissors have one serrated cutting edge to prevent tissue from slipping.

The W after the catalog number indicates the scissors are the wavecut style, e.g. BC211W.

**DUROTIP TC Iris Scissors, Wavecut**

Catalog Number	Tip	Blade	Length (in.)
BC211W	S/S	CVD	4 1/4

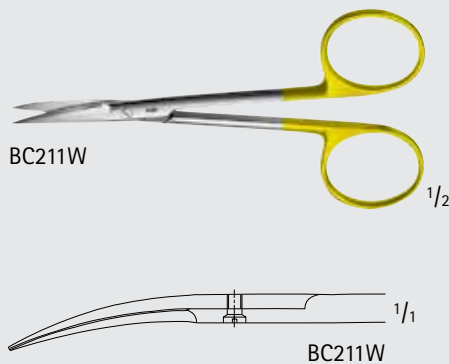

# ENT-NASAL

## DUROTIP™ TC Scissors

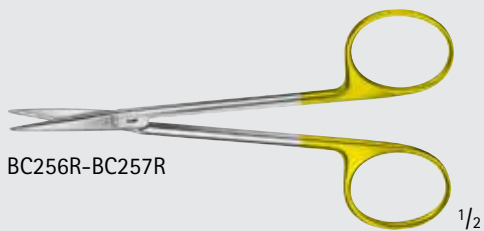

BC256R-BC257R

1/2

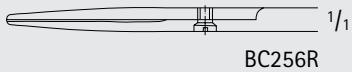

BC256R

1/16

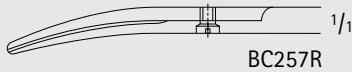

BC257R

1/16

### DUROTIP TC Strabismus Scissors, Delicate

Catalog Number	Tip	Blade	Length (in.)
BC256R	B/B	STR	4 1/2
BC257R	B/B	CVD	4 1/2

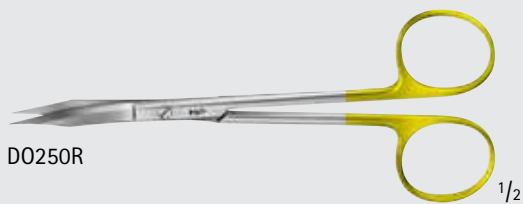

D0250R

1/2

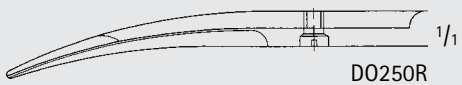

D0250R

1/16

### DUROTIP TC GOLDMAN-FOX Tenotomy Scissors, Delicate

Catalog Number	Tip	Blade	Length (in.)
D0250R	S/S	CVD, 1/SERR	5 1/8

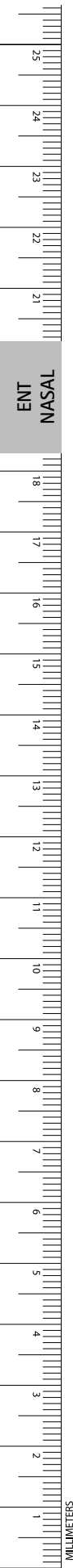

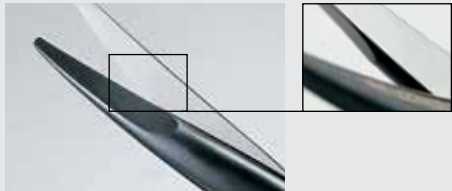

Microtome Edge

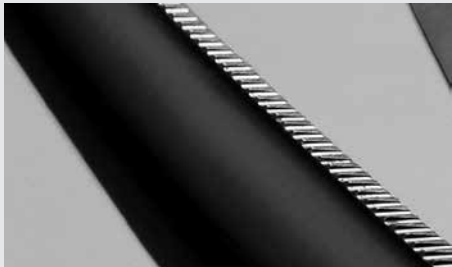

Wavecut

Noir Supreme Cut Scissors

- **Noir**  
The combination of the renowned Aesculap Tungsten Carbide technology with the Aesculap Noir coating results in an extremely high surface hardness and therefore high wear resistance in daily hospital use.
- **Microtome edge**  
The extremely sharp cutting edge of the scissors blade facilitates gentle cutting of tissue with minimal use of force.
- **Wavecut** helps prevent tissue from slipping out during the cutting process.
- The WB after the catalog number indicates the Noir scissors are the wavecut style, e.g. BC211WB.

For more information about Noir Supreme Cut Scissors see our brochure number DOC637.

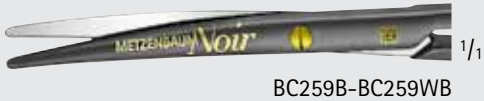

Noir Baby METZENBAUM Dissecting Scissors

Catalog Number	Tip	Blade	Length (in.)
BC259B	B/B	CVD	5 3/4
BC259WB	B/B	CVD	5 3/4



Noir Strabismus Dissecting Scissors

Catalog Number	Tip	Blade	Length (in.)
BC257B	B/B	CVD	4 1/2
BC257WB	B/B	CVD	4 1/2

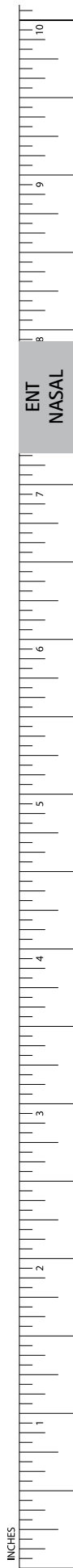

# ENT-NASAL

## SuperCut Scissors



BC904R, BC906R

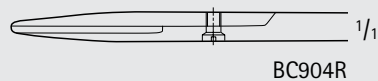

BC904R

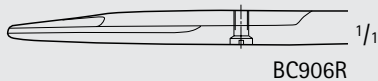

BC906R

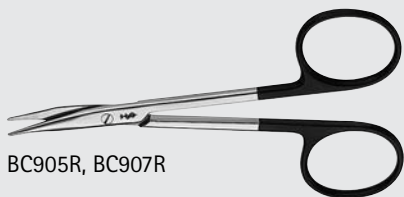

BC905R, BC907R

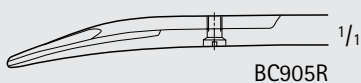

BC905R

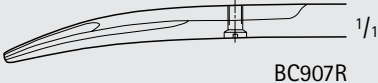

BC907R

### STEVENS SuperCut Scissors

Catalog Number	Tip	Tip Size (mm)	Blade	Length (in.)
BC904R	B/B	12	STR	4 1/8
BC906R	B/B	13	STR	4 1/4
BC905R	B/B	12	CVD	4 1/8
BC907R	B/B	13	CVD	4 1/4



BC939R

1/2



BC939R

1/1

### FOMON SuperCut Scissors

Catalog Number	Tip	Blade	Length (in.)
BC939R	B/B	CVD	4 1/2

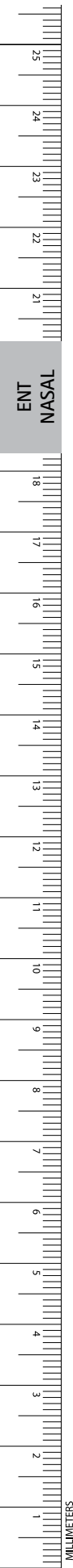

SF812R



1/2

**Septum Needle W/ Luer Lock, Attachment**

Catalog Number	Tip Size (mm)	Length (in.)
SF812R	DIAM. 0.8	3 1/2

MA553R, MA551R, MA552R

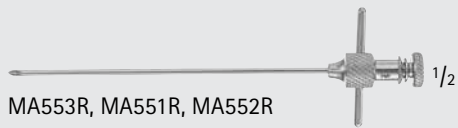

1/2

**Antrum Trocar Needle**

Catalog Number	Tip	Size	Length (in.)
MA553R	BEVELED STYLET	14 GA	4 1/4
MA551R	BEVELED STYLET	16 GA	4 1/4
MA552R	BEVELED STYLET	18 GA	4 1/4

MA553R, MA551R, MA552R

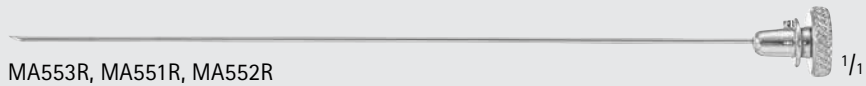

1/1

MA601R

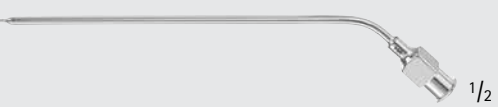

1/2

**Septum Needle**

Catalog Number	Tip	Size	Length (in.)
MA601R	ANG	22	5 3/8

MA554R



1/2

**COAKLEY Antrum Trocar, with Irrigation Extension**

Catalog Number	Length (in.)
MA554R	6 1/4

MA554R



1/1



# ENT-NASAL

## Trocars and Needles



### Sinoscopy Trocar and Cannula

Catalog Number	Tip Size (mm)	Length (in.)
MA597R	4	6 1/2
MA598R	5	6 1/2



### OCHSNER Trocar

Catalog Number	Tip Size (FR)	Length (in.)
MG100R	10	6
MG101R	12	6
MG102R	14	6
MG103R	16	6
MG104R	18	6
MG105R	20	6
MG106R	22	6
MG107R	24	6
MG108R	26	6
MG109R	27	6
MG110R	28	6

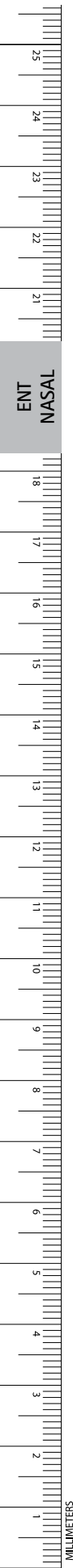

**BROWN Needle Holder, Heavy**

Catalog Number	Tip Size (mm)	Jaw	Length (in.)
MA362R	13	SERR	5 1/4

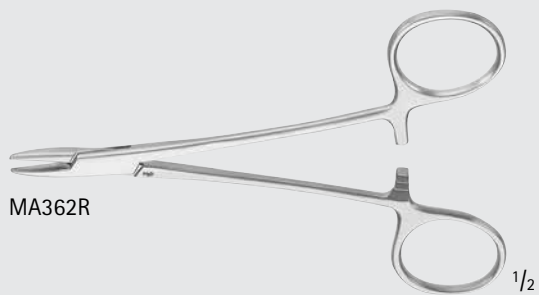

MA362R

1/2



MA362R

1/1

**SOFFERMAN Needle Holder**

Catalog Number	Tip Size (mm)	Jaw	Working Length (in.)
MA627R	5	STR, SERR	3 5/8

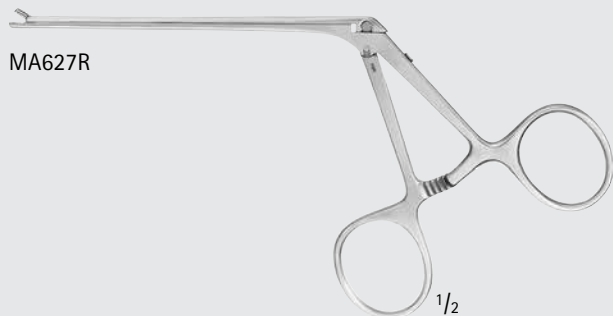

MA627R

1/2



MA627R

1/1

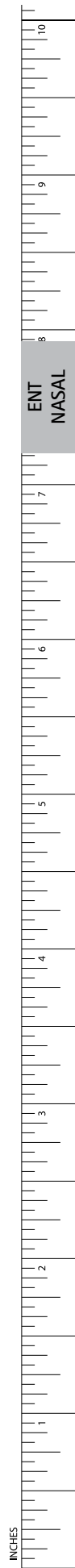

INCHES

# ENT-NASAL

## Forceps- Tissue/Dressing/Sponge



MA537R

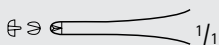

MA537R

### CALLISON-ADSON Tissue Forceps, W/ Platform

Catalog Number	Teeth	Length (in.)
MA537R	1 x 2	5



MA070R



BD879R-BD878R

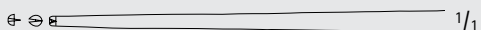

BD879R

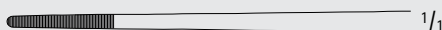

BD878R



MA331R



MA331R



MA070R

### LUCAE Bayonet Forceps

Catalog Number	Tip	Teeth	Length (in.)
BD879R	SMOOTH	1 x 2	5 1/2
BD878R	SERR	-	5 1/2
MA331R	SERR	-	6 3/8
MA070R	DEL, SERR	-	5 3/4



BD880R, MB236

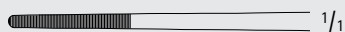

BD880R



MB236

### JANSEN Bayonet Forceps

Catalog Number	Tip	Length (in.)
BD880R	SERR	6 1/4
MB236	SERR	6 1/2

ENT  
NASAL

# ENT-NASAL

## Forceps- Tissue/Dressing/Sponge

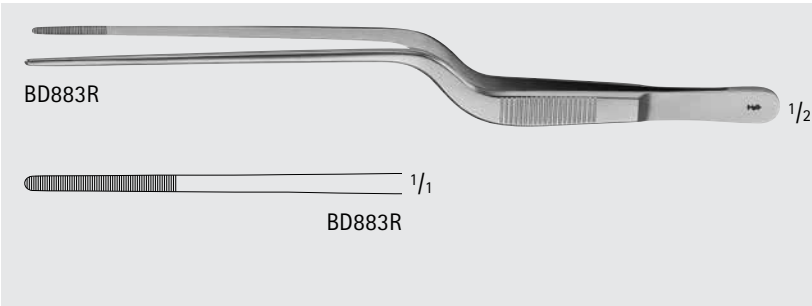

### GRUENWALD Bayonet Forceps

Catalog Number	Tip	Length (in.)
BD883R	SERR	7 7/8

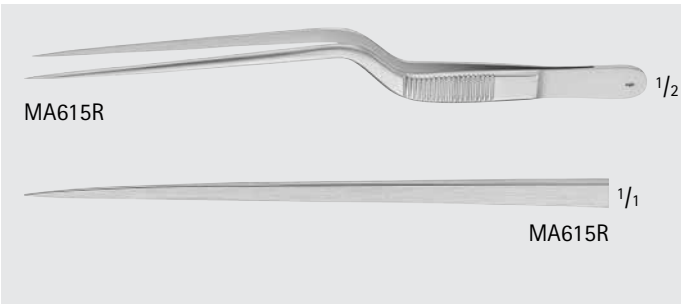

### JACOBSON Forceps

Catalog Number	Tip	Length (in.)
MA615R	SMOOTH, SHARP	6 1/4

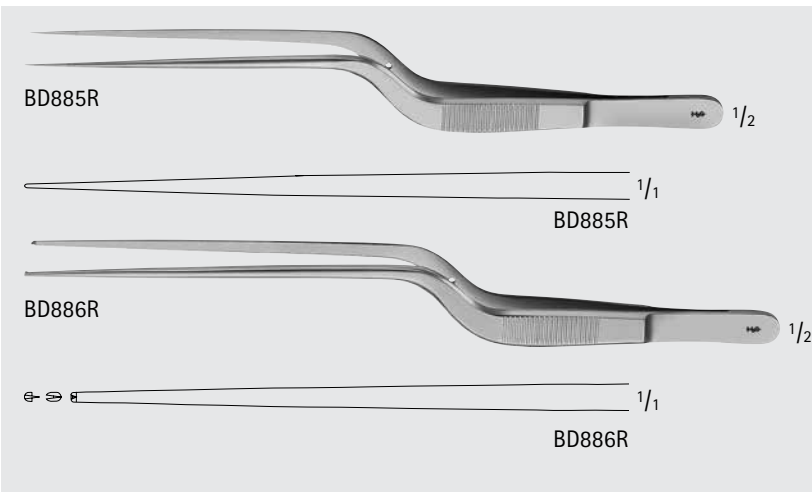

### Bayonet Forceps

Catalog Number	Tip	Teeth	Length (in.)
BD885R	SMOOTH	-	7 1/4
BD886R	SMOOTH	1 x 2	7 7/8

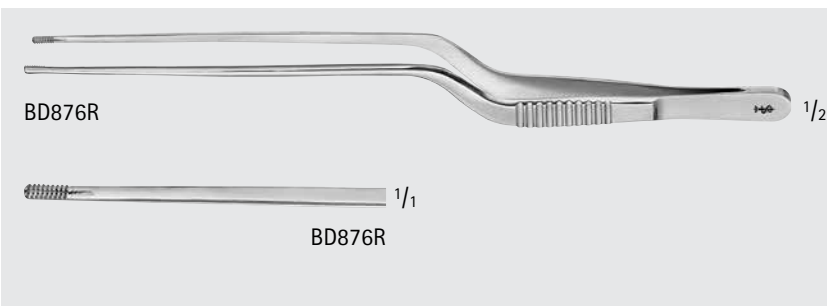

### BROWN-BAHNSON Bayonet Forceps

Catalog Number	Tip	Length (in.)
BD876R	SERR	6 1/8

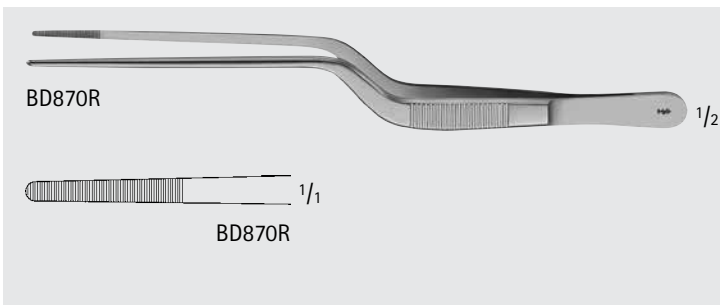

### ADSON Bayonet Forceps

Catalog Number	Tip	Length (in.)
BD870R	SERR	6 7/8



# ENT-NASAL

Forceps- Tissue/Dressing/Sponge



BD904R

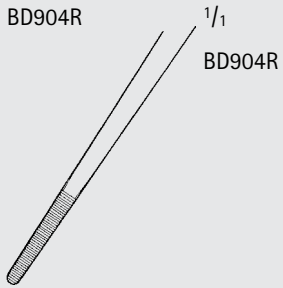

## WILDE Forceps

Catalog Number	Tip	Length (in.)
BD904R	ANG/SERR	4 1/2



BD900R-BD902R

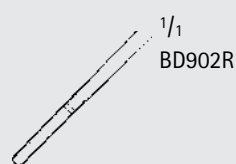
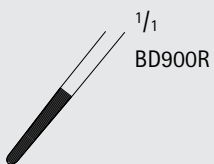

## TROELTSCH Bayonet Forceps

Catalog Number	Tip	Length (in.)
BD900R	ANG/SERR	4
BD902R	ANG/SERR	4 1/2
BD910R	ANG/SERR	5 1/2
BD911R	ANG/SERR	6 3/4



BD910R-BD911R

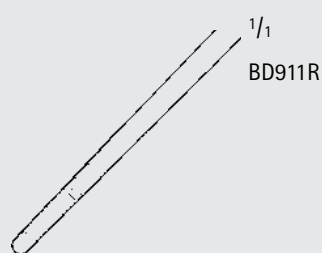
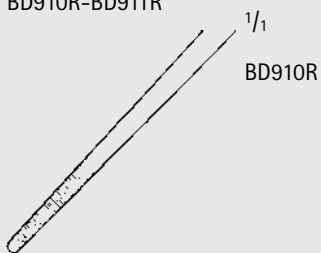

# ENT-NASAL

## Forceps- Tissue/Dressing/Sponge

### HARTMANN Alligator Forceps

Catalog Number	Tip	Length (in.)
OK245R	ANG/SERR	7 1/2

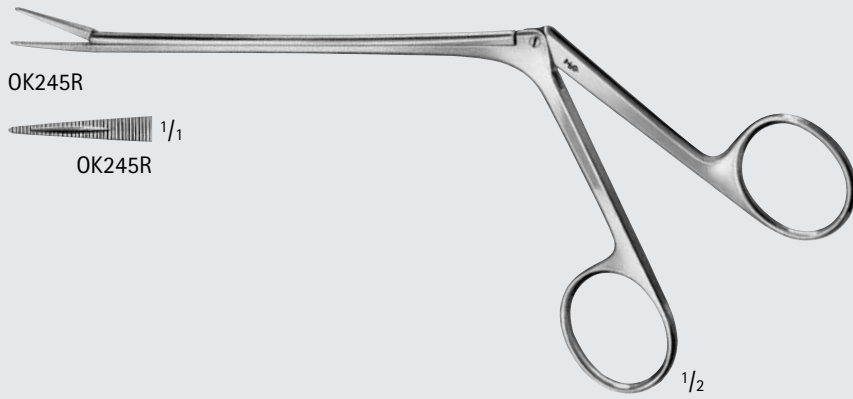

### HARTMANN Nasal Dressing Forceps

Catalog Number	Length (in.)
OK242R	6 7/8
MA329R	7
OK243R	7 7/8
MA330R	8 1/2

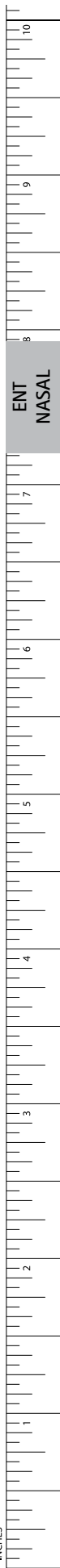
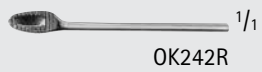

# ENT-NASAL

## Forceps- Tissue/Dressing/Sponge

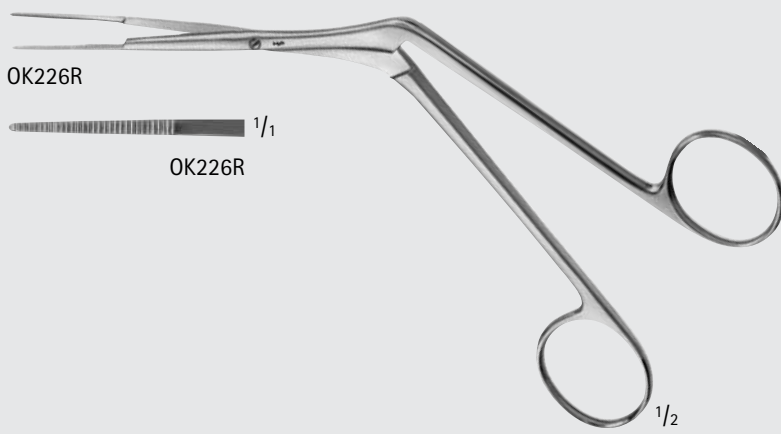

**WEST Nasal Dressing Forceps**

Catalog Number	Tip	Length (in.)
OK226R	SERR	7 7/8



OL010R

**COTTLE Columella Clamp, W/ Fixation Screw**

Catalog Number	Length (in.)
OL010R	4

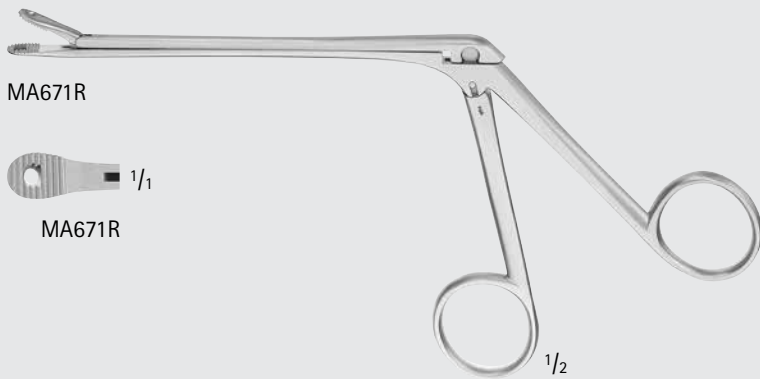

**FERRIS-SMITH Fragment Forceps**

Catalog Number	Tip Size (mm)	Working Length (in.)	Length (in.)
MA671R	8.2 x 6	4 1/4	7 7/8

ENT  
NASAL

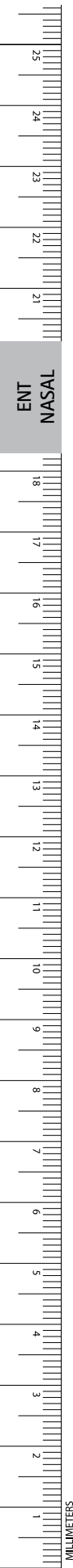

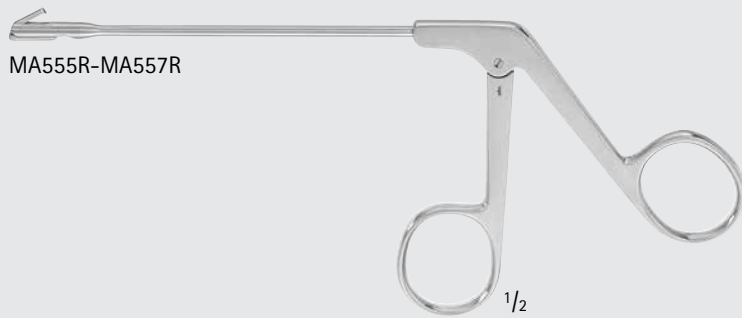

**OSTRUM Antrum Backbiting Punch Forceps**

Catalog Number	Jaw Size (mm)	Jaw	Working Length (in.)	Length (in.)
MA555R	3 x 7	STR	4 1/4	7 3/4
MA556R	3 x 7	ANG-LEFT	4 1/4	7 3/4
MA557R	3 x 7	ANG-RIGHT	4 1/4	7 3/4



MA555R



MA556R



MA557R



OK440R-OK443R

**BRUENINGS Septum Forceps**

Catalog Number	Size	Length (in.)
OK440R	SMALL	7 1/2
OK441R	MEDIUM	7 1/2
OK442R	LARGE	7 1/2
OK443R	X-LARGE	7 1/2



OK440R



OK442R

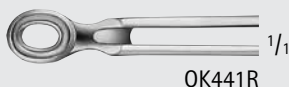

OK441R



OK443R

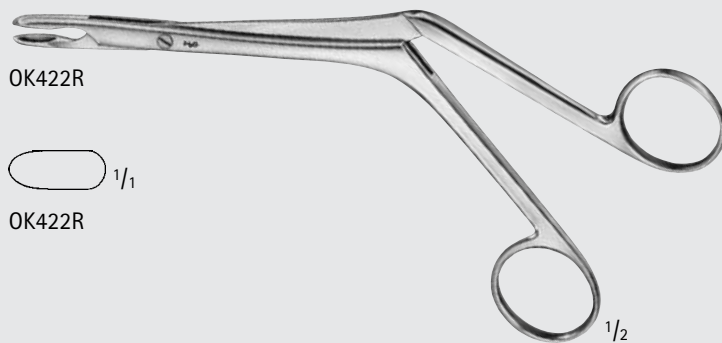

OK422R

**HEYMANN-KNIGHT Septum Forceps**

Catalog Number	Jaw	Length (in.)
OK422R	OVAL	7 1/2

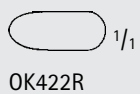

OK422R

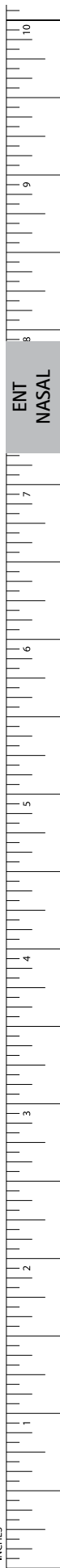

# ENT-NASAL

Forceps- Nasal/Polyp/Bone Cutting

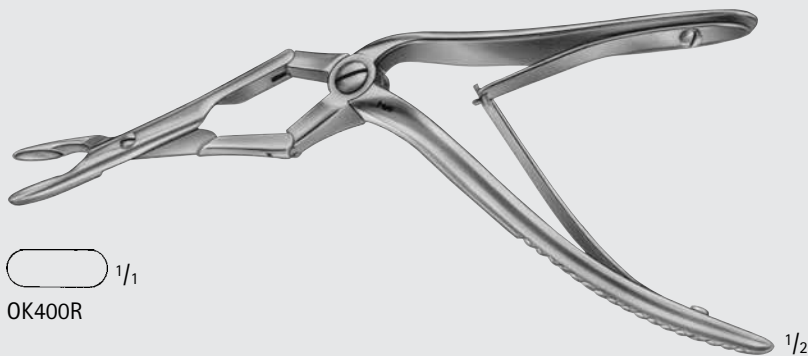

OK400R 1/1

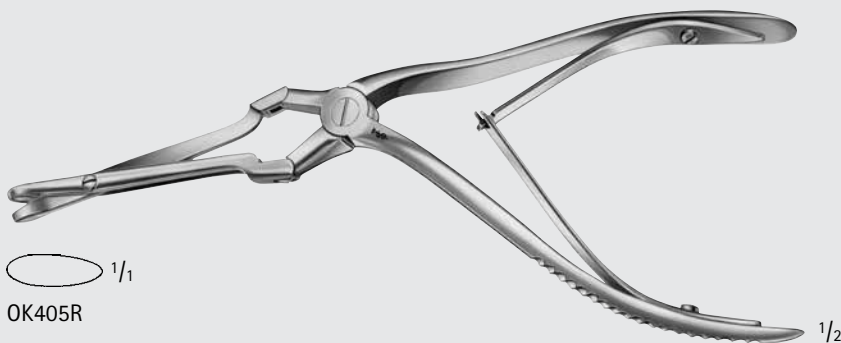

OK405R 1/1

## JANSEN-MIDDLETON Septum Forceps

Catalog Number	Jaw	Length (in.)
OK400R	SPOON	7 7/8
OK405R	THRU-CUT	8 1/4

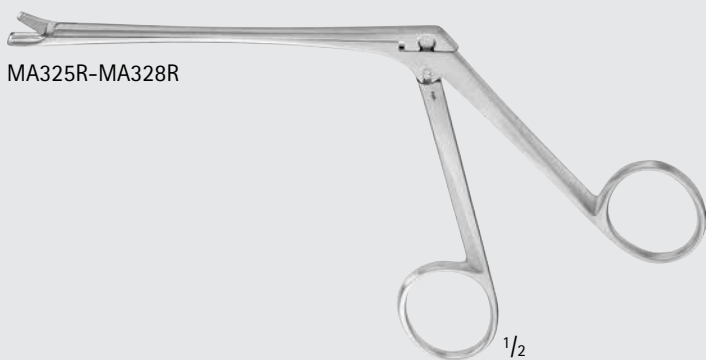

MA325R-MA328R



MA325R 1/1



MA327R 1/1



MA326R 1/1



MA328R 1/1

## GRUENWALD Nasal Forceps

Catalog Number	Tip Size (mm)	Tip Size (#)	Working Length (in.)	Length (in.)
MA325R	2.5 x 9	1	4	7 1/4
MA326R	3 x 10	2	4	7 1/4
MA327R	3.5 x 11	3	4	7 1/4
MA328R	3.5 x 10	3	4	7 1/4







OK612R-OK613R

**GRUENWALD-HENKE Nasal Thru-Cut Rongeur**

Catalog Number	Jaw	Working Length (in.)
OK612R	SMALL	4 3/4
OK613R	LARGE	4 3/4



 1/1  
OK612R

 1/1  
OK613R

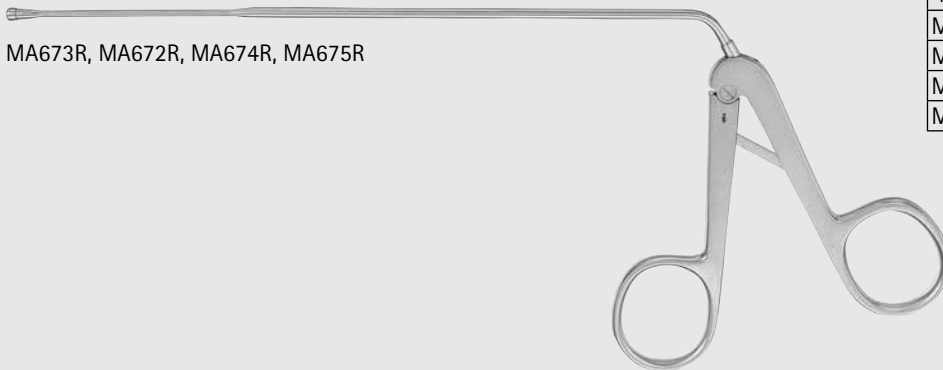

MA673R, MA672R, MA674R, MA675R

**STAMMBERGER Circular Punch Forceps**

Catalog Number	Tip	Tip Size (mm)	Working Length (in.)	Length (in.)
MA673R	STR	3.5	7 1/2	9 3/4
MA672R	STR	4.5	7 1/2	9 3/4
MA674R	70° UP	3.5	7 1/4	9 5/8
MA675R	70° UP	4.5	7 1/4	10 1/4

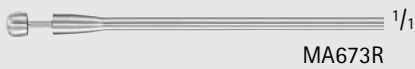

MA673R



MA674R

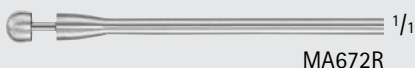

MA672R



MA675R

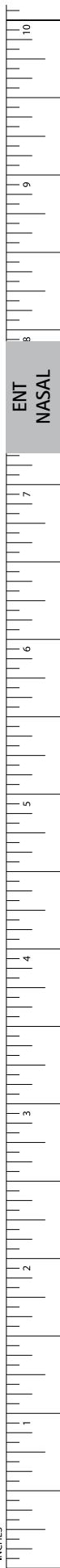

# ENT-NASAL

## Forceps- Nasal/Polyp/Bone Cutting

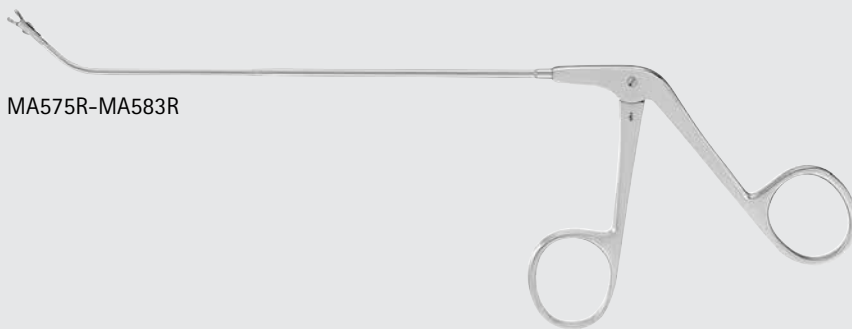
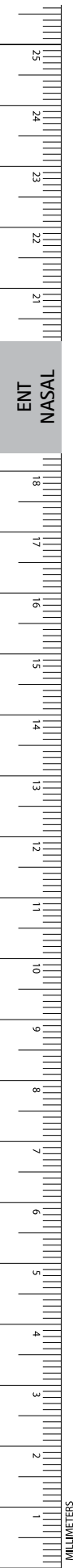

MA575R-MA583R



MA575R, MA577R  $\frac{1}{1}$



MA576R, MA580R  $\frac{1}{1}$

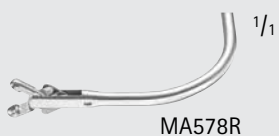

MA578R  $\frac{1}{1}$



MA579R  $\frac{1}{1}$



MA582R  $\frac{1}{1}$



MA581R, MA583R  $\frac{1}{1}$

### Giraffe Frontal Sinus Forceps

Catalog Number	Jaw	Cup Size (mm)	Working Length (in.)	Length (in.)
MA575R	ANG 45° VERTICAL CUTTING	2	5 1/2	8 7/8
MA576R	ANG 45° HORIZONTAL CUTTING	2	5 1/2	8 7/8
MA577R	ANG 90° VERTICAL CUTTING	2	5 1/8	8 3/8
MA578R	ANG 90° HORIZONTAL CUTTING	2	5 1/8	8 3/8
MA579R	ANG 45° VERTICAL CUTTING	3	5 1/2	8 7/8
MA581R	ANG 70° VERTICAL CUTTING DOUBLE ACTION	3	5 1/8	8 1/4
MA580R	ANG 90° HORIZONTAL CUTTING	3	5 1/2	8 7/8
MA582R	ANG 70° HORIZONTAL CUTTING DOUBLE ACTION	4	5 1/8	8 1/4
MA583R	ANG 100° HORIZONTAL CUTTING DOUBLE ACTION	4	4 5/8	8 1/4

Giraffe Thru-Cut Sinus Forceps

Catalog Number	Jaw	Cup Size (mm)	Working Length (in.)
MA584R	ANG 70° VERTICAL CUTTING	3 x 6	4 3/4

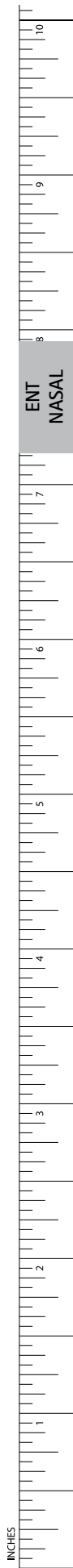
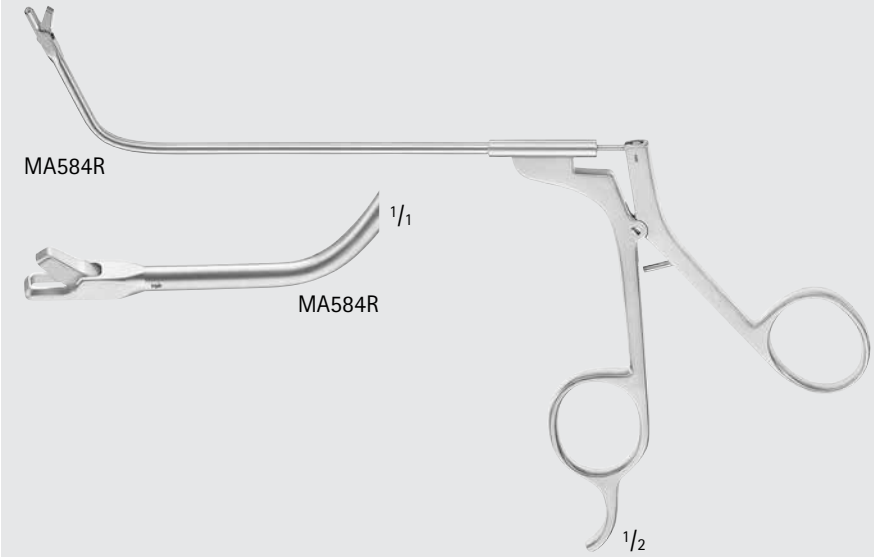

# ENT-NASAL

Forceps- Nasal/Polyp/Bone Cutting

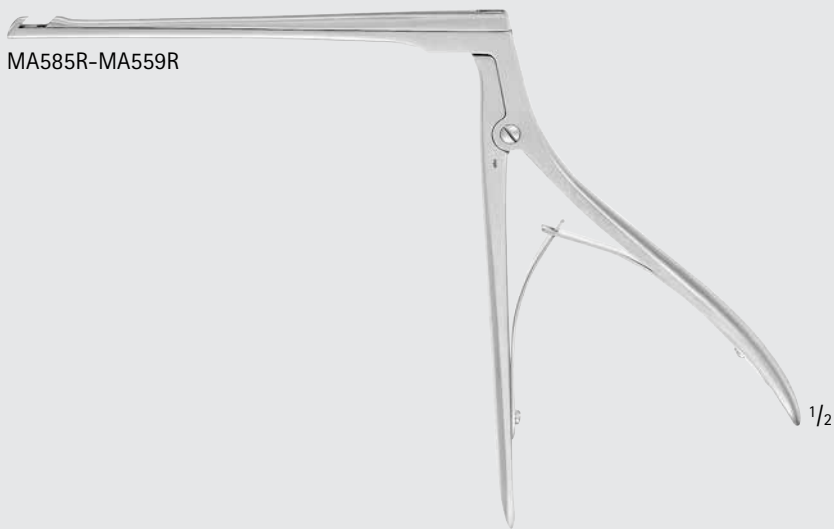

MA585R-MA559R



MA585R



MA559R

## Antrum Punch Forceps

Catalog Number	Jaw	Tip	Cup Size (mm)	Working Length (in.)	Length (in.)
MA585R	ANG 45° BACKWARD 3 MM	3	4 x 5	5 1/2	8 1/4
MA559R	45° FORWARD 3 MM	3	4 x 5	5 1/2	8 1/4

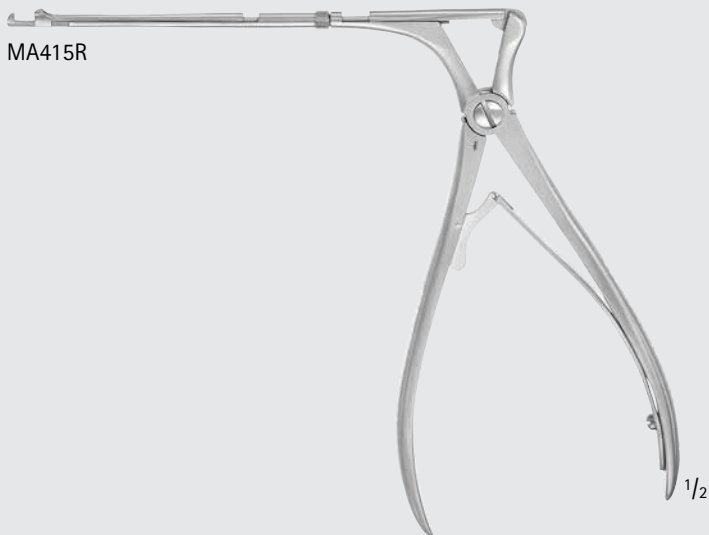

MA415R



MA415R

## MCKENTY Sphenoid Punch Forceps, Rotatable

Catalog Number	Jaw	Working Length (in.)	Length (in.)
MA415R	1.5 x 4	5 3/4	7

# ENT-NASAL

## Forceps- Nasal/Polyp/Bone Cutting



### KERRISON Nasal Rongeur

Catalog Number	Jaw Size (mm)	Jaw	Working Length (in.)
OK711R	4.0	90° UP	3 1/4
OK712R	5.0	90° UP	3 3/8

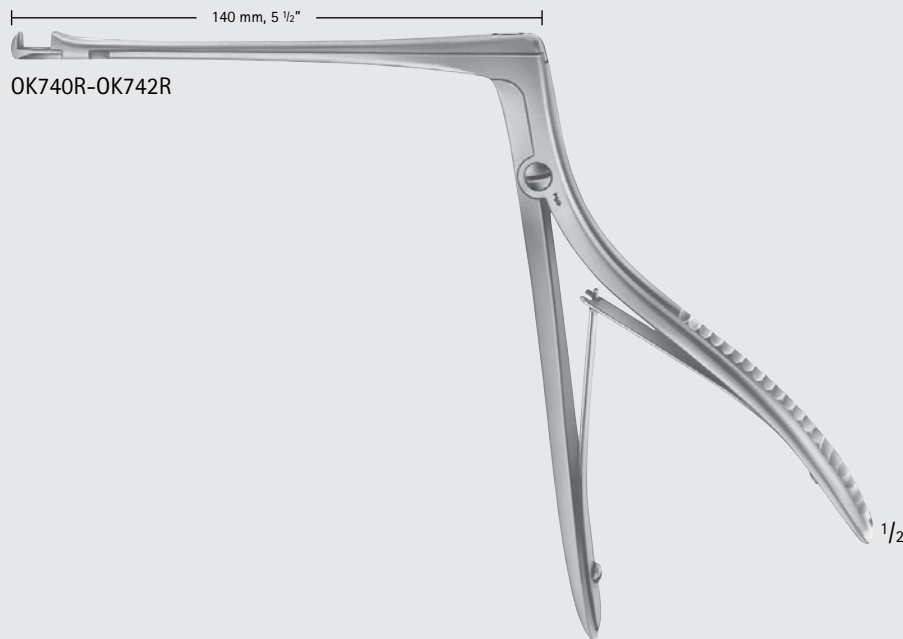
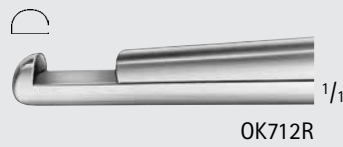
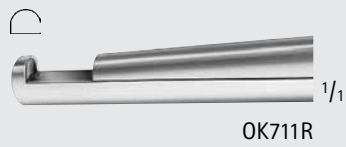

### HAJEK-KOFLER Punch

Catalog Number	Jaw Size (mm)	Jaw	Working Length (in.)
OK740R	3.3	90° UP	5 1/2
OK741R	3.3	90° DOWN	5 1/2
OK742R	4.0	90° UP	5 1/2

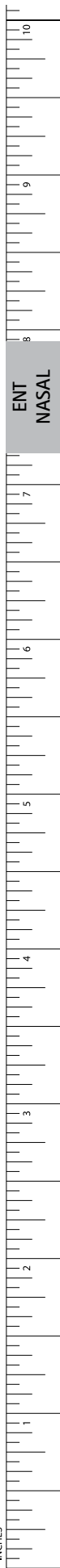
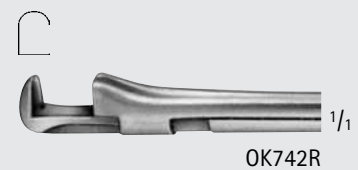
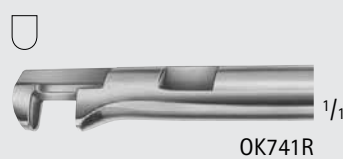

# ENT-NASAL

Forceps- Nasal/Polyp/Bone Cutting



**HAJEK-KOFLER Rotatable Punch, (continued)**

Catalog Number	Jaw Size (mm)	Jaw	Working Length (in.)
OK745R	4.0	90° UP	6 3/4

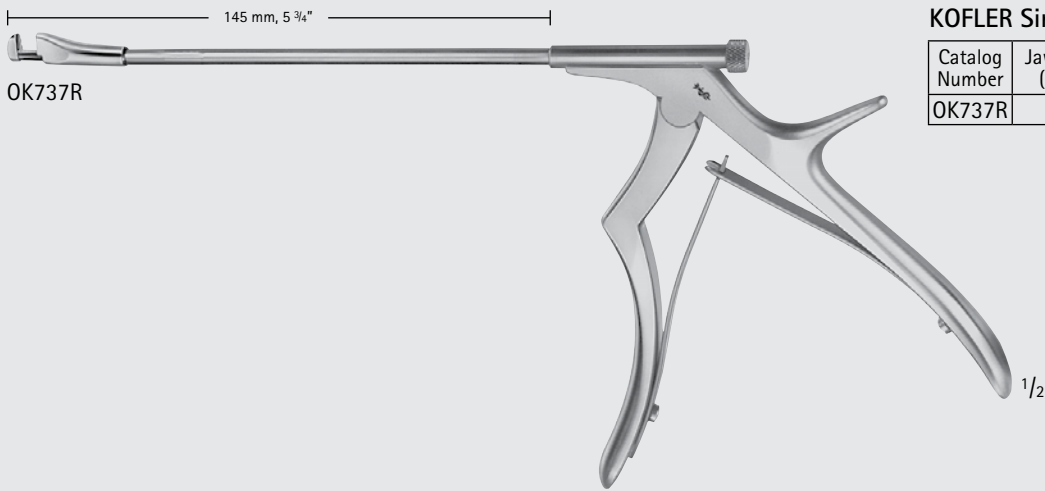
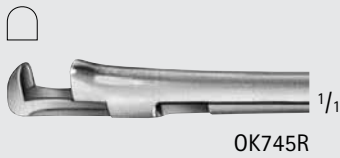

**KOFLER Sinus Punch, Rotatable**

Catalog Number	Jaw Size (mm)	Jaw	Working Length (in.)
OK737R	3.0	90° UP	5 3/4

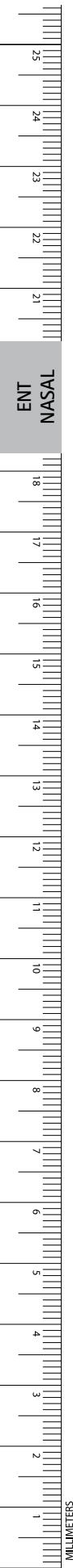



MA340R-MA343R, OK525R-OK526R

TAKAHASHI Nasal Forceps

Catalog Number	Jaw Size (mm)	Jaw	Working Length (in.)
MA342R	2.5	STR	4 3/8
OK525R	3.0	STR	4 3/4
MA340R	3.0	STR	6 3/8
MA343R	4.0	STR	4 3/8
MA341R	4.0	STR	6 3/8
OK526R	3.0	45° UP	4 3/4

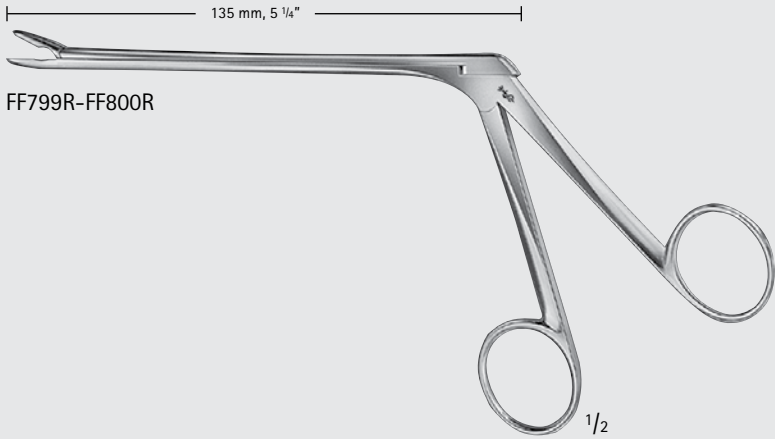
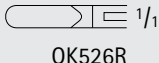
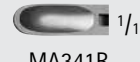
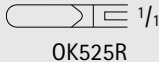
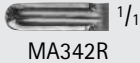

FF799R-FF800R

LOVE-GRUENWALD Rongeur

Catalog Number	Jaw Size (mm)	Jaw	Working Length (in.)
FF799R	2 x 10	STR	5 1/4
FF800R	3 x 10	STR	5 1/4

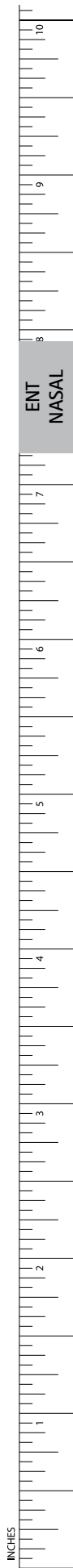
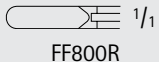
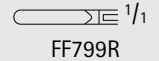

# ENT-NASAL

Forceps- Nasal/Polyp/Bone Cutting

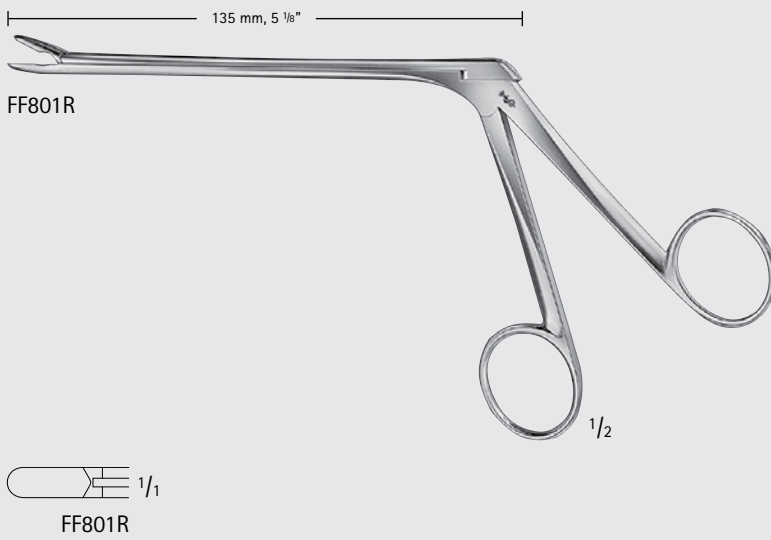

## SPURLING Rongeur

Catalog Number	Jaw Size (mm)	Jaw	Working Length (in.)
FF801R	4 x 10	STR	5 1/8

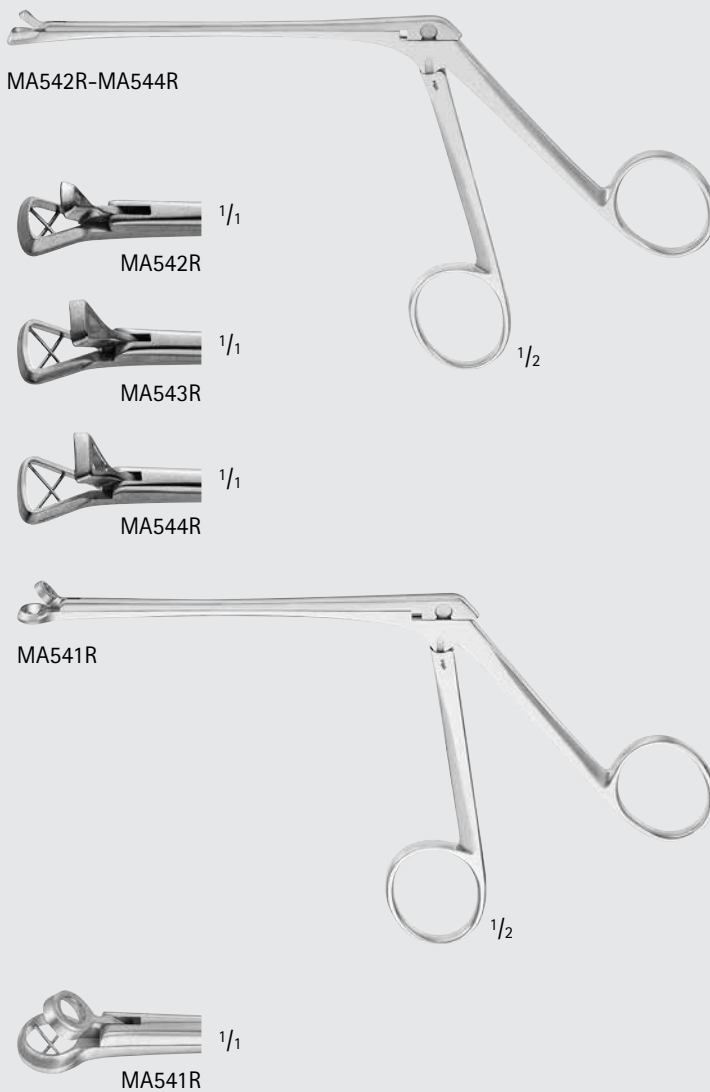

## MELTZER Adenoid Punch Forceps

Catalog Number	Tip Size (mm)	Size (#)	Jaw	Working Length (in.)	Length (in.)
MA542R	5 MM BOTTOM BASKET, 4 MM UPPER JAW	0	TRIANGULAR	4 1/2	7 1/4
MA543R	7 MM BOTTOM BASKET, 3 MM UPPER JAW	1	TRIANGULAR	4 1/2	7 1/4
MA544R	9 MM BOTTOM BASKET, 8 MM UPPER JAW	2	TRIANGULAR	4 1/2	7 1/4
MA541R	6 MM BOTTOM BASKET, 5 MM UPPER BITE	1	ROUND	4 1/2	7 1/4

ENT  
NASAL

MILLIMETERS

Nasal Biopsy Forceps

Catalog Number	Cup Size (mm)	Tip	Working Length (in.)	Length (in.)
MA676R	2.5 x 4	STR	5	7
MA680R	2.5 x 5	70° UP	4	7
MA678R	2.5 x 6	70° UP	3 1/2	7 1/4

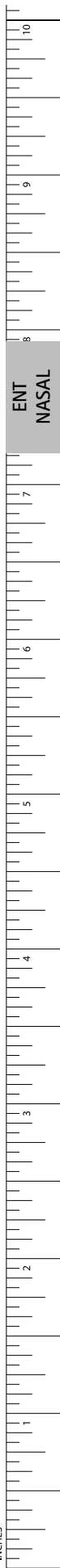
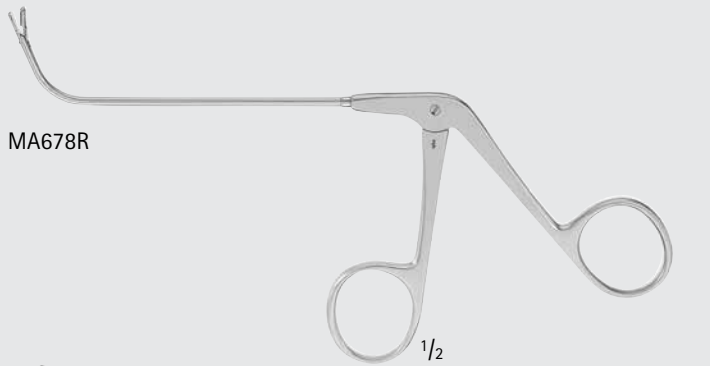
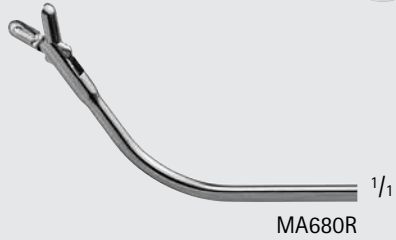
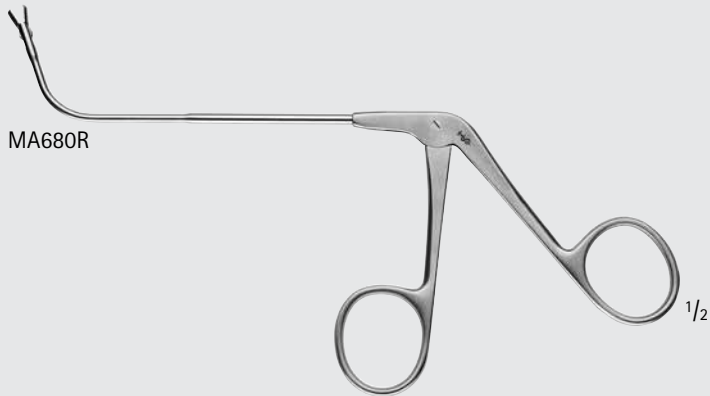

# ENT-NASAL

## Forceps- Nasal/Polyp/Bone Cutting

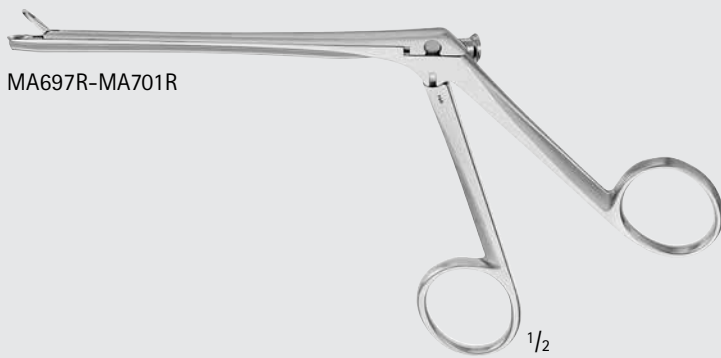

Nasal Suction Forceps

Catalog Number	Jaw Length (mm)	Tip	Tip Size (#)	Working Length (in.)	Length (in.)
MA697R	2.5	STR	00	4	7 1/4
MA699R	3.5	STR	0	4	7 1/4
MA701R	4.5	STR	1	4	7 1/4
MA698R	2.5	45° ANG-UP	00	4 3/4	7 1/4
MA700R	3.5	45° ANG-UP	0	4 1/2	7 3/4



ENT  
NASAL





MA570R-MA572R



MA570R



MA571R



MA572R

Pediatric Ostrum Antrum Punch Forceps

Catalog Number	Jaw Size (mm)	Jaw	Working Length (in.)	Length (in.)
MA570R	1.5 x 4	STR BACK BITE	4 1/2	8
MA571R	1.5 x 4	RIGHT SIDE BITE	4 1/2	8
MA572R	1.5 x 4	LEFT SIDE BITE	4 1/2	8

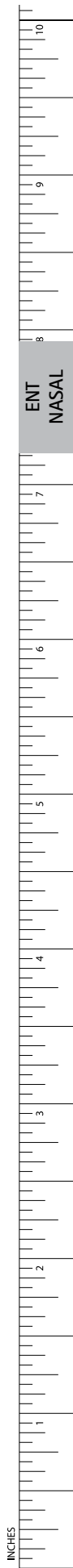

INCHES

# ENT-NASAL

## Forceps- Nasal/Polyp/Bone Cutting

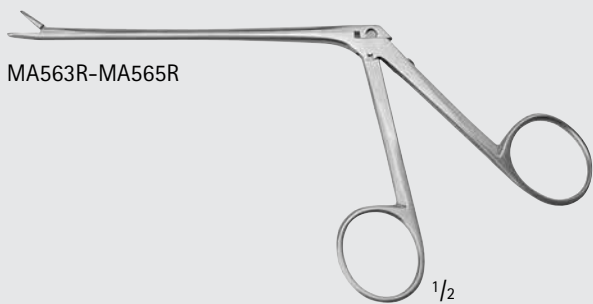

MA563R-MA565R



MA563R



MA564R



MA565R

### Ethmoid Forceps, Pediatric

Catalog Number	Jaw Size (mm)	Jaw	Working Length (in.)	Length (in.)
MA563R	3 x 5	STR	4	6 1/8
MA564R	3 x 5	ANG UP 45°	4	6 1/8
MA565R	3 x 5	ANG UP 90°	3 3/4	6 1/8

### Rotating Ostrum Antrum Punch Forceps, Backbiting

Catalog Number	Jaw Size (mm)	Size	Jaw	Working Length (in.)	Length (in.)
MA574R	1.5 x 4	Pediatric	ROTATING 360°	4 1/4	8 1/4
MA573R	3 x 7	Adult	ROTATING 360°	4 1/4	8 1/4

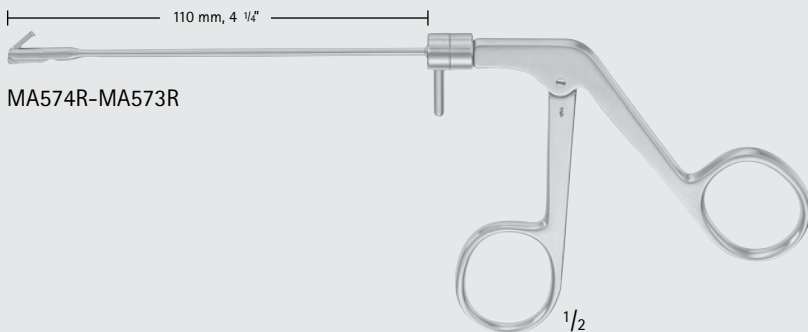

MA574R-MA573R



MA574R



MA573R

ENT  
NASAL

MILLIMETERS

RONIS Adenoid Nasal Forceps

Catalog Number	Tip Size (mm)	Tip Size (#)	Jaw	Working Length (in.)	Length (in.)
MA545R	7 MM BASKET	1	TRIANGULAR	5 3/8	8 1/8
MA546R	8 MM BASKET	2	TRIANGULAR	5 3/8	8 1/8

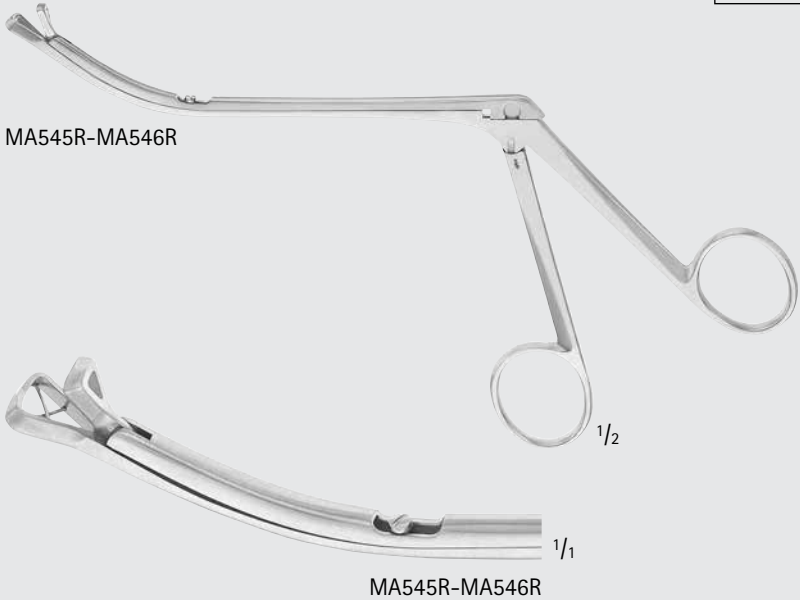

STAMMBERGER Sidecutting Antrum Punch Forceps

Catalog Number	Jaw	Length (in.)
MA568R	LEFT CUT	8 5/8
MA569R	RIGHT CUT	8 5/8

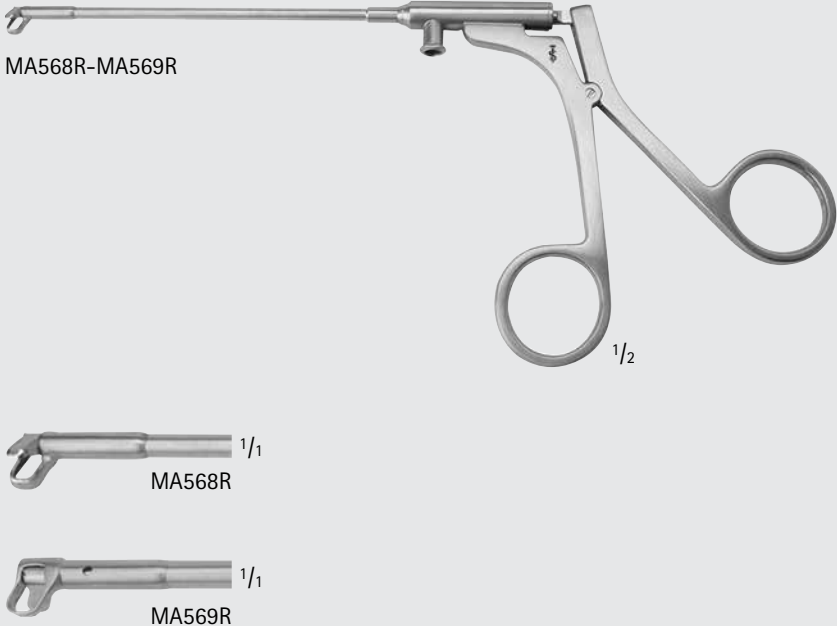

# ENT-NASAL

## Forceps- Nasal/Polyp/Bone Cutting

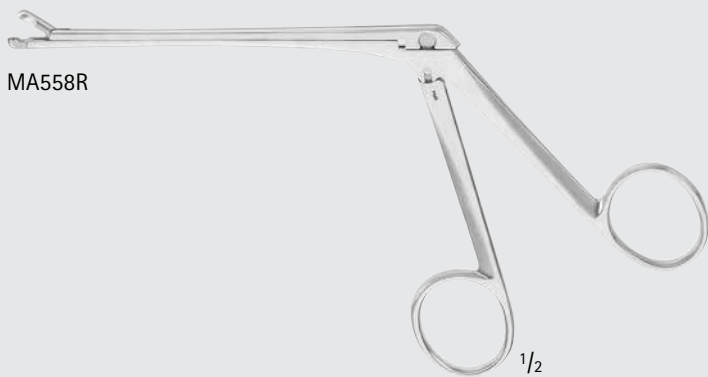

MA558R

### Sinus Cup Forceps

Catalog Number	Cup Size (mm)	Working Length (in.)	Length (in.)
MA558R	3	4 1/2	7



MA558R

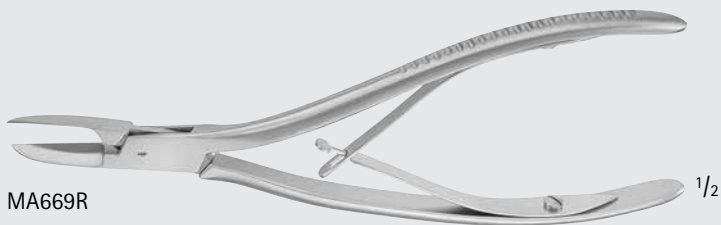

MA669R

### COTTLE Biting Forceps

Catalog Number	Jaw Length (mm)	Jaw	Length (in.)
MA669R	30	ANG	7



MA669R

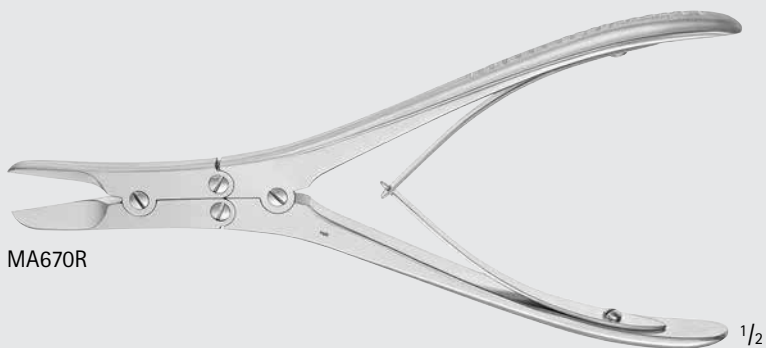

MA670R

### ROWLAND Bone Cutting Forceps, Double Action

Catalog Number	Jaw Length (mm)	Length (in.)
MA670R	25	7 1/4

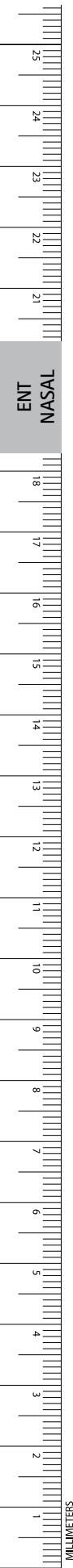

STAMM Bone Cutting Ronguer

Catalog Number	Length (in.)
F0604R	6



F0604R



F0604R



# ENT-NASAL

## Forceps- Nasal/Polyp/Bone Cutting

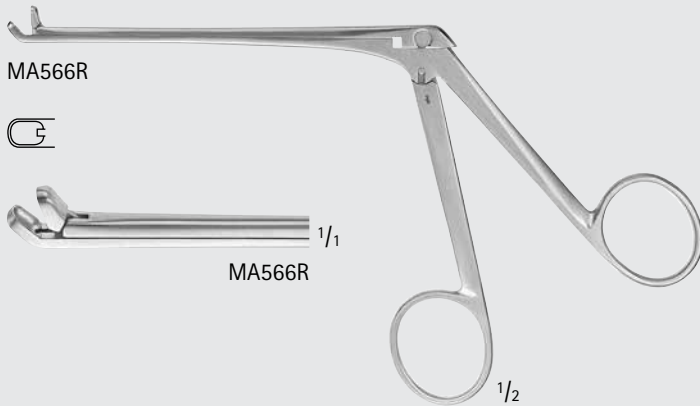

**STUEMPEL-VOSS Nasal Forceps**

Catalog Number	Cup (mm)	Tip	Working Length (in.)	Length (in.)
MA566R	3 x 5	ANG UP	4 1/4	6 7/8

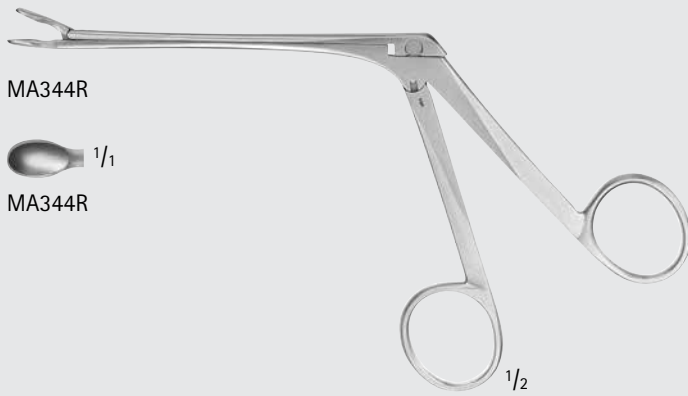

**WEIL Nasal Forceps**

Catalog Number	Cup (mm)	Tip	Working Length (in.)	Length (in.)
MA344R	5 x 8	STR	4	7 1/8
MA345R	5 x 8	ANG UP	4	7 1/8

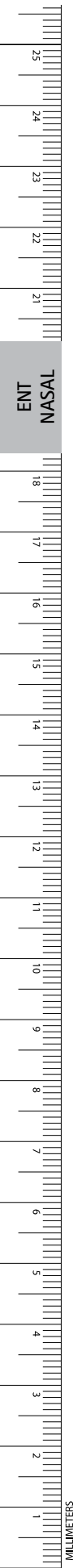
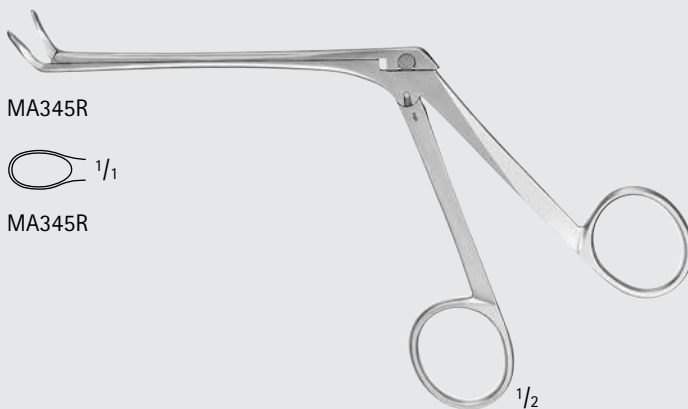

120 mm, 4 3/4"

OK505R-OK509R



110 mm, 4 1/4"

OK520R-OK522R

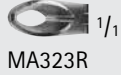
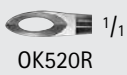
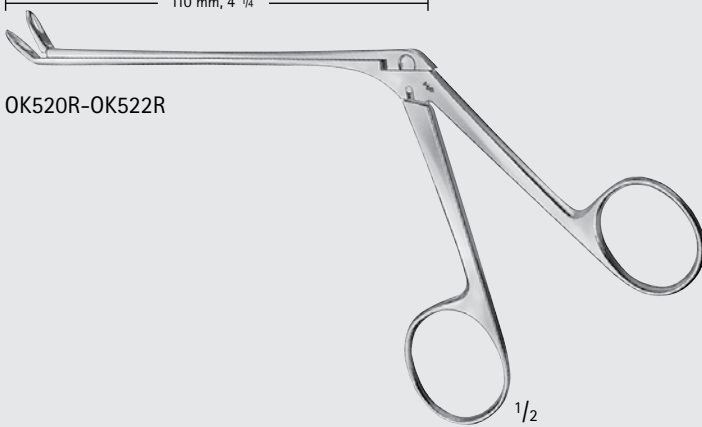

MA324R

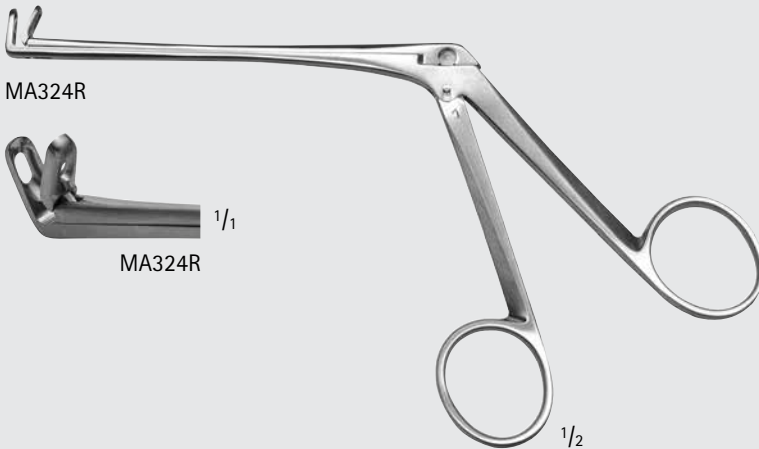

WEIL-BLAKESLEY Nasal Forceps

Catalog Number	Jaw Size (mm)	Tip	Tip Size (#)	Working Length (in.)
OK505R	3.0	STR	0	4 3/4
MA320R	3.5	STR	0	4
OK506R	3.6	STR	0	4 3/4
MA321R	4	STR	1	4 1/2
OK507R	4.2	STR	1	4 3/4
OK508R	4.8	STR	2	4 3/4
MA322R	5	STR	2	4 1/2
OK509R	5.6	STR	3	4 3/4
OK520R	3.6	ANG 45° UP	0	4 1/2
MA323R	4	ANG 45° UP	1	4 1/8
OK521R	4.2	ANG 45° UP	1	4 1/2
OK522R	4.8	ANG 45° UP	2	4 1/2
MA324R	4	ANG 90° UP	1	4

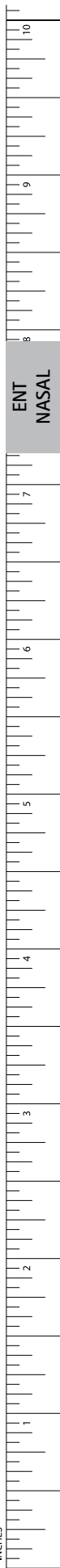

# ENT-NASAL

Forceps- Nasal/Polyp/Bone Cutting



**BLAKESLEY Thru-Cut Forceps**

Catalog Number	Size	Jaw Size (mm)	Tip	Jaw Size (#)	Working Length (in.)	Length (in.)
MA694R	PEDIATRIC	2.5	STR	00	4 1/4	7
MA695R	PEDIATRIC	2.5	ANG	00	4 1/4	7
MA684R	-	3.5	STR	0	4 1/2	7 3/4
MA686R	-	2.5	ANG UP	00	4 3/8	7 1/4

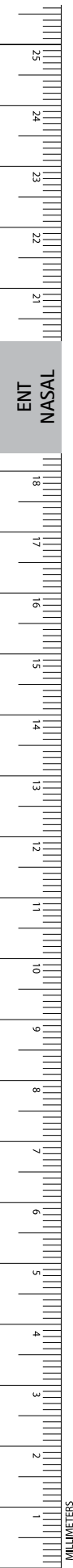
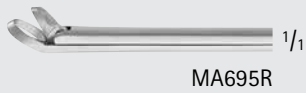
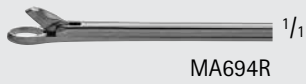

BLAKESLEY-WILDE Nasal Forceps

Catalog Number	Jaw Size (mm)	Tip	Working Length (in.)
OK544R	10 x 3.5	ANG 90° UP	4 1/4
OK545R	13.5 x 3.8	ANG 90° UP	4 1/4
OK546R	14.3 x 5	ANG 90° UP	4 1/4

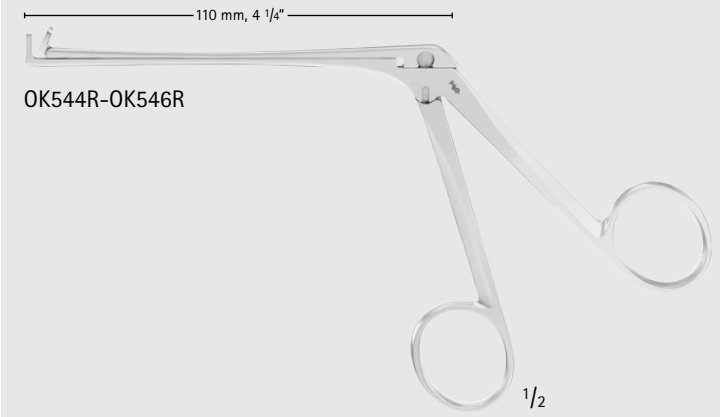

OK544R-OK546R

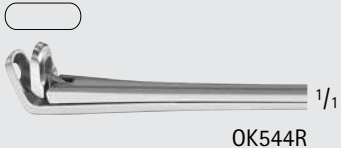

OK544R

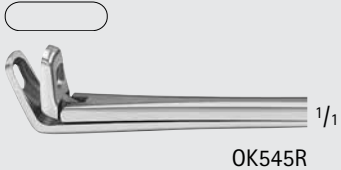

OK545R

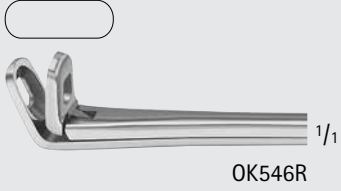

OK546R

WILDE Ethmoid Nasal Forceps

Catalog Number	Jaw Size (mm)	Tip	Jaw Size (#)	Working Length (in.)
MA567R	3.5 x 12	ANG UP 45°	0	4 3/8



MA567R



MA567R

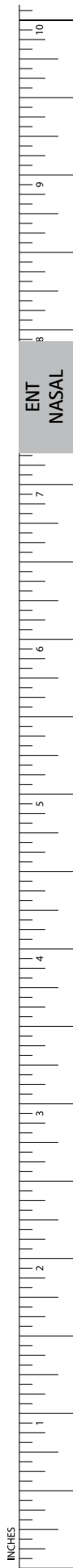

ENT NASAL

INCHES

# ENT-NASAL

Forceps- Nasal/Polyp/Bone Cutting

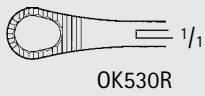
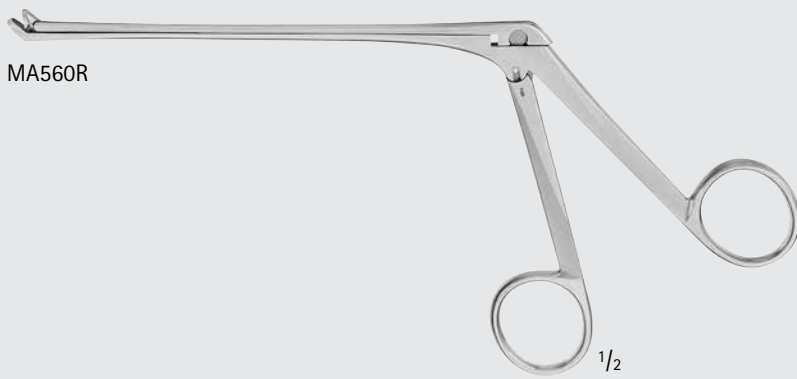

## WATSON-WILLIAMS Ethmoid Forceps

Catalog Number	Jaw	Tip	Working Length (in.)
MA560R	3 MM THRU CUT JAWS W/ BASKET, ANG UP	ANG UP	5 3/8
OK530R	STR, SERR	STR	4 3/4

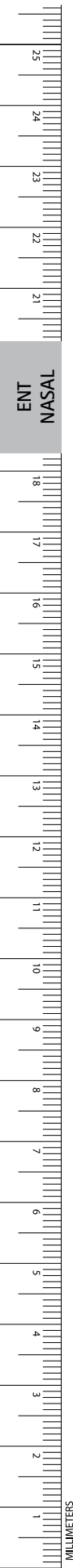

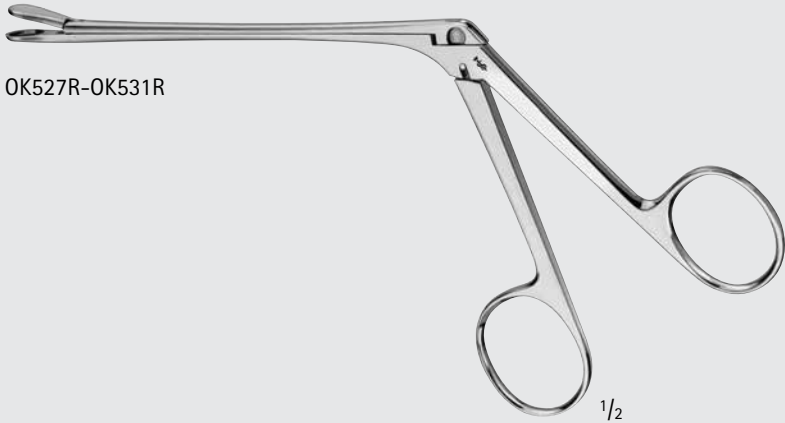

OK527R-OK531R

WATSON-WILLIAMS Ethmoid Forceps

Catalog Number	Jaw Size (mm)	Tip	Size	Working Length (in.)
OK527R	5.0	STR	SMALL	4 3/4
OK529R	7.0	STR	MEDIUM	4 3/4
OK531R	9.0	STR	LARGE	4 3/4

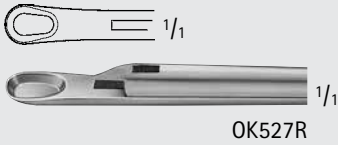

OK527R

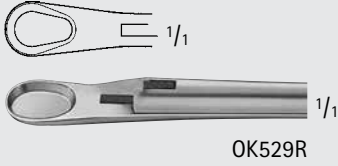

OK529R

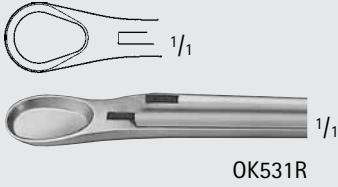

OK531R



# ENT-NASAL

Forceps- Nasal/Polyp/Bone Cutting



MA561R

MA561R

## WILDE Nasal Forceps

Catalog Number	Jaw Size (mm)	Tip	Working Length (in.)	Length (in.)
MA561R	5 x 10	STR	4 1/2	7 1/4
MA562R	5 x 10	ANG UP	4 1/2	7 1/4

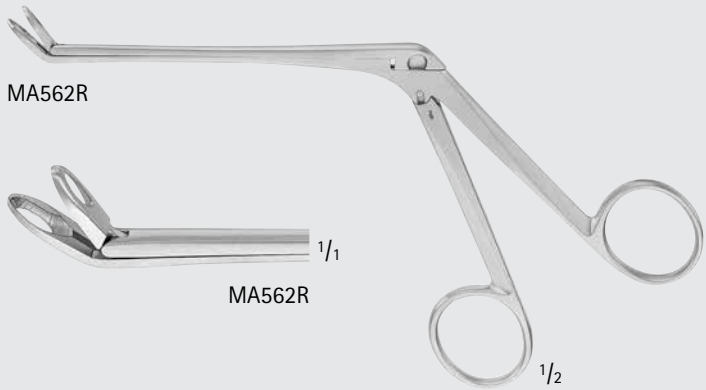

MA562R

MA562R

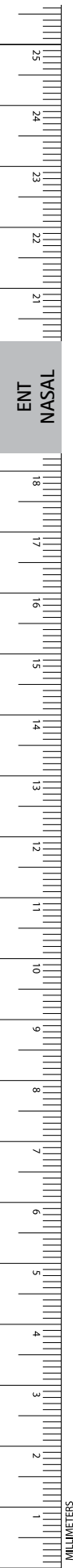

# ENT-NASAL

## Forceps- Nasal/Polyp/Bone Cutting

### WILDE-Type Backbiter Forceps

Catalog Number	Jaw Size (mm)	Tip	Working Length (in.)	Length (in.)
MA688R	2	STR, ROTATING 360°	4 1/4	8 3/4
MA689R	2	CVD UP	3 1/8	6 7/8
MA690R	2	CVD DOWN	3 1/8	6 7/8

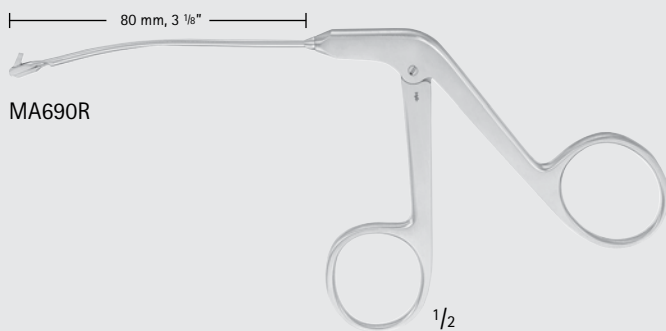
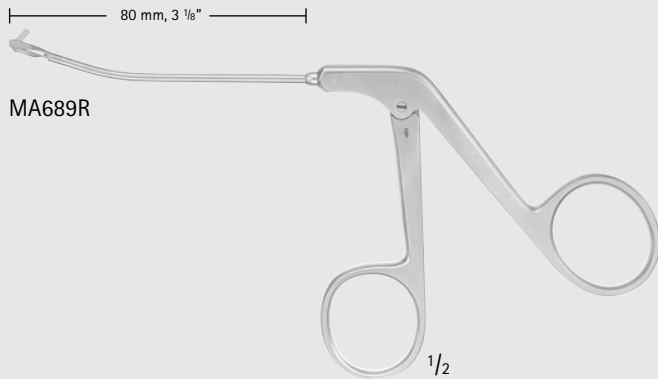
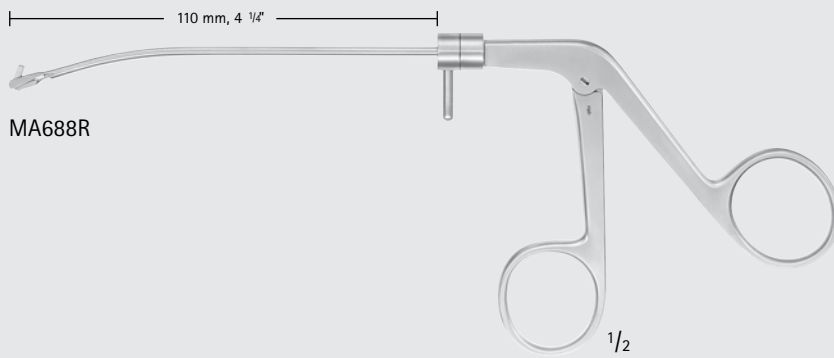

INCHES

# ENT-NASAL

Forceps- Cartilage/Morselizing/Straightening

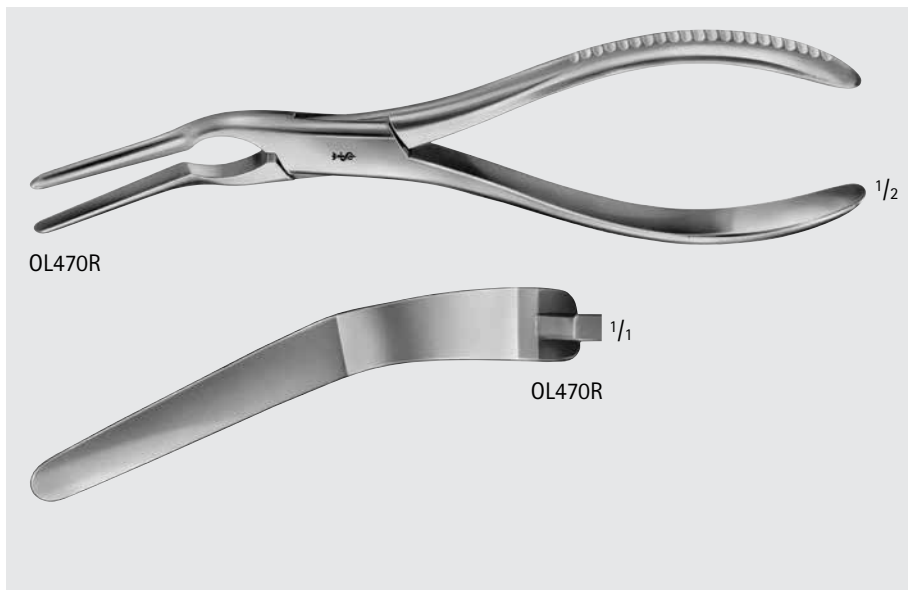
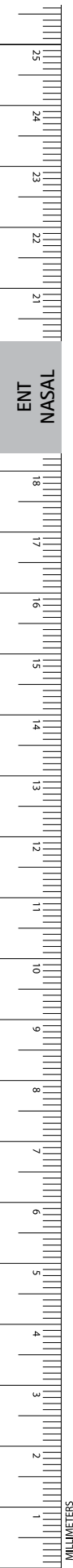

**ASH Septum Forceps**

Catalog Number	Tip	Length (in.)
OL470R	ANG	8 3/4

OL470R

OL470R

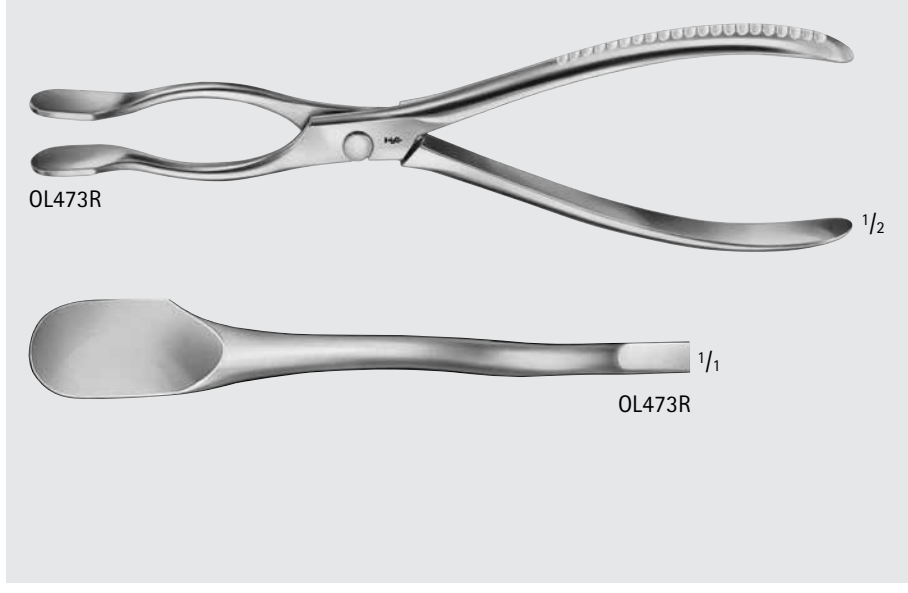

**COTTLE-WALSHAM Septum Forceps**

Catalog Number	Tip	Length (in.)
OL473R	STR	8 3/4

OL473R

OL473R

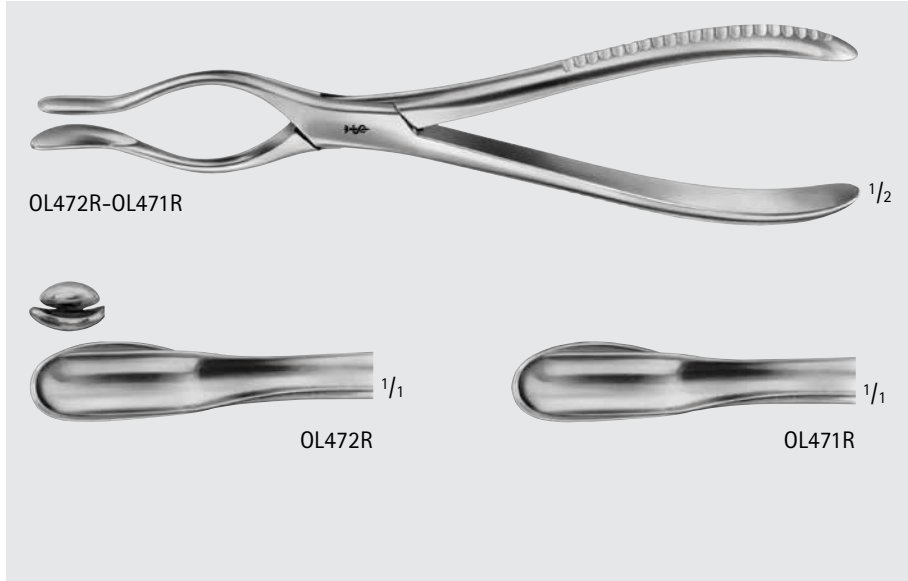

**WALSHAM Septum Forceps**

Catalog Number	Tip	Length (in.)
OL472R	LEFT	8 3/4
OL471R	RIGHT	8 3/4

OL472R-OL471R

OL472R

OL471R



OL474R

Septum Morselizer Forceps,  
W/ Removable Guard

Catalog Number	Length (in.)
OL474R	7 7/8



OL474R

1/1

1/2

Bone and Cartilage Crusher, W/ Clamp

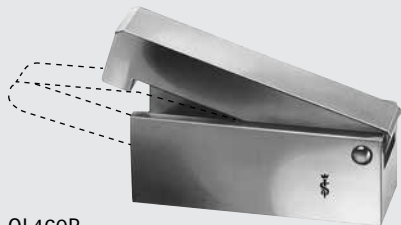

OL460R

Catalog Number
OL460R

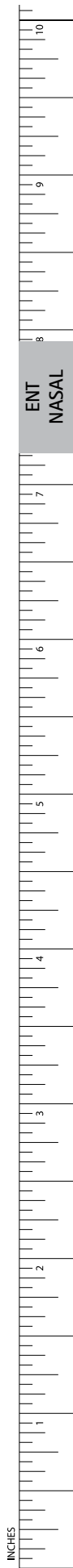

INCHES

# ENT-NASAL

## Nasal Snares and Wires

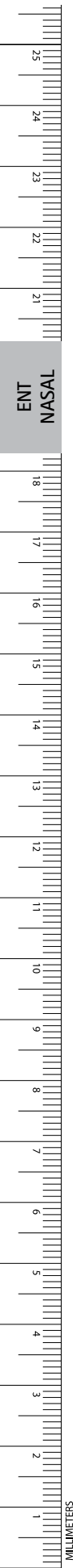

### KRAUSE Nasal Polyp Snare, Knee-Shape

Catalog Number	Length (in.)
OK260R	9 3/4



OK260R

### WILDE Nasal Polyp Snare

Catalog Number	Tip	Length (in.)
OK270R	BAYO	9 3/4

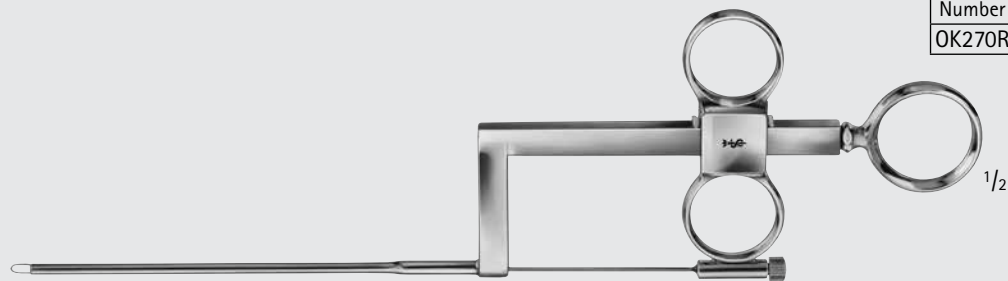

OK270R

### Nasal Snare Wire

Catalog Number	Diameter (mm)	Packaging
OK293R	0.3	100/BOX

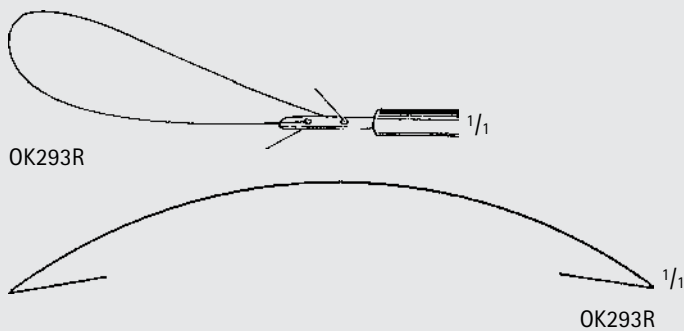

OK293R

OK293R



OL201R 1/2

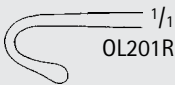

OL201R <sup>1/1</sup>

**LANGE Fistula Hook**

Catalog Number	Tip	Length (in.)
OL201R	BLUNT	9 1/4



MA178R-MA179R 1/2

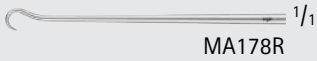

MA178R <sup>1/1</sup>



MA179R <sup>1/1</sup>

**CONVERSE Skin Hooks**

Catalog Number	Size	Length (in.)
MA178R	SMALL	7 1/8
MA179R	LARGE	7 1/8



OL207R 1/2



<sup>1/1</sup>

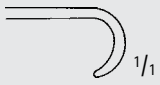

OL207R <sup>1/1</sup>

**CONVERSE Double Hook**

Catalog Number	Blade Size (mm)	Length (in.)
OL207R	7 x 12 / 8 x 12	4 3/4



MA186R 1/2



MA186R <sup>1/1</sup>

**MILLARD Double Hook W/ Thimble Mount**

Catalog Number	Length (in.)
MA186R	3 1/4

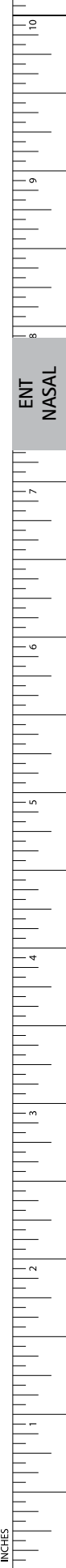

# ENT-NASAL

## Retractors



OK099R-MA422R

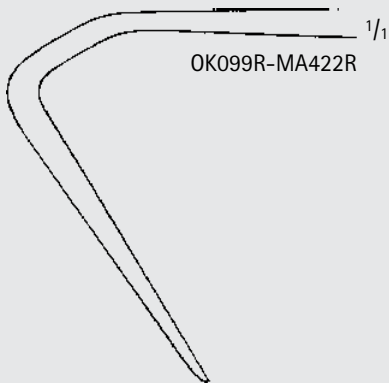

OK099R-MA422R

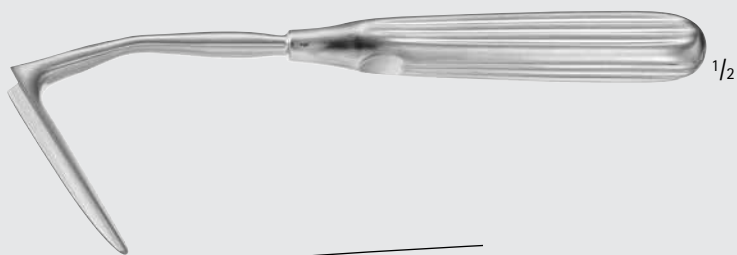

MA423R

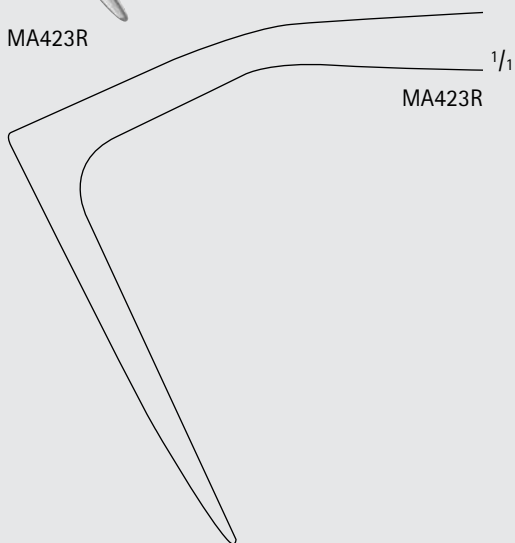

MA423R

### AUFRICHT Nasal Retractor

Catalog Number	Blade Size (mm)	Length (in.)
OK099R	10 x 45	6 7/8
MA422R	10 x 45	7 3/8
MA423R	11 x 60	7 3/8

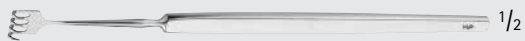

MA424R

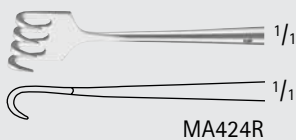

MA424R

### Blair Retractor

Catalog Number	Tip	Blade End	Tip Size (mm)	Length (in.)
MA424R	SHARP	4 PRONGS	7	5 1/4

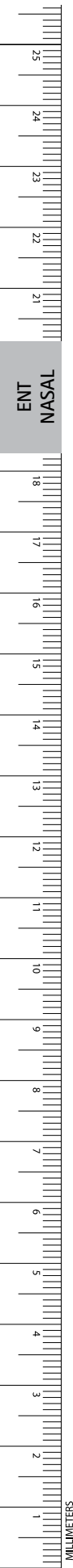

CONVERSE Nasal Retractor

Catalog Number	Blade Size (mm)	Length (in.)
MA425R	9 x 18	3 1/4
MA426R	12 x 21	3 1/4
MA427R	12 x 38	3 1/4
MA428R	12 x 53	3 1/4
MB107R	44 x 11	4 1/2



MA425R

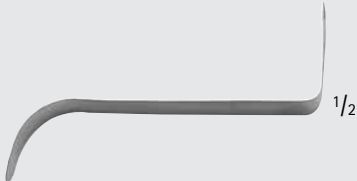

MA426R



MA427R

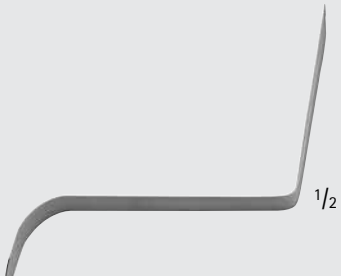

MA428R



MB107R

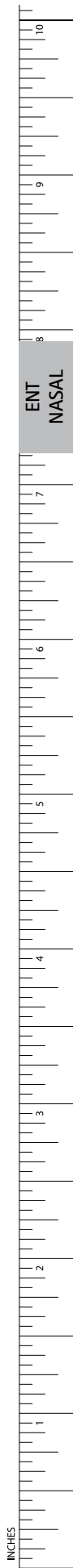

# ENT-NASAL

## Retractors



MA430R



MA430R

### COTTLE Nasal Retractor

Catalog Number	Tip	Blade End	Tip Size (mm)	Length (in.)
MA430R	BLUNT	4 PRONGS	10	5 1/8



OL214R



1/1



OL214R

### COTTLE Nasal Retractor, Double Ended

Catalog Number	Blade Size (mm)	Tip	Length (in.)
OL214R	12 x 5 / 4 x 4.5	BALL END/ BLUNT	7 7/8



OL203R-OL204R



OL203R



OL204R

### COTTLE Retractor

Catalog Number	Tip	Length (in.)
OL203R	BLUNT/RIGHT SHARP	5 3/4
OL204R	LEFT SHARP/BLUNT	5 3/4

ENT  
NASAL

MILLIMETERS



OL212R



OL212R



OL211R



OL211R

COTTLE Alar (MASING) Retractor

Catalog Number	Blade Size (mm)	Length (in.)
OL211R	6 x 12	5 1/2
OL212R	10 x 12	5 1/2



OL202R

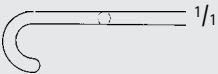

OL202R



MA431R



MA431R

FOMON Retractor

Catalog Number	Tip Size (mm)	Tip	Blade End	Length (in.)
OL202R	12	BLUNT	2 PRONGS	5 3/4
MA431R	13	BALL END	2 PRONGS	6 1/4

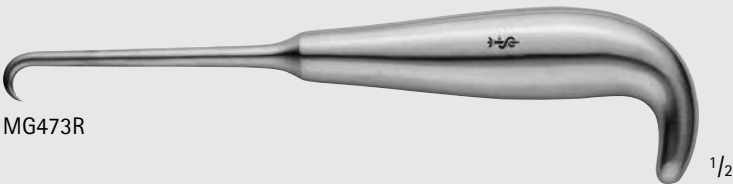

MG473R

GILLIES Bone and Zygoma Hook

Catalog Number	Tip Size (mm)	Length (in.)
MG473R	9	7 1/4



# ENT-NASAL

## Retractors

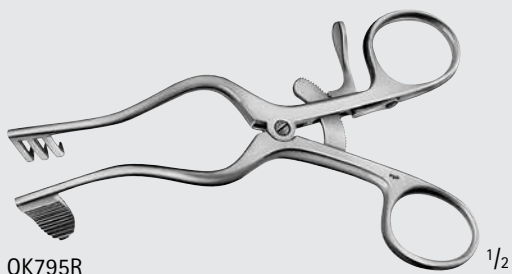

OK795R  $\frac{1}{2}$

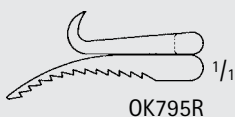

OK795R  $\frac{1}{1}$

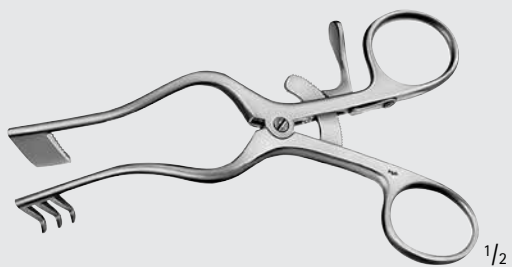

$\frac{1}{2}$

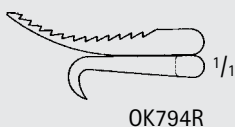

OK794R  $\frac{1}{1}$



$\frac{1}{1}$

### PERKINS Antrum Retractor

Catalog Number	Right Blade	Left Blade	Length (in.)
OK795R	3 PRONGS	SOLID	5
OK794R	SOLID	3 PRONGS	5

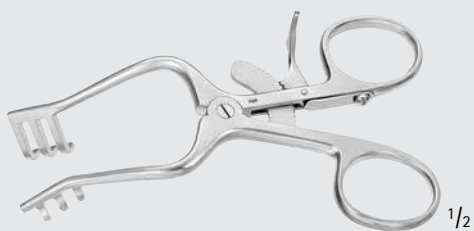

MA438R  $\frac{1}{2}$

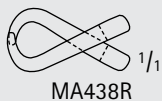

MA438R  $\frac{1}{1}$

### Baby WEITLANER Retractor

Catalog Number	Tip	Blade End	Length (in.)
MA438R	BLUNT	3 x 3 PRONGS	4 1/4

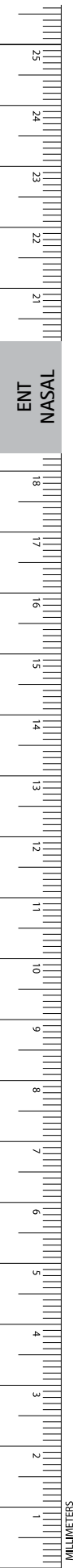



MB054R

1/2



MB054R

**WULLSTEIN Retractor**

Catalog Number	Tip	Blade End	Length (in.)
MB054R	BLUNT	3 x 3 PRONGS	4 1/4



BV030R

1/2

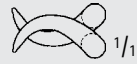

BV030R



BV032R

1/2



BV032R



BV033R

1/2

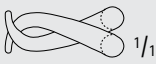

BV033R

**JANSEN Retractor**

Catalog Number	Tip	Blade End	Length (in.)
BV030R	SHARP	3 x 3 PRONGS	4
BV032R	BLUNT	3 x 3 PRONGS	4
BV033R	BLUNT	3 x 4 PRONGS	4

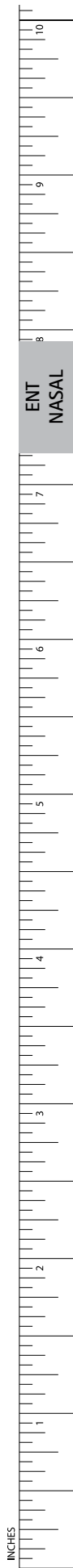

INCHES

# ENT-NASAL

## Elevators and Dissectors



**BOIES Nasal Fracture Elevator**

Catalog Number	Tip	Length (in.)
OL477R	BLUNT	7



**GOLDMANN Septum Displacer**

Catalog Number	Tip	Length (in.)
OL479R	STR	7 7/8

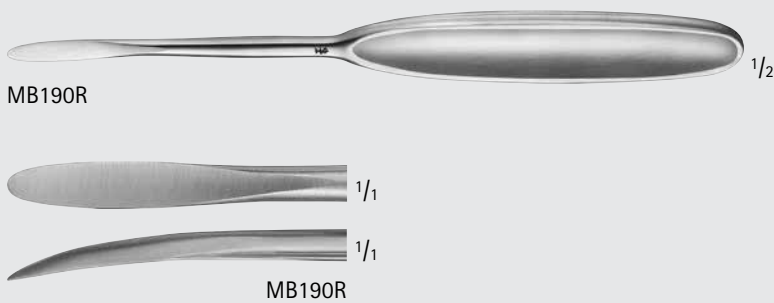

**CUSHING Elevator, Narrow**

Catalog Number	Tip Size (mm)	Tip	Length (in.)
MB190R	8	SHARP	7 3/4

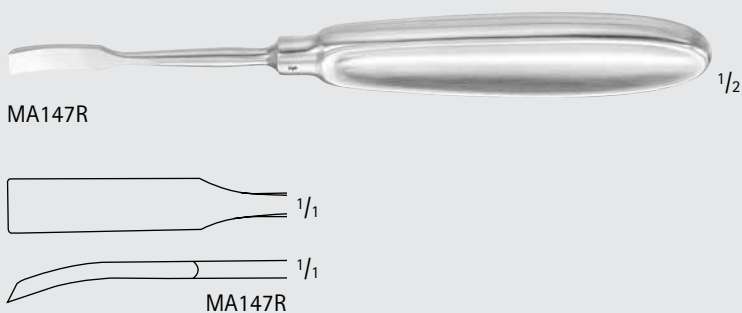

**LEMPERT Elevator**

Catalog Number	Tip Size (mm)	Blade	Length (in.)
MA147R	7	CVD	7 1/4

ENT  
NASAL

MILLIMETERS



MA145R-MA146R



MA145R

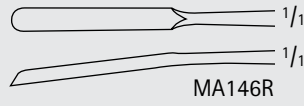

MA146R

**LEMPERT Elevator**

Catalog Number	Tip	Tip Size (mm)	Length (in.)
MA145R	SLIGHT CVD	2	6 3/4
MA146R	SLIGHT CVD	3	6 3/4
OG163R	STR	3	7 1/2
OG164R	BROAD, SLIGHT CVD	6	7 1/4



OG163R

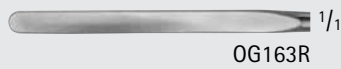

OG163R



OG164R

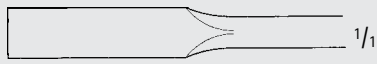

1/1

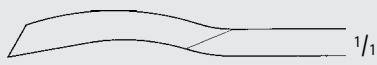

1/1

OG164R



MA290R



MA290R

**KLEINERT-KUTZ Elevator and Dissector, Double Ended**

Catalog Number	Tip Size (mm)	Length (in.)
MA290R	2/4	7



OL192R

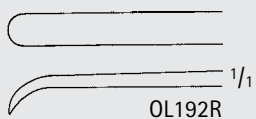

OL192R

**MCKENTY Periosteal Elevator**

Catalog Number	Tip	Tip Size (mm)	Length (in.)
OL192R	CVD, SHARP	4.0	6



ENT  
NASAL

INCHES

# ENT-NASAL

## Elevators and Dissectors

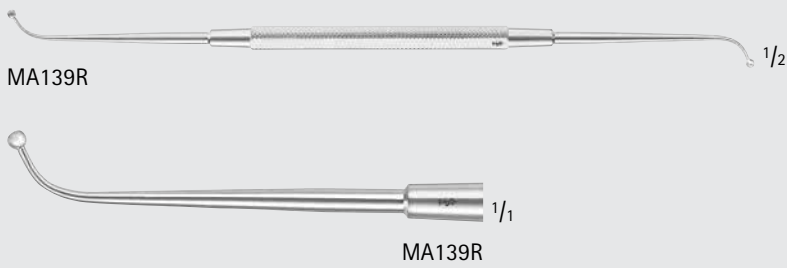

**Ball End Elevator, Double Ended**

Catalog Number	Blade Shape	Length (in.)
MA139R	ANG	7 1/2

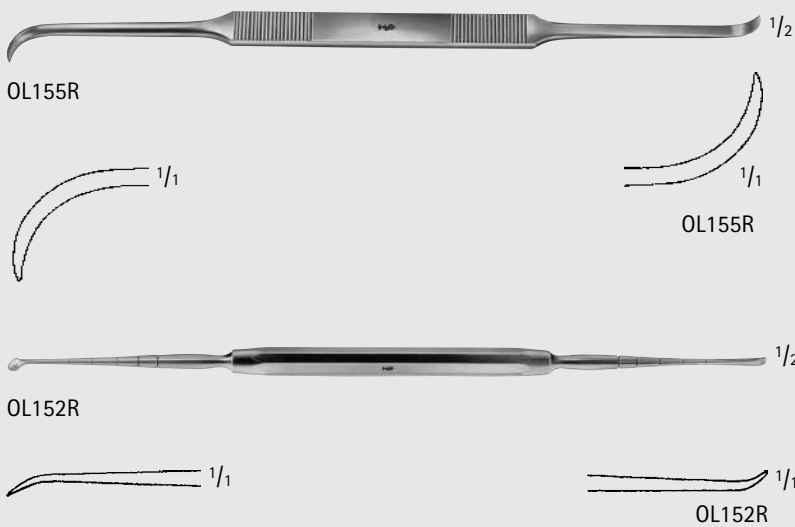

**COTTLE Elevator, Double Ended**

Catalog Number	Blade	Length (in.)
OL155R	-	7 7/8
OL152R	GRADUATED	7 7/8

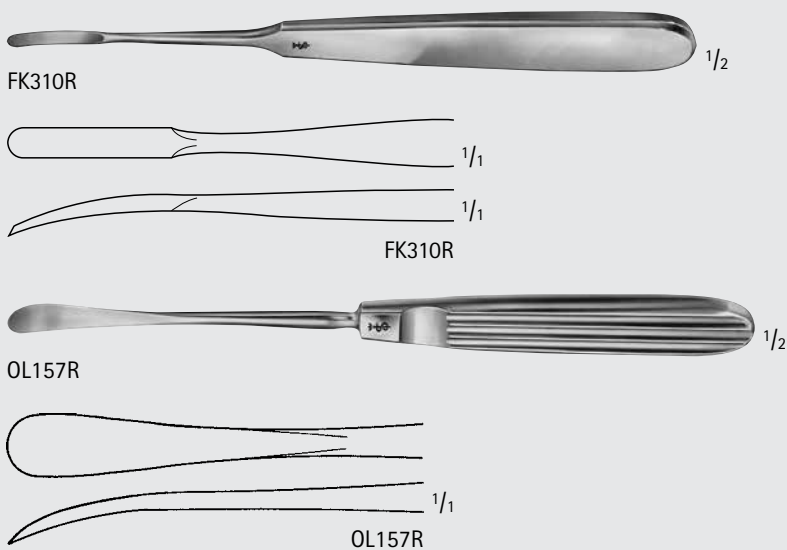

**COTTLE Periosteal Elevator**

Catalog Number	Tip	Width (mm)	Length (in.)
FK310R	SLIGHTLY CVD	4	7
OL157R	CVD, SHARP	8	7 3/4



# ENT-NASAL

## Elevators and Dissectors

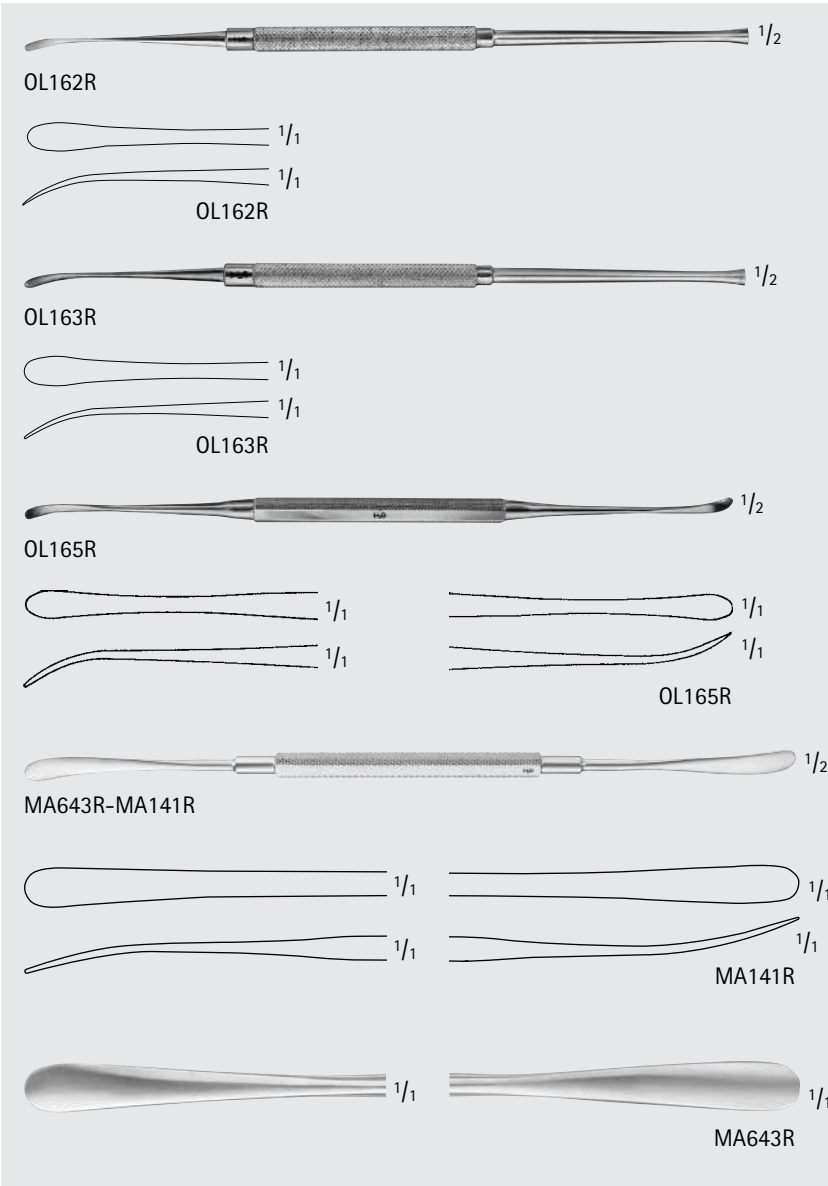

### FREER Elevator

Catalog Number	Tip	Tip Size (mm)	Length (in.)
OL162R	SINGLE ENDED SHARP	4	7 1/2
OL163R	SINGLE ENDED BLUNT	4	7 1/2
OL165R	SHARP/BLUNT	4 / 4	7 1/4
MA643R	SHARP/BLUNT	4.5 / 4.5	7 1/2
MA141R	SHARP/BLUNT	6.5	7 1/2

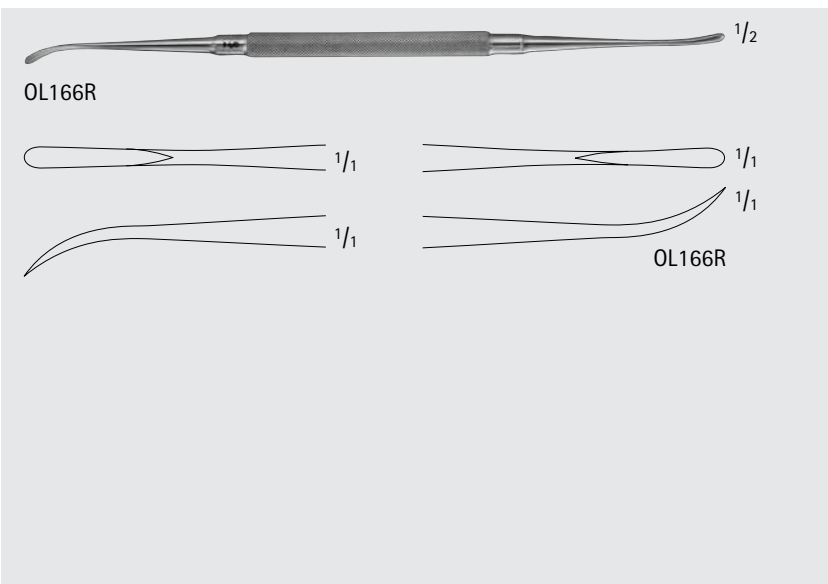

### FREER-YASARGIL Elevator

Catalog Number	Tip	Length (in.)
OL166R	SHARP/SHARP	7 1/4



# ENT-NASAL

## Elevators and Dissectors



OL198R

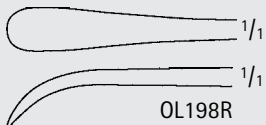

OL198R

### SEWALL Antrum Elevator

Catalog Number	Tip	Tip Size (mm)	Length (in.)
OL198R	BLUNT	5.9	7 7/8



MB297R

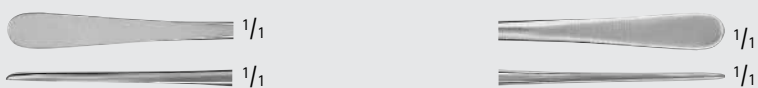

MB297R

### HAJEK-BALLENGER Septum Elevator and Dissector, Double Ended

Catalog Number	Tip	Length (in.)
MB297R	SHARP/BLUNT	7 1/2



OL153R

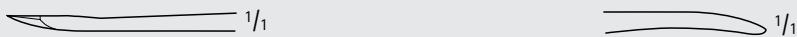

OL153R

### COTTLE (MASING) Elevator, Graduated

Catalog Number	Blade	Length (in.)
OL153R	DBL ENDED	7 7/8



OL151R

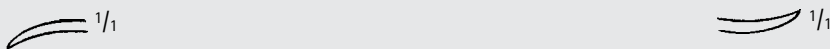

OL151R

### PENNINGTON Elevator

Catalog Number	Tip	Length (in.)
OL151R	SHARP/SHARP	8 1/4



MB313R

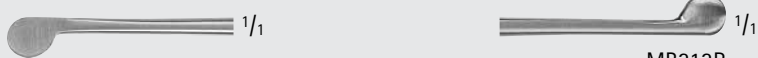

MB313R

### PIERCE Submucous Dissector

Catalog Number	Length (in.)
MB313R	7 1/2



MB312R

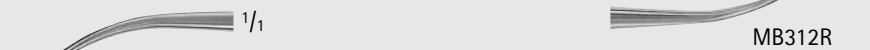

MB312R

### ROGERS Submucous Dissector

Catalog Number	Length (in.)
MB312R	8 3/4

ENT  
NASAL

MA144R

MA144R

Catalog Number	Tip Size (mm)	Length (in.)
MA144R	2/2	8 1/2

OL171R

OL171R

Catalog Number	Tip	Length (in.)
OL171R	SHARP/BLUNT	8 1/2

OL170R

OL170R

Catalog Number	Tip	Length (in.)
OL170R	SHARP/BLUNT	7 1/4

MG374R

MG374R

Catalog Number	Length (in.)
MG374R	5 3/4



# ENT-NASAL

## Elevators and Dissectors



OL160R

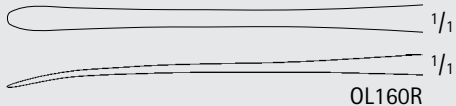

### HALLÉ Elevator

Catalog Number	Tip	Tip Size (mm)	Length (in.)
OL160R	BLUNT	3.3	7



OM307, OM309R, OM308R

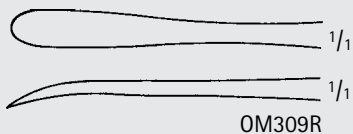
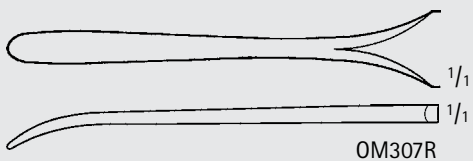

### KOENIG Elevator

Catalog Number	Tip	Tip Size (mm)	Length (in.)
OM307R	SLIGHTLY CVD	4.5	6 1/8
OM309R	SLIGHTLY CVD	4.5	6 1/8
OM308R	STRONGLY CVD	4.5	6 1/8



MA143R

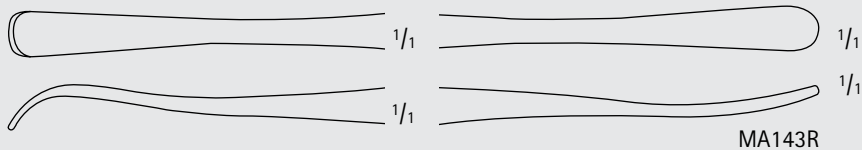

### OBWEGESER-FREER Elevator

Catalog Number	Tip	Tip Size (mm)	Blade Shape	Length (in.)
MA143R	BLUNT	6	DBL ENDED	8 1/2

ENT  
NASAL

MILLIMETERS

COTTLE Septum Speculum

Catalog Number	Blade Size (mm)	Blade Shape	W/ Set Screw	Length (in.)
OK085R	50 x 6	TAPERED	NO	5 1/4
OK089R	76 x 7	THIN	YES	5 1/4
OK090R	90 x 7	THIN	YES	5 1/4



OK085R

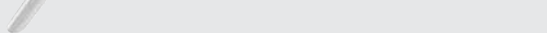
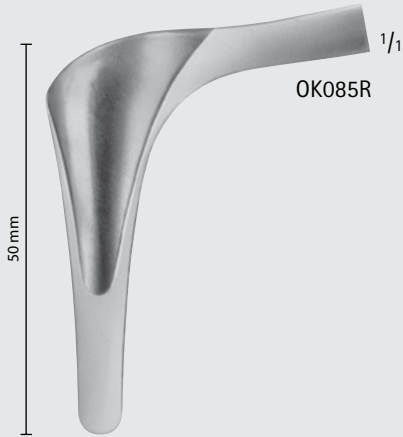

OK089R-OK090R

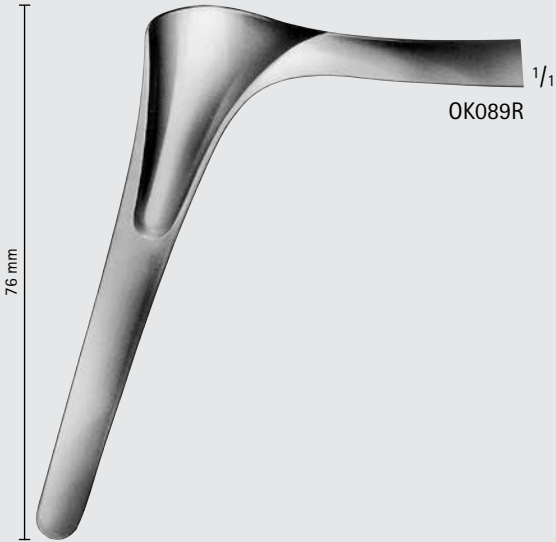

OK089R

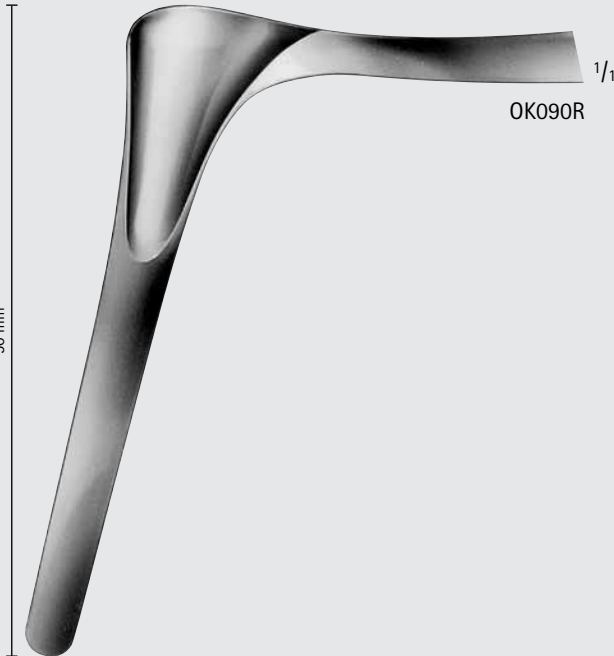

OK090R

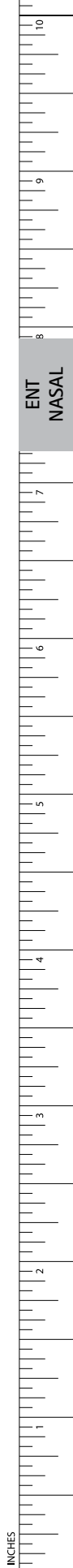

# ENT-NASAL

## Specula

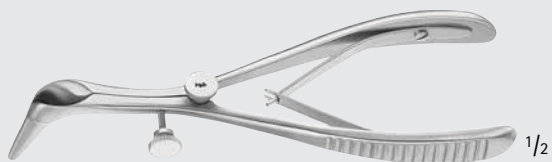

OK105R-OK108R

### COTTLE Nasal Speculum

Catalog Number	Blade Size (mm)	Blade Shape	Size (#)	Length (in.)
OK105R	20	Xtra Thin	1	5 1/4
OK106R	38	Xtra Thin	2	5 1/4
OK107R	41	Xtra Thin	3	5 1/4
OK108R	60	Xtra Thin	4	5 1/4

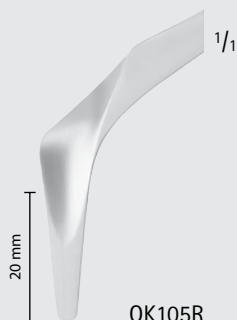

OK105R



OK106R



OK107R

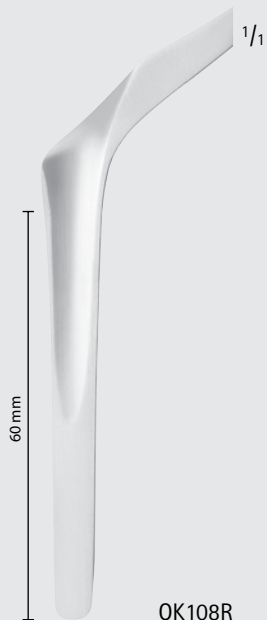

OK108R

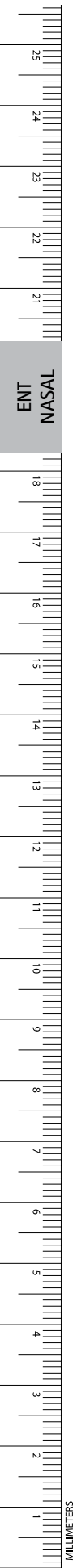

COTTLE Septum Speculum (continued)

Catalog Number	Blade Size (mm)	Blade Shape	Length (in.)
MA346R	50	THIN	5 5/8



MA346R

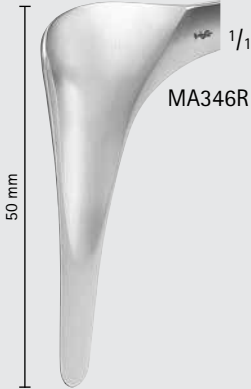

KILLIAN Septum Speculum, Aseptic

Catalog Number	Blade Size (mm)	Length (in.)
OK081R	36 x 7	5 1/2
OK082R	56 x 7	5 1/2
OK083R	75 x 7	5 1/2
OK084R	90 x 7	5 1/2



OK081R-OK084R

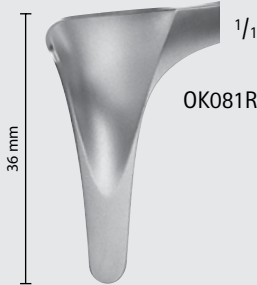

OK081R

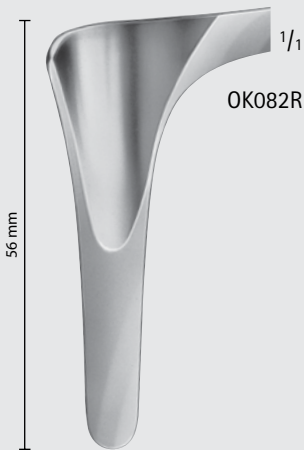

OK082R

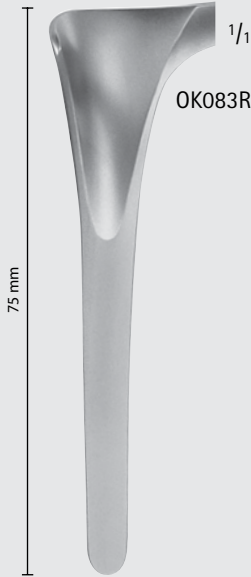

OK083R

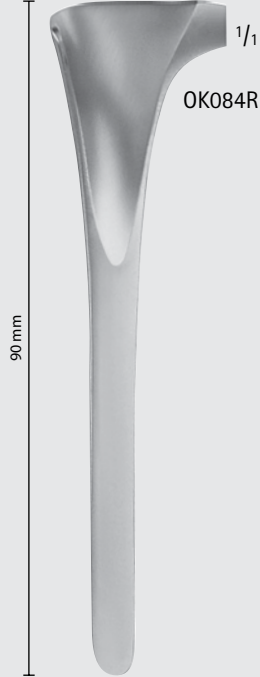

OK084R

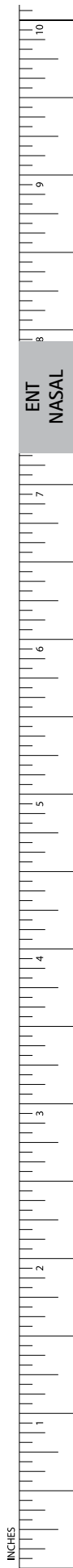

# ENT-NASAL

## Specula



OK091R-OK094R

### KILLIAN Septum Speculum W/ Screw Joint

Catalog Number	Blade Size (mm)	Length (in.)
OK091R	36 x 7	5 3/4
OK092R	56 x 7	5 3/4
OK093R	75 x 7	5 3/4
OK094R	90 x 7	5 3/4

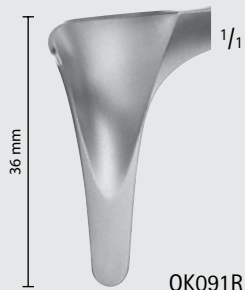

OK091R

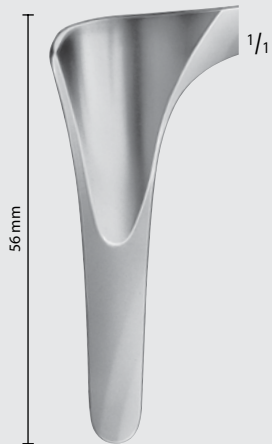

OK092R

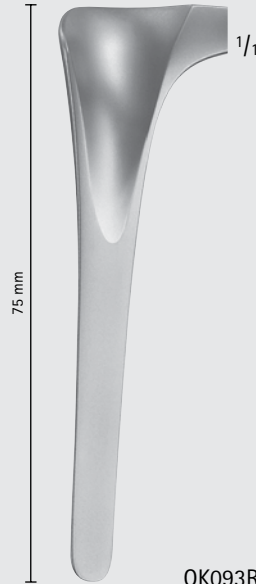

OK093R

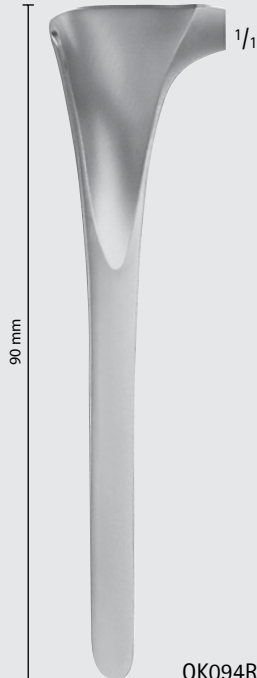

OK094R

ENT  
NASAL

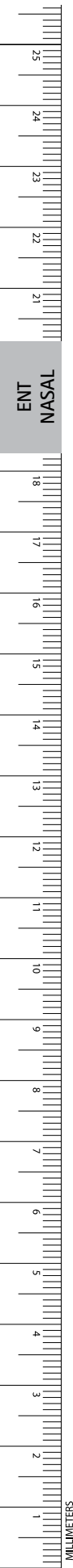

VIENNA Nasal Speculum

Catalog Number	Blade Size	Length (in.)
OK060R	SMALL	5 1/2
OK061R	MEDIUM	5 1/2
OK062R	LARGE	5 1/2



OK060R

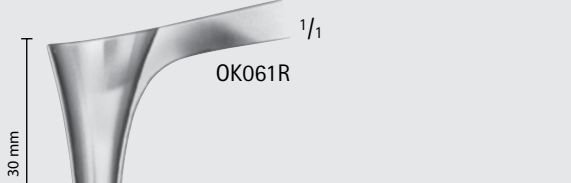

OK061R

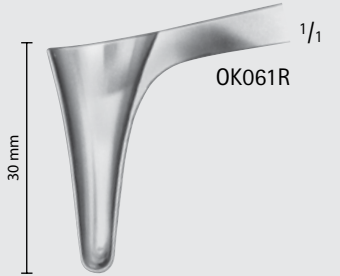

OK062R



# ENT-NASAL

## Specula



MA348R-MA350R

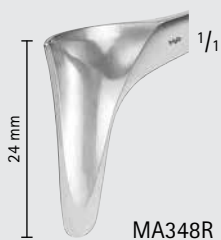

MA348R

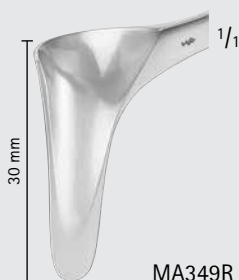

MA349R

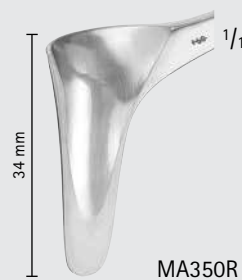

MA350R

### VIENNA Nasal Speculum (continued)

Catalog Number	Blade Size (mm)	Tip Size (mm)	Length (in.)
MA348R	24	1	5 1/4
MA349R	30	3	5 1/4
MA350R	34	4	5 1/4



OK030R



OK030R



OK041R-OK043R



OK041R

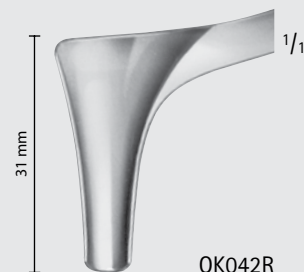

OK042R



OK043R

### HARTMANN Nasal Speculum

Catalog Number	Blade Size	Length (in.)
OK030R	LIGHT	5 3/4
OK041R	SMALL	6 1/4
OK042R	MEDIUM	6 1/4
OK043R	LARGE	6 1/4

ENT  
NASAL



OK047R-OK049R

HARTMANN-HALLE Nasal Speculum W/ Screw Joint

Catalog Number	Blade Size	Length (in.)
OK047R	SMALL	6 1/8
OK048R	MEDIUM	6 1/8
OK049R	LARGE	6 1/8

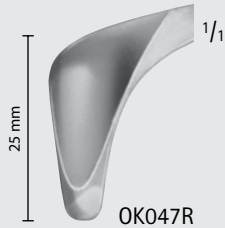

OK047R

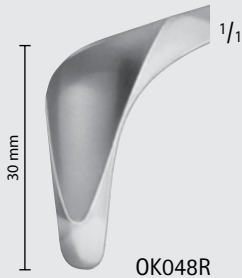

OK048R

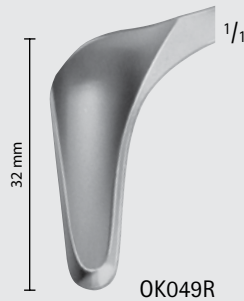

OK049R

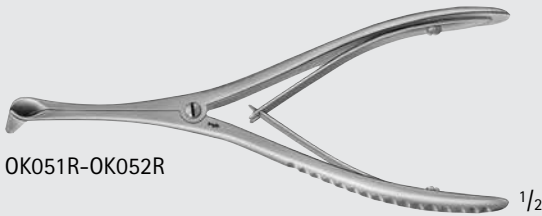

OK051R-OK052R

TIECK-HALLE Nasal Speculum W/ Screw Joint, Pediatric

Catalog Number	Blade Size	Length (in.)
OK051R	SMALL	5 1/4
OK052R	LARGE	5 1/4



OK051R

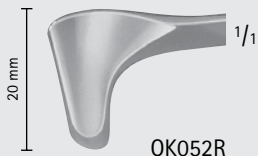

OK052R

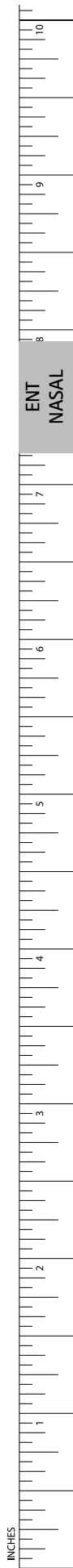

# ENT-NASAL

## Specula

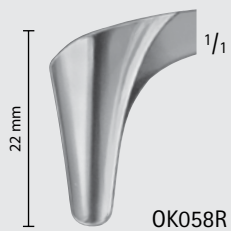
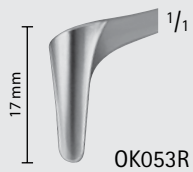

### BECKMANN Nasal Speculum W/ Screw Joint, Pediatric

Catalog Number	Blade Size	Blade Shape	Length (in.)
OK053R	SMALL	LAT-CVD	5 1/2
OK058R	MEDIUM	LAT-CVD	6

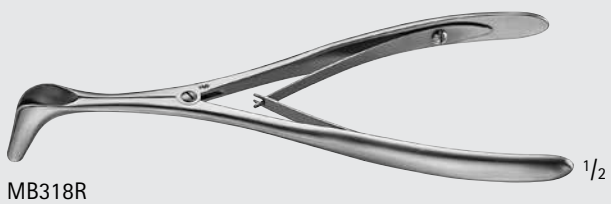

### SONNENSCH EIN Nasal Speculum

Catalog Number	Blade Size	Length (in.)
MB318R	MEDIUM	6

ENT  
NASAL



OK100R-OK102R



OK103R

**CUSHING-LANDOLT Transsphenoidal Speculum**

Catalog Number	Blade Size (mm)	Length (in.)
OK100R	70 x 15	-
OK101R	90 x 15	-
OK102R	110 x 15	-
OK103R	SPREADER FOR OK100R-OK102R	8 1/4

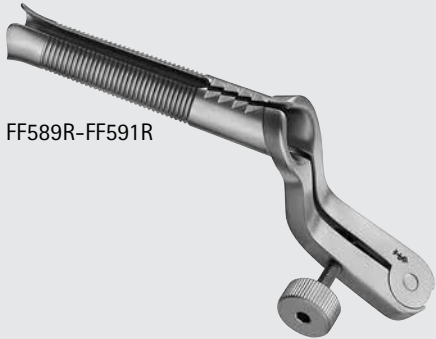

FF589R-FF591R



TE749R



FF595R

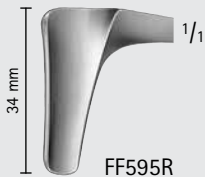

FF595R

**PAPAVERO-HARTMANN (CASPAR) Transsphenoidal Speculum, Slim, W/ Key**

Catalog Number	Blade Size (mm)	Description	Length (in.)
FF589R	80 x 11	-	-
FF590R	90 x 13	-	-
FF591R	100 x 15	-	-
TE749R	-	HEX KEY	-
FF595R	34 x 9	SPREADER FOR FF589R-FF591R	5 1/2

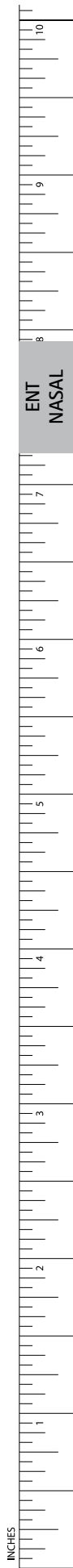

INCHES

# ENT-NASAL

## Rasps, Files and Saws

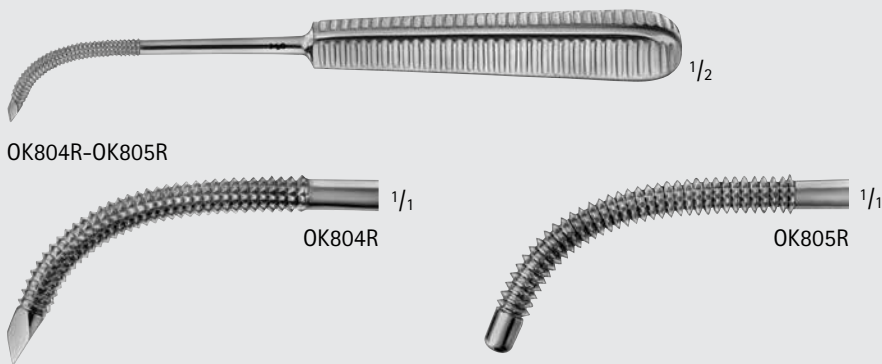

### Antrum Rasp

Catalog Number	Tip	Length (in.)
OK804R	SHARP	7
OK805R	BLUNT	7



### WEINER Antrum Rasp Trocar

Catalog Number	Tip	Length (in.)
MA421R	EXTRA SMALL, TROCAR	7 3/8

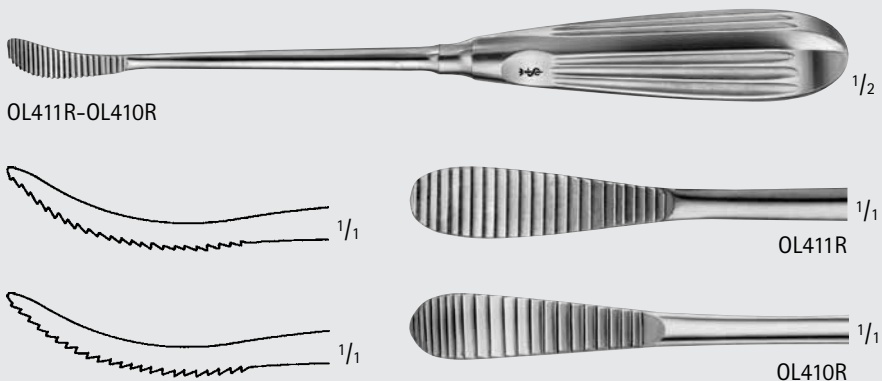

### AUFRICHT Nasal Rasp

Catalog Number	Tip Size (mm)	Tip	Length (in.)
OL411R	9	DOWN-CUT	8 3/4
OL410R	9	UP-CUT	8 3/4



### COTTLE Rasp

Catalog Number	Tip	Length (in.)
MA706R	DOWN CUTTING	8 1/4

ENT  
NASAL



MA417R-MA416R

1/2



MA417R

1/1

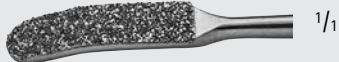

MA416R

1/1

**Diamond Dust Rasp**

Catalog Number	Tip	Length (in.)
MA417R	STR	7 3/8
MA416R	CVD	7 3/8



OL405R

1/2

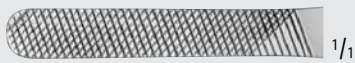

1/1

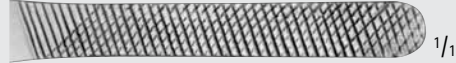

1/1

OL405R



OL406R

1/2



1/1



1/1

OL406R



MG584R

1/2

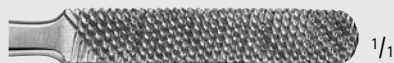
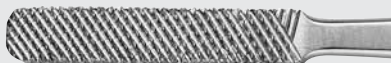

1/1

MG584R

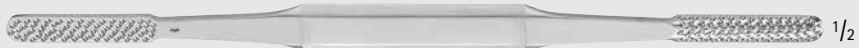

MA418R

1/2



1/1



1/1

MA418R

**FOMON Bone Rasp, Double Ended**

Catalog Number	Tip Size (mm)	Tip	Length (in.)
OL405R	6.5 / 7.5	X-SERR Fine/Coarse	8 1/2
OL406R	6.5 / 7.5	Fine/Coarse	8 1/2
MG584R	8/8	FLAT, CONVEX FINE, COARSE	8 1/2
MA418R	7.5 / 7.5	Coarse/ Xtra-Coarse	8 3/8



OL412R

1/2



1/1

OL412R

**GALLAHER File Rasp, Coarse**

Catalog Number	Tip Size (mm)	Length (in.)
OL412R	6.5	7 1/2

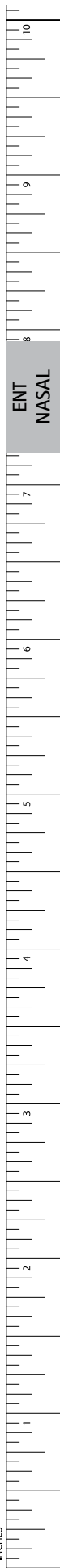

INCHES

# ENT-NASAL

## Rasps, Files and Saws



OL448R



OL451R

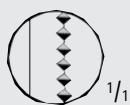

OL452R

### JOSEPH Nasal Saw, Bayonet

Catalog Number	Blade Shape	Length (in.)
OL448R	STR	7 3/4
OL451R	CVD RIGHT	7 3/4
OL452R	CVD LEFT	7 3/4



OL401R-OL403R

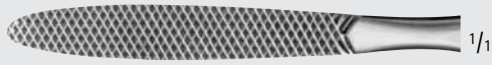

OL401R

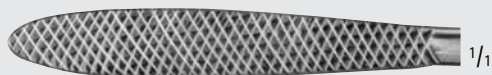

OL403R

### JOSEPH Nasal Saw

Catalog Number	Tip	Tip Size (mm)	Length (in.)
OL401R	FINE-SERR	7.5	6 1/2
OL403R	COARSE-SERR	9	6 1/2



OL408R-OL409R

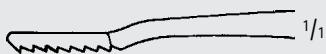

OL408R



OL409R

### LEWIS Bone Rasp

Catalog Number	Tip	Tip Size (mm)	Length (in.)
OL408R	FINE-SERR DOWN-STROKE	8	6 7/8
OL409R	COARSE-SERR DOWN-STROKE	8	6 7/8





MB110R



MB110R

**MALTZ-ANDERSON Nasal Rasp**

Catalog Number	Tip Size (mm)	Length (in.)
MB110R	5.7	6 1/2



OL407R

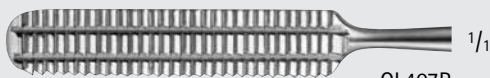

OL407R



MA419R



MA419R



MA420R



MA420R

**MALTZ Bone Rasp**

Catalog Number	Tip Size (mm)	Tip	Length (in.)
OL407R	9	DOWN-STROKE	6 1/2
MA419R	33	DOWN-STROKE	6 1/2
MA420R	33	UP STROKE	6 1/2



MB330R



MB330R

**PARKES Nasal Rasp**

Catalog Number	Tip Size (mm)	Length (in.)
MB330R	8	7 7/8

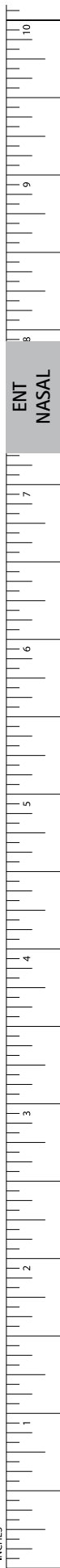

INCHES

# ENT-NASAL

## Chisels and Gouges

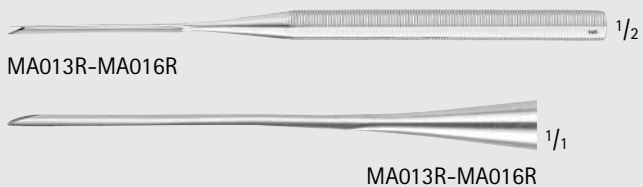

### BALLENGER Chisel, V-shaped

Catalog Number	Tip Size (mm)	Length (in.)
MA013R	2	5 7/8
MA014R	4	5 7/8
MA016R	8	5 7/8

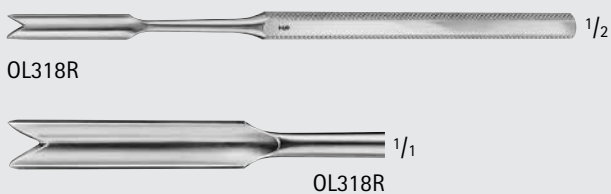

### BALLENGER Septum Gouge

Catalog Number	Tip Size (mm)	Length (in.)
OL318R	6	6

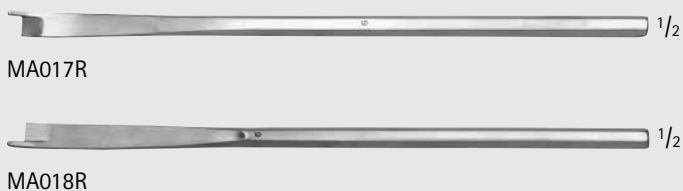

### CONVERSE Guarded Chisel

Catalog Number	Tip Size (mm)	Blade Shape	Length (in.)
MA017R	6	CVD RIGHT	7 1/2
MA018R	6	CVD LEFT	7 1/2



### COTTLE Chisel W/ Depth Marks

Catalog Number	Tip Size (mm)	Length (in.)
OL301R	4	7
OL302R	7	7
OL303R	9	7
OL304R	12	7



OL311R

1/2

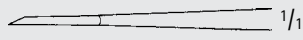

OL311R

1/1



OL314R

1/2

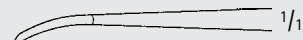

OL314R

1/1

**FREER Chisel**

Catalog Number	Tip Size (mm)	Blade Shape	Length (in.)
OL311R	4	STR	6 1/4
OL314R	4	CVD	6 1/4



FF610R

1/2

**PAPAVERO Bayonet Chisel**

Catalog Number	Tip Size (mm)	Length (in.)
FF610R	4	8 3/4



OL316R

1/2

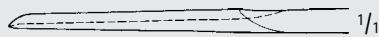

OL316R

1/1

**FREER Septum Gouge**

Catalog Number	Tip Size (mm)	Length (in.)
OL316R	4	6



OL336R

1/2



OL336R

1/1

**KILLIAN Septum Gouge, Bayonet**

Catalog Number	Tip Size (mm)	Length (in.)
OL336R	6	6 3/4



MB108R, MA629R

1/2



MB108R, MA629R

1/1

**PARKES Hump Gouge, Double Guard**

Catalog Number	Tip Size (mm)	Blade Shape	Length (in.)
MB108R	10	STR	7
MA629R	6	STR	7



ENT  
NASAL

INCHES

# ENT-NASAL

## Osteotomes



MA382R

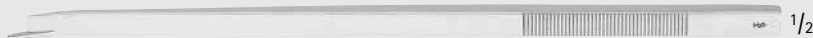

MA381R

### ANDERSON-NEIVERT Osteotome

Catalog Number	Tip Size (mm)	Blade Shape	Length (in.)
MA382R	5	CVD RIGHT	8
MA381R	5	CVD LEFT	8

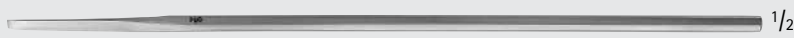

MB590R-MB594R

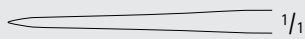

MB590R-MB594R

### CHERRY Osteotome

Catalog Number	Tip Size (mm)	Length (in.)
MB590R	3	8
MB591R	4	8
MB592R	5	8
MB593R	6	8
MB594R	7	8



MA369R

### CINELLI Osteotome, Double Guard

Catalog Number	Tip Size (mm)	Blade Shape	Length (in.)
MA369R	10	CVD	6 1/8

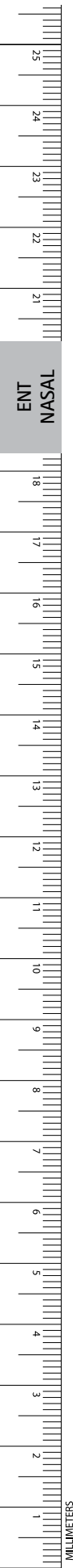



OL326R-OL329R



OL326R



OL327R



OL328R



OL329R

CINELLI Osteotome, Double Guard

Catalog Number	Tip Size (mm)	Blade	Length (in.)
OL326R	10	STR	6 1/4
OL327R	12	STR	6 1/4
OL328R	14	STR	6 1/4
OL329R	16	STR	6 1/4



MB398R-MB403R



MB398R-MB403R

CONVERSE Osteotome

Catalog Number	Tip Size (mm)	Length (in.)
MB398R	2	7
MB399R	4	7
MB400R	6	7
MB401R	8	7
MB402R	10	7
MB403R	12	7



OL294R-OL300R

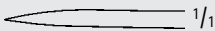

OL294R-OL300R

COTTLE Osteotome, W/ Depth Mark

Catalog Number	Tip Size (mm)	Length (in.)
OL294R	4	7
OL296R	6	7
OL298R	8	7
OL299R	10	7
OL300R	12	7



ENT  
NASAL

INCHES

# ENT-NASAL

## Osteotomes

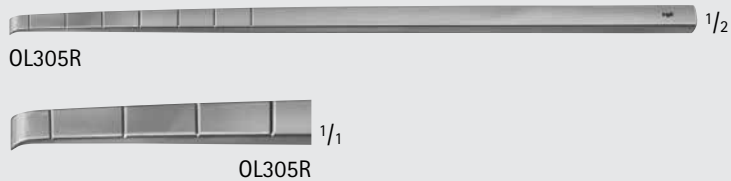

### COTTLE Osteotome, Curved

Catalog Number	Tip Size (mm)	Length (in.)
OL305R	6	7

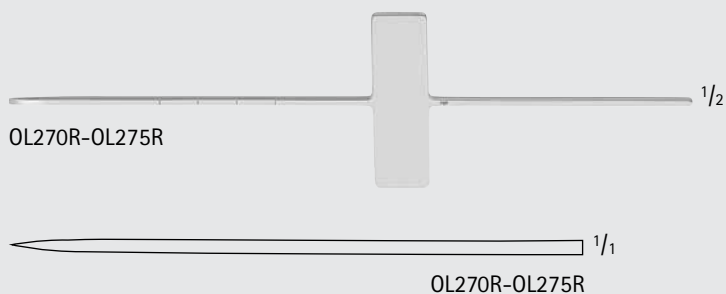

### COTTLE Osteotome W/ Cross Bar

Catalog Number	Tip Size (mm)	Blade Shape	Length (in.)
OL270R	2	STR	7
OL271R	4	STR	7
OL272R	6	STR	7
OL273R	7	STR	7
OL274R	9	STR	7
OL275R	12	STR	7



### TESSIER Osteotome

Catalog Number	Tip Size (mm)	Blade Shape	Length (in.)
OL360R	2.5	STR	6 1/4
OL361R	3.5	STR	6 1/4
OL362R	5	STR	6 1/4
OL366R	7	STR	6 1/4
OL368R	10	STR	6 1/4
OL370R	14	STR	6 1/4
OL371R	18	STR	6 1/4
OL363R	5	CVD	6 1/4
OL367R	7	CVD	6 1/4
OL369R	10	CVD	6 1/4

DAUTREY Osteotome

Catalog Number	Tip Size (mm)	Blade Shape	Length (in.)
OL344R	4	STR	6 3/4
OL345R	6	STR	6 3/4
OL346R	6	SLIGHTLY CVD	6 3/4
OL347R	6	STRONGLY CVD	6 3/4
OL348R	8	STR	6 3/4
OL349R	8	SLIGHTLY CVD	6 3/4
OL350R	8	STRONGLY CVD	6 3/4

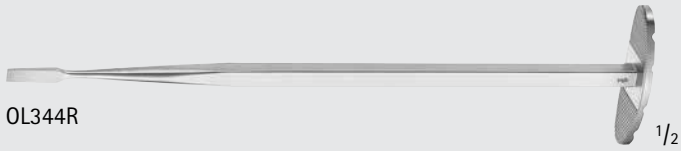

OL344R



1/16

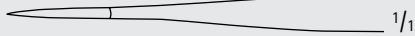

1/16

OL344R

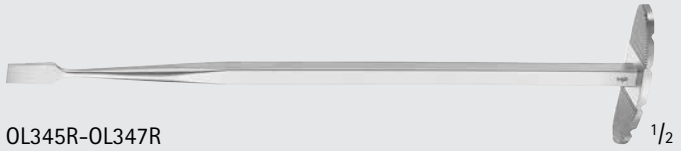

OL345R-OL347R



1/16



1/16

OL345R



1/16

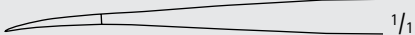

1/16

OL346R



1/16

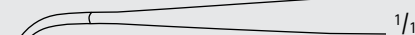

1/16

OL347R



OL348R-OL350R



1/16



1/16

OL348R



1/16



1/16

OL349R



1/16



1/16

OL350R

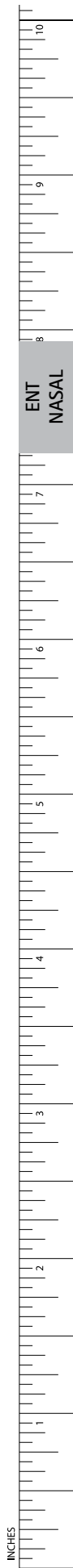

INCHES

# ENT-NASAL

## Osteotomes



OL338R-OL339R

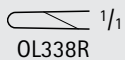

OL338R

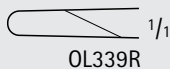

OL339R

### FOMON Osteotome, Single Guard

Catalog Number	Tip Size (mm)	Length (in.)
OL338R	5	6 3/4
OL339R	8	6 3/4



OL323R



OL321R



OL322R

### MASING Osteotome, Single Guard

Catalog Number	Blade	Length (in.)
OL323R	STR	6 7/8
OL321R	LEFT-CVD	6 7/8
OL322R	RIGHT-CVD	6 7/8



MA332R



MA333R



MA334R

### OBEWESGESER Nasal Osteotome

Catalog Number	Tip Size (mm)	Length (in.)
MA332R	6	7 1/4
MA333R	8	7 1/4
MA334R	4	7 1/2

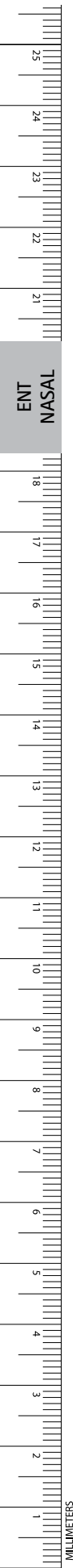



MB404R-MB373R



MB404R-MB373R

Osteotome W/ Hexagonal Handle

Catalog Number	Tip Size (mm)	Length (in.)
MB404R	2	6 1/4
MB405R	3	6 1/4
MB406R	4	6 1/4
MB407R	5	6 1/4
MB408R	6	6 1/4
MB409R	7	6 1/4
MB410R	8	6 1/4
MB411R	9	6 1/4
MB412R	10	6 1/4
MB413R	11	6 1/4
MB373R	12	6 1/4



MA384R

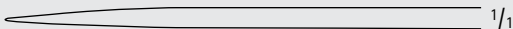

MA384R



MB388R



MB389R

RUBIN Osteotome, W/ Finger Grip

Catalog Number	Tip Size (mm)	Length (in.)
MA384R	14	6 1/4
MB388R	10	6 1/2
MB389R	14	6 1/2



# ENT-NASAL

## Applicators and Probes

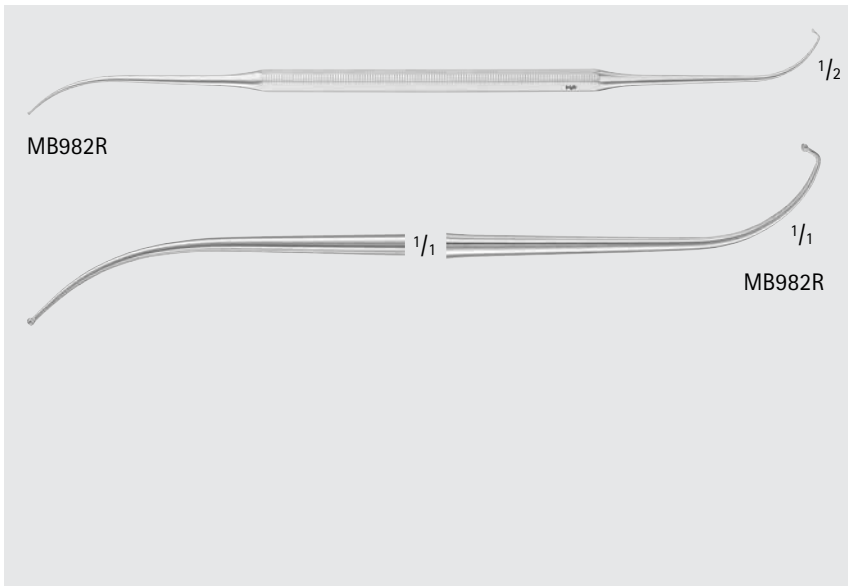
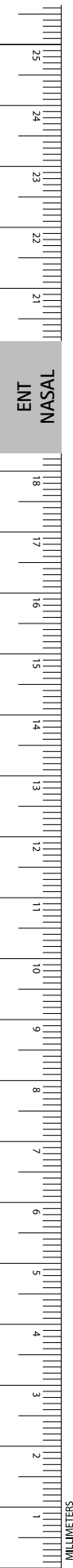

**Frontal Ostium Seeker Probe, Double Ended**

Catalog Number	Tip	Length (in.)
MB982R	CVD RIGHT, ANG	8 1/4

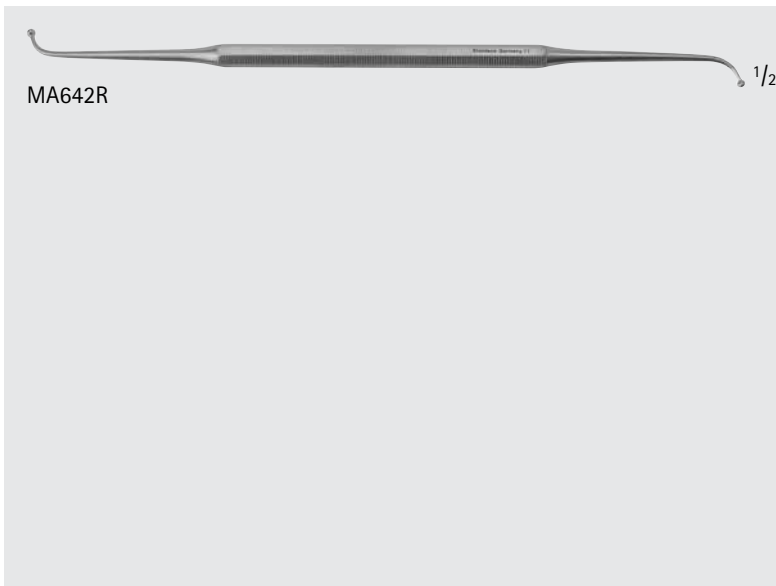

**Maxillary Sinus Seeker Probe, Double Ended**

Catalog Number	Tip	Tip Size (mm)	Length (in.)
MA642R	BALL	1.5 / 2	7 1/2

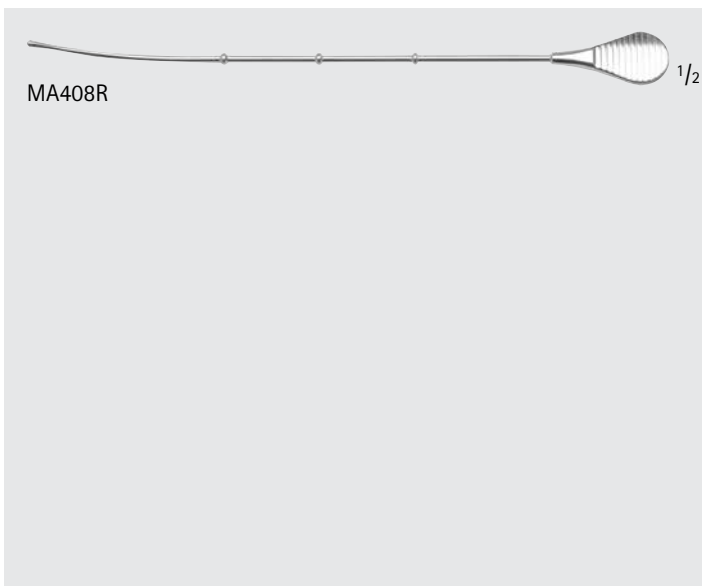

**SKILLERN Sinus Probe**

Catalog Number	Tip	Length (in.)
MA408R	MALLEABLE W/ BEADS AT 50, 70, AND 90 MM	6 3/4



OL354R-OL356R

**BALLENGER Swivel Knife, Bayonet**

Catalog Number	Blade Size (mm)	Length (in.)
OL354R	4 x 3	8 1/4
OL355R	5 x 4	8 1/4
OL356R	6 x 5	8 1/4

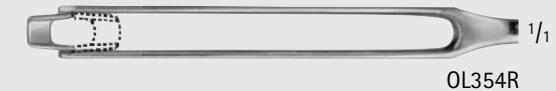

OL354R

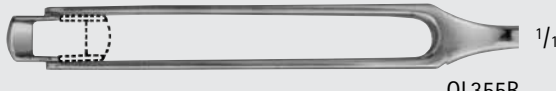

OL355R



OL356R



MA205R-MA207R

**BALLENGER Swivel Knife, Straight**

Catalog Number	Blade Width (mm)	Length (in.)
MA205R	3	7 1/2
MB119R	3	7 3/4
MB118R	4	7 3/4
MA207R	5	7 1/2



MA205R-MA207R



MB119R-MB118R



MB119R

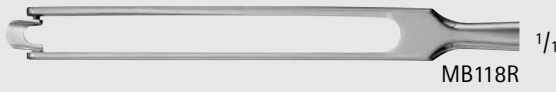

MB118R



OL109R

**CONVERSE Septum Knife, Button End**

Catalog Number	Blade	Length (in.)
OL109R	CVD	6



OL109R



OL113R

**COTTLE Septum Knife, Round End**

Catalog Number	Blade	Length (in.)
OL113R	STR	5 1/2



OL113R

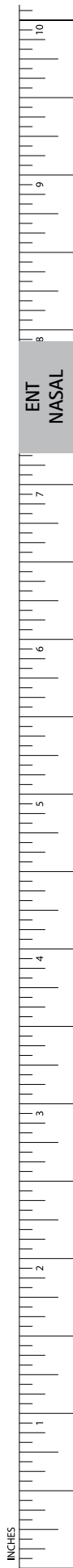

# ENT-NASAL

## Knives



OL120R



OL120R



MA212R



MA212R



MA211R

### FREER Septum Knife

Catalog Number	Blade Shape	Blade Size (mm)	Length (in.)
OL120R	"D" SHAPED	3	6
MA212R	"D" SHAPED	3	6 1/8
MA211R	ANG	5 x 8	7



OL111R



OL111R



OL107R



OL107R

### JOSEPH Knife, Button End

Catalog Number	Tip	Length (in.)
OL111R	STR	5 1/2
OL107R	CVD	6 7/8



OL102R-OL104R



OL102R



OL104R



OL104R

### JOSEPH Knife, Double Edge

Catalog Number	Blade	Blade Size (mm)	Length (in.)
OL102R	STR	5 x 23	5 3/4
OL104R	CVD	5 x 23	5 3/4

ENT  
NASAL



Suction Tube, Angled

Catalog Number	Tip	Tip Size (Gauge)	Length (in.)
MA010R	ANG	13	3



Nasal Suction Tube W/ Luer Hub, Tapered

Catalog Number	Tip Size (mm)	Length (in.)
GF919R	5	7

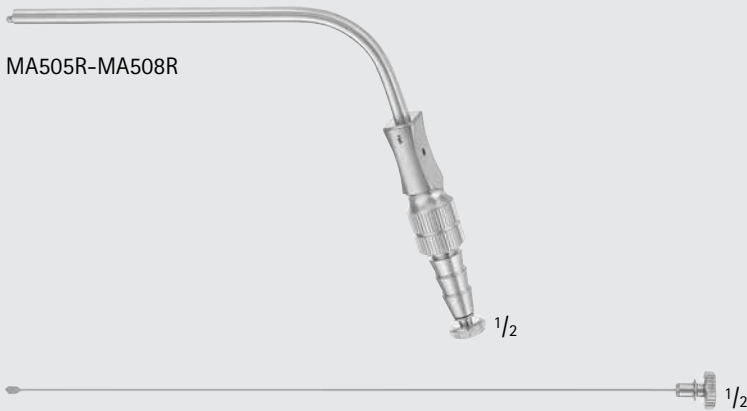

FERGUSON-FRAZIER Suction Tube

Catalog Number	Tip	Tip Size (FR)	Working Length (in.)	Length (in.)
MA505R	ANG	8	7 7/8	10 1/4
MA506R	ANG	10	7 7/8	10 1/4
MA508R	ANG	14	4	6 1/2
MA504R	ANG	14	5 7/8	8

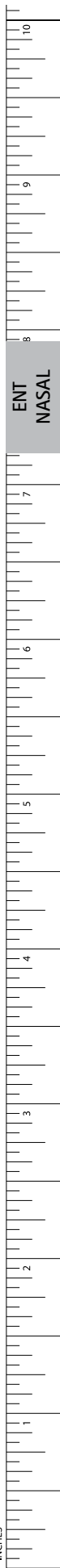
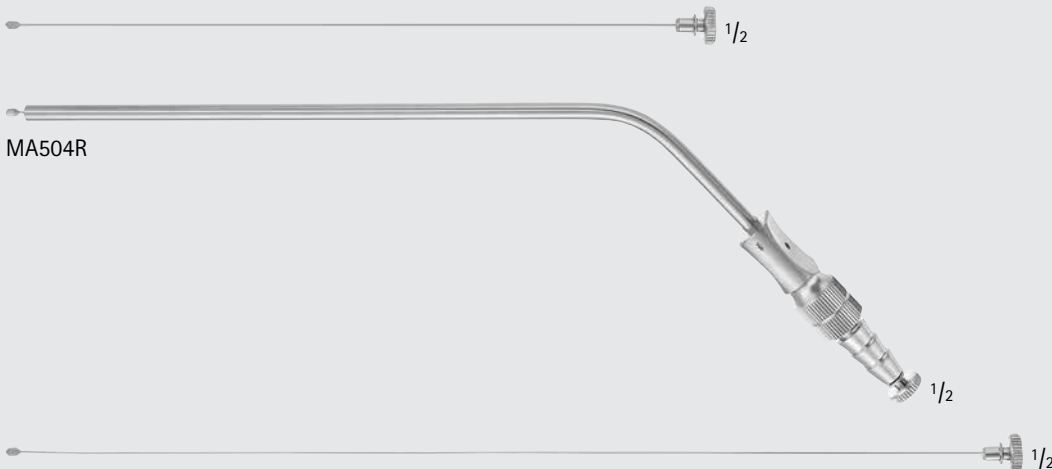

# ENT-NASAL

## Suction and Irrigation

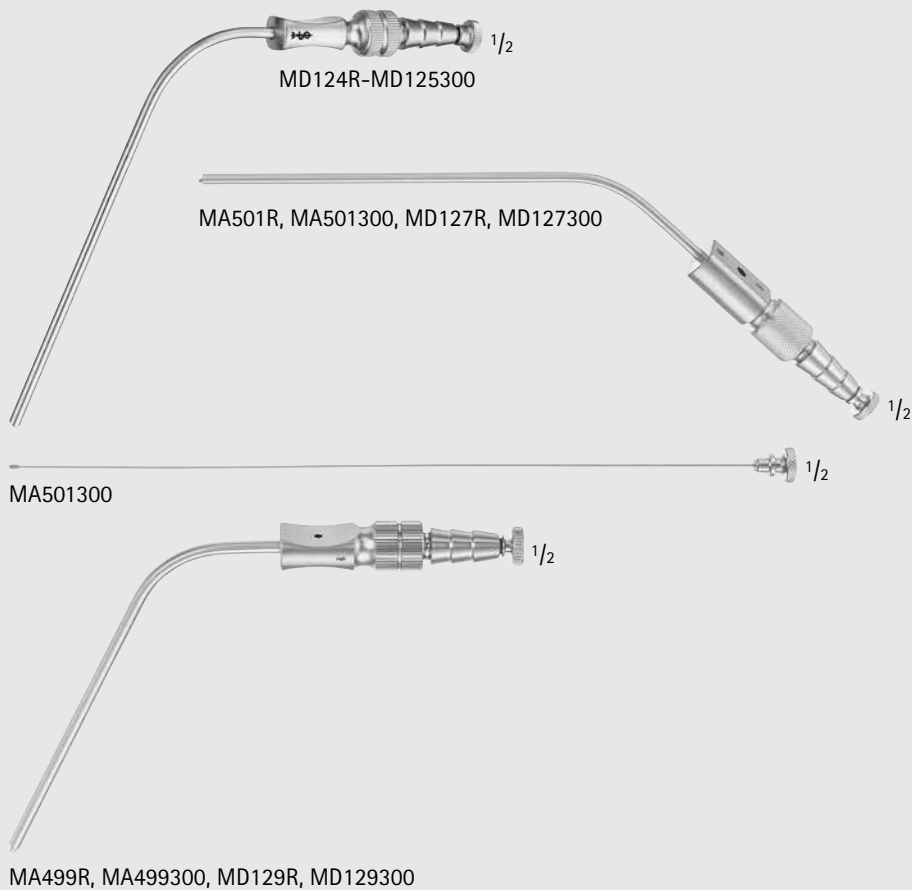

### FRAZIER Suction Tube

Catalog Number	Tip Size (FR)	Description	Working Length (in.)
MD124R	7		4 1/4
MD124300	7	SUCTION STYLET W/ OLIVE TIP FOR MD124R	
MD125R	8		4 1/4
MD125300	8	SUCTION STYLET W/ OLIVE TIP FOR MD125R	
MA501R	9		4 1/4
MA501300		SUCTION STYLET W/ OLIVE TIP FOR MA501R	
MD127R	10		4 1/4
MD127300	10	SUCTION STYLET W/ OLIVE TIP FOR MD127R	
MA499R	11		4 1/4
MA499300	11	SUCTION STYLET W/ OLIVE TIP FOR MA499R	
MD129R	12		4 1/4
MD129300	12	SUCTION STYLET W/ OLIVE TIP FOR MD129R	

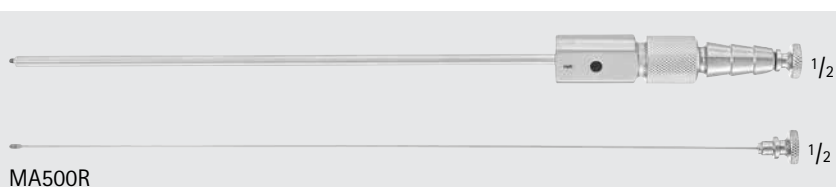

### FRAZIER Suction Tube, Straight

Catalog Number	Tip	Working Length (in.)	Length (in.)
MA500R	STR	5 1/2	6 7/8



**FRAZIER Suction Tube W/ Luer Hub**

Catalog Number	Tip Size (FR)	Length (in.)
GF923R	9	7
GF925R	15	7

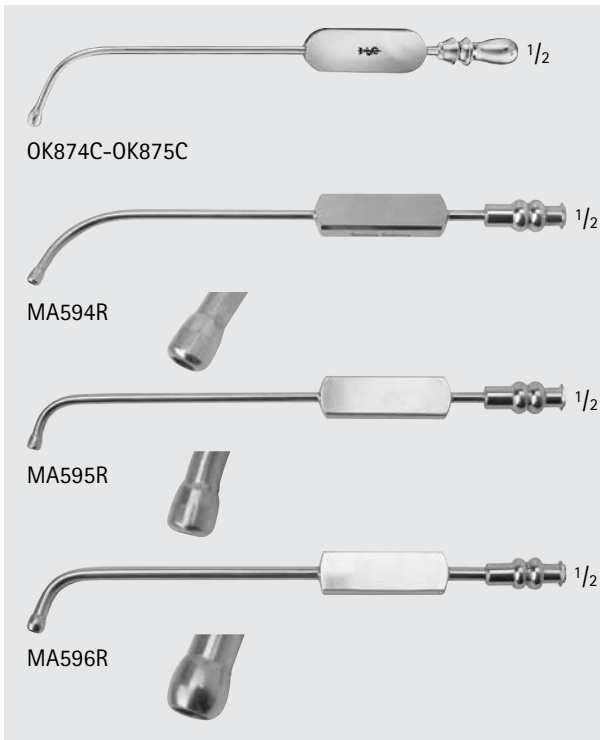

**EICKEN Antrum Suction Tube, Bulbous**

Catalog Number	Tip	Diameter (mm)	Length (in.)
OK874C	SMALL	2.5	5 1/8
OK875C	LARGE	3	5 1/8
MA594R	LONG CURVE	3	5 5/8
MA595R	SHORT CURVE	3	5 5/8
MA596R	SHORT CURVE	4	5 5/8

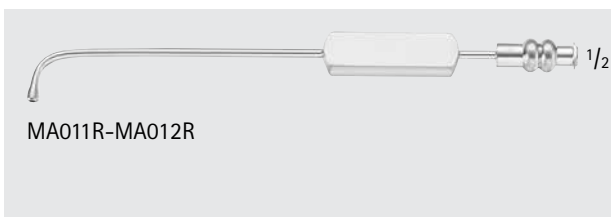

**KILLIAN Antrum Cannula**

Catalog Number	Tip Size	Tip Size (#)	Length (in.)
MA011R	SMALL	1	5
MA012R	LARGE	2	5

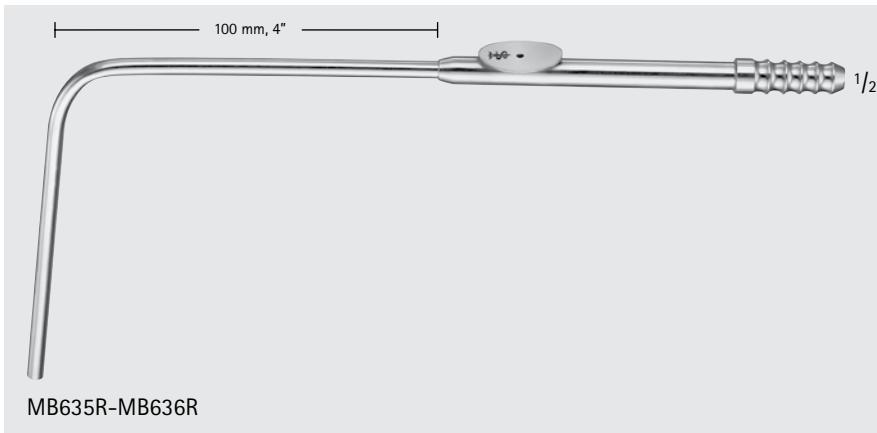

**SACHS Suction Tube**

Catalog Number	Tip Size	Length (in.)
MB635R	SMALL	8 1/2
MB636R	LARGE	8 1/2



# ENT-NASAL

## Suction and Irrigation



### GORNEY Suction Dissector, Elevator

Catalog Number	Tip Size (mm)	Length (in.)
OL168R	6-10	7
MA142R	3	8 1/2



MA142R



### HAJEK Irrigating Cannula

Catalog Number	Diameter (mm)	Length (in.)
OK900	3.5	6 1/2

OK900



### HOUSE Cutoff Adapter

Catalog Number	Tip	Tip Size (mm)
MA607R	TUBING END	4

MA607R

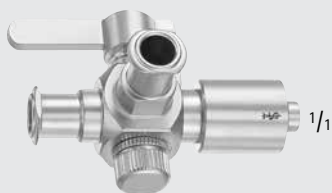

### Stopcock Luer Adapter, Female to Male

Catalog Number	Description
MA716R	FEMALE TO MALE LUER LOCK W/ FEMALE RIGHT

MA716R



### Luer Adapter

Catalog Number	Description
MA715R	MALE LUER LOCK-TO-HOSE

MA715R

ENT  
NASAL

COTTLE Mallet, Flat/Round, 235gr

Catalog Number	Diameter (mm)	Length (in.)
FLO38R	30	7 1/4

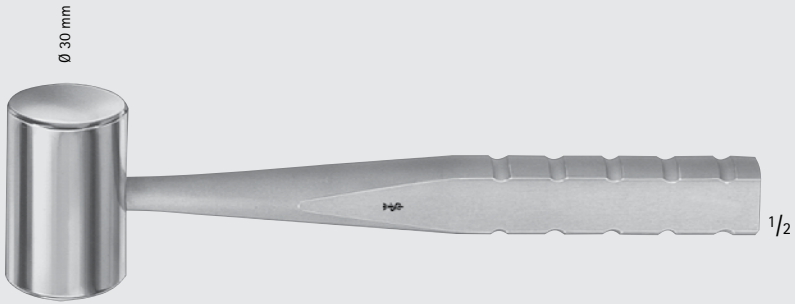

FLO38R

CRANE Mallet

Catalog Number	Diameter (mm)	Length (in.)
MB303R	32	6 1/4



MB303R

Mallet, 155gr

Catalog Number	Diameter (mm)	Length (in.)
DF114R	25	7 1/2



DF114R

Lead Mallet

Catalog Number	Diameter (mm)	Handle	Description	Length (in.)
MA239R	25	LARGE	LEAD FILLED	7 1/16

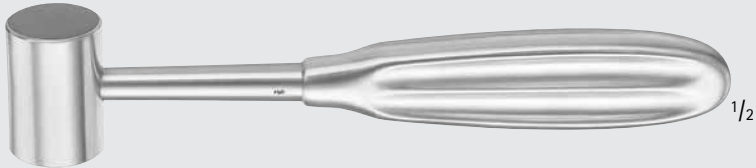

MA239R



# ENT-NASAL

## Mallets, Hammers and Tamps

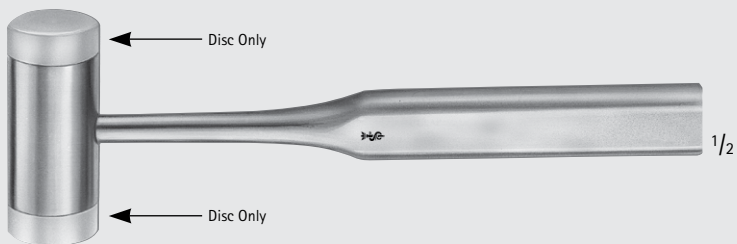

FL036R-FL037

### Mallet W/ Removable Nylon Discs, 135gr

Catalog Number	Description	Diameter (mm)	Length (in.)
FL036R	COMPLETE	25	7 1/4
FL037	NYLON SPARE DISCS, F/FL036R, 2/SET	25	

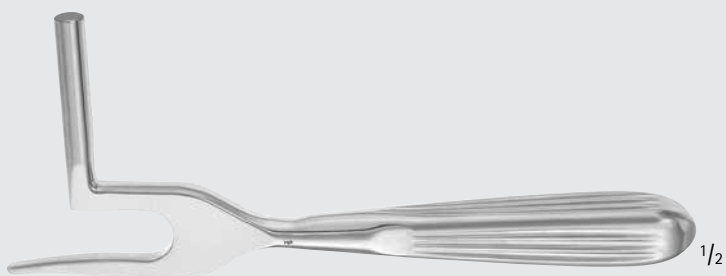

MA338R

### QUISLING Intranasal Hammer

Catalog Number	Length (in.)
MA338R	6 3/4



FL093R-FL096R

### Bone Tamp

Catalog Number	Diameter (mm)	Length (in.)
FL093R	3	6 1/4
FL094R	5	6 1/4
FL095R	7	6 1/4
FL096R	9	6 1/4



FL093R



FL094R



FL095R



FL096R

ENT  
NASAL



MA589R-MA593R



MA589R



MA588R



MA592R



MA593R



FK651R-FK654R



FK651R



FK652R



FK653R



FK654R



MA591R



MA591R



MA590R



MA590R

Antrum Curette

Catalog Number	Tip	Tip Size (mm)	Length in.)
MA589R	OBLONG	-	7 1/2
MA588R	OVAL CUP	7 x 11	7 1/2
MA592R	OVAL CUP	8 x 11	7 1/2
MA593R	OVAL CUP	9 x 13	7 1/2
FK651R	OVAL CUP, ANG	9.5 x 4	7 1/2
FK652R	OVAL CUP, ANG	6 x 3	7 1/2
FK653R	55° CVD	6 x 3	7 1/2
FK654R	90° CVD	6 x 3	7 1/2
MA591R	BACKWARD CUTTING	7 x 10	7 1/2
MA590R	FORWARD CUTTING	7 x 10	7 1/2

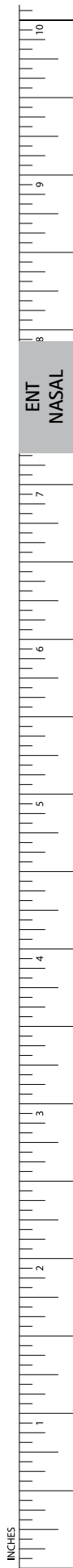

ENT  
NASAL

INCHES

# ENT-NASAL

## Curettes



FK817R



FK817R

### BARTH Bone Curette, Double Ended

Catalog Number	Tip Size (mm)	Length (in.)
FK817R	2.3 x 6.0 / 2.7 x 7.0	7



OK811R-OK816R



OK811R



OK812R



OK813R



OK814R



OK815R



OK816R

### COAKLEY Antrum Curette

Catalog Number	Blade	Size (#)	Length (in.)
MB799R	-	SET OF 6 INCLUDES OK811R- OK816R	-
OK811R	SLIGHT ANG	1	6 3/4
OK812R	45°	2	6 3/4
OK813R	REV ANG	3	6 3/4
OK814R	SLIGHT ANG	4	6 3/4
OK815R	45°	5	6 3/4
OK816R	45°	6	6 3/4

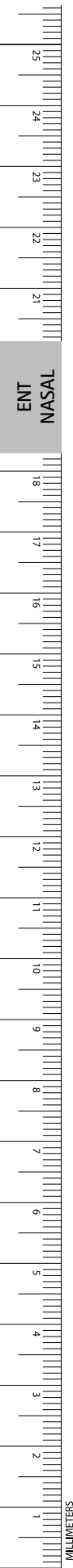



FK813R

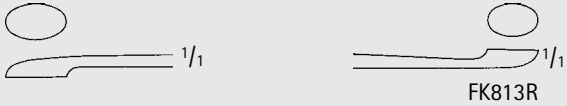

JACOBSON Bone Curette, Double Ended

Catalog Number	Tip Size (mm)	Length (in.)
FK813R	4.3 x 6.5 / 4.5 x 8.5	5 1/2



FK803R

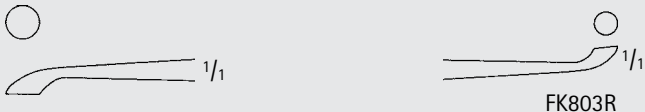

JANSEN Bone Curette, Double Ended

Catalog Number	Diameter (mm)	Length (in.)
FK803R	4.3 / 3.6	6 1/4



FK840R

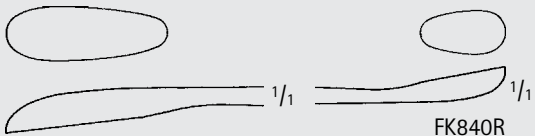

VOLKMANN Bone Curette, Double Ended

Catalog Number	Tip Size (mm)	Length (in.)
FK840R	7.5 x 21.0 / 6.0 x 11.0	5 1/8
FK842R	7.5 x 21.0 / 6.0 x 11.0	6 3/4



FK842R

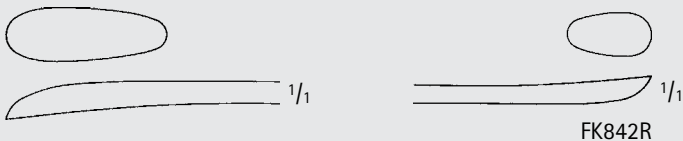

WILLIGER Bone Curette, Double Ended



FK814R

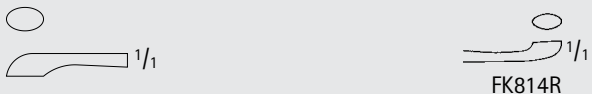

Catalog Number	Tip Size (mm)	Length (in.)
FK814R	2.0 x 3.5 / 3.0 x 4.5	5 3/4

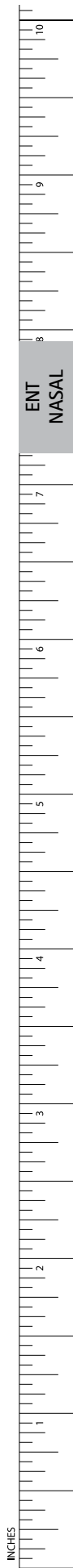

# ENT-NASAL

## Curettes

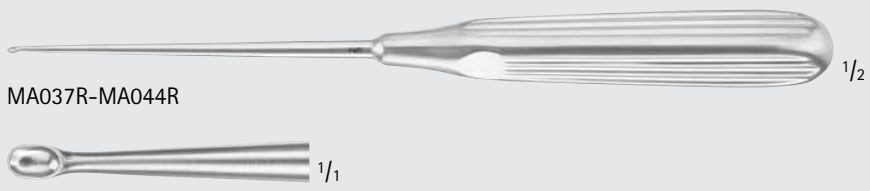

### LEMPERT Bone Curette

Catalog Number	Size (#)	Length (in.)
MA037R	000000	8
MA038R	00000	8
MA039R	0000	8
MA044R	2	8

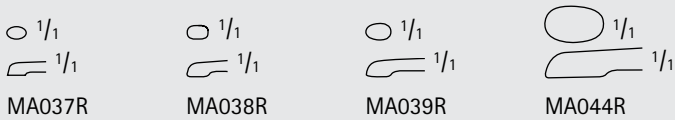

MA037R

MA038R

MA039R

MA044R

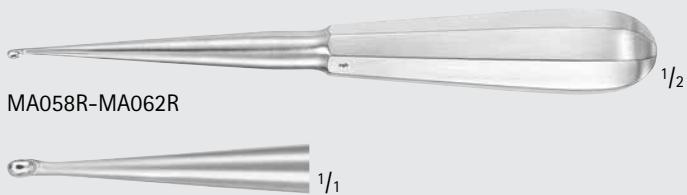

### SPRATT Mastoid Curettes

Catalog Number	Tip Size (mm)	Size (#)	Length (in.)
MA058R	2.5 x 4	00	6 1/2
MA059R	3 x 5	0	6 1/2
MA060R	3.5 x 6	1	6 1/2
MA061R	4.5 x 8	3	6 1/2
MA062R	5.5 x 9	4	6 1/2

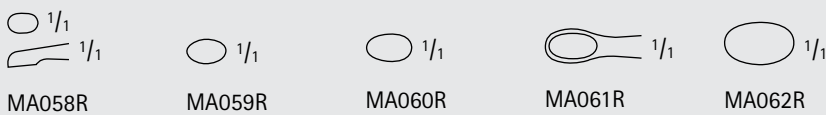

MA058R

MA059R

MA060R

MA061R

MA062R

ENT  
NASAL

MILLIMETERS

ALEXANDER Bone Rongeur

Catalog Number	Jaw Size (mm)	Jaw	Length (in.)
FO440R	3.2 x 27	ANG	5 1/2



FO440R



FO440R

BANE-HARTMANN Bone Rongeur

Catalog Number	Jaw Size (mm)	Jaw	Length (in.)
FO457R	4.0 x 32	CVD	6 7/8

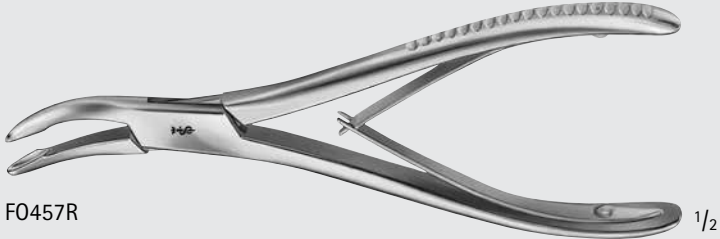

FO457R



FO457R

BEYER Bone Rongeur

Catalog Number	Jaw Size (mm)	Jaw	Handle	Length (in.)
FO453R	3.2 x 32	CVD	Single Action	7
FO514R	4.0 x 30	CVD	Double Action	7

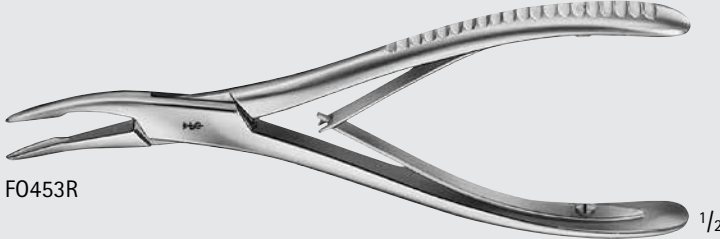

FO453R



FO453R



FO514R

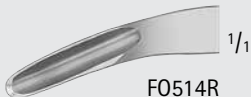

FO514R

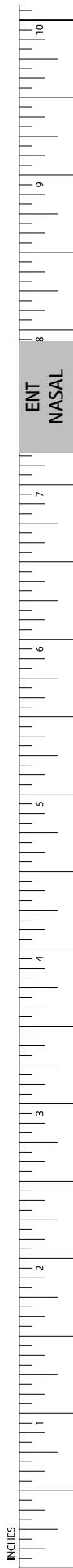

# ENT-NASAL

## Rongeurs

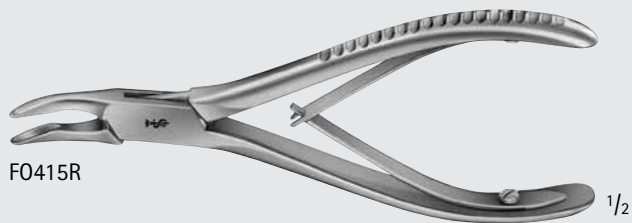

FO415R



FO415R

### BLUMENTHAL Bone Rongeur

Catalog Number	Jaw Size (mm)	Jaw	Length (in.)
FO415R	3.5 x 25	CVD	6 1/8

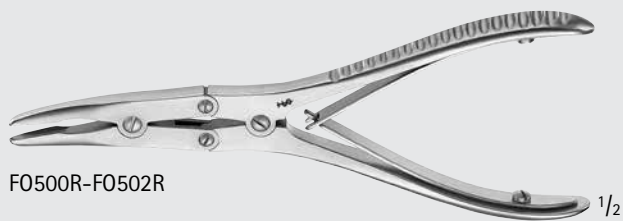

FO500R-FO502R



FO500R



FO502R

### BOEHLER Bone Rongeur, Double Action

Catalog Number	Jaw Size (mm)	Jaw	Jaw End	Length (in.)
FO500R	3.0 x 27	CVD	NARR	6 1/8
FO502R	3.5 x 30	CVD	WIDE	6 1/8

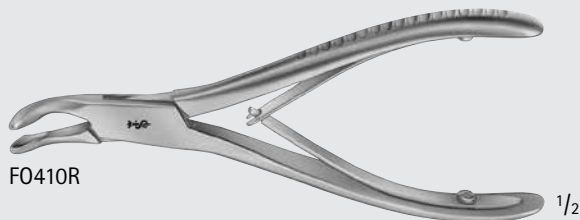

FO410R



FO410R

### Bone Rongeur

Catalog Number	Jaw Size (mm)	Jaw	Length (in.)
FO410R	3.8 x 19	CVD	5 1/2

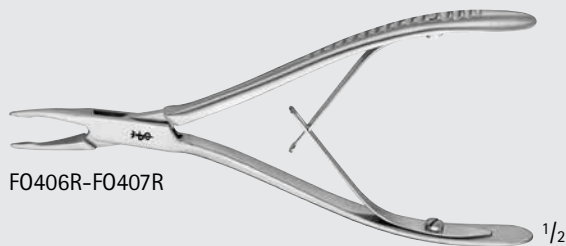

FO406R-FO407R



FO406R



FO407R

### FRIEDMANN Micro Rongeur

Catalog Number	Jaw Size (mm)	Jaw	Length (in.)
FO406R	1.3 x 19	STR	5 1/2
FO407R	1.3 x 20	CVD	5 1/2

ENT  
NASAL

MILLIMETERS

JANSEN Bone Rongeur

Catalog Number	Jaw Size (mm)	Jaw	Length (in.)
FO430R	4.2 x 35	STR	6 7/8
FO432R	4.5 x 30	CVD	6 7/8
FO442R	3.8 x 37	ANG	7 1/2



FO430R-FO432R



FO430R



FO432R

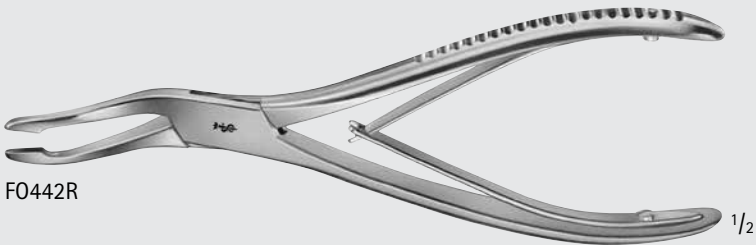

FO442R

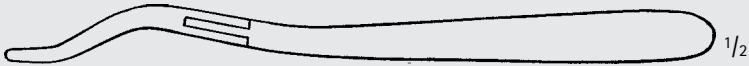

FO442R

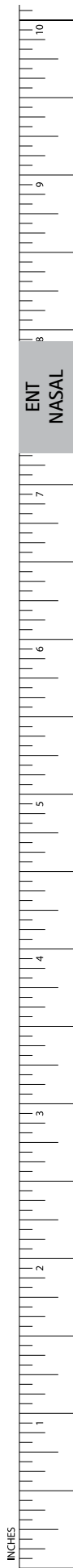

# ENT-NASAL

## Rongeurs

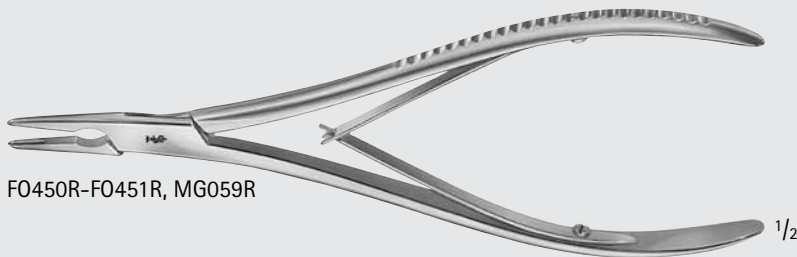
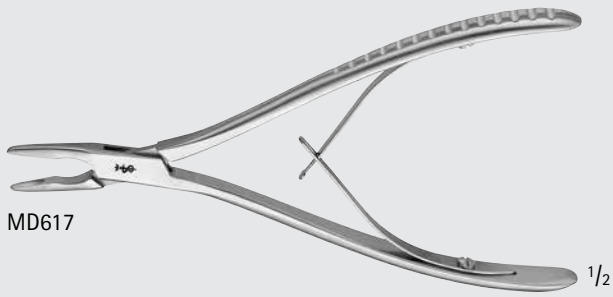

### LEMPERT Bone Rongeur

Catalog Number	Jaw Size (mm)	Jaw	Length (in.)
MD617	2.0 x 23	DEL, STR	6 1/2
FO450R	2.2 x 27	STR	7 7/8
MG059R	2.5 x 30	CVD	6 1/4
FO451R	2.2 x 27	CVD	7 7/8

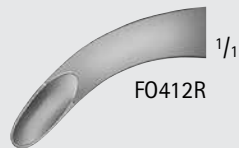
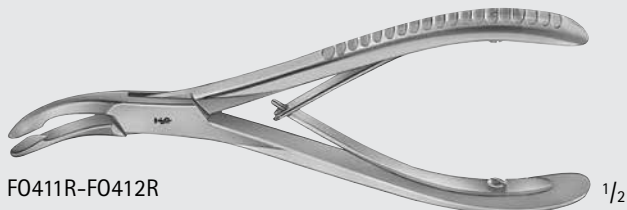

### LUER Bone Rongeur

Catalog Number	Jaw Size (mm)	Jaw	Length (in.)
FO411R	4.2 x 20	CVD	6
FO412R	4.2 x 26	STRONG CVD	6 1/8

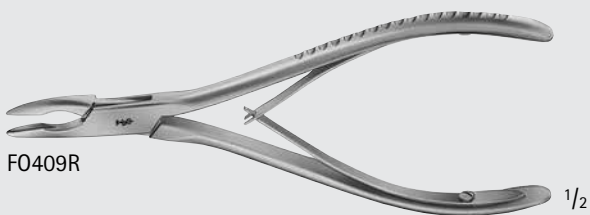

### LUER-FRIEDMANN Bone Rongeur

Catalog Number	Jaw Size (mm)	Jaw	Length (in.)
FO409R	2.2 x 22	CVD	5 3/4

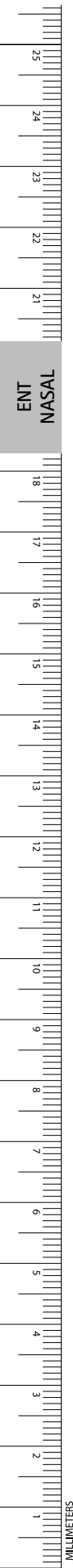

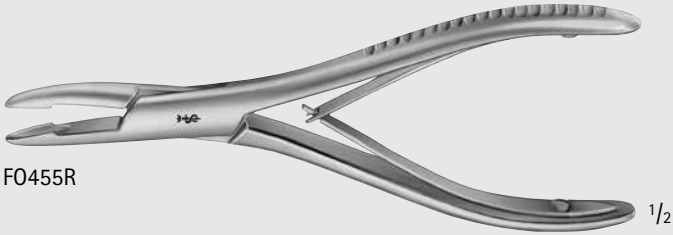

FO455R

1/2



1/1

FO455R

MEAD Bone Rongeur

Catalog Number	Jaw Size (mm)	Jaw	Length (in.)
FO455R	3.5 x 30	CVD	6 1/2



FO515R

1/2



1/1

FO515R

ZAUFAL-JANSEN Bone Rongeur, Double Action

Catalog Number	Jaw Size (mm)	Jaw	Length (in.)
FO515R	4.5 x 29	CVD	7



INCHES

ENT-NASAL

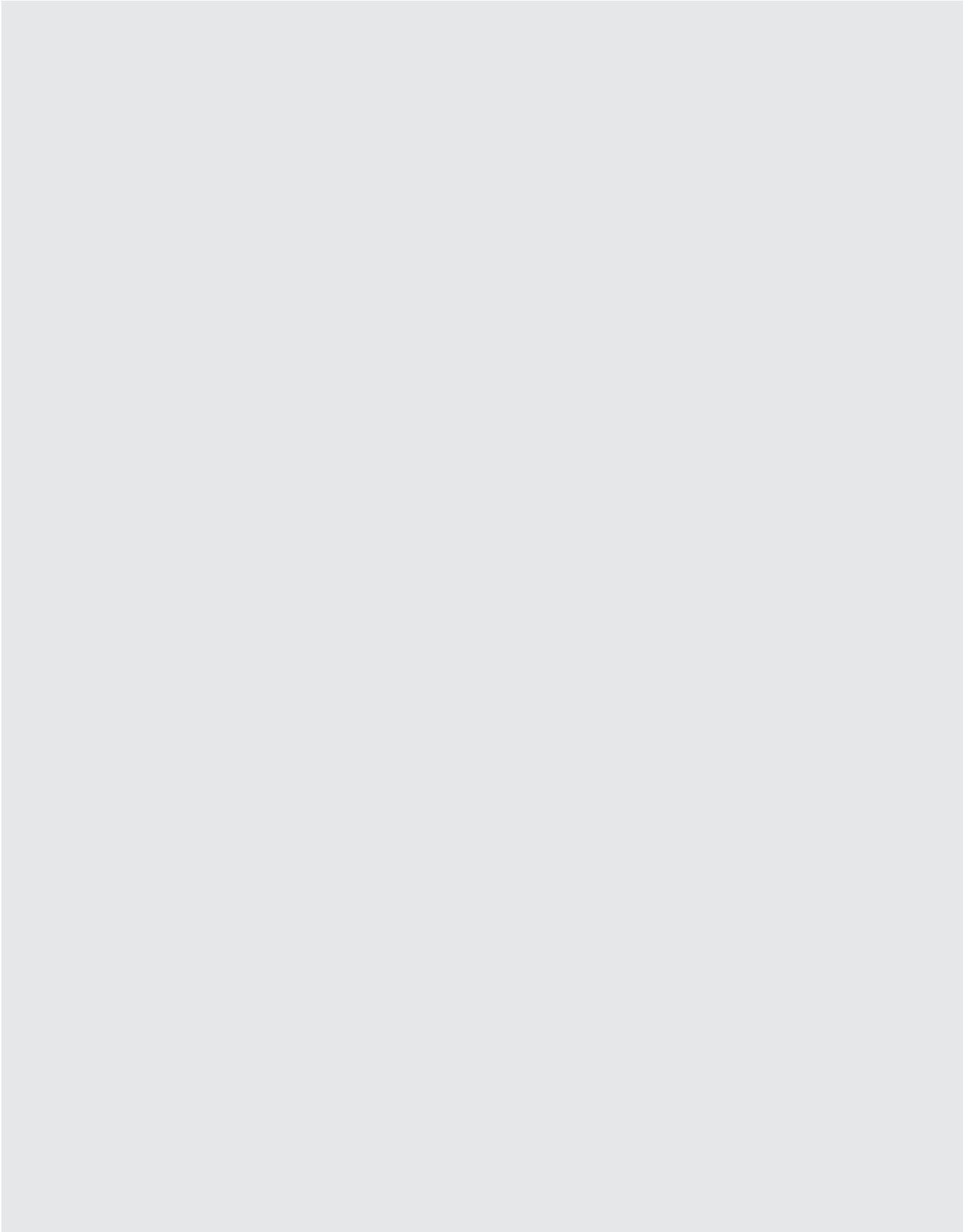
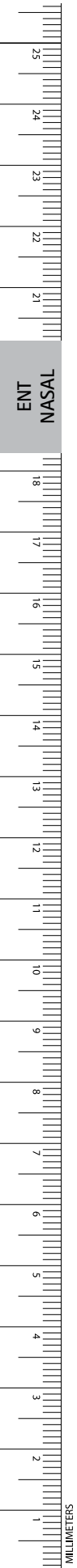



## ENT-ORAL

Scissors .....	706 - 708
Needles .....	709
Forceps .....	709 - 712
Clamps .....	713 - 719
Tracheal Dilators / Hooks / Retractors .....	720 - 721
Retractors .....	722 - 724
Tonsil Dissectors .....	725
Adenotomes, Tonsil Snares and Wires .....	726 - 728
Mouth Gags .....	729 - 737
Tonsil Knives .....	738
Suction Tubes .....	739
Adenoid Currettes .....	740 - 742
Syringes .....	743
Laryngeal Mirrors .....	744
Amalgam Carriers .....	745

# ENT-ORAL

## Oral Scissors

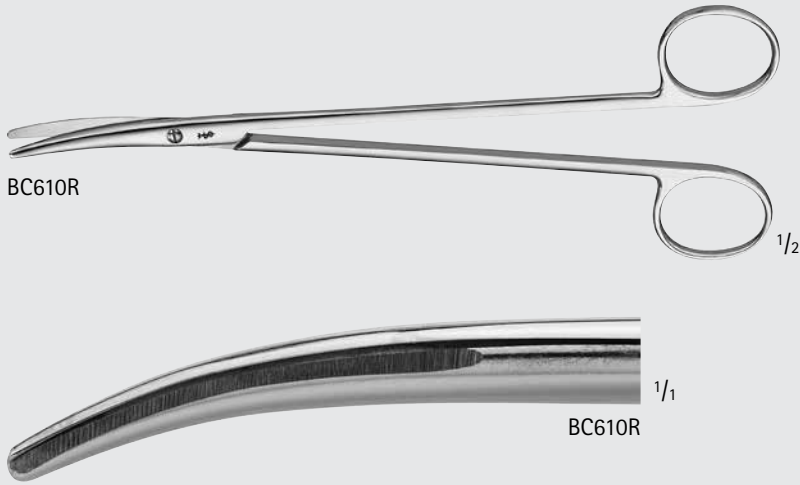

### LILLIE Dissecting Scissors

Catalog Number	Tip	Blade	Length (in.)
BC610R	B/B	CVD	7 7/8

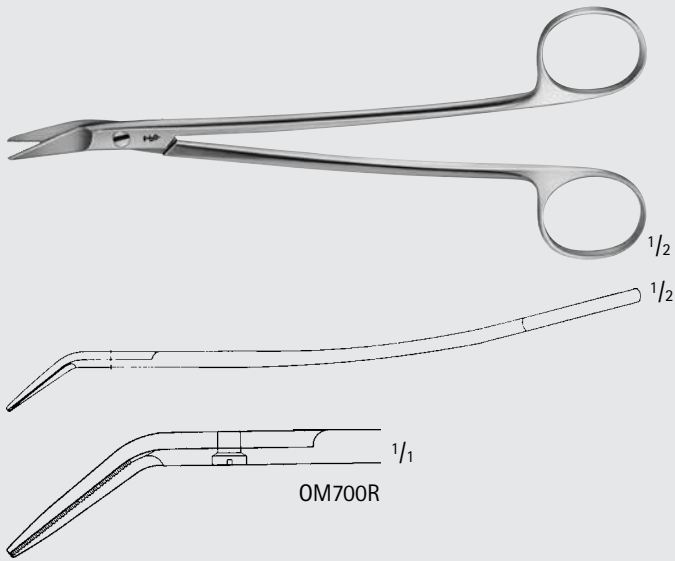

### DEAN Tonsil Scissors

Catalog Number	Tip	Blade	Length (in.)
OM700R	B/B	ANG-SERR	6 3/4

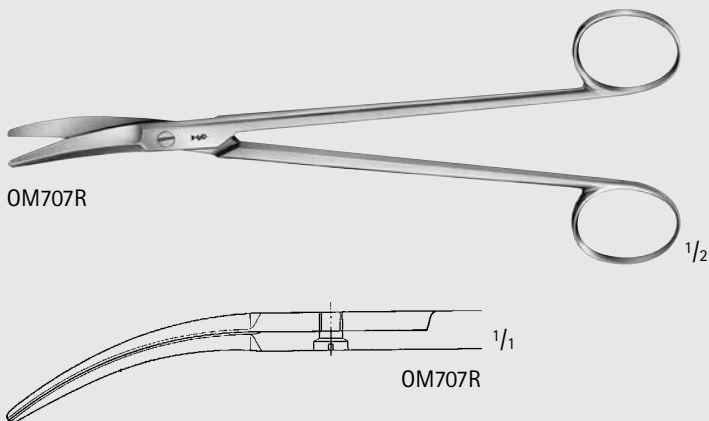

### BOETTCHER Tonsil Scissors

Catalog Number	Tip	Blade	Length (in.)
OM707R	B/B	CVD	7

ENT  
ORAL

MILLIMETERS

**BROPHY Gum Scissors**

Catalog Number	Tip	Blade	Length (in.)
MA445R	S/S	CVD	5 1/2

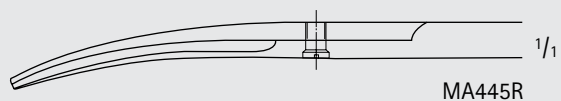
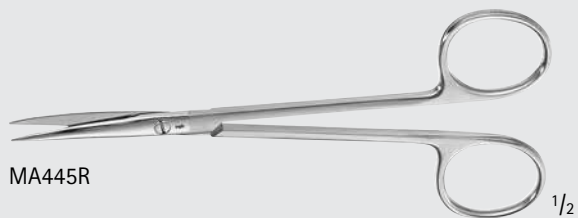

**DUROTIP™ Tungsten Carbide Scissors**

- Excellent cutting accuracy
- Long working life
- Gold-plated rings

**DUROTIP TC Gum Scissors, Delicate**

Catalog Number	Tip	Blade	Length (in.)
DO208R	S/S	STR	4 3/4
DO209R	S/S	CVD	4 3/4

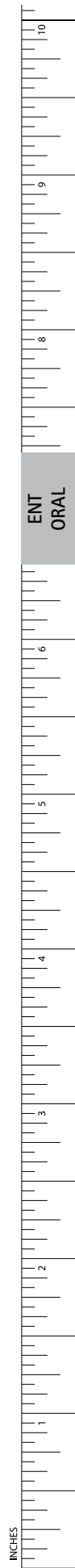
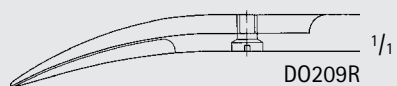
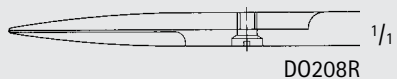
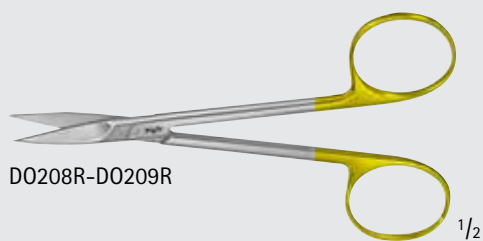

# ENT-ORAL

## Laryngeal Scissors

### Micro Laryngeal Scissors, W/ Flush Port

Catalog Number	Tip	Blade	Working Length (in.)
OP310R	S/S	STR	9 3/4
OP311R	S/S	CVD-LEFT	9 3/4
OP312R	S/S	CVD-RIGHT	9 3/4
OP313R	S/S	ANG-UP	9 3/4

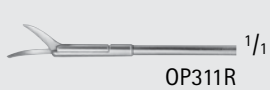
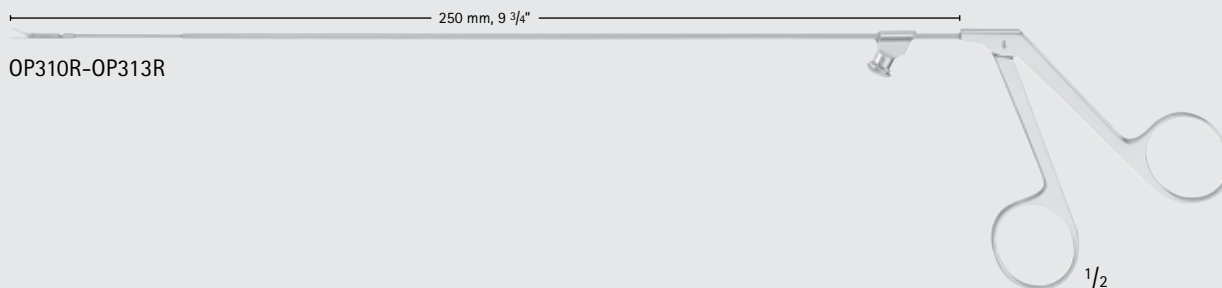

### KLEINSASSER Micro Scissors

Catalog Number	Tip	Blade	Blade Size (mm)	Working Length (in.)
MA460R	B/B	STR	4	14

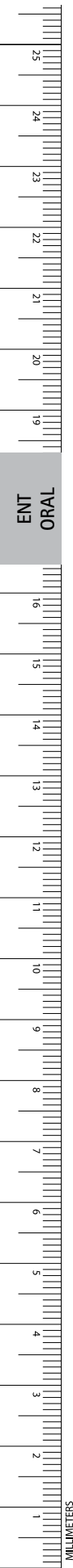
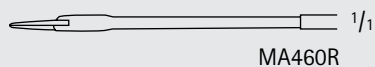
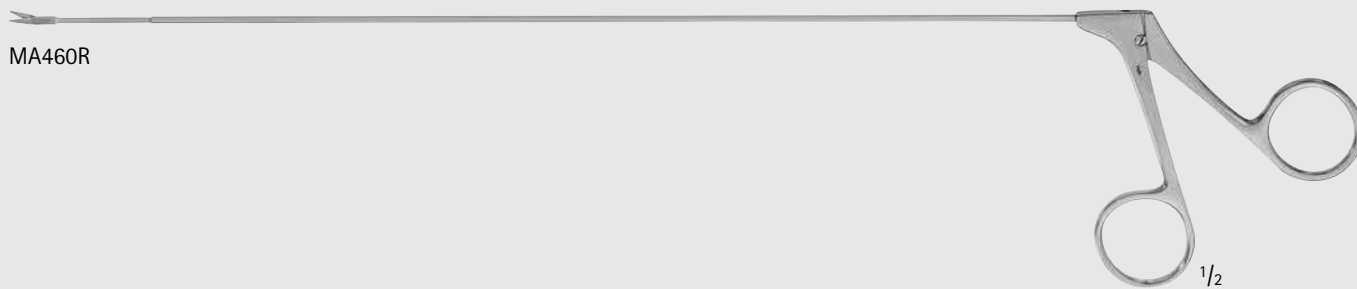

MILLIMETERS

# ENT-ORAL

## Needles and Forceps

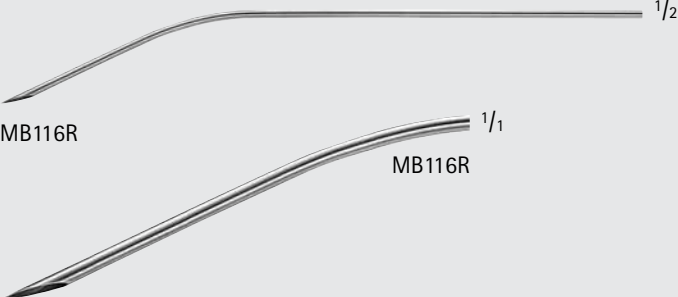

MB116R 1/2

MB116R 1/1

**DINGMAN Wire Passing Needle**

Catalog Number	Tip	Length (in.)
MB116R	CVD	6 3/4

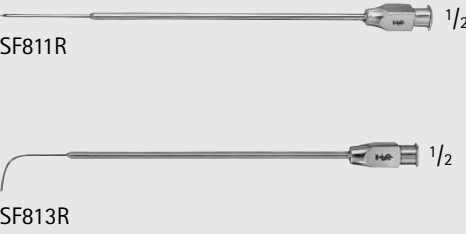

SF811R 1/2

SF813R 1/2

**Tonsil Needle, 23 Gauge**

Catalog Number	Tip	Tip Size (mm)	Length (in.)
SF811R	STR	DIAM. 0.8	3
SF813R	CVD	DIAM. 0.8	3

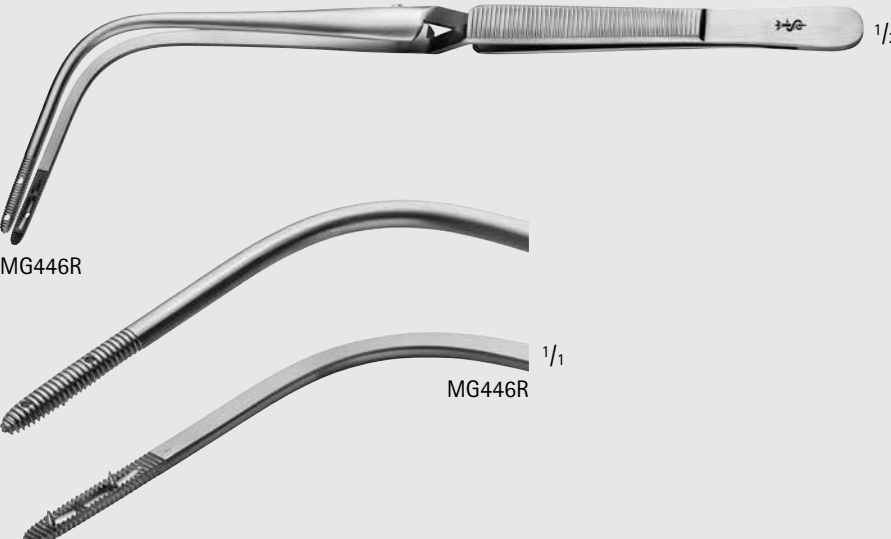

MG446R 1/2

MG446R 1/1

MG446R 1/1

**JACKSON Laryngeal Self-Closing Dressing Forceps**

Catalog Number	Tip	Teeth	Length (in.)
MG446R	SERR	1 x 2	9



ENT  
ORAL

INCHES

# ENT-ORAL

## Forceps

### Laryngeal Forceps, W/ Flush Port

Catalog Number	Jaw	Working Length (in.)
OP300R	STR	9 3/4
OP301R	CVD-LEFT	9 3/4
OP302R	CVD-RIGHT	9 3/4

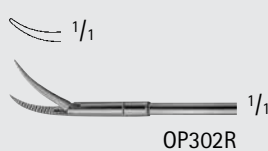
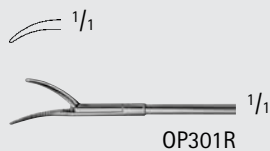
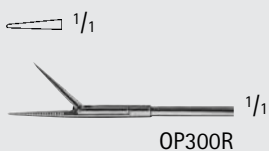
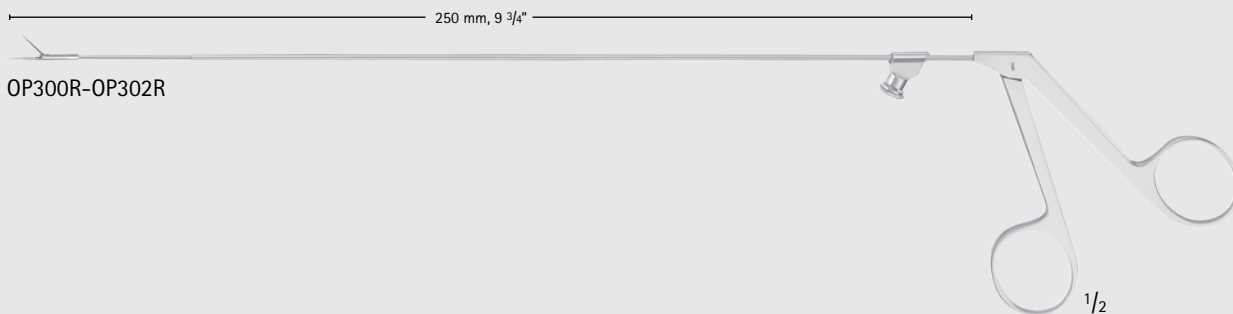

### Micro Laryngeal Cup Forceps, W/ Flush Port

Catalog Number	Cup Size (mm)	Jaw	Working Length (in.)
OP304R	2	STR	9 3/4
OP305R	2	ANG-LEFT	9 3/4
OP306R	2	ANG-RIGHT	9 3/4
OP307R	2	ANG-UP	9 3/4

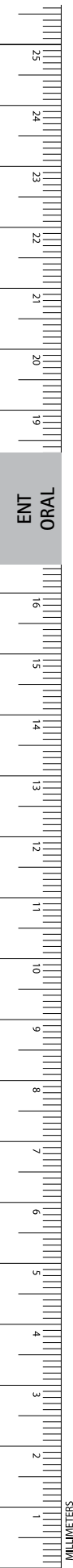
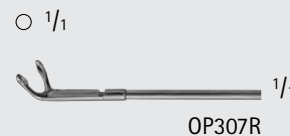
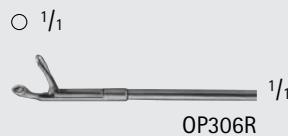
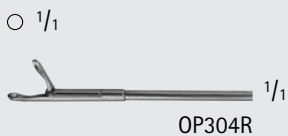
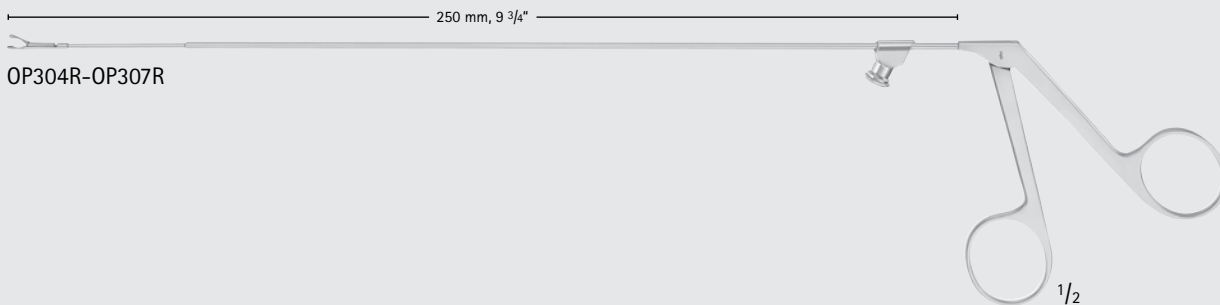

ENT  
ORAL

MILLIMETERS

Alligator Grasping Forceps

Catalog Number	Tip	Tip Size (mm)	Working Length (in.)	Length (in.)
MA663R	SERR	8.8 x 4	11	13 3/4

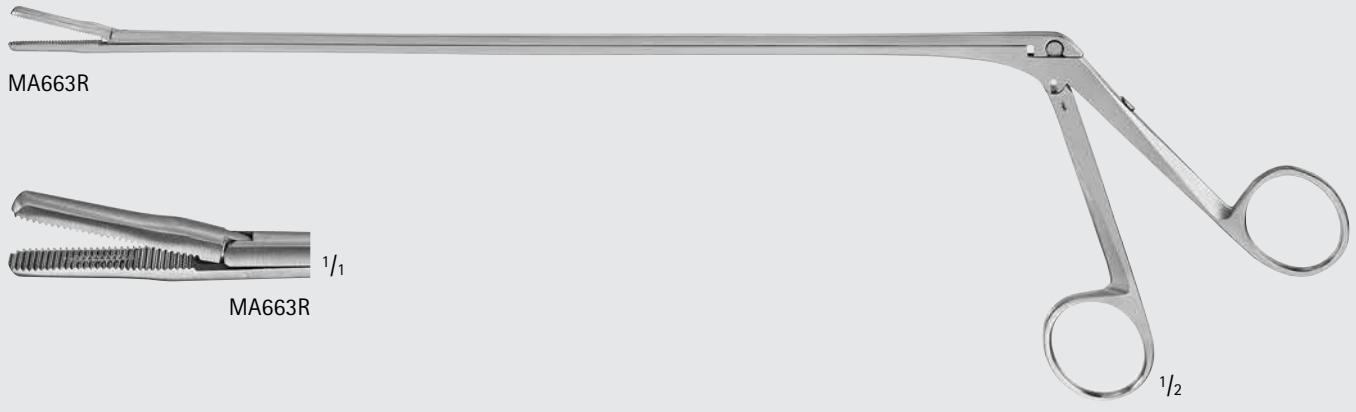

# ENT-ORAL

## Forceps

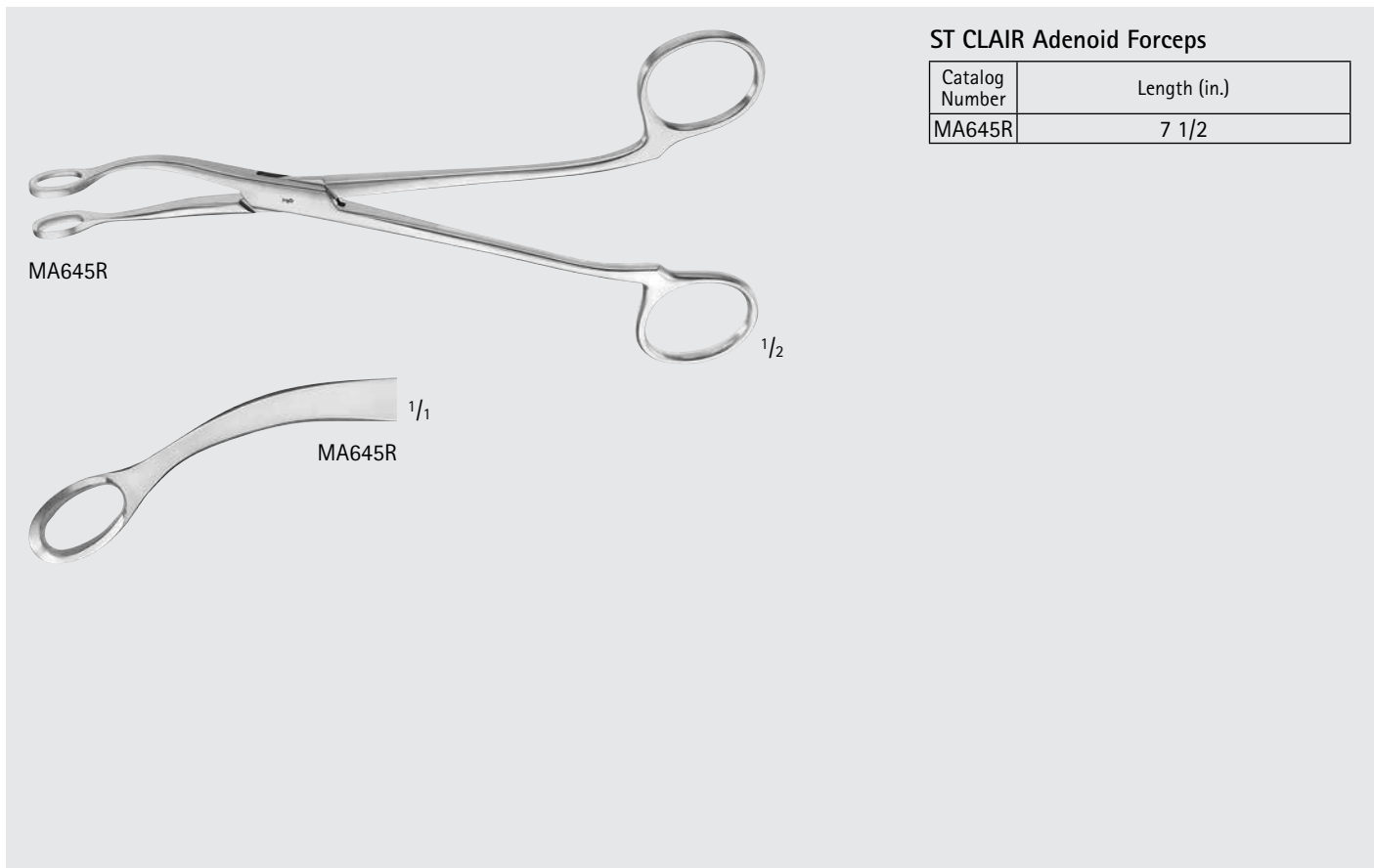
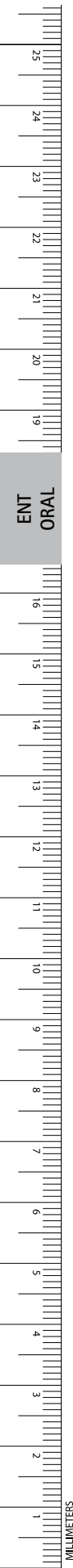

### ST CLAIR Adenoid Forceps

Catalog Number	Length (in.)
MA645R	7 1/2

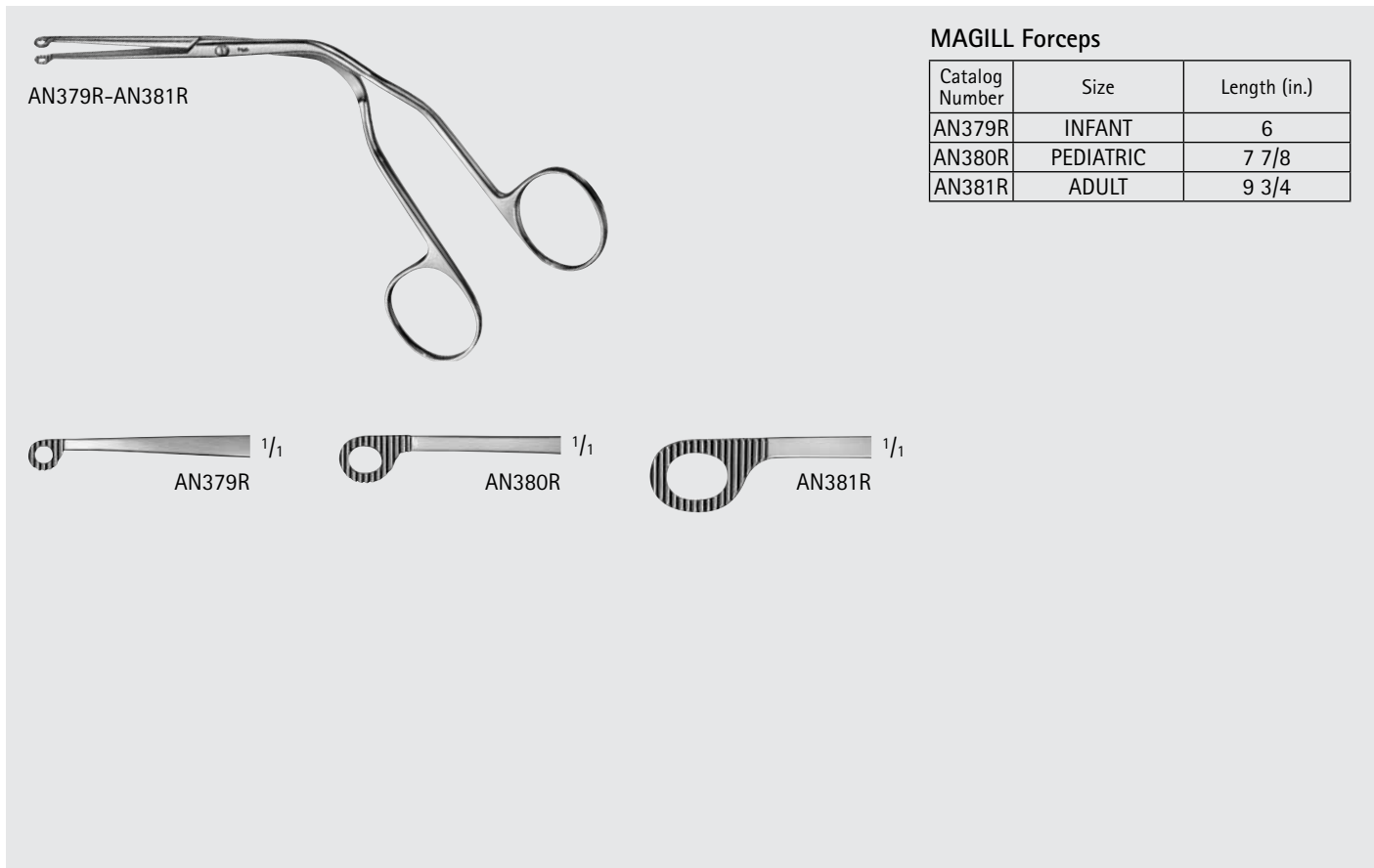

### MAGILL Forceps

Catalog Number	Size	Length (in.)
AN379R	INFANT	6
AN380R	PEDIATRIC	7 7/8
AN381R	ADULT	9 3/4

SCHNIDT Tonsil Clamp

Catalog Number	Ring Handle	Jaw	Length (in.)
MA172R	OPEN RING	STR	7 1/2
BH961R	OPEN-RING	SLIGHT-CVD	7 1/4
BH963R	OPEN-RING	CVD	7 1/4
BH957R	CLOSED-RING	SLIGHT-CVD	7 1/4
BH959R	CLOSED-RING	CVD	7 1/4

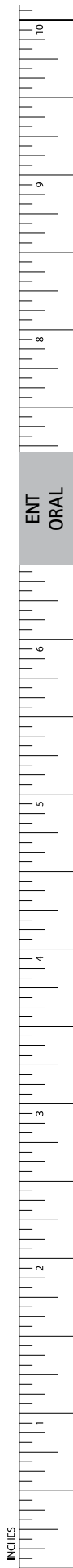
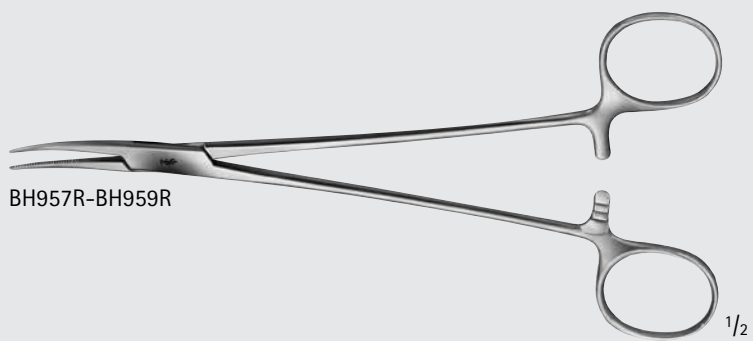
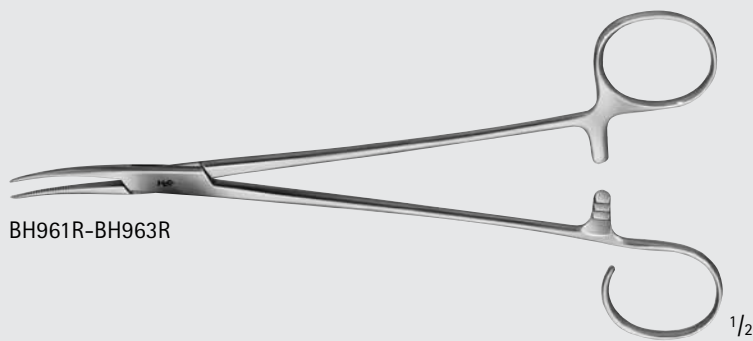
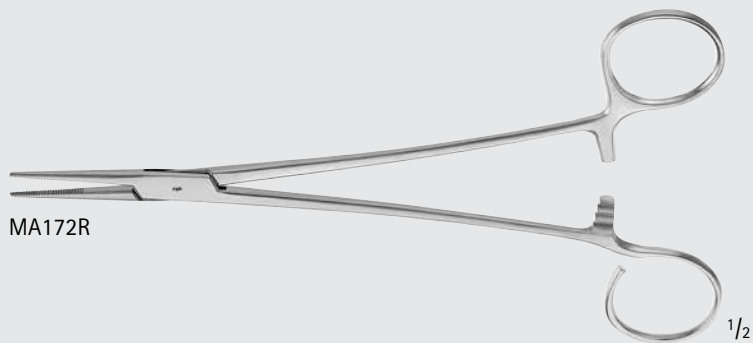

# ENT-ORAL

## Clamps

### Tonsil Clamp, X-long

Catalog Number	Jaw	Length (in.)
MB103R	CVD	14 1/2

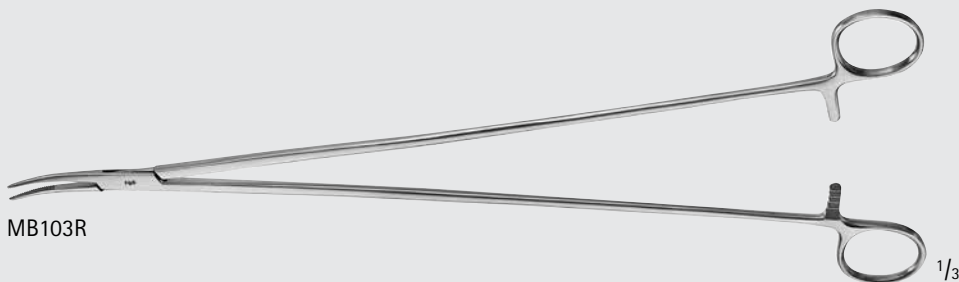

MB103R

1/3



MB103R

1/1

### ADSON Tonsil Clamp, Delicate

Catalog Number	Jaw	Length (in.)
BH200R	STR	7 1/4
BH201R	CVD	7 1/4

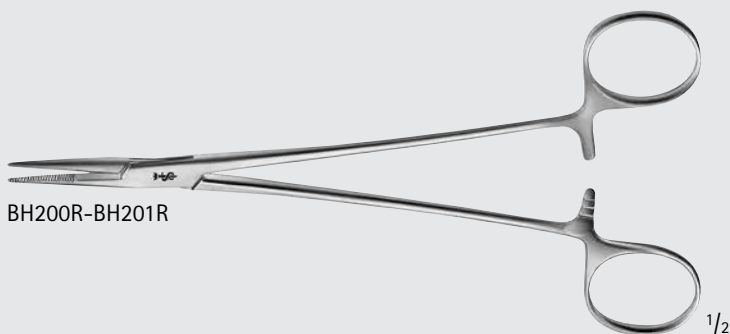

BH200R-BH201R

1/2



BH200R

1/1



BH201R

1/1

### NISSEN Tonsil Clamp, Delicate

Catalog Number	Jaw	Length (in.)
BH199R	CVD	7 1/4

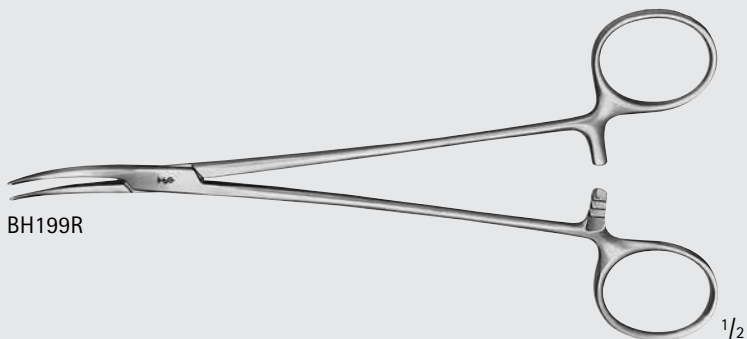

BH199R

1/2



BH199R

1/1

ENT  
ORAL

MILLIMETERS

NEGUS Tonsil Clamp

Catalog Number	Jaw	Length (in.)
BH951R	HEAVY-CVD	7 1/2
BH952R	U-CVD	7 1/2

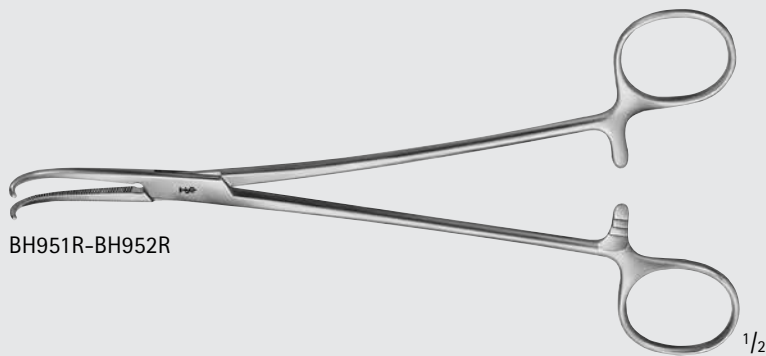

BH951R-BH952R

1/2

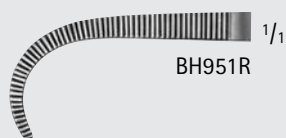

BH951R

1/1

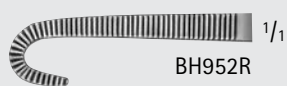

BH952R

1/1

MCHENRY Tonsil Artery and Sponge Holding Clamp

Catalog Number	Jaw	Length (in.)
MB533R	CVD	8

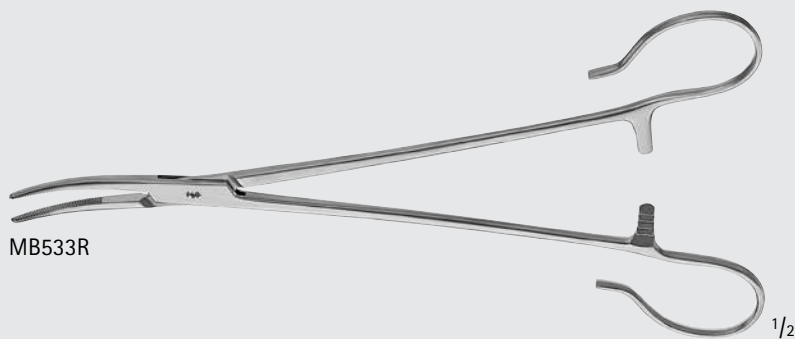

MB533R

1/2

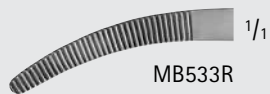

MB533R

1/1

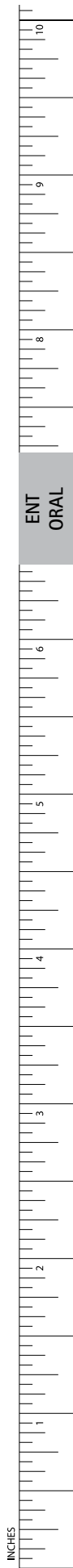

# ENT-ORAL

## Clamps

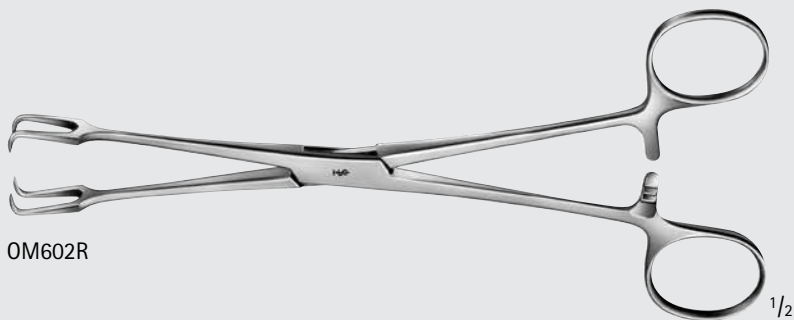

OM602R

1/2

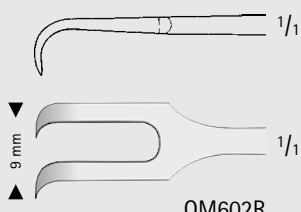

OM602R

### MUSEUX Tonsil Clamp

Catalog Number	Tip	Length (in.)
OM602R	2 x 2	7 7/8



OM612R

1/2



OM612R

### WHITE Tonsil Seizing Clamp

Catalog Number	Length (in.)
OM612R	7
OM613R	9 1/4

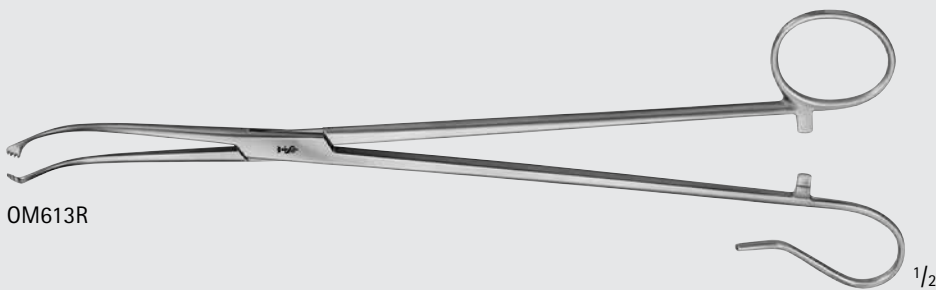

OM613R

1/2



OM613R

ENT ORAL

MILLIMETERS

**ALLIS-COAKLEY Tonsil Clamp**

Catalog Number	Jaw	Length (in.)
MA539R	STR	7 7/8
MA540R	STRONG CVD	7 5/8

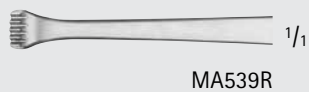
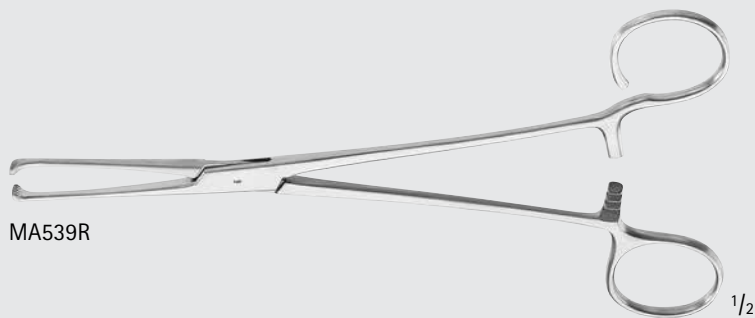

**COLVER Tonsil Seizing Clamp**

Catalog Number	Length (in.)
OM611R	7 7/8

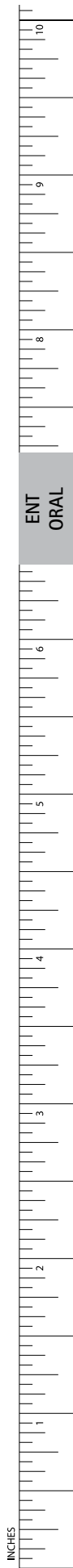

# ENT-ORAL

## Clamps

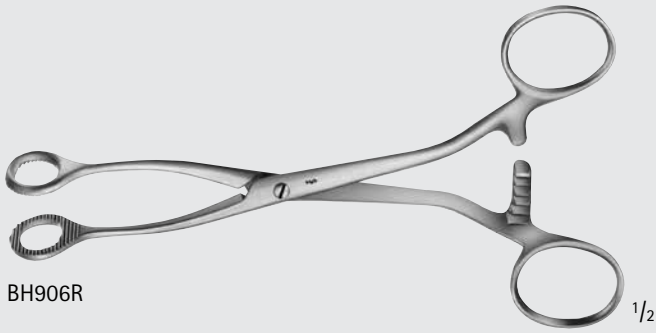

BH906R

1/2

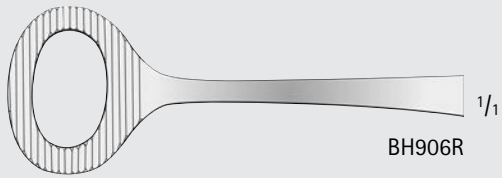

BH906R

1/1

### COLLIN Tongue Clamp

Catalog Number	Jaw	Length (in.)
BH906R	OVAL	6 1/4

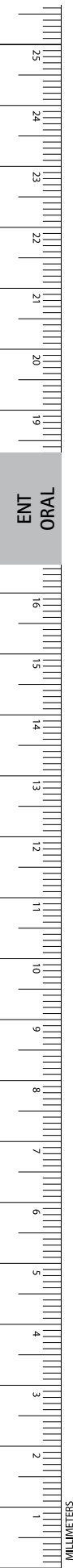

MILLIMETERS

HEYWOOD-SMITH Tongue Clamp

Catalog Number	Tip	Length (in.)
AN710R	SERR	7 7/8
AN711R	SERR	8 1/4

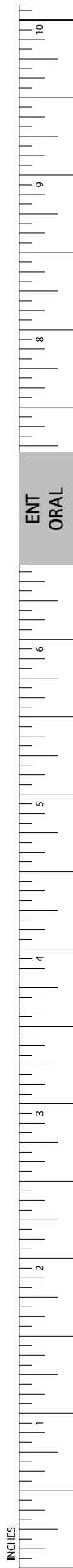
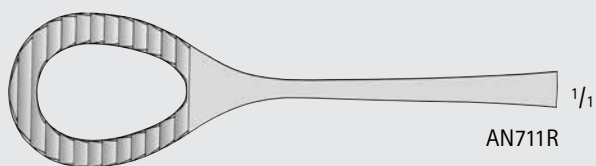
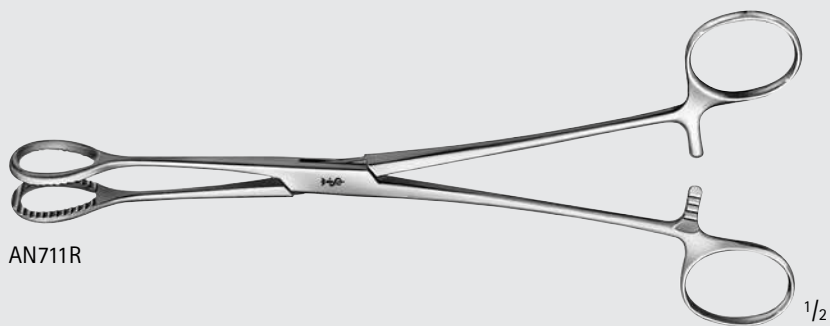
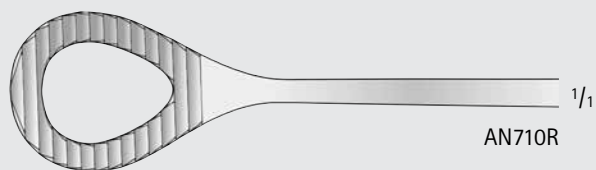
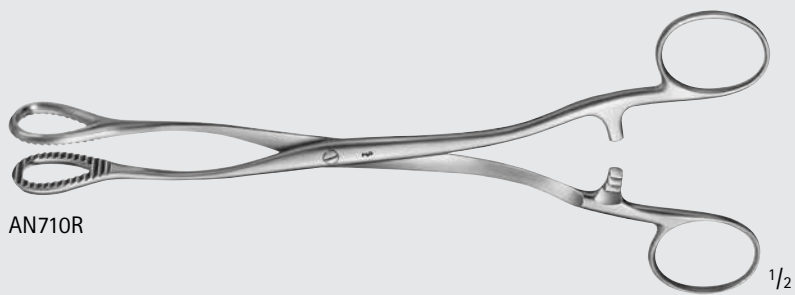

# ENT-ORAL

## Tracheal Dilators/Hooks/Retractors



FA025R

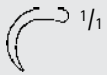

FA026R

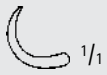

### BOSE Tracheal Hook

Catalog Number	Tip	Length (in.)
FA025R	CVD-LEFT	6 1/2
FA026R	CVD-RIGHT	6 1/2



BT103R-BT107R



BT103R



BT106R



BT107R

### Tracheal Retractor

Catalog Number	Tip	Blade End	Length (in.)
BT103R	SHARP	1 PRONG	7
BT106R	BLUNT	1 PRONG	7
BT107R	BLUNT	2 PRONGS	7



MB230



1/1



1/1

MB230

### JACKSON Tracheal Retractor

Catalog Number	Length (in.)
MB230	7





FA005R

TROUSSEAU Tracheal Dilator

Catalog Number	Length (in.)
FA005R	4 3/4

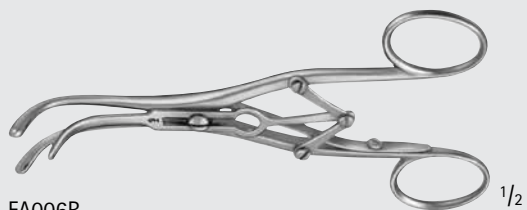

FA006R

LABORDE Tracheal Dilator

Catalog Number	Length (in.)
FA006R	5
FA007R	5 1/4

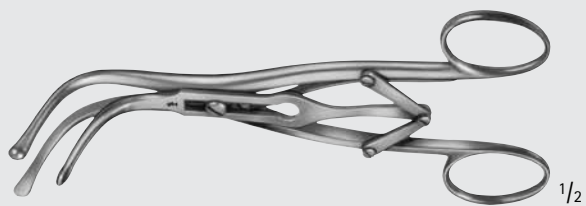

FA007R

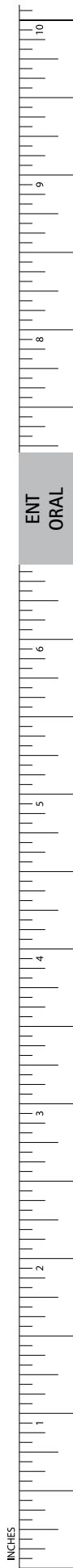

# ENT-ORAL

## Retractors

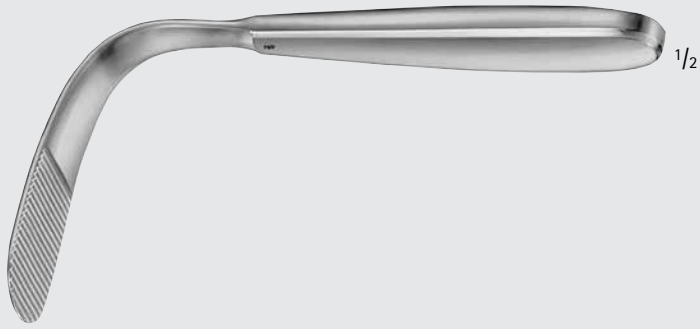

OM235R

### TOBOLD Tongue Depressor

Catalog Number	Length (in.)
OM235R	6 1/4



OM236R-OM237R

### WEDER Tongue Depressor

Catalog Number	Size	Length (in.)
OM236R	SMALL	5
OM237R	LARGE	5

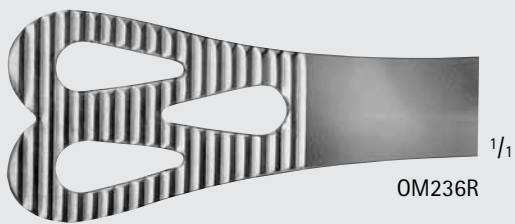

OM236R

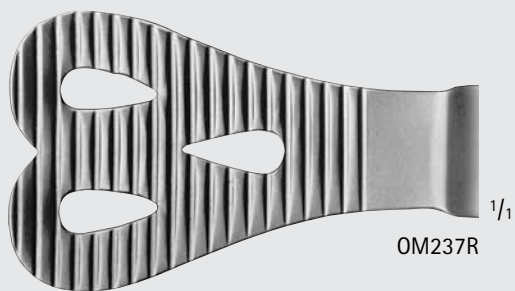

OM237R

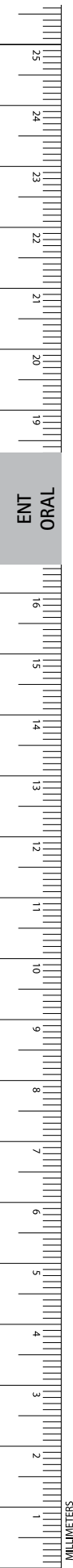

# ENT-ORAL

## Retractors

### LOTHROP Uvula Retractor

Catalog Number	Blade Size (mm)	Length (in.)
MA719R	17 x 20	9 5/8

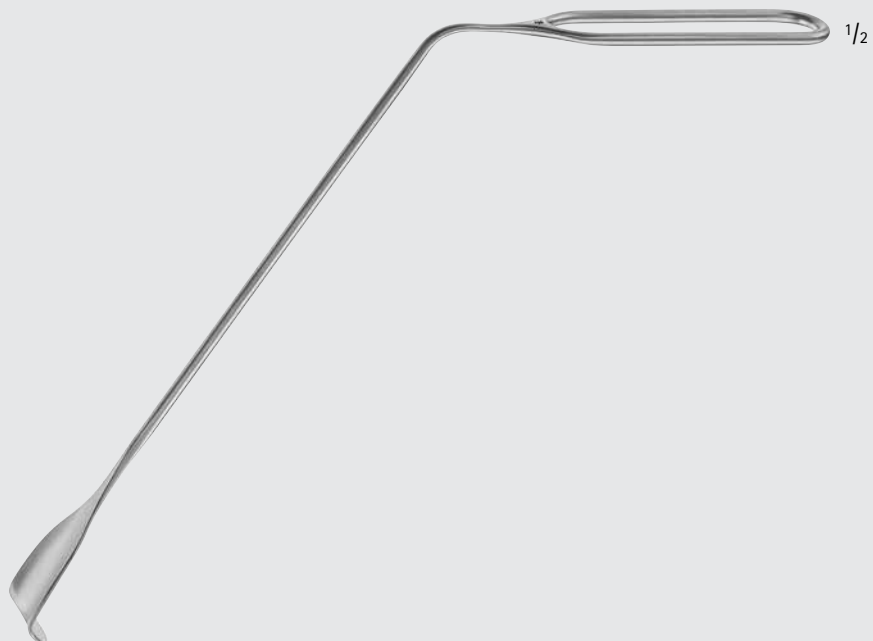

MA719R



MA719R

### GOODYEAR Uvula Retractor

Catalog Number	Blade Size (mm)	Length (in.)
MA608R	15	7 3/8



MA608R

### LAHEY Goiter Retractor

Catalog Number	Blade Size (mm)	Length (in.)
MB785R	24 x 8	7 7/8



MB785R



MB785R

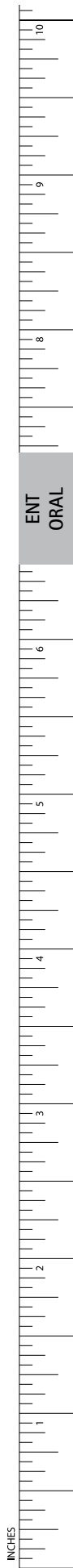

# ENT-ORAL

## Retractors



MA434R-MA437R

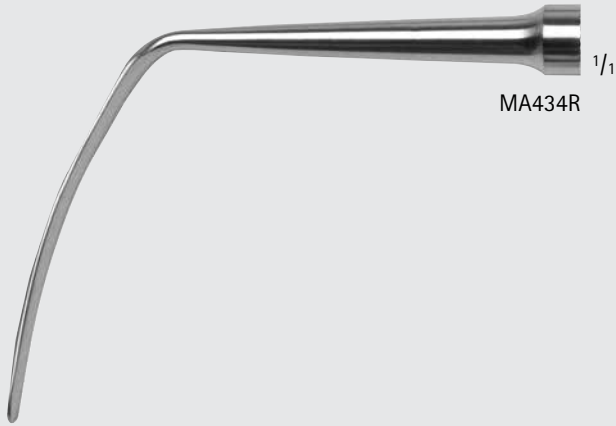

MA434R

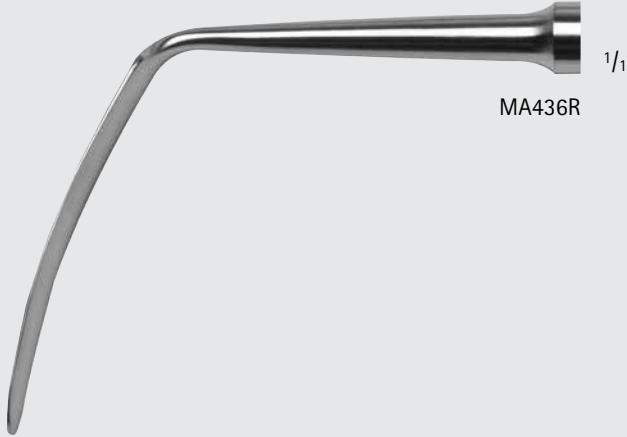

MA436R

### SEWALL Orbital Retractor

Catalog Number	Blade Size (mm)	Length (in.)
MA434R	7 x 52	6 3/4
MA435R	9 x 44	6 3/8
MA436R	11 x 50	6 3/8
MA437R	13 x 67	6 3/4



MA435R

ENT  
ORAL

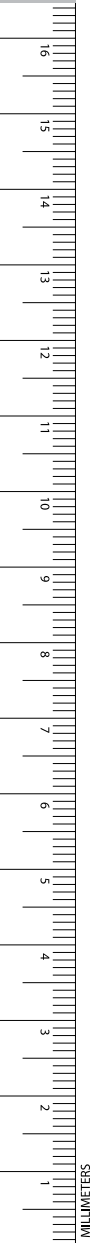

MILLIMETERS

# ENT-ORAL

## Tonsil Dissectors

### HURD Tonsil Dissector / Pillar Retractor

Catalog Number	Tip Size (mm)	Length (in.)
OM660R	6	8 1/2
OM661R	10	8 1/2

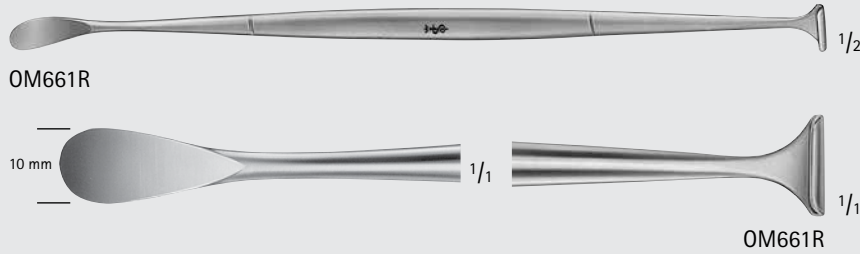
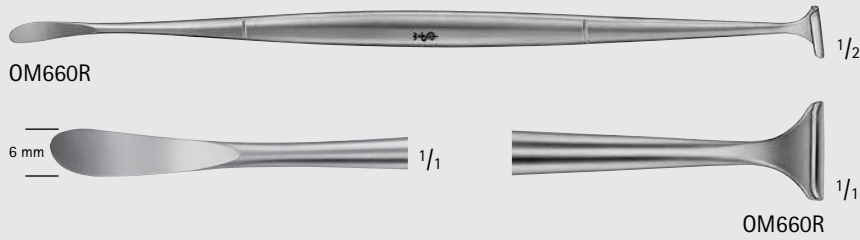

### HENKE Tonsil Dissector

Catalog Number	Tip Size (mm)	Length (in.)
OM668R	12	9 1/4

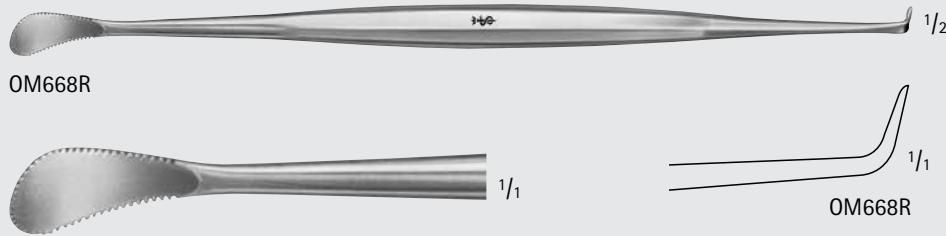

### LOTHROP Tonsil Knife and Dissector

Catalog Number	Length (in.)
MA289R	8 1/4

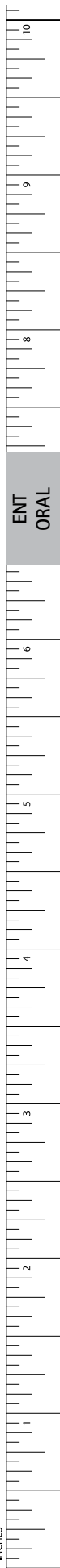

# ENT-ORAL

## Adenotomes/Tonsil Snares/Wires



OM391R-OM398R

### LA FORCE Adenotome

Catalog Number	Size (#)	Description	Length (in.)
OM391R	1	-	9 1/4
OM392R	2	-	9 1/4
OM393R	3	-	9 1/4
OM396R	-	SPARE BLADE F/ OM391R	-
OM397R	-	SPARE BLADE F/ OM392R	-
OM398R	-	SPARE BLADE F/ OM393R	-



OM396R



1/1

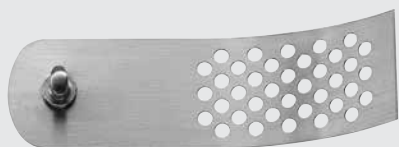

OM397R



1/1

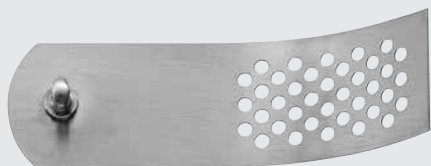

OM398R



1/1

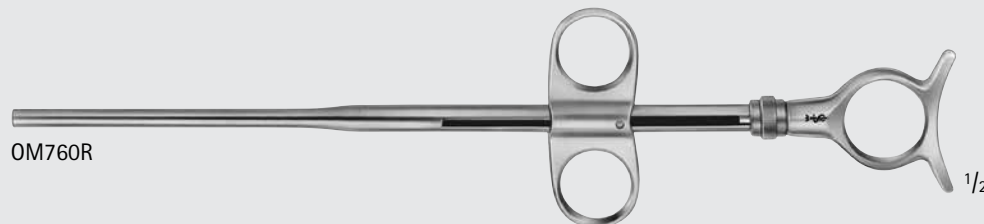

OM760R

### EVES Tonsil Snare W/ 25 Gauge Wire

Catalog Number	Description	Length (in.)
OM760R	W/O RATCHET	9 3/4
OM761R	W/ RATCHET	9 3/4



OM761R

ENT ORAL

MILLIMETERS

**LEWIS Tonsil Snare**

Catalog Number	Description	Length (in.)
MA714R	INCLUDES 12 #8 SNARE WIRES	10 1/4

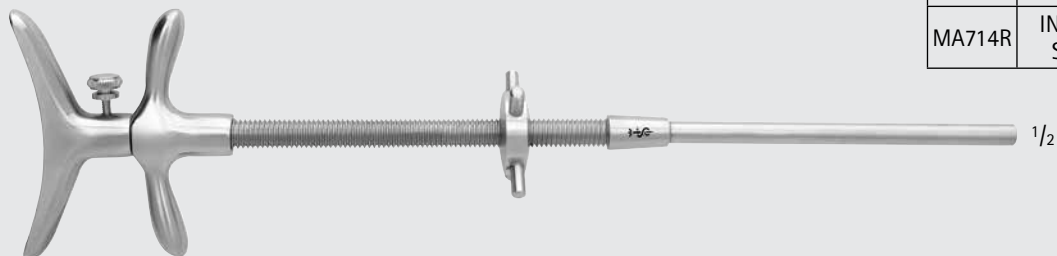

MA714R

**SAGE Tonsil Snare**

Catalog Number	Description	Length (in.)
MA493R	W/ SNARE WIRES	11
MA490R	12 #6 SNARE WIRES	4

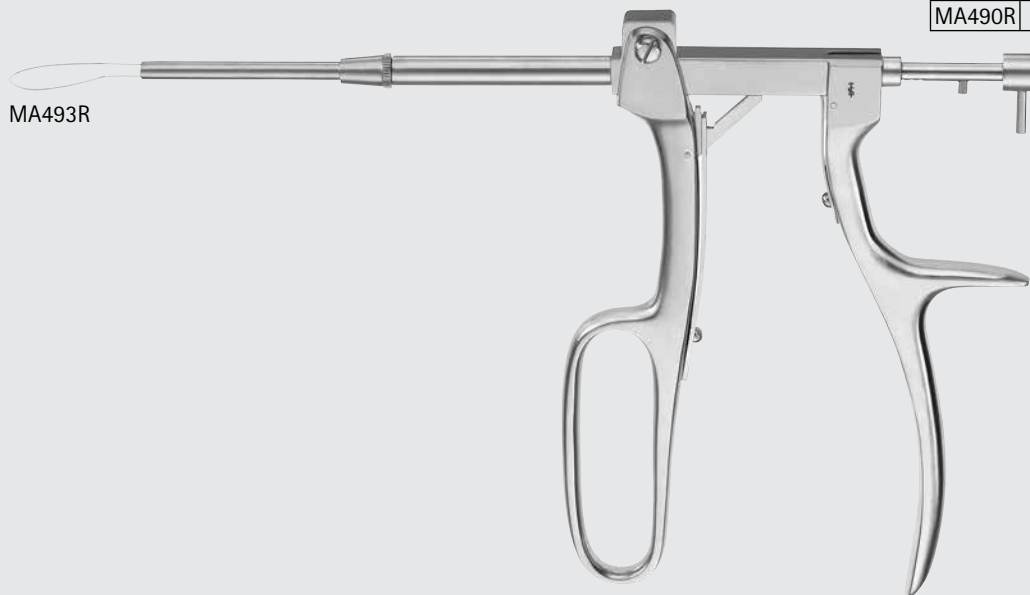

MA493R

1/2



MA490R

1/4

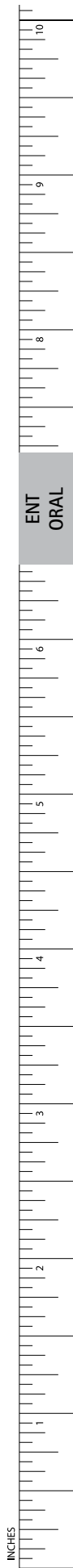

# ENT-ORAL

## Tonsil Snares/Wires/Adenotomes

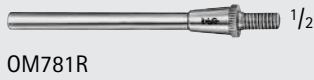
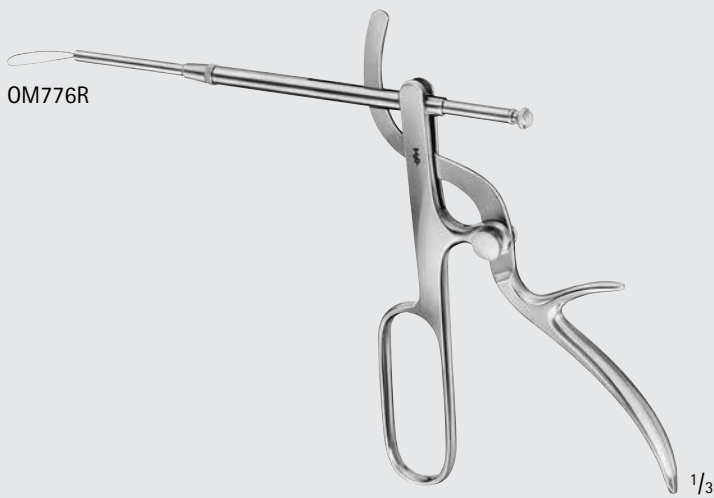

### TYDING Tonsil Snare

Catalog Number	Description
OM781R	-
OM776R	TIP ONLY, STR

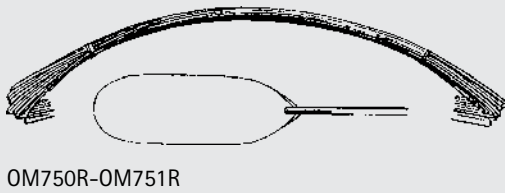

### Tonsil Snare Wire

Catalog Number	Diameter (mm)	Size (#)	Sales Unit	Length (mm)
MA490R	1.4	6	12/BOX	100
OM750R	0.3	7	12/BOX	100
OM751R	0.5	8	12/BOX	100

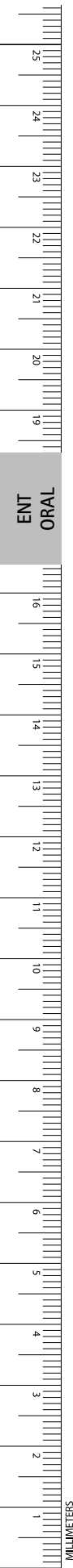

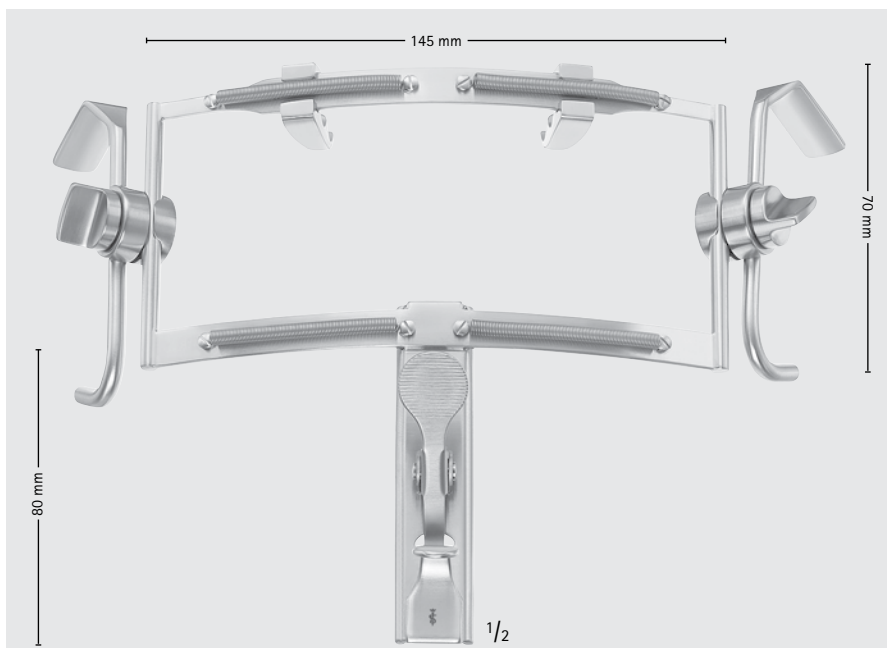

**DINGMAN Mouth Gag**

Catalog Number	Description
MA299R	COMPLETE SET WITH 3 BLADES AND FRAME

MA299R Includes:  
 1 Mouth Gag OM105R,  
 1 Blade of each OM171R, OM172R, OM177R

MA299R



**MOLT Mouth Gag, Pediatric**

Catalog Number	Description	Length (in.)	Length (m)
OM038R	-	4	-
TA009706	SPARE SILICONE TUBE ONLY, LATEX-FREE	-	1

TA009706 Protective covers for OM038R and OM040R available as silicone tubing which may be cut to length

OM038R



**DOYEN-COLLIN Mouth Gag**

Catalog Number	Description	Length (in.)	Length (m)
OM040R	-	4 3/4	-
TA009706	SPARE SILICONE TUBE ONLY, LATEX-FREE	-	1

TA009706 Protective covers for OM038R and OM040R available as silicone tubing which may be cut to length

OM040R, TA009706

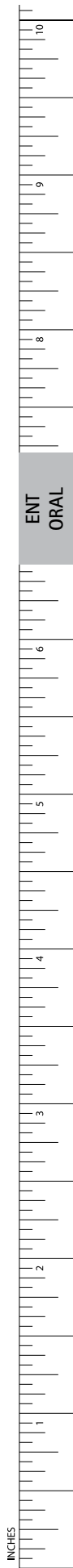

# ENT-ORAL

## Mouth Gags



OM041R, TA005771

1/2

### DOYEN-JANSEN Mouth Gag

Catalog Number	Description	Length (in.)	Length (m)
OM041R	-	5 1/2	-
TA005771	SPARE SILICONE TUBE ONLY, LATEX-FREE	-	1

TA005771 Protective covers for OM041R available as silicone tubing which may be cut to length



OM047R

1/2

### DENHARDT Mouth Gag

Catalog Number	Length (in.)
OM047R	5



OM070R-OM073R



### WHITEHEAD-JENNINGS Mouth Gag

Catalog Number	Length (in.)
OM070R	3 1/2
OM071R	4 1/4
OM072R	5 1/8
OM073R	6



OP299

### Teeth Protector, Latex-Free Rubber

Catalog Number	Size
OP299	ADOLESCENT AND ADULT

DAVIS Mouth Gag

Catalog Number	Blade Size (mm)	Size (#)	Description	Length (in.)
MA302R	-	-	COMPLETE SET, RIGHT	-
MA303R	-	-	COMPLETE SET, LEFT	-
MA307R	-	-	RIGHT FRAME ONLY	6
MA304R	20 x 34	1	BLADE	5 1/4
MA305R	23 x 64	2	BLADE	5 1/4
MA306R	25 x 79	3	BLADE	5 1/4
MA308R	25 x 85	3 1/2	BLADE	5 1/8
MA309R	25 x 95	4	BLADE	5 1/8
MA310R	25 x 106	5	BLADE	5 1/8
OM170	SILICONE INSERT			

MA302R Includes:

1 Blades w/ Tube of each MA304R, MA307R, OM112R, MA315R, OM114R, OM115R

MA303R Includes:

1 Blades w/ Tube of each OM116R, MA304R, OM112R, MA315R, OM114R, OM115R



MA307R



MA304R



MA305R



MA306R



MA308R



MA309R



MA310R

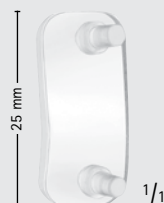

OM170

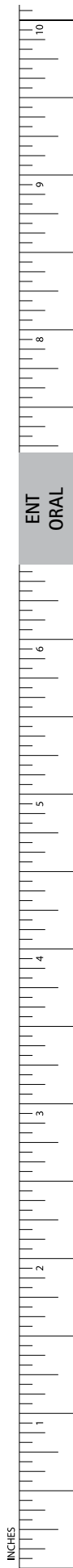

# ENT-ORAL

## Mouth Gags



MA315R



MA319R

### DAVIS Mouth Gag W/ Tube

Catalog Number	Blade Size (mm)	Size (#)
MA315R	24 x 80	3
MA319R	25 x 90	3

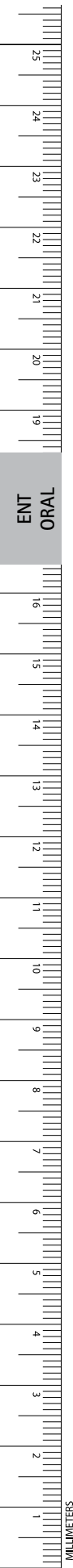

MILLIMETERS

DAVIS-BOYLE Mouth Gag

Catalog Number	Blade Size (mm)	Size	Description	Length (in.)
OM118R	-	CHILD	FRAME ONLY	5 1/4
OM119R	-	TEEN	FRAME ONLY	5 3/4
OM116R	-	ADULT	FRAME ONLY	6 3/4
OM112R	25 x 62	-	BLADE	-
OM113R	25 x 75	-	BLADE	-
OM114R	25 x 92	-	BLADE	-
OM115R	25 x 108	-	BLADE	-
OM170	SILICONE INSERT			

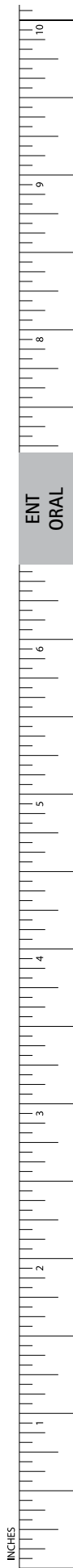
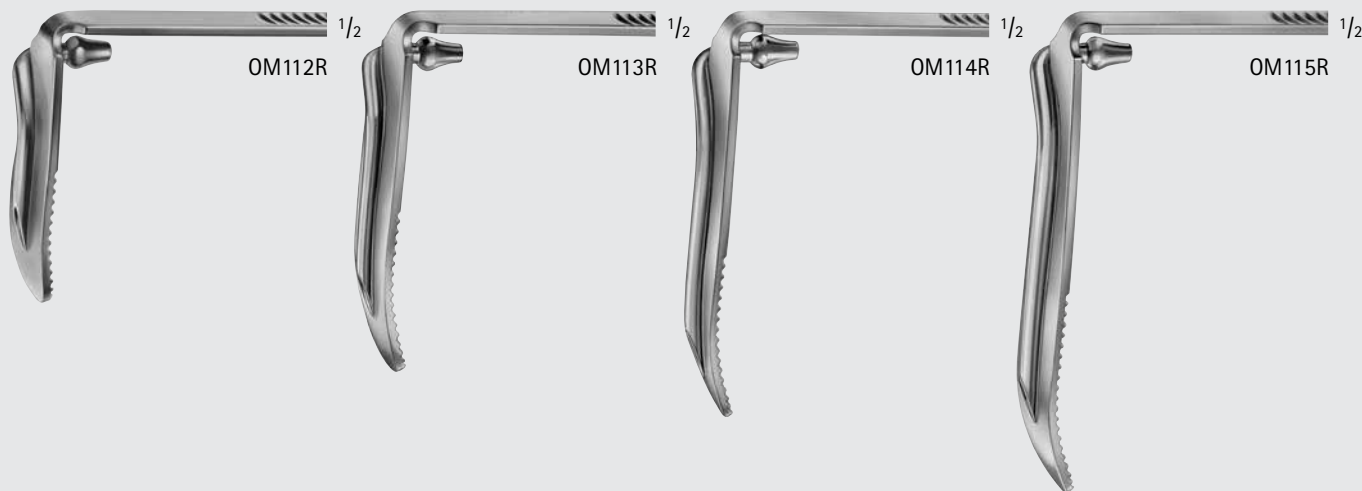
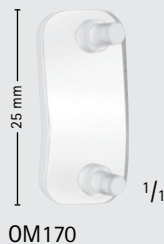

# ENT-ORAL

## Mouth Gags

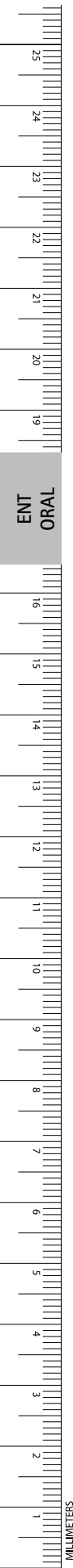

OM169R

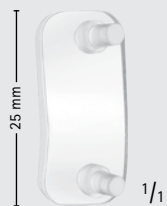

OM170



OM179R

### DAVIS-MEYER Tongue Depressor Frame

Catalog Number	Description
OM169R	FRAME, COMPLETE
OM170	SILICONE INSERT
OM179R	PALATE BLADE

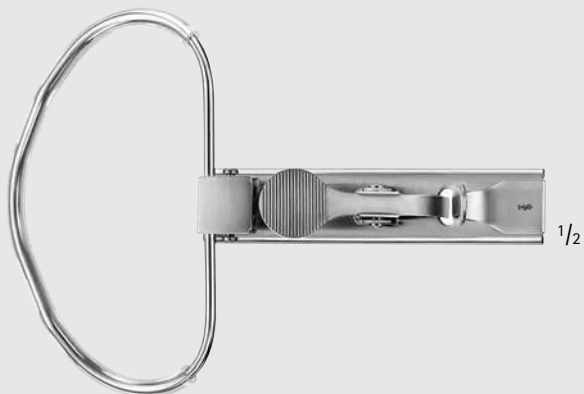

MA311R



MA312R-MA314R

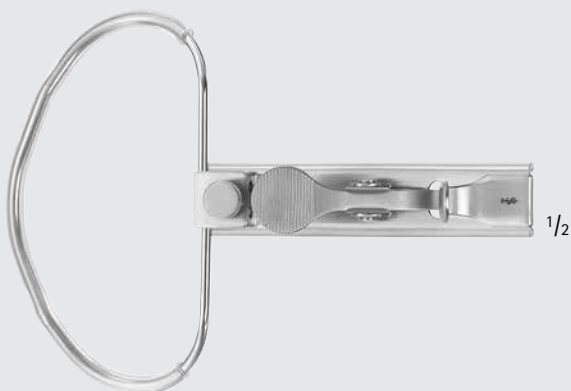

OM104R

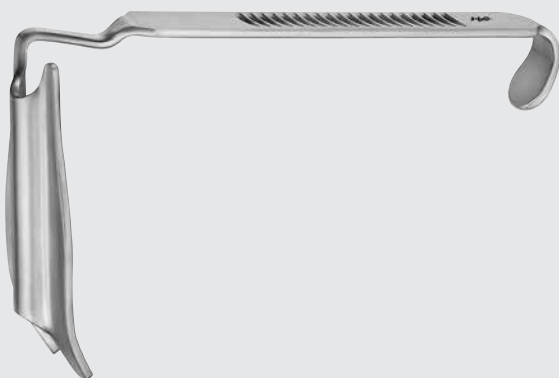

MB595R-MB600R

MCIVOR Mouth Gag

Catalog Number	Blade Size (mm)	Size (#)	Description	Length (in.)
MA311R	-	-	COMPLETE WITH FRAME AND 3 TONGUE BLADES	-
MA312R	22 x 69	1	BLADE	5 3/8
MA313R	24 x 90	2	BLADE	5 3/8
MA314R	25 x 100	3	BLADE	5 3/8
OM104R	-	-	FRAME F/ TONGUE DEPRESSOR	5 1/2
OM104201	-	-	REPLACEMENT TUBE F/ OM104R	-
OM101R	25 x 55	-	BLADE	-
OM102R	25 x 62	-	BLADE	-
OM103R	25 x 75	-	BLADE	-
MB595R	57 x 23	2	BLADE, RIGHT	-
MB596R	72 x 27	3	BLADE, RIGHT	-
MB597R	88 x 33	4	BLADE, RIGHT	-
MB598R	57 x 23	2	BLADE, LEFT	-
MB599R	72 x 27	3	BLADE, LEFT	-
MB600R	88 x 33	4	BLADE, LEFT	-
MA301R	97 x 36	5	BLADE, LEFT	-
MA300R	97 x 36	5	BLADE, RIGHT	-



OM101R-OM103R



MA300R-MA301R

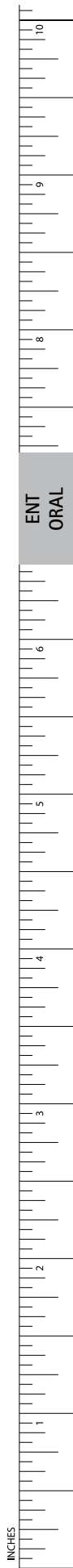

ENT ORAL

INCHES

# ENT-ORAL

## Mouth Gags

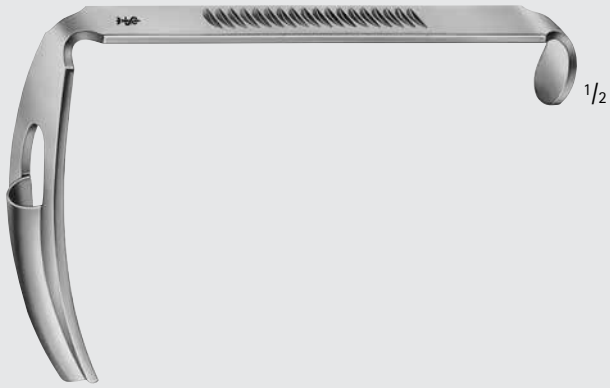

OM171R-OM178R

### RUSSEL-DAVIS Tongue Blade

Catalog Number	Blade Size (mm)
OM171R	29 x 67
OM172R	33 x 75
OM173R	38 x 85
OM174R	40 x 92
OM175R	46 x 100
OM176R	18 x 57
OM177R	22 x 67
OM178R	25 x 75



OM171R



OM172R



OM173R



OM174R



OM175R



OM176R



OM177R



OM178R

ENT  
ORAL

MILLIMETERS

# ENT-ORAL

## Mouth Gags

### GAST Tongue Blade

Catalog Number	Blade Size (mm)
OM181R	28 x 64
OM182R	34 x 74
OM183R	38 x 87



OM181R-OM183R



OM181R

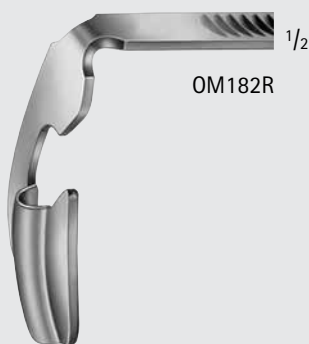

OM182R



OM183R

### DRAFFIN Chest Support, W/ 4 Height Rings

Catalog Number	Length (in.)
OM186R	18 7/8

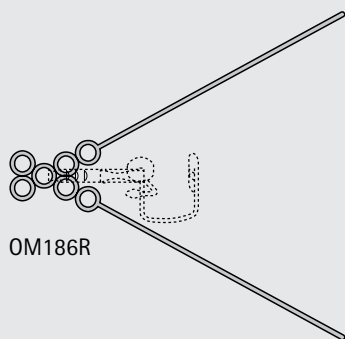

OM186R

### MAGAUAN Plate, F/ Holding OM186R

Catalog Number	Length (in.)
OM187R	16

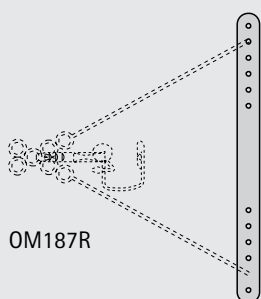

OM187R

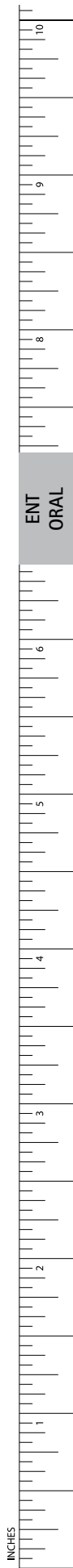

# ENT-ORAL

## Tonsil Knives



OM681R

**ABRAHAM Tonsil Knife**

Catalog Number	Length (in.)
OM681R	8 3/4



OM681R



OM688R

**FISHER Tonsil Knife**

Catalog Number	Length (in.)
OM688R	8



OM688R

ENT  
ORAL

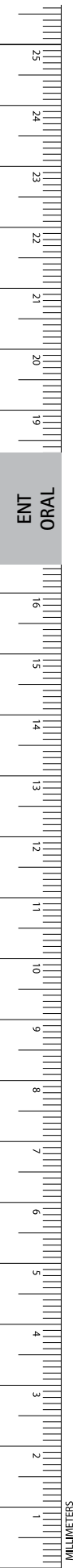

MILLIMETERS

# ENT-ORAL

## Suction Tubes

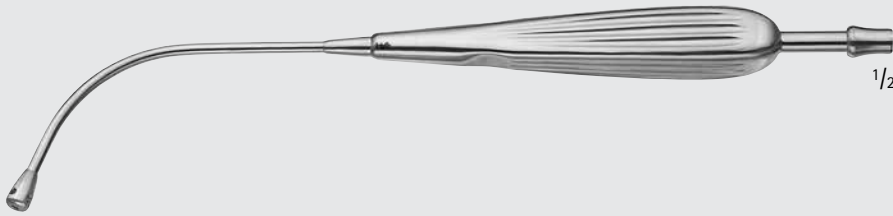

### ANDREWS Pynchon Suction Tube

Catalog Number	Description	Length (in.)
MD613	-	9
MD613001	TIP ONLY F/ MD613	-

MD613



MD613001

OP360R-OP362R

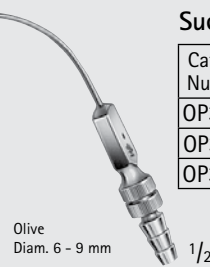

### Suction Tube, W/ Finger Cut-Off

Catalog Number	Tip Size (mm)	Working Length (in.)
OP360R	2.0	9 3/4
OP361R	2.5	9 3/4
OP362R	3.0	9 3/4

Olive  
Diam. 6 - 9 mm

### JACKSON Velvet Eye Aspirating Tube

Catalog Number	Diameter (mm)	Length (in.)
MB366R	4.0	10
MB367R	4.0	16 3/8
MB368R	4.0	22
MB369R	4.0	18 1/8

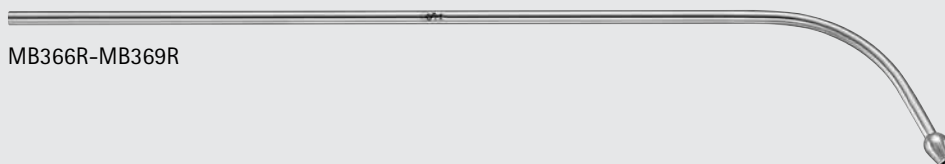

MB366R-MB369R

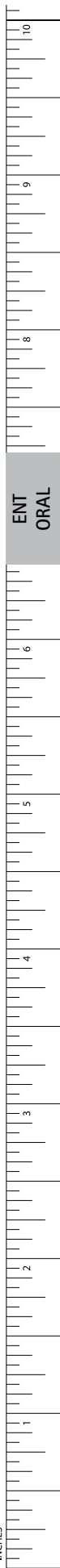

ENT  
ORAL

INCHES

# ENT-ORAL

## Curettes



OM471R-OM474R

### BARNHILL Adenoid Curette

Catalog Number	Tip Size (mm)	Length (in.)
OM471R	11	7 7/8
OM472R	13	7 7/8
OM473R	15	7 7/8
OM474R	17	7 7/8

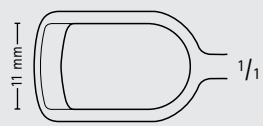

OM471R

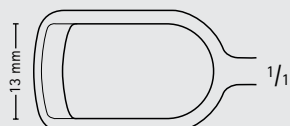

OM472R



OM473R

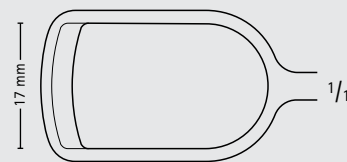

OM474R



OM451R-OM456R

### BECKMANN Adenoid Curette

Catalog Number	Tip Size (mm)	Length (in.)
OM451R	9.25	7 7/8
OM452R	11.5	7 7/8
OM453R	12	7 7/8
OM454R	13	7 7/8
OM455R	15.5	7 7/8
OM456R	16	7 7/8
OM500R	10	8 3/4
OM501R	12	8 3/4
OM502R	14	8 3/4
OM503R	16	8 3/4
OM504R	18	8 3/4
OM505R	20	8 3/4

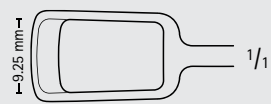

OM451R



OM452R

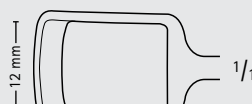

OM453R



OM454R



OM455R



OM456R



OM500R-OM505R



OM500R



OM501R



OM502R



OM503R



OM504R



OM505R

ENT  
ORAL

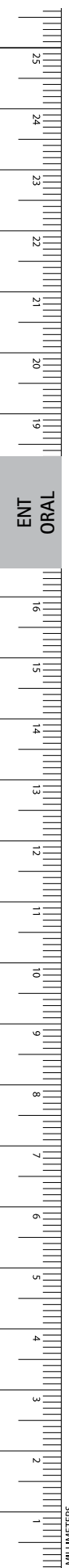

MILLIMETERS



MA654R-MA656R

JONES Adenoid Curette

Catalog Number	Tip Size (mm)	Size (#)	Size	Length (in.)
MA656R	4	1	INFANT	8 3/4
MA655R	6	2	CHILD	8 7/8
MA654R	8	3	ADULT	8 7/8



MA656R



MA655R



MA654R



MA291R

MIDDLETON Adenoid Curette

Catalog Number	Tip Size (mm)	Length (in.)
MA291R	7	8 7/8



MA291R



OM510R-OM514R

NEGUS Adenoid Curette

Catalog Number	Tip Size (mm)	Length (in.)
OM510R	10	7 7/8
OM511R	12.25	7 7/8
OM512R	14	7 7/8
OM513R	16.5	7 7/8
OM514R	18	7 7/8

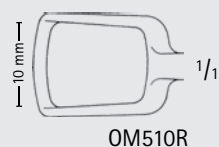

OM510R

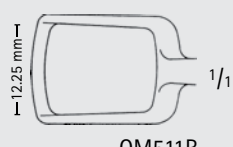

OM511R

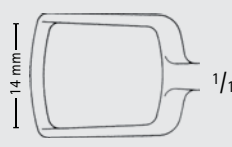

OM512R



OM513R



OM514R

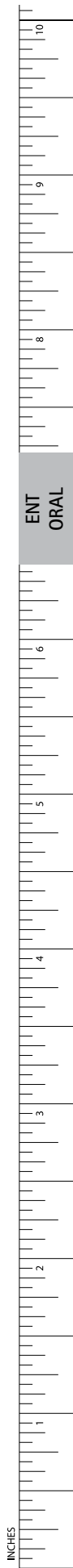

# ENT-ORAL

## Curettes



US149-US150

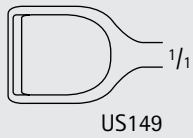

US149

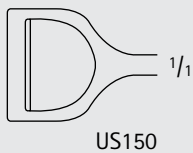

US150



MA066R-MA067R

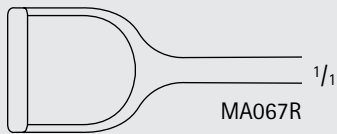

MA067R

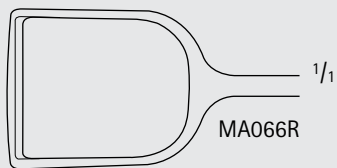

MA066R

### STUBBS Adenoid Curette

Catalog Number	Tip Size (mm)	Size (#)	Length (in.)
US149	11	0	8 1/2
US150	14	1	8 1/2
MA067R	16	2	8 1/2
MA066R	18	3	8 1/2



MB316R



MB316R

### VOGEL Adenoid Curette, Infant

Catalog Number	Tip Size (mm)	Length (in.)
MB316R	7	8 1/2

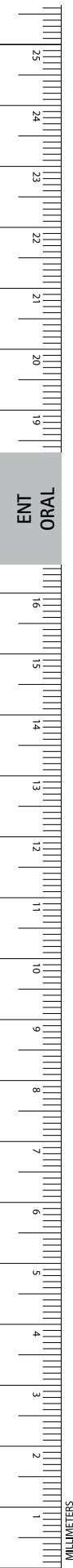

MILLIMETERS

# ENT-ORAL Syringes



## Syringe

Catalog Number	Diameter (mm)	Volume (cc)	Length (in.)
MA533R	11	3	5 1/2
MA534R	14	5	5 1/2
MA535R	17	10	5 1/2

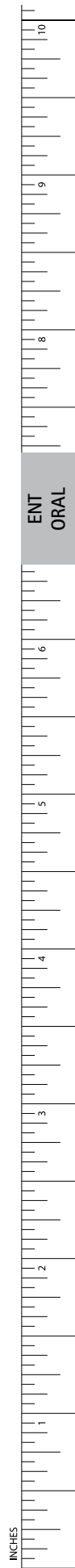

INCHES

# ENT-ORAL

## Laryngeal Mirrors



OM078R-OM090R



OM078R



OM079R



OM080R



OM081R



OM082R



OM083R



OM084R



OM085R



OM086R



OM087R



OM088R



OM089R



OM090R

### Laryngeal Mirror, Rigid, W/ Hex Handle

Catalog Number	Size (#)	Diameter (mm)	Length (in.)
OM078R	000	6.0	7
OM079R	00	8.0	7
OM080R	0	10.0	7
OM081R	1	12.0	7
OM082R	2	14.0	7
OM083R	3	16.0	7
OM084R	4	18.0	7
OM085R	5	20.0	7
OM086R	6	22.0	7
OM087R	7	24.0	7
OM088R	8	26.0	7
OM089R	9	28.0	7
OM090R	10	30.0	7



AC468R-AC480R



AC468R



AC469R



AC470R

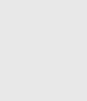

AC471R

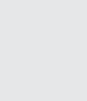

AC472R



AC473R



AC474R



AC475R



AC476R



AC477R



AC478R



AC479R



AC480R

### Laryngeal Mirror, Rigid, F/ Handle AC481R

Catalog Number	Size (#)	Diameter (mm)	Length (in.)
AC468R	000	6.0	4 3/4
AC469R	00	8.0	4 3/4
AC470R	0	10.0	4 3/4
AC471R	1	12.0	4 3/4
AC472R	2	15.0	4 3/4
AC473R	3	16.0	4 3/4
AC474R	4	18.0	4 3/4
AC475R	5	20.0	4 3/4
AC476R	6	22.0	4 3/4
AC477R	7	24.0	4 3/4
AC478R	8	26.0	4 3/4
AC479R	9	28.0	4 3/4
AC480R	10	30.0	4 3/4
AC481R	-	HANDLE	4 1/4

ENT  
ORAL

MILLIMETERS

# ENT-ORAL

## Amalgam Carriers



### Amalgam Carrier, Double Ended

Catalog Number	Size	Length (in.)
MG574R	MEDIUM / LARGE	7 7/8

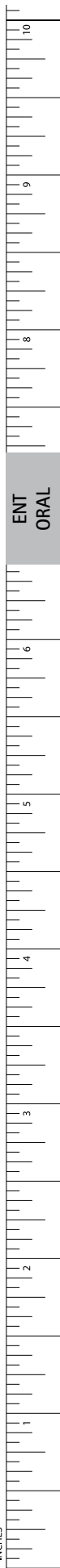

# Brisk Surgical Instruments

## Product Catalog

PRECISION. QUALITY. PERFORMANCE.  
INSTRUMENTS YOU CAN TRUST.



### Engineered for Excellence. Designed for Professionals.

BRISK Surgical Instruments are crafted with premium materials and advanced technology to deliver unmatched precision, durability, and reliability for every procedure.



#### PREMIUM QUALITY

Medical grade  
stainless steel



#### AUTOCLAVABLE

High corrosion  
resistance



#### PRECISION ENGINEERED

Perfect balance  
and accuracy



#### ERGONOMIC DESIGN

Superior grip &  
optimal control



#### QUALITY ASSURED

Strict quality control  
at every step



✉ [Sales@brisksurgical.com](mailto:Sales@brisksurgical.com)

🌐 [www.brisksurgical.com](http://www.brisksurgical.com)

📍 Dubai, United Arab Emirates

# BRISK

— SURGICAL —

THANK YOU FOR CHOOSING BRISK SURGICAL INSTRUMENTS