



# Aluminium Kitchen Drawer and Cabinet Hardware

[www.buildingmaterialsguru.com](http://www.buildingmaterialsguru.com)

# CONTENTS

- Star Series, Pg 3-18
- Xingmi Series, Pg 19-24
- Harry-Pott Series, Pg 25-62



# STAR SERIES



STAR-DISH  
BASKET  
明星全铝碗盘篮

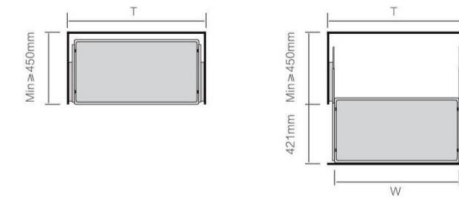

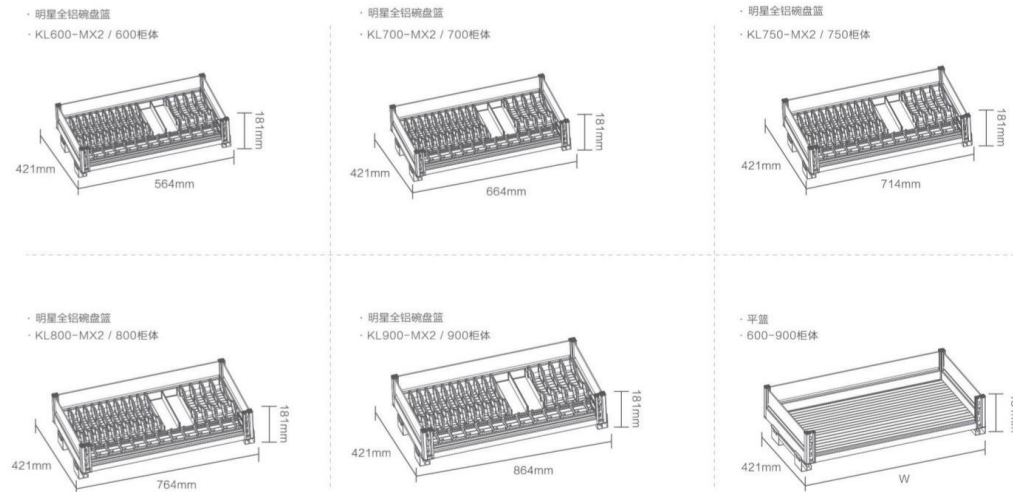
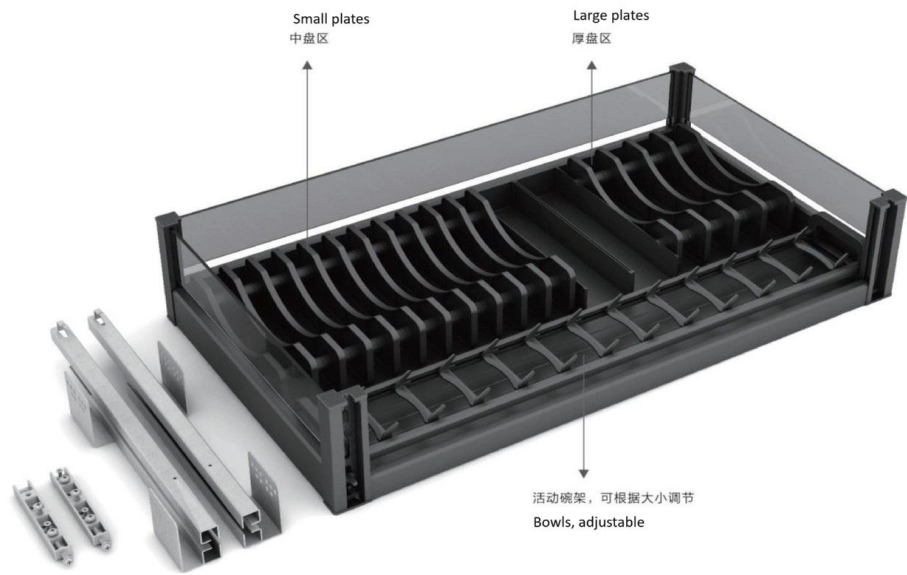

型号 Art.No.	柜体 Cabinet	宽度x深度x高度 WidthxDepthxHeight	描述 Description
KL600-MX2	600mm	564x421x181mm	Track adjustments 柜体调节+4mm; -4mm
KL700-MX2	700mm	664x421x181mm	柜体调节+4mm; -4mm
KL750-MX2	750mm	714x421x181mm	柜体调节+4mm; -4mm
KL800-MX2	800mm	764x421x181mm	柜体调节+4mm; -4mm
KL900-MX2	900mm	864x421x181mm	柜体调节+4mm; -4mm



STAR-SEASONING  
BASKET

明星调味篮

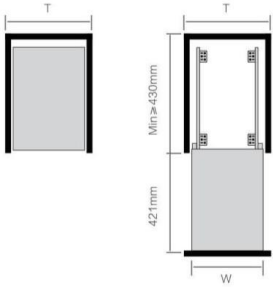



· 明星调味篮  
· KL300-MX / 300柜体

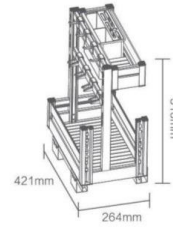

· 明星调味篮  
· KL350-MX / 350柜体

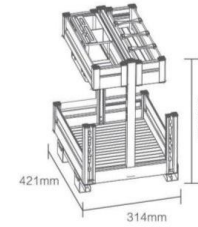

· 明星调味篮  
· KL400-MX / 400柜体

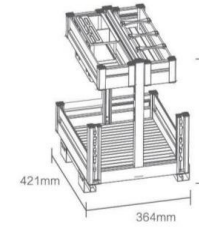

· 明星调味篮  
· KL450-MX / 450柜体

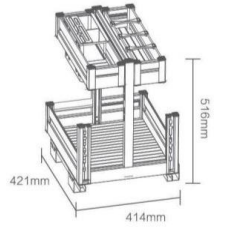

型号 Art.No.	柜体 Cabinet	宽度x深度x高度 WidthxDepthxHeight	描述 Description
KL300-MX	300mm	264x421x516mm	Tracks can be bottom or side mounted 侧装、底装通用滑轨
KL350-MX	350mm	314x421x516mm	侧装、底装通用滑轨
KL400-MX	400mm	364x421x516mm	侧装、底装通用滑轨
KL450-MX	450mm	414x421x516mm	侧装、底装通用滑轨



## STAR-DISH DRAWER IN DRAWER

### 明星碗盘抽中抽

抽中带抽，增加小工具收纳区域。

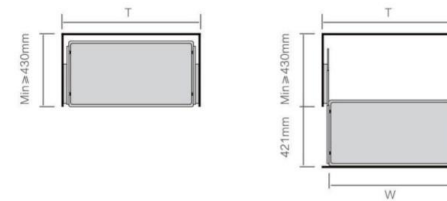





· 明星碗盘抽中抽  
· KL600-MC / 600柜体

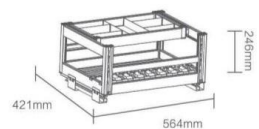

· 明星碗盘抽中抽  
· KL700-MC / 700柜体

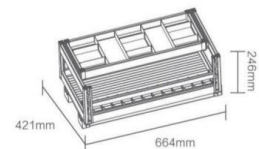

· 明星碗盘抽中抽  
· KL750-MC / 750柜体

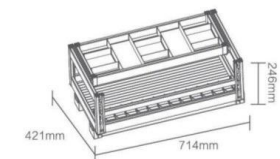

· 明星碗盘抽中抽  
· KL800-MC / 800柜体

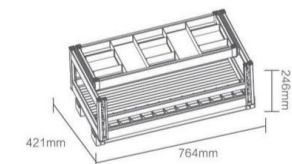

· 明星碗盘抽中抽  
· KL900-MC / 900柜体

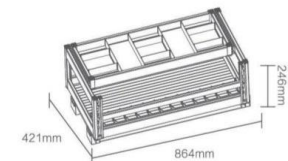

· 明星平篮  
· 600-900柜体

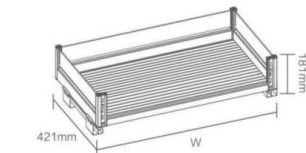

型号 Art.No.	柜体 Cabinet	宽度x深度x高度 WidthxDepthxHeight	描述 Description
KL600-MC	600mm	564x421x246mm 564x421x181mm	Track adjustments 柜体调节+4mm; -4mm
KL700-MC	700mm	664x421x246mm 664x421x181mm	柜体调节+4mm; -4mm
KL750-MC	750mm	714x421x246mm 714x421x181mm	柜体调节+4mm; -4mm
KL800-MC	800mm	764x421x246mm 764x421x181mm	柜体调节+4mm; -4mm
KL900-MC	900mm	864x421x246mm 864x421x181mm	柜体调节+4mm; -4mm



## STAR-SEASONING DRAWER IN DRAWER

### 明星调味抽中抽

三层收纳，层层分明，不下蹲即可取物。

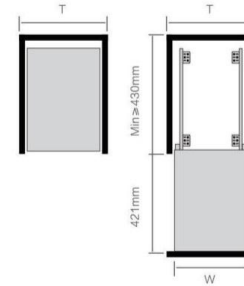

· 明星调味抽中抽  
· KL300-MC / 300柜体

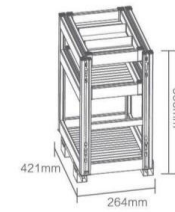

· 明星调味抽中抽  
· KL350-MC / 350柜体

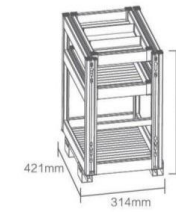

· 明星调味抽中抽  
· KL400-MC / 400柜体



· 明星调味抽中抽  
· KL450-MC / 450柜体



型号 Art.No.	柜体 Cabinet	宽度x深度x高度 WidthxDepthxHeight	描述 Description
KL300-MC	300mm	264x421x566mm	Tracks can be bottom or side mounted 侧装、底装通用滑轨
KL350-MC	350mm	314x421x566mm	侧装、底装通用滑轨
KL400-MC	400mm	364x421x566mm	侧装、底装通用滑轨
KL450-MC	450mm	414x421x566mm	侧装、底装通用滑轨



开门式安装

STAR-FULL-ALUMINUM  
THREE-SEVEN DRAWER

明星全铝三七抽（二合一）

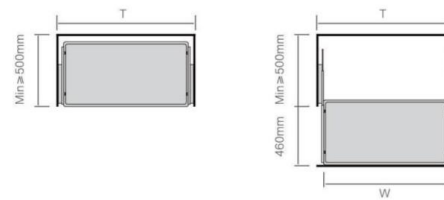

抽屉式安装

Star aluminium 30/70 drawer (2 in 1) (Top level)  
明星全铝三七抽（二合一）（上层）

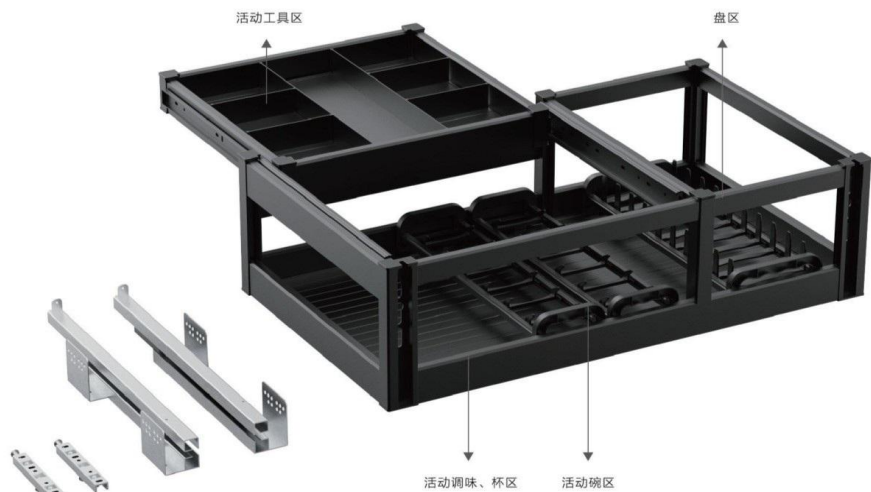

Star aluminium 30/70 drawer (2 in 1) (Bottom level)  
明星全铝三七抽（二合一）（下层）



· 明星全铝三七抽（二合一）（上层）  
· KL600-37MC / 600柜体

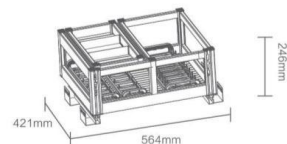

· 明星全铝三七抽（二合一）（上层）  
· KL700-37MC / 700柜体

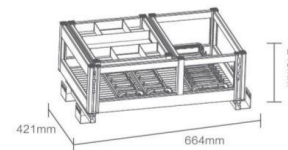

· 明星全铝三七抽（二合一）（上层）  
· KL750-37MC / 750柜体

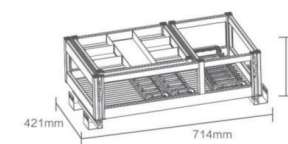

· 明星全铝三七抽（二合一）（上层）  
· KL800-37MC / 800柜体

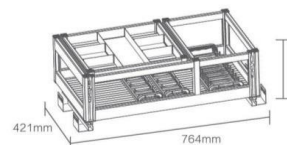

· 明星全铝三七抽（二合一）（上层）  
· KL900-37MC / 900柜体

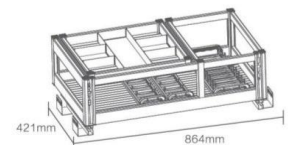

· 明星全铝三七抽（二合一）（下层）  
· 600-900柜体

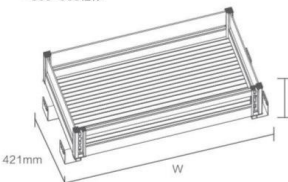

型号 Art.No.	柜体 Cabinet	宽度x深度x高度 WidthxDepthxHeight	描述 Description
KL600-37MC	600mm	(Top level) 564x421x246mm (上层) / (Bottom level) 564x421x181mm (下层)	Track adjustment 柜体调节-4mm
KL700-37MC	700mm	664x421x246mm (上层) / 664x421x181mm (下层)	柜体调节-4mm
KL750-37MC	750mm	714x421x246mm (上层) / 714x421x181mm (下层)	柜体调节-4mm
KL800-37MC	800mm	764x421x246mm (上层) / 764x421x181mm (下层)	柜体调节-4mm
KL900-37MC	900mm	864x421x246mm (上层) / 864x421x181mm (下层)	柜体调节-4mm



STAR-TWO-IN-ONE GENERAL  
DISH DRAWER

明星二合一通用碗盘抽

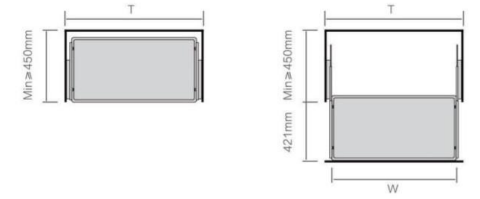

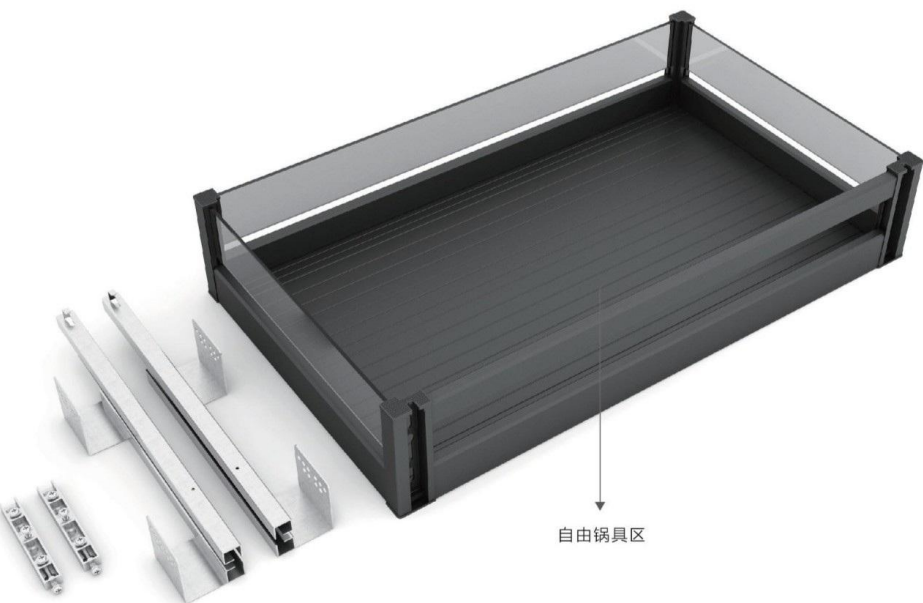
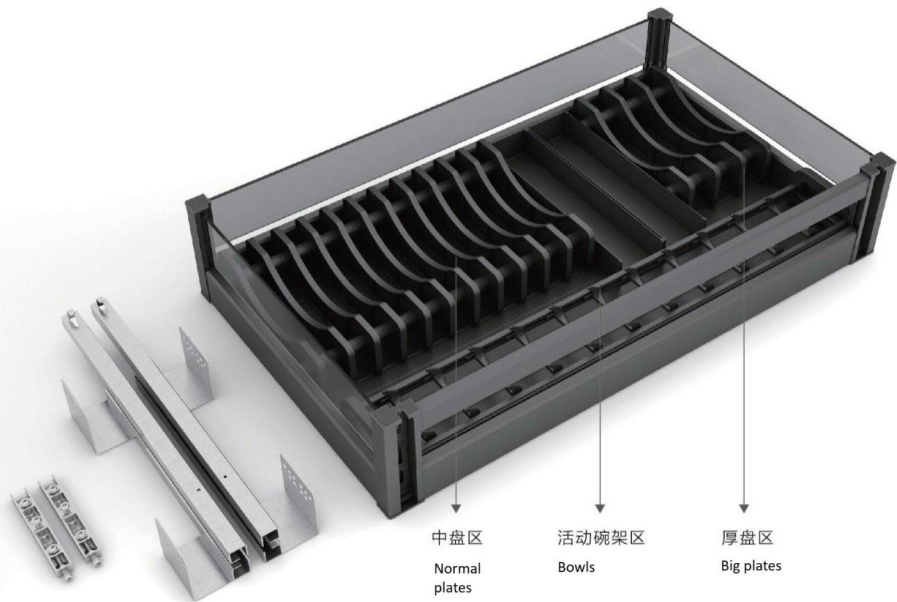

· 明星二合一通用碗盘抽  
· KL600-MX4 / 600柜体

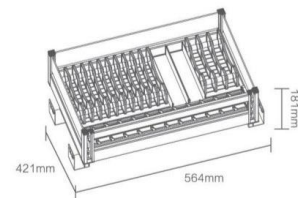

· 明星二合一通用碗盘抽  
· KL700-MX4 / 700柜体

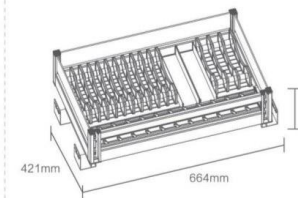

· 明星二合一通用碗盘抽  
· KL750-MX4 / 750柜体

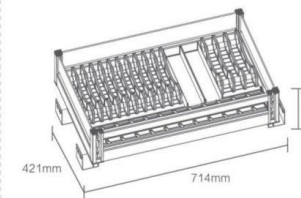

· 明星二合一通用碗盘抽  
· KL800-MX4 / 800柜体

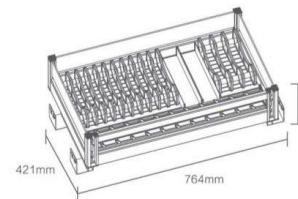

· 明星二合一通用碗盘抽  
· KL900-MX4 / 900柜体

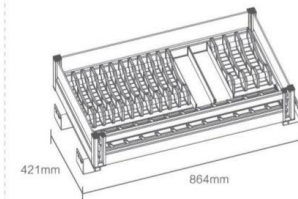

· 明星二合一通用碗盘抽(平抽)  
· 600-900柜体

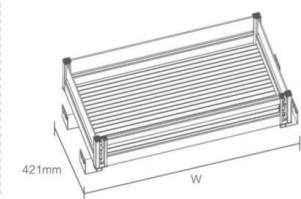

型号 Art.No.	柜体 Cabinet	宽度x深度x高度 WidthxDepthxHeight	描述 Description
KL600-MX4	600mm	564x421x181mm	Track adjustment 柜体调节-4mm
KL700-MX4	700mm	664x421x181mm	柜体调节-4mm
KL750-MX4	750mm	714x421x181mm	柜体调节-4mm
KL800-MX4	800mm	764x421x181mm	柜体调节-4mm
KL900-MX4	900mm	864x421x181mm	柜体调节-4mm



## MINGXING-FLOOR CABINET LINKED BASKET

明星地柜连动篮

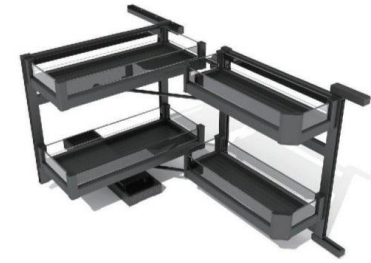
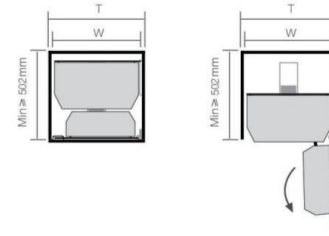

- 明星地柜连动篮
- KL40-500MX/ 400柜体

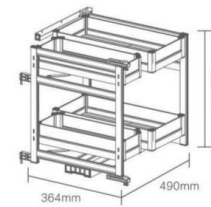

- 明星地柜连动篮
- KL45-500MX/ 450柜体

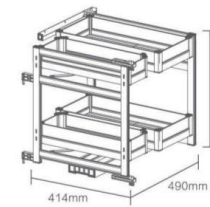

- 明星地柜连动篮
- KL60-500MX/ 500柜体

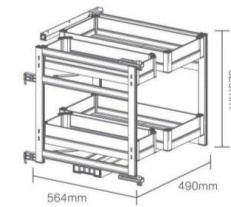

型号 Art.No.	柜体 Cabinet	宽度x深度x高度 WidthxDepthxHeight	层数 Number	描述 Description
KL40-500MX	400mm	364 × 490 × 520mm	2层	Height of cabinet 适用柜体高度 600-800mm
KL45-500MX	450mm	414 × 490 × 520mm	2层	适用柜体高度 600-800mm
KL60-500MX	600mm	564 × 490 × 520mm	2层	适用柜体高度 600-800mm



## STAR-HIGH CABINET LINKED BASKET

### 明星高柜连动篮

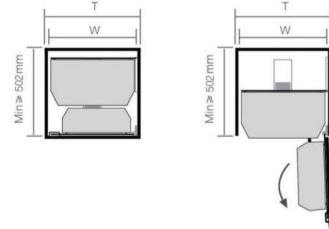

- 明星高柜连动篮
- 4层 / 400柜体 W=364mm
- 450柜体 W=414mm
- 600柜体 W=564mm

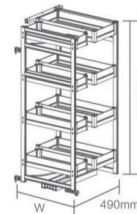

- 明星高柜连动篮
- 6层 / 400柜体

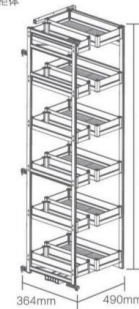

- 明星高柜连动篮
- 6层 / 450柜体

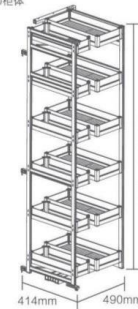

- 明星高柜连动篮
- 6层 / 600柜体

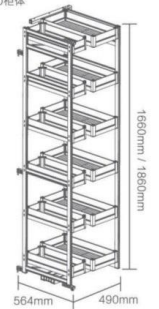

型号 Art.No.	柜体 Cabinet	宽度x深度x高度 WidthxDepthxHeight	层数 Number	描述 Description (Cabinet Height)
KL40-1160MX	400mm	364x490x1160mm	4层 layers	适用柜体高度1300-1500mm
KL40-1660MX	400mm	364x490x1660mm	6层	适用柜体高度1800-2000mm
KL40-1860MX	400mm	364x490x1860mm	6层	适用柜体高度2000-2200mm
KL45-1160MX	450mm	414x490x1160mm	4层	适用柜体高度1300-1500mm
KL45-1660MX	450mm	414x490x1660mm	6层	适用柜体高度1800-2000mm
KL45-1860MX	450mm	414x490x1860mm	6层	适用柜体高度2000-2200mm
KL60-1160MX	600mm	564x490x1160mm	4层	适用柜体高度1300-1500mm
KL60-1660MX	600mm	564x490x1660mm	6层	适用柜体高度1800-2000mm
KL60-1860MX	600mm	564x490x1860mm	6层	适用柜体高度2000-2200mm





## STAR-TWO-IN-ONE GENERAL FUNCTIONAL DRAWER(THREE LAYERS)

### 明星二合一通用功能抽（三层）

Multi-layer drawers for utensils, condiments and general storage. Single solution for multiple drawers. Large storage areas.

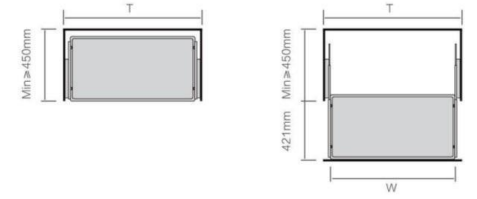



单块抽屉门板安装

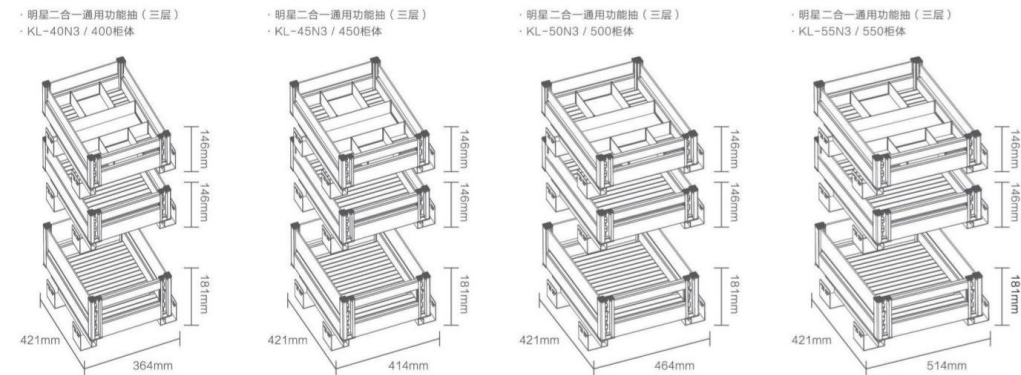
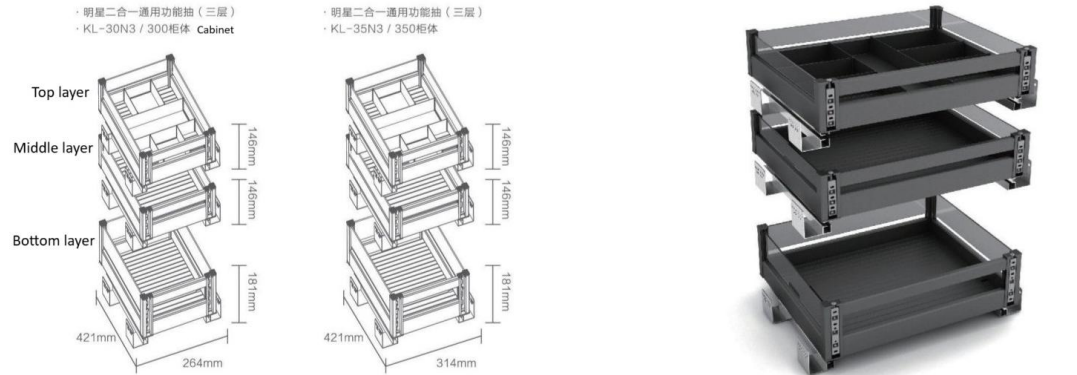

型号 Art.No.	柜体 Cabinet	宽度x深度x高度 WidthxDepthxHeight	描述 Description
KL-30N3	300mm	Top / Middle 上层 / 中层 264x421x146mm Bottom 下层 264x421x181mm	Track adjustments 柜体调节-4mm
KL-35N3	350mm	上层 / 中层 314x421x146mm 下层 314x421x181mm	柜体调节-4mm
KL-40N3	400mm	上层 / 中层 364x421x146mm 下层 364x421x181mm	柜体调节-4mm
KL-45N3	450mm	上层 / 中层 414x421x146mm 下层 414x421x181mm	柜体调节-4mm
KL-50N3	500mm	上层 / 中层 464x421x146mm 下层 464x421x181mm	柜体调节-4mm
KL-55N3	550mm	上层 / 中层 514x421x146mm 下层 514x421x181mm	柜体调节-4mm



星米系列

# XINGMI SERIES

平易近人，简约大气；



## XINGMI DYNAMIC- HIGH STRETCHING DRAWER

### 星米伸缩高抽

更好的区分储放物品，整齐归位无晃动。



· 星米伸缩高抽-4层



· 星米伸缩高抽  
· 4层 / 200柜体

· 星米伸缩高抽  
· 4层 / 250柜体

· 星米伸缩高抽  
· 4层 / 300柜体

· 星米伸缩高抽  
· 4层 / 350柜体

· 星米伸缩高抽  
· 4层 / 400柜体

- 4 layers / 200 cabinet

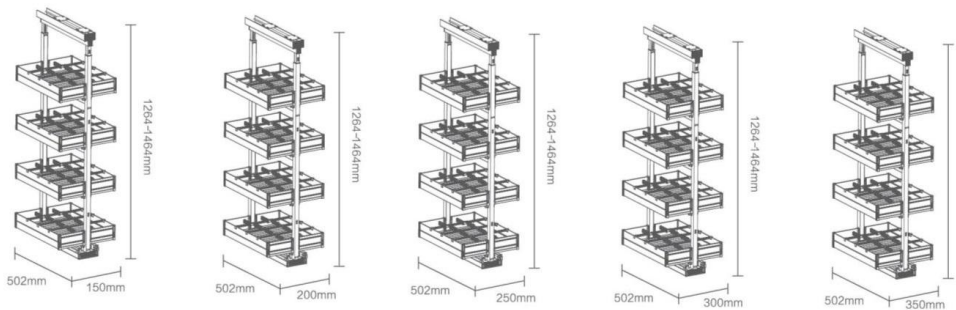

· 星米伸缩高抽  
· 6层 / 200柜体

· 星米伸缩高抽  
· 6层 / 250柜体

· 星米伸缩高抽  
· 6层 / 300柜体

· 星米伸缩高抽  
· 6层 / 350柜体

· 星米伸缩高抽  
· 6层 / 400柜体

- 6 layers / 200 cabinet

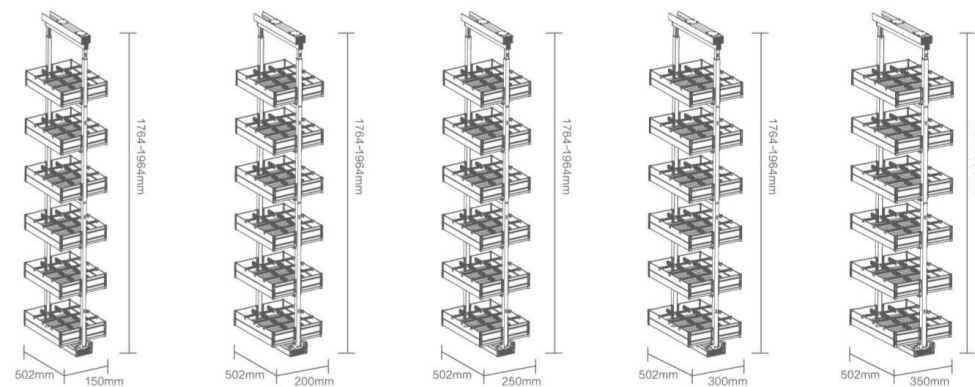

· 非标尺寸可定制

架子1件+篮子1件  
/2件

型号 Art.No.	柜体 Cabinet	宽度x深度x高度 WidthxDepthxHeight	层数 Number	描述 Description
KL200-1300X4	200mm	150x502x1264mm	4层	适用柜体高度1300-1500mm Cabinet height
KL200-1800X6	200mm	150x502x1764mm	6层	适用柜体高度1800-2000mm
KL200-2000X6	200mm	150x502x1964mm	6层	适用柜体高度2000-2200mm
KL250-1300X4	250mm	200x502x1264mm	4层	适用柜体高度1300-1500mm
KL250-1800X6	250mm	200x502x1764mm	6层	适用柜体高度1800-2000mm
KL250-2000X6	250mm	200x502x1964mm	6层	适用柜体高度2000-2200mm
KL300-1300X4	300mm	250x502x1264mm	4层	适用柜体高度1300-1500mm
KL300-1800X6	300mm	250x502x1764mm	6层	适用柜体高度1800-2000mm
KL300-2000X6	300mm	250x502x1964mm	6层	适用柜体高度2000-2200mm
KL350-1300X4	350mm	300x502x1264mm	4层	适用柜体高度1300-1500mm
KL350-1800X6	350mm	300x502x1764mm	6层	适用柜体高度1800-2000mm
KL350-2000X6	350mm	300x502x1964mm	6层	适用柜体高度2000-2200mm
KL400-1300X4	400mm	350x502x1264mm	4层	适用柜体高度1300-1500mm
KL400-1800X6	400mm	350x502x1764mm	6层	适用柜体高度1800-2000mm
KL400-2000X6	400mm	350x502x1964mm	6层	适用柜体高度2000-2200mm



**XINGMI DYNAMIC-  
HIGH CABINET LINKED BASKET**

**星米 高柜连动篮**

更好的区分存放物品，整齐归位无晃动。

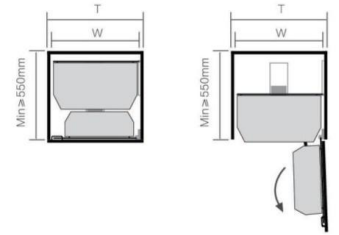

Xingmi dynamic - high cabinet  
linked basket

· 星米高柜连动篮-2层 2 layers



· 星米高柜连动篮  
· 2层  
· 400柜体 W=364mm  
· 450柜体 W=414mm  
· 600柜体 W=564mm

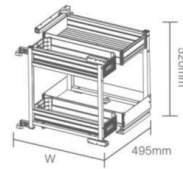

· 星米高柜连动篮-4层



· 星米高柜连动篮  
· 4层  
· 400柜体 W=364mm  
· 450柜体 W=414mm  
· 600柜体 W=564mm

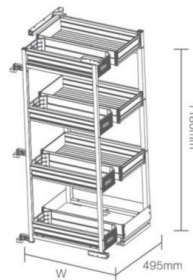

· 星米动静分隔高柜连动篮

· 5层 5 layers  
· 400柜体 W=364mm  
· 450柜体 W=414mm  
· 600柜体 W=564mm

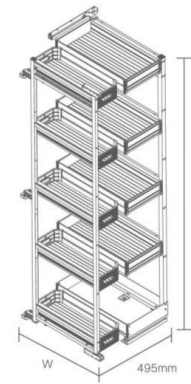

· 星米动静分隔高柜连动篮

· 6层 6 layers  
· 400柜体 W=364mm  
· 450柜体 W=414mm  
· 600柜体 W=564mm

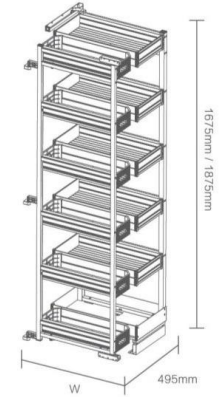

· 可定制宽度高度;  
深度350/495两种

Width and height  
customisable for depth  
350mm/495mm

型号 Art.No.	柜体 Cabinet	宽度x深度x高度 WidthxDepthxHeight	层数 Number	描述 Description
KL40-520X	400mm	364x495x520mm	2 layers 2层	Cabinet height 适用柜体高度700-800mm
KL40-1180X	400mm	364x495x1180mm	4层	适用柜体高度1300-1500mm
KL40-1375X	400mm	364x495x1375mm	5层	适合柜体高度1600-1800mm
KL40-1675X	400mm	364x495x1675mm	6层	适用柜体高度1800-2000mm
KL40-1875X	400mm	364x495x1875mm	6层	适用柜体高度2000-2200mm
KL45-520X	450mm	414x495x520mm	2层	适用柜体高度700-800mm
KL45-1180X	450mm	414x495x1180mm	4层	适用柜体高度1300-1500mm
KL45-1375X	450mm	414x495x1375mm	5层	适合柜体高度1600-1800mm
KL45-1675X	450mm	414x495x1675mm	6层	适用柜体高度1800-2000mm
KL45-1875X	450mm	414x495x1875mm	6层	适用柜体高度2000-2200mm
KL60-520X	600mm	564x495x520mm	2层	适用柜体高度700-800mm
KL60-1180X	600mm	564x495x1180mm	4层	适用柜体高度1300-1500mm
KL60-1375X	600mm	564x495x1375mm	5层	适合柜体高度1600-1800mm
KL60-1675X	600mm	564x495x1675mm	6层	适用柜体高度1800-2000mm
KL60-1875X	600mm	564x495x1875mm	6层	适用柜体高度2000-2200mm



## XINGMI DYNAMIC- CORNER BASKET

### 星米转角篮

全拉出取物，再无死角。

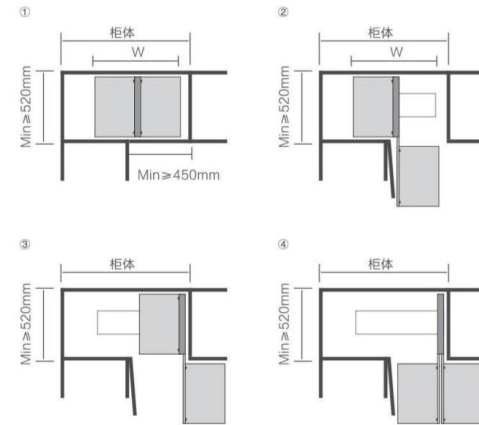

· 星米转角篮  
· KL400-ZX / 400柜门

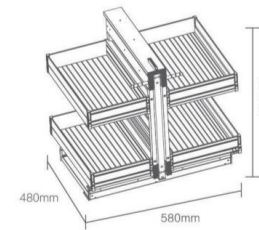

· 星米转角篮  
· KL450-ZX / 450柜门

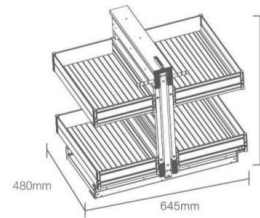

· 不可定制

No customisation  
available

型号 Art.No.	柜门 Cabinet	宽度x深度x高度 WidthxDepthxHeight	描述 Description
KL400-ZX	400mm	580 × 480 × 605mm	Interior width of cabinet 柜体内径 ≥ 900mm
KL450-ZX	450mm	645 × 480 × 605mm	柜体内径 ≥ 900mm





# HARRY POTT SERIES



## FULL-ALUMINUM HIGH CABINET LINKED BASKET

### 全铝高柜连动篮

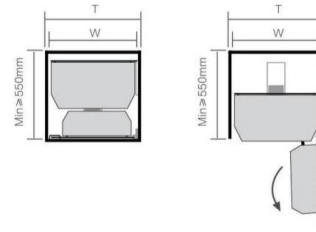

#### Cabinet height

- 适用柜体高度1300-1500mm
- 四层 4 layers
- 400柜体 W=364mm
- 450柜体 W=414mm
- 600柜体 W=564mm

- 适用柜体高度1500-1800mm
- 五层
- 400柜体 W=364mm
- 450柜体 W=414mm
- 600柜体 W=564mm

- 适用柜体高度1800-2000mm
- 六层
- 400柜体 W=364mm
- 450柜体 W=414mm
- 600柜体 W=564mm

- 适用柜体高度2000-2200mm
- 六层
- 400柜体 W=364mm
- 450柜体 W=414mm
- 600柜体 W=564mm

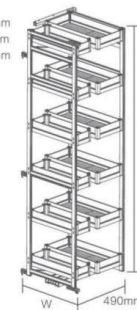
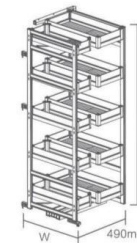
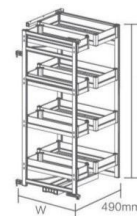

Note: Please use full overlay hinge. For other hinge type, customisation is required.

型号 Art.No.	柜体 Cabinet	宽度x深度x高度 WidthxDepthxHeight	层数 Number	描述 Description
KL40-1160	400mm	364x490x1160mm	4 layers	Cabinet height 适用柜体高度1300-1500mm
KL40-1360	400mm	364x490x1360mm	5层	适用柜体高度1500-1800mm
KL40-1660	400mm	364x490x1660mm	6层	适用柜体高度1800-2000mm
KL40-1860	400mm	364x490x1860mm	6层	适用柜体高度2000-2200mm
KL45-1160	450mm	414x490x1160mm	4层	适用柜体高度1300-1500mm
KL45-1360	450mm	414x490x1360mm	5层	适用柜体高度1500-1800mm
KL45-1660	450mm	414x490x1660mm	6层	适用柜体高度1800-2000mm
KL45-1860	450mm	414x490x1860mm	6层	适用柜体高度2000-2200mm
KL60-1160	600mm	564x490x1160mm	4层	适用柜体高度1300-1500mm
KL60-1360	600mm	564x490x1360mm	5层	适用柜体高度1500-1800mm
KL60-1660	600mm	564x490x1660mm	6层	适用柜体高度1800-2000mm
KL60-1860	600mm	564x490x1860mm	6层	适用柜体高度2000-2200mm



## FULL-OPEN HIGH CABINET LINKED BASKET-300 CABINET 全开高柜连动篮-300柜体

替代300柜体抽拉高升篮，开合结构寿命更长久，使用过程无售后。

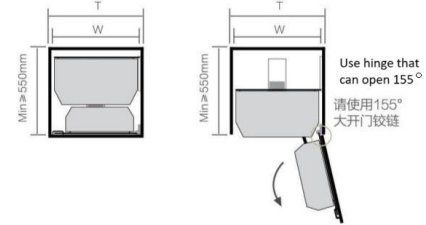

### Cabinet height

- 适用柜体高度1300-1500mm
- 四层 4 layers
- KL30-1160D / 300柜体

- 适用柜体高度1500-1800mm
- 五层
- KL30-1360D / 300柜体

- 适用柜体高度1800-2000mm
- 六层
- KL30-1660D / 300柜体

- 适用柜体高度2000-2200mm
- 六层
- KL30-1860D / 300柜体

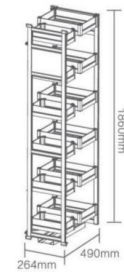
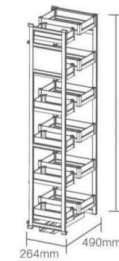
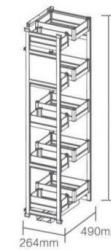
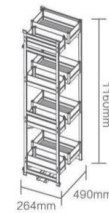

型号 Art.No.	柜体 Cabinet	宽度x深度x高度 WidthxDepthxHeight	层数 Number	描述 Description
KL30-1160D	300mm	264x490x1160mm	4 layers 4层	Cabinet height 适用柜体高度1300-1500mm
KL30-1360D	300mm	264x490x1360mm	5层	适用柜体高度1500-1800mm
KL30-1660D	300mm	264x490x1660mm	6层	适用柜体高度1800-2000mm
KL30-1860D	300mm	264x490x1860mm	6层	适用柜体高度2000-2200mm



## FULL-ALUMINUM FIRST CLASS

### 全铝头等舱

超大容量收纳拉篮，里外空间丝滑滑动，满足多种存储需求

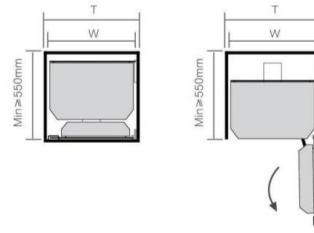

#### Cabinet height

- 适用柜体高度1800-2000mm
- 六层 6 layers
- KL50-1660T / 500柜体

- 适用柜体高度2000-2200mm
- 六层
- KL50-1860T / 500柜体

- 适用柜体高度1800-2000mm
- 六层
- KL60-1660T / 600柜体

- 适用柜体高度2000-2200mm
- 六层
- KL60-1860T / 600柜体

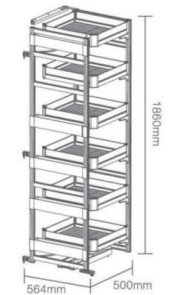
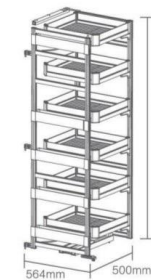

Note: Please use full overlay hinge. For other hinge type, customisation is required.

型号 Art.No.	柜体 Cabinet	宽度x深度x高度 WidthxDepthxHeight	层数 Number	描述 Description
KL50-1660T	500mm	464x500x1660mm	6 layers 6层	Cabinet height 适用柜体高度1800-2000mm
KL50-1860T	500mm	464x500x1860mm	6层	适用柜体高度2000-2200mm
KL60-1660T	600mm	564x500x1660mm	6层	适用柜体高度1800-2000mm
KL60-1860T	600mm	564x500x1860mm	6层	适用柜体高度2000-2200mm



## FULL-ALUMINUM FLOOR CABINET PULLING BASKET-2 FLOORS

### 全铝地柜侧拉篮-2层

角落空间自由收纳，顺滑抽拉轻松取物

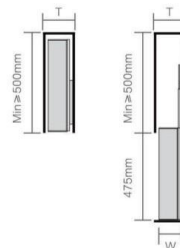

- 全铝地柜侧拉篮-2层
- KL150-左 / 150柜体

- 全铝地柜侧拉篮-2层
- KL150-右 / 150柜体

- 全铝地柜侧拉篮-2层
- KL200-左 / 200柜体

- 全铝地柜侧拉篮-2层
- KL200-右 / 200柜体

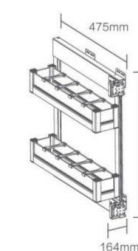
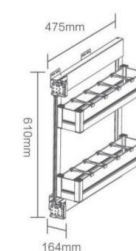
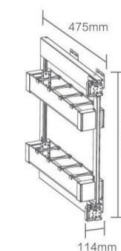
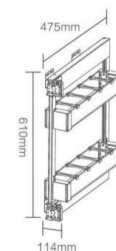

型号 Art.No.	柜体 Cabinet	宽度x深度x高度 WidthxDepthxHeight	描述 Description
KL150-左	150mm	114x475x610mm	右侧取物 Hinge on left, not customisable 高度、层数可定制，宽度深度不可定制
KL150-右	150mm	114x475x610mm	左侧取物 Hinge on right, not customisable 高度、层数可定制，宽度深度不可定制
KL200-左	200mm	164x475x610mm	右侧取物 Hinge on left, not customisable 高度、层数可定制，宽度深度不可定制
KL200-右	200mm	164x475x610mm	左侧取物 Hinge on right, not customisable 高度、层数可定制，宽度深度不可定制



## FULL-ALUMINUM HIGH-SIDE PULLING BASKET-3 FLOORS

### 全铝高身侧拉篮-3层

连动设计，丝滑顺畅，排列整齐，方便取物，无需困扰

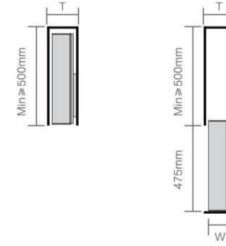

高度、层数可定制，宽度深度不可定制

安装方式：抽拉式

Height and number of layers can be customised.

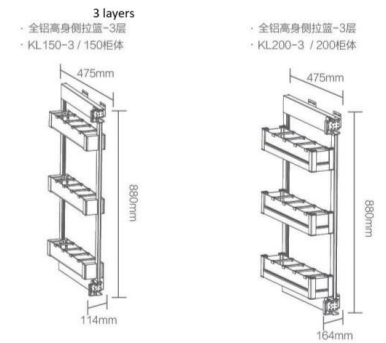

型号 Art.No.	柜体 Cabinet	宽度x深度x高度 WidthxDepthxHeight	层数 Number	描述 Description
KL150-3左	150mm	114x475x880mm	3层 3 layers	Drawer height 1000-1200mm Hinge on left 适合柜体高度1000-1200mm 右侧取物
KL150-3右	150mm	114x475x880mm	3层	1000-1200mm Hinge on right 适合柜体高度1000-1200mm 左侧取物
KL200-3左	200mm	164x475x880mm	3层	1000-1200mm Hinge on left 适合柜体高度1000-1200mm 右侧取物
KL200-3右	200mm	164x475x880mm	3层	1000-1200mm Hinge on right 适合柜体高度1000-1200mm 左侧取物



## FULL-ALUMINUM HIGH-SIDE PULLING BASKET-4 FLOORS

### 全铝高身侧拉篮-4层

联动设计，丝滑顺畅，排列整齐，方便取物，无需困扰

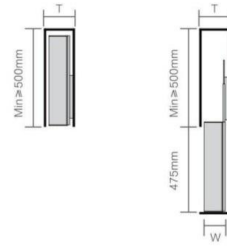

Height and layers customisable

高度、层数可定制，宽度深度不可定制

安装方式：抽拉式

4 layers  
· 全铝高身侧拉篮-4层  
· KL150-4 / 150柜体

· 全铝高身侧拉篮-4层  
· KL200-4 / 200柜体

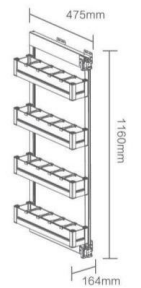
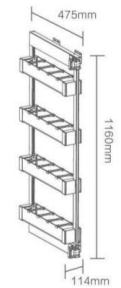

型号 Art.No.	柜体 Cabinet	宽度x深度x高度 WidthxDepthxHeight	层数 Number	描述 Description
KL150-4左	150mm	114x475x1160mm	4层 4 layers	Cabinet height 适用柜体高度1300-1500mm Hinge on left 右侧取物
KL150-4右	150mm	114x475x1160mm	4层	适用柜体高度1300-1500mm Hinge on right 左侧取物
KL200-4左	200mm	164x475x1160mm	4层	适用柜体高度1300-1500mm Hinge on left 右侧取物
KL200-4右	200mm	164x475x1160mm	4层	适用柜体高度1300-1500mm Hinge on right 左侧取物



## FULL-ALUMINUM HIGH-SIDE PULLING BASKET-5 FLOORS

### 全铝高身侧拉篮-5层

连动设计，丝滑顺畅，排列整齐，方便取物，无需困扰

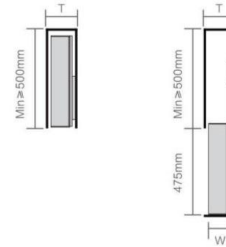

Height and layers customisable

高度、层数可定制，宽度深度不可定制

安装方式：抽拉式

· 全铝高身侧拉篮-5层 5 layers  
· KL150-5 / 150柜体

· 全铝高身侧拉篮-5层  
· KL200-5 / 200柜体

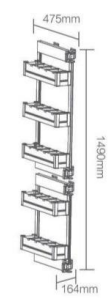
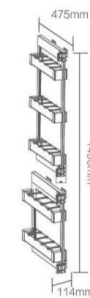

型号 Art.No.	柜体 Cabinet	宽度x深度x高度 WidthxDepthxHeight	层数 Number	描述 Description
KL150-5左	150mm	114x475x1490mm	5层 5 layers	Cabinet height 适合柜体高度1600-1800mm Hinge on left 右侧取物
KL150-5右	150mm	114x475x1490mm	5层	适合柜体高度1600-1800mm Hinge on right 左侧取物
KL200-5左	200mm	164x475x1490mm	5层	适合柜体高度1600-1800mm Hinge on left 右侧取物
KL200-5右	200mm	164x475x1490mm	5层	适合柜体高度1600-1800mm Hinge on right 左侧取物





## FULL-ALUMINUM HIGH-SIDE PULLING BASKET-6 FLOORS

### 全铝高身侧拉篮-6层

连动设计，丝滑顺畅，排列整齐，方便取物，无需困扰

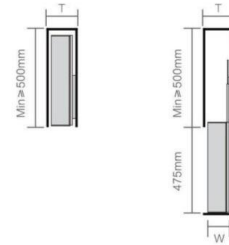

Height and layers customisable  
 高度、层数可定制，宽度深度不可定制  
 安装方式：抽拉式

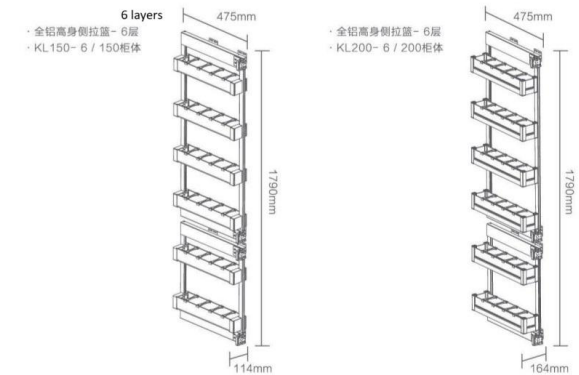

型号 Art.No.	柜体 Cabinet	宽度x深度x高度 WidthxDepthxHeight	层数 Number	描述 Description
KL150-6左	150mm	114x475x1790mm	6 layers (4+2 configuration) 6层(4+2结构)	Cabinet height 适用柜体高度1850-2000mm Hinge on left 右侧取物
KL150-6右	150mm	114x475x1790mm	6层(4+2结构)	适用柜体高度1850-2000mm Hinge on right 左侧取物
KL200-6左	200mm	164x475x1790mm	6层(4+2结构)	适用柜体高度1850-2000mm Hinge on left 右侧取物
KL200-6右	200mm	164x475x1790mm	6层(4+2结构)	适用柜体高度1850-2000mm Hinge on right 左侧取物



## BALCONY SIDE PULL BASKET

### 阳台动动多功能侧拉篮

实现功能阳台的专业收纳，洞洞板设计，将工具、清洁用具等分类收纳其中，用抽拉的方式，把物品带出柜体。

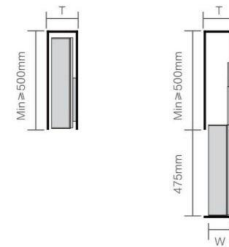

- 阳台动动多功能侧拉篮
- KL200-6Y/200-400柜体

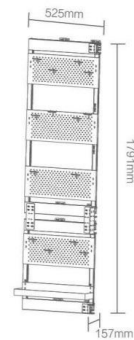

型号 Art.No.	柜体 Cabinet	宽度x深度x高度 WidthxDepthxHeight	层数 Number	描述 Description
KL200-6Y左	200-400mm	157 × 525 × 1791mm	5 layers (3+2 configuration) 5层 (3+2结构)	Hinge on left 右侧取物
KL200-6Y右	200-400mm	157 × 525 × 1791mm	5层 (3+2结构)	Hinge on right 左侧取物



## FULL-ALUMINUM DOOR-LINKED -SIDE HANGING BASKET-6 FLOORS

### 全铝连门侧挂篮-6层

浅柜门板收纳，方便置物，拿取自由，绝不浪费多余空间

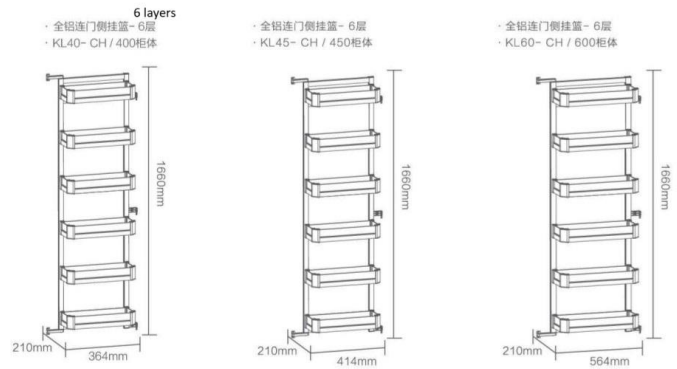
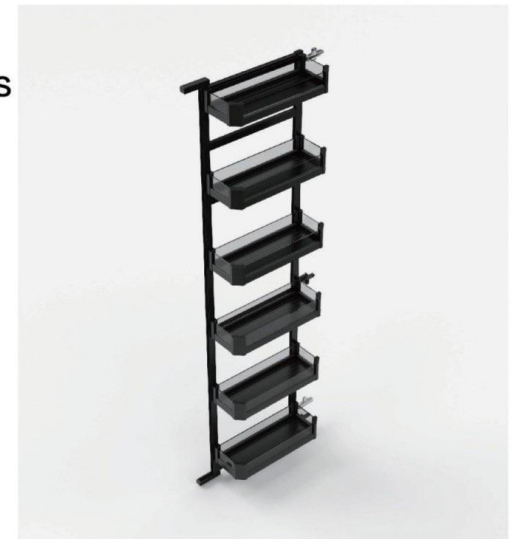
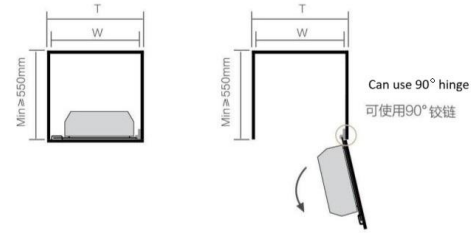

宽度、高度、层数、深度可定制，  
根据实际需求尺寸定制+  
30%-50%价格；

畅销定制柜体宽度：  
350,500,550mm；

畅销定制层数：3,4,5,7层；

Height, width, depth and number of layers  
customisable at additional cost.

Width 350, 500, 550mm. Layers 3, 4, 5 or 7.

型号 Art.No.	柜体 Cabinet	宽度x深度x高度 WidthxDepthxHeight	描述 Description
KL40-CH	400mm	364x210x1660mm	
KL45-CH	450mm	414x210x1660mm	
KL60-CH	600mm	564x210x1660mm	



## SIDE-OPEN LINKED MASS TREASURE-2 FLOORS 侧开连动百纳宝-2层

水槽底及浅柜专用收纳  
建议用于水槽下对开门柜，可避开水槽底部的下水管与净水器。  
用于收纳厨房清洁用品等

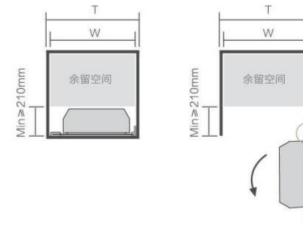

2 layers  
· 侧开连动百纳宝-2层  
· KL40-C / 400柜体

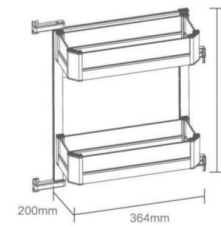

· 侧开连动百纳宝-2层  
· KL45-C / 450柜体

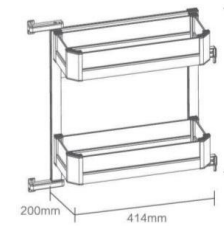

· 侧开连动百纳宝-2层  
· KL60-C / 600柜体

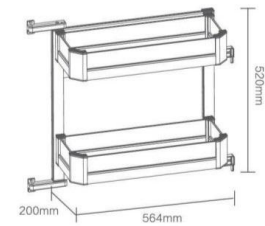

型号 Art.No.	柜体 Cabinet	宽度x深度x高度 WidthxDepthxHeight	描述 Description
KL40-C	400mm	364x200x520mm	
KL45-C	450mm	414x200x520mm	
KL60-C	600mm	564x200x520mm	



## FULL-ALUMINUM FLOOR CABINET LINKED BASKET

### 全铝地柜联动篮

解决地柜收纳烦恼，轻松便捷联动设计，自由拿取日常用品

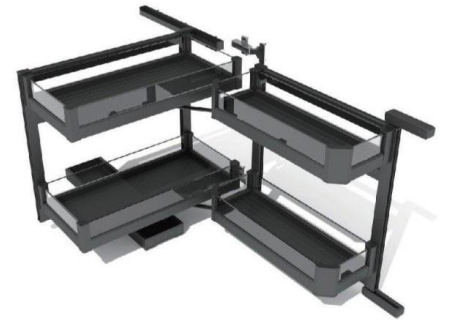
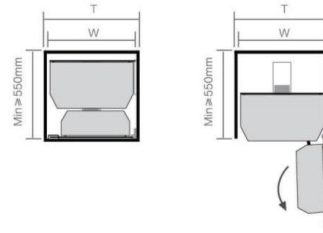

· 全铝地柜联动篮  
· KL40-500 / 400柜体

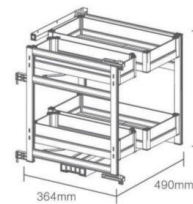

· 全铝地柜联动篮  
· KL45-500 / 450柜体

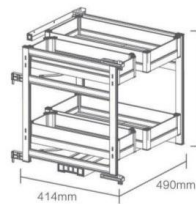

· 全铝地柜联动篮  
· KL60-500 / 600柜体

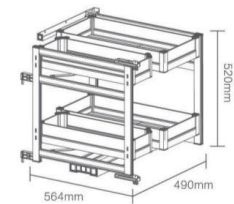

· 宽度、高度、层数、深度可定制，  
根据实际需求尺寸定制  
+30%-50%价格；

畅销定制柜体宽度：  
350,500,550mm；

畅销定制层数：3,4,5,7层；

Height, width, depth and number of layers  
customisable at additional cost.

Width 350, 500, 550mm. Layers 3, 4, 5 or 7.

型号 Art.No.	柜体 Cabinet	宽度x深度x高度 WidthxDepthxHeight	描述 Description
KL40-500	400mm	364x490x520mm	Cabinet height 适用柜体高度550-700mm
KL45-500	450mm	414x490x520mm	适用柜体高度550-700mm
KL60-500	600mm	564x490x520mm	适用柜体高度550-700mm



## FULL-ALUMINUM WALL CUPBOARD LIFTING BASKET

### 全铝吊柜升降篮

双层容量收纳，轻松下降眼前，伸手即可拿取

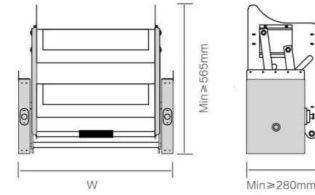

· 全铝吊柜升降篮-1系  
· KL60S-1 / 600柜体  
两层底板全平

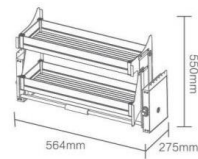

· 全铝吊柜升降篮 1系  
· KL70S-1 / 700柜体

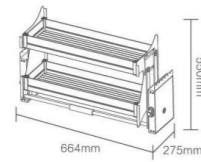

· 全铝吊柜升降篮 1系  
· KL80S-1 / 800柜体

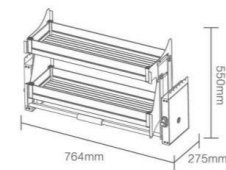

· 全铝吊柜升降篮 1系  
· KL90S-1 / 900柜体

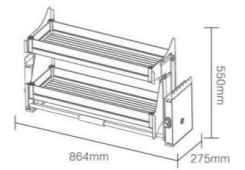

· 宽度可定制，深度高度不可定制；  
根据实际需求尺寸定制  
+30%-50%价格；

Width customisable at extra cost.

型号 Art.No.	柜体 Cabinet	宽度x深度x高度 WidthxDepthxHeight	描述 Description
KL60S-1	600mm	564x275x550mm	
KL70S-1	700mm	664x275x550mm	
KL80S-1	800mm	764x275x550mm	
KL90S-1	900mm	864x275x550mm	



## COLANI-UPPER CABINET LIFTING BASKET

### 克拉尼上柜升降篮

游艇弧线造型设计，皮革腰线设计点缀。内有活动分隔，可分类储物。



产品标准配色为米黄色如需定制其他颜色另加  
100元/套



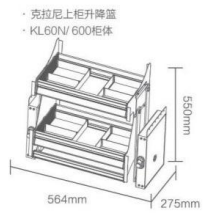
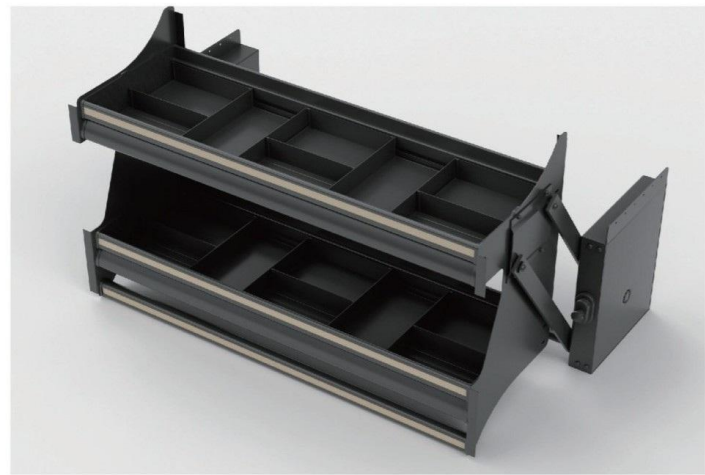

· 非标柜体宽度可定制

Width customisable.

型号 Art.No.	柜体 Cabinet	宽度x深度x高度 WidthxDepthxHeight
KL60N	600mm	564 × 275 × 550mm
KL70N	700mm	664 × 275 × 550mm
KL80N	800mm	764 × 275 × 550mm
KL90N	900mm	864 × 275 × 550mm





## YIDONG DRAWER IN DRAWER MASS TREASURE

### 意动抽中抽百纳宝

灵活自由收纳空间，满足所有厨具分类

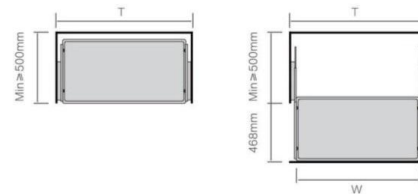

· 意动抽中抽百纳宝  
· KL500-CG / 500柜体

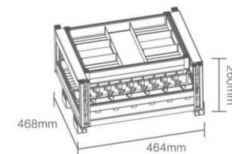

· 意动抽中抽百纳宝  
· KL600-CG / 600柜体

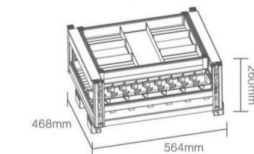

· 意动抽中抽百纳宝  
· KL700-CG / 700柜体

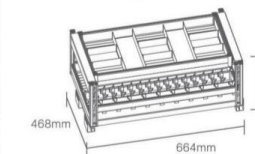

· 意动抽中抽百纳宝  
· KL750-CG / 750柜体

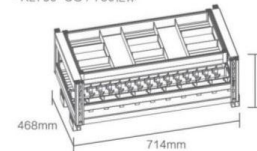

· 意动抽中抽百纳宝  
· KL800-CG / 800柜体

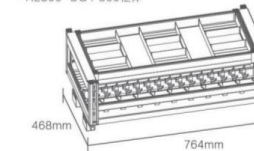

· 意动抽中抽百纳宝  
· KL900-CG / 900柜体

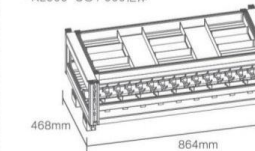

· 深度可定制560mm范围内，深度畅销款建议定制510、550mm，宽度可定制，根据实际需求尺寸定制+30%-50%价格；

Depth customisable, 510 or 550mm at additional cost.

型号 Art.No.	柜体 Cabinet	宽度x深度x高度 WidthxDepthxHeight	描述 Description
KL500-CG	500mm	464x468x260mm	Track adjustments 柜体调节+4mm; -4mm
KL600-CG	600mm	564x468x260mm	柜体调节+4mm; -4mm
KL700-CG	700mm	664x468x260mm	柜体调节+4mm; -4mm
KL750-CG	750mm	714x468x260mm	柜体调节+4mm; -4mm
KL800-CG	800mm	764x468x260mm	柜体调节+4mm; -4mm
KL900-CG	900mm	864x468x260mm	柜体调节+4mm; -4mm



## YIDONG SEASONING DRAWER IN DRAWER MASS TREASURE

### 意动调味抽中抽百纳宝

简约的调味空间，极致的收纳享受

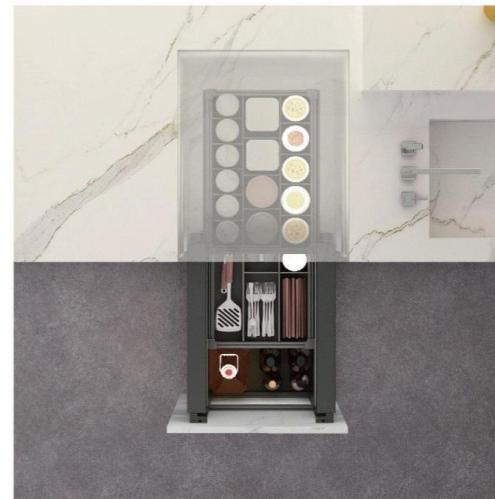
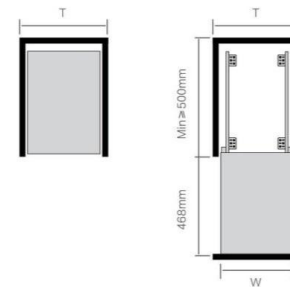

· 意动调味抽中抽百纳宝  
· KL300-CT / 300柜体



· 意动调味抽中抽百纳宝  
· KL350-CT / 350柜体



· 意动调味抽中抽百纳宝  
· KL400-CT / 400柜体



· 意动调味抽中抽百纳宝  
· KL450-CT / 450柜体

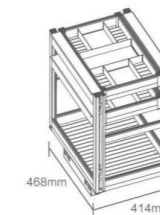

· 意动调味抽中抽百纳宝  
· KL500-CT / 500柜体

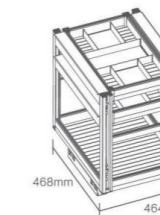

· 深度可定制560mm范围内，  
深度畅销款建议定制510、550mm，  
宽度可定制，根据实际需求尺寸  
定制+30%-50%价格；

Depth customisable, 510 or 550mm at  
additional cost

型号 Art.No.	柜体 Cabinet	宽度x深度x高度 WidthxDepthxHeight	描述 Description
KL300-CT	300mm	264x468x550mm	Track side or bottom mounted 侧装、底装通用滑轨
KL350-CT	350mm	314x468x550mm	侧装、底装通用滑轨
KL400-CT	400mm	364x468x550mm	侧装、底装通用滑轨
KL450-CT	450mm	414x468x550mm	侧装、底装通用滑轨
KL500-CT	500mm	464x468x550mm	侧装、底装通用滑轨



## FULL-ALUMINUM DISH BASKET-BOWL BASKET (THREE EDGES)

### 全铝碗盘篮-碗篮 (三边)

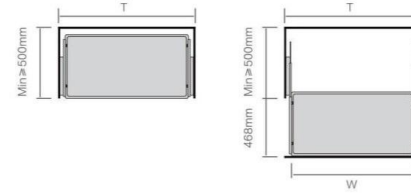

· 全铝碗盘篮-碗篮 (三边)  
· KL500-W / 500柜体

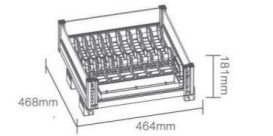

· 全铝碗盘篮-碗篮 (三边)  
· KL600-W / 600柜体

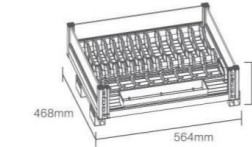

· 全铝碗盘篮-碗篮 (三边)  
· KL700-W / 700柜体

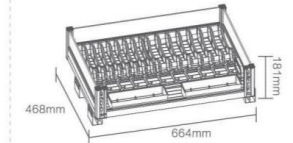

· 全铝碗盘篮-碗篮 (三边)  
· KL750-W / 750柜体

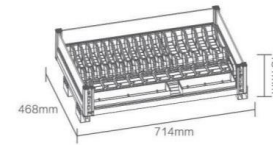

· 全铝碗盘篮-碗篮 (三边)  
· KL800-W / 800柜体

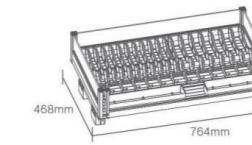

· 全铝碗盘篮-碗篮 (三边)  
· KL900-W / 900柜体

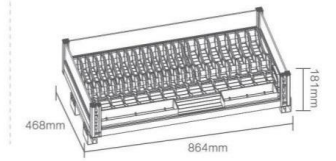

· 深度可定制280-560mm范围内，  
深度畅销款建议定制510、550mm，  
宽度可定制，根据实际需求尺寸  
定制+30%-50%价格；

Depth customisable between 280 - 560mm.  
Most common customised depth 510 or  
550mm. Width is also customisable. All  
customisable at additional cost.

型号 Art.No.	柜体 Cabinet	宽度x深度x高度 WidthxDepthxHeight	描述 Description
KL500-W	500mm	464x468x181mm	Track adjustment 柜体调节+4mm; -4mm
KL600-W	600mm	564x468x181mm	柜体调节+4mm; -4mm
KL700-W	700mm	664x468x181mm	柜体调节+4mm; -4mm
KL750-W	750mm	714x468x181mm	柜体调节+4mm; -4mm
KL800-W	800mm	764x468x181mm	柜体调节+4mm; -4mm
KL900-W	900mm	864x468x181mm	柜体调节+4mm; -4mm



## FULL-ALUMINUM DISH BASKET-FLAT BASKET (THREE EDGES)

全铝碗盘篮-平篮（三边）

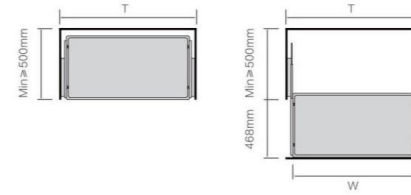

· 全铝碗盘篮-平篮（三边）  
· KL500-P / 500柜体

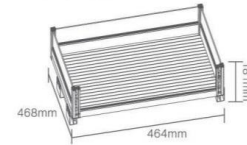

· 全铝碗盘篮-平篮（三边）  
· KL600-P / 600柜体

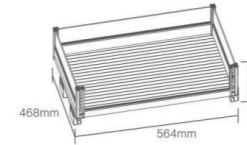

· 全铝碗盘篮-平篮（三边）  
· KL700-P / 700柜体

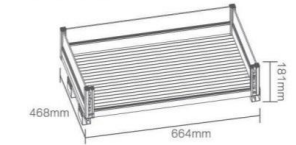

· 全铝碗盘篮-平篮（三边）  
· KL750-P / 750柜体

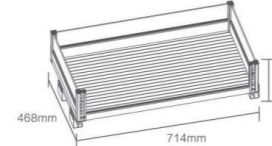

· 全铝碗盘篮-平篮（三边）  
· KL800-P / 800柜体



· 全铝碗盘篮-平篮（三边）  
· KL900-P / 900柜体

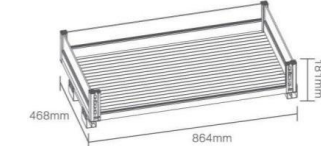

· 深度可定制280-560mm范围内，  
深度畅销款建议定制510、550mm，  
宽度可定制，根据实际需求尺寸  
定制+30%-50%价格；

Depth customisable between 280 - 560mm.  
Most common customised depth 510 or  
550mm. Width is also customisable. All  
customisable at additional cost.

型号 Art.No.	柜体 Cabinet	宽度x深度x高度 WidthxDepthxHeight	描述 Description
KL500-P	500mm	464x468x181mm	Track adjustment 柜体调节+4mm; -4mm
KL600-P	600mm	564x468x181mm	柜体调节+4mm; -4mm
KL700-P	700mm	664x468x181mm	柜体调节+4mm; -4mm
KL750-P	750mm	714x468x181mm	柜体调节+4mm; -4mm
KL800-P	800mm	764x468x181mm	柜体调节+4mm; -4mm
KL900-P	900mm	864x468x181mm	柜体调节+4mm; -4mm



## FULL-ALUMINUM DISH BASKET-BOWL BASKET (FOUR EDGES)

全铝碗盘篮-碗篮（四边）

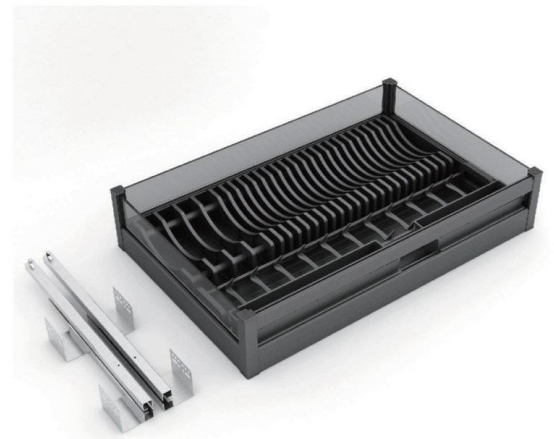
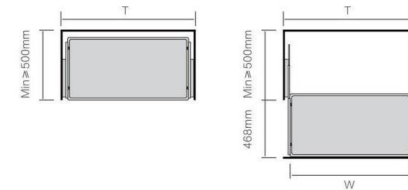

·全铝碗盘篮-碗篮（四边）  
·KL500-W4 / 500柜体

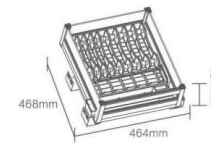

·全铝碗盘篮-碗篮（四边）  
·KL600-W4 / 600柜体



·全铝碗盘篮-碗篮（四边）  
·KL700-W4 / 700柜体

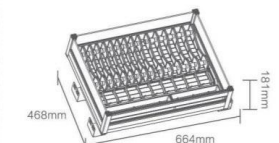

·全铝碗盘篮-碗篮（四边）  
·KL750-W4 / 750柜体

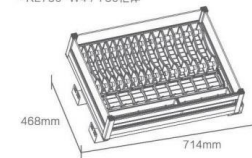

·全铝碗盘篮-碗篮（四边）  
·KL800-W4 / 800柜体

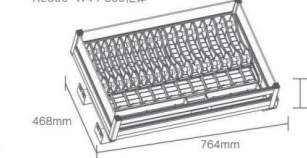

·全铝碗盘篮-碗篮（四边）  
·KL900-W4 / 900柜体

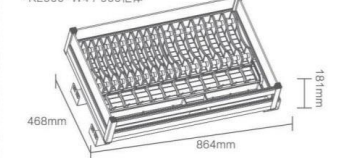

·宽度可定制，深度不可定制，  
根据实际需求尺寸定制  
+30%-50%价格；

安装方式：开门式

Width customisable at additional cost.

Can only be used with swing doors.

型号 Art.No.	柜体 Cabinet	宽度x深度x高度 WidthxDepthxHeight	描述 Description
KL500-W4	500mm	464x468x181mm	Track adjustment 柜体调节-4mm
KL600-W4	600mm	564x468x181mm	柜体调节-4mm
KL700-W4	700mm	664x468x181mm	柜体调节-4mm
KL750-W4	750mm	714x468x181mm	柜体调节-4mm
KL800-W4	800mm	764x468x181mm	柜体调节-4mm
KL900-W4	900mm	864x468x181mm	柜体调节-4mm



## FULL-ALUMINUM DISH BASKET-FLAT BASKET (FOUR EDGES)

全铝碗盘篮-平篮（四边）

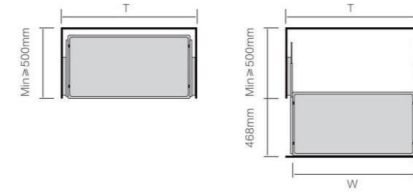

· 全铝碗盘篮-平篮（四边）  
· KL500-P4 / 500柜体

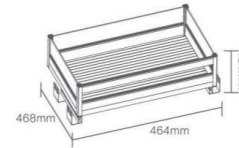

· 全铝碗盘篮-平篮（四边）  
· KL600-P4 / 600柜体

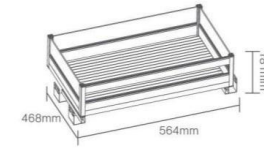

· 全铝碗盘篮-平篮（四边）  
· KL700-P4 / 700柜体

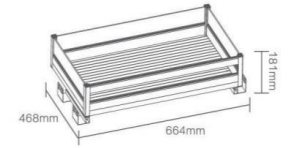

· 全铝碗盘篮-平篮（四边）  
· KL750-P4 / 750柜体

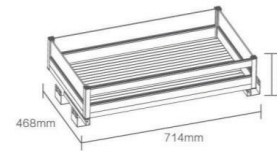

· 全铝碗盘篮-平篮（四边）  
· KL800-P4 / 800柜体

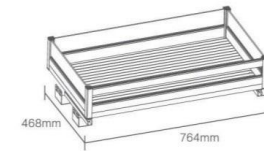

· 全铝碗盘篮-平篮（四边）  
· KL900-P4 / 900柜体

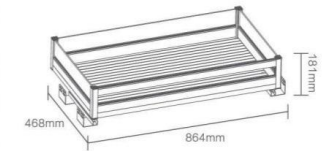

· 宽度可定制，深度不可定制，  
根据实际需求尺寸定制  
+30%-50%价格；

安装方式：开门式

Width customisable at additional cost.

Can only be used with swing doors.

型号 Art.No.	柜体 Cabinet	宽度x深度x高度 WidthxDepthxHeight	描述 Description
KL500-P4	500mm	464x468x181mm	Track adjustments 柜体调节-4mm
KL600-P4	600mm	564x468x181mm	柜体调节-4mm
KL700-P4	700mm	664x468x181mm	柜体调节-4mm
KL750-P4	750mm	714x468x181mm	柜体调节-4mm
KL800-P4	800mm	764x468x181mm	柜体调节-4mm
KL900-P4	900mm	864x468x181mm	柜体调节-4mm



## FULL-ALUMINUM SEASONING BASKET

### 全铝调味篮

分类分区存储，自由调节板块，满足多种搭配收纳需求

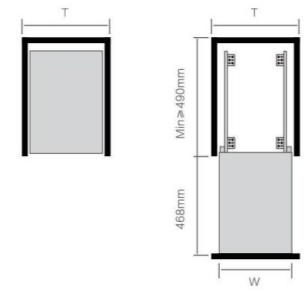





·全铝调味篮  
·200-250柜体



·全铝调味篮  
·300-500柜体



·全铝调味篮  
·KL200-T / 200柜体

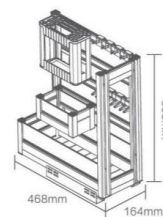

·全铝调味篮  
·KL250-T / 250柜体

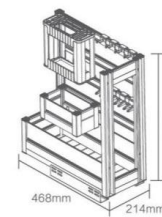

·全铝调味篮  
·KL300-T / 300柜体

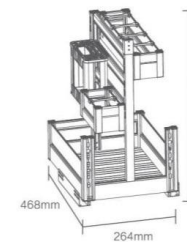

·全铝调味篮  
·KL350-T / 350柜体

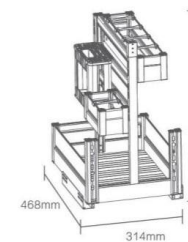

·全铝调味篮  
·KL400-T / 400柜体

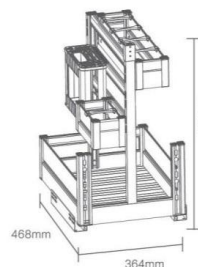

·全铝调味篮  
·KL450-T / 450柜体

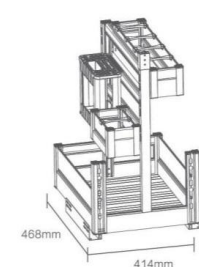

·全铝调味篮  
·KL500-T / 500柜体

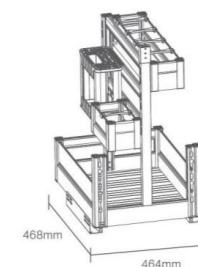

·深度可定制280-560mm范围内，  
深度畅销款建议定制510、550mm，

宽度可定制，根据实际需求尺寸  
定制+30%-50%价格；

Depth customisable, 510 or 550mm at  
additional cost

型号 Art.No.	柜体 Cabinet	宽度x深度x高度 WidthxDepthxHeight	描述 Description
KL200-T	200mm	164x468x555mm	Track side or bottom mounted 侧装、底装通用滑轨, 左取物/右取物
KL250-T	250mm	214x468x555mm	侧装、底装通用滑轨, 左取物/右取物
KL300-T	300mm	264x468x605mm	侧装、底装通用滑轨, 左取物/右取物
KL350-T	350mm	314x468x605mm	侧装、底装通用滑轨, 左取物/右取物
KL400-T	400mm	364x468x605mm	侧装、底装通用滑轨, 左取物/右取物
KL450-T	450mm	414x468x605mm	侧装、底装通用滑轨, 左取物/右取物
KL500-T	500mm	464x468x605mm	侧装、底装通用滑轨, 左取物/右取物



## FULL-ALUMINUM SEPARATED DRAWER (THREE EDGES)

### 全铝分隔抽(三边)

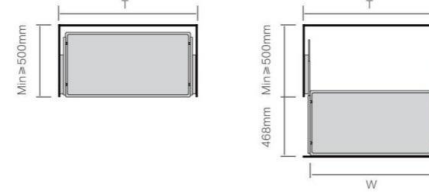

· 全铝分隔抽 (三边)  
· KL45-F / 450柜体

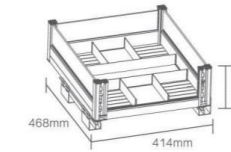

· 全铝分隔抽 (三边)  
· KL50-F / 500柜体

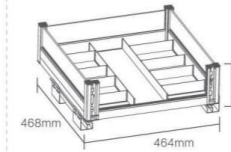

· 全铝分隔抽 (三边)  
· KL60-F / 600柜体

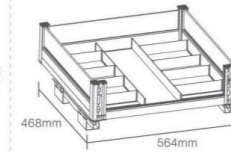

· 全铝分隔抽 (三边)  
· KL70-F / 700柜体

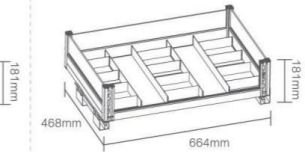

· 全铝分隔抽 (三边)  
· KL75-F / 750柜体

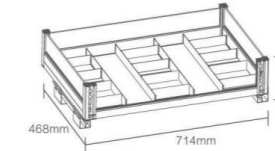

· 全铝分隔抽 (三边)  
· KL80-F / 800柜体

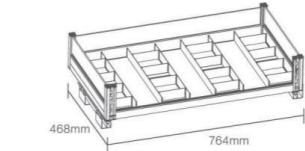

· 全铝分隔抽 (三边)  
· KL90-F / 900柜体

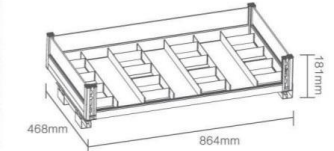

· 深度可定制280-560mm范围内,  
深度畅销款建议定制510、550mm,  
宽度可定制,

根据实际需求尺寸定制  
+30%-50%价格;

Depth customisable between 280 - 560mm.  
Most common customised depth 510 or  
550mm. Width is also customisable. All  
customisable at additional cost.

型号 Art.No.	柜体 Cabinet	宽度x深度x高度 WidthxDepthxHeight	描述 Description
KL45-F	450mm	414x468x181mm	Track adjustments 柜体调节+4mm; -4mm
KL50-F	500mm	464x468x181mm	柜体调节+4mm; -4mm
KL60-F	600mm	564x468x181mm	柜体调节+4mm; -4mm
KL70-F	700mm	664x468x181mm	柜体调节+4mm; -4mm
KL75-F	750mm	714x468x181mm	柜体调节+4mm; -4mm
KL80-F	800mm	764x468x181mm	柜体调节+4mm; -4mm
KL90-F	900mm	864x468x181mm	柜体调节+4mm; -4mm

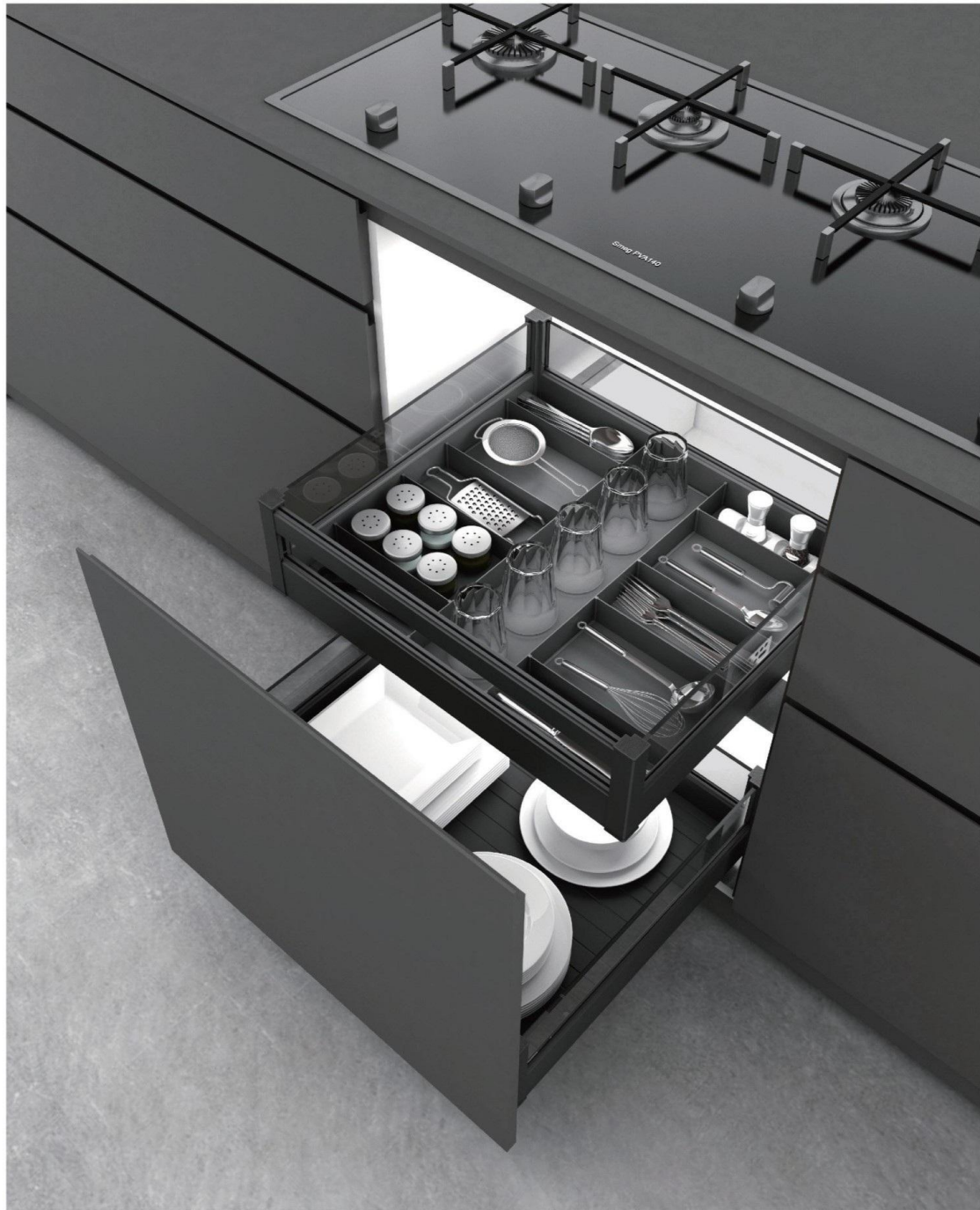

## FULL-ALUMINUM SEPARATED DRAWER (FOUR EDGES)

### 全铝分隔抽(四边)

隔断收纳, 有序分类, 存储更安心, 拿取更清晰

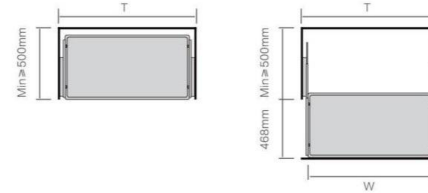
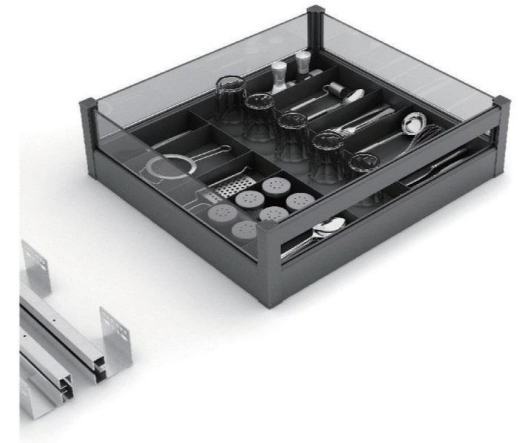

· 全铝分隔抽 (四边)  
· KL45-F4 / 450柜体

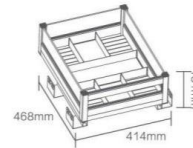

· 全铝分隔抽 (四边)  
· KL50-F4 / 500柜体

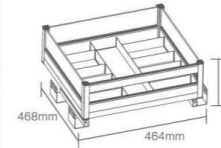

· 全铝分隔抽 (四边)  
· KL60-F4 / 600柜体

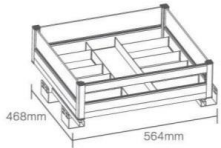

· 全铝分隔抽 (四边)  
· KL70-F4 / 700柜体

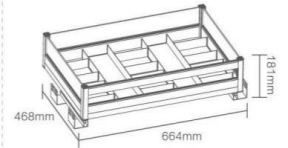

· 全铝分隔抽 (四边)  
· KL75-F4 / 750柜体

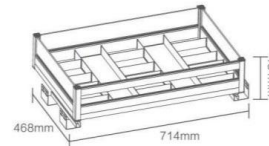

· 全铝分隔抽 (四边)  
· KL80-F4 / 800柜体

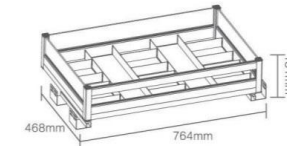

· 全铝分隔抽 (四边)  
· KL90-F4 / 900柜体

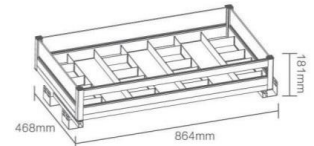

· 宽度可定制, 深度不可定制,  
根据实际需求尺寸  
定制+30%-50%价格;

Width customisable, depth not customisable.  
All customisation at additional cost.

型号 Art.No.	柜体 Cabinet	宽度x深度x高度 WidthxDepthxHeight	描述 Description
KL45-F4	450mm	414x468x181mm	Track adjustment 柜体调节 -4mm
KL50-F4	500mm	464x468x181mm	柜体调节 -4mm
KL60-F4	600mm	564x468x181mm	柜体调节 -4mm
KL70-F4	700mm	664x468x181mm	柜体调节 -4mm
KL75-F4	750mm	714x468x181mm	柜体调节 -4mm
KL80-F4	800mm	764x468x181mm	柜体调节 -4mm
KL90-F4	900mm	864x468x181mm	柜体调节 -4mm



## CUSTOMIZED WATER CHANNEL STORAGE BASKET-LARGE U(TWO-IN-ONE)

### 定制水槽底收纳篮-大U（二合一）

大U收纳常用物品，小U存储实用工具，组合搭配实现槽底收纳自由

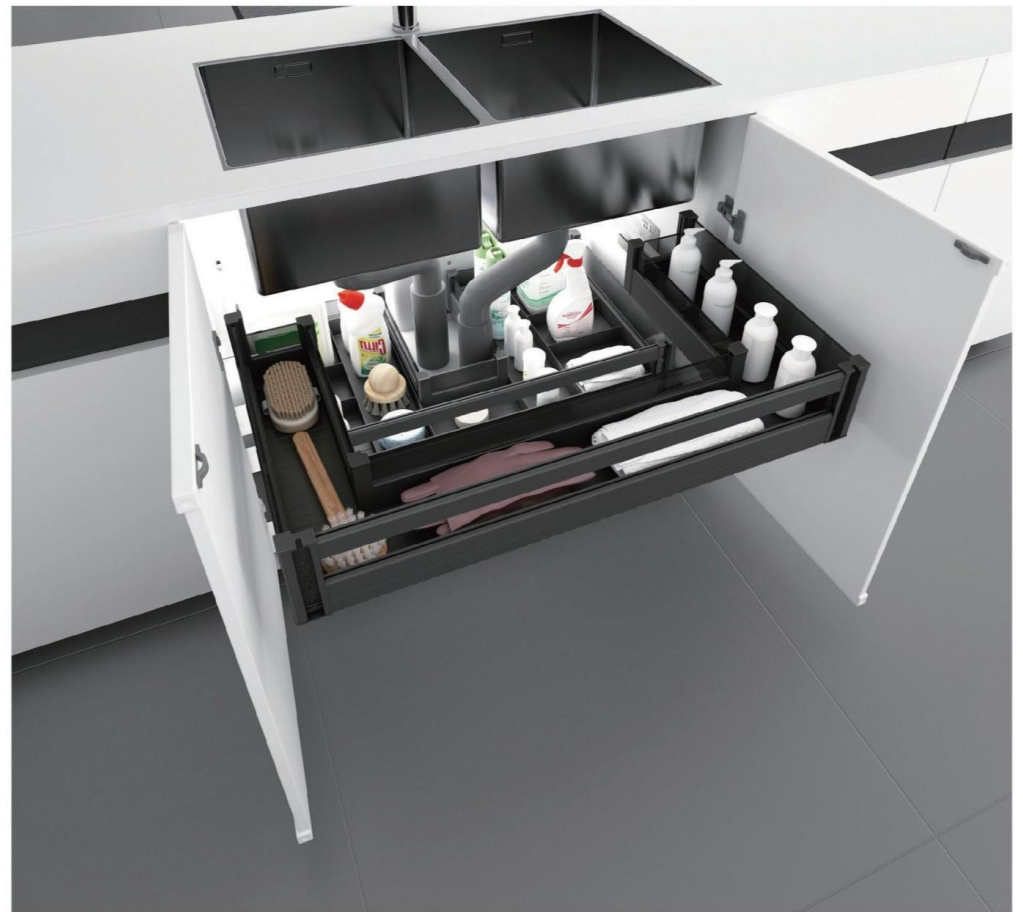
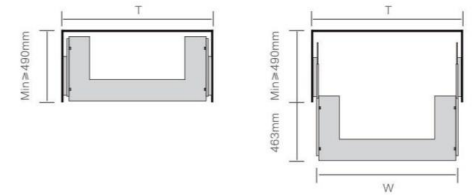

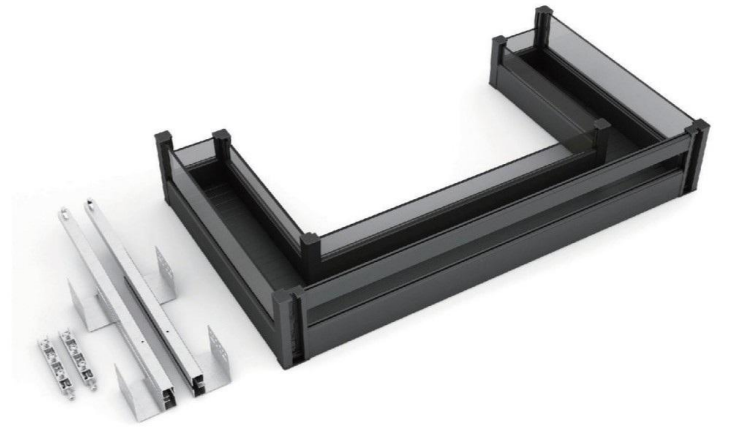
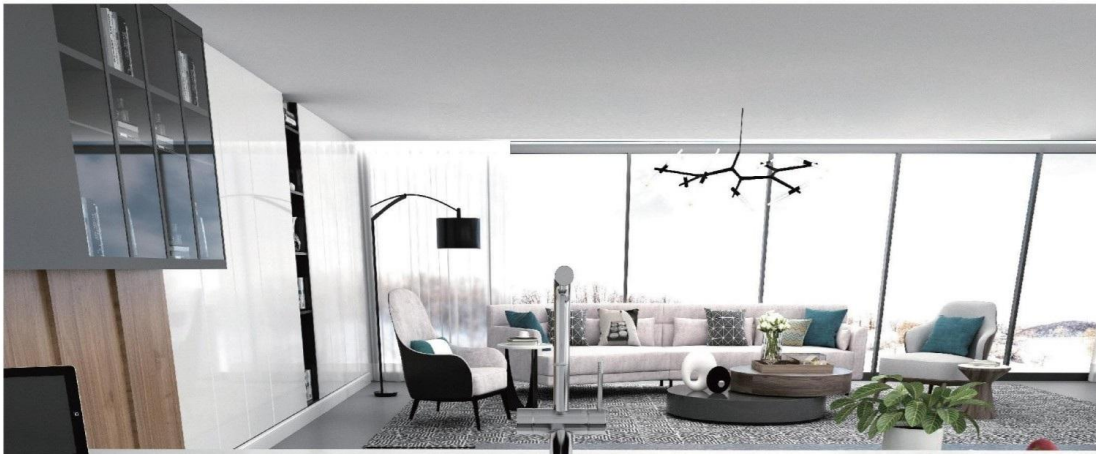

· 定制水槽收纳盖-大U (二合一)  
· KL01-SD34-800 / 800柜体

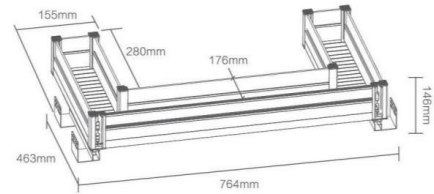

· 定制水槽收纳盖-大U (二合一)  
· KL01-SD34-900 / 900柜体

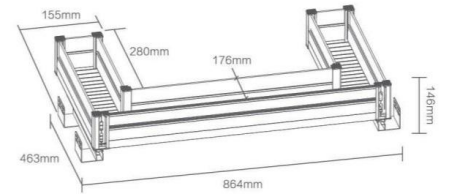

· 宽度可定制, 凹槽尺寸  
可根据水管或障碍物定制,

根据实际需求尺寸定制  
+30%-50%价格;

Width and interior arc customisable  
depending on location of water pipes.  
All customisation at additional cost.

型号 Art.No.	柜体 Cabinet	宽度x深度x高度 WidthxDepthxHeight	描述 Description
KL01-SD34-800	800mm	764x463x146mm	Track adjustments 柜体调节- 4mm
KL01-SD34-900	900mm	864x463x146mm	柜体调节- 4mm



## CUSTOMIZED WATER CHANNEL STORAGE BASKET-SMALL U(TWO-IN-ONE)

### 定制水槽底收纳篮-小U(二合一)

大U收纳常用物品, 小U存储实用工具, 组合搭配实现槽底收纳自由

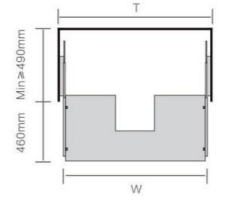
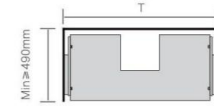

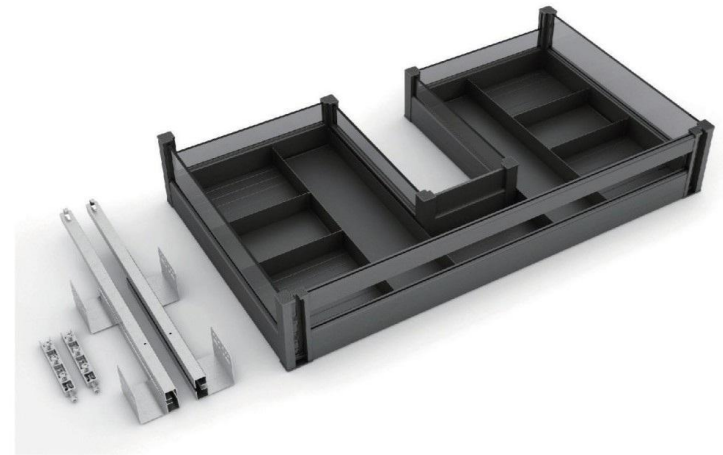
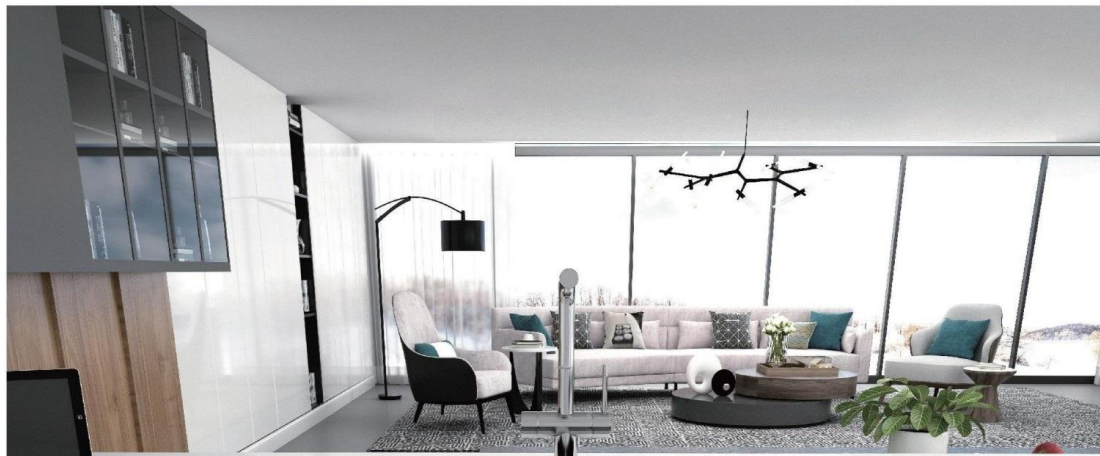

- 定制水槽底收纳篮-小U (二合一)
- KL02-SD34-800 / 800柜体

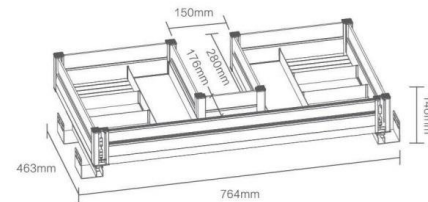

- 定制水槽底收纳篮-小U (二合一)
- KL02-SD34-900 / 900柜体

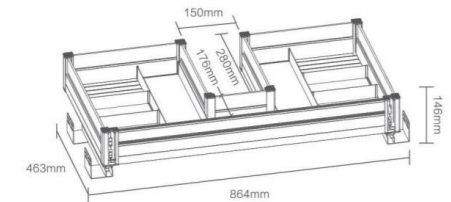

- 宽度可定制，凹槽尺寸可根据水管或障碍物定制，

根据实际需求尺寸定制  
+30%-50%价格；

Width and interior arc is customisable depending on location of water pipes. All customisation at additional cost.

型号 Art.No.	柜体 Cabinet	宽度x深度x高度 WidthxDepthxHeight	描述 Description
KL02-SD34-800	800mm	764x463x146mm	Track adjustments 柜体调节- 4mm
KL02-SD34-900	900mm	864x463x146mm	柜体调节- 4mm



## SINK SIDE PULL-OUT

### 水槽侧拉抽



· 水槽侧拉抽  
· KL300HL- 421SCB / 300柜体

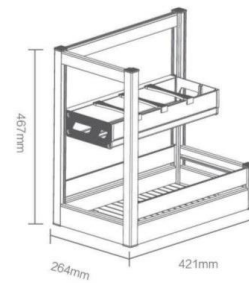

· 水槽侧拉抽  
· KL350HL- 421SCB / 350柜体

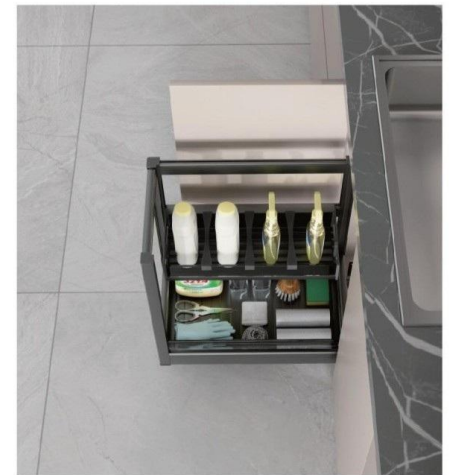
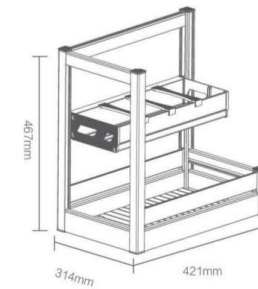

型号 Art.No.	柜体 Cabinet	宽度x深度x高度 WidthxDepthxHeight	层数 Number	描述 Description
KL300HL- 421SCB	300mm	264 × 421 × 467mm	2层 2 layers	
KL350HL- 421SCB	350mm	314 × 421 × 467mm	2层	





## FULL DRAW INVISIBLE LOCKERS

### 全抽隐形储物箱



#### 独立式多格分区

多样化储存米面，双层2区设计  
可放置各类粮食，不混合不串味

#### Stand-alone multi-grid partitioning

Diversified storage of rice noodles, double-layer 2-zone design  
It can place all kinds of grain, no mixing and no flavor



#### 超大容量

加厚耐用，可储存15升大米，桶壁更厚，  
承重更强

#### Extra-large capacity

Thicker and durable, it can store 15 liters of rice, thicker  
barrel walls and stronger load-bearing



#### 嵌入式柜内隐藏

远离油烟，保持整洁，只在需要的时候  
出现，可独立将米箱拿取，清洁打扫更  
便捷

#### Hidden inside built-in cabinet

Keep away from fumes, keep it tidy and only show up  
when needed. The rice box can be taken independently,  
which is more convenient to clean and clean



#### 铝制骨架

防腐防锈，更加坚固，不易变形，防滑  
纹理，增大摩擦不易滑动

#### Aluminum skeleton

Anti-corrosion and anti-rust, more solid, not easy to de-  
form, anti-slip texture, increase friction is not easy to slide

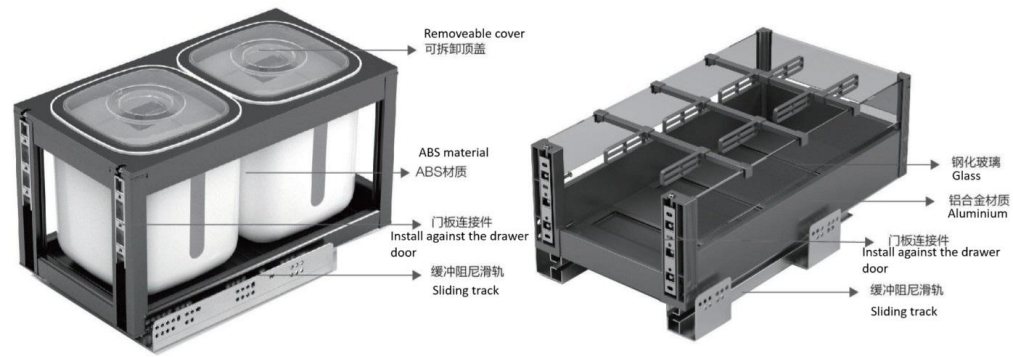

· 文武双全-全隐形储物箱  
· KL2-300MC  
姜与抽屉内可配合抽屉拉篮上下层搭配使用  
2缸每缸容量7.5升

· 储物箱收纳抽可配  
· KL2-300MCC  
配套重物箱安装于重物箱上层或下层

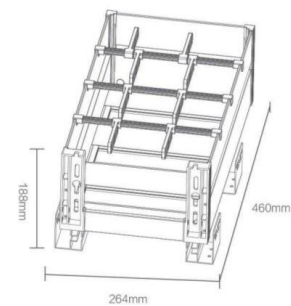
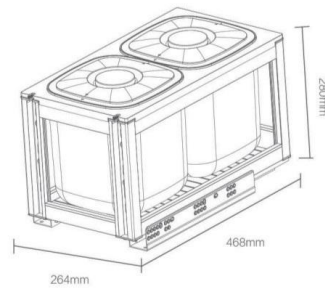

型号 Art.No.	柜体 Cabinet	宽度x深度x高度 WidthxDepthxHeight	描述 Description
KL2-300MC	300mm	264 × 468 × 280mm	Storage capacity of single container 单缸容量7.5L
储物箱收纳抽可配 KL2-300MCC	300mm	264 × 460 × 188mm	Track adjustments 柜体调节+4mm; -4mm



HARRY POTTER-INTELLIGENT  
SMART METERING BINS

哈利·波特-智能计储物箱

一种设计，三份体验，四面环视，多箱储存，密封锁鲜，绚丽夺目，解锁储粮新体验





### 底部双漏斗

底部漏斗设计，出米顺畅，不藏陈米，斜坡式内部结构，时刻保持食材新鲜

#### Double funnel at the bottom

The bottom funnel design allows smooth rice production, no stale rice, and slope-type internal structure to keep ingredients fresh at all times



### 可拆卸手握式顶盖

多个凹槽手握式顶盖，内涵隐形防虫盒，轻松开盖即可添米，有效防虫，祛除异味

#### Removable hand-grip top cover

Multiple grooved hand-gripped top covers, including invisible insect repellent boxes, easy to open the lid to add rice, effectively prevent insects and remove odors



### 嵌入式柜内隐藏

远离油烟，保持整洁，只在需要的时候出现

#### Hidden inside built-in cabinet

Keep away from fumes, keep it tidy and only show up when needed



### 两侧按键式取米

取米盒可独立拿出，按压出米，即松即停，刻度米盒，智能计量

#### Push button on both sides to take rice

The rice box can be taken out independently, press out the rice, that is, loose and stop, scale rice box, intelligent metering

· 设计灵感来源  
Design inspiration



## SMART METERING BINS

### 智能计量储物箱

- 智能计量储物箱-绝代双骄
- KL2-20M / 200柜体



- 智能计量储物箱-四喜临门
- KL4-30M/300柜体浅深度



- 智能计量储物箱-五谷杂粮
- KL5-30M / 300柜体

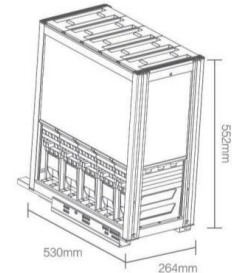
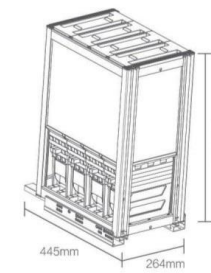
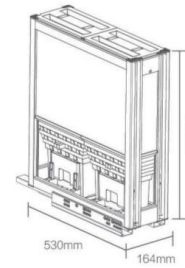

型号 Art.No.	柜体 Cabinet	宽度x深度x高度 WidthxDepthxHeight	描述 Description
KL2-20M	200mm	164 × 530 × 552mm	2 containers, each 5 litres 2缸每缸容量5升
KL4-30M	300mm 浅深度	264 × 445 × 552mm	4 containers, each 5 litres 4缸每缸容量5升
KL5-30M	300mm	264 × 530 × 552mm	5 containers, each 5 litres 5缸每缸容量5升



## BATHROOM STORAGE BASKET

### 卫浴收纳篮

自由定制槽口大小，卫浴收纳易如反掌

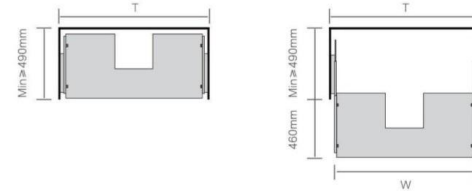

· 卫浴收纳篮  
· DZ-WY35

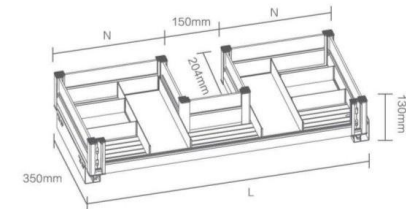

柜体	L / mm	N / mm
600	564mm	207mm
700	664mm	257mm
750	714mm	282mm
800	764mm	307mm
900	864mm	357mm

· 卫浴收纳篮  
· DZ-WY46

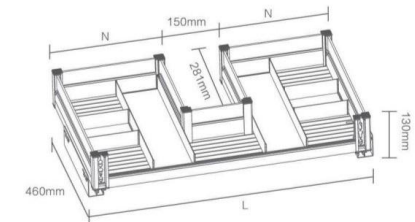

柜体	L / mm	N / mm
600	564mm	207mm
700	664mm	257mm
750	714mm	282mm
800	764mm	307mm
900	864mm	357mm

· 深度定制范围280-560mm，  
凹槽尺寸可根据水管或障碍物定制，

根据实际需求尺寸定制  
+30%-50%价格；

安装方式：抽屉式

Depth customisable between 280 - 560mm.  
Internal arc can be customised according to  
customers requirements. All customisation at  
additional cost. Drawer installation.

型号 Art.No.	宽度x深度x高度 WidthxDepthxHeight	描述 Description
DZ-WY35	宽度refer to tables above 宽度x350x130mm	Track adjustments 柜体调节+4mm；-4mm
DZ-WY46	宽度x460x130mm	柜体调节+4mm；-4mm