



# JINDAL

Pipes and Tanks



## PRICE LIST

JUNE 2024



### COMPLETE PLUMBING AND BATHROOM SOLUTION

CPVC | uPVC | SWR | AGRI PIPES | CONDUIT | WATER TANKS | HDPE PIPES | SPRINKLER SYSTEM | PTMT TAPS | SANITARY PRODUCTS

Phone : +91 11 4525 900

Email : info@jindalplast.com

Website : www.jindalplast.com

# Welcome to Jindal Sanitaryware Private Limited

Catalogue cum Price List: JUNE 2024

## TERMS AND CONDITIONS:-

1. IGST/CGST/SGST/UGST/ will be charged extra as applicable.
2. Any revision in existing duties or any new levies introduced will be to buyer's account at the time of dispatch.
3. The company reserves the right to alter the prices, terms and conditions without prior notice.
4. Price prevailing on the date of dispatch will be applicable.
5. Order may be executed in part or full depending on the availability of the stock.
6. Supplies will be made in standard packing only, if applicable.
7. This Price list supersedes all our earlier price lists.
8. Warranty not applicable in case of use of combination with any other brand/make of pipe, fittings & solvent/lubricant.
9. Interest will be charged @24% Per Annum for delayed payment beyond 30 days from the date of invoice.
10. All disputes are subject to Haryana/Delhi Jurisdiction only.
11. The seller shall not be responsible for the selection of sizes, pressure ratings and type of pipes as well as the technical and commercial viability and suitability of pipes for Buyer's needs and application(s). The seller shall not be responsible for failure of pipes/pipeline or non-working of pipeline of any sort except for the manufacturing defect of the pipes during warranty period as agreed.





# CONTENT



<b>ABOUT US</b>	<b>01</b>
<b>CERTIFICATIONS</b>	<b>02</b>
<b>OUR PRODUCTS</b>	<b>04</b>
<b>CPVC PIPES &amp; FITTINGS</b>	<b>08</b>
<b>uPVC ASTM PIPES &amp; FITTINGS</b>	<b>10</b>
<b>SWR DRAINAGE SYSTEM</b>	<b>12</b>
<b>uPVC PRESSURE PIPES &amp; FITTINGS</b>	<b>16</b>
<b>GARDEN PIPES</b>	<b>18</b>
<b>SOLVENT CEMENT</b>	<b>19</b>
<b>HDPE PIPES &amp; COILS</b>	<b>20</b>
<b>HDPE SPRINKLER SYSTEM</b>	<b>22</b>
<b>uPVC CONDUIT PIPES &amp; FITTINGS</b>	<b>23</b>
<b>WATER STORAGE TANKS</b>	<b>24</b>
<b>MILK BUCKETS &amp; CONTAINERS</b>	<b>26</b>
<b>PTMT TAPS</b>	<b>27</b>
<b>EXPOSED CISTERN   FLUSH TANKS</b>	<b>31</b>
<b>CONCEALED CISTERN   IN-WALL CISTERN</b>	<b>33</b>
<b>TOILET SEAT COVERS</b>	<b>34</b>
<b>BATHROOM FITTINGS &amp; ACCESSORIES</b>	<b>36</b>

# ABOUT US

Based in India, for more than four decades we have been spearheading the plumbing and sanitaryware Industry. With multiple innovations and developments, we have retained a leading market share.

At Jindal Sanitaryware Pvt. Ltd., as a complete water solution provider we are proud to be the pioneer of the sanitaryware industry in India while playing a Pivotal role in the countries development.

**Founded in 1980 by Sh. Ram Niwas Jindal, Jindal Plast has come a long way from its humble beginnings.**

Started with the vision of eco-friendly water solutions in mind, Jindal Plast has for sure been able to achieve in many terms what it was intended for. With multiple high capacity production plants across India, we are one of the largest producers of bathroom and plumbing solutions across the country.

We are recognized as a leader in design and innovation, Plumbing and Bathroom fixtures, taps, sanitaryware products and accessories for residential, commercial and industrial markets nationwide.

We are dedicated to providing a consistently reliable and modern range of high-quality products and services. Therefore, Our products are made under the strict supervision of highly qualified and experienced technical personnel. Our high-grade raw materials, superior workmanship subjected to severe quality controls at various stages, and massive infrastructure are all controlled under one roof. Our in house research and development division works to improve the quality of our products.

We have a Complete Range of Plumbing, Sanitary, Road Safety and waste management Products with advanced technology, Our customers can avail all our Products and Services from anywhere in India.

We have wide range of products. Our Pipes and Fittings are available in CPVC (Chlorinated Polyvinyl chloride), uPVC (un-Plasticised Polyvinyl chloride), HDPE (High Density Polyethylene), DWC (Double Wall Corrugated), MDPE (Medium Density Polyethylene), & HDPE PLB Duct.

with applications in households, industries Agriculture, electrical purposes, offices, communication lines, etc. In addition we also provide SWR (Soil, Waste & Rain) Drainage System, uPVC Conduit Pipes and Fittings. We also produce Water Storage Tanks, Milk Buckets and Containers.

Our Sanitaryware portfolio includes: PTMT Taps, Toilet seat covers (UF and PP available in soft close-and hard close), Concealed Cistern (In-wall Cistern), Exposed Cistern Flush Tanks), Internal Mechanisms (Flush valves and Fill valves), Mirror Cabinets, Stainless Steel Kitchen Sinks and a wide range of Bathroom Fittings and Accessories.

Our Road Safety and waste management portfolio includes: Road Barriers, Traffic Cones, Spring Post, Road Studs, Corner Guards, Speed Breakers, Wheel Stopper and all kind of Dust Bins etc.

We've maintained a commitment to always believing in better, creating stronger, healthier communities and more sustainable product solutions in an effort to leave the world a better place for generations to come.

# CERTIFICATIONS



CLASS 11



CLASS 17



CLASS 20



CLASS 11

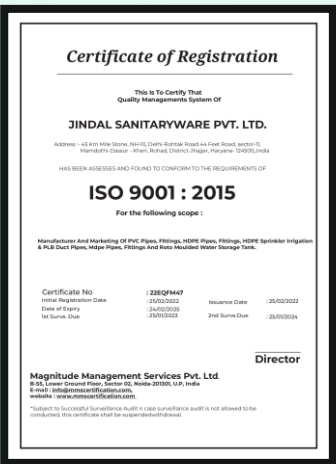

ISO 9001 : 2015



ISO 4427-1, 2 & 3 : 2019

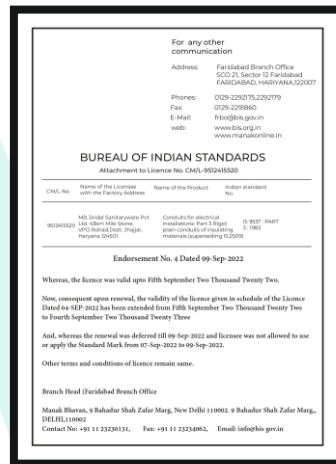

IS 9537 : 1983

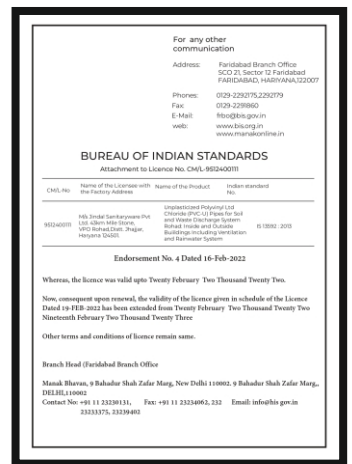

IS 13592 : 2013

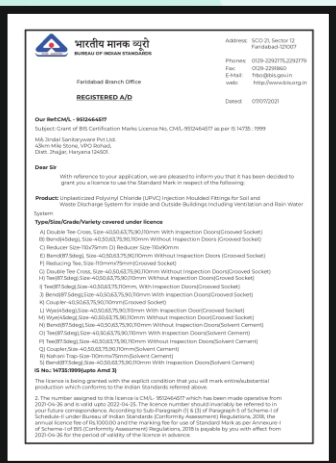

IS 14735 : 1999

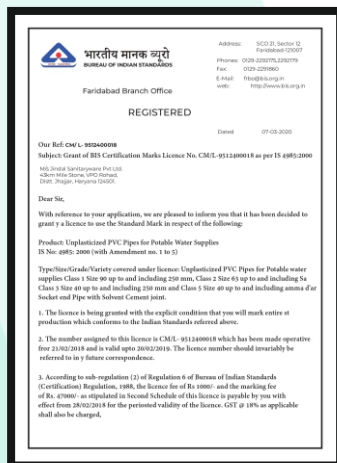

IS 4985 : 2000

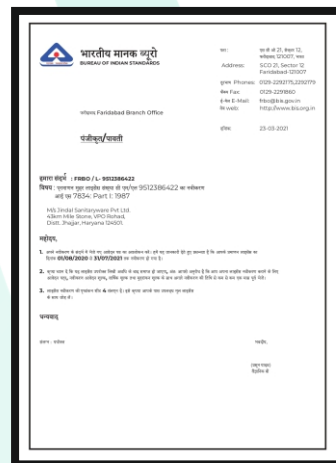

IS 7834 : 1987

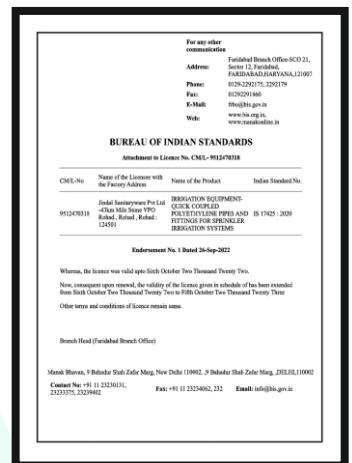

IS 17425 : 2020

**भारतीय मानक ब्यूरो**  
BUREAU OF INDIAN STANDARDS

For any other communication:  
Farrukabad Branch Office  
F-1, Sector 12, Phase-1, Faridkot  
Farrukabad (U.P.) 202002  
Phone: 0526-226171, 226172  
Fax: 0526-226180  
E-Mail: bsi@bis.org.in  
www.bis.org.in

Subject: Grant of BIS Certification License No. CHL/92/2009 per IS 4984: 2016

**IS 4984: 2016**

1000 reference to your application, you are pleased to inform you that it has been decided to grant you a license to use the Standard Mark in respect of the following:

**Product:** High Density Polyethylene Pipes for Pressure Water Supplies  
**Type:** Solid/Double Wall/Corrugated/Other

1. HDPE PN2 DN20 to 200mm SDR 11	2. HDPE PN2 DN25 to 250mm SDR 11	3. HDPE PN2 DN32 to 300mm SDR 11	4. HDPE PN2 DN40 to 350mm SDR 11
5. HDPE PN2 DN50 to 400mm SDR 11	6. HDPE PN2 DN63 to 450mm SDR 11	7. HDPE PN2 DN75 to 500mm SDR 11	8. HDPE PN2 DN90 to 550mm SDR 11
9. HDPE PN2 DN110 to 630mm SDR 11	10. HDPE PN2 DN125 to 700mm SDR 11	11. HDPE PN2 DN150 to 800mm SDR 11	12. HDPE PN2 DN175 to 900mm SDR 11
13. HDPE PN2 DN200 to 1000mm SDR 11	14. HDPE PN2 DN225 to 1100mm SDR 11	15. HDPE PN2 DN250 to 1200mm SDR 11	16. HDPE PN2 DN280 to 1300mm SDR 11
17. HDPE PN2 DN315 to 1400mm SDR 11	18. HDPE PN2 DN350 to 1500mm SDR 11	19. HDPE PN2 DN375 to 1600mm SDR 11	20. HDPE PN2 DN400 to 1700mm SDR 11

**भारतीय मानक ब्यूरो**  
BUREAU OF INDIAN STANDARDS

For any other communication:  
Farrukabad Branch Office  
F-1, Sector 12, Phase-1, Faridkot  
Farrukabad (U.P.) 202002  
Phone: 0526-226171, 226172  
Fax: 0526-226180  
E-Mail: bsi@bis.org.in  
www.bis.org.in

Subject: Grant of BIS Certification License No. CHL/92/2009 per IS 12701: 1996

**IS 12701: 1996**

1000 reference to your application, you are pleased to inform you that it has been decided to grant you a license to use the Standard Mark in respect of the following:

**Product:** High Density Polyethylene Pipes for Pressure Water Supplies  
**Type:** Solid/Double Wall/Corrugated/Other

1. HDPE PN2 DN20 to 200mm SDR 11	2. HDPE PN2 DN25 to 250mm SDR 11	3. HDPE PN2 DN32 to 300mm SDR 11	4. HDPE PN2 DN40 to 350mm SDR 11
5. HDPE PN2 DN50 to 400mm SDR 11	6. HDPE PN2 DN63 to 450mm SDR 11	7. HDPE PN2 DN75 to 500mm SDR 11	8. HDPE PN2 DN90 to 550mm SDR 11
9. HDPE PN2 DN110 to 630mm SDR 11	10. HDPE PN2 DN125 to 700mm SDR 11	11. HDPE PN2 DN150 to 800mm SDR 11	12. HDPE PN2 DN175 to 900mm SDR 11
13. HDPE PN2 DN200 to 1000mm SDR 11	14. HDPE PN2 DN225 to 1100mm SDR 11	15. HDPE PN2 DN250 to 1200mm SDR 11	16. HDPE PN2 DN280 to 1300mm SDR 11
17. HDPE PN2 DN315 to 1400mm SDR 11	18. HDPE PN2 DN350 to 1500mm SDR 11	19. HDPE PN2 DN375 to 1600mm SDR 11	20. HDPE PN2 DN400 to 1700mm SDR 11

**भारतीय मानक ब्यूरो**  
BUREAU OF INDIAN STANDARDS

For any other communication:  
Farrukabad Branch Office  
F-1, Sector 12, Phase-1, Faridkot  
Farrukabad (U.P.) 202002  
Phone: 0526-226171, 226172  
Fax: 0526-226180  
E-Mail: bsi@bis.org.in  
www.bis.org.in

Subject: Grant of BIS Certification License No. CHL/92/2009 per IS 15778: 2007

**IS 15778: 2007**

1000 reference to your application, you are pleased to inform you that it has been decided to grant you a license to use the Standard Mark in respect of the following:

**Product:** High Density Polyethylene Pipes for Pressure Water Supplies  
**Type:** Solid/Double Wall/Corrugated/Other

1. HDPE PN2 DN20 to 200mm SDR 11	2. HDPE PN2 DN25 to 250mm SDR 11	3. HDPE PN2 DN32 to 300mm SDR 11	4. HDPE PN2 DN40 to 350mm SDR 11
5. HDPE PN2 DN50 to 400mm SDR 11	6. HDPE PN2 DN63 to 450mm SDR 11	7. HDPE PN2 DN75 to 500mm SDR 11	8. HDPE PN2 DN90 to 550mm SDR 11
9. HDPE PN2 DN110 to 630mm SDR 11	10. HDPE PN2 DN125 to 700mm SDR 11	11. HDPE PN2 DN150 to 800mm SDR 11	12. HDPE PN2 DN175 to 900mm SDR 11
13. HDPE PN2 DN200 to 1000mm SDR 11	14. HDPE PN2 DN225 to 1100mm SDR 11	15. HDPE PN2 DN250 to 1200mm SDR 11	16. HDPE PN2 DN280 to 1300mm SDR 11
17. HDPE PN2 DN315 to 1400mm SDR 11	18. HDPE PN2 DN350 to 1500mm SDR 11	19. HDPE PN2 DN375 to 1600mm SDR 11	20. HDPE PN2 DN400 to 1700mm SDR 11

**भारतीय मानक ब्यूरो**  
BUREAU OF INDIAN STANDARDS

For any other communication:  
Farrukabad Branch Office  
F-1, Sector 12, Phase-1, Faridkot  
Farrukabad (U.P.) 202002  
Phone: 0526-226171, 226172  
Fax: 0526-226180  
E-Mail: bsi@bis.org.in  
www.bis.org.in

Subject: Grant of BIS Certification License No. CHL/92/2009 per IS 7231: 2021

**IS 7231: 2021**

1000 reference to your application, you are pleased to inform you that it has been decided to grant you a license to use the Standard Mark in respect of the following:

**Product:** High Density Polyethylene Pipes for Pressure Water Supplies  
**Type:** Solid/Double Wall/Corrugated/Other

1. HDPE PN2 DN20 to 200mm SDR 11	2. HDPE PN2 DN25 to 250mm SDR 11	3. HDPE PN2 DN32 to 300mm SDR 11	4. HDPE PN2 DN40 to 350mm SDR 11
5. HDPE PN2 DN50 to 400mm SDR 11	6. HDPE PN2 DN63 to 450mm SDR 11	7. HDPE PN2 DN75 to 500mm SDR 11	8. HDPE PN2 DN90 to 550mm SDR 11
9. HDPE PN2 DN110 to 630mm SDR 11	10. HDPE PN2 DN125 to 700mm SDR 11	11. HDPE PN2 DN150 to 800mm SDR 11	12. HDPE PN2 DN175 to 900mm SDR 11
13. HDPE PN2 DN200 to 1000mm SDR 11	14. HDPE PN2 DN225 to 1100mm SDR 11	15. HDPE PN2 DN250 to 1200mm SDR 11	16. HDPE PN2 DN280 to 1300mm SDR 11
17. HDPE PN2 DN315 to 1400mm SDR 11	18. HDPE PN2 DN350 to 1500mm SDR 11	19. HDPE PN2 DN375 to 1600mm SDR 11	20. HDPE PN2 DN400 to 1700mm SDR 11

**IS 4984 : 2016**

**IS 12701 : 1996**

**IS 15778 : 2007**

**IS 7231 : 2021**

**HARYANA VIDYUT PRASARAN NIGAM LIMITED**  
HVPNL

Regd. Office: Boarding Street, Sector 4, Faridkot  
Identity Number: UAD/03/HR/PS/03/03/683

Office of Chief Engineer (Pipes) (In Charge)  
Website: www.hvpln.co.in | Email: ce@hvpln.co.in  
SAVE ENERGY FOR THE BENEFIT OF SELF AND NATION

Subject: Vendor Registration of Jindal Sanitaryware Pvt. Ltd. (MS 1542) for supply of HDPE Pipes in Haryana.

S.No.	Name of Equipment	Quantity	Address of the factory / works
1	HDPE Pipe	1000000	MS 1542, Sector 12, Phase 1, Faridkot, U.P.
2	HDPE Pipe	1000000	MS 1542, Sector 12, Phase 1, Faridkot, U.P.
3	HDPE Pipe	1000000	MS 1542, Sector 12, Phase 1, Faridkot, U.P.
4	HDPE Pipe	1000000	MS 1542, Sector 12, Phase 1, Faridkot, U.P.

**UTTAR HARYANA BOLI VITRAN NIGAM LIMITED**  
UHBVNL

Regd. Office: Boarding Street, Sector 4, Faridkot  
Identity Number: UAD/03/HR/PS/03/03/683

Office of Chief Engineer (Pipes) (In Charge)  
Website: www.uhbvnl.co.in | Email: ce@uhbvnl.co.in  
SAVE ENERGY FOR THE BENEFIT OF SELF AND NATION

Subject: Vendor Registration of Jindal Sanitaryware Pvt. Ltd. (MS 1542) for supply of HDPE Pipes in Uttar Pradesh.

S.No.	Name of Equipment	Quantity	Address of the factory / works
1	HDPE Pipe	1000000	MS 1542, Sector 12, Phase 1, Faridkot, U.P.
2	HDPE Pipe	1000000	MS 1542, Sector 12, Phase 1, Faridkot, U.P.
3	HDPE Pipe	1000000	MS 1542, Sector 12, Phase 1, Faridkot, U.P.
4	HDPE Pipe	1000000	MS 1542, Sector 12, Phase 1, Faridkot, U.P.

**DAKSHIN HARYANA BOLI VITRAN NIGAM**  
DHBVN

Regd. Office: Boarding Street, Sector 4, Faridkot  
Identity Number: UAD/03/HR/PS/03/03/683

Office of Chief Engineer (Pipes) (In Charge)  
Website: www.dhbvn.co.in | Email: ce@dhbvn.co.in  
SAVE ENERGY FOR THE BENEFIT OF SELF AND NATION

Subject: Vendor Registration of Jindal Sanitaryware Pvt. Ltd. (MS 1542) for supply of HDPE Pipes in Haryana.

S.No.	Name of Equipment	Quantity	Address of the factory / works
1	HDPE Pipe	1000000	MS 1542, Sector 12, Phase 1, Faridkot, U.P.
2	HDPE Pipe	1000000	MS 1542, Sector 12, Phase 1, Faridkot, U.P.
3	HDPE Pipe	1000000	MS 1542, Sector 12, Phase 1, Faridkot, U.P.
4	HDPE Pipe	1000000	MS 1542, Sector 12, Phase 1, Faridkot, U.P.

**CERTIFICATE OF TRUST**

Jindal Sanitaryware Private Limited  
Jhajjar, Haryana

has been certified as a trusted member of INDIAMART

Following details of the company have been verified:

- ✓ Director / Proprietor: Siddhant Jindal
- ✓ GSTIN: 06AACJ1957010
- ✓ Business Address: 43 Km Stone, Manohar, Dassar Khori Road, Bahadurgarh, Jhajjar-124597, Haryana, India
- ✓ Import Export Code: 05120\*\*\*\*
- ✓ Mobile Number
- ✓ Email Id

Issue date: 24th April 2024 | Expiry date: 24th April 2025

**HVPNL**

**UHBVNL**

**DHBVN**

**INDIAMART**

**CHIEF INSPECTOR OF FACTORIES, HARYANA**

Application No: 14153 | Issued On: 08-10-2022

**RENEWAL OF FACTORY LICENSE**

License is hereby granted to

**MS 1542, Sector 12, Phase 1, Faridkot, U.P.**

valid for the premises described below for use as a factory is hereby renewed for the year 2023

DESCRIPTION OF THE LICENCED PREMISES

Renewal Details: MS 1542, Sector 12, Phase 1, Faridkot, U.P.

**CHIEF INSPECTOR OF FACTORIES, HARYANA**

Application No: 14153 | Issued On: 08-10-2022

**RENEWAL OF FACTORY LICENSE**

License is hereby granted to

**MS 1542, Sector 12, Phase 1, Faridkot, U.P.**

valid for the premises described below for use as a factory is hereby renewed for the year 2023

DESCRIPTION OF THE LICENCED PREMISES

Renewal Details: MS 1542, Sector 12, Phase 1, Faridkot, U.P.

**India Construction Meet 2023**  
International Conference & Exhibition  
10-12 April 2023 | ICA Convention Center, Pusa, New Delhi, India

**Certificate of Appreciation**

On behalf of the Organizing Committee of India Construction Meet 2023, We Express Our Deepest Appreciation to

**Jindal Sanitaryware Pvt. Ltd.**

For your outstanding achievements and contributions as Sponsor

for the success of the India Construction Meet 2023  
10-12 April 2023 | New Delhi

New Delhi, India  
Date: 12th April, 2023

Director General  
Construction Industry Development Council

**FACTORY LICENSE JSPL**

**FACTORY LICENSE WMJ**

**CIDC**



## CPVC PIPES & FITTINGS

1. Ideal for Hot and Cold Water Plumbing.
2. High withstanding capacity ranging from max 28.1 bar pressure at 23°C and max 8.79 bar at 82°C.
3. Wide range of pipes and fittings from 3/4" to 2".
4. Pipes are available in SDR 11, SDR 13.5, SCH 40 & SCH 80.



## uPVC ASTM PIPES & FITTINGS

1. For cold water plumbing.
2. Available as per ASTM D 1785 in Schedule 40 & 80.
3. Available in sizes 1/2" to 2".
4. Lead-free and Durable.



## SWR PIPES & FITTINGS

1. Available in sizes from 75mm to 160mm.
2. Joint pressure tested up to 5 Kg/cm<sup>2</sup> in Push-fit.
3. 100% leakproof joints.
4. Fitted with best quality rubber rings.



## uPVC PRESSURE PIPES & FITTINGS

1. Pressure Pipes & Fittings are free from lead & heavy metal.
2. We maintain minimal ovality at higher precision.
3. The chance of cracking through the weld line is minimal.
4. JPLEX JINDAL Pressure pipes are manufactured in accordance with IS 4985 standard, covering a range from 40mm to 315mm in pressure rating of 2.5, 4, 6 & 10 kg/cm<sup>2</sup>.



## GARDEN PIPES

1. Crack-less and Leak Proof.
2. Chemical Resistant.
3. JPLEX JINDAL Garden Pipes are available in the sizes 12.5mm (1/2"), 25mm (1"), 32mm (1.25"), and 20mm (3/4").
4. Available in 30-meter length in single layer, double layer, zebra line, and transparent, as well as a wide range of colours.



## HDPE PIPES & COILS

1. Very cost-effective piping system.
2. Flexible and Durable, apt for electrical and agricultural usage.
3. Can withstand temperatures from -148 to 176 degrees Fahrenheit.
4. Resistant to UV and most chemicals.



## SOLVENT CEMENT

1. The most constant & highest quality Solvent Cement commercial available.
2. Easily sticks to both wet and dry Pipe Surfaces.
3. Does not wash off even with flowing water.
4. Non - toxic and safe for people and environment.



## HDPE SPRINKLER SYSTEM

1. HDPE Sprinkler System are manufactured as per IS-17425.
2. HDPE Sprinkler Pipes are available in 6 meter length with coupler in size of outside diameter 50mm to 110mm in the pressure rating of 2.5 kg/cm<sup>2</sup> & 3.2 kg/cm<sup>2</sup>.
3. Sprinkler Fittings are available in sizes of 50mm to 110mm, with pressure rating of 4 kg/cm<sup>2</sup> & 10 kg/cm<sup>2</sup>.
4. High resistance to corrosion.



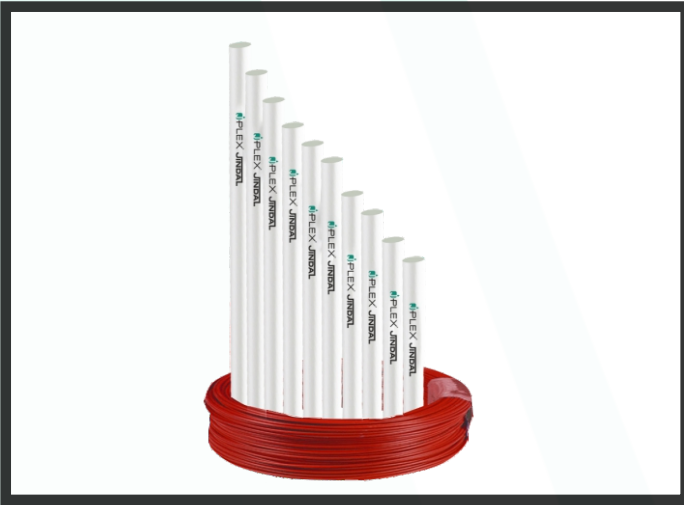

## uPVC CONDUIT PIPES & FITTINGS

1. JPLEX JINDAL Conduit Pipes are ISI marked with confirmation to BIS Standards.
2. Electrical Conduit Pipes are non-combustible because they are unplasticized.
3. Handling and installation are simple.
4. Wires may be laid out more easily with a smooth internal finish.



## WATER STORAGE TANK

1. Contoured design and extra ribs to give high strength.
2. Three, Four and Five layered storage tanks for improved safety & durability.
3. Based on German technology for superior quality.
4. Available in Capacities of 300, 500, 750, 1000, 1500, 2000, 3000 & 5000 litres.



## MILK BUCKETS & CONTAINERS

1. Hygienic food grade HDPE material used.
2. Lightweight & easy to clean.
3. Made from virgin plastic.
4. Maintains original colour and strength.



## PTMT TAPS

1. Zero Drop Advantage.
2. Highly durable material for long life.
3. Easy to clean and maintain.
4. Attractive design and glossy finish.



## EXPOSED CISTERN FLUSH TANKS

1. Modern design offers a stylish look for the interior of your bathroom.
2. Strong and Durable material.
3. Advanced flush mechanism.
4. Comes with plastic bend pipe.



## CONCEALED CISTERN IN-WALL CISTERN

1. Its modern design offers a stylish look for the interior of the bathroom.
2. It's a great space saver if you have a small bathroom.
3. Hygienic and long lasting.
4. Advanced flush mechanism.



## TOILET SEAT COVERS

1. The thermoset material is unscratchable.
2. Very easy to clean and even after years looks like at the first day.
3. Synthetic resin (grains) softened and transformed by injection.
4. Made from virgin plastic.



## BATHROOM FITTINGS & ACCESSORIES

1. Mirror Cabinets.
2. PTMT Cockroach Traps.
3. Faucets Collection.
4. Bathroom Fittings such as Soap Dish, Corner Self etc.



# CPVC PIPES

SDR-11 (3 Mtr.)

PIPES



Item Code	Size mm	Size inch	Pcs. per Bundle	M.R.P. per mtr.
JPSDR11020	20mm	¾"	50	90.00
JPSDR11025	25mm	1"	30	145.00
JPSDR11032	32mm	1-¼"	20	230.00
JPSDR11040	40mm	1-½"	15	335.00
JPSDR11050	50mm	2"	10	575.00

PIPES

SDR-13.5 (3 Mtr.)



Item Code	Size mm	Size inch	Pcs. per Bundle	M.R.P. per mtr.
JPSDR135020	20mm	¾"	50	85.00
JPSDR135025	25mm	1"	30	135.00
JPSDR135032	32mm	1-¼"	20	210.00
JPSDR135040	40mm	1-½"	15	295.00
JPSDR135050	50mm	2"	10	495.00

## CPVC FITTINGS

ELBOW 90°



Item Code	Size		Pcs. Per Pkt.	Pcs. Per Box	M.R.P. per piece
	mm	inch			
JPELBW020	20mm	¾"	50	500	14.50
JPELBW025	25mm	1"	50	250	28.50
JPELBW032	32mm	1-¼"	25	150	61.50
JPELBW040	40mm	1-½"	15	105	121.50
JPELBW050	50mm	2"	6	48	257.00

ELBOW 45°



Item Code	Size		Pcs. Per Pkt.	Pcs. Per Box	M.R.P. per piece
	mm	inch			
JPELBW020	20mm	¾"	50	300	22.00
JPELBW025	25mm	1"	25	150	38.50

EQUAL TEE



Item Code	Size		Pcs. Per Pkt.	Pcs. Per Box	M.R.P. per piece
	mm	inch			
JPTTEE020	20mm	¾"	50	400	22.50
JPTTEE025	25mm	1"	25	200	37.50
JPTTEE032	32mm	1-¼"	15	105	75.50
JPTTEE040	40mm	1-½"	10	60	153.00
JPTTEE050	50mm	2"	5	30	328.50

COUPLER



Item Code	Size		Pcs. Per Pkt.	Pcs. Per Box	M.R.P. per piece
	mm	inch			
JPCOUPLR020	20mm	¾"	100	800	12.50
JPCOUPLR025	25mm	1"	50	400	21.00
JPCOUPLR032	32mm	1-¼"	35	245	38.00
JPCOUPLR040	40mm	1-½"	25	150	72.50
JPCOUPLR050	50mm	2"	10	80	157.50

UNION



Item Code	Size		Pcs. Per Pkt.	Pcs. Per Box	M.R.P. per piece
	mm	inch			
JPUNION020	20mm	¾"	40	240	81.50
JPUNION025	25mm	1"	20	160	115.50
JPUNION032	32mm	1-¼"	20	100	148.00
JPUNION040	40mm	1-½"	12	72	247.00
JPUNION050	50mm	2"	6	36	445.50

 BALL VALVE  
(2 pcs.)

Item Code	Size		Pcs. Per Pkt.	Pcs. Per Box	M.R.P. per piece
	mm	inch			
JPBVALVE020	20mm	¾"	20	120	157.50
JPBVALVE025	25mm	1"	10	80	225.00
JPBVALVE032	32mm	1-¼"	6	54	450.00
JPBVALVE040	40mm	1-½"	4	32	742.50
JPBVALVE050	50mm	2"	2	20	1305.00

 FEMALE THREADED  
ELBOW  
(BRASS INSERT)

Item Code	Size		Pcs. Per Pkt.	Pcs. Per Box	M.R.P. per piece
	mm	inch			
JPFTEW020	20X20	¾"x¾"	20	160	89.50
JPFTEW2525	25X25	1"x1"	15	90	266.00
JPFTEW2015	20X15	¾"x½"	25	200	60.00
JPFTEW2515	25X15	1"x½"	25	150	103.00
JPFTEW2520	25X20	1"x¾"	20	120	166.50

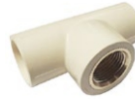
 FEMALE THREADED  
TEE  
(BRASS INSERT)

Item Code	Size		Pcs. Per Pkt.	Pcs. Per Box	M.R.P. per piece
	mm	inch			
JPFTT2020	20X20	¾"x¾"	25	100	108.50
JPFTT2525	25X25	1"x1"	25	75	227.50
JPFTT2015	20X15	¾"x½"	25	150	72.50
JPFTT2515	25X15	1"x½"	25	100	113.50
JPFTT2520	25X20	1"x¾"	25	100	187.50

 FEMALE THREADED  
ADAPTER  
(BRASS INSERT)

Item Code	Size		Pcs. Per Pkt.	Pcs. Per Box	M.R.P. per piece
	mm	inch			
JPFABT020	20mm	¾"	25	200	164.50
JPFABT025	25mm	1"	25	125	256.00
JPFABT2015	20X15	¾"x½"	25	250	67.00
JPFABT2515	25X15	1"x½"	25	250	86.00
JPFABT2520	25X20	1"x¾"	25	150	140.00

 FEMALE THREADED  
ADAPTER  
(HEXA BRASS)

Item Code	Size		Pcs. Per Pkt.	Pcs. Per Box	M.R.P. per piece
	mm	inch			
JPFABT0020	20mm	¾"	25	200	198.50
JPFABT0025	25mm	1"	25	100	306.00
JPFABT0032	32mm	1-¼"	8	72	593.50
JPFABT0040	40mm	1-½"	6	48	675.00
JPFABT0050	50mm	2"	4	32	1274.00
JPFABT2015	20X15	¾"x½"	25	250	136.00
JPFABT2520	25X20	1"x¾"	25	150	218.50

 MALE THREADED  
ADAPTER  
(HEXA BRASS)

Item Code	Size		Pcs. Per Pkt.	Pcs. Per Box	M.R.P. per piece
	mm	inch			
JPMABT0020	20mm	¾"	25	200	193.00
JPMABT0025	25mm	1"	25	100	310.00
JPMABT0032	32mm	1-¼"	8	72	580.50
JPMABT0040	40mm	1-½"	6	48	729.00
JPMABT0050	50mm	2"	4	32	1400.00
JPMABT2015	20X15	¾"x½"	25	250	128.50
JPMABT2520	25X20	1"x¾"	25	125	203.00

# CPVC PIPES & FITTINGS

**MALE THREADED ELBOW (BRASS INSERT)**



Item Code	Size		Pcs. Per Pkt.	Pcs. Per Box	M.R.P. per piece
	mm	inch			
JPMTEW2015	20X15	¾"x½"	25	200	122.00

**MALE THREADED TEE (BRASS INSERT)**



Item Code	Size		Pcs. Per Pkt.	Pcs. Per Box	M.R.P. per piece
	mm	inch			
JPMTEW2015	20X15	¾"x½"	25	150	151.00
JPMTEW2515	25X15	1"x½"	30	90	248.00

**MALE THREADED ADAPTER (BRASS INSERT)**



Item Code	Size		Pcs. Per Pkt.	Pcs. Per Box	M.R.P. per piece
	mm	inch			
JPMABT0020	20	¾"	25	200	166.00
JPMABT0025	25	1"	25	100	265.50
JPMABT2015	20X15	¾"x½"	25	250	94.00
JPMABT2515	25X15	1"x½"	25	200	153.50
JPMABT2520	25X20	1"x¾"	25	125	211.50

**END CAP**



Item Code	Size		Pcs. Per Pkt.	Pcs. Per Box	M.R.P. per piece
	mm	inch			
JPECAP020	20	¾"	100	1800	10.00
JPECAP025	25	1"	50	900	15.00
JPECAP032	32	1-¼"	50	500	34.50
JPECAP040	40	1-½"	50	350	52.00
JPECAP050	50	2"	20	160	112.00

**MALE THREADED ADAPTER (PLASTIC)**



Item Code	Size		Pcs. Per Pkt.	Pcs. Per Box	M.R.P. per piece
	mm	inch			
JPMAPT020	20	¾"	50	800	19.00
JPMAPT025	25	1"	50	500	26.50
JPMAPT032	32	1-¼"	40	240	44.50
JPMAPT040	40	1-½"	25	150	67.50
JPMAPT050	50	2"	12	96	133.50
JPMAPT2015	20X15	¾"x½"	50	400	24.00

**FEMALE THREADED ADAPTER (PLASTIC)**



Item Code	Size		Pcs. Per Pkt.	Pcs. Per Box	M.R.P. per piece
	mm	inch			
JPFAPT020	20	¾"	50	700	23.00
JPFAPT025	25	1"	50	350	34.50
JPFAPT032	32	1-¼"	35	210	88.50
JPFAPT040	40	1-½"	20	160	121.50
JPFAPT050	50	2"	12	72	189.00

**TANK NIPPLE**



Item Code	Size		Pcs. Per Pkt.	Pcs. Per Box	M.R.P. per piece
	mm	inch			
JPTN020	20	¾"	25	240	47.50
JPTN025	25	1"	25	175	77.00
JPTN032	32	1-¼"	15	90	124.50
JPTN040	40	1-½"	10	80	176.00
JPTN050	50	2"	8	56	283.50

**STEP OVER BEND**



Item Code	Size		Pcs. Per Pkt.	Pcs. Per Box	M.R.P. per piece
	mm	inch			
JPSOBEND20	20	¾"		180	67.50
JPSOBEND25	25	1"		48	90.00

**CROSS TEE**



Item Code	Size		Pcs. Per Pkt.	Pcs. Per Box	M.R.P. per piece
	mm	inch			
JPCROSS020	20	¾"	75	300	20.50
JPCROSS025	25	1"	32	150	44.50

**REDUCING BUSH**



Item Code	Size		Pcs. Per Pkt.	Pcs. Per Box	M.R.P. per piece
	mm	inch			
JPRDBH2015	20X15	¾"x½"	250	1000	9.50
JPRDBH2515	25X15	1"x½"	100	500	20.50
JPRDBH2520	25X20	1"x¾"	50	500	15.00
JPRDBH3215	32X15	1¼"x½"	50	300	31.00
JPRDBH3220	32X20	1¼"x¾"	50	300	29.00
JPRDBH3225	32X25	1¼"x1"	50	300	23.00
JPRDBH4015	40X15	1½"x½"	50	300	49.50
JPRDBH4020	40X20	1½"x¾"	25	300	43.50
JPRDBH4025	40X25	1½"x1"	50	300	44.00
JPRDBH4032	40X32	1½"x1¼"	50	300	34.00
JPRDBH5015	50X15	2"x½"	25	150	92.00
JPRDBH5020	50X20	2"x¾"	25	150	90.00
JPRDBH5025	50X25	2"x1"	25	150	90.50
JPRDBH5032	50X32	2"x1¼"	25	150	94.00
JPRDBH5040	50X40	2"x1½"	25	150	79.50

**REDUCING COUPLER**



Item Code	Size		Pcs. Per Pkt.	Pcs. Per Box	M.R.P. per piece
	mm	inch			
JPRDCR2015	20X15	¾"x½"		600	16.00
JPRDCR2515	25X15	1"x½"		600	24.50
JPRDCR2520	25X20	1"x¾"		600	25.00
JPRDCR3215	32X15	1¼"x½"		245	84.50
JPRDCR3220	32X20	1¼"x¾"		245	65.00
JPRDCR3225	32X25	1¼"x1"		245	61.00
JPRDCR4015	40X15	1½"x½"		150	142.50
JPRDCR4020	40X20	1½"x¾"		150	128.00
JPRDCR4025	40X25	1½"x1"		150	127.50
JPRDCR4032	40X32	1½"x1¼"		150	86.50
JPRDCR5015	50X15	2"x½"		80	265.50
JPRDCR5020	50X20	2"x¾"		80	261.00
JPRDCR5025	50X25	2"x1"		80	261.50
JPRDCR5032	50X32	2"x1¼"		80	268.00
JPRDCR5040	50X40	2"x1½"		80	200.00

**REDUCING TEE**



Item Code	Size		Pcs. Per Pkt.	Pcs. Per Box	M.R.P. per piece
	mm	inch			
JPRDTE2015	20X15	¾"x½"	75	450	34.50
JPRDTE2515	25X15	1"x½"	25	300	61.50
JPRDTE2520	25X20	1"x¾"	25	200	54.50
JPRDTE3215	32X15	1¼"x½"	15	105	119.00
JPRDTE3220	32X20	1¼"x¾"	20	120	115.50
JPRDTE3225	32X25	1¼"x1"	20	120	108.50
JPRDTE4015	40X15	1½"x½"	10	60	198.50
JPRDTE4020	40X20	1½"x¾"	10	60	173.00
JPRDTE4025	40X25	1½"x1"	10	60	175.50
JPRDTE4032	40X32	1½"x1¼"	10	60	172.50
JPRDTE5015	50X15	2"x½"	5	30	351.00
JPRDTE5020	50X20	2"x¾"	5	30	346.50
JPRDTE5025	50X25	2"x1"	5	30	335.00
JPRDTE5032	50X32	2"x1¼"	5	30	288.00
JPRDTE5040	50X40	2"x1½"	5	30	294.00

**REDUCING ELBOW**



Item Code	Size		Pcs. Per Pkt.	Pcs. Per Box	M.R.P. per piece
	mm	inch			
JPRDEL2015	20X15	¾"x½"	100	400	20.50
JPRDEL2515	25X15	1"x½"	50	250	44.50
JPRDEL2520	25X20	1"x¾"	50	350	35.50

## HEAVY DUTY SOLVENT CEMENT



Item Code	Size of TIN	Pcs. per Box	M.R.P. per piece
JPSOLTB025	25 ml	5X100	85.00
JPSOLTB059	59 ml	6X48	120.00
JPSOLTN118	118 ml	6X24	185.00
JPSOLTN237	237 ml	8X12	325.00
JPSOLTB473	473 ml	1X20	725.00
JPSOLTB946	946 ml	1X10	1250.00

## uPVC ASTM PIPES

Pipes are available as per ASTM - D 1785 in Schedule 40 & 80 (sizes - 1/2" to 2")



### PIPES



Size		Schedule 40				Schedule 80			
mm	inch	3 mtr		6 mtr		3 mtr		6 mtr	
		Std. Pkg.	Price/3 mtr	Std. Pkg.	Price/6 mtr	Std. Pkg.	Price/3 mtr	Std. Pkg.	Price/6 mtr
15	1/2"	50	235.00	25	470.00	50	295.00	25	590.00
20	3/4"	45	315.00	25	630.00	45	395.00	25	790.00
25	1"	30	465.00	15	930.00	30	575.00	15	1150.00
32	1-1/4"	15	650.00	12	1300.00	15	775.00	12	1550.00
40	1-1/2"	12	805.00	10	1610.00	12	1005.00	10	2010.00
50	2"	8	1085.00	8	2170.00	8	1405.00	8	2810.00

## uPVC ASTM FITTINGS

Fittings are available as per ASTM-D 2467 in Schedule 80 (sizes - 1/2" to 2")

### COUPLER



Size		Packaging per		Price Per Piece
mm	inch	Bag	Box	
15 mm	1/2"	100x6	600	10.40
20 mm	3/4"	50x7	350	15.20
25 mm	1"	35x6	210	23.20
32 mm	1-1/4"	20x6	120	39.20
40 mm	1-1/2"	15x6	90	46.40
50 mm	2"	9x6	50	70.00

### END CAP



Size		Packaging per		Price Per Piece
mm	inch	Bag	Box	
15 mm	1/2"	150x8	1200	6.80
20 mm	3/4"	80x8	640	11.00
25 mm	1"	50x9	450	17.20
32 mm	1-1/4"	30x8	240	28.00
40 mm	1-1/2"	24x8	192	35.60
50 mm	2"	15x7	105	58.20

### TEE



Size		Packaging per		Price Per Piece
mm	inch	Bag	Box	
15 mm	1/2"	50x5	250	21.60
20 mm	3/4"	25x6	150	30.00
25 mm	1"	13x7	90	49.00
32 mm	1-1/4"	8x6	50	73.00
40 mm	1-1/2"	7x6	40	100.40
50 mm	2"	4x5	20	151.40

### ELBOW 90°



Size		Packaging per		Price Per Piece
mm	inch	Bag	Box	
15 mm	1/2"	60x7	400	15.40
20 mm	3/4"	40x6	240	22.20
25 mm	1"	25x6	150	38.40
32 mm	1-1/4"	10x9	90	52.80
40 mm	1-1/2"	8x8	60	72.40
50 mm	2"	6x6	36	119.10

### MALE ADAPTER PLASTIC THREADED



Size		Packaging per		Price Per Piece
mm	inch	Bag	Box	
15 mm	1/2"	120x6	720	8.40
20 mm	3/4"	70x6	450	13.00
25 mm	1"	35x9	300	20.80
32 mm	1-1/4"	35x8	280	31.40
40 mm	1-1/2"	24x7	168	42.80
50 mm	2"	15x7	105	56.40

### UNION



Size		Packaging per		Price Per Piece
mm	inch	Bag	Box	
15 mm	1/2"	40x7	270	36.60
20 mm	3/4"	22x7	150	56.20
25 mm	1"	15x8	120/100	75.60
32 mm	1-1/4"	10x7	72	104.80
40 mm	1-1/2"	8x6	50	148.40
50 mm	2"	4x6	25	215.30

### FEMALE ADAPTER PLASTIC THREADED



Size		Packaging per		Price Per Piece
mm	inch	Bag	Box	
15 mm	1/2"	120x5	630	10.00
20 mm	3/4"	60x6	390	16.40
25 mm	1"	30x7	210	24.40
32 mm	1-1/4"	20x8	160	37.40
40 mm	1-1/2"	16x8	128	48.80
50 mm	2"	9x8	72	62.40

### ELBOW 45°



Size		Packaging per		Price Per Piece
mm	inch	Bag	Box	
15 mm	1/2"	60x8	480	14.80
20 mm	3/4"	40x6	240	22.00
25 mm	1"	25x6	150	34.40
32 mm	1-1/4"	20x4	80	45.30
40 mm	1-1/2"	15x4	60	58.20
50 mm	2"	10x4	40	92.60

### TANK NIPPLE



Size		Packaging per		Price Per Piece
mm	inch	Bag	Box	
15 mm	1/2"	50x7	330	38.50
20 mm	3/4"	30x8	240	55.00
25 mm	1"	20x8	150	80.80
32 mm	1-1/4"	15x6	90	119.70
40 mm	1-1/2"	12x5	60	135.30
50 mm	2"	5x8	40	171.20

### BALL VALVES



Size		Packaging per		Price Per Piece
mm	inch	Bag	Box	
15 mm	1/2"	80x1	80	92.00
20 mm	3/4"	50x1	50	125.00
25 mm	1"	35x1	35	184.00
32 mm	1-1/4"	5x5	25	248.00
40 mm	1-1/2"	2x10	20	349.00
50 mm	2"	1x10	10	534.00

# uPVC ASTM PIPES & FITTINGS

## REDUCING TEE



Size		Packaging per		Price Per Piece
mm	inch	Bag	Box	
20x15	¾" x ½"	25X7	180	30.60
25x15	1" x ½"	15x7	108	43.80
25x20	1" x ¾"	15X6	90	46.20
32x15	1¼" x ½"	12x4	48	70.50
32x20	1¼" x ¾"	12x4	48	78.50
32x25	1¼" x 1"	12x4	48	82.50
40x15	1½" x ½"	7x8	56	93.50
40x20	1½" x ¾"	7x8	56	97.50
40X25	1½" x 1"	7x8	56	103.00
40x32	1½" x 1¼"	7x8	56	110.50
50x15	2" x ½"	4x8	32	146.50
50x20	2" x ¾"	4x8	32	148.50
50X25	2" x 1"	4x8	32	163.00
50x32	2" x 1¼"	4x7	28	165.50
50X40	2" x 1½"	4x7	28	167.20

## REDUCING BUSH



Size		Packaging per		Price Per Piece
mm	inch	Bag	Box	
20x15	¾" x ½"	100x9	900	6.20
25x15	1" x ½"	75x8	600	15.80
25x20	1" x ¾"	80x7	600	11.20
32x15	1¼" x ½"	50x7	350	31.20
32x20	1¼" x ¾"	50x7	350	26.50
32X25	1¼" x 1"	50x7	350	19.20
40x15	1½" x ½"	30x8	240	38.70
40x20	1½" x ¾"	30x8	240	39.20
40X25	1½" x 1"	30x8	240	35.00
40x32	1½" x 1¼"	30x8	240	24.50
50X25	2" x 1"	20x7	140	55.40
50x32	2" x 1¼"	20x7	140	50.50
50X40	2" x 1½"	20x7	140	41.60

## TANK NIPPLE (SOCKET)



Size		Packaging per		Price Per Piece
mm	inch	Bag	Box	
15 mm	½"	50x8	400	37.00
20mm	¾"	30x8	240	54.00
25 mm	1"	20x8	150	72.50

## REDUCING COUPLER



Size		Packaging per		Price Per Piece
mm	inch	Bag	Box	
20x15	¾" x ½"	60X6	360	15.20
25x15	1" x ½"	50x6	300	21.20
25x20	1" x ¾"	40X5	210	27.80
40x20	1½" x ¾"	20x5	100	58.50
40X25	1½" x 1"	20x5	100	57.50
40x32	1½" x 1¼"	20x5	100	52.00
50X25	2" x 1"	20x3	60	89.25
50x32	2" x 1¼"	20x3	60	88.50
50X40	2" x 1½"	20x3	60	89.00

## REDUCING ELBOW



Size		Packaging per		Price Per Piece
mm	inch	Bag	Box	
20x15	¾" x ½"	50X5	240	25.50
25x15	1" x ½"	35X5	180	36.20
25x20	1" x ¾"	30X5	150	38.20

## CROSS TEE



Size		Packaging per		Price Per Piece
mm	inch	Bag	Box	
15mm	½"	30x5	150	47.25
20mm	¾"	25x5	125	67.90
25mm	1"	20x5	100	106.50

## uPVC ASTM BRASS FITTINGS

Fittings are available as per ASTM-D 2467 in Schedule 80 (sizes - ½" to 2")

### BRASS ELBOW 90°



Size		Packaging per		Price Per Piece
mm	inch	Bag	Box	
15 mm	½"	50X4	200	81.00
20 mm	¾"	35x4	120	124.80
25 mm	1"	15x5	75	207.60

### REDUCING BRASS ELBOW 90°



Size		Packaging per		Price Per Piece
mm	inch	Bag	Box	
20x15	¾" x ½"	28X5	140	84.60
25x15	1" x ½"	20x5	100	110.80
25x20	1" x ¾"	20x4	80	139.00

### BRASS TEE



Size		Packaging per		Price Per Piece
mm	inch	Bag	Box	
15 mm	½"	28X5	140	89.40
20 mm	¾"	20x5	100	136.20
25 mm	1"	12x4	40	240.20

### REDUCING BRASS TEE



Size		Packaging per		Price Per Piece
mm	inch	Bag	Box	
20x15	¾" x ½"	20x5	100	98.80
25x15	1" x ½"	15x4	60	123.00
25x20	1" x ¾"	10X6	60	167.20

### MALE ADAPTER BRASS THREADED



Size		Packaging per		Price Per Piece
mm	inch	Bag	Box	
15 mm	½"	50X4	200	107.00
20 mm	¾"	30X5	150	145.60
25 mm	1"	20x5	100	233.40
32 mm	1¼"	20x4	80	350.50
40 mm	1½"	15x4	60	485.50
50 mm	2"	10x4	40	645.50

### FEMALE ADAPTER BRASS THREADED



Size		Packaging per		Price Per Piece
mm	inch	Bag	Box	
15 mm	½"	52X5	260	73.40
20 mm	¾"	30X7	200	110.00
25 mm	1"	20X6	120	183.20
32 mm	1¼"	20x4	80	375.50
40 mm	1½"	15x4	60	520.50
50 mm	2"	10x4	40	651.50

### REDUCING MTA BRASS THREADED



Size		Packaging per		Price Per Piece
mm	inch	Bag	Box	
20x15	¾" x ½"	40x5	200	110.00
25x15	1" x ½"	28X5	140	114.60
25x20	1" x ¾"	20X6	120	136.20

### REDUCING FTA BRASS THREADED



Size		Packaging per		Price Per Piece
mm	inch	Bag	Box	
20x15	¾" x ½"	52X5	260	74.40
25x15	1" x ½"	35X4	140	80.00
25x20	1" x ¾"	20X5	100	118.40

**S.W.R. PIPES**  
SWR PIPES CONFORMING TO IS 13592/1992

IS: 13592



**RINGFIT RUBBER RING JOINT**

**RINGFIT**



Sizes	Sockets	75 mm		90 mm		110 mm		160 mm	
		Type A	Type B	Type A	Type B	Type A	Type B	Type A	Type B
10ft.(3mtr.)	Single Socket	577.00	982.70	789.80	1166.90	1035.60	1454.50	2347.60	2699.70
10ft.(3mtr.)	Double Socket	615.90	1019.10	822.70	1237.00	1119.20	1525.00	2392.80	2814.20
20ft.(6mtr.)	Single Socket	1154.00	1965.40	1579.60	2333.70	2071.20	2909.00	4695.20	5399.50
20ft.(6mtr.)	Double Socket	1231.70	2038.20	1645.40	2473.90	2238.40	3050.00	4785.50	5628.50
6ft. (1.80 mtr.)	Single Socket	384.90	649.50	486.10	785.80	682.60	969.20	-	-
6ft. (1.80 mtr.)	Double Socket	396.10	663.80	499.90	799.80	700.30	987.10	-	-
4ft. (1.20 mtr.)	Double Socket	279.20	465.70	388.60	525.70	493.80	662.80	-	-
3ft	Double Socket	229.10	356.00	269.50	407.90	379.70	504.80	-	-
2ft. (0.60 mtr.)	Double Socket	160.60	249.90	222.00	276.90	281.90	352.80	-	-

**SELFIT SOLVENT JOINT**

**SELFIT**



Sizes	40mm		50mm		63mm		75mm		90mm		110mm		160mm	
	Type B	Type B	Type B	Type A	Type B	Type A	Type B	Type A	Type B	Type A	Type B	Type A	Type B	
10ft.(3mtr.)	274.60	420.40	603.20	565.40	963.00	774.00	1143.50	1014.90	1425.40	2300.60	2645.70			
20ft.(6mtr.)	549.10	840.80	1206.40	1130.80	1926.00	1548.00	2287.00	2029.80	2850.80	4601.20	5291.40			

**S.W.R. PIPE FITTINGS**  
SWR FITTINGS CONFORMING TO IS 14735

IS: 14735



**COUPLER**



Size		Model	Packaging Box	Price
mm	inch			
75 mm	2.5"	Ringfit	60	75.50
		Selfit	60	73.85
90 mm	3"	Ringfit	80	112.10
		Selfit	95	109.85
110 mm	4"	Ringfit	50	130.60
		Selfit	60	128.00
160 mm	6"	Ringfit	24	321.20
		Selfit	24	314.75

**BEND 87.5° ISI HEAVY**



Size		Model	Packaging Box	Price
mm	inch			
90 mm	3"	Ringfit	40	183.55
		Selfit	50	180.45
110 mm	4"	Ringfit	32	205.50
		Selfit	32	201.40
160 mm	6"	Ringfit	12	545.05
		Selfit	12	533.35

**BEND 87.5°**



Size		Model	Packaging Box	Price
mm	inch			
75 mm	2.5"	Ringfit	48	104.25
		Selfit	48	102.20
110 mm	4"	Ringfit	32	191.10
		Selfit	32	187.30

**SINGLE TEE**



Size		Model	Packaging Box	Price
mm	inch			
75 mm	2.5"	Ringfit	60	143.50
		Selfit	60	141.35
110 mm	4"	Ringfit	20	252.95
		Selfit	20	248.10

**BEND 87.5° LW**



Size		Model	Packaging Box	Price
mm	inch			
110 mm	4"	Ringfit	32	181.10

**SINGLE TEE ISI**



Size		Model	Packaging Box	Price
mm	inch			
90 mm	3"	Ringfit	36	245.40
		Selfit	36	241.10
110 mm	4"	Ringfit	20	296.20
		Selfit	20	292.00
160 mm	6"	Ringfit	7	785.80
		Selfit	7	772.10

# SWR PIPES & FITTINGS

**BEND 87.5° WITH DOOR**



Size		Model	Packaging Box	Price
mm	inch			
75 mm	2.5"	Ringfit	72	136.65
		Selfit	72	133.90
110 mm	4"	Ringfit	28	248.80
		Selfit	30	245.35

**SINGLE Y**



Size		Model	Packaging Box	Price
mm	inch			
75 mm	2.5"	Ringfit	24	180.50
		Selfit	24	178.05
90 mm	3"	Ringfit	30	297.95
		Selfit	30	293.80
110 mm	4"	Ringfit	16	337.20
		Selfit	16	332.45
160 mm	6"	Ringfit	6	995.15
		Selfit	6	975.65

**BEND 87.5° WITH DOOR ISI**



Size		Model	Packaging Box	Price
mm	inch			
90 mm	3"	Ringfit	40	227.50
		Selfit	50	223.35
110 mm	4"	Ringfit	28	255.65
		Selfit	30	250.85
160 mm	6"	Ringfit	12	615.25
		Selfit	12	601.25

**SINGLE Y WITH DOOR**



Size		Model	Packaging Box	Price
mm	inch			
75 mm	2.5"	Ringfit	20	214.85
		Selfit	20	210.55
90 mm	3"	Ringfit	30	346.35
		Selfit	28	340.00
110 mm	4"	Ringfit	16	415.15
		Selfit	16	408.35
160 mm	6"	Ringfit	6	1079.60
		Selfit	6	1058.00

**BEND 45°**



Size		Model	Packaging Box	Price
mm	inch			
75 mm	2.5"	Ringfit	50	89.05
		Selfit	60	87.45
110 mm	4"	Ringfit	36	158.80
		Selfit	40	155.80

**DOUBLE Y**



Size		Model	Packaging Box	Price
mm	inch			
75 mm	2.5"	Ringfit	30	235.75
		Selfit	30	231.05
90 mm	3"	Ringfit	20	412.50
		Selfit	20	409.75
110 mm	4"	Ringfit	10	485.55
		Selfit	10	476.55

**BEND 45° ISI**



Size		Model	Packaging Box	Price
mm	inch			
90 mm	3"	Ringfit	30	138.55
		Selfit	36	135.95
110 mm	4"	Ringfit	36	183.35
		Selfit	40	180.05
160 mm	6"	Ringfit	15	475.70
		Selfit	15	465.40

**DOUBLE Y WITH DOOR**



Size		Model	Packaging Box	Price
mm	inch			
75 mm	2.5"	Ringfit	24	265.50
		Selfit	24	259.70
90 mm	3"	Ringfit	16	460.50
		Selfit	16	454.25
110 mm	4"	Ringfit	8	611.50
		Selfit	8	599.25

**REDUCING TEE**



Size		Packaging Box	Price
mm	inch		
90x75	3" x 2-1/2"	40	218.50
110x75	4" x 2-1/2"	24	258.55
160x110	6" x 4"	9	728.40

**SINGLE TEE WITH DOOR**



Size		Model	Packaging Box	Price
mm	inch			
75 mm	2.5"	Ringfit	51	175.75
		Selfit	45	172.55
110 mm	4"	Ringfit	16	310.85
		Selfit	16	306.15

**REDUCING TEE ISI**



Size		Packaging Box	Price
mm	inch		
110x75	4" x 2-1/2"	26	298.40
110x90	4" x 3"	22	318.50

**SINGLE TEE WITH DOOR ISI**



Size		Model	Packaging Box	Price
mm	inch			
90 mm	3"	Ringfit	24	278.20
		Selfit	30	273.05
110 mm	4"	Ringfit	16	355.30
		Selfit	16	350.15
160 mm	6"	Ringfit	7	845.90
		Selfit	8	830.90



**DOUBLE TEE**



Size		Model	Packaging Box	Price
mm	inch			
75 mm	2.5"	Ringfit	36	190.55
		Selfit	45	186.25
90 mm	3"	Ringfit	20	318.95
		Selfit	24	312.55
110 mm	4"	Ringfit	16	385.25
		Selfit	16	376.55

**DOUBLE TEE ISI**



Size		Model	Packaging Box	Price
mm	inch			
110 mm	4"	Ringfit	16	450.25
		Selfit	16	441.55

**DOUBLE TEE WITH DOOR**



Size		Model	Packaging Box	Price
mm	inch			
75 mm	2.5"	Ringfit	32	262.30
		Selfit	32	257.05
90 mm	3"	Ringfit	16	383.70
		Selfit	20	376.05
110 mm	4"	Ringfit	12	485.25
		Selfit	12	475.50

**DOUBLE TEE WITH DOOR ISI**



Size		Model	Packaging Box	Price
mm	inch			
110 mm	4"	Ringfit	12	558.25
		Selfit	12	547.50

**PIPE CLIP**



Size		Model	Packaging Box	Price
mm	inch			
75 mm	2.5"	Selfit	450	26.15
90 mm	3"	Selfit	500	29.90
110 mm	4"	Selfit	300	39.50
160 mm	6"	Selfit	150	78.40

**VENT COWL**



Size		Model	Packaging Box	Price
mm	inch			
75 mm	2.5"	Selfit	285	23.50
90 mm	3"	Selfit	165	40.50
110 mm	4"	Selfit	112	43.50

**SOCKET PLUG**



Size		Model	Packaging Box	Price
mm	inch			
75 mm	2.5"	Selfit	165	46.50
90 mm	3"	Selfit	112	64.45
110 mm	4"	Selfit	56	74.50
160 mm	6"	Selfit	60	178.00

**DOOR CAP**



Size		Model	Packaging Box	Price
mm	inch			
75 mm	2.5"	Selfit	100	18.90
90 mm	3"	Selfit	100	24.65
110 mm	4"	Selfit	100	30.95

**CLEANING PIPE WITH DOOR ISI**



Size		Model	Packaging Box	Price
mm	inch			
75 mm	2.5"	Ringfit	72	142.85
		Selfit	82	140.00
90 mm	3"	Ringfit	40	248.25
		Selfit	45	245.75
110 mm	4"	Ringfit	27	307.45
		Selfit	27	302.85
160 mm	6"	Ringfit	9	669.40
		Selfit	9	655.85

**ROUND JALI**



Size		Model	Packaging Box	Price
mm	inch			
110 mm	4"	Selfit	100	40.50

**SQUARE JALI**



Size		Model	Packaging Box	Price
mm	inch			
110 mm	4"	Selfit	100	102.50

## REDUCER



Size		Packaging Box	Price
mm	inch		
90x75	3" x 2-1/2"	50	102.50
110x75	4" x 2-1/2"	55	110.40
110x75 ISI	4" x 2-1/2"	55	156.40
110x90	4" x 3"	55	146.40
160x110	6" x 4"	36	298.50

## REDUCING Y



Size		Packaging Box	Price
mm	inch		
110x75	4" x 2-1/2"	16	259.75
160x110	6" x 4"	6	845.15

## REDUCING Y WITH DOOR



Size		Packaging Box	Price
mm	inch		
110x75	4" x 2-1/2"	16	322.40
160x110	6" x 4"	6	871.20

## REDUCING TEE WITH DOOR



Size		Packaging Box	Price
mm	inch		
90x75	3" x 2-1/2"	24	237.50
110x75	4" x 2-1/2"	20	304.50
160x110	6" x 4"	8	773.50

## REDUCING TEE WITH DOOR ISI



Size		Packaging Box	Price
mm	inch		
110x75	4" x 2-1/2"	20	346.40
110x90	4" x 3"	20	372.50

# S.W.R TRAPS

## P TRAP SHORT (TWO PIECE)



Size		Packaging Box	Price
mm	inch		
110x110	4" x 4"	16	442.25
125x110	4-1/2" x 4"	15	457.75

## MULTI FLOOR TRAP WITHOUT JALI



Size		Packaging Box	Price
mm	inch		
110x75	4" x 2-1/2"	40	245.50

## P TRAP SHORT PLAIN LW (SINGLE PIECE)



Size		Packaging Box	Price
mm	inch		
125x110 (TWO PIECE)	4-1/2" x 4"	15	398.50
125x110 (SINGLE PIECE)	4-1/2" x 4"	15	390.50

## NAHANI TRAP WITHOUT JALI (TWO PIECE)



Size		Packaging Box	Price
mm	inch		
110x75	4" x 2-1/2"	24	163.50
110x90	4" x 3"	48	172.50
110x110	4" x 4"	42	214.50

## P TRAP LONG



Size		Packaging Box	Price
mm	inch		
110x110	4" x 4"	12	485.50
125x110	4-1/2" x 4"	10	495.00

## NAHANI TRAP WITHOUT JALI (SINGLE PIECE)



Size		Packaging Box	Price
mm	inch		
110x63	4" x 2"	28	158.50
110x75	4" x 2-1/2"	30	160.50
110x90	4" x 3"	54	168.50
110x110	4" x 4"	42	198.50

## Q TRAP



Size		Packaging Box	Price
mm	inch		
110x110	4" x 4"	12	796.45
125x110	4-1/2" x 4"	10	942.50

## NAHANI TRAP WITH JALI



Size		Packaging Box	Price
mm	inch		
110x75	4" x 2-1/2"	30	213.20
110x90	4" x 3"	54	222.75
110x110	4" x 4"	42	264.65

## S TRAP



Size		Packaging Box	Price
mm	inch		
110x110	4" x 4"	12	1127.40
125x110	4-1/2" x 4"	10	1203.50



## AGRICULTURE PIPES / PRESSURE PIPES

Rigid uPVC pipes for agriculture conforming to IS 4985/2000 working pressure kgf/cm<sup>2</sup>/price in rupees per mtr.

**PRESSURE PIPES**



Size OD in mm	Size inch	Class 1 (2.5 kg/p)	Class 2 (4 kg/p)	Class 3 (6 kg/p)	Class 5 (10 kg/p)
40	1-¼"	-	-	83.20	117.00
50	1-½"	-	-	127.40	187.20
63	2"	-	132.60	192.40	296.40
75	2-½"	-	188.50	270.40	474.50
90	3"	179.40	260.50	370.40	598.00
110	4"	273.00	382.50	540.50	890.50
125	4-½"	351.00	507.00	786.50	1294.80
140	5"	403.00	604.50	910.00	1474.20
160	6"	533.00	819.00	1170.00	1924.00
180	7"	760.50	1164.80	1605.50	2528.50
200	8"	955.50	1427.40	1982.50	3135.60
225	9"	1323.40	1926.60	2645.50	4121.00
250	10"	1625.00	2320.50	3276.00	5083.00
280	11"	2379.00	3263.00	4615.00	7137.00
315	12"	2977.00	4134.00	5889.00	9132.50

## AGRICULTURE FITTINGS / PRESSURE FITTINGS

Rigid uPVC fittings for agriculture conforming to IS 7834

**LW = LIGHT WEIGHT**  
**HW = HEAVY WEIGHT**



**ELBOW 90° PN4**



Size		Packaging Box	Price
mm	inch		
50 mm	1 ½"	175	30.50
63 mm	2"	200	41.50
75 mm	2 ½"	135	51.50
90 mm	3"	70	86.50
110 mm	4"	40	120.00
140 mm	5"	18	290.50

**COUPLER LW**



Size		Packaging Box	Price
mm	inch		
63mm	2"	150	39.50
90mm	3"	120	65.50
110 mm	4"	60	94.50
140 mm	5"	20	192.50
160 mm	6"	24	295.00

**TEE PN4**



Size		Packaging Box	Price
mm	inch		
50 mm	1-½"	100	41.50
63 mm	2"	125	52.50
75 mm	2-½"	102	65.50
90mm	3"	50	122.50
110 mm	4"	32	164.50
140 mm	5"	12	380.50

**COUPLER HEAVY**



Size		Packaging Box	Price
mm	inch		
90 mm	3"	120	132.50
110 mm	4"	60	168.50

**ELBOW 90° PN6 ISI**



Size		Packaging Box	Price
mm	inch		
40mm	1-¼"	280	26.50
90 mm	3"	27	158.50
110 mm	4"	32	248.00
160 mm	6"	11	590.00

**ELBOW 90° ECO FIT LW**



Size		Packaging Box	Price
mm	inch		
90 mm	3"	80	78.50
110 mm	4"	40	112.50

**TEE PN6 ISI**



Size		Packaging Box	Price
mm	inch		
40 mm	1-1/4"	180	36.50
90 mm	3"	18	214.50
110 mm	4"	24	358.00
160 mm	6"	7	778.50

**TEE LW ECO FIT**



Size		Packaging Box	Price
mm	inch		
90 mm	3"	50	105.50
110 mm	4"	32	154.50

**ELBOW 45° PN4**



Size		Packaging Box	Price
mm	inch		
110 mm	4"	45	142.50

**ELBOW HEAVY PN10**



Size		Packaging Box	Price
mm	inch		
110 mm	4"	18	398.50

**ELBOW 90° 6 KG NON ISI**



Size		Packaging Box	Price
mm	inch		
90 mm	3"	28	132.50
110 mm	4"	32	210.00
125 mm	4.5"	20	255.50
140 mm	5"	18	375.50
160 mm	6"	11	498.50
200 mm	8"	6	835.00

**TEE HEAVY PN10**



Size		Packaging Box	Price
mm	inch		
110 mm	4"	20	495.00

**TEE 6 KG NON ISI**



Size		Packaging Box	Price
mm	inch		
90 mm	3"	18	190.50
110 mm	4"	24	328.00
125 mm	4.5"	16	415.50
140 mm	5"	12	515.00
160 mm	6"	7	680.50
200 mm	8"	5	1295.00

**MTA**

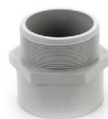

Size		Packaging Box	Price
mm	inch		
40 mm	1-1/4"	500	20.00
50 mm	1-1/2"	385	31.50
63 mm	2"	240	44.50
75 mm	2-1/2"	150	55.50
90 mm	3"	96	80.00
110 mm	4"	32	110.00

**FTA**



Size		Packaging Box	Price
mm	inch		
40mm	1-1/4"	450	22.50
50mm	1-1/2"	250	33.50
63mm	2"	168	44.00
75 mm	2-1/2"	75	72.50
90 mm	3"	48	96.00
110 mm	4"	24	140.00

**END CAP**



Size		Packaging Box	Price
mm	inch		
90 mm	3"	105	60.00
110 mm	4"	140	70.00
140 mm	5"	70	148.50
160 mm	6"	48	225.00
180 mm	7"	28	285.00
200 mm	8"	25	355.00
225 mm	9"	21	415.00

**REDUCING ELBOW**



Size		Packaging Box	Price
mm	inch		
110 x 90	4" x 3"	24	164.50

**REDUCING TEE**



Size		Packaging Box	Price
mm	inch		
90x75	3" x 2 1/2"	50	148.50
110x90	4" x 3"	34	160.50
110x90 HEAVY	4" x 3"	24	315.50
110x75	4" x 2 1/2"	34	155.50
160x110	6" x 4"	9	755.50

**P TRAP SHORT PLAIN LW (SINGLE PIECE)**



Size		Packaging Box	Price
mm	inch		
125x110 (TWO PIECE)	4-1/2" x 4"	15	398.50
125x110 (SINGLE PIECE)	4-1/2" x 4"	15	390.50

**REDUCING TEE WITH DOOR**



Size		Packaging Box	Price
mm	inch		
160x110	6" x 4"	9	825.50

**REDUCER**



Size mm	Packaging Box	Price
90x75	105	62.00
90x63	105	60.00
90x50	105	58.00
110x90	54	94.00
110x75	54	90.00
110x63	54	88.00
160x90	36	225.00
160x110	36	250.00

# PVC GARDEN PIPES



JPLEX JINDAL Garden Pipes are all-weather pipes in our renowned Garden Pipes sector that have a superior build, are lightweight, and ensure top-notch quality. They are a sort of water pipe that is widely recognised for their flexibility and durability, and they are frequently used to flush out water for all garden and landscaping reasons. Garden pipes are made in India and developed specifically for Green India. Our garden pipes are made of high-quality materials and have exceptional qualities such as remaining soft in any weather conditions and having a robust adaptor and connector for convenient use. They are available in a variety of colours. They are produced under the supervision of technicians in accordance with industry standards,

## PRODUCT RANGE

Range : 1/2" , 3/4", 1", 1-1/4"

Material : Flexible PVC.

Packaging Type : Roll

Available in 30 meter length

Color : Yellow, Blue, Green, Red, Pink

Usage/Application : Garden Fencing, and Drainage

Available in single layer, double layer, zebra line & transparent



Crack Proof



Leak Proof



Chemical Resistant



Robust Structure

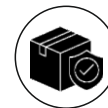

Attractive & Safe Packing



Easy Maintenance

### RATE PER BUNDLE 30 METER LENGTH

Products	1/2"	3/4"	1"	1-1/4"
PVC Garden Pipe Double Layer Blue	750	1200	1650	2550
PVC Garden Pipe Opec Zebra	775	1225	1675	2575
PVC Garden Pipe Transparent	800	1250	1700	2600
PVC Garden Pipe Transparent Zebra	825	1275	1725	2625
PVC Garden Pipe Double Colour Special Heavy	875	1325	1775	2675

### WEIGHT CHART

Inchs	mm	Weight Kgs.
1/2"	(15 mm)	3.5
3/4"	(20 mm)	5.5
1"	(25 mm)	7.5
1-1/4"	(32 mm)	11.5

# uPVC AND CPVC SOLVENT CEMENTS



- JINDAL Solvent Cements fuses the material together, creating one uniformly bonded piece of thermoplastic.
- It is a fast, easy and incredibly reliable joining method.
- Assures unmatched superiority, backed by extensive R&D efforts.



### CPVC HEAVY DUTY SOLVENT CEMENT

Item Code	Tin Size	Pcs. per Box	M.R.P.
JPSOLTB025	25 ml	5X100	85.00
JPSOLTB059	59 ml	6X48	120.00
JPSOLTN118	118 ml	6X24	185.00
JPSOLTN237	237 ml	8X12	325.00
JPSOLTB473	473 ml	1X20	725.00
JPSOLTB946	946 ml	1X10	1250.00

### uPVC ASTM SOLVENT CEMENT FOR ASTM PIPES & FITTINGS

Size	Price
20 ml. Tube	60.00
50 ml. Tube	100.00
100 ml. Tube	175.00
59 ml. Tin	100.00
04 OZ / 0.118 ml. Tin	155.00
08 OZ / 0.237 ml. Tin	225.00
16 OZ / 0.473 ml. Tin	425.00
32 OZ / 0.946 ml. Tin	825.00

### REGULAR SOLVENT CEMENT FOR RIGID PVC PIPES & FITTINGS

Quantity	Rate per Tin/Can	Packing per Box (in nos.)
50 ml.	65.00	245
100ml.	95.00	100
250 ml.	150.00	50
500 ml.	250.00	20
1.0 Ltr.	450.00	10

### Directions for Uses

- To make consistently good joints, the following points should be clearly understood.
- Stir or shake before using.
- Clean pipe and fitting with cleaner.
- The joining surfaces must be softened and made semi-fluid.
- Apply liberal coat of solvent cement to pipe and fitting Do not 'overcoat' thin wall or bell end pipe.
- Assemble parts QUICKLY! Cement must be fluid. If not fluid, re-coat both parts.
- Push pipe firmly into fitting using a 1/4 turning motion until pipe bottoms.
- Hold pipe and fitting together for 60 seconds.
- Allow joint to cure sufficiently before handling.
- Do not pressure test until cement is fully cured.

### Storage & Handling

- Store at temperatures between 10°C and 50°C.
- Keep container closed when not in use.
- Keep away from heat, spark, open flame and children.
- Store in cool, dry, well-ventilated place.
- Do not mix with any other solvent.

# HDPE PIPES & COILS

FOR POTABLE WATER SUPPLY, GAS, CHEMICALS, TELECOM & ELECTRICAL DUCTING APPLICATIONS



(As Per IS : 4984-2016)



MADE FROM  
VIRGIN PLASTIC



SAFE AND  
COST EFFECTIVE



DURABLE  
AND FLEXIBLE



ELECTRICAL  
DUCTING



GAS AND OIL  
TRANSMISSION



TELEPHONE CABLE  
PROTECTION



POTABLE WATER  
SUPPLY



INDUSTRIAL  
USAGE



OFFICE &  
RESIDENTIAL USE



Jindal Sanitaryware Pvt. Ltd. High Density Polyethylene Pipes are made from thermo plast polymers, a cost effective material used for a broad range of piping solutions in landfill, industrial, electrical municipal and agricultural application. They have been subjected to the most gruelling of tests and proven effective for above ground surface, buried slip lined floating and sub surface marine locations.

HDPE Pipes carry potable water waste, water slurries, chemicals, electric wires and hazardous waste and compressed gases with the greatest ease. In fact, Polyethylene Pipes have a long and distinguished history of service.

- ◇ Type and colour :- Black colour with Blue Strips
- ◇ Product Range(MM) :- 20mm to 315mm
- ◇ Pressure :- PN2 to 20
- ◇ Material Grade :- PE 100 /80/63
- ◇ Standards :- Is 4984-2016
- ◇ Application :- Potable Water Supply, Industrial, Electrical Work, etc.
- ◇ Made under strict quality standards and conform to various ISI and international standards

## DIMENSIONS

S.NO.	Size Range	Length (in metres)
1	20mm to 50mm	100, 200, 300, 500 & 1000 metre coils
2	63mm to 75mm	100, 200 & 300 metre coils
3	90mm to 110mm	100, 125, 150 metre coils & Straight length of 6 metre
4	125mm to 315mm	In Straight length of 6 metre

# HDPE PIPES

FOR POTABLE WATER SUPPLY

(As Per IS : 4984-2016)

IS: 4984



Size		PE-63 (Rate per Metre)													
INCH	MM	SDR 41 (2 kg/cm <sup>2</sup> )	PN-2	SDR 33 (2.5 kg/cm <sup>2</sup> )	PN-2.5	SDR 26 (3.2 kg/cm <sup>2</sup> )	PN-3.2	SDR 21 (4 kg/cm <sup>2</sup> )	PN-4	SDR 17 (5 kg/cm <sup>2</sup> )	PN-5	SDR 13.6 (6 kg/cm <sup>2</sup> )	PN-6	SDR 11 (8 kg/cm <sup>2</sup> )	PN-8
1/2"	20														33.22
3/4"	25											42.28			49.83
1"	32									54.36		67.95			80.03
1-1/4"	40							69.46		84.56		105.70			128.35
1-1/2"	50					90.60		108.72		134.39		164.59			199.32
2"	63					144.96		172.14		211.40		261.23			315.59
2-1/2"	75	133.50		159.00		198.00		246.00		300.00		369.00			442.50
3"	90	184.50		232.50		291.00		348.00		420.00		525.00			630.00
4"	110	277.50		343.50		429.00		582.00		637.50		780.00			943.50
4-1/2"	125	357.60		438.06		543.85		670.50		812.05		998.30			1214.35
5"	140	454.45		551.30		679.44		841.85		1020.65		1251.60			1525.76
6"	160	572.69		718.46		895.48		1100.75		1338.75		1636.25			1985.81
7"	180	727.39		907.38		1137.94		1383.38		1680.88		2067.63			2501.98
8"	200	901.43		1108.19		1392.30		1718.06		2082.50		2543.63			3086.56
9"	225	1143.89		1413.13		1770.13		2171.75		2632.88		3235.31			3918.08
10"	250	1398.25		1732.94		2186.63		2677.50		3235.31		3979.06			4834.38

Size		PE-80 (Rate per Metre)													
INCH	MM	SDR 41 (2.5 kg/cm <sup>2</sup> )	PN-2.5	SDR 33 (3.2 kg/cm <sup>2</sup> )	PN-3.2	SDR 26 (4 kg/cm <sup>2</sup> )	PN-4	SDR 21 (5 kg/cm <sup>2</sup> )	PN-5	SDR 17 (6 kg/cm <sup>2</sup> )	PN-6	SDR 13.6 (8 kg/cm <sup>2</sup> )	PN-8	SDR 11 (10 kg/cm <sup>2</sup> )	PN-10
1/2"	20														33.44
3/4"	25											42.56			50.16
1"	32									54.72		68.40			80.56
1-1/4"	40							69.92		85.12		106.40			129.20
1-1/2"	50					91.20		109.44		135.28		165.68			200.64
2"	63					145.92		173.28		212.80		262.96			317.68
2-1/2"	75	135.28		161.12		200.64		249.28		304.00		373.92			448.40
3"	90	186.96		235.60		294.88		352.64		425.60		532.00			638.40
4"	110	281.20		348.08		434.72		589.76		646.00		790.40			956.08
4-1/2"	125	360.00		441.00		547.50		675.00		817.50		1005.00			1222.50
5"	140	457.50		555.00		684.00		847.50		1027.50		1260.00			1536.00
6"	160	574.61		720.88		898.49		1104.45		1343.25		1641.75			1992.49
7"	180	729.83		910.43		1141.76		1388.03		1686.53		2074.58			2510.39
8"	200	904.46		1111.91		1396.98		1723.84		2089.50		2552.18			3096.94
9"	225	1147.73		1417.88		1776.08		2179.05		2641.73		3246.19			3931.25
10"	250	1402.95		1738.76		2193.98		2686.50		3246.19		3992.44			4850.63

Size		PE-100 (Rate per Metre)													
INCH	MM	SDR 41 (3 kg/cm <sup>2</sup> )	PN-3	SDR 33 (4 kg/cm <sup>2</sup> )	PN-4	SDR 26 (5 kg/cm <sup>2</sup> )	PN-5	SDR 21 (6 kg/cm <sup>2</sup> )	PN-6	SDR 17 (8 kg/cm <sup>2</sup> )	PN-8	SDR 13.6 (10 kg/cm <sup>2</sup> )	PN-10	SDR 11 (12.5 kg/cm <sup>2</sup> )	PN-12.5
1/2"	20														34.10
3/4"	25											43.40			51.15
1"	32									55.80		69.75			82.15
1-1/4"	40							71.30		86.80		108.50			131.75
1-1/2"	50					93.00		111.60		137.95		168.95			204.60
2"	63					148.80		176.70		217.00		268.15			323.95
2-1/2"	75	137.95		164.30		204.60		254.20		310.00		381.30			457.25
3"	90	190.65		240.25		300.70		359.60		434.00		542.50			651.00
4"	110	286.75		354.95		443.30		601.40		658.75		806.00			974.95
4-1/2"	125	364.80		446.88		554.80		684.00		828.40		1018.40			1238.80
5"	140	463.60		562.40		693.12		858.80		1041.20		1276.80			1556.48
6"	160	583.28		731.75		912.03		1121.10		1363.50		1666.50			2022.53
7"	180	740.84		924.15		1158.98		1408.95		1711.95		2105.85			2548.23
8"	200	918.09		1128.68		1418.04		1749.83		2121.00		2590.65			3143.63
9"	225	1165.04		1439.25		1802.85		2211.90		2681.55		3295.13			3990.51
10"	250	1424.10		1764.98		2227.05		2727.00		3295.13		4052.63			4923.75



# HDPE SPRINKLER SYSTEM

IS: 17425



- HDPE Sprinkler Pipes & Fittings are manufactured as per IS-17425.
- HDPE Sprinkler pipes are available in 6 meter length with coupler in size of outside diameter 50mm to 110 mm in the pressure rating of 2.5 kg/cm<sup>2</sup> & 3.2 kg/cm<sup>2</sup>.
- Sprinkler Fitting are available in sizes of 50mm to 110mm pressure rating of 4 kg/cm<sup>2</sup> to 10 kg/cm<sup>2</sup>.
- Sprinkler pipe is easy to use & safe Ideal for seasonal & permanent planting.
- High resistance to corrosion.
- Easily it adapts to all kinds of terrain.
- Eliminate the water loss by providing a reliable seal with the sealing system.
- Chemically inert, and suitable to use liquid fertilizers and pesticides.
- Easy handling & quick installation by using coupler joint for both pipes.

## HDPE SPRINKLER SYSTEM

As Per IS :17425

### HDPE Sprinkler Irrigation System IS: 17425 - 2020 ( © TYPE)

S.NO.	DESCRIPTION	63 MM	75 MM	90 MM	110 MM
1	HDPE Sprinkler Pipe Duly Coupled IS : 17425 (class -I)	-	1090	1432	2140
2	HDPE Sprinkler Pipe Duly Coupled IS : 17425 (class -II)	910	1330	1858	2632
3	HDPE Sprinkler Adopter/Coupler With Foot Batton	820	895	955	1315
4	HDPE Sprinkler Tee With Black Clamp	718	820	910	1240
5	HDPE Sprinkler Bend	487	556	820	1150
6	HDPE Sprinkler Pump Connecting Nipple	850	880	940	1300
7	HDPE Sprinkler End Cap	145	160	220	280
8	Sprinkler Nozzle	880	880	880	880
9	GI Riser Pipe 20mm	400	400	400	400

### HDPE Sprinkler Irrigation System IS: 17425 - 2020 (KAN TYPE)

S.NO.	DESCRIPTION	63 MM	75 MM	90 MM	110 MM
1	HDPE Sprinkler Pipe Duly Coupled IS : 17425 (class - I)	-	1068	1404	2097
2	HDPE Sprinkler Pipe Duly Coupled IS : 17425 (class - II)	892	1304	1821	2580
3	HDPE Sprinkler Adopter/Coupler With Foot Batton	804	877	936	1289
4	HDPE Sprinkler Tee With Black Clamp	704	804	892	1215
5	HDPE Sprinkler Bend	477	545	804	1127
6	HDPE Sprinkler Pump Connecting Nipple	833	863	921	1274
7	HDPE Sprinkler End Cap	142	157	216	275
8	Sprinkler Nozzle	863	863	863	863
9	GI Riser Pipe 20mm	392	392	392	392

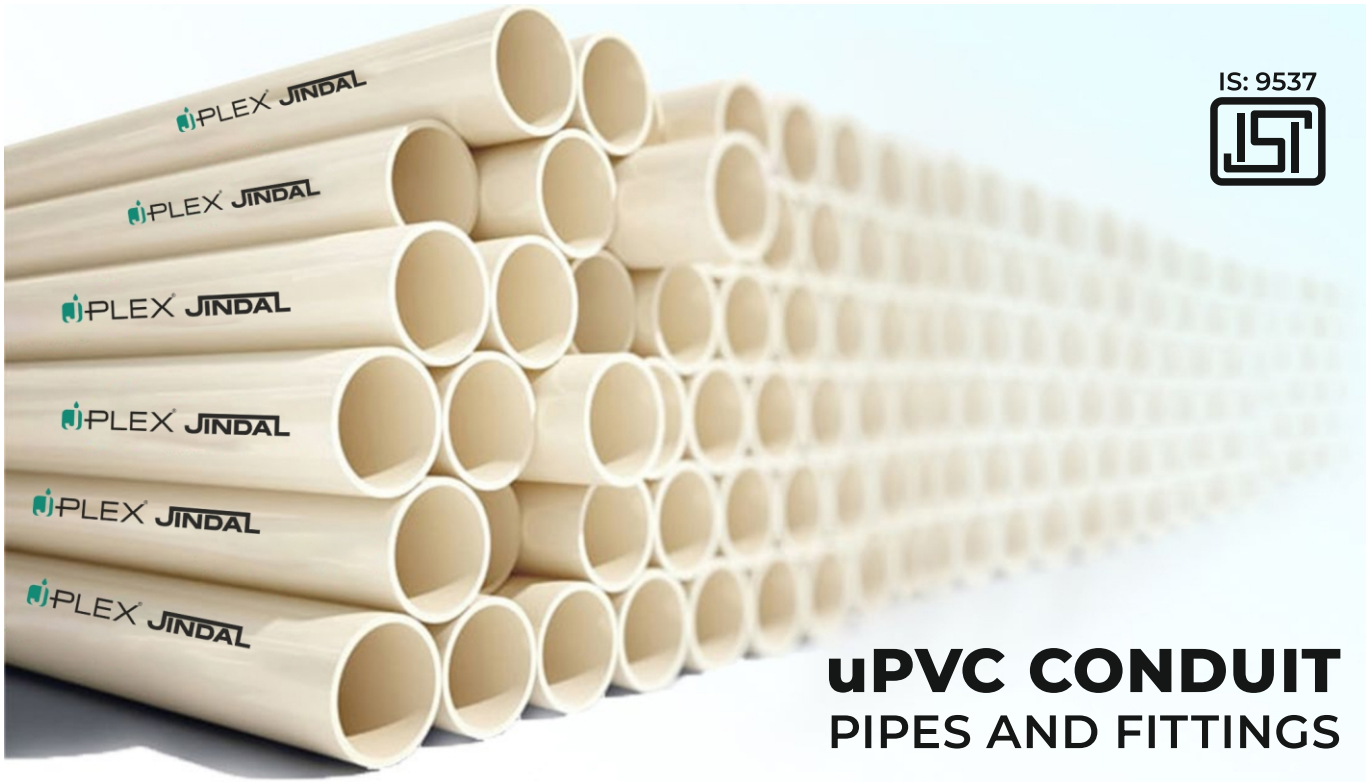

## uPVC CONDUIT PIPES AND FITTINGS

- JPLEX JINDAL Conduit Pipes are ISI marked with confirmation to BIS standards
- Electrical Conduit Pipes are unplasticised and as a result non supporters of combustion
- Easy handling and installation
- Smooth interior finish facilitates easy laying of wires
- Tested for Bending, Impact, Compression and Collapsing
- Very cost effective Piping System

### DIMENSIONS OF THE uPVC CONDUIT PIPES

Normal Size	Outer	Tolerance on	Inside Diameter (minimum)		
			Light	Medium	Heavy
20	20	-0.3	17.40	16.90	15.80
25	25	-0.4	22.10	21.40	20.60
32	32	-0.4	28.60	27.80	26.60
40	40	-0.4	35.80	35.40	34.40
50	50	-0.5	45.10	44.30	43.20

### uPVC Conduit Pipes ISI marked as per IS : 9537

Size	Rate Per Meter			Packing Per Bundle
	Light	Medium	Heavy	
20	30.00	36.00	45.00	40
25	45.00	54.00	64.00	25
32	60.00	80.00	100.00	15
40	100.00	115.00	140.00	10
50	155.00	180.00	215.00	8

ROTO MOULDING WATER TANKS

NOW INTRODUCING

**Weather Proof**  
Premium Water Storage Tanks



100% Virgin Food Grade Raw Material



Antibacterial-100% Safe For Drinking Water



UV Stabilized- No Weather Effect



5 Layered Design with Extra Thick Foam For Superior Insulation



Insulated Covers with Inbuilt Locking Provision

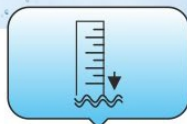

Provided with Water Level Indicator & Pump Controller

The Jindal Plast India is an acknowledged leader of India's plastic industry. It is credited with pioneering several path breaking products and has been a torch bearer in the transition from conventional to advanced plastic piping products in the country. Its customer centric approach fuels its research for designing unmatched quality products to meet the aspirations of its quality conscious customers. The innovative product portfolio offered by Jindal plast is extensive in range and application and comprises variety of pipes and vast spectrum of fittings totalling over 100 diverse products.

After encouraging response to the blow moulded water tanks, we are pleased to offer yet another unique quality product i.e. premium water storage tanks under the brand name of Weather Proof. These first of its kind premium overhead water storage tanks are designed to offer many best in class features to meet the requirements of elite class of customers. Weather Proof tanks are made available in five layered design with extra thick foam layer to make it extra strong, durable and most importantly to offer superior thermal insulation properties.

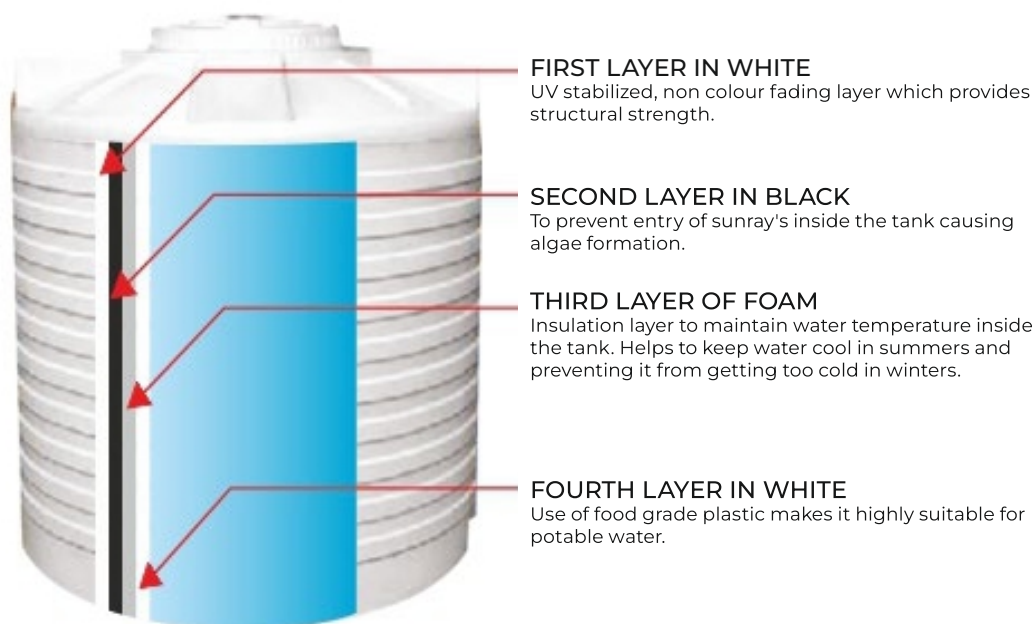

CAPACITY	3 Layer	4 Layer	Jindal Pure 5 Layer
Rate per litre	5.50	6.50	7.50
300 Litres	1650.00	1950.00	2250.00
500 Litres	2750.00	3250.00	3750.00
750 Litres	4125.00	4875.00	5625.00
1000 Litres	5500.00	6500.00	7500.00
1500 Litres	8250.00	9750.00	11250.00
2000 Litres	11000.00	13000.00	15000.00
3000 Litres	16500.00	19500.00	22500.00
5000 Litres	27500.00	32500.00	37500.00

## Installation guidelines

- Provide a full bottom levelled support wherever necessary.
- Before installation, ensure that the top surface of the bottom support is plain and free from any sharp stones or metal pieces.
- Outlet connections should be drilled at least one inch from the bottom.
- Ensure proper support for inlet (s) and outlet (s) pipes to avoid undue pressure/ stress on the tank body.
- Use drill machine to make the holes on the tank and ensure that holes are of proper size.
- Never allow tank to remain dry for long duration once it is put to use.



- Hygienic Food Grade HDPE material used
- Lightweight & easy to clean
- Made from Virgin plastic
- Maintains original colour and strength
- Better substitute in comparison to steel or aluminium containers
- Capacity of 5, 7.5, 10, 15, 20, 30 and 40 litres
- High Chemical Resistance & UV stabilized
- Anti-bacterial and anti- microbial properties
- Used in Dairy, Food Industry and Household Purposes

Sizes	Height	Diameter	Packaging	M.R.P.
5 Litres	283.50 mm	198.00 mm	30 Pieces	210.00
7.5 Litres	343.50 mm	215.00 mm	30 Pieces	315.00
10 Litres	403.60 mm	232.00 mm	20 Pieces	425.00
15 Litres	367.00 mm	329.60 mm	12 Pieces	630.00
20 Litres	369.50 mm	329.60 mm	10 Pieces	845.00
30 Litres	507.40 mm	338.00 mm	6 Pieces	1260.00
40 Litres	628.00 mm	338.00 mm	6 Pieces	1680.00

Available Colours:  
Golden, Blue, Red, Green



*HIGH STRENGTH  
AND DURABLE*



*FOOD GRADE  
MATERIAL*



*INDUSTRIAL  
USAGE*



*ANTI - BACTERIAL  
AND HYGIENIC*



*ULTRA - VIOLET  
RESISTANT*



*MADE FROM  
VIRGIN PLASTIC*

**EDGE COLLECTION (COLOURED)**

**BIB COCK WITH FLANGE**



Model Number	M.R.P.
501-B	345
Inner Box : 28 pcs.	

**PILLAR COCK**



Model Number	M.R.P.
502-B	430
Inner Box : 12 pcs.	

**ANGULAR STOP COCK WITH FLANGE**



Model Number	M.R.P.
503-B	290
Inner Box : 56 pcs.	

**BIB COCK LONG BODY WITH FLANGE**



Model Number	M.R.P.
504-B	405
Inner Box : 12 pcs.	

**TWO WAY BIB COCK WITH FLANGE**



Model Number	M.R.P.
505-B	530
Inner Box : 12 pcs.	

**SINK COCK WITH FLANGE**



Model Number	M.R.P.
506-B	755
Inner Box : 12 pcs.	

**SWAN NECK**



Model Number	M.R.P.
507-B	785
Inner Box : 12 pcs.	

**TWO WAY ANGLE COCK WITH FLANGE**



Model Number	M.R.P.
508-B	530
Inner Box : 12 pcs.	

**EDGE COLLECTION**

**BIB COCK WITH FLANGE**



Model Number	M.R.P.
501	315
Inner Box : 28 pcs.	

**PILLAR COCK**



Model Number	M.R.P.
502	400
Inner Box : 12 pcs.	

**ANGULAR STOP COCK WITH FLANGE**



Model Number	M.R.P.
503	260
Inner Box : 56 pcs.	

**BIB COCK LONG BODY WITH FLANGE**



Model Number	M.R.P.
504	375
Inner Box : 12 pcs.	

**EDGE COLLECTION**

**TWO WAY BIB COCK WITH FLANGE**



Model Number	M.R.P.
505	500
Inner Box : 12 pcs.	

**SINK COCK WITH FLANGE**



Model Number	M.R.P.
506	725
Inner Box : 12 pcs.	

**SWAN NECK**



Model Number	M.R.P.
507	750
Inner Box : 12 pcs.	

**EDGE COLLECTION 90°**

**BIB COCK WITH FLANGE**



Model Number	M.R.P.
501-C	345
Inner Box : 28 pc	

**PILLAR COCK**



Model Number	M.R.P.
502-C	430
Inner Box : 12 pcs.	

**ANGULAR STOP COCK WITH FLANGE**



Model Number	M.R.P.
503-C	290
Inner Box : 56 pcs.	

**BIB COCK LONG BODY WITH FLANGE**

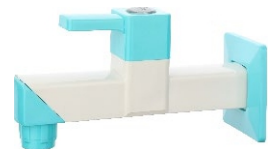

Model Number	M.R.P.
504-C	405
Inner Box : 12 pcs.	

**TWO WAY BIB COCK WITH FLANGE**



Model Number	M.R.P.
505-C	530
Inner Box : 12 pcs.	

**SINK COCK WITH FLANGE**



Model Number	M.R.P.
506-C	755
Inner Box : 12 pcs.	

**SWAN NECK**



Model Number	M.R.P.
507-C	785
Inner Box : 12 pcs.	

**TWO WAY ANGLE COCK WITH FLANGE**



Model Number	M.R.P.
508-C	530
Inner Box : 12 pcs.	

**STANDARD COLLECTION**

**BIB COCK WITH FLANGE**



Model Number	M.R.P.
401	175
Inner Box : 56 pcs.	

**PILLAR COCK**



Model Number	M.R.P.
402	250
Inner Box : 56 pcs.	

**ANGULAR STOP COCK WITH FLANGE**



Model Number	M.R.P.
403	175
Inner Box : 56 pcs.	

**BIB COCK LONG BODY WITH FLANGE**



Model Number	M.R.P.
404	225
Inner Box : 56 pcs.	

**TWO WAY BIB COCK WITH FLANGE**



Model Number	M.R.P.
405	375
Inner Box : 12 pcs.	

**SINK COCK WITH FLANGE**



Model Number	M.R.P.
407	475
Inner Box : 12 pcs.	

**SWAN NECK**



Model Number	M.R.P.
408	490
Inner Box : 12 pcs.	

**TWO WAY ANGLE COCK WITH FLANGE**



Model Number	M.R.P.
409	375
Inner Box : 28 pcs.	

**SMART COLLECTION**

**BIB COCK WITH FLANGE**



Model Number	M.R.P.
701	200
Inner Box : 56 pcs.	

**PILLAR COCK**



Model Number	M.R.P.
702	325
Inner Box : 56 pcs.	

**ANGULAR STOP COCK WITH FLANGE**



Model Number	M.R.P.
703	200
Inner Box : 56 pcs.	

**BIB COCK LONG BODY WITH FLANGE**



Model Number	M.R.P.
704	275
Inner Box : 56 pcs.	

last.com



**TWO WAY BIB COCK WITH FLANGE**



Model Number	M.R.P.
705	450
Inner Box : 12 pcs.	

**SINK COCK WITH FLANGE**



Model Number	M.R.P.
706	575
Inner Box : 12 pcs.	

**SWAN NECK**



Model Number	M.R.P.
707	590
Inner Box : 12 pcs.	

**PRIMA COLLECTION**

**BIB COCK WITH FLANGE**



Model Number	M.R.P.
201	70

**PILLAR COCK**



Model Number	M.R.P.
203	80

**ANGULAR STOP COCK WITH FLANGE**



Model Number	M.R.P.
204	65

**BIB COCK LONG BODY WITH FLANGE**



Model Number	M.R.P.
202	80

**TWO WAY BIB COCK WITH FLANGE**



Model Number	M.R.P.
210	300

**SINK COCK WITH FLANGE**



Model Number	M.R.P.
209	320

**SWAN NECK WITH FLANGE**



Model Number	M.R.P.
208	320

**TWO WAY ANGLE COCK WITH FLANGE**



Model Number	M.R.P.
211	300

# EXPOSED CISTERN FLUSH TANKS



- Modern design offers a stylish look for the interior of your bathroom
- Strong and durable material
- Advanced flush mechanism
- Comes with plastic bend pipe
- Saves water as it is available in both single and dual flush variants
- Very cost effective over ceramic cisterns
- Sleek designs for space saving
- Made from virgin plastic
- Easy to clean and maintain
- Also available with toilet fresheners



MODERN LOOK FOR BATHROOM



SCRATCH RESISTANT DUST RESISTANT



ANTI BACTERIAL HIGH QUALITY MATERIAL



STRONG AND DURABLE



VALUE FOR MONEY



WATER SAVING TECHNOLOGY

## SINGLE FLUSH CISTERN



Model Number	M.R.P.
502	900



Model Number	M.R.P.
503	825



Model Number	M.R.P.
503A	850

\*With Side-Top Push



**Model Number**      **M.R.P.**

506                      775



**Model Number**      **M.R.P.**

506A                    800

\*With Centre Push



**Model Number**      **M.R.P.**

508                      700



**Model Number**      **M.R.P.**

509                      775



Urinal Tank

**Model Number**      **M.R.P.**

512                      750



Urinal Tank

**Model Number**      **M.R.P.**

513                      825



**Model Number**      **M.R.P.**

1008                    850



**Model Number**      **M.R.P.**

1009                    900

## DUAL FLUSH CISTERN



**Model Number**      **M.R.P.**

504                      1100



**Model Number**      **M.R.P.**

507                      1050



**Model Number**      **M.R.P.**

1010                    1325



**Model Number**      **M.R.P.**

0777                    1350



**Model Number**      **M.R.P.**

1011                    1400

\*With Air Freshner



**Model Number**      **M.R.P.**

1012                    1375

\*With Air Freshner



**Model Number**      **M.R.P.**

1015                    1600

\*With Air Freshner



**Model Number**      **M.R.P.**

1015A                   1400

\*With Air Freshner

# CONCEALED CISTERN IN-WALL CISTERN



- Its modern design offers a stylish look
- It's a great space saver if you have a small bathroom
- Hygienic and long lasting
- Advanced flush mechanism
- Saves water as it is available in both single and dual flush
- It's more effective than the older flush versions
- Comes with wide range of Flush Plate designs
- Available in both half metal frame and full metal frame



### 100MM CONCEALED CISTERN

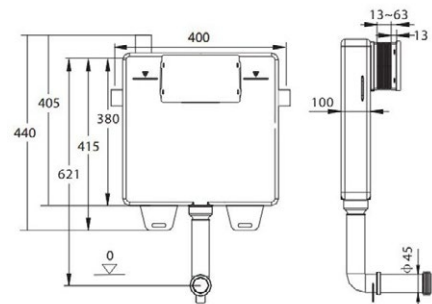

MODERN LOOK FOR BATHROOM



LESS MAINTENANCE



ANTI BACTERIAL HIGH QUALITY MATERIAL



STRONG AND DURABLE



SPACE SAVER SOLUTION



WATER SAVING TECHNOLOGY

## CONCEALED CISTERN



Model Number M.R.P.  
JMB 01 4600

\*Mechanical Cistern



Model Number M.R.P.  
JMC 03 4000

\*Mechanical 2 Piece Cistern



Model Number M.R.P.  
JMC 04 5200

\*Pneumatic 2 Piece Cistern



Model Number M.R.P.  
JBPN02 5700

\*Pneumatic Cistern



Model Number M.R.P.  
JF 01 2500

\*Half-Frame Model



Model Number M.R.P.  
JF 02 3100

\*Full-Frame Model

## FLUSH PLATES



Model No. M.R.P.  
H-01 1350



Model No. M.R.P.  
Q-02 1350



Model No. M.R.P.  
R-03 1350



Model No. M.R.P.  
B-04 1350



Model No. M.R.P.  
M-05 1350



Model No. M.R.P.  
SH-08 1350



Model No. M.R.P.  
PN H-06 1500



Model No. M.R.P.  
PN H-07 1500

\*Pneumatic Plates

# TOILET SEAT COVERS



### UF (Urea-Formaldehyde, Thermoset)

- The thermoset material is unscratchable.
- Very easy to clean and even after years looks like at the first day
- A high quality material and aesthetically looks like ceramic
- Resistant against cigarette burns
- Can be 3D printed.
- Sounds more deep and less "plastic"

### PP (Polypropylene, Thermoplastic)

- Synthetic resin (grains) softened and transformed by injection.
- Made from virgin plastic
- Fitted with high quality hinges
- Doesn't lose its colour and strength
- Shiny look
- Unbreakable design

- Available in both Soft Close and Hard Close Variants
- Antibacterial material for safety and hygiene
- Easy to Install, Maintain and Fix
- Available for Floor Mounted, Wall Mounted, Two Piece and One Piece water closet



ANTI-STATIC



SOFT CLOSING  
SLOW FALLING



ANTI BACTERIAL  
HIGH QUALITY MATERIAL



STRONG  
AND DURABLE



FIX CLIP QUICK  
RELEASE FITTING



HIGH QUALITY  
HINGES

## SOFT CLOSE SLOW DOWN SEAT COVERS



Model Number	M.R.P.
614A	800



Model Number	M.R.P.
614B	750



Model Number	M.R.P.
631	1250



Model Number	M.R.P.
632	900



Model Number	M.R.P.
633	750



Model Number	M.R.P.
635	800



Model Number	M.R.P.
636	1000



Model Number	M.R.P.
639	1000



Model Number	M.R.P.
641	950



Model Number	M.R.P.
642	950



Model Number	M.R.P.
644	950



Model Number	M.R.P.
645	950

## SOFT CLOSE SLOW DOWN SEAT COVERS



Model Number	M.R.P.
646	900



Model Number	M.R.P.
648	900



Model Number	M.R.P.
650	800



Model Number	M.R.P.
651	850



Model Number	M.R.P.
652	850



Model Number	M.R.P.
653	850



Model Number	M.R.P.
654	850



Model Number	M.R.P.
656	850



Model Number	M.R.P.
659	850



Model Number	M.R.P.
657	1200

\*with Quick-Release Hinges



Model Number	M.R.P.
658	1200

\*with Quick-Release Hinges



Model Number	M.R.P.
660	1200

\*with Quick-Release Hinges

## NORMAL HARD CLOSE SEAT COVERS



Model Number	M.R.P.
601	375



Model Number	M.R.P.
602	425



Model Number	M.R.P.
603	350



Model Number	M.R.P.
604	475



Model Number	M.R.P.
606	450



Model Number	M.R.P.
608	400

\*Heavy Model M.R.P. 950



Model Number	M.R.P.
610	450



Model Number	M.R.P.
611	400



Model Number	M.R.P.
612	600



Model Number	M.R.P.
613	375



Model Number	M.R.P.
614	550



Model Number	M.R.P.
614C	440

\*with Jet-Nozzle & Tube



Model Number	M.R.P.
615	330



Model Number	M.R.P.
616	425



Model Number	M.R.P.
617	450



Model Number	M.R.P.
618	550



Model Number	M.R.P.
618A	450



Model Number	M.R.P.
1101	600

\*with Jet-Nozzle & Tube

**HEALTH FAUCET COLLECTION**

**MAXXO WHITE**  
WITH WHITE 1 MTR TUBE



Model Number	M.R.P.
3303	300

Inner Box : 14 pcs.

**GRENITO WHITE**  
WITH WHITE 1 MTR TUBE



Model Number	M.R.P.
3304	300

Inner Box : 14 pcs.

**MIRROR CABINETS**

**MIRROR CABINET ABS**



Model Number	M.R.P.
702 ABS	2450

**MIRROR CABINET PP**



Model Number	M.R.P.
703 PP	1750

**STANDARD COLLECTION - SHOWERS**

**ULTRA SLIM**



Sizes	M.R.P.
4x4	280
6x6	440
8x8	640
12x12	1060

**ELEGANCE**



Sizes	M.R.P.
4x4	440
6x6	680
8x8	1000
12x12	1880

**3" ABS CHROME**  
WITH ARM



Model Number	M.R.P.
6505	340

**4" ABS CHROME**  
WITH ARM



Model Number	M.R.P.
6502	400

**5" ABS CHROME**  
WITH ARM



Model Number	M.R.P.
6506	510

**3" PTMT SHOWER**  
WITH ARM



Model Number	M.R.P.
6805	240

**4" PTMT SHOWER**  
WITH ARM



Model Number	M.R.P.
6802	270

**5" PTMT SHOWER**  
WITH ARM



Model Number	M.R.P.
6806	310















# JINDAL<sup>®</sup>

Pipes and Tanks

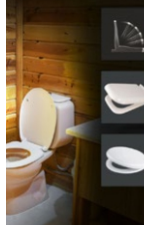
**J PLEX**  
Bringing flow to your life

**JINDAL PRO**

**JSPL**

 <p><b>CPVC</b> Pipes &amp; Fittings</p>	<p><b>uPVC</b> ASTM Plumbing Pipes &amp; Fittings</p> 	 <p><b>SWR</b> DRAINAGE SYSTEM</p>	<p><b>WATER</b> STORAGE TANKS</p> 
 <p><b>uPVC</b> PRESSURE Pipes &amp; Fittings for Agriculture Purpose</p>	<p><b>HDPE</b> Pipes &amp; Coils</p> 	 <p><b>uPVC</b> CONDUIT Pipes for Electrical Purpose</p>	<p><b>MILK</b> BUCKETS And Containers</p> 
 <p><b>SOLVENT</b> CEMENTS for CPVC &amp; uPVC</p>	<p><b>MDPE</b> Pipes</p> 	 <p><b>DWC</b> Pipes</p>	<p><b>HDPE</b> SPRINKLER System</p> 
 <p><b>HDPE</b> PLB DUCT Pipes</p>	<p><b>TOILET SEAT</b> COVERS UF &amp; PP Hard Close &amp; Soft Close</p> 	 <p><b>PTMT</b> TAPS Plastic Taps</p>	<p><b>EXPOSED</b> FLUSH TANKS Flushing Cisterns</p> 
 <p><b>IN-WALL</b> CISTERN Concealed Cistern</p>	<p><b>PVC</b> Garden Pipes</p> 	<p><b>Road Safety</b> and <b>Dustbin</b> Division</p> 	<p><b>MIRROR</b> Cabinets</p> 

## JINDAL SANITARYWARE PVT. LTD.

NH-10, Rohad, Bahadurgarh, District - Jhajjar, Haryana 124501  
Corporate Office: T-5/241, Phase-I, Mangolpuri Industrial Area, New Delhi-110083, India  
Phone: **+91 11 45525 900** Email: **info@jindalplast.com** Website: **www.jindalplast.com**

