

• DOOS
www.doosdesign.es



• DOOS

Desde 2010, DOOS diseña sus colecciones con profesionales de reconocido prestigio y proyección internacional. Esta colaboración se mantiene durante todo el proceso de producción industrial, siempre respetando valores de calidad, innovación, diseño, y la profesionalidad que imprime muchos años de trabajo en el sector de mueble.

Estamos especializados en el desarrollo de asientos y mesas, abarcando todo el proceso de fabricación. En la planificación de nuestros productos tenemos en cuenta aspectos de sostenibilidad tanto sociales como medioambientales. En este contexto, como fabricantes de asientos y mesas, producimos de la forma más responsable posible.

Cientes, arquitectos, diseñadores e interioristas, obtienen en los productos DOOS realidades para todo tipo de proyectos y entornos, ya sean del mundo Contract o bien interiores privados. Todos nuestros productos transmiten calidad de vida y elegancia.

Since 2010, DOOS designs its collections with professionals of recognized prestige and international projection. This collaboration is maintained throughout the whole industrial production process, always respecting values of quality, innovation, design, and the professionalism that many years of work in the furniture sector print.

We are specialized in the development of seats and tables, covering the entire manufacturing process. In the planning of our products, we take into account both social and environmental sustainability aspects. In this context, being seats and tables manufacturers, we produce in the most responsible way possible.

Clients, architects, designers, and interior designers, obtain DOOS solutions for all kinds of projects and environments, whether they are from the Contract sector or maybe for private interiors. All our products convey quality of life and elegance.

Inspirados en un estilo de vida actual. Inspired by a modern lifestyle.

Diseñamos e investigamos para conseguir productos cómodos, resistentes y durables, con un alto componente de personalización.

Maderas nobles, tapizados de inspiración natural, porcelánicos, metales pintados al horno y superficies de alta resistencia, son obtenidos mediante procesos sostenibles y cuidadosamente seleccionados para crear objetos atemporales y bellos.

Ponemos especial énfasis en el desarrollo de asientos con una durabilidad y confort máximos, con especialización en asientos y respaldos de inyección de espuma.

We design and research to achieve comfortable, resistant and durable products, with a high customization component.

Fine woods, naturally inspired fabrics, porcelain stoneware, oven-painted metals and high-resistance working surfaces are obtained through sustainable and carefully selected processes to create timeless and beautiful objects.

We place special emphasis on developing seats with maximum durability and comfort, specializing in foam injection seats and backrests.

Tecnología de moldeo por inyección. Injection molding technology.

¿QUÉ ES LA ESPUMA INYECTADA FLEXIBLE?

Es una de las soluciones más eficientes y versátiles para la industria del mueble y la opción más usada para artículos de descanso.

APLICACIÓN EN ASIENTOS Y RESPALDOS

Consiste en una carcasa externa de espuma inyectada, y un esqueleto metálico que le añade solidez y estabilidad.

WHAT IS FLEXIBLE INJECTED FOAM?

It is one of the most efficient and versatile solutions for the furniture industry and the most used option for rest items.

APPLICATION TO SEATS AND BACKRESTS

It consists of an external casing of injected foam, and a metal frame that adds solidity and stability.

Ventajas de la espuma inyectada flexible. Advantages of flexible injected foam.



Durabilidad: Resiste la humedad y no se desgasta ni se deforma con la presión.
Durability: Resists moisture and does not erode or deform under pressure.



Balance medioambiental positivo: Reutilizable y reciclable.
Positive environmental balance: Reusable and recyclable.



Consumo más responsable: Aporta a los productos una vida útil más larga.
More responsible consumption: Gives products a longer useful life.



Mejor diseño: Permite formas que las espumas tradicionales no permiten.
Better design: Allows shapes that traditional foams do not allow.



Ergonomía: Más confort.
Ergonomics: More comfort.



Ignífuga: Alta resistencia al fuego.
Flame retardant: High resistance to fire.

Sillas Chairs



Taburetes Stools



Butacas Lounge Chairs



Mesas Tables



Centros Side & Coffee Tables



Neo

DESIGN ENRIQUE MARTÍ ASSOCIATES



Neo MR silla: Tejido Sumi Uto. Madera color natural.
Neo MR chair: Fabric Sumi Uto. Wood in natural color.



ES La colección Neo proporciona una sentada amplia y mullida, con un respaldo prolongado que permite el apoyo parcial del brazo. Perfecta para uso en interiores privados, su funcionamiento es también óptimo para el sector de la hostelería por su comodidad y durabilidad.

EN The Neo collection offers a seat that is both wide and soft, and an elongated backrest that allows for partial arm support. Perfect for private indoor use, its operation is also optimal for the hospitality industry for its comfort and durability.



Neo MF silla: Tejido Sumi Handa. Madera color natural.
Nervio mesa: 200x100cm. Madera color natural.
Neo MF chair: Fabric Sumi Handa. Wood in natural color.
Nervio table: 200x100cm. Wood in natural color.



Neo GM silla: Tejido Sumi Narita. Madera color natural.
Radar mesa: Ø140cm. Madera color natural. Metal color negro texturizado.

Neo GM chair: Fabric Sumi Narita. Wood in natural color.
Radar table: Ø140cm. Wood in natural color. Metal in textured black color.



(De izquierda a derecha). Neo taburete madera alto: Tejido X2 Maths. Madera color natural.
 Neo GM silla: Tejido X2 Number. Madera color natural.
 Neo MF silla: Tejido X2 Number. Madera color natural.
 Neo PP silla: Tejido Main Line Flax Upminster. Metal color RAL 1015.
 Neo GA silla: Tejido Main Line Flax Upminster. Metal color negro.
 Neo taburete metal alto: Tejido Main Line Flax Kensington. Metal color RAL 9002.
 Neo PH silla: Tejido X2 Number. Metal color RAL 1015.
 Neo MR silla: Tejido X2 Divide. Madera color nogal.

(From left to right). Neo wood high stool: Fabric X2 Maths. Wood in natural color.
 Neo GM chair: Fabric X2 Number. Wood in natural color.
 Neo MF chair: Fabric X2 Number. Wood in natural color.
 Neo PP chair: Fabric Main Line Flax Upminster. Metal in RAL 1015 color.
 Neo GA chair: Fabric Main Line Flax Upminster. Metal in black color.
 Neo metal high stool: Fabric Main Line Flax Kensington. Metal in RAL 9002 color.
 Neo PH chair: Fabric X2 Number. Metal in RAL 1015 color.
 Neo MR chair: Fabric X2 Divide. Wood in walnut color.



Neo GA silla: Tejido Sumi Noda. Metal color negro.
Panorama mesa: 220x100cm. Cristal transparente. Madera color nogal.

Neo GA chair: Fabric Sumi Noda. Metal in black color.
Panorama table: 220x100cm. Transparent glass. Wood in walnut color.



Neo MF Silla



Neo PP Silla



Neo PH Silla



Neo GM Silla



Neo GA Silla



Neo GR Silla



Neo MR Silla



Neo Taburete Disco



Neo Taburete Metal Alto



Neo Taburete Madera Alto

Neo MR Silla

Carcasa asiento-respaldo a partir de tecnología de moldeo por inyección, con armazón metálico.
 Patas madera de Fresno.
 Seat-backrest shell made from injection molding technology, with metal frame. Ash wood legs.

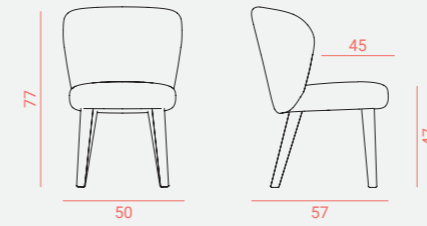

Neo GA Silla

Carcasa asiento-respaldo a partir de tecnología de moldeo por inyección, con armazón metálico.
 Base de aluminio. Mecanismo giratorio con auto-retorno.
 Seat-backrest shell made from injection molding technology, with metal frame. Aluminum base. Swivel mechanism with self-return.

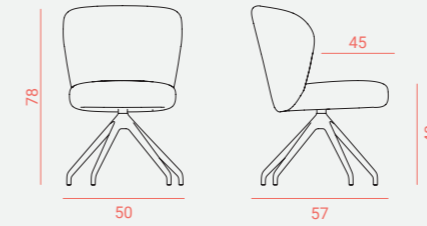

Neo PH Silla

Carcasa asiento-respaldo a partir de tecnología de moldeo por inyección, con armazón metálico.
 Patas tubo metálico de 14mm.
 Seat-backrest shell made from injection molding technology, with metal frame. 14mm metal tube legs.

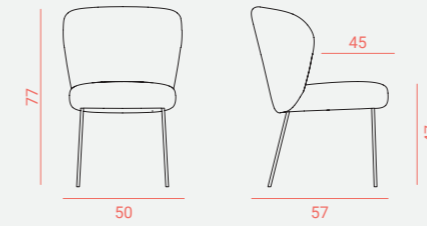

Neo GR Silla

Carcasa asiento-respaldo a partir de tecnología de moldeo por inyección, con armazón metálico.
 Base aluminio pulido y nylon. Mecanismo giratorio, con ruedas y altura regulable.
 Seat-backrest shell made from injection molding technology, with metal frame. Polished aluminum and nylon base. Swivel mechanism, with casters and adjustable height.



Neo Taburete Metal

Carcasa asiento-respaldo a partir de tecnología de moldeo por inyección, con armazón metálico.
 Patas varilla metálica de 12mm.
 Seat-backrest shell made from injection molding technology, with metal frame. 12mm metal rod legs.

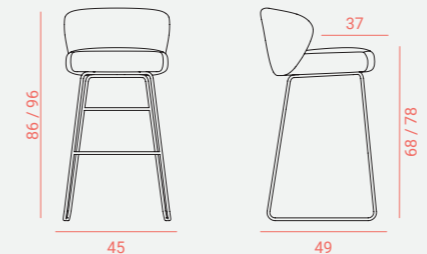

Neo GM Silla

Carcasa asiento-respaldo a partir de tecnología de moldeo por inyección, con armazón metálico.
 Patas madera de Fresno. Mecanismo giratorio.
 Seat-backrest shell made from injection molding technology, with metal frame. Ash wood legs. Swivel mechanism.

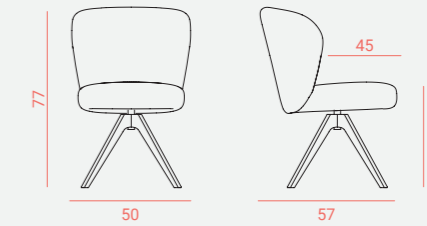

Neo PP Silla

Carcasa asiento-respaldo a partir de tecnología de moldeo por inyección, con armazón metálico.
 Patas varilla metálica de 12mm.
 Seat-backrest shell made from injection molding technology, with metal frame. 12mm metal rod legs.

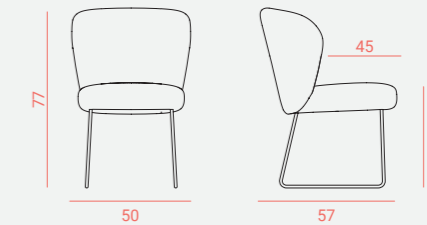

Neo MF Silla

Carcasa asiento-respaldo a partir de tecnología de moldeo por inyección, con armazón metálico.
 Patas madera de Fresno.
 Seat-backrest shell made from injection molding technology, with metal frame. Ash wood legs.

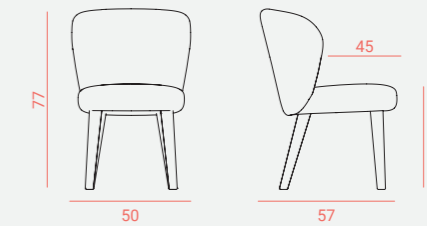

Neo Taburete Disco

Carcasa asiento-respaldo a partir de tecnología de moldeo por inyección, con armazón metálico.
 Base nylon, fibra de vidrio y aluminio. Mecanismo giratorio con altura regulable.
 Seat-backrest shell made from injection molding technology, with metal frame. Nylon, fiberglass and aluminum base. Swivel mechanism with adjustable height.

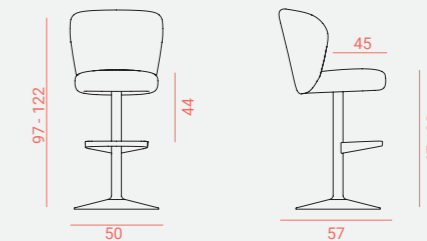

Neo Taburete Madera

Carcasa asiento-respaldo a partir de tecnología de moldeo por inyección, con armazón metálico.
 Patas madera de Fresno.
 Seat-backrest shell made from injection molding technology, with metal frame. Ash wood legs.

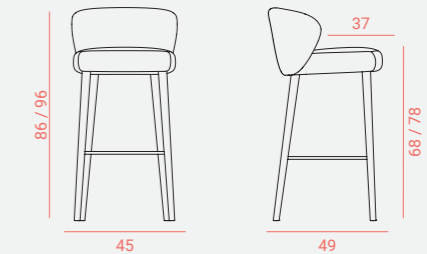

Finn

DESIGN ENRIQUE MARTÍ ASSOCIATES



Finn silla: Tejido Main Line Flax Stratford. Madera color natural.

Finn chair: Fabric Main Line Flax Stratford. Wood in natural color.



ES Inspirada en el trabajo artesanal de la madera, Finn es una expresión renovada del estilo nórdico. Sus dos unidades tapizadas y acolchadas proporcionan gran comodidad y multiplican las posibilidades decorativas y de personalización.

EN Inspired by wood craftsmanship, Finn is a renewed expression of the Nordic style. Its padded backs and seats provide great comfort, and our wide fabrics selection multiply decorative and customization possibilities.



Finn sillón: Tejido Main Line Flax Barbican. Madera color natural.
Cortés mesa: Madera color natural. Metal color RAL 3009.

Finn armchair: Fabric Main Line Flax Barbican. Wood in natural color.
Cortés table: Wood in natural color. Metal in RAL 3009 color.



Finn silla: Tejido Main Line Flax Bayswater. Madera color natural.
Finn sillón: Tejido Main Line Flax Lambeth. Madera color natural.
Evolve mesa: 200x100cm. Madera color natural.

DOOS COLLECTION **ÍNDICE / INDEX** FINN

Finn chair: Fabric Main Line Flax Bayswater. Wood in natural color.
Finn armchair: Fabric Main Line Flax Lambeth. Wood in natural color.
Evolve table: 200x100cm. Wood in natural color.



Finn Silla

Asiento y respaldo acolchados sobre armazón de madera. Madera de fresno.
Padded seat and backrest over wood frame. Ash wood.

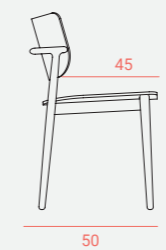
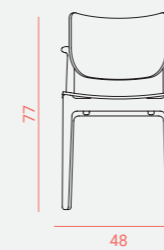

Finn Sillón

Asiento y respaldo acolchados sobre armazón de madera. Madera de fresno.
Padded seat and backrest over wood frame. Ash wood.

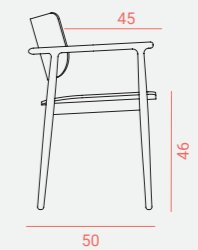
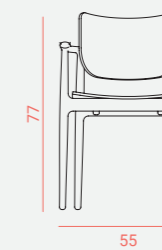

Finn silla: Tejido Main Line Flax Stratford. Madera color natural.
Finn sillón: Tejido Main Line Flax Barbican. Madera color natural.
Evolve mesa: 200x100cm. Madera color natural.

Finn chair: Fabric Main Line Flax Stratford. Wood in natural color.
Finn armchair: Fabric Main Line Flax Barbican. Wood in natural color.
Evolve table: 200x100cm. Wood in natural color.

Finn silla y sillón: Tejido Sumi Nagoya. Madera color natural.
Finn chair and armchair: Fabric Sumi Nagoya. Wood in natural color.

Pelikan

DESIGN ENRIQUE MARTÍ ASSOCIATES



Pelikan PH sillón: Tejido Capture 5501. Metal texturizado color negro.
Pelikan PH armchair: Fabric Capture 5501. Metal in textured black color.



ES Inspirada en la libertad del vuelo de las aves, la familia de asientos Pelikan se caracteriza por sus formas sinuosas, envolvente sentada, uso versátil y alta resistencia. Su agradable sentada es posible gracias a su construcción por espuma inyectada, con propiedades físicas que otras tecnologías más convencionales no permiten.

EN Inspired by the freedom of bird flight, the Pelikan collection is characterized by its sinuous shapes, enveloping seating, versatile use and high resistance. Its pleasant sitting is possible thanks to its injected foam construction, with physical properties that other more conventional technologies do not allow.



Pelikan PP silla, sillón: Tejido Capture 5201 (negro), 7401 (naranja). Metal texturizado color negro.
Evolve mesa: 200x100cm. Madera color natural y madera teñida en negro.

Pelikan PP chair, armchair: Fabric Capture 5201 (black), 7401 (orange). Metal in textured black color.
Evolve table: 200x100cm. Wood in natural color and black dye.





(De izquierda a derecha). Pelikan GM sillón: Tejido Capture 6501. Madera color natural.
Pelikan MF silla: Tejido Capture 5501. Madera color natural.
Pelikan PP silla: Tejido Sumi Tang. Metal texturizado color negro.
Pelikan PA sillón: Tejido Sumi Tang. Metal texturizado color negro.
Pelikan MF sillón: Tejido Capture 6601. Madera color natural.
Pelikan PH silla: Tejido Capture 7201. Metal texturizado color negro.

(From left to right). Pelikan GM armchair: Fabric Capture 6501. Wood in natural color.
Pelikan MF chair: Fabric Capture 5501. Wood in natural color.
Pelikan PP chair: Fabric Sumi Tang. Metal in textured black color.
Pelikan PA armchair: Fabric Sumi Tang. Metal in textured black color.
Pelikan MF armchair: Fabric Capture 6601. Wood in natural color.
Pelikan PH chair: Fabric Capture 7201. Metal in textured black color.



Pelikan PP Sillón



Pelikan GA Silla

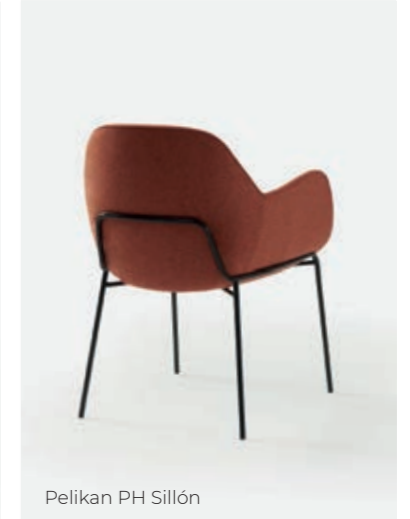

Pelikan PH Sillón



Pelikan MF Silla



Pelikan PA Sillón



Pelikan GR Sillón



Pelikan GM Silla

Pelikan MF Silla / Sillón

Carcasa asiento-respaldo a partir de tecnología de moldeo por inyección, con armazón metálico. Patas madera de fresno.
Seat-backrest shell made from injection molding technology, with metal frame. Ash wood legs.

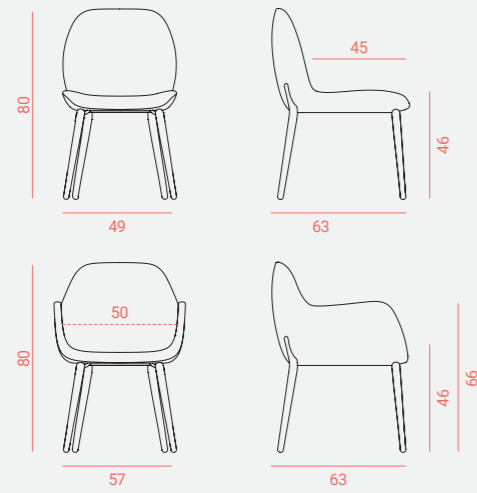

Pelikan GM Silla / Sillón

Carcasa asiento-respaldo a partir de tecnología de moldeo por inyección, con armazón metálico.
Patas madera de fresno. Mecanismo giratorio.
Seat-backrest shell made from injection molding technology, with metal frame. Ash wood legs. Swivel mechanism.

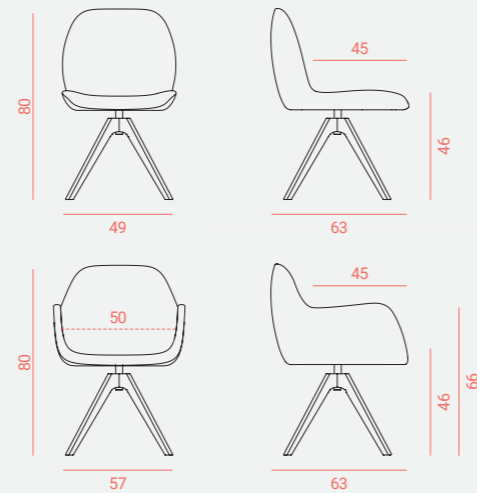

Pelikan GR Silla / Sillón

Carcasa asiento-respaldo a partir de tecnología de moldeo por inyección, con armazón metálico.
Base aluminio pulido y nylon. Mecanismo giratorio, con ruedas y altura regulable.
Seat-backrest shell made from injection molding technology, with metal frame.
Polished aluminum and nylon base. Swivel mechanism, with casters and adjustable height.

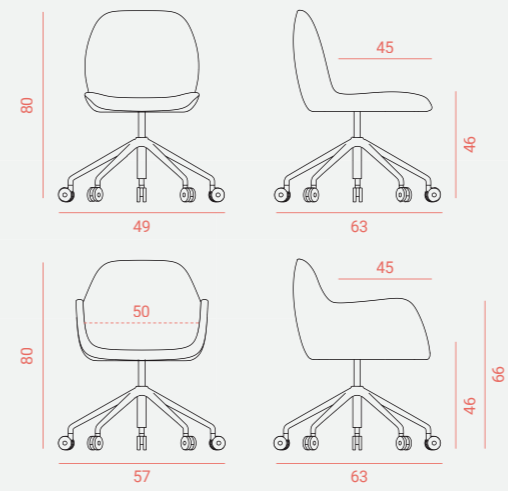

Pelikan GA Silla / Sillón

Carcasa asiento-respaldo a partir de tecnología de moldeo por inyección, con armazón metálico.
Base de aluminio. Mecanismo giratorio con auto-retorno.
Seat-backrest shell made from injection molding technology, with metal frame.
Aluminum base. Swivel mechanism with self-return.

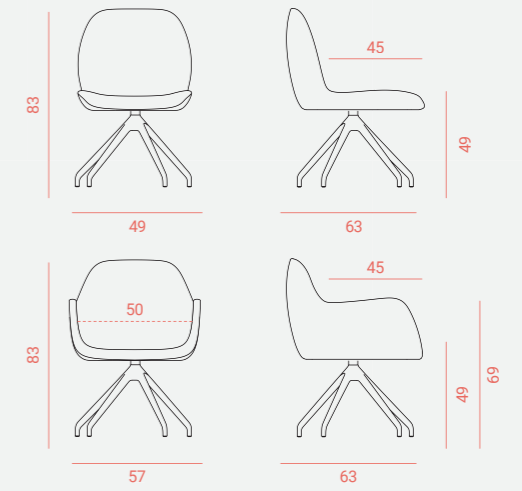

Pelikan PA Silla / Sillón

Carcasa asiento-respaldo a partir de tecnología de moldeo por inyección, con armazón metálico. Patas tubo metálico de 14mm.
Seat-backrest shell made from injection molding technology, with metal frame. 14mm metal tube legs.

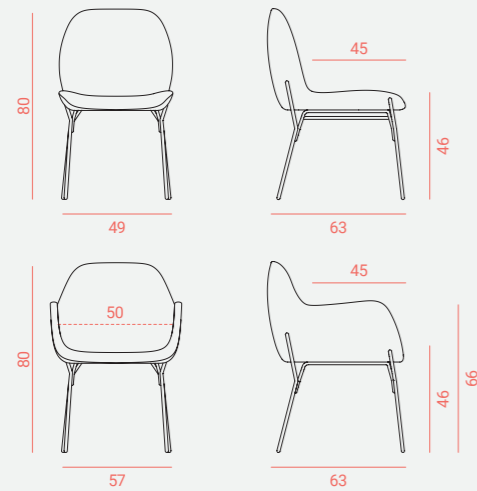

Pelikan PH Silla / Sillón

Carcasa asiento-respaldo a partir de tecnología de moldeo por inyección, con armazón metálico. Patas tubo metálico de 14mm.
Seat-backrest shell made from injection molding technology, with metal frame. 14mm metal tube legs.

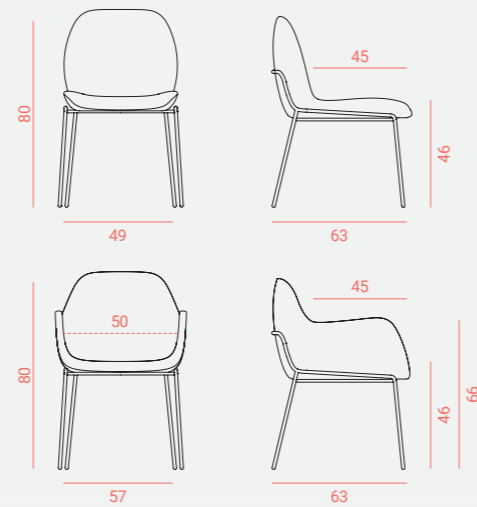

Pelikan PP Silla / Sillón

Carcasa asiento-respaldo a partir de tecnología de moldeo por inyección, con armazón metálico. Patas varilla metálica de 12mm.
Seat-backrest shell made from injection molding technology, with metal frame. 12mm metal rod legs.

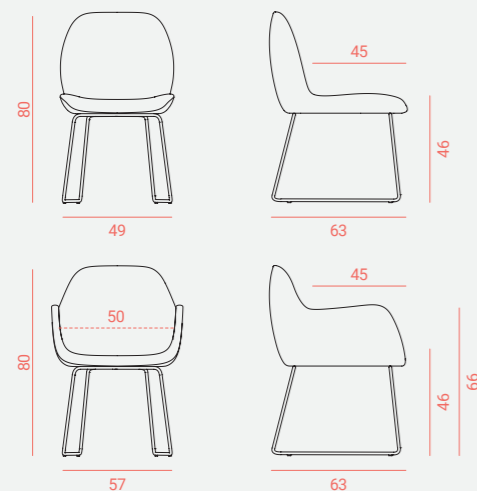

Blur

DESIGN ENRIQUE MARTÍ ASSOCIATES



Blur PH sillón: Tejido Liverpool Ocean. Metal texturizado color negro.

Blur PH armchair: Fabric Liverpool Ocean. Metal in textured black color.



ES Un gran caparazón envuelve el asiento en un suave abrazo. La costura define y diseña las líneas suaves, proporcionando un aspecto elegante y versátil. La colección de asientos Blur se caracteriza por una carcasa circundante y un aspecto elegante y versátil. Un producto muy flexible que puede caber en diferentes tipos de espacios, desde un lugar de lectura en una casa hasta espacios públicos y salones.

EN A large enveloping shell encloses the seat in a soft embrace. The stitching defines and designs the soft lines, providing an elegant and versatile look. The Blur collection of seats, is characterized by a large enveloping shell and an elegant and versatile look. A very flexible product that can fit inside different kind of spaces, from a reading spot in a house to public spaces and lounges.



Blur PP sillón: Tejido Madeira Yellow, metal color RAL 1006. Seattle Salmón, metal texturizado color negro. Babel Red, metal color RAL 3012. Copa mesa: Ø120cm. Madera color blanco. Metal texturizado color blanco.

Blur PP armchair: Fabric Madeira Yellow, metal in RAL 1006 color. Seattle Salmón, metal in textured black color. Babel Red, metal in RAL 3012 color. Copa table: Ø120cm. Wood in white color. Metal in textured white color.



Blur PH sillón: Tejido Madeira Ocean, Madeira Sky, metal texturizado color negro.
 Aliena mesa: 180x90cm. Madera color natural. Metal texturizado color negro.
 Blur PH armchair: Fabric Madeira Ocean, Madeira Sky, metal in textured black color.
 Aliena table: 180x90cm. Wood in natural color. Metal in textured black color.



Blur PP sillón: Tejido Seattle Red, RAL 9022. Apollo Lavanda, RAL 4002. Seattle Ash, RAL 9022.
 Blur PP armchair: Fabric Seattle Red, RAL 9022. Apollo Lavanda, RAL 4002. Seattle Ash, RAL 9022.



(De izquierda a derecha). Blur taburete madera alto. Tejido Capture 4902. Madera color nogal.
 Blur MF sillón: Tejido Seattle Salmon. Madera color natural.
 Blur PP sillón: Tejido Main Line Flax Clapham. Metal texturizado negro.
 Blur MR sillón: Tejido Babel Red. Madera color natural.
 Blur taburete metal alto sin respaldo: Tejido Main Line Flax Richmond. Metal texturizado negro.
 Blur PH sillón: Tejido Seattle Salmon. Metal texturizado negro.
 Blur GM sillón: Tejido Capture 4001. Madera color natural.
 Blur taburete disco: Tejido Capture 4102. Metal color negro.

(From left to right). Blur wood high stool. Fabric Capture 4902. Wood in walnut color.
 Blur MF armchair: Fabric Seattle Salmon. Wood in natural color.
 Blur PP armchair: Fabric Main Line Flax Clapham. Metal in textured black color.
 Blur MR armchair: Fabric Babel Red. Wood in natural color.
 Blur metal high stool, no backrest: Fabric Main Line Flax Richmond. Metal in textured black color.
 Blur PH armchair: Fabric Seattle Salmon. Metal in textured black color.
 Blur GM armchair: Fabric Capture 4001. Wood in natural color.
 Blur disc stool: Fabric Capture 4102. Metal in black color.



Blur PP Sillón



Blur PH Sillón

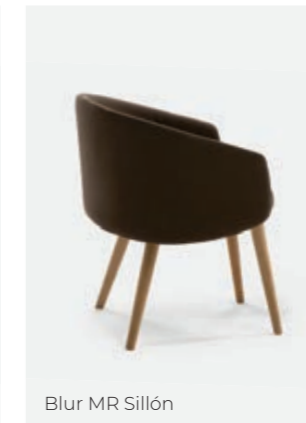

Blur MR Sillón

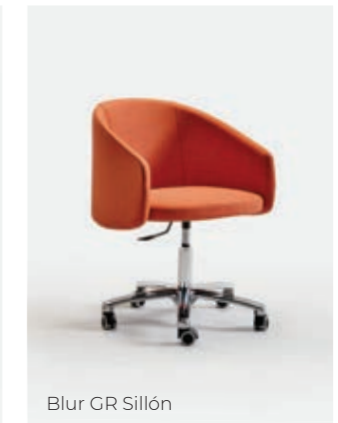

Blur GR Sillón



Blur GM Sillón



Blur GA Sillón



Blur MF Sillón



Tab. Madera Alto Con Respaldo



Tab. Metal Alto Con Respaldo



Tab. Disco Alto Con Respaldo



Tab. Madera Alto Sin Respaldo



Tab. Metal Alto Sin Respaldo



Tab. Disco Alto Sin Respaldo

Blur Lounge sillón: Tapizado Madeira White. Madera color nogal.
John mesa: Madera color natural. Metal color negro texturizado.

Blur Lounge armchair: Fabric Madeira White. Wood in walnut color.
John table: Wood in natural color. Metal in textured black color.

Blur MR Sillón

Carcasa de respaldo a partir de tecnología de moldeo por inyección, con armazón metálico. Patas madera de haya.
Backrest shell made from injection molding technology, with metal frame. Beech wood legs.

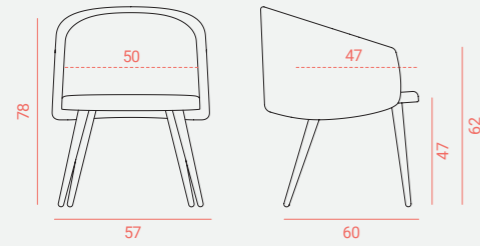

Blur MF Sillón

Carcasa de respaldo a partir de tecnología de moldeo por inyección, con armazón metálico. Patas madera de haya.
Backrest shell made from injection molding technology, with metal frame. Beech wood legs.

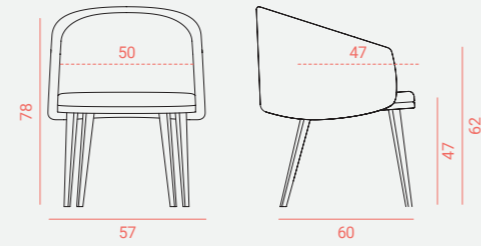

Blur Lounge Sillón

Carcasa de respaldo a partir de tecnología de moldeo por inyección, con armazón metálico. Patas madera de haya.
Backrest shell made from injection molding technology, with metal frame. Beech wood legs.

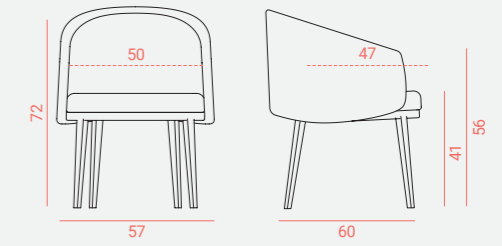

Blur PP Sillón

Carcasa de respaldo a partir de tecnología de moldeo por inyección, con armazón metálico. Patas varilla metálica de 12mm.
Backrest shell made from injection molding technology, with metal frame. 12mm metal rod legs.

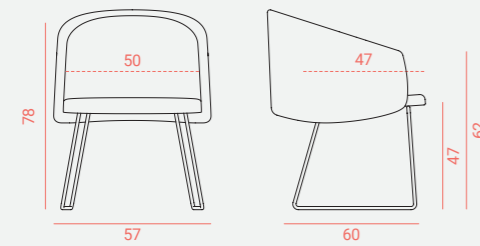

Blur PH Sillón

Carcasa de respaldo a partir de tecnología de moldeo por inyección, con armazón metálico. Patas tubo metálico de 16mm.
Backrest shell made from injection molding technology, with metal frame. 16mm metal tube legs.

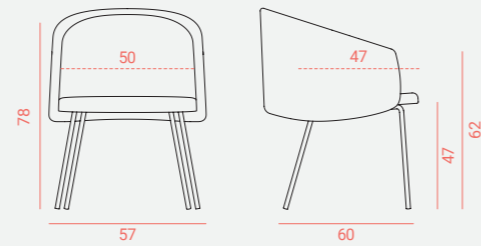

Blur Taburete Madera con Respaldo

Asiento y respaldo acolchados sobre armazón de madera. Patas madera de haya.
Padded seat and backrest on wooden frame. Beech wood legs.

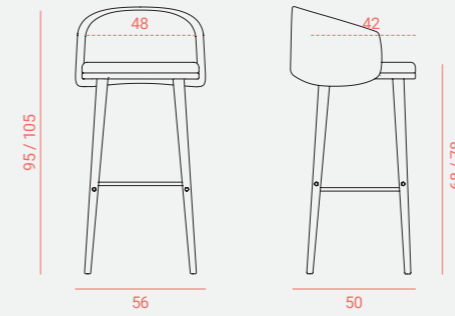

Blur Taburete Madera sin Respaldo

Asiento acolchado sobre armazón de madera. Patas madera de haya.
Padded seat on wooden frame. Beech wood legs.

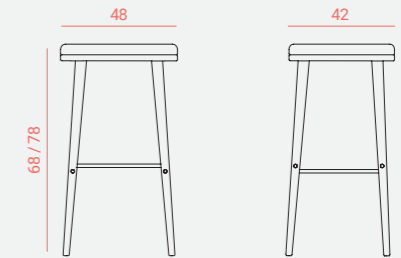

Blur GM Sillón

Carcasa de respaldo a partir de tecnología de moldeo por inyección, con armazón metálico. Patas madera de fresno. Mecanismo giratorio.
Backrest shell made from injection molding technology, with metal frame. Ash wood legs. Swivel mechanism.

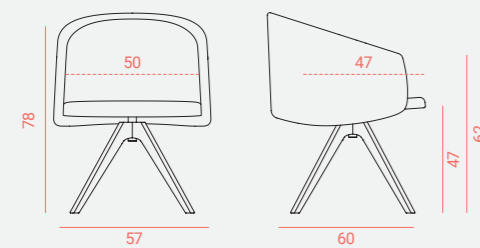

Blur GR Sillón

Carcasa de respaldo a partir de tecnología de moldeo por inyección, con armazón metálico. Base aluminio pulido y nylon. Mecanismo giratorio, con ruedas y altura regulable.
Backrest shell made from injection molding technology, with metal frame. Polished aluminum and nylon base. Swivel mechanism, with casters and adjustable height.

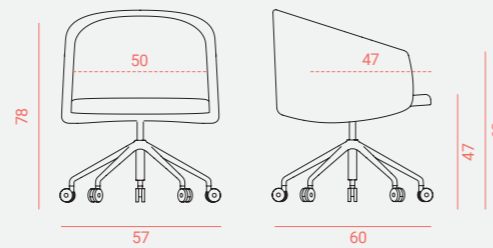

Blur Taburete Metal Con Respaldo

Asiento y respaldo acolchados sobre armazón de madera. Patas varilla metálica de 12mm.
Padded seat and backrest on wooden frame. 12mm metal rod legs.

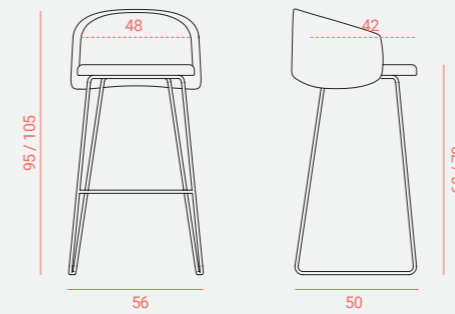

Blur Taburete Metal Sin Respaldo

Asiento acolchado sobre armazón de madera. Patas varilla metálica de 12mm.
Padded seat on wooden frame. 12mm metal rod legs.

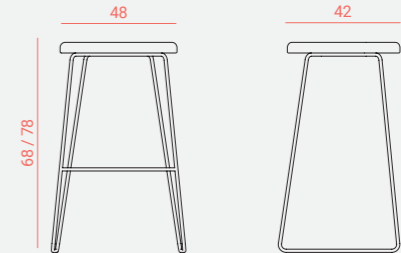

Blur GA Sillón

Carcasa de respaldo a partir de tecnología de moldeo por inyección, con armazón metálico. Base de aluminio. Mecanismo giratorio con auto-retorno.
Backrest shell made from injection molding technology, with metal frame. Aluminum base. Swivel mechanism with self-return.

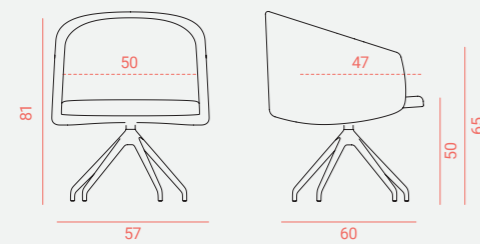

Blur Taburete Disco Con Respaldo

Asiento y respaldo acolchados sobre armazón de madera. Base nylon, fibra de vidrio y aluminio. Mecanismo giratorio con altura regulable.
Padded seat and backrest on wooden frame. Nylon, fiberglass and aluminum base. Swivel mechanism with adjustable height.

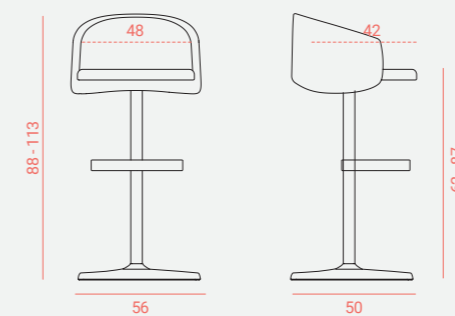

Blur Taburete Disco Sin Respaldo

Asiento acolchado sobre armazón de madera. Base nylon, fibra de vidrio y aluminio. Mecanismo giratorio con altura regulable.
Padded seat on wooden frame. Nylon, fiberglass and aluminum base. Swivel mechanism with adjustable height.

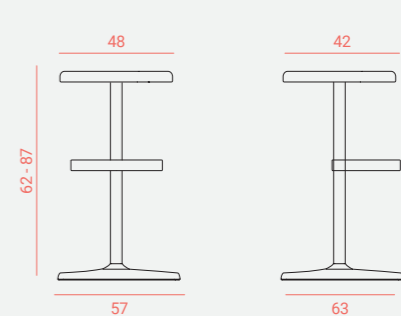

Evia

DESIGN ENRIQUE MARTÍ ASSOCIATES



ES Evia se adapta a todas las necesidades objetivas de belleza, comodidad, resistencia y durabilidad. De formas femeninas y redondeadas, suaves y sensuales, ligeras y esbeltas, Evia seduce a primera vista. Es camaleónico y adaptable, pudiendo ser desde un cálido compañero de lectura hasta un perfecto complemento del trabajo diario.

EN Evia adapts to virtually all objective needs of beauty, comfort, strength and durability. With feminine and rounded shapes, soft and sensual, light and slim, Evia seduces at first sight. Evia is chameleonic and adaptable, ranging from a warm reading companion to a perfect complement to daily work.



Evia MF sillón: Tejido Gent 01. Madera color natural.
Nervio mesa: 200x100cm. Madera color natural.

Evia MF armchair: Fabric Gent 01. Wood in natural color.
Nervio table: 200x100cm. Wood in natural color.





(De izquierda a derecha). Evia PZ sillón: Tejido Main Line Flax Redbridge. Metal texturizado color negro.
 Evia MF sillón: Tejido Main Line Flax Parsons. Madera color natural.
 Evia PP sillón: Tejido Main Line Flax Redbridge. Metal texturizado color negro.
 Evia MR sillón: Tejido Main Line Flax Upminster. Madera color natural.
 Evia GA sillón: Tejido Main Line Flax Whitechapel. Metal color negro.
 Evia GM sillón: Tejido Main Line Flax Redbridge. Madera color natural.
 Evia PH sillón: Tejido Main Line Flax Goldhawk. Metal texturizado color negro.

(From left to right). Evia PZ armchair: Fabric Main Line Flax Redbridge. Metal in textured black color.
 Evia MF armchair: Fabric Main Line Flax Parsons. Wood in natural color.
 Evia PP armchair: Fabric Main Line Flax Redbridge. Metal in textured black color.
 Evia MR armchair: Fabric Main Line Flax Upminster. Wood in natural color.
 Evia GA armchair: Fabric Main Line Flax Whitechapel. Metal in black color.
 Evia GM armchair: Fabric Main Line Flax Redbridge. Wood in natural color.
 Evia PH armchair: Fabric Main Line Flax Goldhawk. Metal in textured black color.





Evia MF Sillón



Evia PP Sillón



Evia PZ Sillón



Evia GM Sillón



Evia MR Sillón



Evia PH Sillón



Evia GA Sillón



Evia GR Sillón

Evia GR Sillón

Carcasa asiento-respaldo a partir de tecnología de moldeo por inyección, con armazón metálico. Base aluminio pulido y nylon. Mecanismo giratorio, con ruedas y altura regulable.
Seat-backrest shell made from injection molding technology, with metal frame. Polished aluminum and nylon base. Swivel mechanism, with casters and adjustable height.

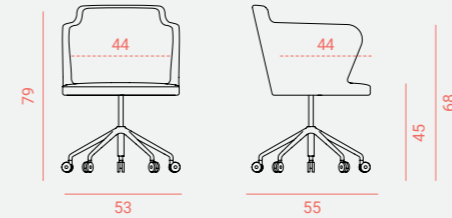

Evia GM Sillón

Carcasa asiento-respaldo a partir de tecnología de moldeo por inyección, con armazón metálico. Patas madera de fresno. Mecanismo giratorio.
Seat-backrest shell made from injection molding technology, with metal frame. Ash wood legs. Swivel mechanism.

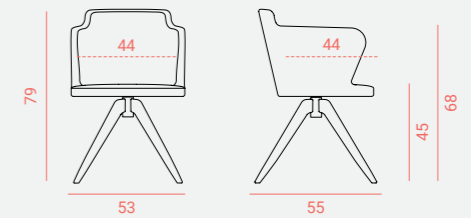

Evia GA Sillón

Carcasa asiento-respaldo a partir de tecnología de moldeo por inyección, con armazón metálico. Base de aluminio. Mecanismo giratorio con auto-retorno.
Seat-backrest shell made from injection molding technology, with metal frame. Aluminum base. Swivel mechanism with self-return.

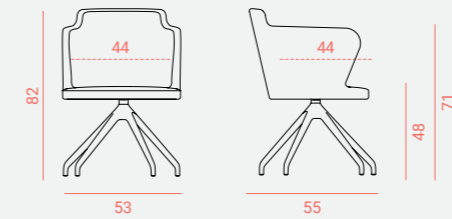

Evia PP Sillón

Carcasa asiento-respaldo a partir de tecnología de moldeo por inyección, con armazón metálico. Patas varilla metálica de 12mm.
Seat-backrest shell made from injection molding technology, with metal frame. 12mm metal rod legs.

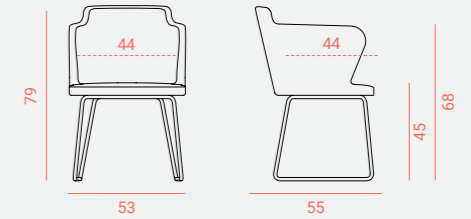

Evia PH Sillón

Carcasa asiento-respaldo a partir de tecnología de moldeo por inyección, con armazón metálico. Patas tubo metálico de 14mm.
Seat-backrest shell made from injection molding technology, with metal frame. 14mm metal tube legs.

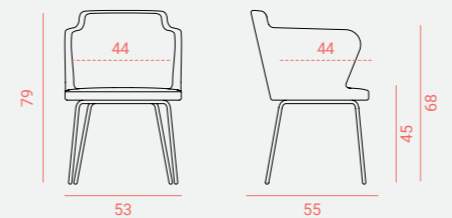

Evia MF Sillón

Carcasa asiento-respaldo a partir de tecnología de moldeo por inyección, con armazón metálico. Patas madera de fresno.
Seat-backrest shell made from injection molding technology, with metal frame. Ash wood legs.

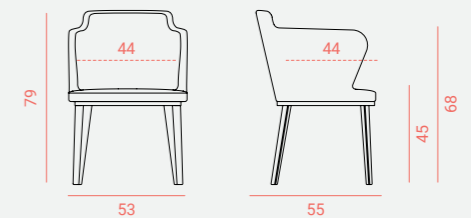

Evia MR Sillón

Carcasa asiento-respaldo a partir de tecnología de moldeo por inyección, con armazón metálico. Patas madera de fresno.
Seat-backrest shell made from injection molding technology, with metal frame. Ash wood legs.

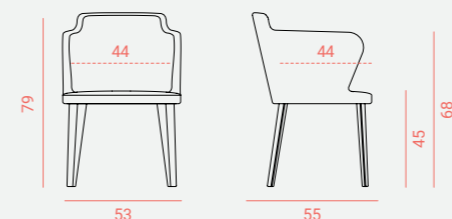

Evia PZ Sillón

Carcasa asiento-respaldo a partir de tecnología de moldeo por inyección, con armazón metálico. Patas tubo metálico de 14mm.
Seat-backrest shell made from injection molding technology, with metal frame. 14mm metal tube legs.

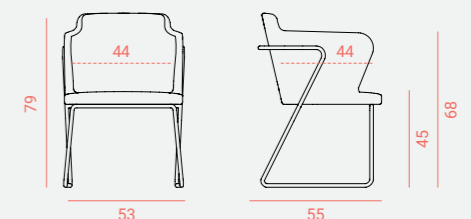

Pure

DESIGN ENRIQUE MARTÍ ASSOCIATES



Pure sillón: Madera color natural.

Pure armchair: Wood in natural color.



ES La colección Pure es una búsqueda de la simplicidad que recuerda a las sillas tradicionales. De proporciones contenidas y ligera, sus dimensiones suaves y compactas líneas transmiten a la perfección el concepto de una silla que habla un lenguaje universal.

EN The Pure collection is a search for simplicity reminiscent of traditional chairs. Minimalist in proportions and light-weighted, its soft dimensions and compact volumes perfectly convey the concept of a chair that speaks a universal language.



Radar mesa: Ø140cm. Porcelánico Fokos Sale. Madera color nogal.

Pure silla y sillón: Madera color nogal.

Radar table: Ø140cm. Porcelain Fokos Sale. Wood in walnut color.

Pure chair and armchair: Wood in walnut color.



Pure silla: Madera teñida en negro. Tejido X2 Number.
Grace mesa: HPL color Antique White. Madera color natural.

Pure chair: Wood in black dye color. Fabric X2 Number.
Grace table: HPL in Antique White color. Wood in natural color.



Pure Silla

Madera y contrachapado de fresno.
Asiento opcional acolchado y tapizado.
Ash wood and plywood.
Optional padded and upholstered seat.

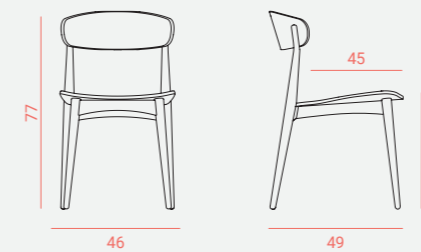

Pure Sillón

Madera y contrachapado de fresno.
Asiento opcional acolchado y tapizado.
Ash wood and plywood.
Optional padded and upholstered seat.

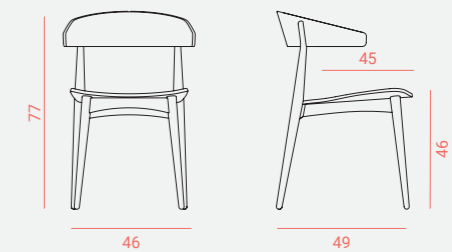

Karen

DESIGN ENRIQUE MARTÍ ASSOCIATES



Karen PP silla: Madera color RAL 3003. Metal texturizado color negro.

Karen PP chair: Wood in RAL 3003 color. Metal in textured black color.



ES Karen son asientos con mucha personalidad, que les viene dada por su respaldo en forma de "T" de proporciones amplias. Destacan por su orientación funcional y aptitud para uso intensivo en ambientes demandantes.

EN Karen are seats with a lot of personality, which is given their back piece in the form of "T" of wide proportions. Karen seats stand out for their functional orientation and aptitude for intensive use in demanding environments.



Karen MF silla: Madera color natural.

Pluma mesa: Ø90cm. HPL color Earth. Metal color RAL 7006.

Karen MF chair: Wood in natural color.

Pluma table: Ø90cm. HPL in Earth color. Metal in RAL 7006 color.



(De izquierda a derecha). Karen MF silla: Madera color natural.
Karen PP silla: Madera color natural. Metal color RAL 7006.
Karen MR silla: Madera color natural.
Karen PH silla: Madera color natural. Metal color RAL 7006.
Karen maburete madera bajo: Madera color natural. Tejido X2 Polygon.
Karen taburete metal alto: Madera color natural. Metal color RAL 7006.

(From left to right). Karen MF chair: Wood in natural color.
Karen PP chair: Wood in natural color. Metal in RAL 7006 color.
Karen MR chair: Wood in natural color.
Karen PH chair: Wood in natural color. Metal in RAL 7006 color.
Karen wood low stool: Wood in natural color. Fabric X2 Polygon.
Karen metal high stool: Wood in natural color. Metal in RAL 7006 color.



Karen MR Silla



Karen PH Silla



Karen PP Silla



Karen MF Silla



Karen Taburete Madera Bajo



Karen Taburete Metal Alto

Karen MR Silla
Madera y contrachapado de fresno.
Ash wood and plywood.

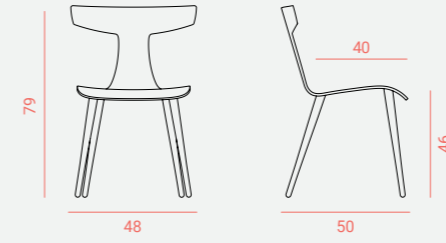

Karen PP Silla
Contrachapado de fresno. Varilla metálica de 12mm.
Ash plywood. 12mm metal rod.

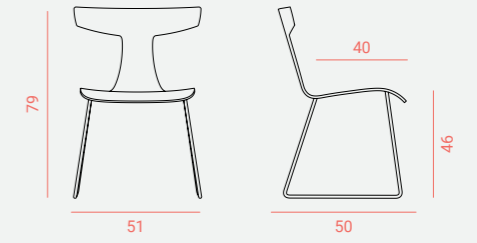

Karen PH Silla
Contrachapado de fresno. Tubo metálico de 14mm.
Ash plywood. 14mm metal tube.

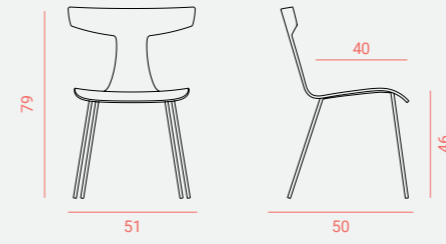

Karen MF Silla
Madera y contrachapado de fresno.
Ash wood and plywood.

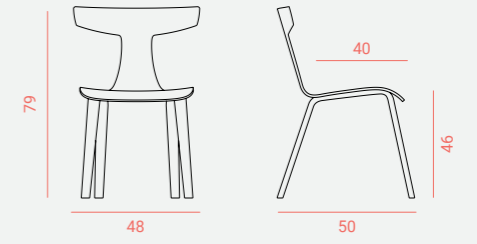

Karen Taburete Madera
Contrachapado de fresno. Madera de fresno.
Ash wood and plywood.

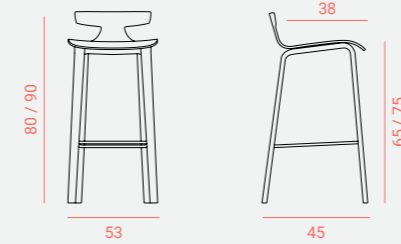

Karen Taburete Metal
Contrachapado de fresno. Varilla metálica de 12mm.
Ash plywood. 12mm metal rod.

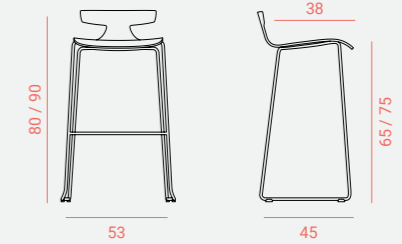

Dalia

DESIGN ENRIQUE MARTÍ ASSOCIATES



Dalia MR silla: Madera teñida en negro. Tejido Main Line Flax Stratford.

Dalia MR chair: Wood in black dye color. Fabric Main Line Flax Stratford.



ES Dalia son asientos con un carácter funcional y adaptable. Dotados de gran resistencia y durabilidad, están pensados para un uso continuado y mantenimiento muy fácil.

EN Dalia are functional and adaptable seats. Highly resistant and durable, they are designed for continuous use and very easy maintenance.



Dalia MR silla: Madera color natural.

Pluma mesa: 80x80cm. HPL color Green Slate. Metal color RAL 9001.

Dalia MR chair: Wood in natural color.

Pluma table: 80x80cm. HPL in Green Slate color. Metal in RAL 9001 color.



(De izquierda a derecha). Dalia MF silla: Madera color natural.
Dalia PP silla: Madera color natural. Metal color RAL 8002.
Dalia MR silla: Madera color natural. Tejido Silvertex Basil.
Dalia PH silla: Madera color natural. Metal color RAL 8002.
Dalia maburete madera bajo: Madera color natural. Tejido Silvertex Basil.
Dalia taburete metal alto: Madera color natural. Metal color RAL 8002.

(From left to right). Dalia MF chair: Wood in natural color.
Dalia PP chair: Wood in natural color. Metal in RAL 8002 color.
Dalia MR chair: Wood in natural color. Fabric Silvertex Basil.
Dalia PH chair: Wood in natural color. Metal in RAL 8002 color.
Dalia wood low stool: Wood in natural color. Fabric Silvertex Basil.
Dalia metal high stool: Wood in natural color. Metal in RAL 8002 color.



Dalia MF Silla



Dalia PH Silla



Dalia PP Silla



Dalia MR Silla



Dalia Taburete Madera Bajo



Dalia Taburete Metal Alto

Dalia MF Silla
Madera y contrachapado de fresno.
Ash wood and plywood.

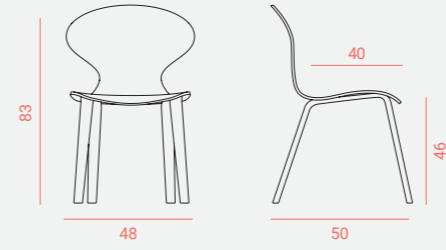

Dalia PH Silla
Contrachapado de fresno. Tubo metálico de 14mm.
Ash plywood. 14mm metal tube.

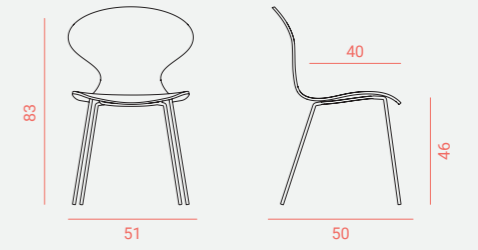

Dalia PP Silla
Contrachapado de fresno. Varilla metálica de 12mm.
Ash plywood. 12mm metal rod.

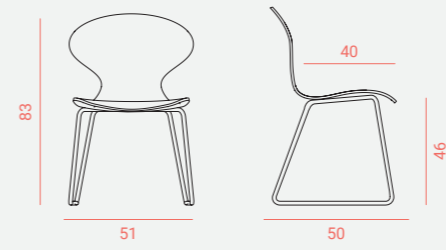

Dalia MR Silla
Madera y contrachapado de fresno.
Ash wood and plywood.

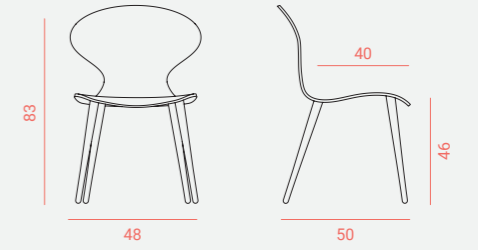

Dalia Taburete Madera
Contrachapado de fresno. Madera de fresno.
Ash wood and plywood.

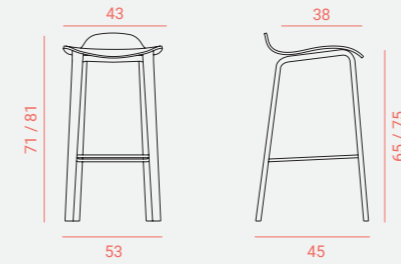

Dalia Taburete Metal
Contrachapado de fresno. Varilla metálica de 12mm.
Ash plywood. 12mm metal rod.

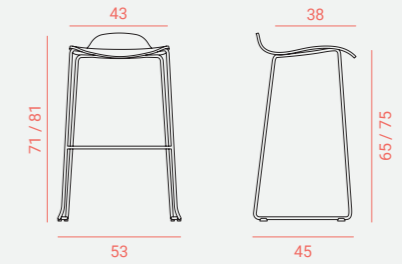

Zeta

DESIGN ENRIQUE MARTÍ ASSOCIATES



ES Zeta es una decidida apuesta por la sobriedad, la elegancia y la funcionalidad. Está pensada sobre todo para el mundo de la hostelería y la restauración, aunque también cumple perfectamente en la calidez del hogar. Es un ejercicio de estilo que combina minimalismo con la sensualidad y amabilidad de sus curvas.

EN Zeta is a firm commitment to sobriety, elegance, and functionality. Mainly designed for the world of hotels and restaurants, it also complies perfectly with the warmth of any home. It is an exercise of style that combines minimalism with the sensuality and softness of its curves.



Zeta sillón: Piel color Antracita. Metal cromado.
Ópera mesa: 240x110cm. Madera color natural.

Zeta armchair: Leather in Anthracite color. Chromed metal.
Ópera table: 240x110cm. Wood in natural color.



Zeta Sillón

Asiento y respaldo acolchados sobre armazón de madera.
 Tubo metálico de 14mm.
 Padded seat and backrest over wood frame.
 14mm metal tube.

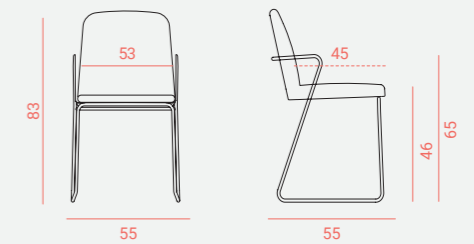

Retro

DESIGN ENRIQUE MARTÍ ASSOCIATES



Retro silla: Tejido Seattle Black. Madera color natural.

Retro chair: Fabric Seattle Black. Wood in natural color.



ES Retro es un clásico que no acusa el paso del tiempo. Retro tiene una presencia sólida, contundente, sobria, y está pensada para abrazar en la sentada. Por eso gusta desde el primer encuentro y conquista para siempre con su uso. Su funcionamiento en entornos de gran actividad es sobresaliente, pero también destaca en contextos íntimos y personales.

EN Retro is a classic which stands the test of time. Retro has a solid, forceful, sober presence, and is designed to embrace while sitting. That is why it attracts since the first encounter and conquers forever with its use. Its performance in highly active environments is outstanding, but also excels in intimate and personal contexts.



Retro silla: Tejido Main Line Flax Watford. Madera teñida en negro.
Goltay mesa: 160x90cm. Madera color natural.

Retro chair: Fabric Main Line Flax Watford. Wood in black dye color.
Goltay table: 160x90cm. Wood in natural color.



Retro Chair

Asiento y respaldo acolchados sobre armazón de madera. Patas madera de haya.
 Padded seat and backrest over wood frame. Beech wood legs.

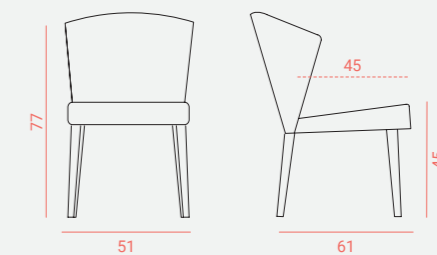

Retro silla: Tejido Yoredale Burnsall. Madera color natural.
 Ópera mesa: 200x100cm. Madera color natural.

Retro chair: Fabric Yoredale Burnsall. Wood in natural color.
 Ópera table: 200x100cm. Wood in natural color.

Retro silla: Tejido X2 Acute. Madera color nogal.
 Retro chair: Fabric X2 Acute. Wood in walnut color.

Cala

DESIGN ENRIQUE MARTÍ ASSOCIATES



Cala silla: Madera color natural.

Cala chair: Wood in natural color.



ES Cala está pensada para un uso intensivo en ambientes muy demandantes gracias a su robustez y gran comodidad, con un amplio asiento que puede ser tapizado.

EN The robustness and comfort of Cala make it ideal for intensive use in very demanding environments, and it features a large seat that can be upholstered.



Cala silla: Madera color nogal.

Pluma mesa: Ø90cm. HPL color Henna. Metal color RAL 9001.

Cala chair: Wood in walnut color.

Pluma table: Ø90cm. HPL in Henna color. Metal in RAL 9001 color.



Cala Chair

Madera y contrachapado de haya. Asiento opcional acolchado y tapizado.
 Beech wood and plywood. Optional padded and upholstered seat.

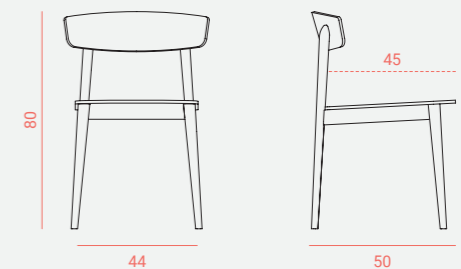

Cala silla: Madera color nogal.
 Pluma mesa: 80x80cm. HPL color Night Sea. Metal color RAL 5008.
 Cala chair: Wood in walnut color.
 Pluma table: 80x80cm. HPL in Night Sea color. Metal in RAL 5008 color.

Cala silla: Tejido Madeira Orange. Madera color nogal.
 Cala silla: Madera color natural.
 Cala chair: Fabric Madeira Orange. Wood in walnut color.
 Cala chair: Wood in natural color.

Solid

DESIGN ENRIQUE MARTÍ ASSOCIATES



Solid silla: Tejido X2 Álgebra. Madera color natural.

Solid chair: Fabric X2 Álgebra. Wood in natural color.



ES Solid es un diseño esencial y sobrio, aunque también cálido y acogedor. De gran adaptabilidad para espacios colectivos o residenciales, su durabilidad la hace una elección segura.

EN Solid is a design that is both essential and sober, but also warm and inviting. It is a safe choice for communal or residential spaces because it is highly adaptable and durable.



Solid silla: Tejido X2 Percentage. Madera color natural.

Ópera mesa: 240x110cm. Madera color natural.

Bandeja Giratoria: Porcelánico Fokos Grafite.

Solid chair: Fabric X2 Percentage. Wood in natural color.

Ópera table: 240x110cm. Wood in natural color.

Lazy Susan: Porcelain Fokos Grafite.



Solid Taburete
Madera de haya. Asiento acolchado y tapizado.
Beech wood. Padded and upholstered seat.

Solid Silla
Madera de haya. Asiento acolchado y tapizado.
Beech wood. Padded and upholstered seat.

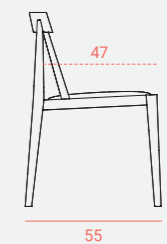
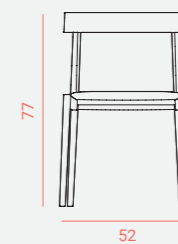
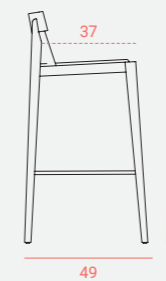
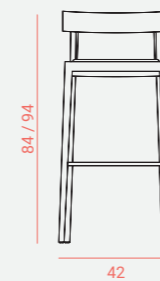

Solid silla: Tejido X2 Álgebra. Madera color natural.
Pluma mesa: Ø90cm. HPL color Green Slate. Metal color RAL 9001.
Solid chair: Fabric X2 Álgebra. Wood in natural color.
Pluma table: Ø90cm. HPL in Green Slate color. Metal in RAL 9001 color.

Solid taburete alto: Tejido X2 Porcentaje. Madera color natural.
Solid silla: Tejido X2 Divide. Madera color natural.
Solid high stool: Fabric X2 Porcentaje. Wood in natural color.
Solid chair: Fabric X2 Divide. Wood in natural color.

Casia

DESIGN ENRIQUE MARTÍ ASSOCIATES



ES Casia es menuda y sencilla, una colección diseñada para acompañar con elegancia y discreción cualquier tipo de decoración. Cómoda y adaptable, CASIA transmite cercanía en sus ajustadas proporciones y redondeadas aristas.

EN Casia is petite and simple, a collection designed to accompany with elegance and discretion any type of decoration. Comfortable and adaptable, CASIA transmits closeness in its tight proportions and rounded edges.



Casia silla: Tejido Bristol Mouse. Madera teñida color negro.
Grace mesa: Ø120cm. Madera color natural y teñida color negro.

Casia chair: Fabric Bristol Mouse. Wood in black dye color.
Grace table: Ø120cm. Wood in natural color and black dye color.



Casia Silla



Casia Sillón



Casia Taburete Alto

Casia Silla

Asiento-respaldo acolchados y tapizados sobre armazón de madera. Patas madera de haya.
Padded and upholstered seat-backrest over wood frame. Beech wood legs.

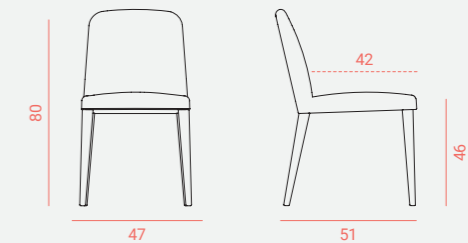

Casia Taburete

Asiento-respaldo acolchados y tapizados sobre armazón de madera. Patas madera de haya.
Padded and upholstered seat-backrest over wood frame. Beech wood legs.

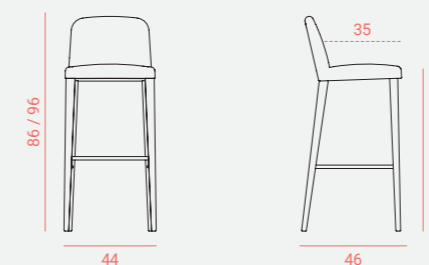

Casia Sillón

Asiento-respaldo acolchados y tapizados sobre armazón de madera. Patas madera de haya.
Padded and upholstered seat-backrest over wood frame. Beech wood legs.

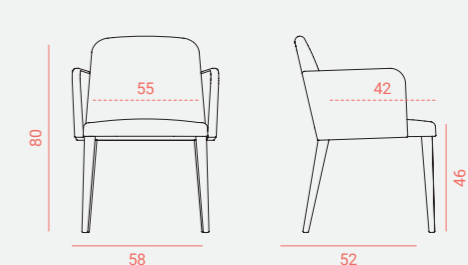

Amable

DESIGN ACHODOSO



Amable butaca fija: Tejido Synergy Contribution. Madera color nogal.
Amable fixed armchair: Fabric Synergy Contribution. Wood in walnut color.



ES Caracterizada por la singularidad de sus formas, Amable es icónica, de proporciones desafiantes, aunque también encantadora y muy confortable. Amable proporciona unas condiciones de relax únicas; crea un entorno íntimo donde los sonidos exteriores disminuyen.

EN Characterized by the uniqueness of its shapes, Amable is iconic, of challenging proportions, but also charming and very comfortable. Amable provides unique relaxing conditions; creates an intimate environment where outside sounds are reduced.



Amable butaca giratoria: Tejido Synergy Similar. Madera color natural.
Cortés mesa: Altura 45cm. Madera color natural. Metal color RAL 3009.

Amable swivel armchair: Fabric Synergy Similar. Wood in natural color.
Cortés table: Height 45cm. Wood in natural color. Metal in RAL 3009 color.



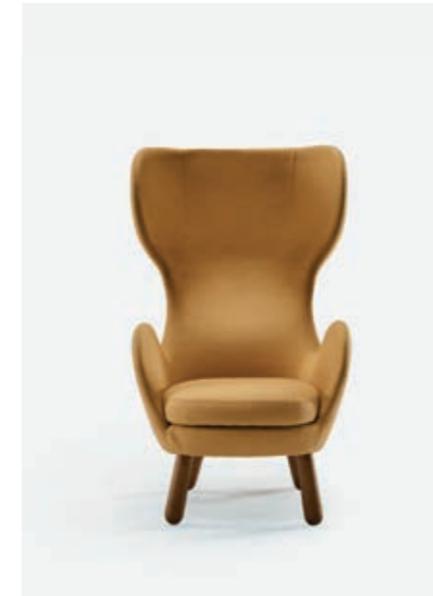

Amable Butaca Fija

Carcasa asiento-respaldo a partir de tecnología de moldeo por inyección, con armazón metálico. Base madera de haya.
 Seat-backrest shell made from injection molding technology, with metal frame. Beech wood base.

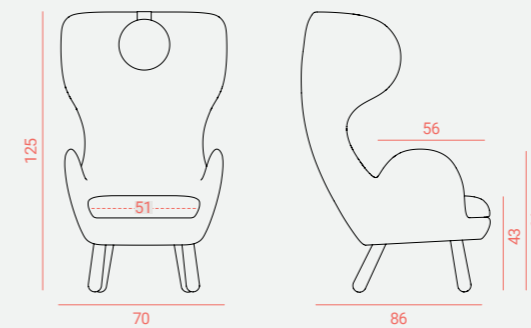

Amable Butaca Giratoria

Carcasa asiento-respaldo a partir de tecnología de moldeo por inyección, con armazón metálico. Base madera de fresno. Mecanismo giratorio.
 Seat-backrest shell made from injection molding technology, with metal frame. Ash wood base. Swivel mechanism.

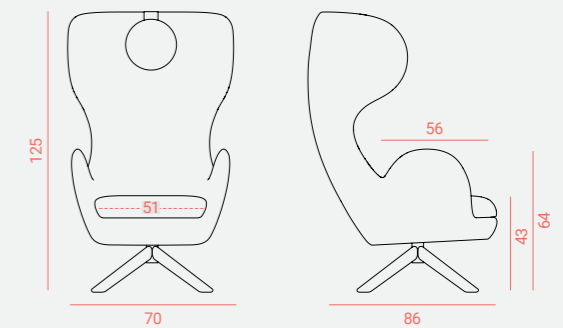

Aurora

DESIGN ENRIQUE MARTÍ ASOCIADOS



Aurora butaca giratoria respaldo bajo: Tejido Silk Arabia. Madera color natural.

Aurora swivel armchair, low backrest: Fabric Silk Arabia. Wood in natural color.



ES Aurora es una pieza escultórica con una expresión minimalista. Su construcción sólida pero liviana conserva todas las características de los grandes clásicos, al tiempo que agrega comodidad y relax a la serie.

EN Aurora is a sculptural piece with a minimalist expression. Its solid but lightweight construction retains all the characteristics of the great classics while adding comfort and relaxation to the series.



Aurora butaca fija, respaldo bajo: Tejido Yoredale Gordale, vivo Yoredale Marsden. Madera color RAL 5009.

Aurora fixed armchair, low backrest: Fabric Yoredale Gordale, welt Yoredale Marsden. Wood in RAL 5009 color.





Aurora Butaca Fija Respaldo Bajo
 Asiento y respaldo acolchados sobre armazón de madera.
 Base madera de roble.
 Padded seat and backrest over wood frame.
 Oak wood base.

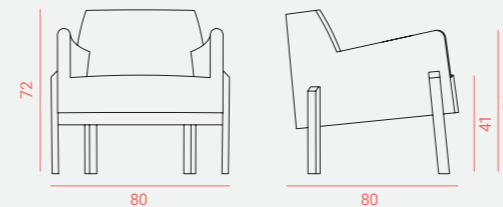

Aurora Butaca Fija Respaldo Alto
 Asiento y respaldo acolchados sobre armazón de madera.
 Base madera de roble.
 Padded seat and backrest over wood frame.
 Oak wood base.

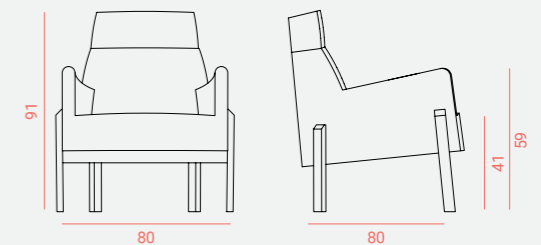

Aurora Butaca Giratoria Respaldo Bajo
 Asiento y respaldo acolchados sobre armazón de madera.
 Base madera de fresno. Mecanismo giratorio.
 Padded seat and backrest over wood frame.
 Ash wood base. Swivel mechanism.

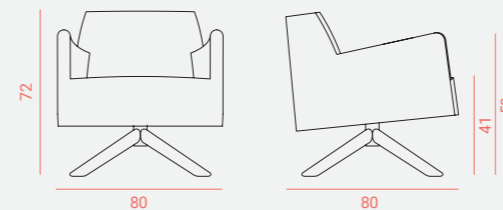

Aurora Butaca Giratoria Respaldo Alto
 Asiento y respaldo acolchados sobre armazón de madera.
 Base madera de fresno. Mecanismo giratorio.
 Padded seat and backrest over wood frame.
 Ash wood base. Swivel mechanism.

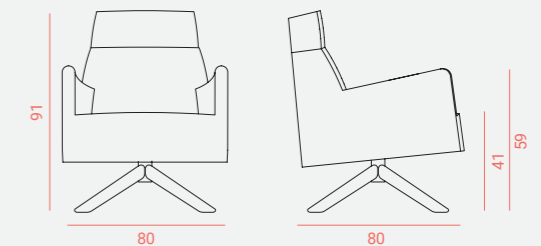

Aurora butaca giratoria, respaldo alto: Tejido Yoredale Gordale, vivo Yoredale Buckden. Madera color natural.

Aurora swivel armchair, high backrest: Fabric Yoredale Gordale, welt Yoredale Buckden. Wood in natural color.

Aurora butaca giratoria, respaldo bajo: Tejido X2 Number. Madera color natural.
 Aurora butaca fija, respaldo alto: Tejido Yoredale Darley, vivo Yoredale Gordale. Madera color natural.

Aurora swivel armchair, low backrest: Fabric X2 Number. Wood in natural color.
 Aurora fixed armchair, high backrest: Fabric Yoredale Darley, welt Yoredale Gordale. Wood in natural color.

King

DESIGN VICENTE SOTO



King butaca giratoria: Tejido Main Line Flax Newbury. Madera color natural.

King swivel armchair: Fabric Main Line Flax Newbury. Wood in natural color.



ES King es una de las piezas con más carácter de toda nuestra colección y todo un clásico. Es esbelta e imponente, resistente, sólida y proporcionada. Su ligero movimiento de balanceo, unido a su altísima comodidad, producen ambos un imprescindible para el relax.

EN King is one of the pieces with more character in our entire collection and a classic. It is very slender and imposing, resistant, solid, and harmonious. Its slight rocking motion, with its very high comfort, both produce an essential piece for relaxation.



King butaca fija: Tejido Main Line Flax Edgware. Metal texturizado color negro.
King fixed armchair: Fabric Main Line Flax Edgware. Metal in textured black color.

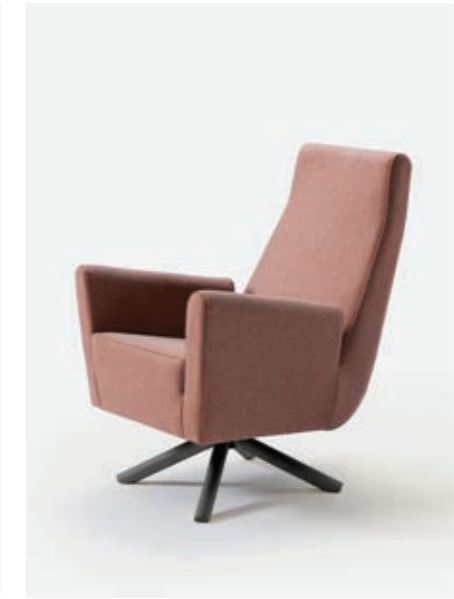

King Butaca Fija

Asiento y respaldo acolchados sobre armazón de madera.
Base de metal.
Padded seat and backrest over wood frame.
Metal base.

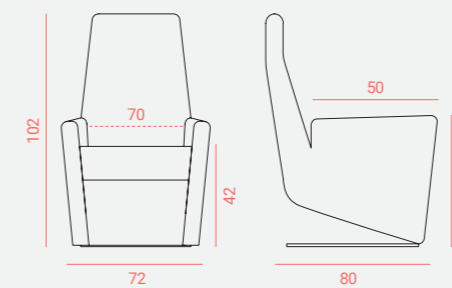

King Butaca Giratoria

Asiento y respaldo acolchados sobre armazón de madera.
Base madera de fresno. Mecanismo giratorio.
Padded seat and backrest over wood frame.
Ash wood base. Swivel mechanism.

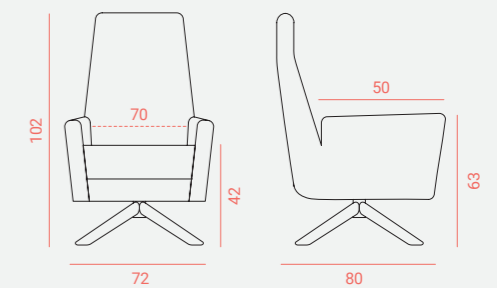

King butaca giratoria: Tejido Main Line Flax Epping. Madera color natural.
Yoko mesa: 110x60cm. Porcelánico Fokos Grafite. Metal texturizado color negro.
King swivel armchair: Fabric Main Line Flax Epping. Wood in natural color.
Yoko table: 110x60cm. Porcelain Fokos Grafite. Metal in textured black color.

King butaca fija: Tejido Main Line Flax Greenwich. Metal texturizado color óxido.
King butaca giratoria: Tejido Main Line Flax Barbican. Madera color RAL 7037.
King fixed armchair: Fabric Main Line Flax Greenwich. Metal in textured oxide color.
King swivel armchair: Fabric Main Line Flax Barbican. Wood in RAL 7037 color.

Cleo

DESIGN ENRIQUE MARTÍ ASSOCIATES



Cleo 187 sofa: Tejido Madeira Cement. Madera color natural.

Cleo 187 sofa: Fabric Madeira Cement. Wood in natural color.



ES Inspirada en las tradicionales y algo opulentas formas de las lujosas piezas Decó, Cleo conserva todo el espíritu y esencia del lujo, contenido en unas formas más contemporáneas y racionales.

EN Inspired by the traditional and somewhat opulent forms of luxurious Deco pieces, Cleo retains all the spirit and essence of luxury, contained in more contemporary and rational forms.



Cleo 147 sofa: Tejido Madeira Cement. Madera color natural.

Cleo 147 sofa: Fabric Madeira Cement. Wood in natural color.



Cleo 147 Sofá

Dos plazas. Asiento y respaldo acolchados sobre armazón de madera. Patas de madera de haya (con o sin zócalo) o de metal.
Two seater. Padded seat and backrest over wood frame. Beech wood legs (with or without plinth) or metal.

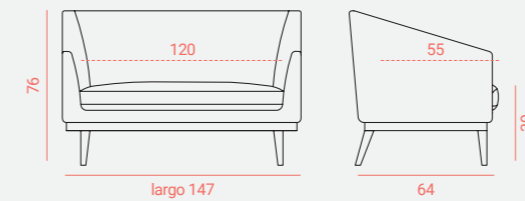

Cleo 187 Sofá

Tres plazas. Asiento y respaldo acolchados sobre armazón de madera. Patas de madera de haya (con o sin zócalo) o de metal.
Three seater. Padded seat and backrest over wood frame. Beech wood legs (with or without plinth) or metal.

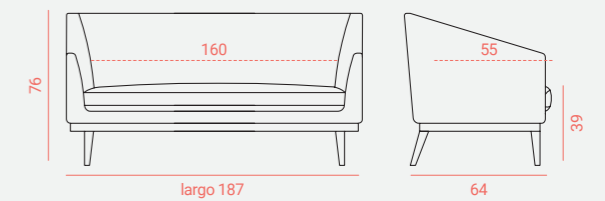

Cleo 87 Butaca

Una plaza. Asiento y respaldo acolchados sobre armazón de madera. Patas de madera de haya (con o sin zócalo) o de metal.
One seater. Padded seat and backrest over wood frame. Beech wood legs (with or without plinth) or metal.

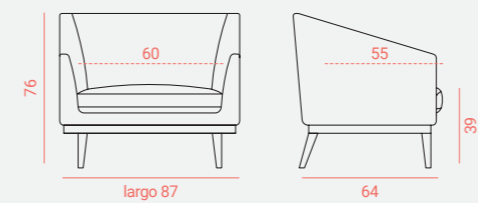

Cleo Puf

Asiento acolchado sobre armazón de madera. Patas de madera de haya (con o sin zócalo) o de metal.
Padded seat over wood frame. Beech wood legs (with or without plinth) or metal.

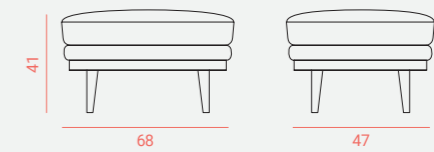

Nervio

DESIGN ENRIQUE MARTÍ ASSOCIATES



Nervio mesa: 200x100cm. Madera color natural.

Nervio table: 200x100cm. Wood in natural color.



ES Nervio tiene proporciones muy esbeltas y un trabajo geométrico de la madera distintivo. Se caracteriza por unas líneas simples, limpias y modernas. Su aspecto noble y cálido harán de tu espacio un lugar agradable.

EN Nervio has very slender proportions and a distinctive geometric woodwork. The Nervio table is characterized by simple, clean and modern lines. Its noble and warm appearance will make your space a pleasant place.



Nervio mesa: 200x100cm. Madera color natural.
Blur GM sillón: Piel color oliva (trasera), Tejido Capture 5101 (frontal). Madera color natural.

Nervio table: 200x100cm. Wood in natural color.
Blur GM armchair: Leather in olive color (back), Fabric Capture 5101 (front). Wood in natural color.





Nervio Mesa

Estructura de madera maciza de roble. Encimera con cantos macizados, chapada en madera de roble. Longitud extensible o fija.
 Solid oak wood structure. Tabletop with solid edges, oak wood veneered. Extendable or fixed length.

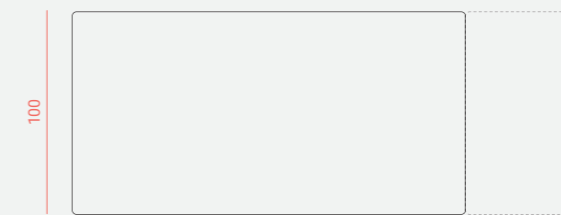
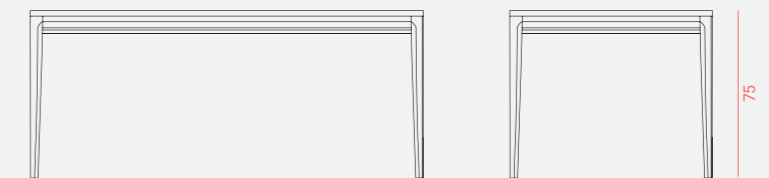

160 x 100	160 x 100 + ext. 50
180 x 100	180 x 100 + ext. 50
200 x 100	200 x 100 + ext. 50

Radar

DESIGN ENRIQUE MARTÍ ASSOCIATES



Radar mesa: Ø140cm. Porcelánico Fokos Grafite. Madera color nogal. Metal texturizado color negro.

Radar table: Ø140cm. Porcelain Fokos Grafite. Wood in walnut color. Metal in textured black color.



ES De líneas rectas y suaves, Radar se caracteriza por su robustez e imponente presencia, elevando la categoría de tu espacio a otro nivel.

EN With straight and smooth lines, Radar is characterized by its robustness and imposing presence, elevating your space to another level.



Radar mesa: Ø140cm. Porcelánico Fokos Sale. Madera color nogal. Metal texturizado color negro.
Pure silla y sillón: Madera color nogal.

Radar table: Ø140cm. Porcelain Fokos Sale. Wood in walnut color. Metal in textured black color.
Pure chair and armchair: Wood in walnut color.



0120 Radar mesa: 250x120cm. Madera color natural. Metal texturizado color negro.
Pelikan GA silla: Tejido Madeira Cement. Metal color negro.

DOOS COLLECTION **ÍNDICE / INDEX** RADAR

Radar table: 250x120cm. Wood in natural color. Metal in textured black color.
Pelikan GA chair: Fabric Madeira Cement. Metal in black color.

0121



Radar Mesa

Encimera redonda con una columna cónica, o encimera oval con dos columnas cónicas. Columna de contrachapado de madera de roble. Base de acero. Encimera chapada en madera de roble o de porcelánico de 12mm.
 Round tabletop with one conical column, or oval tabletop with two conical columns. Oak plywood column. Steel base. Oak wood veneered or 12mm porcelain tabletop.

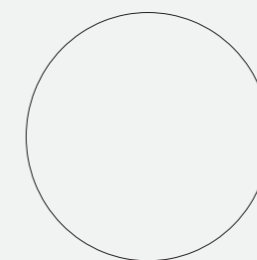
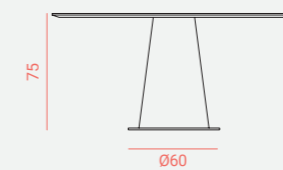

Radar Mesa Redonda
 Ø120
 Ø130
 Ø140

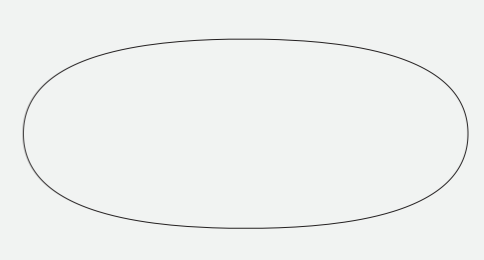
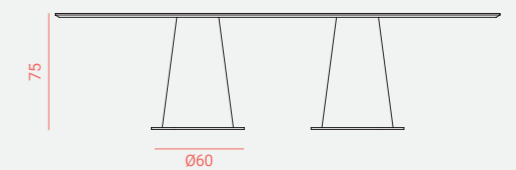

Radar Mesa Oval
 180x110
 200x120
 250x120

Radar mesa: Ø140cm. Porcelánico Fokos Piombo.
 Pure silla y sillón: Madera color nogal.

Radar table: Ø140cm. Porcelain Fokos Piombo.
 Pure chair and armchair: Wood in walnut color.

Radar mesa: 250x120cm. Madera color natural. Metal texturizado color negro.
 Bandeja Giratoria: Porcelánico Fokos Grafite.

Radar table: 250x120cm. Wood in natural color. Metal in textured black color.
 Lazy Susan: Porcelain Fokos Grafite.

Panorama

DESIGN ENRIQUE MARTÍ ASSOCIATES



Panorama mesa: 220x100cm. Cristal transparente. Madera color nogal.

Panorama table: 220x100cm. Transparent glass. Wood in walnut color.



ES Con sus patas de madera natural como firmes columnas y el sobre de vidrio que se sostiene en el aire, la mesa Panorama es una mezcla de robustez y ligereza.

EN With its natural wood legs like strong columns and the glass top that hangs in the air, the Panorama table is a mix of robustness and lightness.



Panorama mesa: 220x100cm. Cristal transparente. Madera color nogal.
Pure silla y sillón: Madera color nogal.

Panorama table: 220x100cm. Transparent glass. Wood in walnut color.
Pure chair and armchair: Wood in walnut color.





Panorama Mesa

Encimera de cristal transparente templado de 12mm.
Patas madera maciza de roble.
12mm translucent tempered glass tabletop.
Solid oak legs.

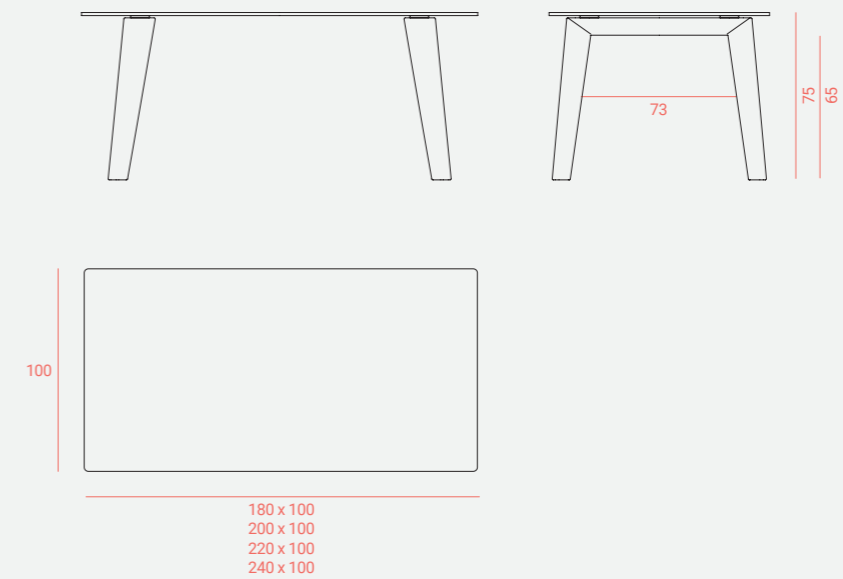

Evolve

DESIGN ENRIQUE MARTÍ ASSOCIATES



Evolve mesa: 200x100cm. Madera color natural.

Evolve table: 200x100cm. Wood in natural color.



ES Evolve es una mesa con aire retro, diseñada para comedor, oficina u otros espacios. Contrasta la suavidad que le aporta la madera de perfiles redondeados, con la solidez de encimeras de madera, porcelánicas o de cristal.

EN Evolve is a table with a retro look, designed for dining, office or other spaces. Evolve contrasts the smoothness of rounded profile wood with the solidity of wood, porcelain or glass tops.



Evolve mesa: 200x100cm. Madera color natural.
Evía GM sillón: Tejido Capture 4902. Madera color natural.
Evolve table: 200x100cm. Wood in natural color.
Evía GM armchair: Fabric Capture 4902. Wood in natural color.





Evolve Mesa

Estructura de madera maciza de fresno. Encimera chapada en madera de fresno, o de cristal transparente templado de 12mm o porcelánico de 12mm.
Solid ash wood structure. Ash wood veneered tabletop, or 12mm tempered transparent glass or 12mm porcelain.

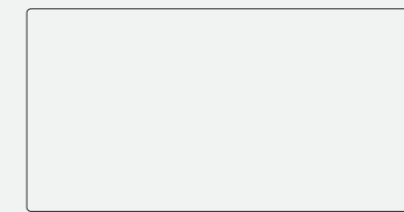
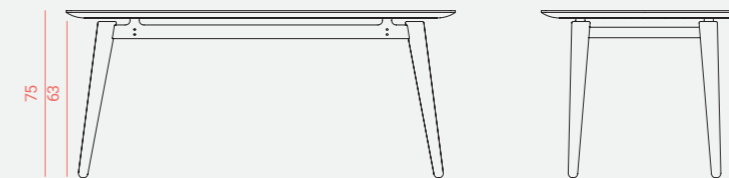

140 x 80
160 x 90
180 x 100
200 x 100
220 x 100

Ópera

DESIGN ENRIQUE MARTÍ ASSOCIATES

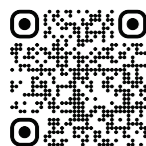

Ópera mesa: 140x90cm. Madera color natural.

Ópera table: 140x90cm. Wood in natural color.



ES Su elegante sencillez de líneas y sus proporciones equilibradas dan a Ópera una personalidad especial. Pensada para el equipamiento de salas de reuniones, grandes salones e instalaciones en general.

EN Its elegant shape simplicity and balanced proportions give Ópera a special personality. Designed for equipping meeting rooms, large halls, and professional facilities in general.



Ópera mesa: 200x100cm. Madera color natural.
Retro silla: Tejido Yoredale Burnsall. Madera color natural.

Ópera table: 200x100cm. Wood in natural color.
Retro chair: Fabric Yoredale Burnsall. Wood in natural color.



Ópera mesa: 200x100cm. Madera color natural.
Blur GA sillón: Piel Camel (trasera), Tejido Capture 3301 (frontal). Metal color negro.

Ópera table: 200x100cm. Wood in natural color.
Blur GA armchair: Leather in camel color (back), Fabric Capture 3301 (front). Metal in black color.



Ópera mesa: 140x90cm. Madera color natural.
Retro silla: Piel color negro. Madera color natural.

Ópera table: 140x90cm. Wood in natural color.
Retro chair: Leather in black color. Wood in natural color.



Ópera Mesa

Estructura de madera maciza de roble.
Encimera chapada en madera de roble.
Solid oak structure.
Oak wood veneer tabletop.

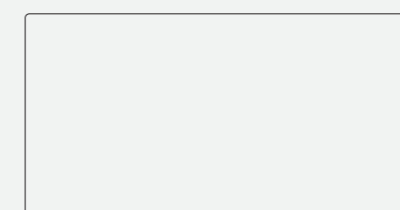

140 x 90
200 x 100
240 x 110

Ópera mesa: 240x110cm. Madera color natural.
Ópera mesa: 100x100cm. Madera color natural.

Ópera table: 240x110cm. Wood in natural color.
Ópera table: 100x100cm. Wood in natural color.

Aliena

DESIGN ENRIQUE MARTÍ ASSOCIATES



Aliena mesa: 180x90cm. Porcelánico Fokos Grafite. Metal texturizado color negro.

Aliena table: 180x90cm. Porcelain Fokos Grafite. Metal in textured black color.



ES Aliena es la respuesta a las necesidades de resistencia y durabilidad más exigentes junto con el gusto por las líneas más depuradas, sutiles y minimales.

EN Aliena is the answer to the most demanding resistance and durability needs along with the taste for the most refined, subtle, and minimal lines.



Aliena mesa: 180x100cm. Madera color nogal. Metal texturizado color negro.
Pure silla: Tejido Madeira White. Madera color nogal.

Aliena table: 180x100cm. Wood in walnut color. Metal in textured black color.
Pure chair: Fabric Madeira White. Wood in walnut color.



Aliena mesa: 180x100cm. Cristal color blanco. Metal texturizado color óxido.
Evia PZ sillón: Tejido Sumi Muso. Metal texturizado color óxido.

Aliena table: 180x100cm. Glass in white color. Metal in textured oxide color.
Evia PZ armchair: Fabric Sumi Muso. Metal in textured oxide color.



Aliena Mesa

Encimera de cristal opaco de 12mm o en porcelánico de 12mm, o chapada en madera de roble o nogal. Patas de acero. Longitud extensible o fija.
 Aliena table: Tabletop made of 12mm opaque glass, 12mm porcelain, or veneered in oak or walnut wood. Steel legs. Extendable or fixed length.

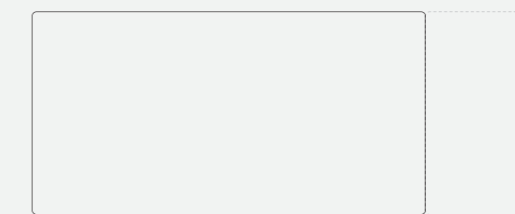

140 x 90	140 x 90 + ext. 60
160 x 90	160 x 90 + ext. 60
180 x 90	180 x 90 + ext. 60
140 x 100	140 x 100 + ext. 60
160 x 100	160 x 100 + ext. 60
180 x 100	180 x 100 + ext. 60

Aliena mesa: 180x90cm. Madera color RAL 9010. Metal texturizado color negro.
 Zeta sillón: Tejido Main Line Twist Slub. Metal texturizado color negro.

Aliena table: 180x90cm. Wood in RAL 9010 color. Metal in textured black color.
 Zeta armchair: Fabric Main Line Twist Slub. Metal in textured black color.

Aliena mesa: 180x90cm. Porcelánico Fokos Grafite. Metal texturizado color negro.

Aliena table: 180x90cm. Porcelain Fokos Grafite. Metal in textured black color.

Goltay

DESIGN STUDIO DOOS



Goltay mesa: 140x90cm. Madera color natural.

Goltay table: 140x90cm. Wood in natural color.



ES La mesa Goltay destaca por su elegante sencillez, de líneas minimalistas y proporciones equilibradas. Se adapta a múltiples necesidades de amueblamiento de salones y otros espacios.

EN Goltay table stands out for its elegant simplicity, minimalist lines and balanced proportions. Goltay adapts to multiple needs of living-room equipment as well as other spaces.



Goltay mesa: 160x90cm. Madera color natural.
Pelikan PH sillón: Tejido Madeira White.

Goltay table: 160x90cm. Wood in natural color.
Pelikan PH armchair: Fabric Madeira White.





Goltay Mesa

Chapa de madera de roble o nogal. Encimera en chapa de madera, cristal opaco de 12mm, o porcelánico de 12mm. Longitud extensible o fija.
 Oak or walnut wood veneer. Tabletop in wood veneer, 12mm opaque glass or 12mm porcelain. Extendable or fixed length.

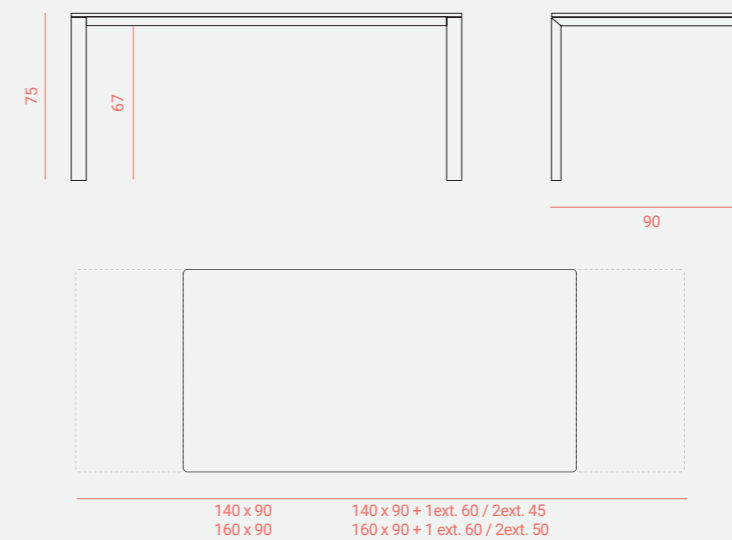

Londres

DESIGN ENRIQUE MARTÍ ASSOCIATES



Londres mesa: Ø105cm. Madera color natural.

Londres table: Ø105cm. Wood in natural color.



ES Suave y orgánica, Londres se suma a la tendencia de interpretar los materiales según su naturaleza. Sus patas se contraponen entre igualdad y asimetría, con un atractivo juego de volúmenes, luces y sombras.

EN Soft and organic, Londres joins the trend of interpreting materials according to their nature. Its legs create a contrast between symmetry and asymmetry, with an attractive game of volumes, lights, and shadows.



Londres mesa: Ø120cm. Madera color natural.
Evia MR sillón: Tejido Bristol Ash. Madera color natural.

Londres table: Ø120cm. Wood in natural color.
Evia MR armchair: Fabric Bristol Ash. Wood in natural color.



Londres Mesa

Estructura de madera maciza de roble. Encimera chapada en madera de roble. Longitud extensible o fija.
 Solid oak wood structure. Oak wood veneer tabletop.
 Extendable or fixed length.

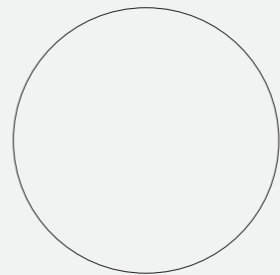
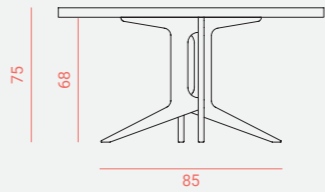

Ø105 Ø105 + ext.50
 Ø120 Ø120 + ext.50

Londres mesa: Ø120cm. Madera color natural.
 Retro silla: Tejido Main Line Flax Stratford. Madera color natural.
 Londres table: Ø120cm. Wood in natural color.
 Retro chair: Fabric Main Line Flax Stratford. Wood in natural color.

Global

DESIGN ENRIQUE MARTÍ ASSOCIATES



Global mesa: 180x100cm. Madera color natural.

Global table: 180x100cm. Wood in natural color.



ES Global está concebida para armonizar una base contundente, de patas anchas, con una encimera muy ligera. Es eminentemente funcional, pero también dignifica cualquier estancia con su estética minimalista, calculada y contenida.

EN Global is designed to harmonize a strong wide-legged base with a very light top. Functional, but also dignifies any room with its minimalist, calculated and contained aesthetic.



Global mesa: 200x100cm. Madera color natural.
Evia MF sillón: Tejido Main Line Flax Whitechapel. Madera color natural.

Global table: 200x100cm. Wood in natural color.
Evia MF armchair: Fabric Main Line Flax Whitechapel. Wood in natural color.





Global Mesa

Chapa de madera de roble o nogal. Encimera en chapa de madera, cristal opaco de 12mm, o porcelánico de 12mm. Longitud extensible o fija.
 Oak or walnut wood veneer. Tabletop in wood veneer, 12mm opaque glass or 12mm porcelain. Extendable or fixed length.

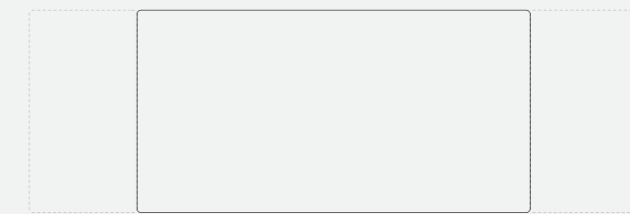

140 x 90	140x90 + 1 ext.60 / 2 ext.45
160x90	160x90 + 1 ext.60 / 2 ext.50
160x100	160x100 + 1 ext.60 / 2 ext.50
180x90	180x90 + 1 ext.60 / 2 ext.50
180x100	180x100 + 1 ext.60 / 2 ext.50
200x100	200x100 + 1 ext.60 / + 2 ext.50

Grace

DESIGN STUDIO DOOS



ES Grace está pensada para adoptar diámetros especiales conservando su estética inicial. Grace puede tener cuatro o tres patas, para obtener una imagen más inusual.

EN Grace is designed to adopt special diameters while preserving its initial aesthetics. Grace can have four or three legs, for a more unusual image.

Grace mesa, cuatro patas: Ø120cm. Madera color natural y teñida color negro.
Blur MR sillón: Tejido Synergy Summon. Madera en color natural.

Grace table, four legs: Ø120cm. Wood in natural color and black dye color.
Blur MR armchair: Fabric Synergy Summon. Wood in natural color.



Grace mesa, cuatro patas: Ø120cm. Madera color natural y teñida color negro.
Grace table, four legs: Ø120cm. Wood in natural color and black dye color.



Grace Mesa
Madera maciza de roble. Encimera chapada en
madera de roble.
Solid oak wood. Oak wood veneer tabletop.

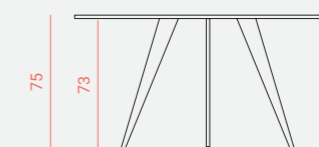

Medida inferior según medida superior.

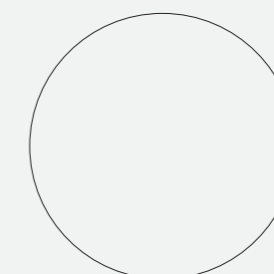

3 patas / 4 patas
Ø105
Ø120
Medida especial: Ø90 - Ø140

Grace mesa, tres patas: Ø105cm. Madera color natural.
Grace mesa, cuatro patas: Ø120cm. Madera color natural y teñida color negro.

Grace table, three legs: Ø105cm. Wood in natural color.
Grace table, four legs: Ø120cm. Wood in natural color and black dye color.

Celine

DESIGN ENRIQUE MARTÍ ASSOCIATES



Celine mesa: Ø105cm. Madera color nogal.

Celine table: Ø105cm. Wood in walnut color.



ES Celine integra la función extensible a la armónica organización espacial de las mesas circulares. Su orientación práctica se complementa con un trabajo noble de la madera de roble sólida.

EN Celine integrates the extendable function into the harmonious spatial organization of the circular tables. Its practical orientation is complemented by a noble workmanship of solid oak wood.



Celine mesa: Ø120cm. Madera color natural.

Karen MR silla: Madera en color natural.

Karen MF silla: Madera en color RAL 2012 (naranja).

Celine table: Ø120cm. Wood in natural color.

Karen MR chair: Wood in natural color.

Karen MF chair: Wood in RAL 2012 color (orange).



Celine Mesa

Madera maciza de roble. Encimera chapada en madera de roble. Longitud extensible o fija.
Solid oak wood. Oak wood veneer tabletop. Extendable or fixed length.

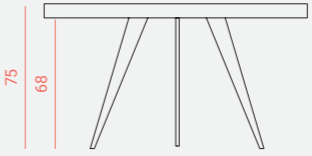

Medida inferior según medida superior.

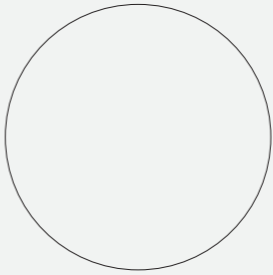

Ø105 Ø105 + ext.50
Ø120 Ø120 + ext.50

Celine mesa: Ø120cm. Madera color natural.
Karen MR silla: Madera en color RAL 6034 (turquesa).
Karen MF silla: Madera en color natural y RAL 2012 (naranja).
Celine table: Ø120cm. Wood in natural color.
Karen MR chair: Wood in RAL 6034 color (turquoise).
Karen MF chair: Wood in natural color and RAL 2012 color (orange).

Celine mesa: Ø105cm. Madera color nogal.
Celine table: Ø105cm. Wood in walnut color.

Copa

DESIGN STUDIO DOOS



ES Copa optimiza el uso del espacio, con sencillez y funcionalidad, en torno a su columna central. Muy versátil, Copa ofrece amplias opciones de personalización en tamaños, materiales y acabados.

EN Copa optimizes the use of space, with simplicity and functionality, around its central column. Very versatile, Copa offers wide customization options in sizes, materials and finishes.

Copa mesa: Ø120 cm. Porcelánico Fokos Sale. Metal texturizado color negro.
Evia PH sillón: Tejido Liverpool Ash. Metal texturizado color negro.

Copa table: Ø120 cm. Porcelain Fokos Sale. Metal in textured black color.
Evia PH armchair: Fabric Liverpool Ash. Metal in textured black color.



Copa mesa: Ø120 cm. HPL color Henna. Metal color RAL 8002.
 Blur sillón: Tejido Liverpool Beige. Metal color RAL 8002.

Copa table: Ø120 cm. HPL in Henna color. Metal in RAL 8002 color.
 Blur armchair: Fabric Liverpool Beige. Metal in RAL 8002 color.



Copa Mesa

Pie central de acero inoxidable o acero color epoxy. Tablero de 20mm chapado en madera de roble, cristal de 10mm transparente u opaco, o porcelánico de 12mm. Medidas del pie central en función del diámetro de la encimera.

Central foot made of stainless steel or epoxy-colored steel. 20mm oak wood veneered board, 10mm transparent or opaque glass, or 12mm porcelain. Central foot measurements based on the tabletop diameter.

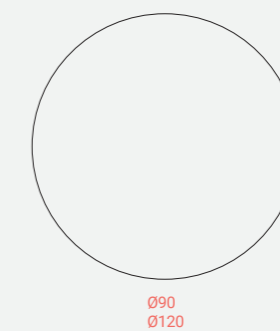
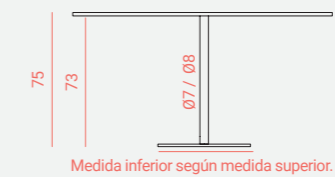

Copa mesa: Ø120 cm. Madera color natural. Metal color RAL 9010.
 Copa mesa: Ø120 cm. HPL color Henna. Metal color RAL 9010.

Copa table: Ø120 cm. Wood in natural color. Metal in RAL 9010 color.
 Copa table: Ø120 cm. HPL in Henna color. Metal in RAL 9010 color.

Pluma

DESIGN ENRIQUE MARTÍ ASSOCIATES



ES Pluma es una colección de mesas de pie central, con variación en altura y en forma de encimera. Especialmente óptima para entornos comerciales por su versatilidad y ligereza, su funcionalidad la hace idónea también en usos domésticos.

EN Pluma is a collection of one central leg tables, with variations in height and tabletop shape. Especially optimal for commercial environments due to its versatility and lightness, its functionality also makes it ideal for domestic use.



Pluma mesa: 80x80cm y Ø90cm. HPL color Green Slate. Metal color RAL 9001.
Cala silla: Madera en color nogal.

Pluma table: 80x80cm and Ø90cm. HPL in Green Slate color. Metal in RAL 9001 color.
Cala chair: Wood in walnut color.



Pluma mesa: 80x80cm. HPL color Denim. Metal color RAL 9001.
Dalia MR silla: Madera color natural.

Pluma table: 80x80cm. HPL in Denim color. Metal in RAL 9001 color.
Dalia MR chair: Wood in natural color.



Pluma Mesa

Pie central de acero inoxidable o acero color epoxi. Tablero de 20mm chapado en madera de roble, cristal de 10mm transparente u opaco, o porcelánico de 12mm. Medidas del pie central en función del diámetro de la encimera.

Central foot made of stainless steel or epoxy-colored steel. 20mm oak wood veneered board, 10mm transparent or opaque glass, or 12mm porcelain. Central foot measurements based on the tabletop diameter.

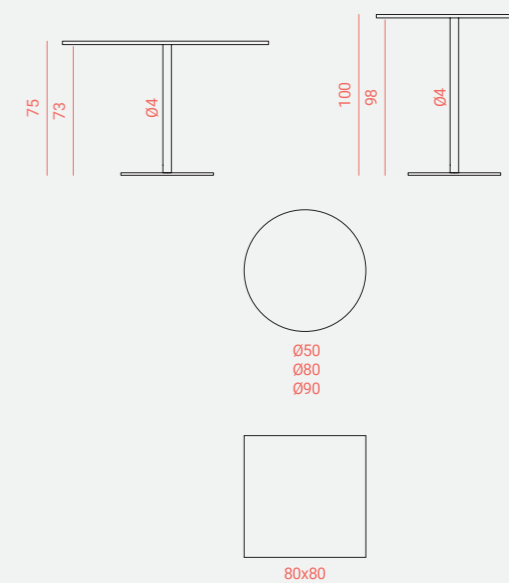

Pluma mesa: 80x80cm. HPL color Night Sea. Metal color RAL 5008.
Pluma mesa: Ø50cm. HPL color Algae. Metal color RAL 6025.

Pluma table: 80x80cm. HPL in Night Sea color. Metal in RAL 5008 color.
Pluma table: Ø50cm. HPL in Algae color. Metal in RAL 6025 color.

Cortés

DESIGN ACHODOSO



Cortés mesa: Altura 35cm. Madera color natural. Metal color RAL 3009.

Cortés table: Height 35cm. Wood in natural color. Metal in RAL 3009 color.



ES Las mesas auxiliares Cortés muestran un juego de volúmenes geométricos elementales, con un contraste muy fresco entre notas tradicionales e industriales.

EN Cortés auxiliary tables focus on a game of elemental geometric volumes, with a very fresh contrast between traditional notes and industrial ones.



Cortés mesa: Altura 45cm. Madera color natural. Metal color RAL 5001.
Amable butaca giratoria: Tejido Synergy Kinship. Madera color natural.

Cortés table: Height 45cm. Wood in natural color. Metal in RAL 5001 color.
Amable swivel armchair: Fabric Synergy Kinship. Wood in natural color.



Cortés Mesas

Encimera y columna en madera maciza de fresno.

Base de acero.

Tabletop and column in solid ash wood.

Steel base.

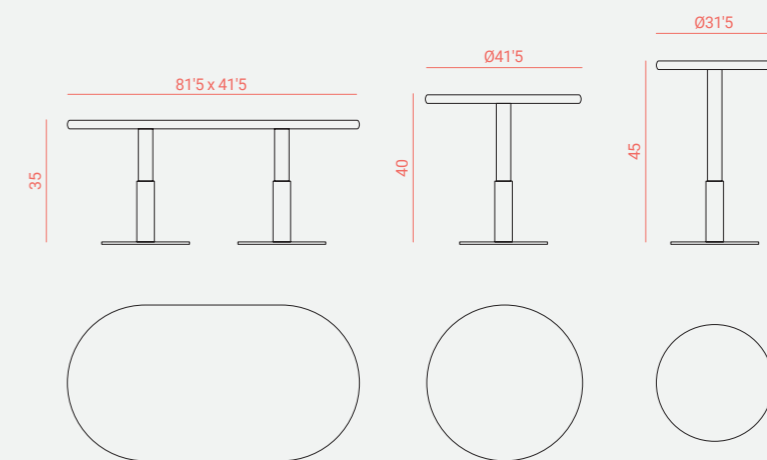

Cortés mesa: Altura 45cm. Madera color natural. Metal color RAL 5001.
Amable butaca giratoria: Tejido Synergy Collaborate. Madera color natural.

Cortés table: Height 45cm. Wood in natural color. Metal in RAL 5001 color.
Amable swivel armchair: Fabric Synergy Collaborate. Wood in natural color..

Cortés mesas: Alturas 45cm, 40cm, 35cm. Madera color natural. Metal color RAL 6010.

Cortés table: Height 45cm, 40cm, 35cm. Wood in natural color. Metal in RAL 6010 color.

Yoko & John

DESIGN ENRIQUE MARTÍ ASSOCIATES



John mesa: Ø60cm. Porcelánico Fokos Sale. Metal texturizado color negro.

John table: Ø60cm. Porcelain Fokos Sale. Metal in textured black color.



ES De aspecto limpio, robusto y compacto, Yoko & John se pueden usar en conjunto o por separado. Juntas crean un juego complementario en alturas, formas y acabados, que es único cada vez.

EN Clean looking, robust and compact, Yoko & John can be used together or separately. In partnership they create a complementary game in heights, shapes and finishes, which is unique each time.



Yoko mesa: 110x60cm. Porcelánico Fokos Grafite. Metal texturizado color negro.
King butaca giratoria: Tejido Main Line Flax Epping. Madera color natural.

Yoko table: 110x60cm. Porcelain Fokos Grafite. Metal in textured black color.
King swivel armchair: Fabric Main Line Flax Epping. Wood in natural color.



John mesa: Madera color natural. Metal color negro texturizado.
 Blur Lounge sillón: Tapizado Madeira White. Madera color nogal.

John table: Wood in natural color. Metal in textured black color.
 Blur Lounge armchair: Fabric Madeira White. Wood in walnut color.

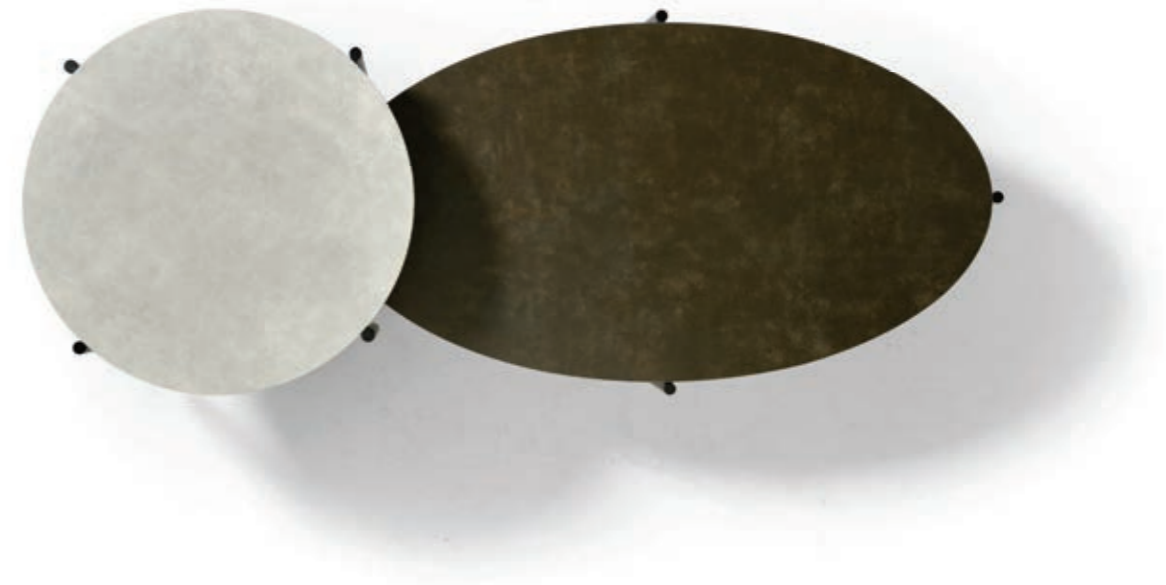

Yoko & John Mesas

Base de tubo metálico de 14mm.
 Encimera chapada en madera de roble, de cristal opaco o de porcelánico de 12mm.
 Base made of 14mm metal tube.
 Tabletop veneered in oak wood, opaque glass or 12mm porcelain.

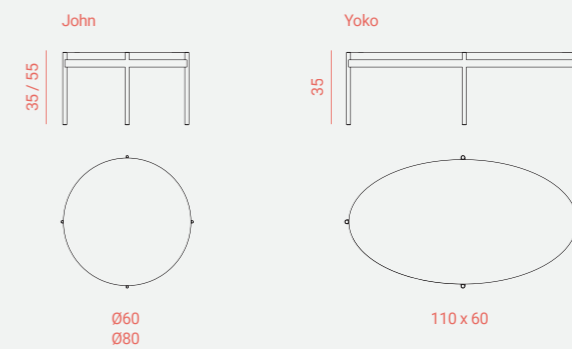

Ginger & Fred

DESIGN ENRIQUE MARTÍ ASSOCIATES



Fred mesa: Ø60cm. Madera color RAL 9010. Metal cromado.

Fred table: Ø60cm. Wood in RAL 9010 color. Chromed metal.



ES Ginger & Fred están creadas para adoptar múltiples posiciones y funcionar juntas o por separado. Pueden desempeñar distintos usos y por eso están provistas de varias alturas y materiales posibles.

EN Ginger & Fred are created to adopt multiple positions and work together or separately. They can have different uses and that is why they are provided with various heights and possible materials.



Ginger mesa: 110x60cm. Porcelánico Fokos Grafite. Metal texturizado color negro.

Ginger table: 110x60cm. Porcelain Fokos Grafite. Metal in textured black color.

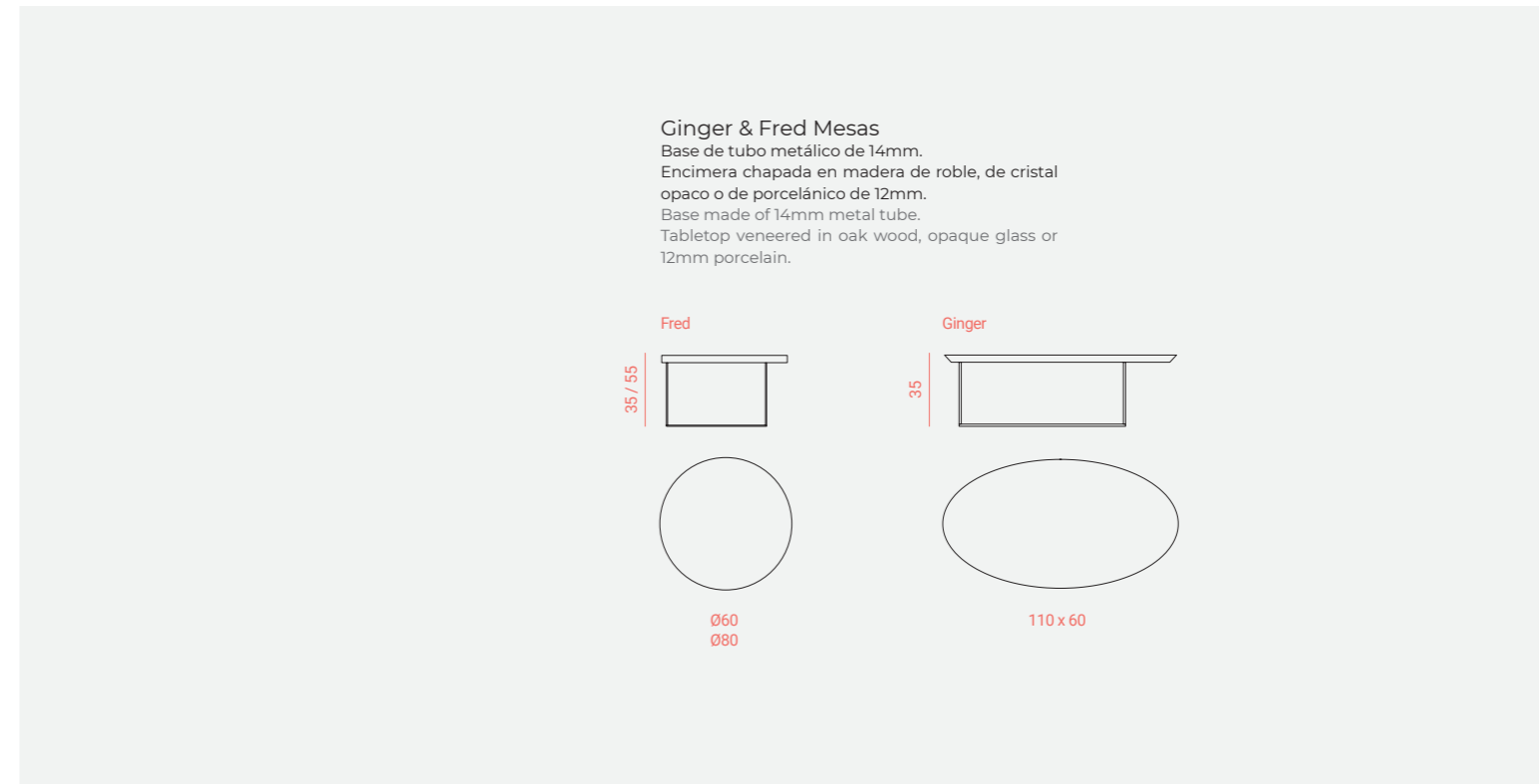

Fred mesa: Ø60cm. Madera color RAL 9010. Metal cromado.
 Ginger mesa: 110x60cm. Madera color natural. Metal cromado.
 Ginger mesa: 110x60cm. Porcelánico Fokos Sale. Metal texturizado color negro.
 Fred table: Ø60cm. Wood in RAL 9010 color. Chromed metal.
 Ginger table: 110x60cm. Wood in natural color. Chromed metal.
 Ginger table: 110x60cm. Porcelain Fokos Sale. Metal in textured black color.

Ginger & Fred mesas: Porcelánico Fokos Grafite. Metal texturizado color negro.
 Ginger & Fred tables: Porcelain Fokos Grafite. Metal in textured black color.

Nuestro producto cumple con las especificaciones y requisitos de la norma de aplicación:

- **UNE-EN 16139:2013** para usos intensivos.
- **STANDARD 100 by OEKO-TEX®**: Garantiza que las telas no contienen productos nocivos.

Our product complies with the specifications and requirements of the application standard

- **UNE-EN 16139: 2013** for intensive uses.
- **STANDARD 100 by OEKO-TEX®**: Guarantees that the fabrics do not contain harmful products.

CETEM

Producto desarrollado en colaboración con CETEM.

Product developed in collaboration with CETEM.



UNIÓN EUROPEA

Fondo Europeo de Desarrollo Regional (FEDER).

Una manera de hacer Europa.

FINANCIADA POR:



MINISTERIO
DE INDUSTRIA,
COMERCIO Y
TURISMO

• DOOS

ART DIRECTION: Enrique Martí Associates

DESIGN AND LAYOUT: Enrique Martí Associates

PHOTOGRAPHS: Marcelo Martínez

PRINT: LOGIK GRAPHICS

www.doosdesign.es

KOKER MOBILIARIO SL
C/ Miguel Servet 29, Pol Ind. Las Teresas, 30510 Yecla, Murcia.
T. (+34) 968 752 872 comercial@kdoos.es

