



# MERTAY MAKINA

 | +90 224 441 96 56

 | [www.mertaymakina.com](http://www.mertaymakina.com)

 | [info@mertaymakina.com](mailto:info@mertaymakina.com)

# Hakkımızda



2007

Kuruluş

50+

Uzman Çalışan

2.500 m<sup>2</sup>

Üretim Tesisi

16

Ülke Ortağı



# Makine Parkuru

<b>Makineler</b>	<b>Adet</b>	<b>Makineler</b>	<b>Adet</b>
<b>5-Eksen CNC Freze</b>	<b>3</b>	<b>Universal Torna</b>	<b>1</b>
<b>3-Eksen CNC Freze</b>	<b>3</b>	<b>Dikey Freze</b>	<b>1</b>
<b>3D CMM Ölçüm Makinesi</b>	<b>1</b>	<b>PVD Kaplama Cihazı</b>	<b>1</b>
<b>SLS Endüstriyel 3D Yazıcı</b>	<b>1</b>	<b>Giyotin Makan</b>	<b>1</b>
<b>2kW Lazer Kaynak Makinesi</b>	<b>1</b>	<b>Kumlama Makinesi</b>	<b>1</b>
<b>TIG/MIG Kaynak Makinesi</b>	<b>6</b>	<b>Profil Kesim Makinesi</b>	<b>1</b>
<b>Lazer Kesim Makinesi 20 kW</b>	<b>1</b>	<b>Lazer Markalama (UV/Fiber)</b>	<b>2</b>

# MAKİNA PARKURUMUZ



# MAKİNA PARKURUMUZ

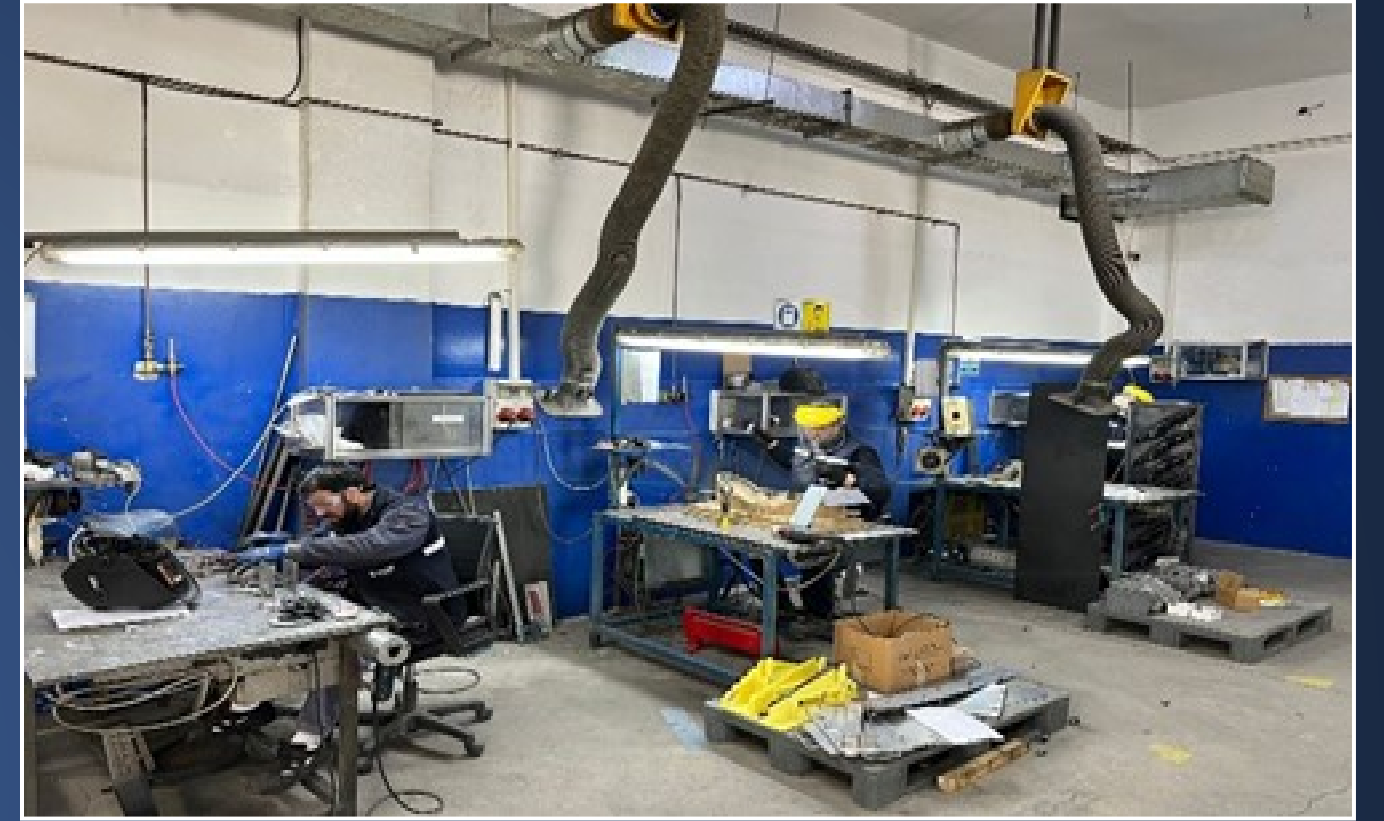

# SERTİFİKALARIMIZ



## CERTIFICATE

MERTAY METAL SAÇ MAKİNA GIDA TEKSTİL  
TURİZM OTOMOTİV SANAYİ VE TİCARET  
LİMİTED ŞİRKETİ

FETHİYE OSB MAH. PEMBE CAD. NO:9  
NİLÜFER / BURSA / TÜRKİYE

*Has been assessed and found to Comply with the Requirements of:  
Denetlenmiş ve aşağıdaki standardın gerekliliklerine uygunluğu görülmüştür:*

**ISO 9001:2015**

*The Quality Management System is applicable to:  
Kalite Yönetim Sistemi:*

MANUFACTURING OF AUTOMOTIVE ASSEMBLY LINES, CNC MACHINED PARTS, JIGS  
FIXTURES AND TOOLS, CONVEYORS, SHEET METAL FORMING, VACUUM METALLIZATION  
RACKS, AEROSPACE SECTOR PARTS, FORMING OF METAL

OTOMOTİV MONTAJ HATLARININ, CNC PARÇALARININ, APARATLARIN, FİKSTÜRLERİN,  
KONVEYÖRLERİN, METAL KAPLAMA PLANETLERİNİN, HAVACILIK SEKTÖRÜNE YÖNELİK  
METAL PARÇALARININ İMALATI, METALLERİN ŞEKİLLENDİRİLMESİ

Certificate Number: QMS-10464  
Belge Numarası: QMS-10464

Initial Certification Date: 07.07.2023  
İlk Belgelendirme Tarihi: 07.07.2023

Certification Period: 3 Years  
Belgelendirme Periyodu: 3 Yıl

Certificate Validity Date: 06.07.2025  
Belge Geçerlilik Tarihi: 06.07.2025



*QMS*

IQR Sertifikasyon Onayı

IQR ULUSLARARASI BELGELENDİRME HİZMETLERİ LTD.ŞTİ.  
Beşevler Mah. Kocayunus Sk. No:3 Arslan Han Plaza K:2 Nilüfer / BURSA  
Tel.: +90.224.266 00 16 Faks: +90.224.249 41 13 www.iqrcert.com e-posta: info@iqrcert.com



## CERTIFICATE

MERTAY METAL SAÇ MAKİNA GIDA TEKSTİL  
TURİZM OTOMOTİV SANAYİ VE TİCARET  
LİMİTED ŞİRKETİ

FETHİYE OSB MAH. PEMBE CAD. NO:9  
NİLÜFER / BURSA / TÜRKİYE

*Has been assessed and found to comply with the requirements of:  
Denetlenmiş ve aşağıdaki standardın gerekliliklerine uygunluğu görülmüştür:*

**ISO 14001:2015**

*The Environmental Management System is applicable to:  
Çevre Yönetim Sistemi:*

MANUFACTURING OF AUTOMOTIVE ASSEMBLY LINES, CNC MACHINED PARTS, JIGS  
FIXTURES AND TOOLS, CONVEYORS, SHEET METAL FORMING, VACUUM METALLIZATION  
RACKS, AEROSPACE SECTOR PARTS, MACHINES, FORMING OF METALS

OTOMOTİV MONTAJ HATLARININ, CNC PARÇALARININ, APARATLARIN, FİKSTÜRLERİN,  
KONVEYÖRLERİN, METAL KAPLAMA PLANETLERİNİN, HAVACILIK SEKTÖRÜNE YÖNELİK  
METAL PARÇALARIN, MAKİNELERİN İMALATI, METALLERİN ŞEKİLLENDİRİLMESİ

Certificate Number: EMS-004082  
Belge Numarası: EMS-004082

Initial Certification Date: 30.11.2024  
İlk Belgelendirme Tarihi: 30.11.2024

Certification Period: 3 Years  
Belgelendirme Periyodu: 3 Yıl

Certificate Validity Date: 29.11.2025  
Belge Geçerlilik Tarihi: 29.11.2025



*QMS*

IQR Sertifikasyon Onayı

IQR ULUSLARARASI BELGELENDİRME HİZMETLERİ LTD.ŞTİ.  
Beşevler Mah. Kocayunus Sk. No:3 Arslan Han Plaza K:2 Nilüfer / BURSA  
Tel.: +90.224.266 00 16 Faks: +90.224.249 41 13 www.iqrcert.com e-posta: info@iqrcert.com



## CERTIFICATE

MERTAY METAL SAÇ MAKİNA GIDA TEKSTİL  
TURİZM OTOMOTİV SANAYİ VE TİCARET  
LİMİTED ŞİRKETİ

FETHİYE OSB MAH. PEMBE CAD. NO:9  
NİLÜFER / BURSA / TÜRKİYE

*Has been assessed and found to Comply with the Requirements of:  
Denetlenmiş ve aşağıdaki standardın gerekliliklerine uygunluğu görülmüştür:*

**ISO 45001:2018**

*The Occupational Health and Safety Management System is applicable to:  
İş Sağlığı Ve Güvenliği Yönetim Sistemi:*

MANUFACTURING AND SALES OF MACHINERY AND SPARE PARTS

MAKİNA VE YEDEK PARÇALARININ İMALATI VE SATIŞI

Certificate Number: 2022/OHSMS/00111754  
Belge Numarası: 2022/OHSMS/00111754

Initial Certification Date: 26.10.2022  
İlk Belgelendirme Tarihi: 26.10.2022

Certification Period: 3 Years  
Belgelendirme Periyodu: 3 Yıl

Certificate Validity Date: 25.10.2024  
Belge Geçerlilik Tarihi: 25.10.2024



*QMS*

IQR Sertifikasyon Onayı

IQR ULUSLARARASI BELGELENDİRME HİZMETLERİ LTD.ŞTİ.  
Beşevler Mah. Kocayunus Sk. No:3 Arslan Han Plaza K:2 Nilüfer / BURSA  
Tel.: +90.224.266 00 16 Faks: +90.224.249 41 13 www.iqrcert.com e-posta: info@iqrcert.com

# TASARIM PROGRAMLARIMIZ

- 10 SOLIDWORKS CAD
- 1 SOLIDWORKS CAM
- 2 CATIAV5 CAD
- 1 CATIAV5CAM
- 1 Visi CAD/CAM
- 1 MasterCAM CAM
- 1 SINTRATEC Nesting

 **SOLIDWORKS**

VISI BY  **HEXAGON**

 **AUTODESK<sup>®</sup>  
INVENTOR<sup>®</sup>**

 **CATIA**

 **Mastercam<sup>®</sup>**



# KABİLİYETLERİMİZ



1. CNC talaşlı imalat ve kaynaklı çelik konstrüksiyon
2. Bariyer, platform, merdiven ve iş güvenliği ekipmanları
3. İş masaları, dolaplar, talaş kasaları ve taşıma arabaları
4. Vinç sistemleri, konveyörler ve malzeme taşıma çözümleri
5. Özel makine, fikstür, aparat ve proses destek ekipmanları
6. PLC kontrollü istasyonlar, otomasyon ve yazılım geliştirme
7. Robotik uygulamalar, ölçüm ve kalite kontrol sistemleri
8. Montaj hatları, saha montajı ve endüstriyel entegrasyon

# YETKİNLİKLERİMİZ

**Özel Makine İmalatı**

**CNC Talaşlı İmalat ve  
Hassas İşleme**

**Kaynaklı İmalat ve  
Çelik Konstrüksiyon**

**Makine ve  
Konveyör Sistemi  
Entegrasyonu**

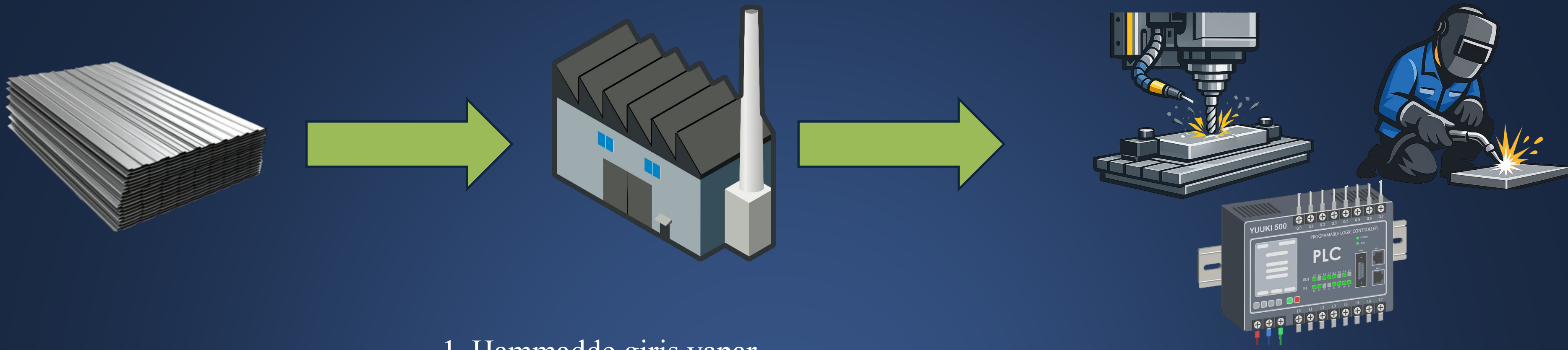

1. Hammadde giriş yapar
2. Üretim süreci
3. Kalite kontrol
4. Tamamlanan ürün fabrikadan sevk edilir
5. Ürünler iş ortağımıza ulaşır

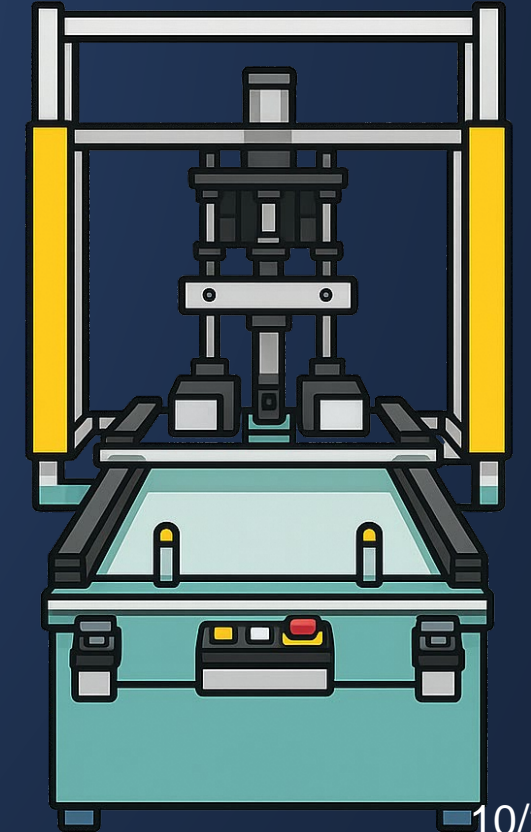
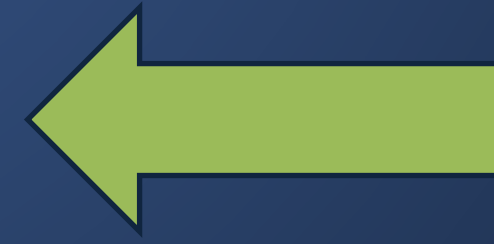

# Özel Makine ve Anahtar Teslim Sistemler



Üretim ihtiyaçlarına özel olarak tasarlanmış makineler ve sistemler geliştiriyoruz.

Tasarım aşamasından devreye almaya kadar tüm süreci kendi bünyemizde yönetiyoruz.

Mekanik, elektrik ve otomasyon kabiliyetlerimizi birleştirerek, doğrudan üretime hazır anahtar teslim çözümler sunuyoruz.

- Tam ve yarı otomatik makine sistemleri
- Mevcut üretim hatlarına entegrasyon
- Kullanıcı dostu HMI arayüzleri ve güvenlik sistemleri
- Dokümantasyon, test ve sahada kurulum

Tüm projeler şirket içinde geliştirilir; tasarım, üretim ve teslimat süreçleri tamamen kontrol altındadır.

# ROBOTLU SİSTEMLER

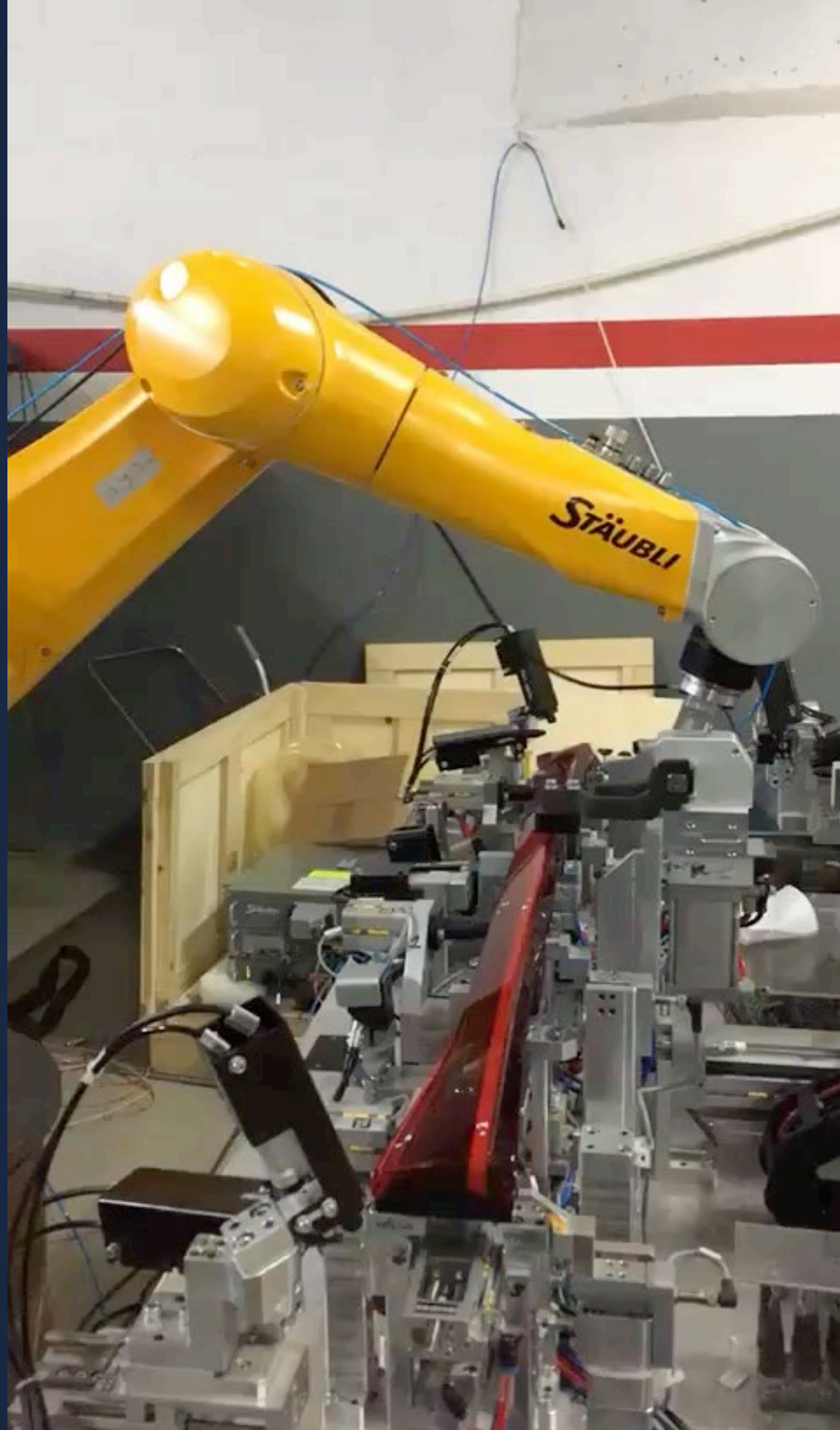

Arka Far Boyutsal Ölçüm Makinesi



Bobin Yükleme Makinesi



Konveyör Lift Sistemi



Ayran Şişe Kapak Makinesi

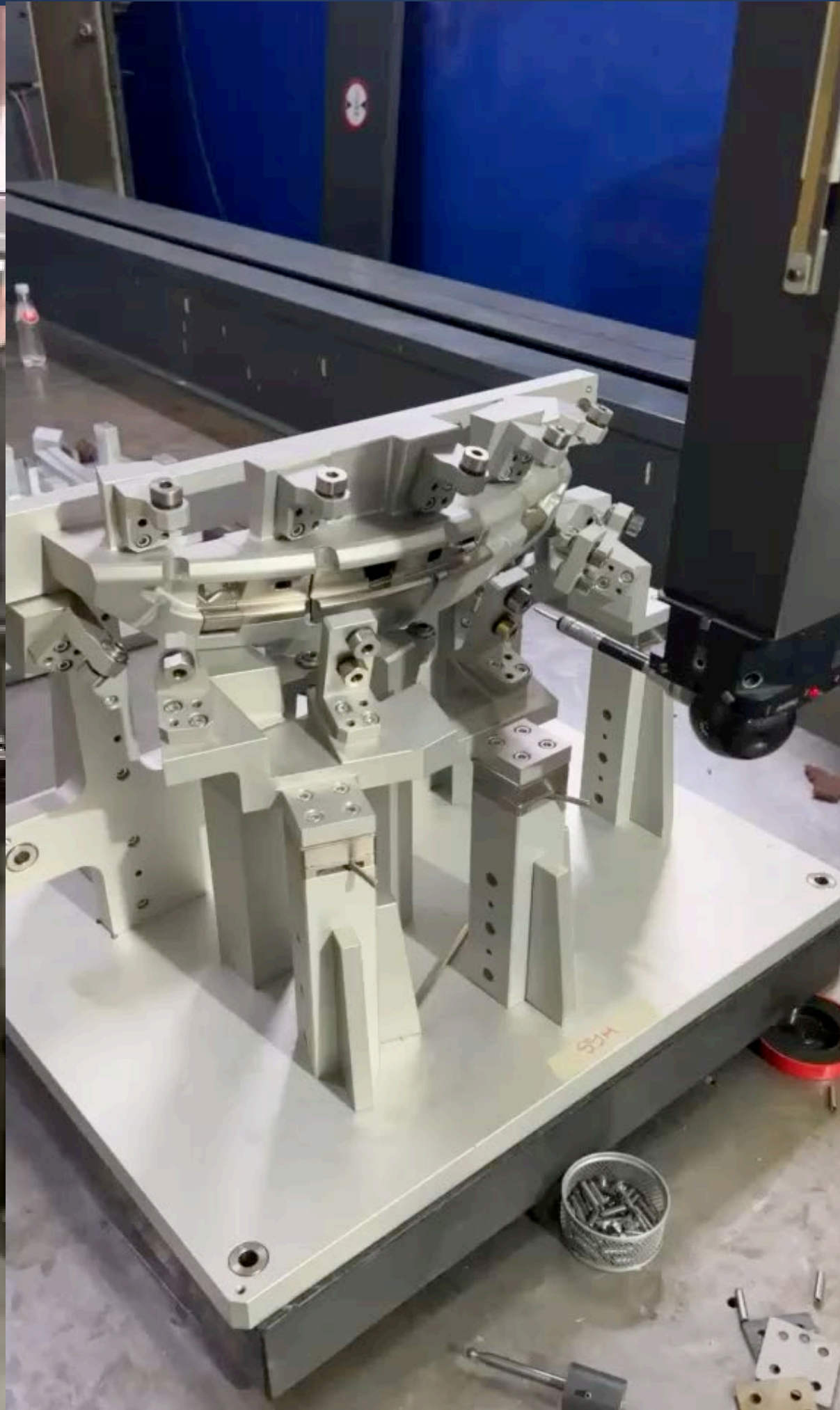

CMM Ölçüm Fikstürü

[www.mertaymakina.com](http://www.mertaymakina.com)



Far Metalizasyon Maske ve Planetler

# KAYNAK KALİTESİ KONTROL FİKSTÜRÜ

Kaynak sırasında oluşan deformasyonları kamera ile izleyen ve kaynak kalitesini OK/NOK olarak değerlendiren cihazdır.

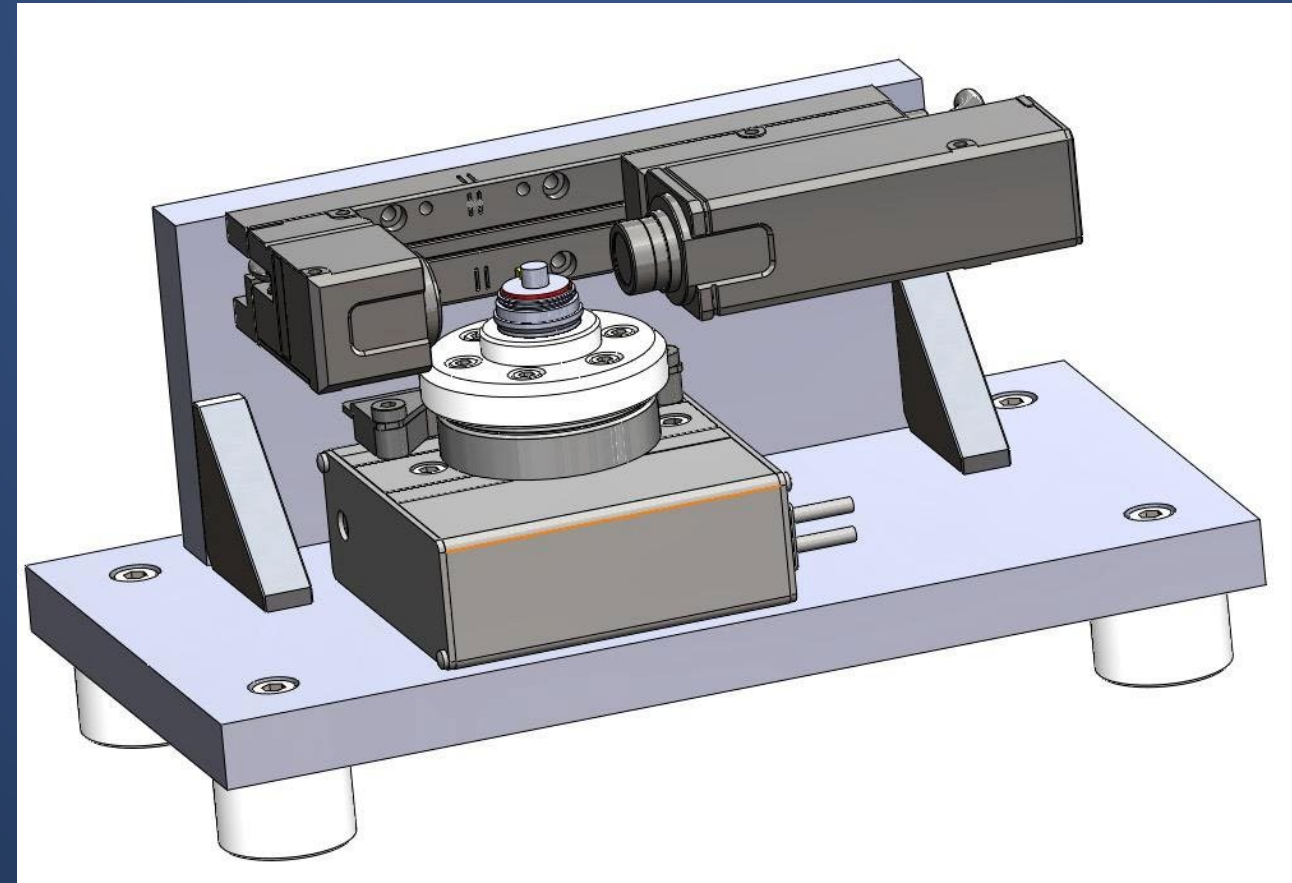

# Konveyör Sistemleri ve Montaj Hatları

Mertay Makina, parça geometrisi, çevrim süresi ve proses gereksinimlerine uygun konveyör sistemleri ve montaj hatları tasarlar ve üretir.

Kapsam:

- PVC bantlı, rulolu, zincir tahrikli ve yerçekimli konveyör sistemleri
- Manuel, yarı otomatik ve tam otomatik üretim hatları
- PLC tabanlı kontrol sistemleri, sensör entegrasyonu ve barkod/DMC izlenebilirlik çözümleri
- Hat dengeleme, istasyon sıralama ve fikstür entegrasyonu
- Operatör ergonomisi, güvenlik kilitlemeleri ve hata önleyici (poka-yoke) uygulamalar
- SCADA entegrasyonu ile gerçek zamanlı izleme ve veri toplama

Tüm sistemler şirket bünyesinde tasarlanır, üretilir ve devreye alınır. Bu yaklaşım, mühendislikten teslimata kadar süreç kontrolü ve proje gereksinimlerine uyum sağlar.

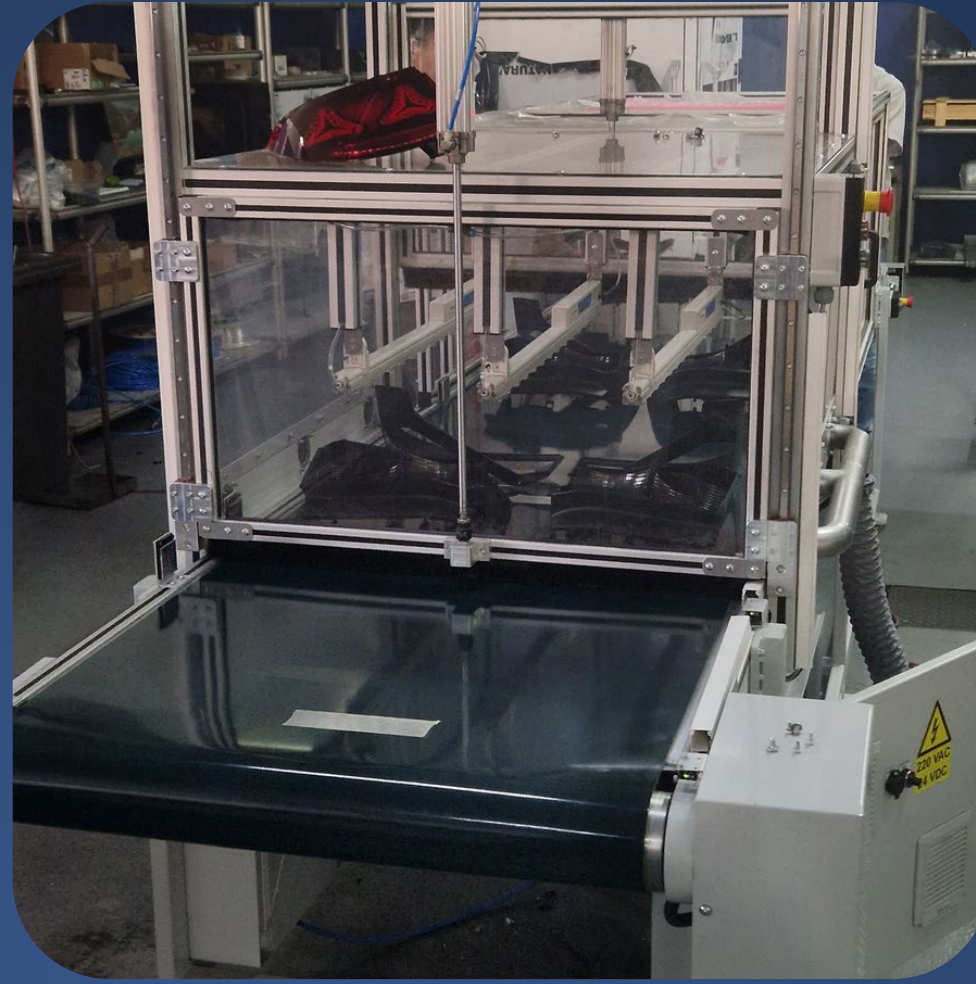

# KONVEYÖR PROJELERİ



KOMBİ MONTAJ HATTI



ESD Özellikli Çift Banth Konveyör



AKÜ MONTAJ HATTI



YOĞURT ÜRETİM HATTI

# TALAŞLI ÜRETİM PARÇALAR

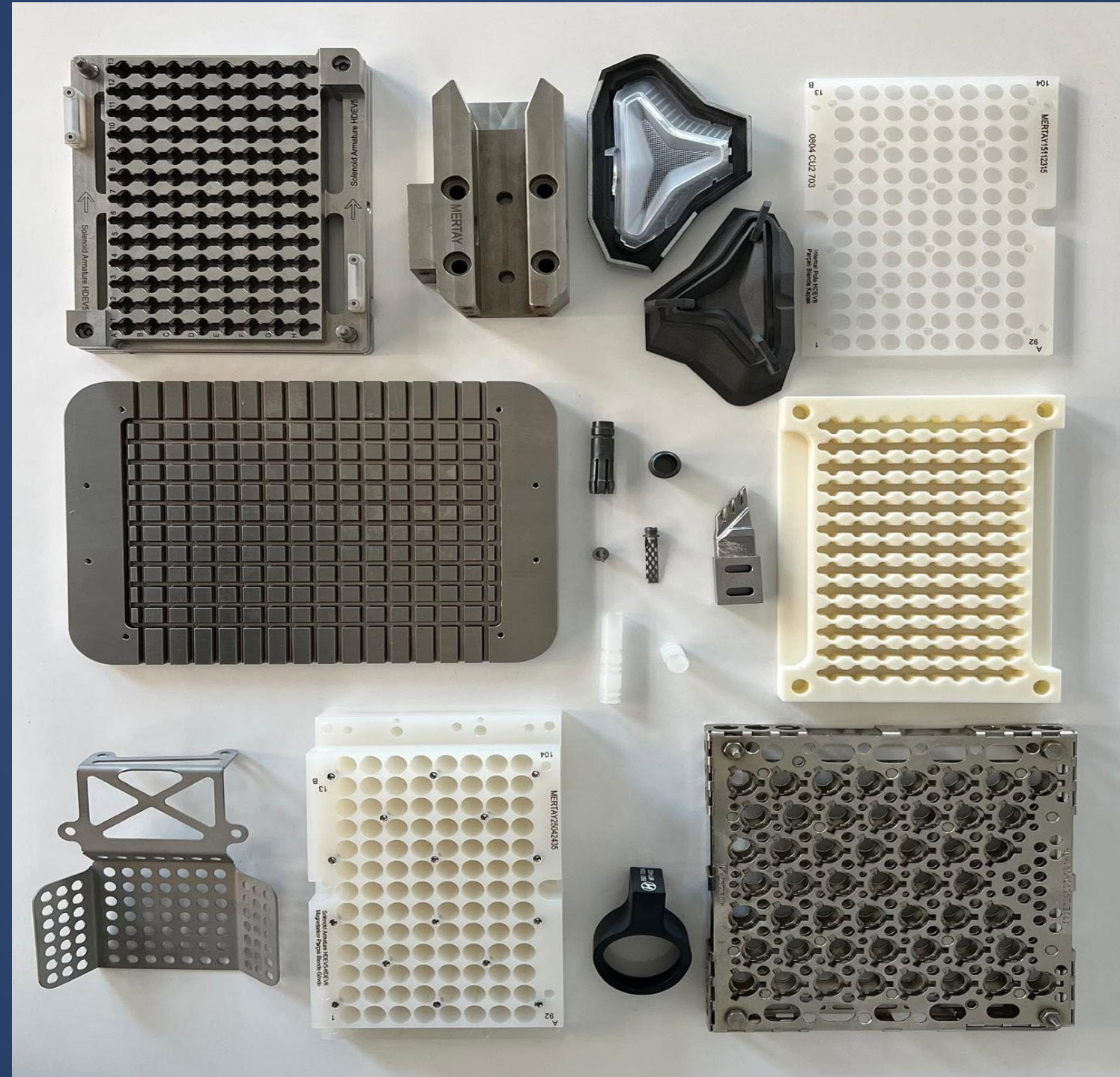

# TALAŞLI ÜRETİM PARÇALAR

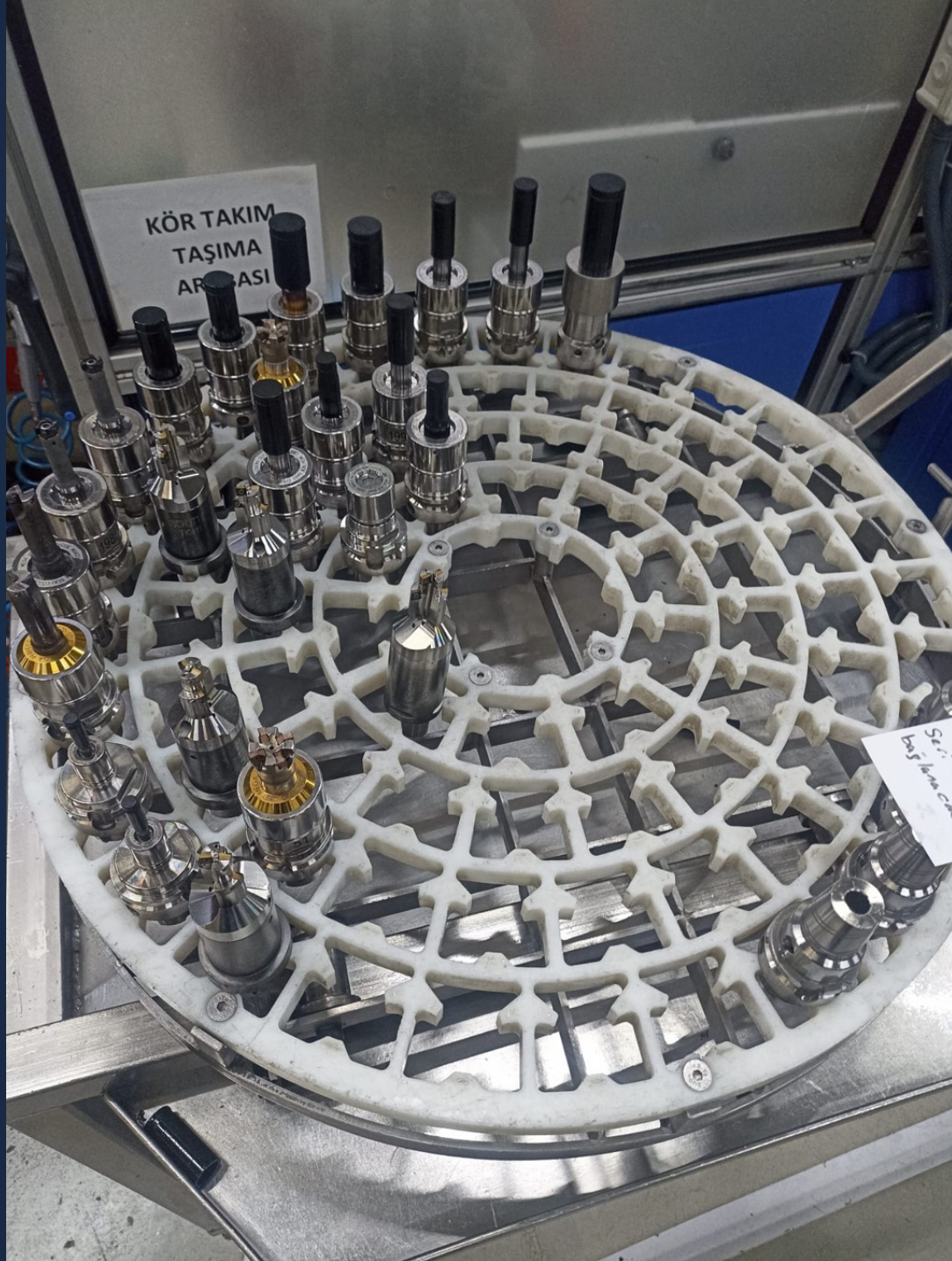

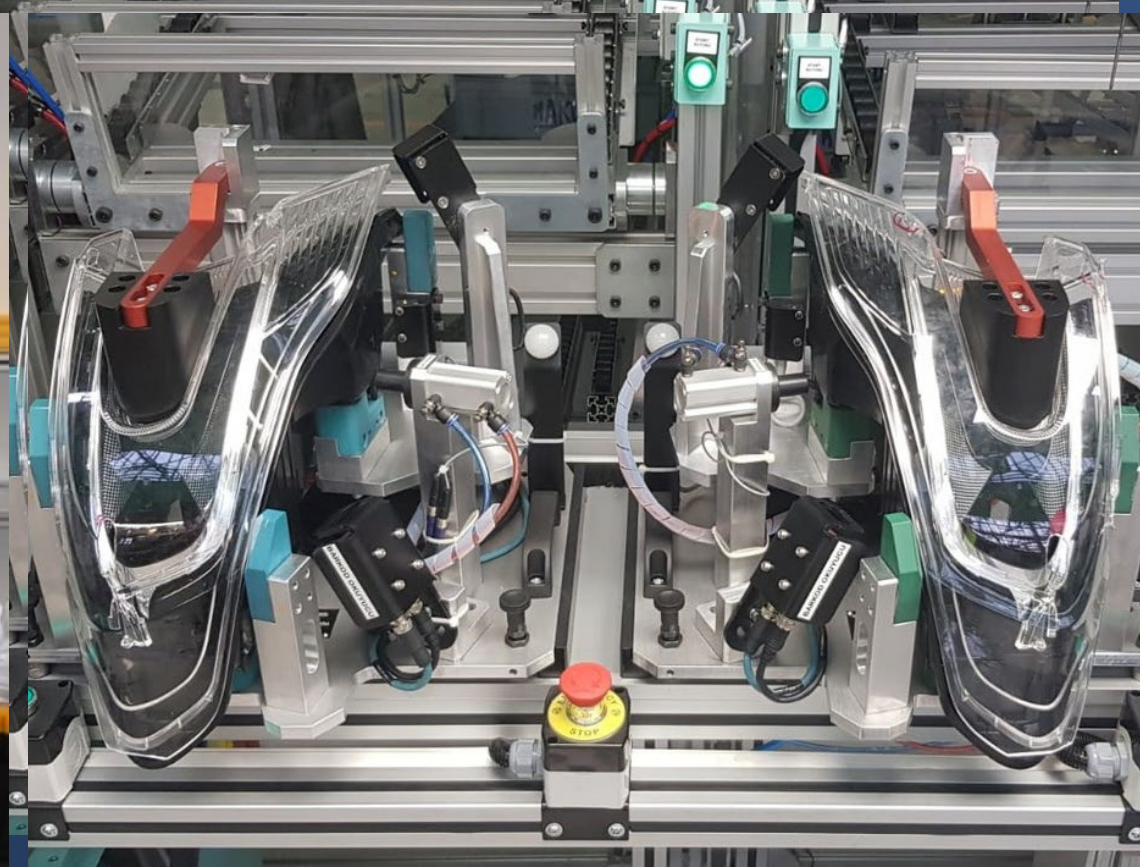
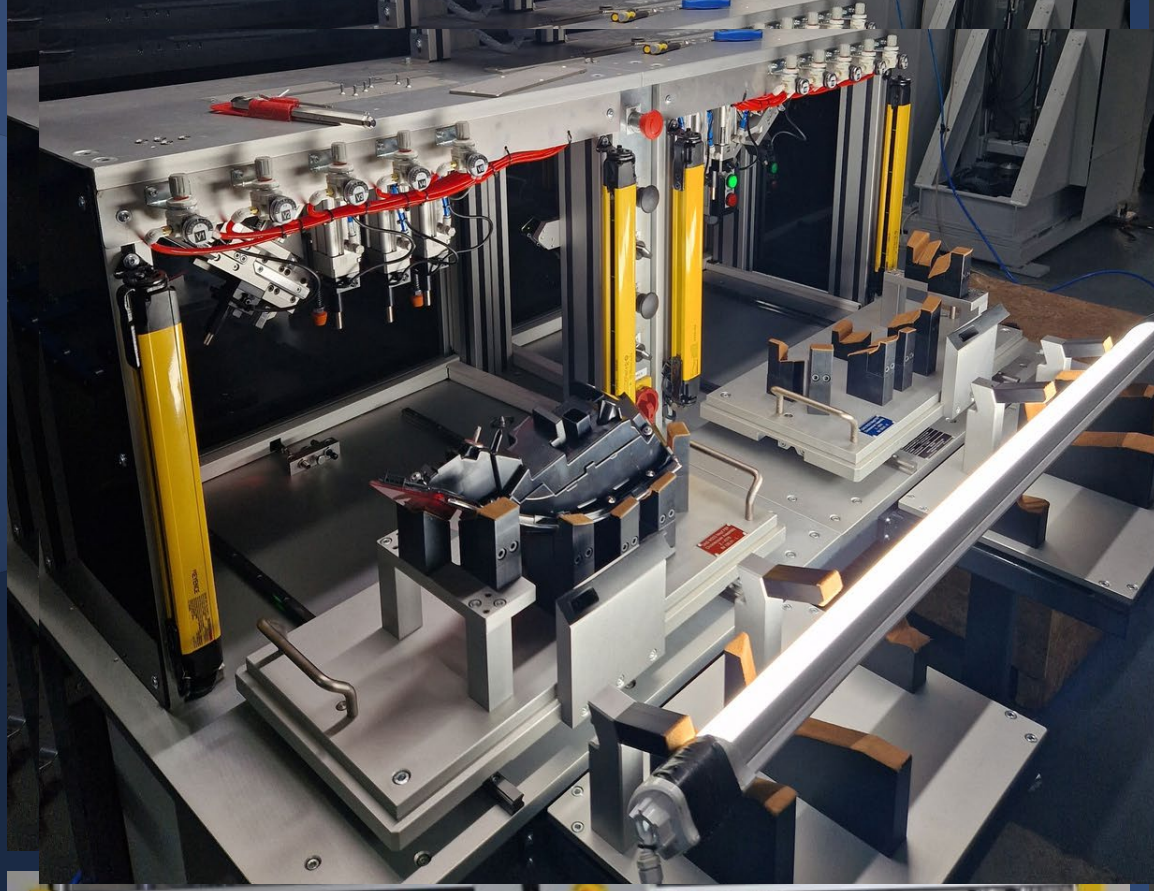

## Fikstürler ve Aparatlar

- Parça geometrisi ve üretim akışına özel tasarım
- Poka-yoke, sensör ve izlenebilirlik entegrasyonu (DMC/barkod)
- PLC kontrollü sistemler ve otomatik hatlarla uyumluluk
- Ergonomik, dayanıklı ve hızlı değişime uygun yapı

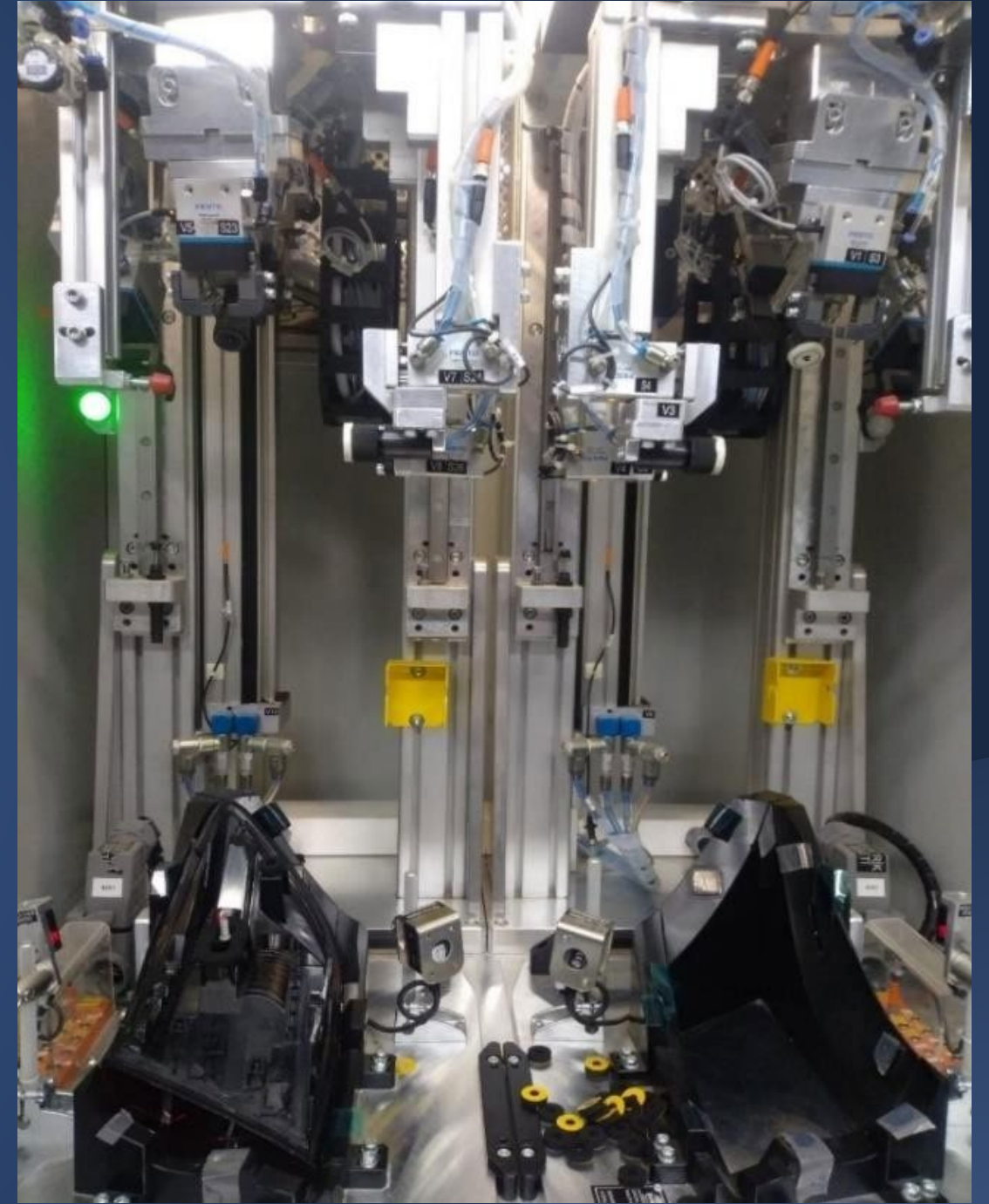

# İŞ İSTASYONU VE DOLAPLAR



# PLATFORM VE BARIYERLER



# PVD Metalizasyon Fikstürleri

PVD kaplama süreçleri için, hassas maskeleme, optimum parça konumlandırma ve hızlı yükleme/boşaltma sağlayan fikstürler tasarlıyoruz.

- Otomotiv aydınlatma parçaları (far, stop, sinyal)
- Karbon fiber, sac metal ve termoform parçalar için maskeleme çözümleri
- Farklı PVD sistemleriyle uyumlu, tam ve kısmi kaplama uygulamaları
- Yüksek tekrarlanabilirlik, denge ve termal stabilite odaklı tasarım



# SOSYAL SORUMLULUK PROJELERİMİZ

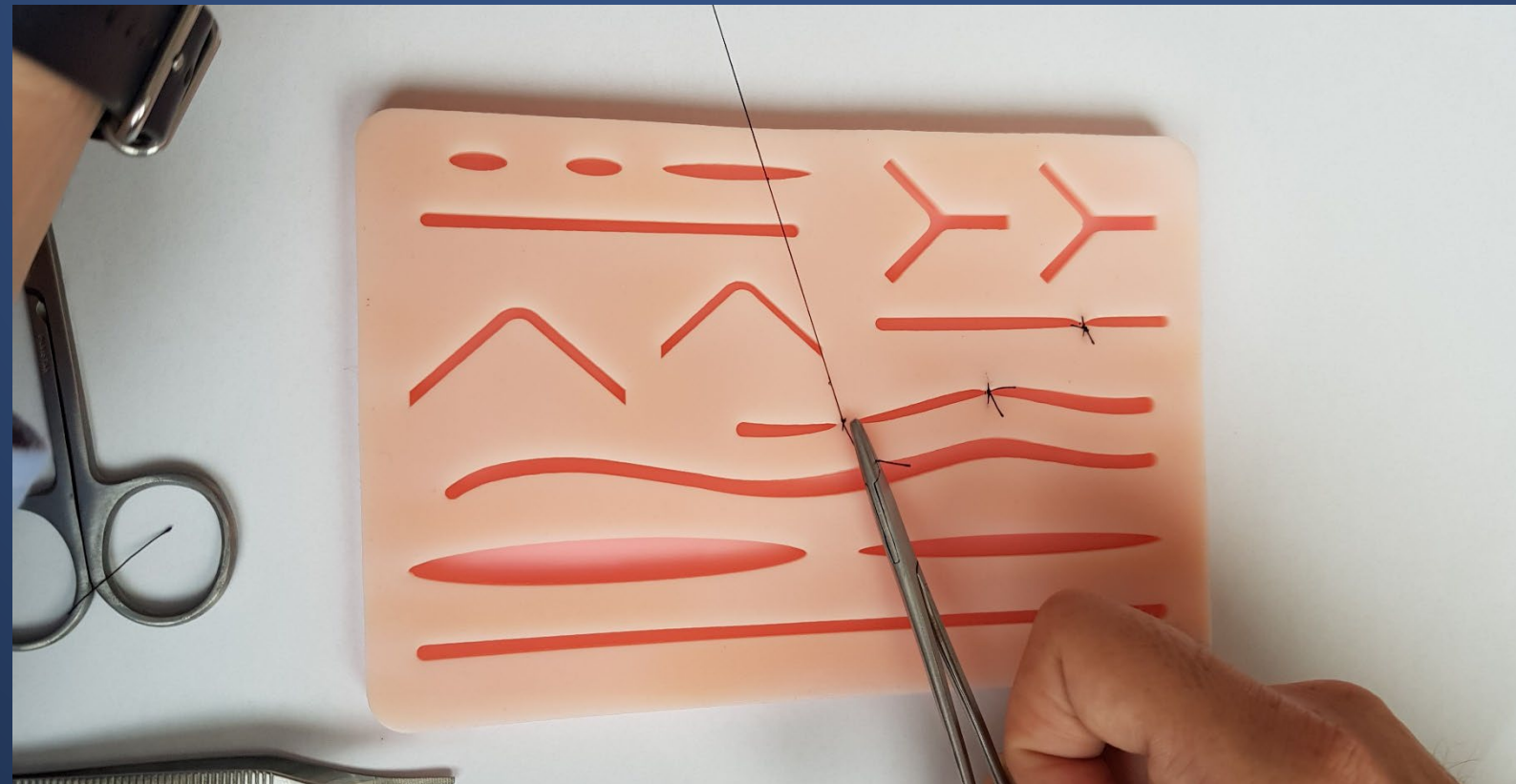



- 1. Turkey
- 2. Germany
- 3. United States
- 4. Mexico
- 5. Switzerland
- 6. France
- 7. Italy
- 8. Morocco
- 9. Poland
- 10. Czechia
- 11. Slovenia
- 12. Bulgaria
- 13. China
- 14. Serbia
- 15. North Macedonia
- 16. Romania

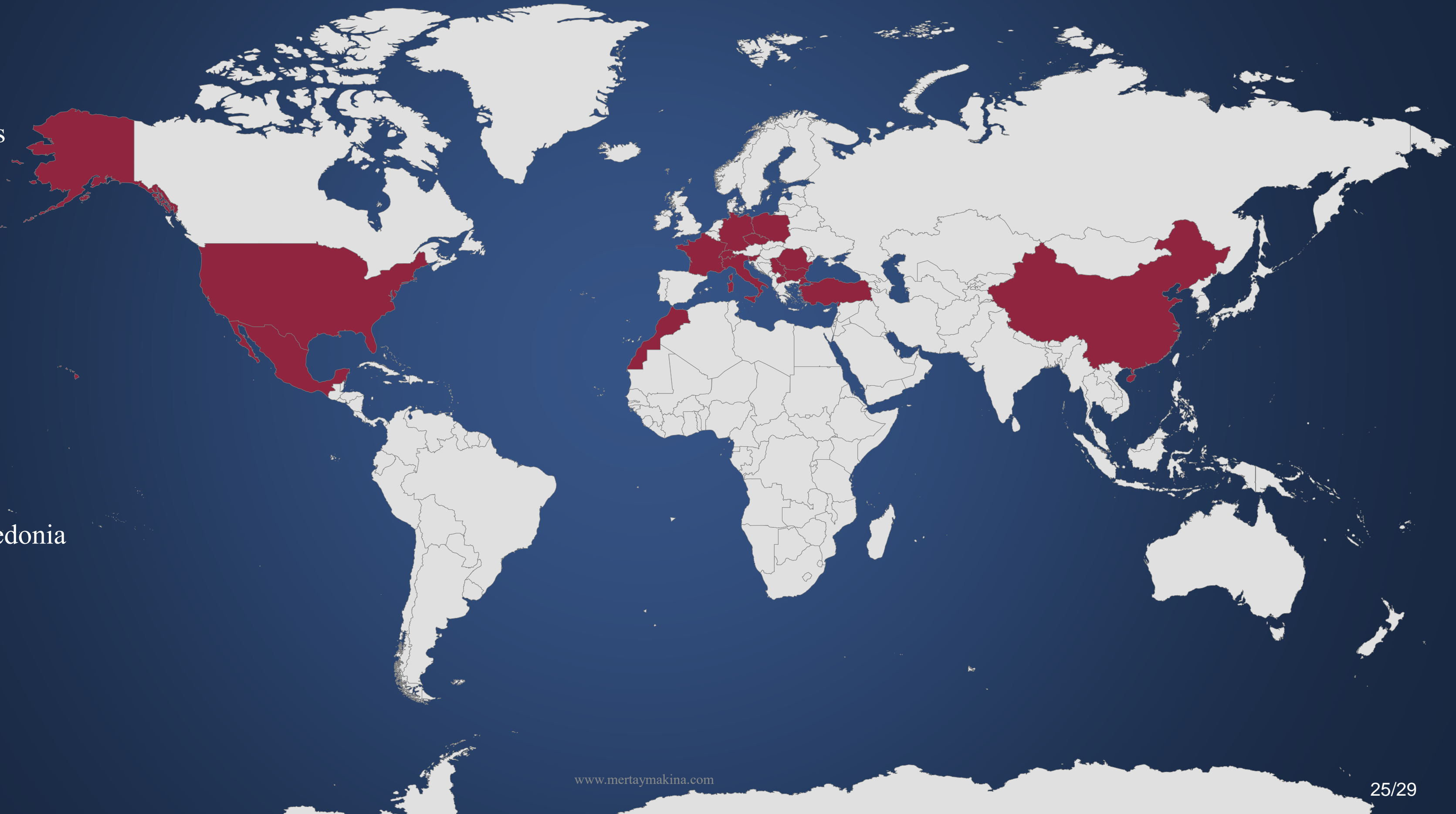



+90 224 441 96 56

www.mertaymakina.com

info@mertaymakina.com



+90 224 441 96 56

www.mertaymakina.com

info@mertaymakina.com



+90 224 441 96 56

www.mertaymakina.com

info@mertaymakina.com

# DİNLEDİĞİNİZ İÇİN TEŞEKKÜR EDERİZ

 | +90 224 441 96 56

 | [www.mertaymakina.com](http://www.mertaymakina.com)

 | [info@mertaymakina.com](mailto:info@mertaymakina.com)