

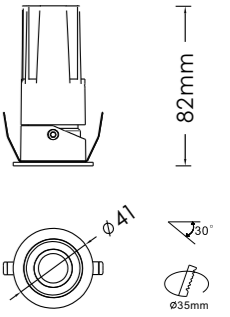

Code No.:DB001M

Power	MAX 8W			
Voltage	AC 220~240V			
Current	200mA			
Angle	15°	24°	36°	60°
Lumen	480LM	495LM	503LM	512LM
CRI	90			
IP	20			
Installation	Embedded			



Honey Comb Spread Lens Solite Lens

Reflector



Matt Black Dark Chrome Matt White Matt Gold Chrome



PHILIPS LUMINUS CITIZEN CREE bridgelux

2700K / 3000K / 3500K / 4000K / 5000K

Angle

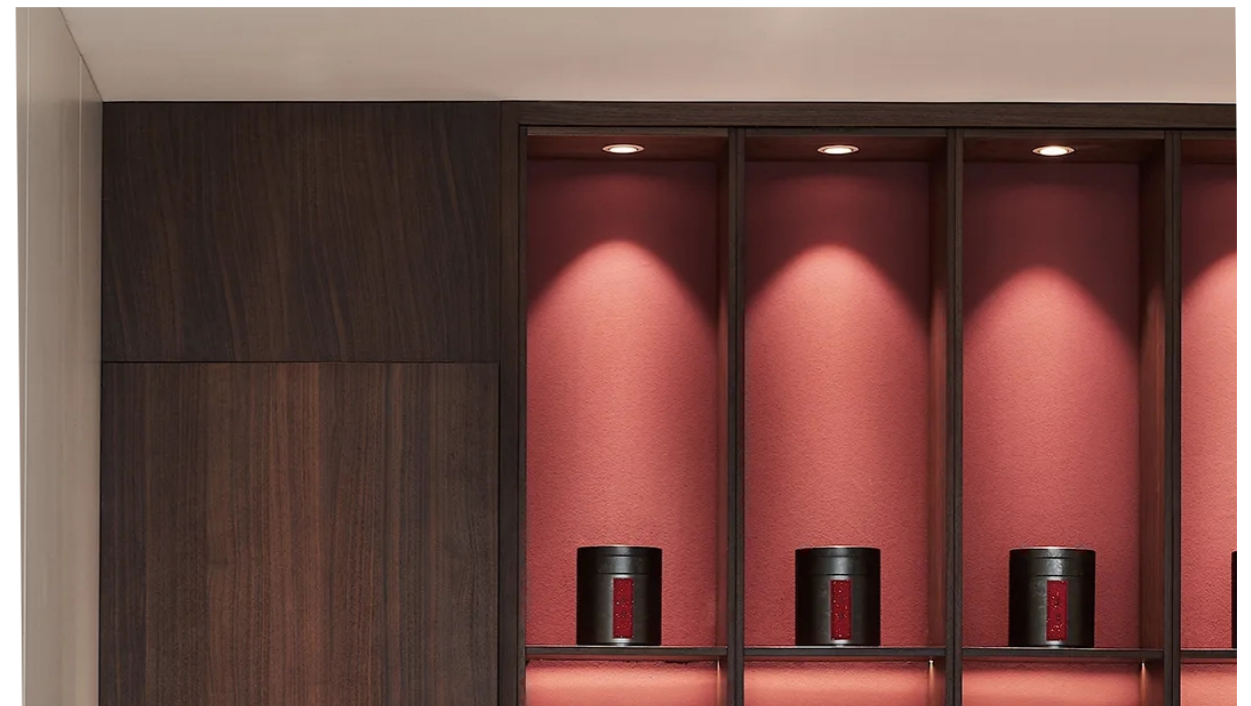
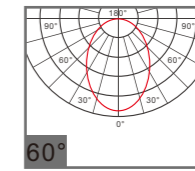
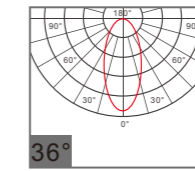
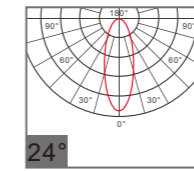
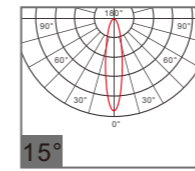

- SCR Dimming
- 0-10V Dimming
- DALI Dimming
- Bluetooth Dimming
- Tuya Dimming
- High-power LED SDCM<3
- CRI ≥ 90
- Anti-Glare



Code No.:DB001

Power	MAX 8W			
Voltage	AC 220-240V			
Current	200mA			
Angle	15°	24°	36°	60°
Lumen	523LM	548LM	554LM	567LM
CRI	90			
IP	20/44			
Installation	Embedded			

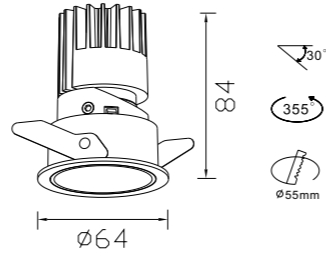

Reflector



PHILIPS LUMINUS CITIZEN CREE bridgelux.
2700K / 3000K / 3500K / 4000K / 5000K

Angle

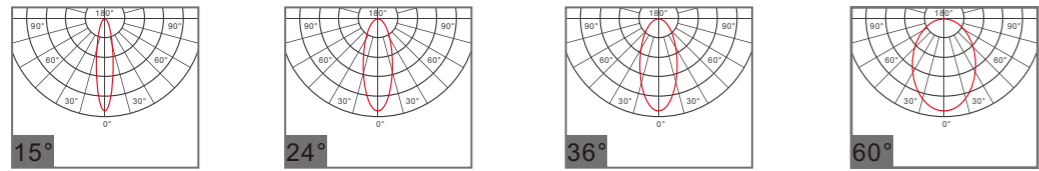

Code No.:DB002

Power	MAX 8W			
Voltage	AC 220-240V			
Current	200mA			
Angle	15°	24°	36°	60°
Lumen	536LM	547M	558LM	563LM
CRI	90			
IP	20/44			
Installation	Embedded			

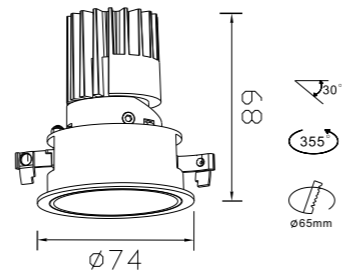

Reflector

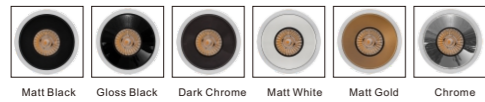

PHILIPS LUMINUS CITIZEN CREE bridgelux.
2700K / 3000K / 3500K / 4000K / 5000K

Angle

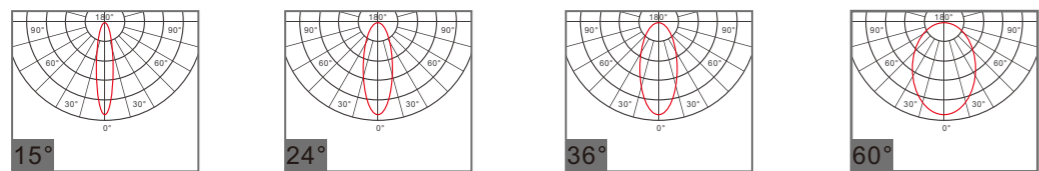



Code No.:DB003

Power	MAX 15W
Voltage	AC 220~240V
Current	350mA
Angle	15° 24° 36° 60°
Lumen	1156LM 1180LM 1226LM 1250LM
CRI	90
IP	20/44
Installation	Embedded

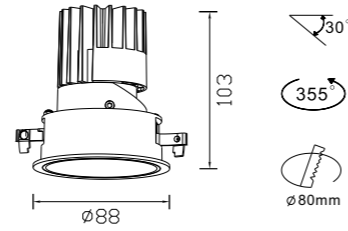

Reflector

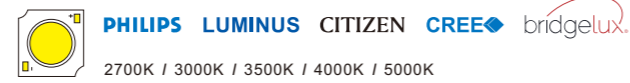

Angle

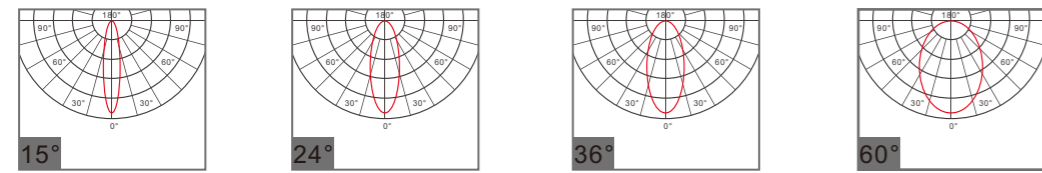

Code No.:DB004

Power	MAX 25W
Voltage	AC 220~240V
Current	600mA
Angle	15° 24° 36° 60°
Lumen	2053LM 2150LM 2275LM 2280LM
CRI	90
IP	20/44
Installation	Embedded

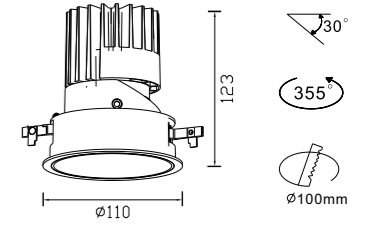

Reflector

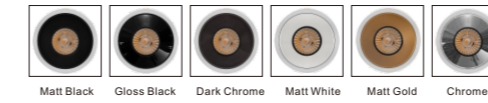

Angle

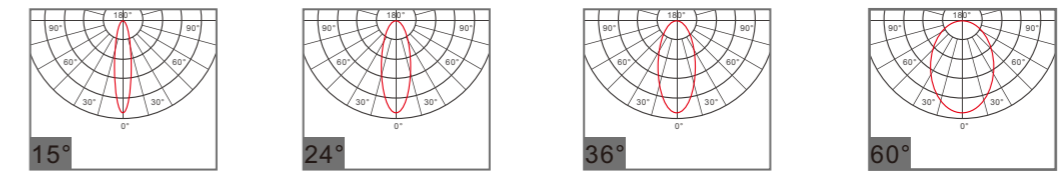

• Buckle



• Buckle



• Honeycomb



Code No.:DB005

Power	MAX 35W
Voltage	AC 220~240V
Current	800mA
Angle	15° 24° 36° 60°
Lumen	2950LM 3150LM 3300LM 3350LM
CRI	90
IP	20/44
Installation	Embedded

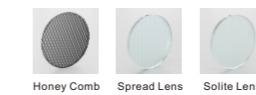
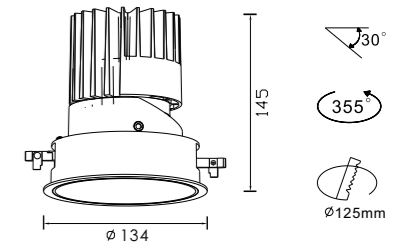

Reflector



Angle

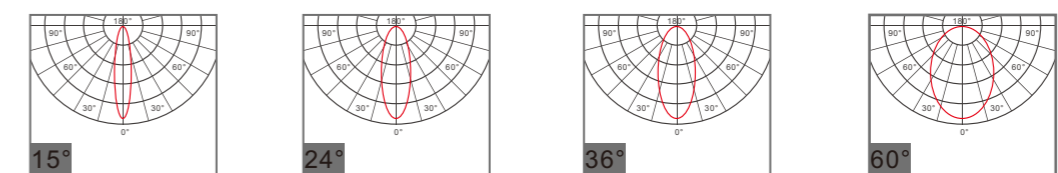

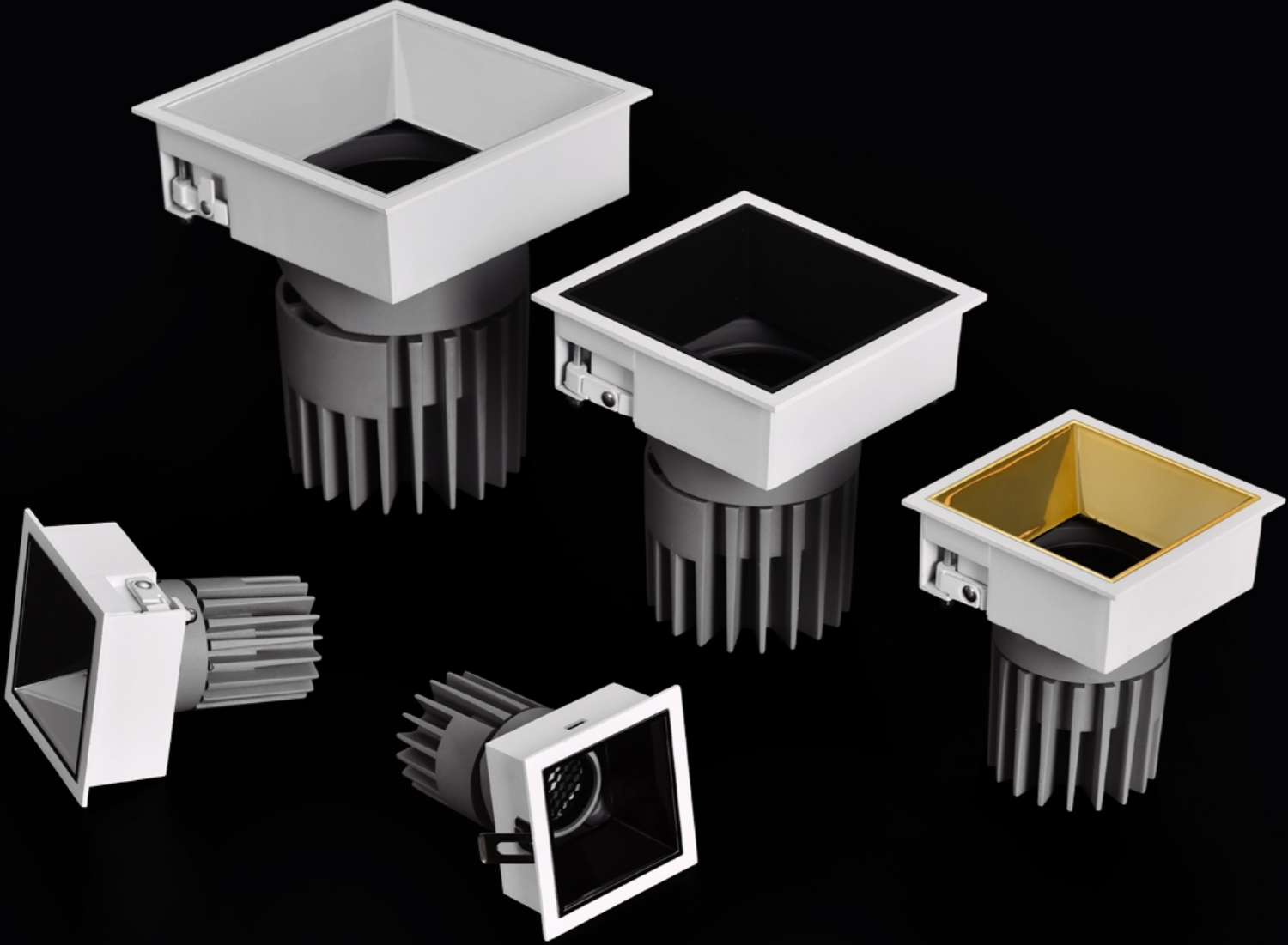

Code No.:DB001S

Power	MAX 8W			
Voltage	AC 220~240V			
Current	200mA			
Angle	15°	24°	36°	60°
Lumen	527LM	533LM	548LM	561LM
CRI	90			
IP	20/44			
Installation	Embedded			

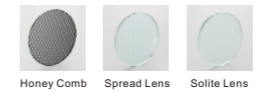
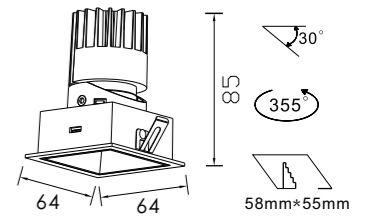

Honey Comb Spread Lens Solite Lens

Reflector



Angle

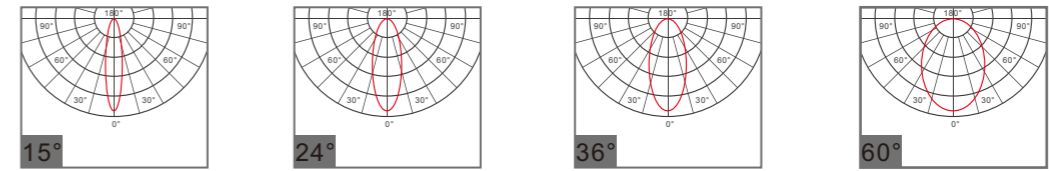

Code No.:DB002S

Power	MAX 8W			
Voltage	AC 220~240V			
Current	200mA			
Angle	15°	24°	36°	60°
Lumen	533LM	542M	553LM	559LM
CRI	90			
IP	20/44			
Installation	Embedded			

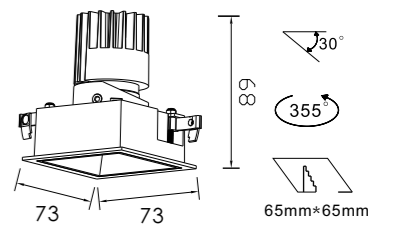

Honey Comb Spread Lens Solite Lens

Reflector



Angle

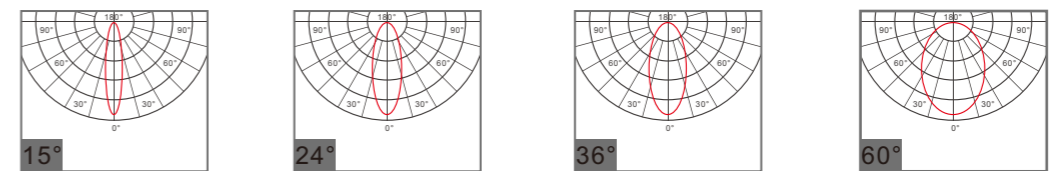

-
-
-
-
-
-
-
-



Code No.:DB003S

Power	MAX 15W
Voltage	AC 220~240V
Current	350mA
Angle	15° 24° 36° 60°
Lumen	1156LM 1180LM 1226LM 1250LM
CRI	90
IP	20/44
Installation	Embedded

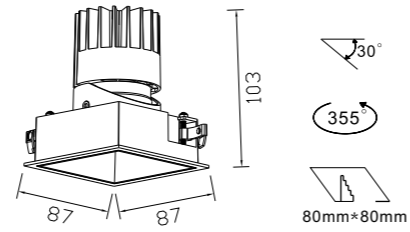

Reflector

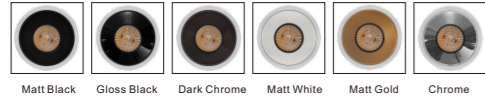

2700K / 3000K / 3500K / 4000K / 5000K

Angle

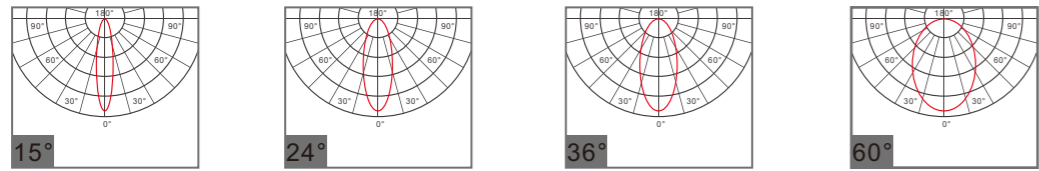

Code No.:DB004S

Power	MAX 25W
Voltage	AC 220~240V
Current	600mA
Angle	15° 24° 36° 60°
Lumen	2046LM 2120LM 2253LM 2270LM
CRI	90
IP	20/44
Installation	Embedded

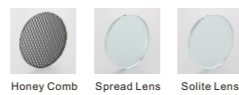
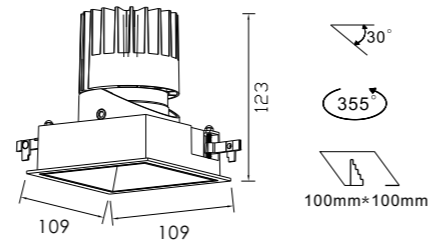

Reflector

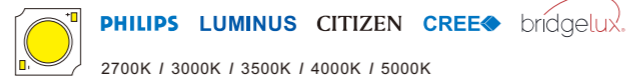
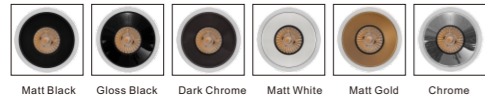

2700K / 3000K / 3500K / 4000K / 5000K

Angle

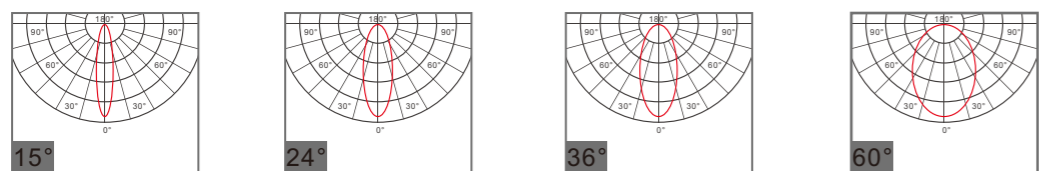

Code No.:DB005S

Power	MAX 35W
Voltage	AC 220~240V
Current	800mA
Angle	15° 24° 36° 60°
Lumen	2950LM 3150LM 3300LM 3350LM
CRI	90
IP	20/44
Installation	Embedded

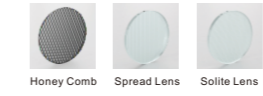
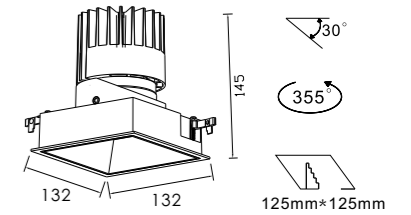

Reflector



2700K / 3000K / 3500K / 4000K / 5000K

Angle

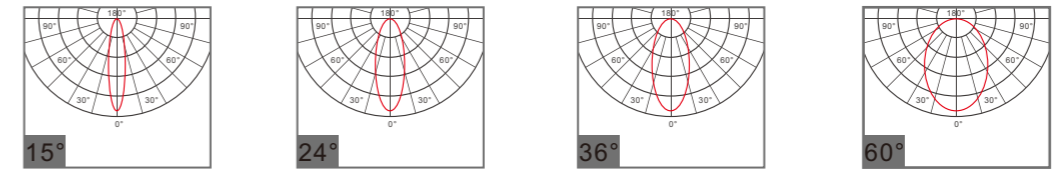



Code No.:DB001N

Power	MAX 8W			
Voltage	AC 220~240V			
Current	200mA			
Angle	15°	24°	36°	60°
Lumen	523LM	548LM	554LM	567LM
CRI	90			
IP	20/44			
Installation	Embedded			

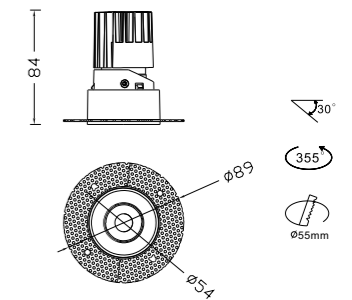

Reflector



Angle

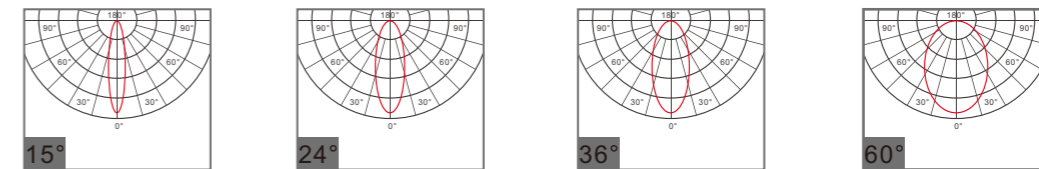

Code No.:DB002N

Power	MAX 8W			
Voltage	AC 220~240V			
Current	200mA			
Angle	15°	24°	36°	60°
Lumen	536LM	547M	558LM	563LM
CRI	90			
IP	20/44			
Installation	Embedded			

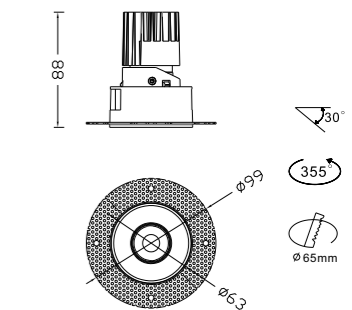

Reflector



Angle

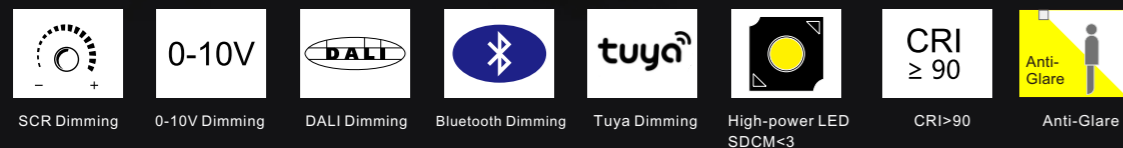
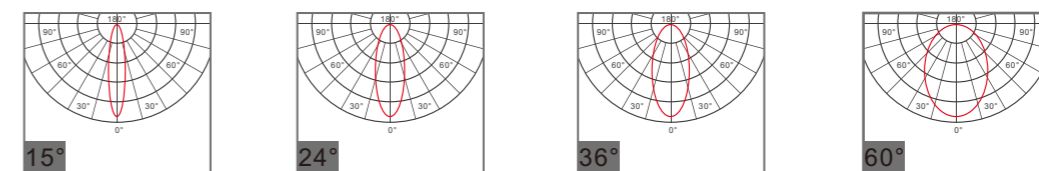



Code No.:DB003N

Power	MAX 15W
Voltage	AC 220~240V
Current	350mA
Angle	15° 24° 36° 60°
Lumen	1156LM 1180LM 1226LM 1250LM
CRI	90
IP	20/44
Installation	Embedded

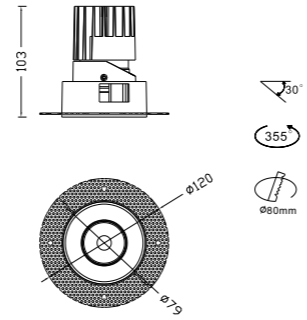

Reflector



PHILIPS LUMINUS CITIZEN **CREE** **bridgelux**.
 2700K / 3000K / 3500K / 4000K / 5000K

Angle

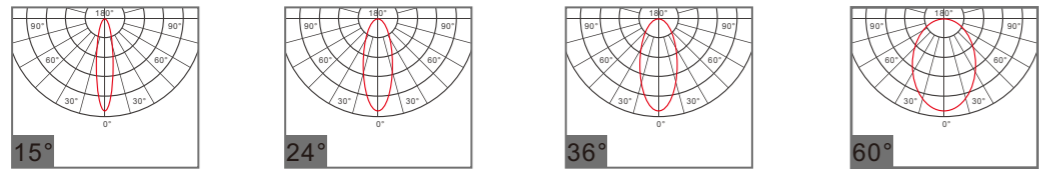

Code No.:DB004N

Power	MAX 25W
Voltage	AC 220~240V
Current	600mA
Angle	15° 24° 36° 60°
Lumen	2053LM 2150LM 2275LM 2280LM
CRI	90
IP	20/44
Installation	Embedded

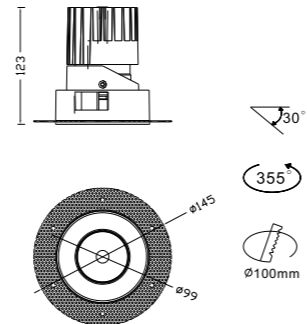

Reflector

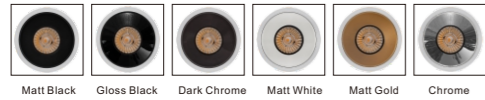

PHILIPS LUMINUS CITIZEN **CREE** **bridgelux**.
 2700K / 3000K / 3500K / 4000K / 5000K

Angle

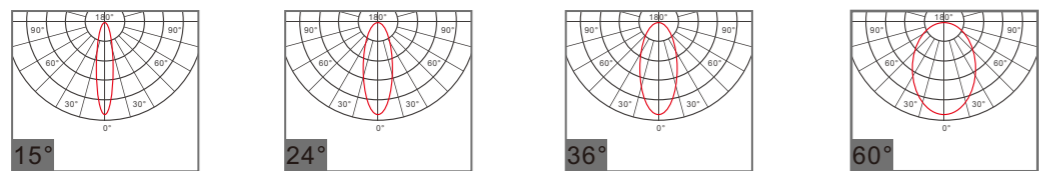



Code No.:DB005N

Power	MAX 35W			
Voltage	AC 220~240V			
Current	800mA			
Angle	15°	24°	36°	60°
Lumen	2950LM	3150LM	3300LM	3350LM
CRI	90			
IP	20/44			
Installation	Embedded			

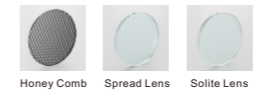
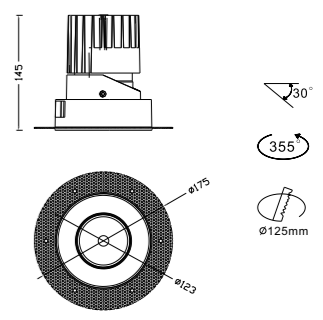

Reflector



Angle

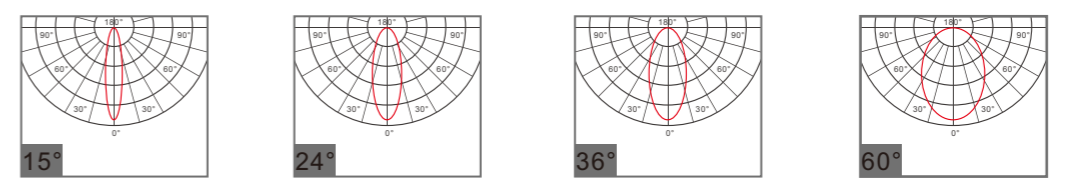



Code No.:DB001SN

Power	MAX 8W			
Voltage	AC 220~240V			
Current	200mA			
Angle	15°	24°	36°	60°
Lumen	527LM	533LM	548LM	561LM
CRI	90			
IP	20/44			
Installation	Embedded			

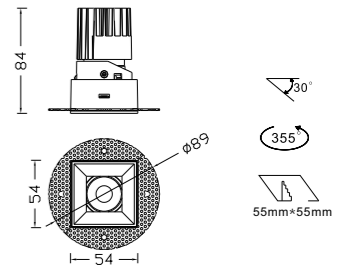

Reflector



Angle

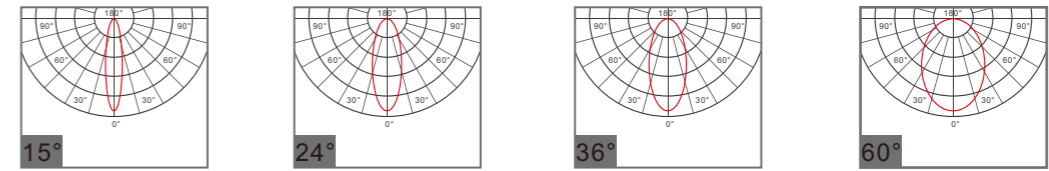

Code No.:DB002SN

Power	MAX 8W			
Voltage	AC 220~240V			
Current	200mA			
Angle	15°	24°	36°	60°
Lumen	533LM	542LM	553LM	559LM
CRI	90			
IP	20/44			
Installation	Embedded			

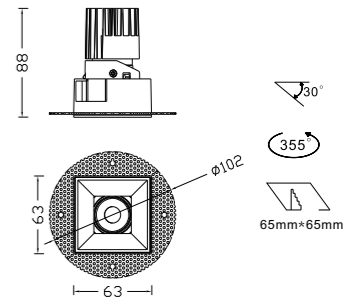

Reflector



Angle

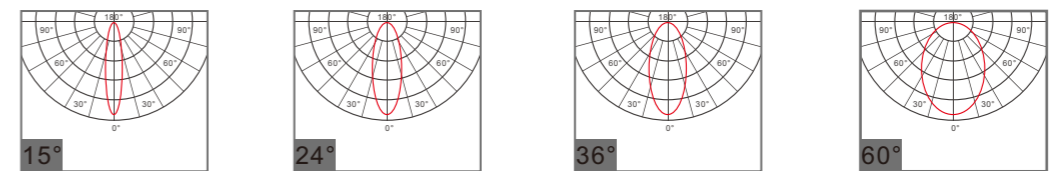

-
-
-
-
-
-
-
-



Code No.:DB003SN

Power	MAX 15W
Voltage	AC 220~240V
Current	350mA
Angle	15° 24° 36° 60°
Lumen	1156LM 1180LM 1226LM 1250LM
CRI	90
IP	20/44
Installation	Embedded

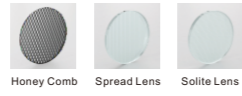
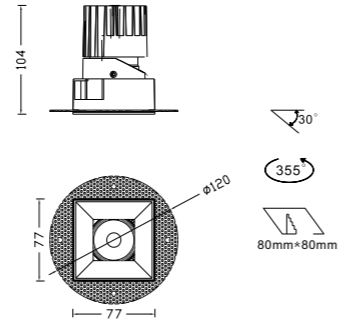

Reflector

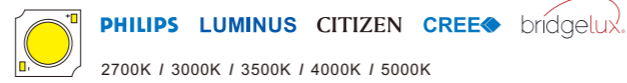

Angle

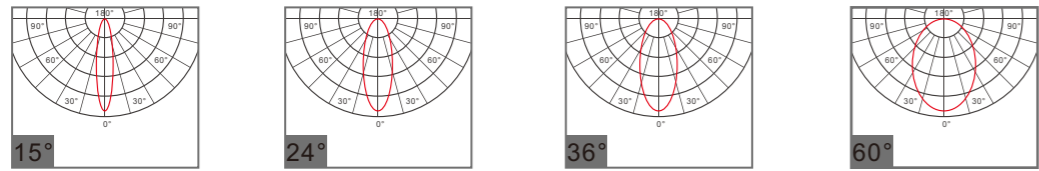

Code No.:DB005SN

Power	MAX 35W
Voltage	AC 220~240V
Current	800mA
Angle	15° 24° 36° 60°
Lumen	2950LM 3150LM 3300LM 3350LM
CRI	90
IP	20/44
Installation	Embedded

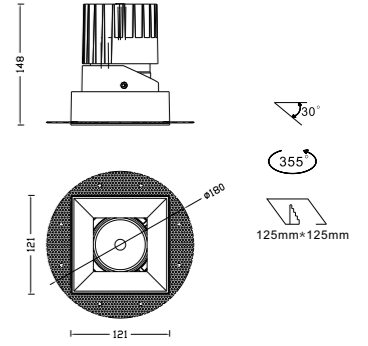

Reflector



Angle

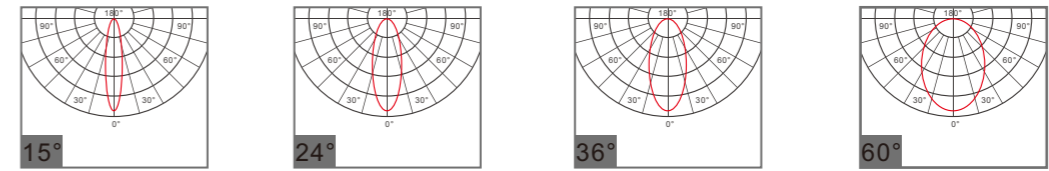

Code No.:DB004SN

Power	MAX 25W
Voltage	AC 220~240V
Current	600mA
Angle	15° 24° 36° 60°
Lumen	2046LM 2120LM 2253LM 2270LM
CRI	90
IP	20/44
Installation	Embedded

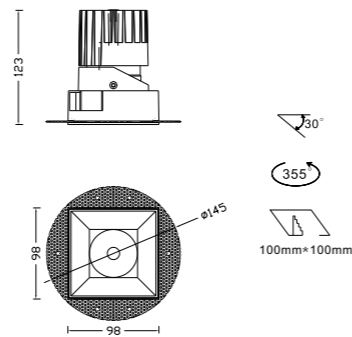

Reflector

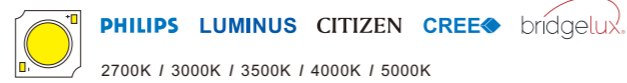
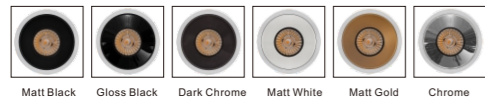

Angle

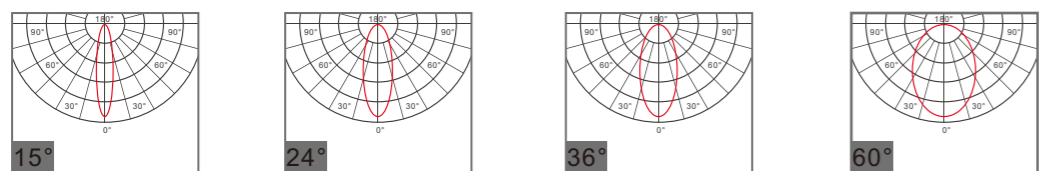

Multiple Combination

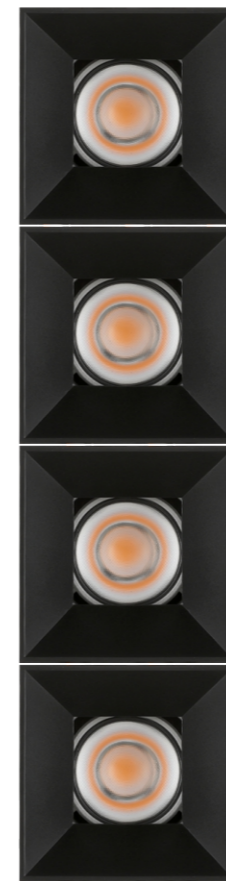
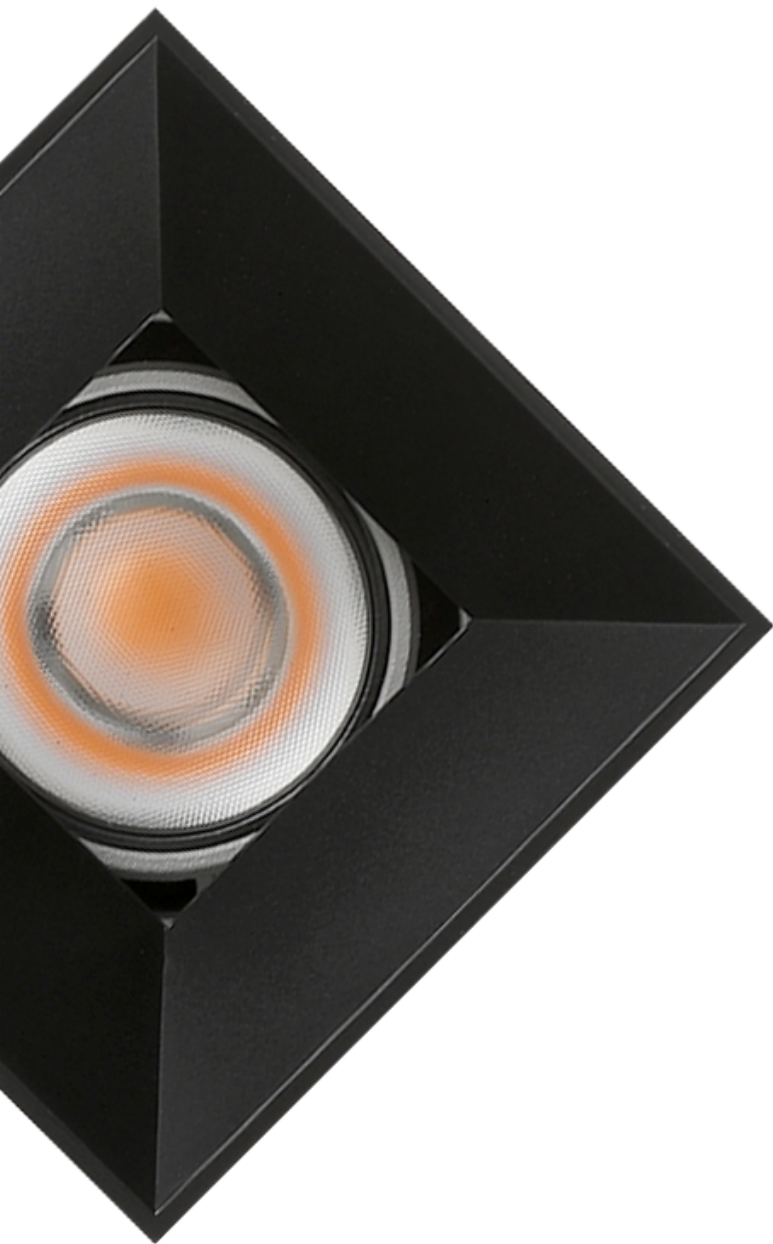

Four combinations

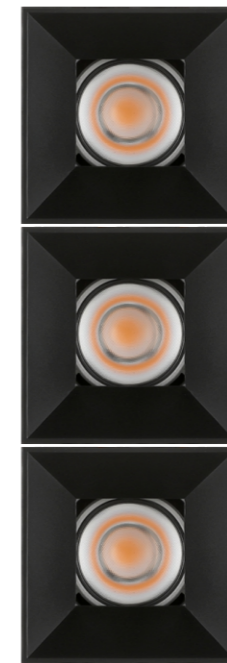

Three combinations

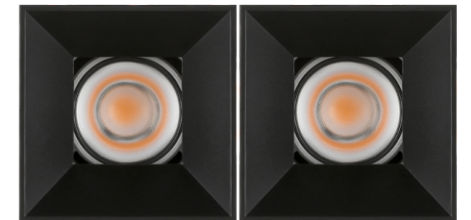

Two combinations

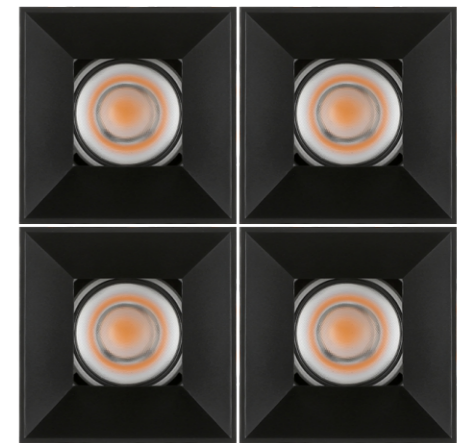

Four combinations



Code No.:DB021S

Power	MAX 2*8W
Voltage	AC 220~240V
Current	200mA
Angle	15° 24° 36° 60°
Lumen	527LM 533LM 548LM 561LM
CRI	90
IP	20/44
Installation	Embedded

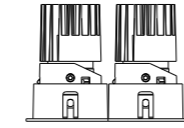

85mm

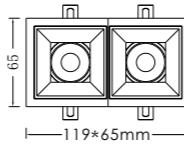

50°
355°
111mm*58mm

Reflector



PHILIPS LUMINUS CITIZEN CREE bridgelux.

2700K / 3000K / 3500K / 4000K / 5000K

Angle

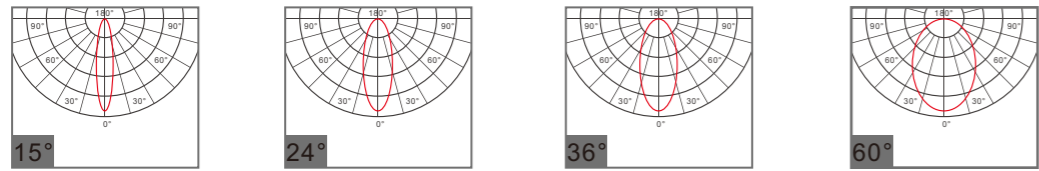

Code No.:DB023S

Power	MAX 2*15W
Voltage	AC 220~240V
Current	350mA
Angle	15° 24° 36° 60°
Lumen	1156LM 1180LM 1226LM 1250LM
CRI	90
IP	20/44
Installation	Embedded

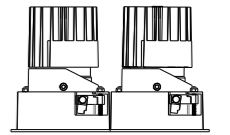

103mm

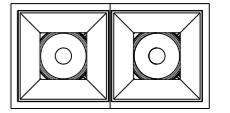

30°
355°
158mm*80mm

Reflector



PHILIPS LUMINUS CITIZEN CREE bridgelux.

2700K / 3000K / 3500K / 4000K / 5000K

Angle

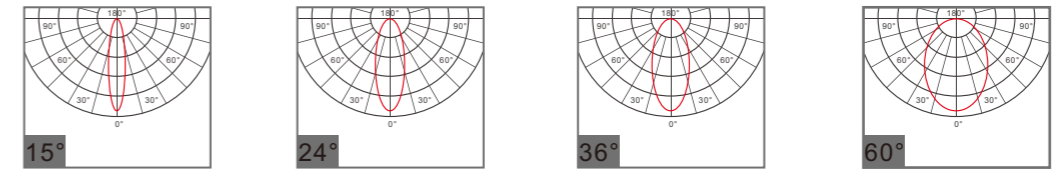

Code No.:DB022S

Power	MAX 2*8W
Voltage	AC 220~240V
Current	200mA
Angle	15° 24° 36° 60°
Lumen	533LM 542M 553LM 559LM
CRI	90
IP	20/44
Installation	Embedded

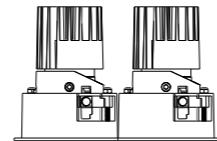

89mm

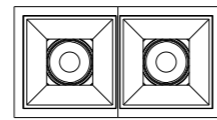

30°
355°
130mm*65mm

Reflector

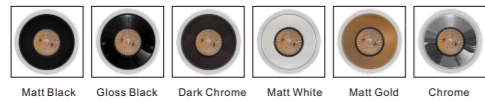

PHILIPS LUMINUS CITIZEN CREE bridgelux.

2700K / 3000K / 3500K / 4000K / 5000K

Angle

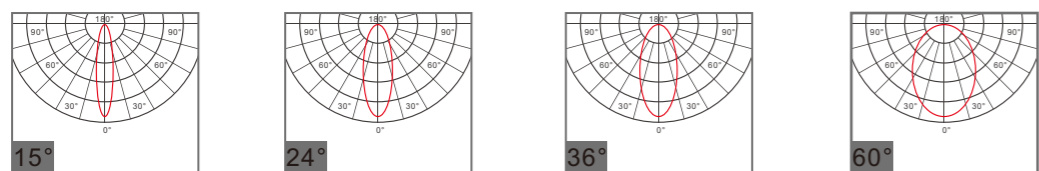

Code No.:DB024S

Power	MAX 2*25W
Voltage	AC 220~240V
Current	600mA
Angle	15° 24° 36° 60°
Lumen	2046LM 2120LM 2253LM 2270LM
CRI	90
IP	20/44
Installation	Embedded

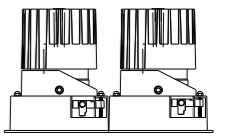

123mm

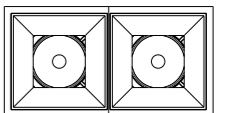

30°
355°
200mm*100mm

Reflector



PHILIPS LUMINUS CITIZEN CREE bridgelux.

2700K / 3000K / 3500K / 4000K / 5000K

Angle

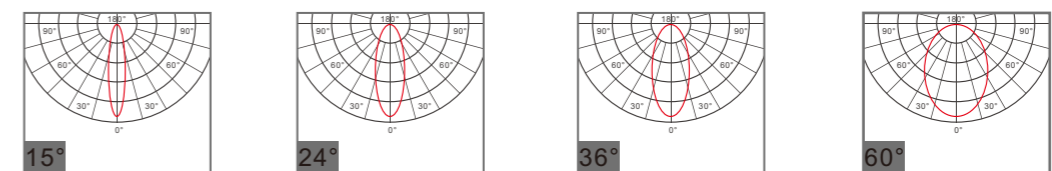



Code No.:DB025S

Power	MAX 2*35W			
Voltage	AC 220~240V			
Current	800mA			
Angle	15°	24°	36°	60°
Lumen	2950LM	3150LM	3300LM	3320LM
CRI	90			
IP	20/44			
Installation	Embedded			

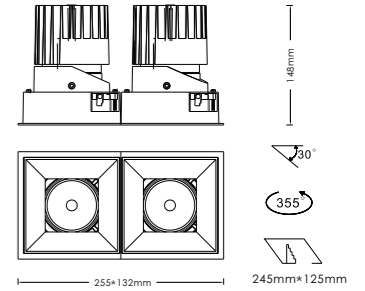

Honey Comb Spread Lens Solite Lens

Reflector



Matt Black Gloss Black Dark Chrome Matt White Matt Gold Chrome



PHILIPS LUMINUS CITIZEN **CREE** **bridgelux**
2700K / 3000K / 3500K / 4000K / 5000K

Angle

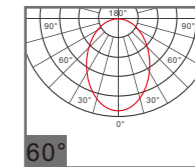
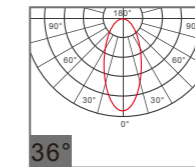
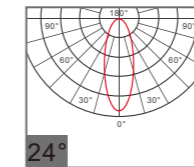
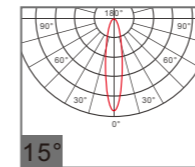



Code No.:DB023SN

Power	MAX 2*15W
Voltage	AC 220~240V
Current	350mA
Angle	15° 24° 36° 60°
Lumen	1156LM 1180LM 1226LM 1250LM
CRI	90
IP	20/44
Installation	Embedded

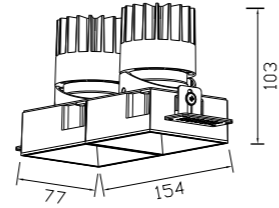

Reflector



PHILIPS LUMINUS CITIZEN CREE bridgelux.

2700K / 3000K / 3500K / 4000K / 5000K

Angle

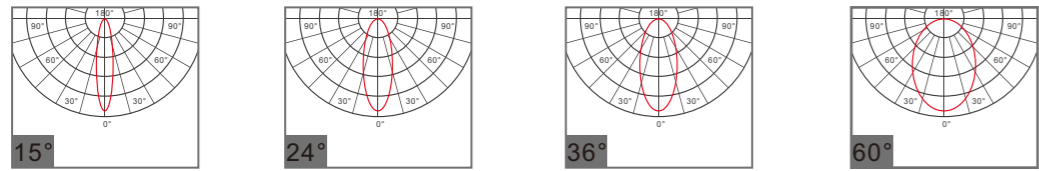

Code No.:DB024SN

Power	MAX 2*25W
Voltage	AC 220~240V
Current	600mA
Angle	15° 24° 36° 60°
Lumen	2046LM 2120LM 2253LM 2270LM
CRI	90
IP	20/44
Installation	Embedded

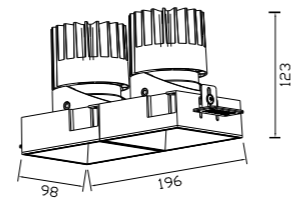

Reflector

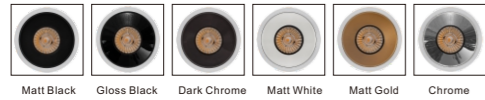

PHILIPS LUMINUS CITIZEN CREE bridgelux.

2700K / 3000K / 3500K / 4000K / 5000K

Angle

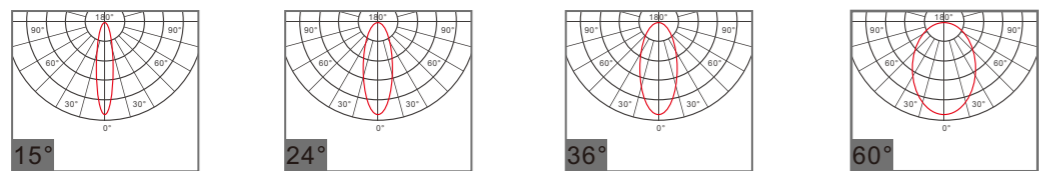



Code No.:DB003A

Power	MAX 12W			
Voltage	AC 220~240V			
Current	300mA			
Angle	15°	24°	36°	60°
Lumen	916LM	925LM	953LM	987LM
CRI	90			
IP	20/44			
Installation	Embedded			

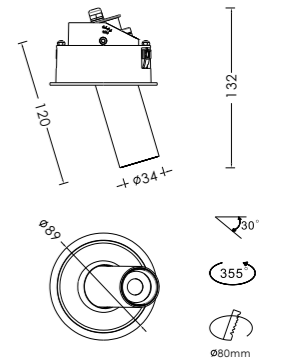
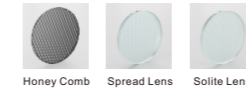

Reflector



Angle

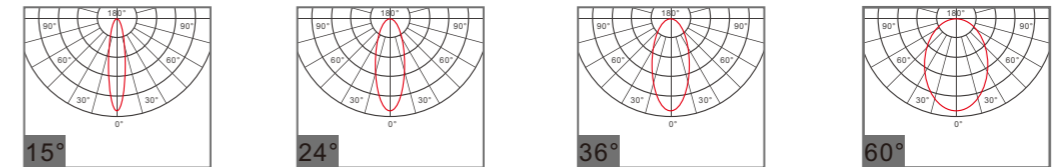

Code No.:DB004A

Power	MAX 15W			
Voltage	AC 220~240V			
Current	350mA			
Angle	15°	24°	36°	60°
Lumen	1140LM	1170M	1210LM	1260LM
CRI	90			
IP	20/44			
Installation	Embedded			

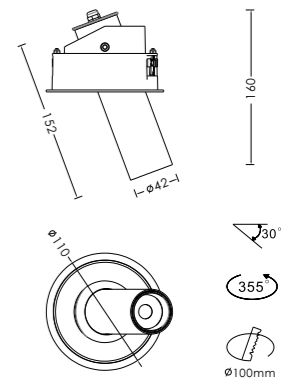
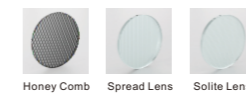

Reflector



Angle

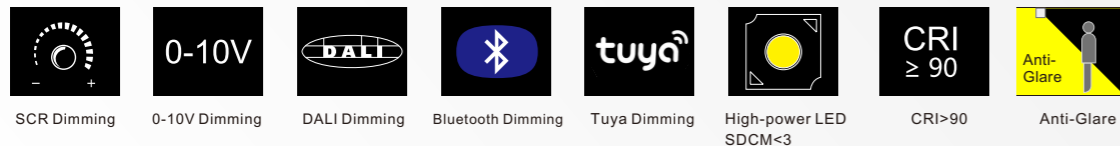
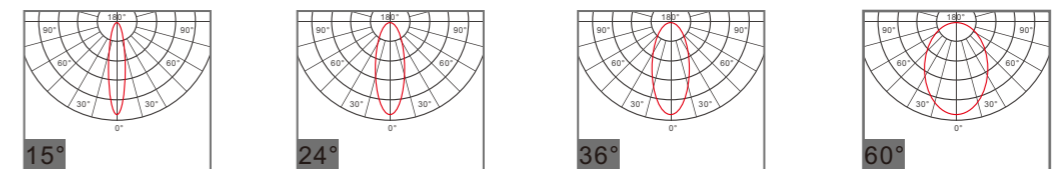



Code No.:DB003NA

Power	MAX 12W
Voltage	AC 220-240V
Current	300mA
Angle	15° 24° 36° 60°
Lumen	916LM 925LM 953LM 987LM
CRI	90
IP	20/44
Installation	Embedded

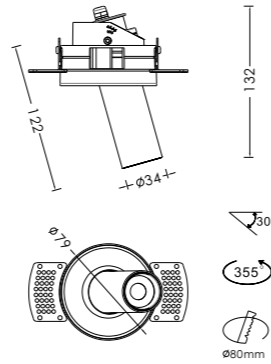

Reflector

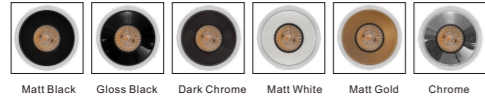

PHILIPS LUMINUS CITIZEN CREE bridgelux.

2700K / 3000K / 3500K / 4000K / 5000K

Angle

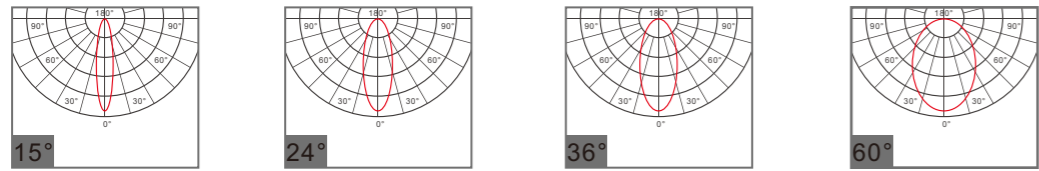

Code No.:DB004NA

Power	MAX 15W
Voltage	AC 220-240V
Current	350mA
Angle	15° 24° 36° 60°
Lumen	1140LM 1170M 1210LM 1260LM
CRI	90
IP	20/44
Installation	Embedded

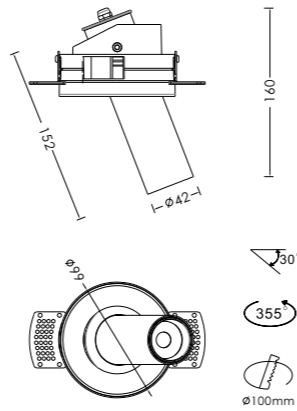

Reflector

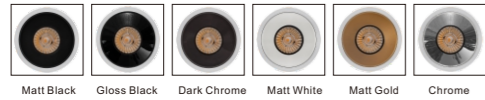

PHILIPS LUMINUS CITIZEN CREE bridgelux.

2700K / 3000K / 3500K / 4000K / 5000K

Angle

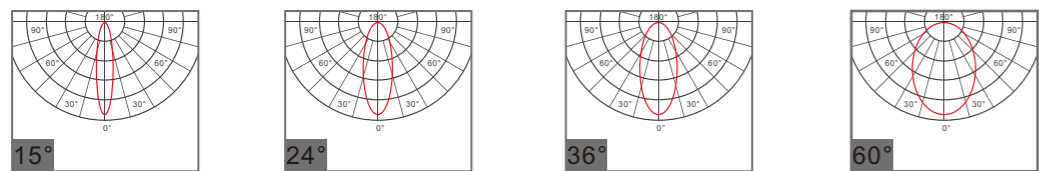



Code No.:DB003SA

Power	MAX 12W
Voltage	AC 220~240V
Current	300mA
Angle	15° 24° 36° 60°
Lumen	916LM 925LM 953LM 987LM
CRI	90
IP	20/44
Installation	Embedded

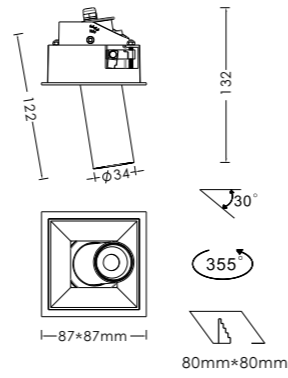

Reflector

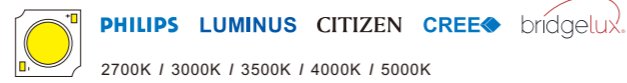

Angle

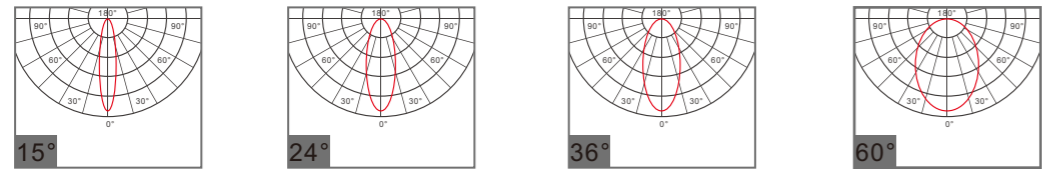

Code No.:DB004SA

Power	MAX 15W
Voltage	AC 220~240V
Current	350mA
Angle	15° 24° 36° 60°
Lumen	1140LM 1170M 1210LM 1260LM
CRI	90
IP	20/44
Installation	Embedded

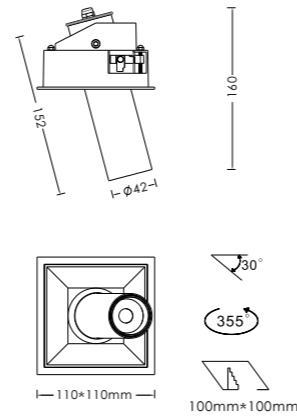

Reflector



Angle

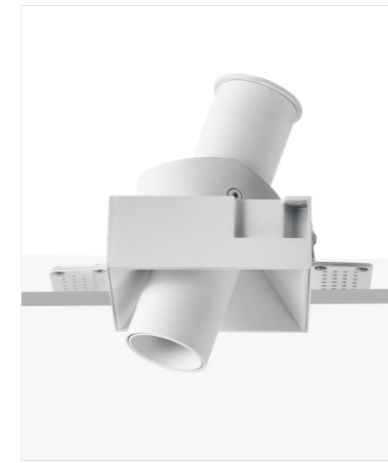
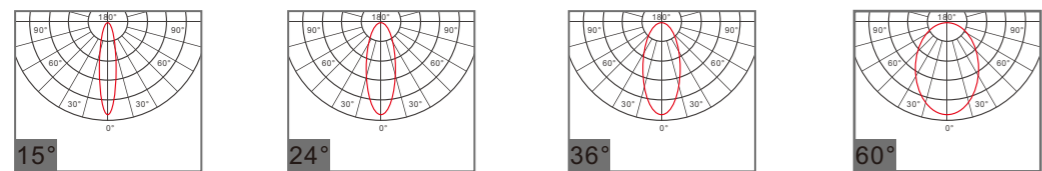

Code No.:DB003SNA

Power	MAX 12W
Voltage	AC 220~240V
Current	300mA
Angle	15° 24° 36° 60°
Lumen	916LM 925LM 953LM 987LM
CRI	90
IP	20/44
Installation	Embedded

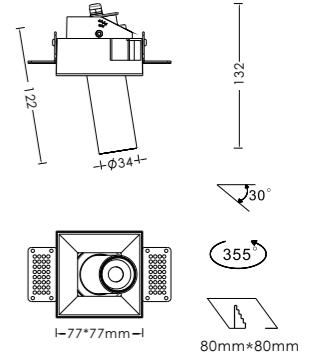

Reflector



Angle

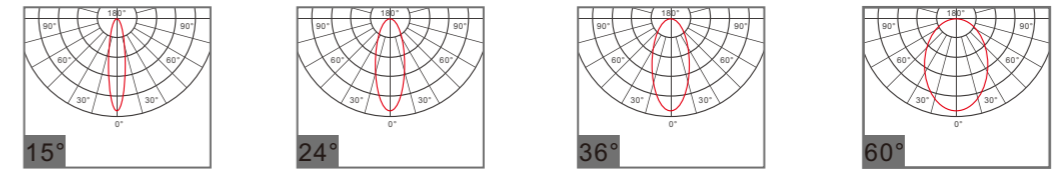

Code No.:DB004SNA

Power	MAX 15W
Voltage	AC 220~240V
Current	350mA
Angle	15° 24° 36° 60°
Lumen	1140LM 1170M 1210LM 1260LM
CRI	90
IP	20/44
Installation	Embedded

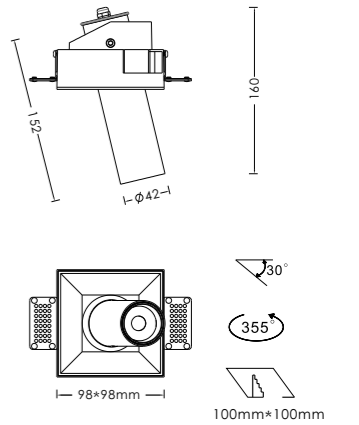
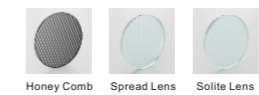

Reflector



Angle

