



# FÖHR Power Quality Analyzer



INSTRUCTION MANUAL

# Contents

1. Summary.....	1
2. Packing .....	7
3. Presentation .....	8
4. USE .....	14
5. Configuration Key .....	19
6. Waveform Capture Key .....	29
7. Harmonics Mode .....	36
8. Waveform Key .....	41
9. Alarm Mode Key .....	51
10. Trend Mode Key .....	54
11. Power And Energy Key .....	62
12. Screen Snapshot Key .....	67
13. Help Key.....	69
14. Data Uploaded To The Computer .....	69
15. General Specifications.....	70
16. Functional Characteristics .....	72
17. Appendices.....	75
18. Maintenance.....	83
19. Packing List.....	84
20. Precautions .....	84

# 1. Summary

## 1.1. Introduction

**FÖHR-5000 Power Quality Analyzer** is a comprehensive test instrument carefully developed by our company and specially designed for field test of three phases, multi-functional and intelligent, concise man-machine operation. It is easy to use, large LCD screen display, high resolution, interface in both Chinese and English, shock-proof shell structure and so on. Can simultaneously measure the 4-channel current (ABC three phase and neutral wire current), 4-channel voltage (ABC three-phase voltage and neutral line voltage to ground), the peak value of current voltage, maximum/minimum value over a period, three-phase imbalance factor, short-time voltage flicker, transformer K factor, active power, reactive power, apparent power, power factor and displacement power factor, active power, reactive power, apparent power, total harmonic distortion and harmonic, etc; Display real-time waveform, harmonic ratio bar charts of current voltage; Dynamically capture instantaneous change of voltage current, monitoring starting current, monitoring the power parameters and generate the alarm list, generate the trend chart for a long time record test data.

In the current power applications, more and more large power equipment, power grid fault have become more and more complex, with development of the industry, it put forward high request more and more to quality that electric energy. We provide this power quality analyzer for that, which you can troubleshoot of complex power system more quickly and accurate, and monitoring and maintenance of power quality parameters more comprehensive and systemic.

FÖHR-5000 Power quality analyser adopt DSP + ARM double processor architecture, DSP is use for data collection and the processing of algorithm, the ARM is use for the communication protocol and the man-machine interface processing; Analog signal acquisition is by 2 pieces AD7655 of ADI company. Resolution for AD7655 is 16 bit and it is 4 channel synchronous sampling. The highest sampling rate can reach 1 MSPS, to ensure the accuracy of the channel and the information integrity, and wouldn't miss any transient changes in the grid, can more accurate to detect the transient waveform rising and dropping drastically, and waveform instantaneous interrupt; DSP working frequency is over 200 MHZ, to be able to timely monitoring of the power grid and dynamically adjust the sampling frequency to realize synchronization of power frequency and sampling frequency; Using a 5.6 -inch LCD color screen display, a resolution of 640 dots x 480 dots, with different display color difference between the parameters of phase, waveform, vector diagram, harmonic ratio, the user can be more efficient and more intuitive understand the state of power grid parameters. Built-in flash memory can store 60 group of screenshots at the same time, 150 groups of capture transient voltage/current waveform figure, and 12800 groups of alarm list. Starting current detection model can continuously capture starting current waveform for 100 s. Built-in 2G memory card to store the trend curve record, simultaneous recording 20 parameters (can choose according to need) collect data for once every five seconds, trend curve records can be stored for 300 days.

Power Quality Analyser also named: Intelligent Three Phase Power Quality Analyser, Multifunctional Power Quality Analyser, which simultaneous with the functions of harmonic analyser, phase volt-ampere meter, electric parameter tester. It apply to electricity industry, petrochemical, metallurgy, railway, mining enterprises, scientific research institution, metrological department. Especially suitable for comprehensive analysis and diagnosis on all the voltage, current, power, power, harmonic, phase electric parameters.

## 1.2. Function

### 1.2.1. Basic function

- ★ Waveform real-time display (4 channels voltage/4 channels current).
- ★ True RMS values of voltages and currents.
- ★ The DC components of voltages.
- ★ Peak current and voltage values.
- ★ Minimum and maximum half-cycle RMS current and voltage values.
- ★ Phasor diagram display.
- ★ Measurement of each harmonic up to order 50.
- ★ Bar charts show harmonic ratios of current and voltage of each phase.
- ★ Total harmonic distortion (THD).
- ★ Active, reactive, apparent power, by phase and cumulative.
- ★ Active, reactive, apparent energy, by phase and cumulative.

- ★ Transformer K factor.
- ★ Power factors (PF) and displacement factors (DPF or  $\text{COS}\Phi$ ).
- ★ Short-term voltage flicker (PST).
- ★ Three phase unbalance(current and voltage).

### 1.2.2. Capture function

#### ◆Transient capture function

Monitoring instantaneous change of power grid voltage current parameters, including the voltage current fluctuations, voltage current surge, sag and short supply interruption, temporary overvoltage, impact current and Current voltage instantaneous distortion. Instruments can store 150 sets of transient waveform at the same time.

#### ◆Starting current monitoring

Monitoring surge current of line and the startup current when electrical equipment is starting, help to correctly design capacity. Can be display the RMS rising / falling curve In the startup process, the envelope curve of startup current, waveform of 4 channels current and 4 channels voltage. Recording about 100s after trigger, storage the current /voltage instantaneous and waveform curve of each cycle in 100s.

#### ◆ Trend chart recording and storing function

Store all the test parameters of basic test functions (Urms, Uthd, Ucf, Uunb, Hz, Vrms, Vthd, Vcf, Vunb, PST, Arms, Athd, Acf, Aunb, KFW, VAR, VA, PF,  $\text{COS}\phi$ ,  $\text{TAN}\phi$ ),50 voltage harmonics, 50 current harmonics. And create the trend curve. Record data for a long time according to need(concurrent selection 20 parameters to record data for once every five seconds, you can record about 300 days.).

#### ◆Alarm function

Set the limit values according to need, monitoring the values whether overshoot, if overshoot will generate an alarm log, such as: voltage, current, unbalance, harmonic ratio, frequency, active power, total harmonic distortion. You can configure 40 different alarms, each group can set different monitoring parameters (including 50 harmonics, total of 123 different parameters) and limit values, also can set the shortest time of overshoot. The log can contain up to 12,800 alarms.

#### ◆Snapshot function

Any screen can be saved (screen snapshot), at the same time automatically records the time and test mode. Such as can save voltage and current waveform, harmonic bar chart, phasor diagram etc. It can save a maximum of 60 screen snapshot.

### 1.2.3. Other functions

#### ◆Communication function

Communicate with computer via USB; Monitoring software can display waveform of power quality analysis, read of the transient waveform, trend chart recording, alarm log, screenshots, and display on the computer.

#### ◆Setting function

The user can configuration of the time and date, configuration of the screen contrast and brightness, definition of each phase curve colors'.

Choice of type of connection to the net work.

Configuration of the type of the current sensors and voltage ratios.

Select Chinese menu or English menu.

#### ◆Help menu in Chinese/English

Every stage of operation can press the "help" key to obtain relevant information.

### 1.3. Technical specification

#### 1.3.1. Base condition and working condition

Influence factor	Test item	Base condition	Working condition
Environment temperature	All parameters	(23±2)°C	-10°C~ 40°C
Relative humidity	All parameters	40%~ 60%	<80%
Phase-to-neutral voltage	All parameters	(100±1%)V	1.0V~ 1000V
Phase-to-phase voltage	True RMS phase-to-phase voltage	(200±1%)V	1.0V~ 2000V
Current	True RMS current	(5±1%)A	10mA~ 6000A
Network frequency	All parameters	50Hz±0.1Hz	40Hz~ 70Hz
Phase shift	Active power and active energy	Cosφ=1	Cosφ: 0.2~ 1.0
	Reactive power and reactive energy	Sinφ=1	Sinφ: 0.2~ 1.0
Harmonic	All parameters	<0.1%	0.0%~ 100%
Voltage unbalance	All parameters	<10%	0.0%~ 100%
Working voltage of device	All parameters	DC9.8V±0.1V	DC9.5V~ 10.5V
External electric field, magnetic field	All parameters	Should be avoided	
Test position	Measured related parameters of current	Tested wire at the center of clamp.	

#### 1.3.2. General specification

Power supply	Rechargeable lithium-ion battery pack 9.6V, backup charger.
Battery indicator	Battery symbol  shows dump energy. When the voltage is too low, automatic shutdown after the 1 minute.
Power consumption	Current consumption of normal test 490 mA, continuous working for 8 hours.
Display mode	LCD color screen, 640dots×480dots, 5.6 inches, display domain: 116mm×88mm.
Size of clamp	10A small sharp current clamp: 7.5mm×13mm; 100A circle current clamp: 35mm×40mm; 1000A circle current clamp: 68mm×68mm. 6000A Flexible Coil Current Sensor (with Integrator) : Φ300mm
Instrument dimensions	L×W×H: 240mm×170mm×68 mm.
Number of channels	4U/4I.
Phase-to phase voltage	1.0V~2000V.
Phase-to-neutral voltage	1.0V~1000V.
Current	10A current clamp: 10mA~10.0A;

	100A current clamp: 0.10A~100A; 1000A current clamp: 1.0A~1000A; 6000A Flexible Coil Current Sensor (with Integrator) : 10A ~ 6000A
<b>Frequency</b>	40Hz~70Hz.
<b>Parameters of electricity</b>	W, VA, Var, PF, DPF, $\cos\phi$ , $\tan\phi$ .
<b>Energy parameters</b>	Wh, Varh, Vah.
<b>Harmonic</b>	Order 0~50.
<b>Total harmonic distortion</b>	Order 0~50, each phase.
<b>Expert mode</b>	Yes.
<b>Number of Transient records</b>	150 sets.
<b>Voltage flicker</b>	Yes.
<b>Starting current mode</b>	Yes, 100 seconds.
<b>3 phases unbalance</b>	Yes.
<b>Record</b>	300 days(simultaneous recording 20 parameters, record one point every 5 seconds).
<b>Min/Max recorded value</b>	Measurement of maximum and minimum values over a period of time.
<b>Alarm</b>	40 different types of parameter selections, 12,800 sets alarm logs.
<b>Peak</b>	Yes.
<b>Phasor diagram display</b>	Automatically.
<b>Capacity of snapshots</b>	60.
<b>Menu language</b>	English/Chinese.
<b>Communication</b>	USB.
<b>Automatic switching off</b>	When an alarm campaign is initiated or a search for transients, an inrush current capture, or a trend recording is pending or in progress, the device is not automatic switching off. In other test mode, 15 minutes without keystrokes, automatic shutdown after prompt 1 minute.
<b>Backlight function</b>	Yes, suitable for use at night and dark place.
<b>Weight</b>	Host: 1.6kg (with battery). 10A small sharp current clamp: 170g×4; 100A circle current clamp: 190g×4; 1000A circle current clamp: 510g×4; 6000A Flexible Coil Current Sensor (with Integrator) : 330g×4; Test wires and power adapter: 900g; Total weight: about 9.2kg (with packaging).
<b>Length of voltage test wire</b>	3m.
<b>Length of current sensor wire</b>	2m.
<b>Working temperature and humidity</b>	-10°C~40°C; below 80%Rh.
<b>Storage temperature and</b>	-10°C~60°C; below 70%Rh.

<b>humidity</b>	
<b>Input impedance</b>	Input impedance of test voltage: 1MΩ.
<b>Withstand voltage</b>	Withstand 3700V/50Hz sinusoidal AC voltage for 1 minute between instrument wiring and shell.
<b>Insulation</b>	Between instrument wiring and shell $\geq 10M\Omega$ .
<b>Structure</b>	Double insulation, with insulation vibration-proof sheath.
<b>Safely rules</b>	IEC 61010 1000V Cat III / 600V CAT IV, IEC61010-031, IEC61326, Pollution degree: 2.

### 1.3.3. Instrument precision (excluding the current sensor)

Respectively introduce the following data (on the basic of base conditions and the ideal current sensors, perfectly linear, no phase shift).

Measurement	Range	Display resolution	The maximum error in the range of the reference
<b>Frequency</b>	40Hz~ 70Hz	0.01Hz	$\pm(0.03)\text{Hz}$
<b>True RMS phase-to-neutral voltage</b>	1.0V~ 1000V	Min resolution 0.1V	$\pm(0.5\%+5\text{dgt})$
<b>True RMS phase-to-phase voltage</b>	1.0V~ 2000V	Min resolution 0.1V	$\pm(0.5\%+5\text{dgt})$
<b>DC voltage</b>	1.0V~ 1000V	Min resolution 0.1V	$\pm(1.0\%+5\text{dgt})$
<b>True RMS current</b>	10mA~ 1000A	Min resolution 1mA	$\pm(0.5\%+5\text{dgt})$
<b>Peak of phase-to-neutral voltage</b>	1.0V~ 1414V	Min resolution 0.1V	$\pm(1.0\%+5\text{dgt})$
<b>Peak of phase-to-phase voltage</b>	1.0V~ 2828V	Min resolution 0.1V	$\pm(1.0\%+5\text{dgt})$
<b>Current peak</b>	10mA~ 1414A	Min resolution 1mA	$\pm(1.0\%+5\text{dgt})$
<b>Peak factor</b>	1.00~ 3.99	0.01	$\pm(1\%+2\text{dgt})$
	4.00~ 9.99	0.01	$\pm(5\%+2\text{dgt})$
<b>Active power</b>	0.000W~ 9999.9kW	Min resolution 0.001W	$\pm(1\%+3\text{dgt})$ $\text{Cos}\phi \geq 0.8$
			$\pm(1.5\%+10\text{dgt})$ $0.2 \leq \text{Cos}\phi < 0.8$
<b>Reactive power, inductive or capacitive</b>	0.000VAR~ 9999.9kVAR	Min resolution 0.001VAR	$\pm(1\%+3\text{dgt})$ $\text{Sin}\phi \geq 0.5$
			$\pm(1.5\%+10\text{dgt})$ $0.2 \leq \text{Sin}\phi < 0.5$
<b>Apparent power</b>	0.000VA~ 9999.9kVA	Min resolution 0.001VA	$\pm(1\%+3\text{dgt})$
<b>Power factor</b>	-1.000~ 1.000	0.001	$\pm(1.5\%+3\text{dgt})$ $\text{Cos}\phi \geq 0.5$
			$\pm(1.5\%+10\text{dgt})$

			$0.2 \leq \cos\phi < 0.5$
<b>Active energy</b>	0.000Wh~ 9999.9MWh	Min resolution 0.001Wh	$\pm(1\%+3\text{dgt})$ $\cos\phi \geq 0.8$
			$\pm(1.5\%+10\text{dgt})$ $0.2 \leq \cos\phi < 0.8$
<b>Reactive energy, inductive or capacitive</b>	0.000VARh~ 9999.9MVARh	Min resolution 0.001VARh	$\pm(1\%+3\text{dgt})$ $\sin\phi \geq 0.5$
			$\pm(1.5\%+10\text{dgt})$ $0.2 \leq \sin\phi < 0.5$
<b>Papparent energy</b>	0.000VAh~ 9999.9MVAh	Min resolution 0.001VAh	$\pm(1\%+3\text{dgt})$
<b>Phase angle</b>	-179°~ 180°	1°	$\pm(2^\circ)$
<b>Tan<math>\phi</math> (VA<math>\geq</math>50VA)</b>	-32.76~ 32.76	Min resolution 0.001	$\phi: \pm(1^\circ)$
<b>Phase shift of power factor (DPF)</b>	-1.000~ 1.000	0.001	$\phi: \pm(1^\circ)$
<b>Harmonic ratio (order 1 to 50) (Vrms&gt;50V)</b>	0.0%~ 99.9%	0.1%	$\pm(1\%+5\text{dgt})$
<b>Harmonic angle (Vrms&gt;50V)</b>	-179°~ 180°	1°	$\pm(3^\circ)$ harmonics of order 1 to 25
			$\pm(10^\circ)$ harmonics of order 26 to 50
<b>Total harmonic ratio (THD or THD-F)<math>\leq</math>50</b>	0.0%~ 99.9%	0.1%	$\pm(1\%+5\text{dgt})$
<b>Distortion factor (DF or THD-R)<math>\leq</math>50</b>	0.0%~ 99.9%	0.1%	$\pm(1\%+10\text{dgt})$
<b>Transformer K factor</b>	1.00~ 99.99	0.01	$\pm(5\%)$
<b>3 phases unbalance</b>	0.0%~ 100%	0.1%	$\pm(1\%)$

#### 1.3.4. Current sensor character

Type of current sensor	True RMS current	Max error of true RMS current	Max error of phase angle $\phi$
<b>10A current clamp</b>	10mA~ 99mA	$\pm(1\%+3\text{dgt})$	$\pm(1.5^\circ)$ , Arms $\geq$ 20mA
	100mA~ 10.0A	$\pm(1\%+3\text{dgt})$	$\pm(1^\circ)$
<b>100A current clamp</b>	0.10A~ 0.99A	$\pm(1\%+3\text{dgt})$	$\pm(1.5^\circ)$
	1.00A~ 100A	$\pm(1\%+3\text{dgt})$	$\pm(1^\circ)$
<b>1000A current clamp</b>	1.0A~ 9.9A	$\pm(2\%+3\text{dgt})$	$\pm(3^\circ)$
	10.0A~ 1000A	$\pm(2\%+3\text{dgt})$	$\pm(2^\circ)$

<b>6000A Flexible Coil Current Sensor (with Integrator)</b>	10A~99A	$\pm(1\% + 3\text{dgt})$	$\pm(3^\circ)$
	100A~6000A	$\pm(1\% + 3\text{dgt})$	$\pm(2^\circ)$

**Note:** current clamp and instruments must be connected to the corresponding, cannot be inserted opposite.

- ★ The side of current clamp marks L1, L2, L3, N/D or has red dot is the current noninverting input, that is homonymous end.
- ★ The side of 10A current clamp has red dot is the current noninverting input, that is homonymous end.
- ★ The side of 100A, 1000A current clamp without screws is the current noninverting input, that is homonymous end.
- ★ 6000A flexible coil current sensor to lock the logo "  " side of the current input to the same side, that is, the same name.

## 2. Packing

### 2.1. Standard configuration

No.	Designation	Quantity
1	Instrument host.	1
2	Instrument knapsack.	1
3	Current sensors ( Optional)	12 (3 kinds)
4	6000A Flexible Coil Current Sensors (with Integrator) ( Optional)	4
5	Testing wires.	5 (yellow, green, red, blue, black)
6	Crocodile clips.	5
7	Test probe.	5
8	Dedicated power adapter.	1
9	USB data cord.	1
10	Software CD.	1
11	Lithium battery pack.	1(Built into the instrument)
12	2GB memory.	1(Plug in the instrument)
13	Manual, warranty card, certification.	1

### 2.2. Weight

No.	Designation	Weight
1	Instrument host.	1.6Kg (with battery).
2	10A small sharp current clamp. ( Optional)	170g×4.
3	100A circle current clamp. ( Optional)	190g×4.
4	1000A circle current clamp. ( Optional)	510g×4.
5	6000A Flexible Coil Current Sensor (with Integrator) ( Optional)	330g×4.
6	Test wires and power adapter.	900g.
7	Total weight.	9.2kg (with packaging).



Figure 2-1: The total package diagram

### 3. Presentation

#### 3.1. Overall view



Figure 3-1: Overall view of the device

### 3.2. On/Off key

Pressing the  starts the device.

The device can be powered by the battery alone (if it is adequately charged) or by a specific mains power supply unit (if, in this case, the battery is also present, the power supply unit charge it).

Pressing the  key again turns the device off. Confirmation is required to turn it off if the device is in one of its recording modes or is searching for transients, alarm, and/or inrush current capture.

### 3.3. Display screen

#### 3.3.1. Presentation

This backlit 640×480 pixel graphic liquid crystal screen displays all measurement with their curves, the parameters of the unit, the curves selected, the instantaneous values of the signals, and the type of measurement selected. When the device powered up, it automatically displays the *Waveform screen*. Information about this screen can be found in §8.

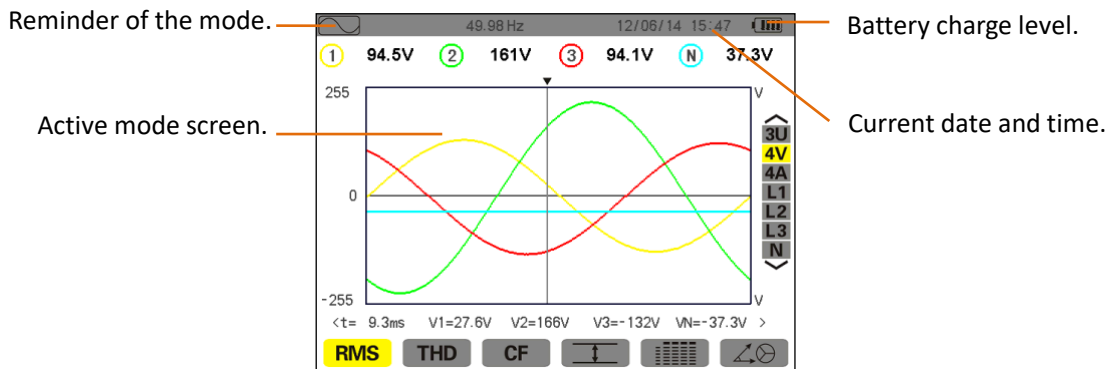











Figure 3-2: Example of a display screen

#### Automatic switching off:

When an alarm campaign is initiated or a search for transients, an inrush current capture, or a trend recording is pending or in progress, the device is not automatic switching off. In other test mode, 15 minutes without keystrokes, automatic switching off after prompt 1 minute.

#### 3.3.2. Icons

The display uses the following icons:

Icon	Designation	Icons	Designation
V	Phase -to-neutral voltage.		Display of voltage and current RMS values and their extrema.
U	Phase-to-phase voltage.		Simultaneous display of all voltage and current measurements.
A	Current.		Display of voltage and current vector diagram.
VA	Apparent power.		Energies consumed.
	Zoom in.		Energies generated.
	Zoom out.		Page screen 1 of the help function.
▼	The X axis cursor indicator.		Page screen 2 of the help function.

<b>PF...</b>	Display of PF, DPF, Tanφ.		Page screen 3 of the help function.
<b>W...</b>	Display of powers and energies values.		The monitoring parameter of group 1 in the trend mode.
	Start Record.		The monitoring parameter of group 2 in the trend mode.
	Recording list.		The monitoring parameter of group 3 in the trend mode.
<b>OK</b>	Validation prompt.		The monitoring parameter of group 4 in the trend mode.
	Shut down.		Previous page screen.
	Delete.		Next page screen.

### 3.4. Keypad keys

#### 3.4.1. Function keys(yellow keys)

These 6 keys **F1**, **F2**, **F3**, **F4**, **F5**, **F6** activate the function or tool represented by the corresponding icon on the screen.

#### 3.4.2. Navigation keys

A block of 4 arrow keys, a confirm key and a return key are used for navigation in the menus.

Item	Function
	Up direction or zoom in key.
	Down direction or zoom out key.
	Right direction or next page key.
	Left direction or previous page key.
	Confirms the selection.
	Return key.

#### 3.4.3. Mode keys



These give access to specific modes:

Item	Function	Voir
	Waveform mode: display of voltage and current waveforms, maxima and minima, extreme value, summary tables, voltage and current vector diagrams.	§ 8
	Harmonic mode: display of voltage, current, and apparent power harmonic ratios (displayed in a graph), harmonic RMS value, phase shift with respect to the fundamental.	§ 7
	Power and energy mode: displays the active power, the reactive power, the apparent power, power factor, phase shift of power factor, etc.	§11
	Trend mode: recording of the parameters selected in the <i>Configuration</i> menu.	§10
	Alarm mode: listing of recorded alarms exceeding the thresholds programmed in the configuration; recording of network blackouts with half-cycle resolution ( $V_{rms}$ , $A_{rms}$ , $U_{rms}$ ), determination of energy consumption overshoots, monitoring of compliance with a power supply	§9

	quality contract.	
	Capture mode: monitoring instantaneous change of power grid voltage current parameters, including the voltage current fluctuations, voltage current surge, sag and short supply interruption, temporary overvoltage, impact current and current voltage instantaneous distortion.	§ 6

### 3.4.4. Other keys

The other keys have the following functions:

Item	Function	Voir
	Configuration key: device configuration and capture mode parameter configuration, can setting date and time, display, type of connection to the network, voltage ratio, current sensor select, choice of thresholds to be detected, definition of alarms to be detected, choice of parameters to be detected.	§5
	Snapshot mode: snapshot of current screen and retrieval of screens already stored.	§12
	Help key: provides information about the functions and the symbols used for the current display mode.	§13

## 3.5. Connectors

### 3.5.1. Measurement input connectors

Located on the top of the device, these connectors are distributed as follows:



Figure 3-3: Connectors on the top of device



### 3.5.2. Charging interface and USB interface

Must be used with a special power adapter and USB cable.

## 3.6. Power supply

### 3.6.1. Indication of battery level

The battery icon in the top right corner of the screen shows the battery level. The number of bars proportional to the charge level.

Icon	State of charge
	Battery fully charged.
	Low battery.
	Mobile bars: battery charging.



The device is powered by mains and pre-charged.

When the battery level is too low, the following message is displayed: "Low battery, Instrument will soon turn OFF". If you do not reconnect the device to mains, it is switched off one minute after this message appears.

### 3.6.2. Battery life

Battery life is 8 hours when the battery delivered with the device is fully charged.

### 3.6.3. Recharging the battery

The battery is recharged by the mains power unit provided, connected to the device by the jack (Figure 3-3).

Use only the mains power unit provided with the instrument.

Charging a fully discharged battery takes about 5 hours. When the battery is recharged, the device continues to use mains power and does not discharge the battery.

### 3.6.4. The battery

The device is powered by a specific lithium battery (9.6V) having a nominal capacity of 4,500 mAh.

### 3.6.5. Mains operation

The battery is not essential when the unit is running on mains power. However, if mains power is cut off (there is no battery), during the recording process, for example, data may be lost.

### 3.7. The stand

A retractable stand (Figure 3-4) on the back of the instrument keeps the device at an angle of 60° from the horizontal.



Figure 3-4: Battery compartment cover

## 3.8. Summary of functions

### 3.8.1. Measurement functions

- The RMS values of AC voltages up to 1000 V between terminals.
- The RMS values of AC currents up to 1000A (neutral included).
- Sustaining voltages and currents (neutral included).
- Minimum and maximum half-cycle RMS voltage and current.
- Peak voltages and currents (neutral included).
- Frequency of 50 Hz and 60 Hz networks.
- Current and voltage peak factor (excluding neutral).
- Calculation of the K factor (KF) (application to transformers when current harmonics are present).
- Current and voltage distortion factor (DF) (excluding neutral).
- Current and voltage total harmonic distortion (excluding neutral).
- Active, reactive (capacitive and inductive), apparent power of each phase (excluding neutral).
- Power factors (PF) and displacement power factors (DPF) (excluding neutral).
- Short-term flicker (PST) (excluding neutral).
- Active, reactive (capacitive and inductive), and apparent energy (excluding neutral).
- Current and voltage harmonics (excluding neutral) up to order 50: harmonic ratio, RMS value, minimum and

maximum, and sequence harmonics.

- Apparent power of each harmonic up to order 50: harmonic ratio, RMS value, minimum and maximum.
- The motor starting current and inrush currents.

### 3.8.2. Main functions

- Display of waveforms (voltages and currents).
- Inrush Current function: displays parameters useful for study of the starting of a motor.
  - ★ Instantaneous current at the instant designated by the cursor.
  - ★ Maximum instantaneous current (over the entire starting time).
  - ★ RMS value of the half-cycle of the current on which the cursor is positioned.
  - ★ Maximum half-cycle RMS current (over the entire starting time).
  - ★ Time at which starting of motor commenced.
- Screen captures (60 maximum).
- Transients function. Detection and recording of transients (up to 150) between user-defined start and stop dates and times. Recording of 4 complete cycles (one before the triggering event and three after).
- Trend recording function (2GB memory with date-stamping and user-defined start and stop dates for recording, with a maximum of 100 recordings). Display, in bar chart or curve form, of the means of many parameters vs. time, with or without minima and maxima.
- Alarm function. List of recorded alarms (up to 12,800) exceeding thresholds defined in the configuration menu. User-defined alarm monitoring start and stop times. Display the alarm trigger channel, minimum and maximum values after trigger, duration.

### 3.8.3. Configuration function

- Date and time settings.
- Screen brightness and contrast settings.
- Choice of curve colours.
- Choice of reactive power and reactive energy calculation mode (with or without harmonics).
- Choice of connection (single-phase, split-phase, 3- or 4-wire three-phase, 5-wire three-phase).
- Choose current sensors and voltage ratio.
- Trigger threshold values setting (voltage and current).
- Monitoring parameters of trend diagram settings.
- Choice of alarm monitoring parameters.
- Erasure of data (total or partial).
- Display of software and hardware version numbers.
- Choice of language (Chinese/English).

## 3.9. Abbreviations

Meanings of the symbols and abbreviations used:

Symbol	Designation	Symbol	Designation
$\approx$	AC and DC components.	<b>MAX</b>	Maximum true RMS.
$\sim$	AC component only.	<b>MIN</b>	Minimum true RMS.
$\equiv$	DC component only.	<b>ms</b>	Millisecond (unit).
$\phi$	Phase angle.	<b>PEAK</b>	Maximum (+) or minimum(-) voltage /current peak.
$\overline{W}$	Inductive phase shift.	<b>PF</b>	Power factor.
$\underline{W}$	Capacitive phase shift.	<b>PST</b>	Short-term flicker.
$^{\circ}$	Degree.	<b>RMS</b>	True RMS value (current or voltage).
-.+	Expert mode.	<b>t</b>	Time.
$\Sigma$	Sum of values.	<b>Tan</b>	Tangent.
<b>L</b>	Phase (line).	<b>THD</b>	Total harmonic distortion.

<b>%</b>	Percentage.	<b>Ucf</b>	Phase-to-phase voltage crest factor.
<b>A</b>	Ampere.	<b>Uh</b>	Phase-to-phase voltage harmonic.
<b>Acf</b>	Crest (peak) factor of current.	<b>Urms</b>	True RMS phase-to-phase voltage.
<b>Ah</b>	Current harmonic.	<b>Uthd</b>	Total phase-to-phase voltage harmonic distortion.
<b>Akf</b>	K Factor (for transformers).	<b>Uunb</b>	Phase-to-phase voltage unbalance (3 $\phi$ ).
<b>Arms</b>	True RMS current.	<b>V</b>	Phase-to-neutral voltage.
<b>Athd</b>	Total harmonic distortion of current.	<b>VA</b>	Apparent power.
<b>Aunb</b>	Current unbalance (3 $\phi$ ).	<b>Vah</b>	Apparent energy.
<b>AVG</b>	Mean value.	<b>VAR</b>	Reactive power.
<b>CF</b>	Peak factor (current or voltage).	<b>VARh</b>	Reactive energy.
<b>DC</b>	DC component (current or voltage).	<b>Vcf</b>	Voltage crest (peak) factor.
<b>DPF</b>	Displacement power factor.	<b>Vrms</b>	True RMS phase-to-neutral voltage.
<b>Hz</b>	Frequency of network studied.	<b>Vthd</b>	Total harmonic distortion of phase-to-neutral voltage.
<b>KF</b>	See Akf.	<b>Vunb</b>	Phase-to-neutral voltage unbalance (3 $\phi$ ).
<b>W</b>	Active power.	<b>Wh</b>	Active energy.

## 4. USE

The device must be configured in accordance with §5 before any measurements are made.

The following precautions for use must be complied with:

- Do not connect to any voltage exceeding 1,000 Vrms with respect to earth.
- When connecting and disconnecting the battery, make sure that the measuring leads are disconnected and turn off.

### 4.1. Start-up

Press the  key on the keypad to start the device.

After about 3 seconds, the *Waveform screen* is displayed.

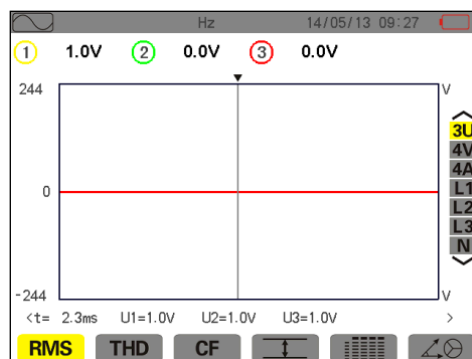





Figure 4-1: Waveform screen

The device is battery powered only if the battery is adequately charged. If not, the alarm message "Low battery, Instrument will soon turn OFF" is displayed (see § 3.6). The device can be used with the mains power unit supplied with it connected to the jack; there is no need of the battery in this case.

## 4.2. Configuration

To configure the device, proceed as follows:

★With the device on, press .The configuration screen appears.

★Press  or  to select the parameter to be modified. Press  to enter the selected sub-menu.

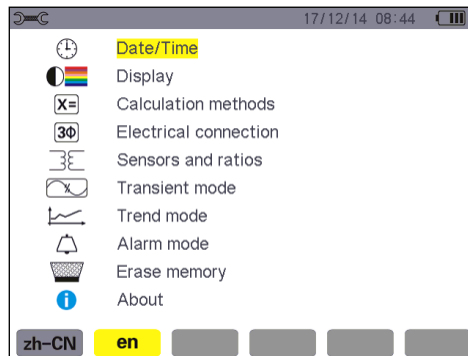







Figure 4-2: Configuration screen

Press  or  and  or  to browse and  to confirm in the displayed sub-menu. See §5.3–§ 5.10 for details.

**Note:** The following points must be checked or adapted for each measurement:

Function	See
Define the parameters of the calculation methods.(reactive power/ reactive energy).	§5.5
Select the type of connection (single- phase to three-phase, five-wire).	§5.6
Programming of the voltage ratios according to the type of current sensor connected.	§5.7
Transient triggering levels (transients mode).	§5.8
Values to be recorded (trend mode).	§5.9
Definition of alarm thresholds.	§5.10

Press  to return to the *Configuration* screen.

## 4.3. Installation of leads

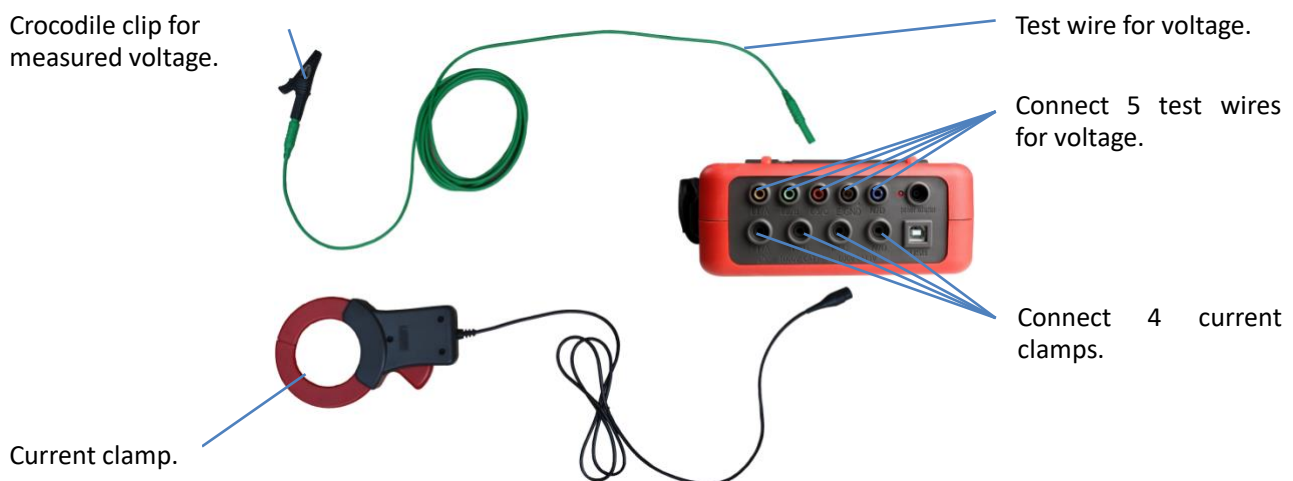

Figure 4-3 test connection on the top of device

Connect the measuring leads to the device as follows:

- Current measurement 4 current clamp corresponding connect to 4 channels current interfaces of L1/A, L2/B, L3/C, N/D. Current clamp muse corresponding connection to ensure the accuracy measurement. Select current clamp before measurement (see § 5.7).
- Voltage measurement: The 5 voltage test wires according to the color corresponding connect to 5 voltage input interfaces of L1/A, L2/B, L3/C, E/GND, N/D. Set the voltage ratio before measurement.(see § 5.7).

The measuring leads must be connected to the circuit to be studied as shown by the following diagrams.

#### 4.3.1. Single-phase network

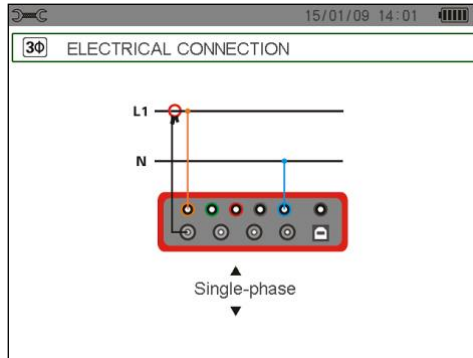

Figure 4-4: Single-phase connection

#### 4.3.2. Split-phase network

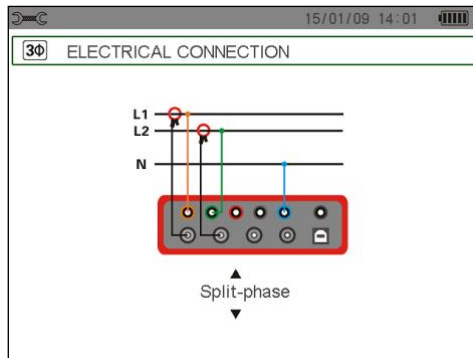

Figure 4-5: Split-phase connection

#### 4.3.3. 3- or 4-wire three-phase network

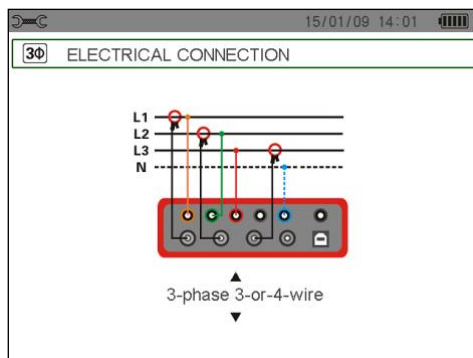

Figure 4-6: 3- or 4-wire three-phase connection

#### 4.3.4. 5-wire three-phase network

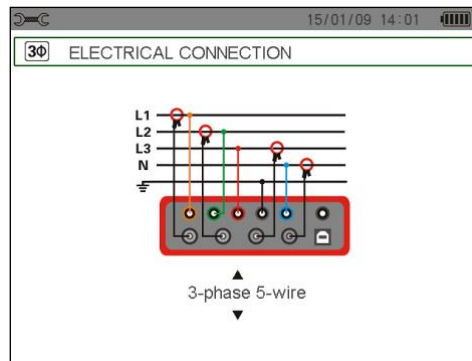



Figure 4-7: 5-wire three-phase connection

#### 4.3.5. Connection procedure

- ★ Switch the instrument on.
- ★ Configure voltage ratio, select current sensor and the type of network concerned.
- ★ Connect the leads and current sensors to the unit.
- ★ Connect the earth and/or neutral lead to the network earth and/or neutral (when distributed) and connect the corresponding current sensor.
- ★ Connect the L1 phase lead to the network L1 phase and connect the corresponding current sensor.
- ★ If applicable, repeat the procedure for phases L2, L3.

**Note:** complying with this procedure reduces connection errors to a minimum and avoids wasting time.

#### 4.4. Waveform capture

**Reminder:** any screen can be saved (screen snapshot) by pressing the  key (see § 12).

With the device powered up and connected to the network (voltage measurement leads and current sensor), press .

##### 4.4.1. Display of the transients mode

See §6.2.

##### 4.4.2. Display of the inrush current mode

See §6.3.

#### 4.5. Display of harmonics

**Reminder:** any screen can be saved (screen snapshot) by pressing the  key (see § 12).

With the device powered up and connected to the network (voltage measurement leads and current sensor), press .

##### 4.5.1. Voltage harmonics display

See §7.2.

##### 4.5.2. Current harmonics display

See §7.3.

#### 4.6. Waveform measurements

**Reminder:** any screen can be saved (screen snapshot) by pressing the  key (see § 12).

With the device powered up and connected to the network (voltage measurement leads and current sensor), press .

#### 4.6.1. Display of true RMS measurements

See §8.2.

#### 4.6.2. Display of measurement of total harmonic distortion

See §8.3.

#### 4.6.3. Display of PEAK factor measurements

See §8.4.

#### 4.6.4. Display of Min and Max RMS, extreme values (voltage and current)

See §8.5.

#### 4.6.5. Simultaneous display

See §8.6.

#### 4.6.6. Display of vector diagram

See §8.7.

### 4.7. Alarm recording

**Reminder:** any screen can be saved (screen snapshot) by pressing the  key (see § 12).

With the device powered up and connected to the network (voltage measurement leads and current sensors), press .

#### 4.7.1. Configuration of alarm mode

Configure the values to be monitored as described in §9.2.

#### 4.7.2 Programming of an alarm campaign

See §9.3, configure start and stop time.

#### 4.7.3. Auto stoppage

The alarm recording campaign is stopped automatically at the *Stop* date and time programmed by the operator.

#### 4.7.4. Manual stoppage

See §9.3.3. Do not reach the preset stop date and time, operator to stop detection active.

#### 4.7.5. Viewing the alarm log

See §9.4.

#### 4.7.6. Deleting the alarm log

See §9.5.

### 4.8 Trend recording

**Reminder:** any screen can be saved (screen snapshot) by pressing the  key (see § 12).

With the device powered up and connected to the network (voltage measurement leads and current sensors), press .

#### 4.8.1. Configuring a trend parameter

See § 10.3.

#### 4.8.2 Programming a recording

See § 10.2.

## 4.9. Energy measurements

**Reminder:** any screen can be saved (screen snapshot) by pressing the  key (see § 12).

With the device powered up and connected to the network (voltage measurement leads and current sensors), press .

### 4.9.1. Measurement of energies consumed

See §11.2.

### 4.9.2. Measurement of energies generated

See §11.6.

## 4.10. Transfer of data to the PC

The PC software can communicate with the device through USB interface. Upload and storage the measurements for future reference.

**Note:** The transfer does not delete the data, just copy to the PC. When an alarm campaign is initiated or a search for transients, an inrush current capture, or a trend recording is pending or in progress, PC cannot read the data.

## 4.11. Deleting data

Stored data may be deleted prior to a new test campaign, to free memory. See §5.11.

## 4.12. Turning off

Press the  key to turn the device off.

When an alarm campaign is initiated or a search for transients, an inrush current capture, or a trend recording is pending or in progress, the device is not automatic switching off without confirmation. The following message appears:

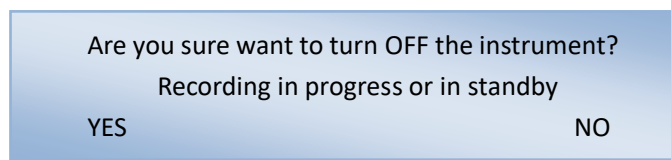

Select **Yes** or **No** using the  or  key and press  to validate.

★ If **No** is selected, recording will continue.

★ If **Yes** is selected, the data recorded until that point are saved and the device is turned off.

## 4.13. Power supply

### 4.13.1. Recharging the battery

See §3.6.3.





### 4.13.2. Mains operation

See §3.6.5.

# 5. Configuration Key

The  key is used to configure the device. Before using the instrument, and thereafter as necessary, you must parameterize it. The stored configuration is retained when the instrument is switched off.

### 5.1. Available sub- menus

Select the sub-menu using the  and  keys and confirm by pressing . To return to the main screen, press .

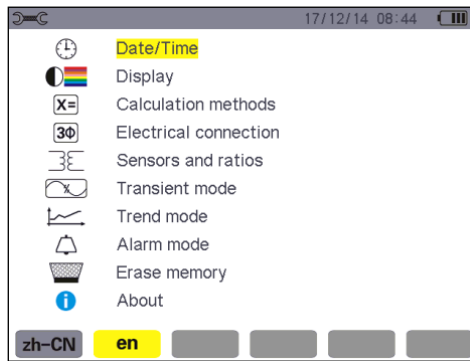



Figure 5-1: The sub-menu display screen

Name	Sub-menu	See
<b>Date/Time</b>	Date and time settings.	§5.3
<b>Display</b>	Screen contrast and brightness settings.	§5.4.1
	Definition of voltage curve and current curve colours.	§5.4.2
<b>Calculation method</b>	Choice of reactive parameters (with or without harmonics).	§5.5
<b>Connection</b>	Choice of type of connection to the network (attention: some calculations depend upon the type of connection).	§5.6
<b>Sensor and ratios</b>	Configuration of the ratios of the current sensors (10A current clamp, 100A current clamp, 1000A current clamp, transformer).	§5.7.1
	Configuration of voltage ratios.	§5.7.2
<b>Transient mode</b>	Choice of current thresholds to be detected.	§5.8.1
	Choice of voltage thresholds to be detected.	§5.8.2
<b>Trend mode</b>	Choice of parameters to be recorded for  .	§5.9
<b>Alarm Mode</b>	Definition of alarms to be detected.	§5.10
<b>Erase data</b>	Choice of total or partial deletion of user data.	§5.11
<b>About</b>	Serial number, software and hardware version numbers, and capacity of on-board memory card.	§5.12

### 5.2. Display language

To select the display language, press the yellow key under the corresponding icon on the screen (Figure 5-1). Select **zh-CN** is Chinese, choose **en** is English. Yellow icon indicates the current use language.

### 5.3. Date/Time

This menu defines the system date and time. The display is as follows:

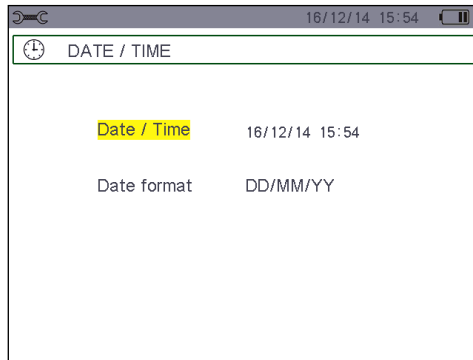

Figure 5-2: Date/Time menu

The Date/Time field is highlighted in yellow.

- To change the date/time, press . The arrows show which value can be changed. To increment or decrement a value, press or .
- To select the value, press or . To confirm, press .
- To modify the dating system, position the yellow cursor on the field using the or key. Press . The arrows show which value can be changed. Select DD/MM/YY or MM/DD/YY or YY/MM/DD, press or , then confirm by pressing .

To return to the *Configuration* main menu, press .

## 5.4. Display

### 5.4.1. Contrast/Brightness

This menu is used to define the contrast and brightness of the display unit. The display is as follows:

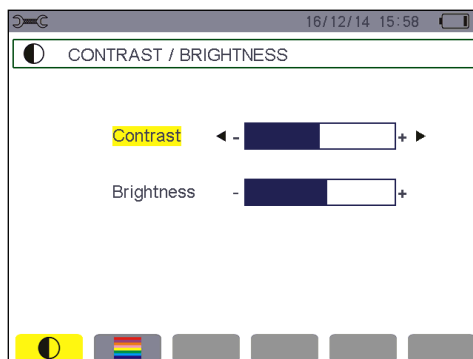

Figure 5-3: The Contrast/Brightness menu

The selected field is highlighted in yellow.

- To modify the contrast, press or .
- To move to the next field, press or .
- To change the brightness, press or .

To return to the *Configuration* menu, press .

### 5.4.2. Colours

The menu is used to define the colours of the voltage and current curves. The colours available are: yellow, orange, red, pink, brown, green, dark green, wathet blue, sky blue, dark blue, light grey, grey.

The display is as follows:

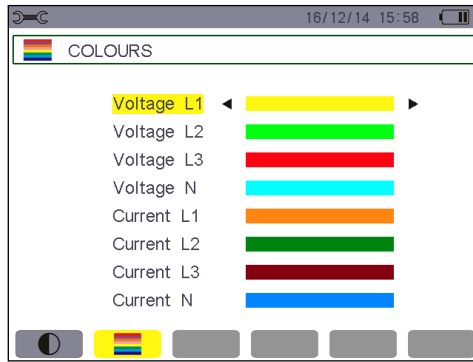

Figure 5-4: The Colours menu

The selected field is highlighted in yellow.

- To select the colour of the voltage and current curves, press ◀ or ▶.
- To move to the next field, press ▲ or ▼.

To return to the *Configuration* menu, press ↵.

### 5.5. Calculation methods

[X=] determines whether or not harmonics are used in calculating the reactive parameters (powers and energies).

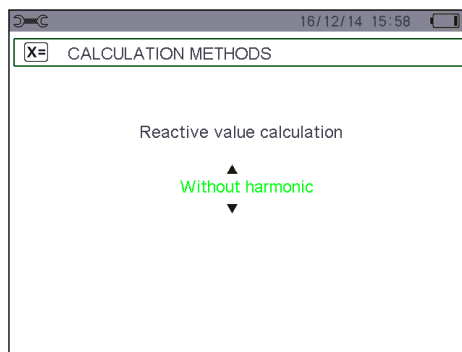

Figure 5-5: The Calculation methods menu

- To select *With harmonics* or *Without harmonics*, press ▲ or ▼.
  - ★ *With harmonics*: harmonics are taken into account when calculating reactive quantities.
  - ★ *Without harmonics*: only the fundamental is used in calculations of the reactive quantities.

To return to the *Configuration* menu, press ↵.

### 5.6. Connection

The [3Φ] menu is used to define how the device is connected, according to the type of network.

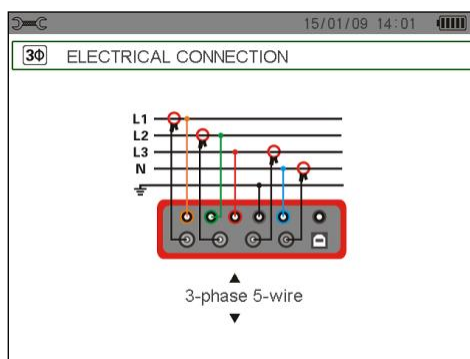

Figure 5-6: The Connection menu

Several electrical diagrams can be selected:



Figure 5-7: four type can be selected

To configure the type of connection, proceed as follows:

- Select *Single-Phase, Two-Phase, 3- or 4-wire Three-Phase, or 5-wire Three-Phase* by pressing or .

To return to the *Configuration* menu, press .

## 5.7. Sensors and ratios

### 5.7.1. Current sensors and ratios

The menu, invoked by the yellow key **A** icon, defines the current sensors and ratios. The device can select 3 current sensors, meanwhile, it can choose optional current transformer, and set the turns ratio according need.

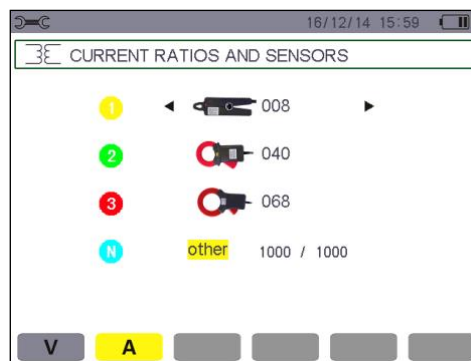

Figure 5-8: Current clamp and ratios screen in the Sensors and ratios menu

The possibilities are:

	10A current clamp: 10mA~ 10A
	100A current clamp: 0.10A~ 100A
	1000A current clamp: 1.0A~ 1000A
	6000A Flexible Coil Current Sensor (with Integrator) : 10A ~ 6000A

If use the optional current transformer, should be configuration as follows:

- Set transformer turns ratio:  
Into ratio setting, press .  
To select each field, use the or , To modify the turns ratio, use the or , (such as 2000/0001, device input 25mA, display 50.0A).
- To validate, press .

**Note:** selecting optional transformer, device current port forbidden input more than 500mA.

### 5.7.2. Voltage ratios

The  menu, invoked by the **V** icon, defines the voltage ratios.

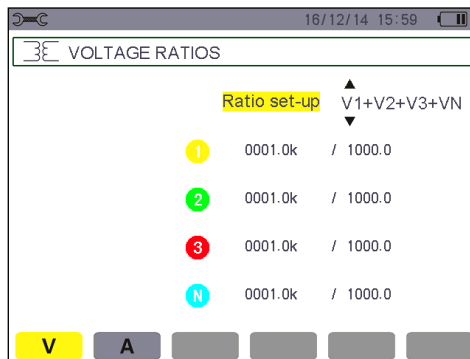

















Figure 5-9: The Voltage Ratios screen in the Sensors and ratios menu

All the channels ratio can be set as the following:

- (4V, 1/1) 4 channels are 1:1 ratio.
  - (4V) 4 channels are the same ratio.
  - (3V+VN)L1\L2\L3 is the same ratio, N line independent setting ratio.
  - (V1+V2+V3+VN)4 channels independent setting ratio respectively.
- ★ To configure the ratios, press , then use the  or  key and validate by pressing .
  - ★ To select the values, use the  or  key (highlighted in yellow).
  - ★ To setting the ratio, press , The arrows   appear.
  - ★ To select the value, press  or . To increment or decrement a value, press  or , then press  to confirm.

To return to the *Configuration* main menu, press .

### 5.8. Transient mode

The  mode is used to configure the voltage and current thresholds.

#### 5.8.1. Current thresholds

The  screen, displayed by pressing the **A** icon, is used to define the current thresholds.

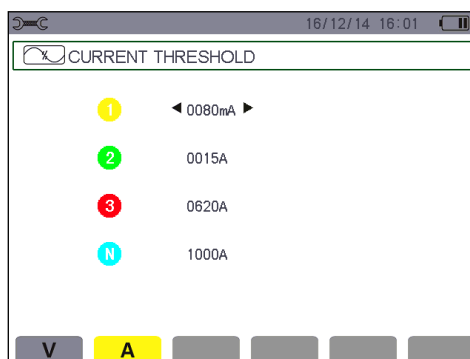













Figure 5-10: The Current thresholds screen in the Transient Mode menu

- ★ The arrow   indicate the channel of cursor.
- ★ Use the  or  key to go from one channel to another, press  appear  , start to change.
- ★ Press  or  to select the change bit and threshold current unit(mA/A), To increment or decrement a value, press  or .
- ★ Press  to confirm.

### 5.8.2. Voltage thresholds

The  screen, displayed by pressing the **V** icon, is used to define the voltage thresholds.

All the voltage threshold can be set as the following:

- (4V)4 channels are the same threshold.
- (3V+VN)L1\L2\L3 is the same threshold, N line independent setting threshold.
- (V1+V2+V3+VN) 4 channels independent setting threshold respectively.

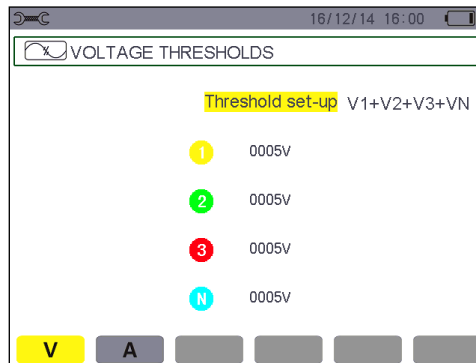























Figure 5-11: The Voltage thresholds screen in the Transient Mode menu

- ★ Press  to enter ratio configure, the arrows   appear. Use  or  to select the above 3 different threshold combinations, then press .
- ★ To select the threshold, use the  or  key (highlighted in yellow).
- ★ To setting the threshold, press , The arrows   appear, start to change.
- ★ Press  or  to select the change bit and threshold unit(V/kV), To increment or decrement a value, press  or . Then press .

To return to the *Configuration* main menu, press .

### 5.9. Trend mode

The device has a recording function – key  - (see § 10) for recording measured and calculated values (Urms, Vrms, Arms, etc.). Four independent configurations can be parameterized, depending on needs.

To select the desired configuration, press the yellow key corresponding to the , , ,  icon. The active configuration is identified by the icon with a yellow background.

A configuration example is shown below:

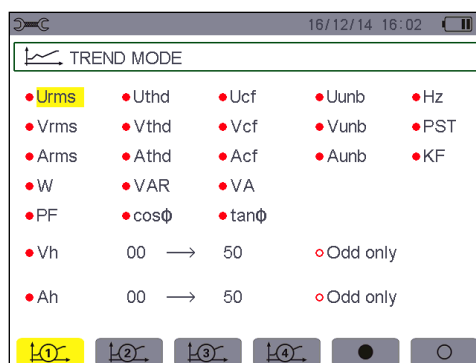







Figure 5-12: In this example, only the Urms values are recorded in configuration 1

- ★ To define configuration 1, press the yellow key on the keypad corresponding to the  icon. The icon appears on a yellow ground.
- ★ To select the values, move the yellow cursor using the  or  and  or .
- ★ Press  to select/unselect, red solid dot indicate is selected, red hollow dot indicate is unselected.

The recordable values are:

Unit	Designation.
Urms	True RMS phase-to-phase voltage.
Uthd	harmonic distortion of the phase-to-phase voltage(2 $\phi$ , 3 $\phi$ ).
Ucf	Crest (peak) factor of phase-to-phase voltage(2 $\phi$ , 3 $\phi$ ).
Uunb	Phase-to- phase voltage unbalance(2 $\phi$ , 3 $\phi$ ).
Hz	Network frequency.
Vrms	True RMS phase-to- neutral voltage.
Vthd	Total harmonic distortion of the phase-to-neutral voltage.
Vcf	Crest factor of phase-to-neutral voltage.
Vunb	Phase-to-neutral voltage unbalance(2 $\phi$ , 3 $\phi$ ).
PST	Short-term flicker.
Arms	True RMS current.
Athd	Total harmonic distortion of the current.
Acf	Crest factor of current.
Aunb	Current unbalance (2 $\phi$ , 3 $\phi$ ).
KF	K factor.
W	Active power.
VAR	Reactive power.
VA	Apparent power.
PF	Power factor.
DPF	Displacement power factor.
Tan	Tangent.
?	See comment below.

Features specific to the last two lines. These are recalled below:



Figure 5-13: These two lines involve harmonics

These two lines involve the recording of the harmonics of VAh, Ah, Vh and Uh. You can select a range of orders of the harmonics to be recorded (between 0 and 50) for each of these quantities, and within this range, if desired, only odd harmonics. Proceed as follows:

- **To enter the value to be recorded:** with line  highlighted in yellow, press . The arrows appear. Select the value (VAh, Ah, Vh, and Uh) for which harmonics are to be recorded by pressing or . “?” indicate is unselected. Confirm by pressing . The values field is highlighted in yellow. Press to go to the next field.
- **To select the starting harmonic order:** with the field highlighted in yellow. Press , the arrows appear. Press or to increment or decrement the harmonic order, then validate by pressing . Press to go to the next field.
- **To select the last harmonic:** (greater than or equal to the starting harmonic order) highlighted in yellow. Press , The arrows appear. Press or to increment or decrement the harmonic order, then validate by pressing . Press to go to the next field.
- **odd harmonics only:** to select or deselect this function, press . The solid red dot identifies your selection:

*Selected*, only odd harmonics between the two orders of harmonics specified in the previous points are recorded.

*Not selected*, all harmonics (even and odd) between the two orders of harmonics specified in the previous points are recorded.

● Vh	00	→	50	○ Odd only
● Ah	00	→	50	○ Odd only

Figure 5-14: record setting harmonic order

To return to the *Configuration* main menu, press .

Proceed in the same way to define the other configurations.

### 5.10. Alarm mode

The  screen defines the alarms used by the Alarm Mode function (see § 9). You can configure 40 different alarms.

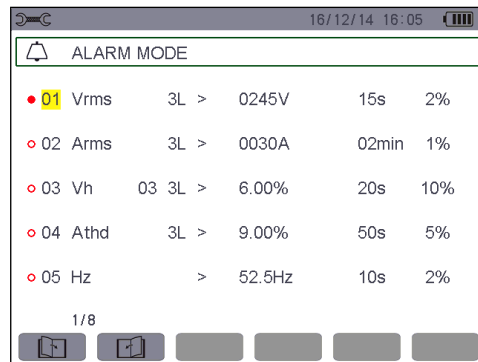





















Figure 5-15: The Alarm mode menu

- Use the  or  key to select a different setting alarm parameter group. To select the field, press . The arrows   appear.
- To select the values (Vah, Ah, Uh, etc., see table in § 5.9), press  or , then confirm with . The field is highlighted in yellow.
- To navigate horizontally in the fields, use the  or  keys, then confirm by pressing . The arrows   appear. Enter the values by pressing  or , then confirm by pressing . Do the same for all values to be entered in the fields.

For each alarm to be defined, select:

- ★ The type of alarm (Vah, Ah, Uh, Vh, Tan, PF, DPF, VA, VAR, W, Athd, Uthd, Vthd, KF, Hz, Aunb, Vunb, Vrms, Acf, Ucf, Vcf, PST, Arms, Urms and Vrms – see the table of abbreviations in § 3.9).
  - ★ The orders of harmonics (between 0 and 50, for Vah, Ah, Uh and Vh).
  - ★ The alarm filter (3L: 3 phases, L1, L2, L3 can be triggered individually ; N: neutral can be triggered).
  - ★ The direction of the alarm (> or < for Arms, Urms, Vrms, Hz only; otherwise only one direction is possible).
  - ★ The triggering threshold of the alarm (the prefix of the unit of the alarm can be set in the following cases: W, VAR, VA, Arms, Urms, Vrms).
  - ★ The minimum duration above or below the threshold required for alarm validation (can set 0 second to 99 minutes).
  - ★ The hysteresis (The percentage increase or decrease from the corresponding alarm threshold, optional values are 1%, 2%, 5% or 10%. If more than this percentage will stop alarm - See § 17.2).
- Press  to select or cancel the alarm parameter set, red solid dot indicate is selected, red hollow dot indicate is unselected.
  - To display different alarm screen pages, press the yellow buttons corresponding to the  icons.

- To return to the *Configuration* menu, press .

### 5.11. Erase memory

The  menu partially or totally deletes the data recorded in the device (trend recording, transients recording, inrush current, alarm, screen snapshots, device setting and monitoring parameter setting).

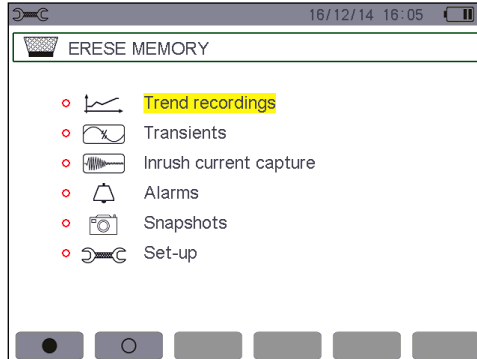







Figure 5-16: Erase memory menu

#### ■ For a partial deletion:

- ★ Select the parameters you want to delete by pressing the  or  key. The selected field is highlighted in yellow.
- ★ Press  to select/unselect, red solid dot indicate is selected, red hollow dot indicate is unselected.

**Note:** If the *Configuration* is selected, the message “after the configuration is deleted, the device will be turned off” appears on the screen.

- ★ Select the submenu by pressing the yellow key corresponding to the  icon. The  icon displayed yellow indicate ready to delete, then press the yellow key corresponding to the icon to cancel the delete state.
- ★ In the state of ready to delete, press  to confirm the deletion.

To return to the *Configuration* main menu, press .

#### ■ To delete everything:

- ★ Select All parameters by pressing the yellow key on the keypad corresponding to the  icon. The selection is identified by the red marks.

**Note:** Since the Configuration is selected, the message “after the configuration is deleted, the device will be turned off” appears on the screen.

- ★ To uncheck all items selected, press the yellow key on the keypad corresponding to the  icon, red hollow dot indicate is unselected.

To return to the *Configuration* main menu, press .

### 5.12. About

The screen displays the serial number of the device, the firmware version, the DSP software version, the icon version, and the SD card capacity.

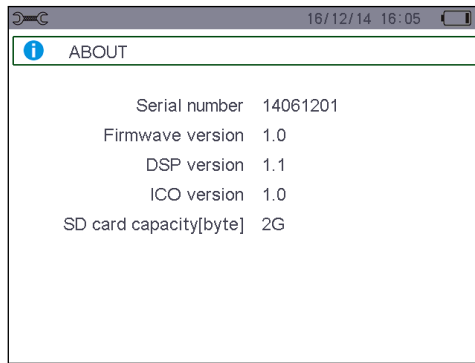



Figure 5-17: The About menu

To return to the *Configuration* menu, press .

## 6. Waveform Capture Key

### 6.1. Available sub-modes

The sub-modes are listed in the screen below and covered individually in the paragraphs that follow.

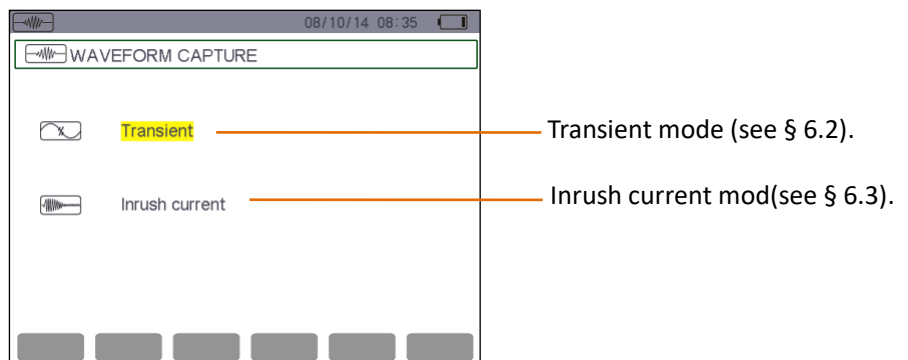





Figure 6-1: The screen when the Waveform Capture mode is entered

To enter the sub-modes, proceed as follows:

- ★ Select the mode by using the  or  key. The selected field is highlighted in yellow.
- ★ Confirm by pressing .

To return to the *Waveform capture* screen, press .

### 6.2. Transient mode

The  mode is used to record transients, view the list of recorded transients, and if necessary delete them. You can record up to 150 transients.

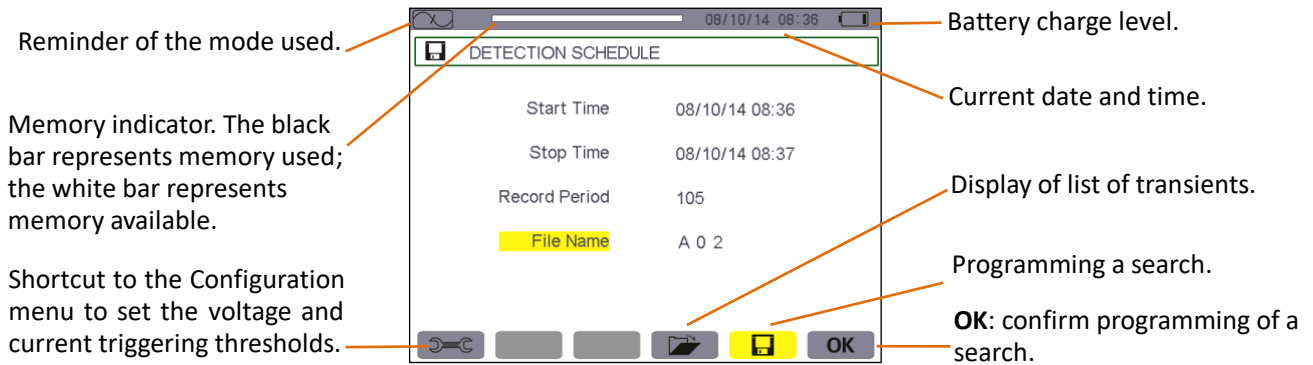

Figure 6-2: The Detection schedule screen in Transients mode

### 6.2.1. Programming and starting a search

Pressing the yellow key corresponding to the  icon. The Detection schedule screen is displayed.

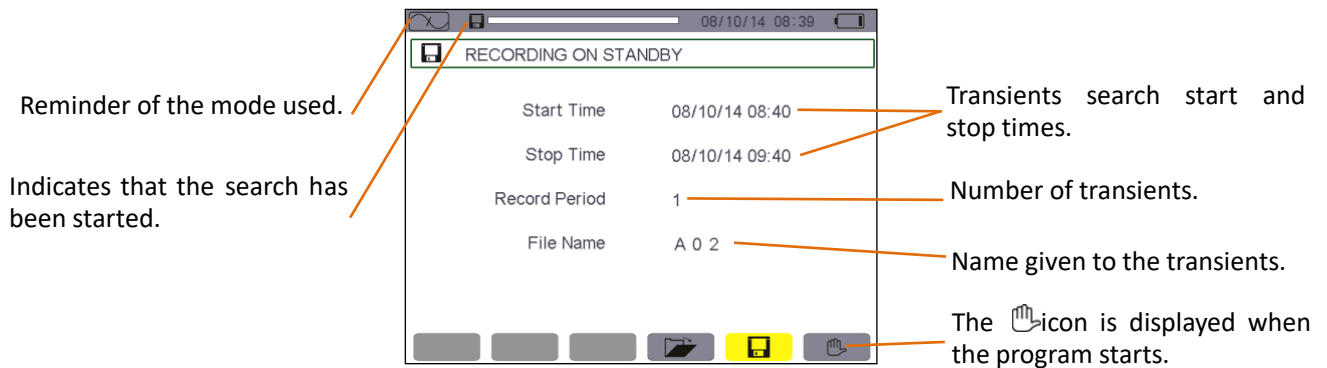





















Figure 6-3: The Detection schedule screen in Transients mode

#### 6.2.1.1. Stage 1: configuration of parameter

- ★ Select the **Start** field using the  or  key. The selected field is highlighted in yellow. Press  to enter the values. The arrows   appear in the start date and time field of the programming of a campaign.
- ★ Press  or  to increment or decrement a value and  or  to go to the next item.

**Note:** The start date and time must be later than the current date and time.

- ★ Press  to validate the programmed **Start** date and time.
- ★ Select the **Stop** field using the  or  key. The selected field is highlighted in yellow. Press  to enter the values. The arrows   appear in the **Stop** date and time field of the programming of a campaign.
- ★ Press  or  to increment or decrement a value and  or  to go to the next item.

**Note:** The stop date and time must be later than the start date and time.

- ★ Press  to validate the programming of the **Stop** date and time.
- ★ Instruments can store 150 sets of Transient record at the same time.

Proceed in the same way for the **Count**. The count can contain up to 150 transient records.



Proceed in the same way for **Series name** fields. The available alphanumeric characters are the uppercase letters from A to Z and the digits from 0 to 9. File name length up to eight characters.

- ★ To configure the voltage thresholds and current thresholds, press the yellow shortcut  key to return to the *Configuration* menu.

To return to the *Waveform capture* screen, press .

### 6.2.1.2. Stage 2: starting the program

To begin monitoring between the start and stop times you have defined, press the yellow key on the keypad corresponding to the **OK** icon.

- The **OK** icon disappears and the  icon appears instead.
- The message Detection on standby is displayed until the start time is reached and the  icon flashes in the screen's top display bar.
- When the start time is reached the message Detection in progress is displayed.
- When the stop time is reached, the Detection schedule screen with the **OK** icon (bottom right-hand corner of the screen) is displayed again. It is then possible to program another search.

**Note:** voltage and/or current transients are recorded according to the activation thresholds configured. If an activation occurs on the current threshold, the current and voltage waveforms are recorded.

To return to the *Waveform capture* screen, press .

### 6.2.1.3. Intentional transients campaign stoppage

The search can be stopped deliberately before the stop date and time by pressing the yellow key on the keypad corresponding to the  icon (bottom right corner of screen). The **OK** icon then reappears in the same place.

### 6.2.2. Display a transient

To display the recorded transients, proceed as follows:

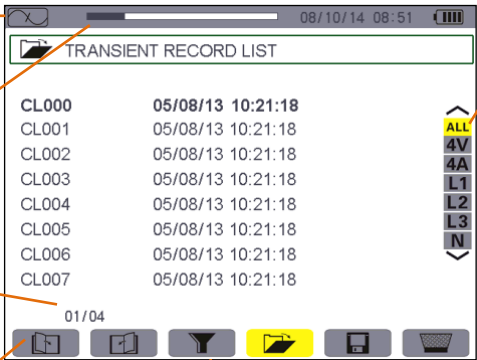

- ★ Select the submenu by pressing the yellow key corresponding to the  icon. The Transient list screen is displayed.



Reminder of the mode used.

Memory indicator. The black bar represents memory used; the white bar represents memory available.



The page number and the number of pages.

The   icons let you browse through the previous and next screen pages. Press the yellow keys corresponding to these icons to display the pages.

The  icon is used to activate or deactivate the choice of a transient list display filter.

Selection of transients in the list to be displayed:  
**-ALL:** all transients are displayed.  
**-4V:** the transients triggered by an event in one of the 4 voltage channels are displayed.  
**-4A:** the transients triggered by an event in one of the 3 current channels and 1 neutral current channel are displayed.  
**-L1, L2, or L3:** the transients triggered by an event on a particular phase are displayed (voltage or current).  
**-N:** the transients triggered by an event on the neutral current or neutral voltage are displayed.

Figure 6-4: the Transient list screen

- ★ Select the line of the transient to be displayed using the  or  key. The selected field is bolded. Confirm by pressing . The screen displays the transients in the form of curves.

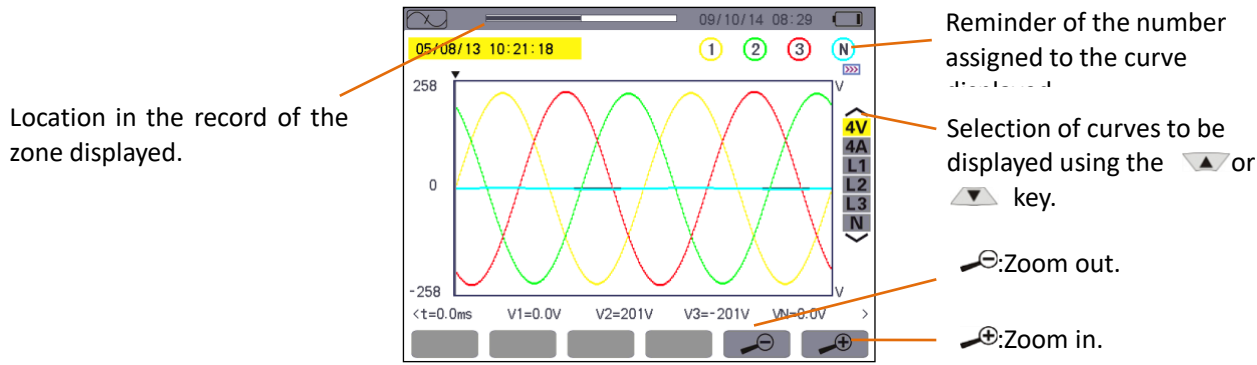

Figure 6-5: transients in the form of curves

★ Select the curve to be displayed using the ▲ or ▼ key, move the cursor using the ← or →, long press can move quickly.

To return to the *Transient list* screen, press ↵.

### 6.2.3. Delete a transient

The 🗑️ icon is displayed only if a record has been made. To delete a transient, proceed as follows:

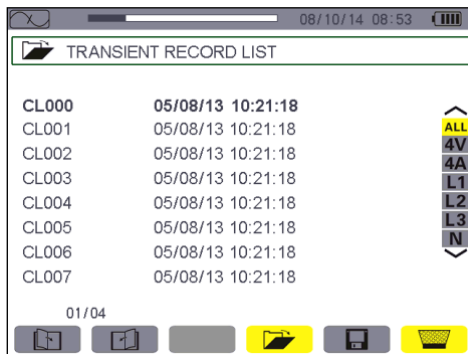

Figure 6-6: Delete transient screen

- ★ Select the transient to be deleted using the ▲ or ▼ key. The selected field is bolded.
- ★ Select the submenu by pressing the yellow key corresponding to the 🗑️ icon. The 🗑️ icon displayed yellow indicate ready to delete, then press the yellow key corresponding to the 🗑️ icon or ↵ to cancel the delete state.
- ★ In the state of ready to delete, press ↵ to confirm the deletion.

## 6.3. Starting current mode

This mode is used to capture (record) inrush currents (voltage and current waveforms). In capture display mode, two sub-menus, **RMS** and **PEAK**, are available (see § 6.3.2).

The device keeps in memory only a single current inrush capture.

### 6.3.1. Programming the capture

To program the capture of an inrush current, select the submenu by pressing the yellow key of the keypad corresponding to the 📅 icon. The *Capture schedule* screen is displayed.

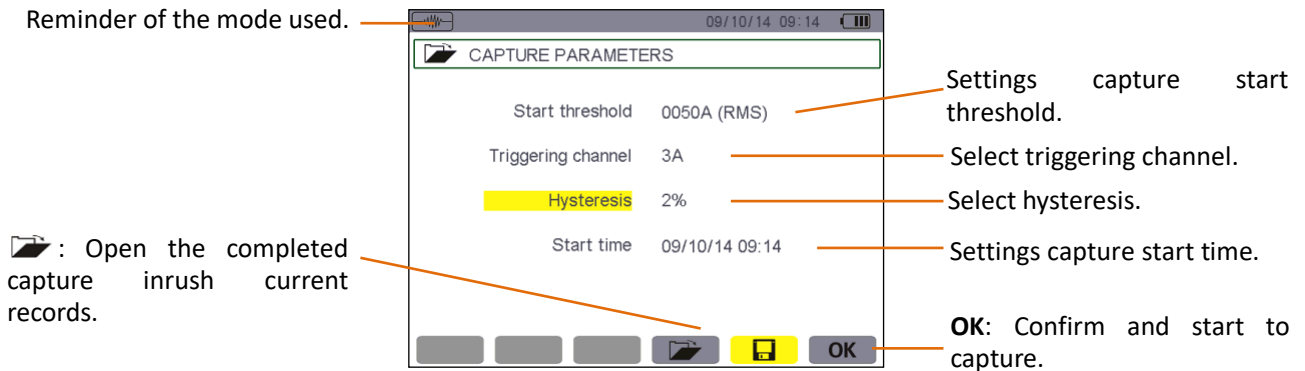

Figure 6-7: the Capture schedule screen in Inrush current mode

### 6.3.1.1. Stage 1: configuration of parameter

Proceed as follows:

- ★ Select the **Start threshold** field using the  $\blacktriangle$  or  $\blacktriangledown$  key. The selected field is highlighted in yellow. Press  $\blacktriangleright$  to enter the type of values. The arrows  $\blacktriangle$  $\blacktriangledown$  appear in the Start threshold field.
- ★ Press  $\blacktriangle$  or  $\blacktriangledown$  to increment or decrement a value and press  $\blacktriangleleft$  or  $\blacktriangleright$  to go to the next item.
- ★ Press  $\blacktriangleright$  to confirm

Proceed in the same manner for the **Triggering filter**, **Hysteresis** and **Start time**.

**Note:** for more information on the hysteresis, refer to § 17.2.

### 6.3.1.2. Stage 2: starting the capture

To start the capture program at the start date and time you have defined press the yellow key on the keypad corresponding to the **OK** icon.

- ★ The **OK** icon disappears and the  $\text{hand}$  icon appears instead.
- ★ The message *capture pending* is displayed until the start time is reached and the  $\text{square}$  icon flashes in the screen's upper display bar.
- ★ When the start conditions are met and the start time is reached, the message *Capture in progress* is displayed and the memory occupation indicator appears at the top of the screen. (The black bar represents memory used; the white bar represents memory available.) The indicator is displayed only during the capture, and disappears when the capture is completed.
- ★ If the capture is completed with a stop event (see conditions in § 17.5) or if the recording memory of the device is full, the capture stops automatically. *Programming the capture mode* and **OK** icon reappear.

**Note:** the device can keep in memory only a single inrush current capture. If you wish to make another capture, first delete the previous one.

To return to the *Waveform capture* screen, press  $\blacktriangleright$ .

### 6.3.1.3. Intentional stoppage of capture

A capture can be stopped deliberately by pressing the yellow key on the keypad corresponding to the  $\text{hand}$  icon (bottom right corner of the screen). **OK** icon will appear in the same place.

### 6.3.2. Displaying the parameter of the capture

To display the characteristics of the capture, proceed as follows:

- ◆ Select the submenu by pressing the yellow key corresponding to the  $\text{capture icon}$  icon. The *Capture parameters* screen is displayed.

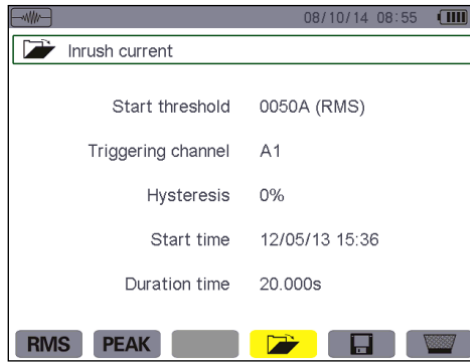

Figure 6-8: the Capture parameters screen

No.	Function	See
(1)	<b>RMS</b> mode	§ 6.3.3
(2)	<b>PEAK</b> mode	§ 6.3.4

- ◆ Choose the type of display, **RMS** or **PEAK**, by pressing the yellow key corresponding to the icon. The device displays waveforms (current and voltage) on which you can move the time cursor and zoom in and out.
  - ★ The instantaneous current and voltage at the time indicated by the cursor
  - ★ The maximum instantaneous current (over the entire capture).
  - ★ The **RMS** current in the half-cycle on which the cursor is positioned.
  - ★ The maximum half-cycle RMS current (over the entire capture).
  - ★ Maximum instantaneous value PEAK(over the entire starting time).
  - ★ The starting time and the motor starting period.

**Caution:** The voltage must be present before the inrush current proper for a stable and correct frequency lock.

### 6.3.3. True RMS current and voltage

The **RMS** mode displays the record of the trend of the true half-cycle RMS current and voltage and the frequency trend curve.

#### 6.3.3.1. The 3A RMS display screen

The following information is displayed:

Reminder of the mode used.

Scale of values of current.

Cursor. Use the ◀ or ▶ and keys to move the cursor. Long press can move quickly.

t: relative time position of the cursor (t=0 corresponds to the start of the inrush current capture).

**A1, A2, A3:** the instantaneous current of phases 1, 2, and 3 at the position of the cursor.

**AMAX:** maximum half-cycle RMS value of the inrush current capture.

Selection of curves to be displayed:  
**3 V:** displays the 3 voltages during the inrush current capture.  
**3 A:** displays the 3 currents during the inrush current capture.  
**L1, L2, L3:** display the current and voltage of phases 1, 2, and 3, respectively.  
**Hz:** displays network frequency.

Figure 6-9: the 3A RMS display screen

### 6.3.3.2. The L1 RMS display screen

The following information is displayed:

Reminder of the mode used.

Scale of values of current and voltage.

Cursor. Use the ◀ or ▶ and keys to move the cursor. Long press can move quickly.

t: relative time position of the cursor (t=0 corresponds to the start of the inrush current capture).

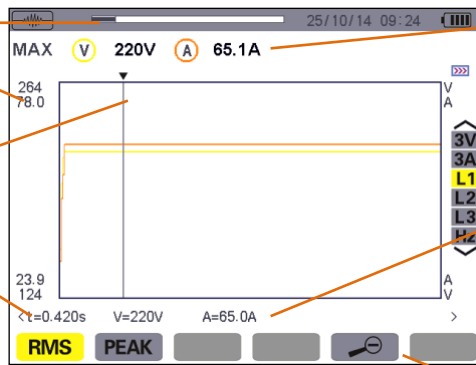

**MAX:** maximum half-cycle RMS value of the inrush current capture.

**V:** measured voltage.

**A:** measured current.

**V1:** the instantaneous voltage of phase 1 at the position of the cursor.

**A1:** the instantaneous current of phase 1 at the position of the cursor.

**Note:** Filters L2 and L3 display the trend of the true half-cycle RMS current and screen is identical to the one displayed for filter L1.

◀: Zoom out, ▶: Zoom in.

### 6.3.4. Instantaneous inrush current

The **PEAK** mode is used to display the envelopes and waveforms of the inrush current capture.

#### 6.3.4.1. The 4A PEAK display screen

The following information is displayed:

Reminder of the mode used.

Peak absolute value.

Scale of values of current.

Cursor. Use the ◀ or ▶ and keys to move the cursor. Long press can move quickly.

t: relative time position of the cursor (t=0 corresponds to the start of the inrush current capture).

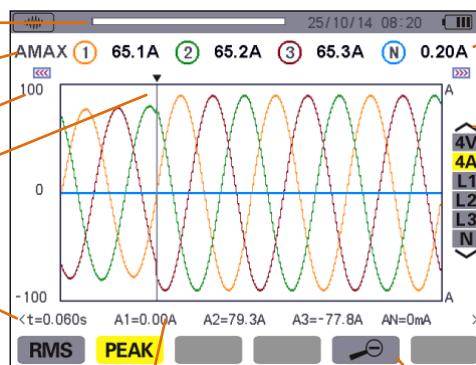

**AMAX:** maximum half-cycle RMS value of the inrush current capture.

Selection of curves to be displayed:

**4 V:** display the 3 phase and neutral voltages.

**4 A:** display the 3 phase and neutral current.

**L1, L2, L3:** display the current and voltage of phases 1, 2, and 3, respectively.

**N:** display the neutral current and voltage.

**A1, A2, A3:** the instantaneous current in phases 1, 2, and 3 at the position of the cursor.

**AN:** the neutral instantaneous current at the position of the cursor.

◀: Zoom out, ▶: Zoom in.

Figure 6-11: the 4A PEAK display screen

#### 6.3.4.2. The A1 PEAK display screen

The following information is displayed:

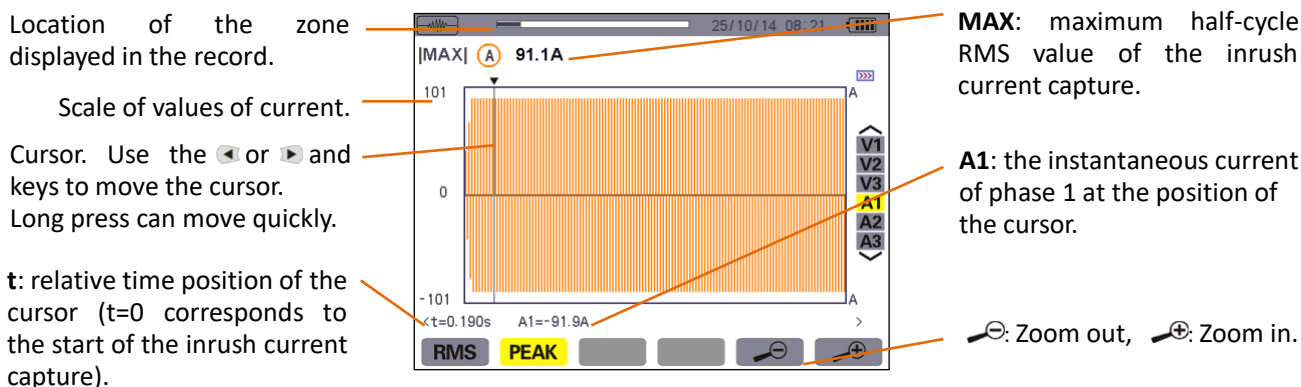



Figure 6-12: the A1 PEAK display screen

**Note:** Filters A2 and A3 display the record of the current envelope of phases 2 and 3. The screen is identical to the one displayed for filter A1.

## 7. Harmonics Mode

The  key displays a representation of the harmonic ratios of the voltage, current, and apparent power, order by order. It can be used to determine the harmonic currents produced by nonlinear loads and analyze problems caused by harmonics according to their order (overheating of neutrals, conductors, motors, etc.).

### 7.1. Available sub-menus

The submenus are listed on the screen below and described individually in the paragraphs that follow. The measurement type is selected using the yellow keys of the keypad below the screen.

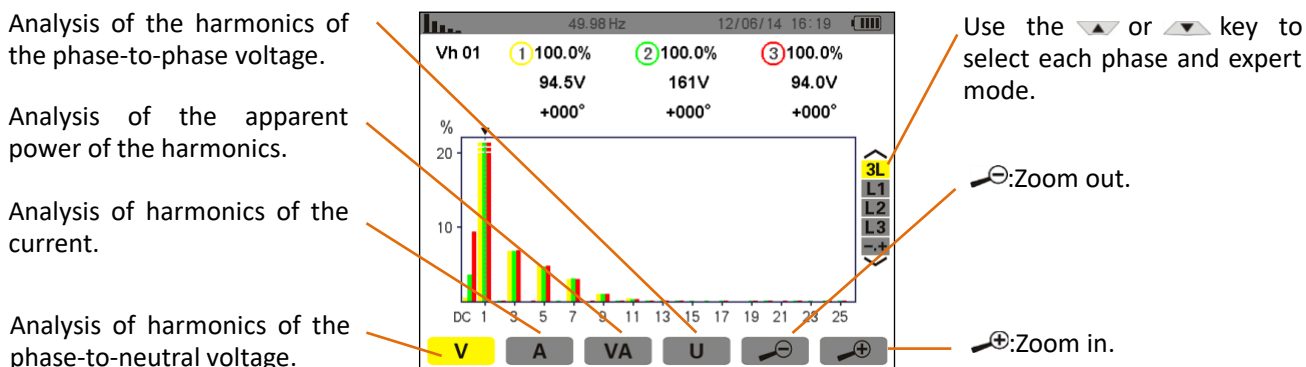

Figure 7-1: Harmonic mode screen

### 7.2. Phase-to-neutral voltage

The **V** sub-menu displays the harmonics of the phase-to-neutral voltage.

**Note:** The choice of curves to be displayed depends on the type of connection (see § 5.6):

- ★ Single-phase: no choice (L1).
- ★ Two-phase: 2L, L1, L2.
- ★ Three-phase, 3-, 4-, or 5-wire: 3L, L1, L2, L3, -, + (expert mode).

The screen snapshots shown as examples were obtained with a three-phase connection. This observation also applies to the other sub-menus.

#### 7.2.1. The 3L phase-to-neutral harmonics display screen

The following information is displayed:

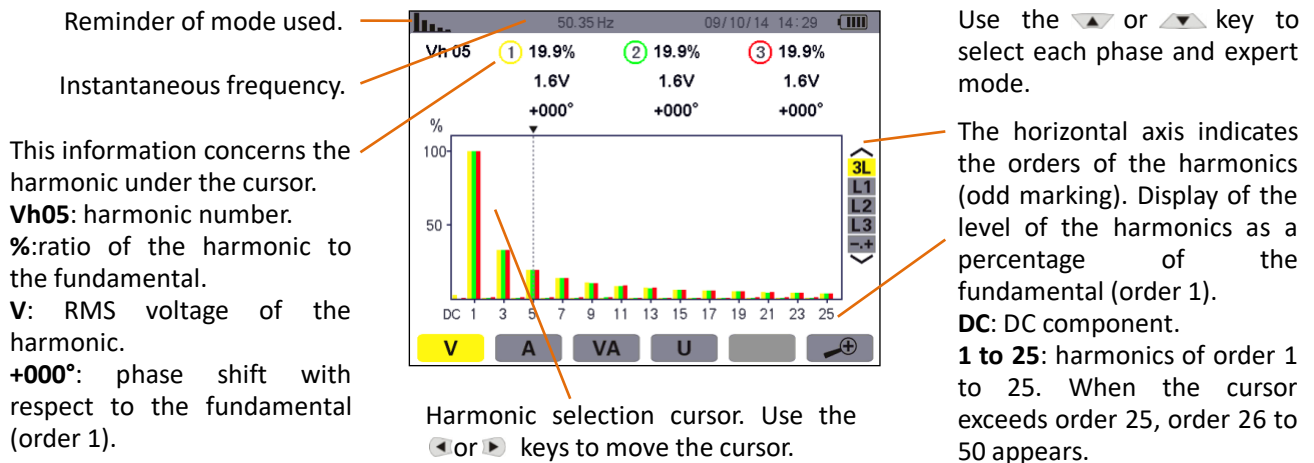

Figure 7-2: example of 3L phase-to-neutral voltage harmonics display

Display in expert mode (three-phase connection only - See § 7.6) of the 3 phases (3×3L) or of L1, L2 or L3(\*).

### 7.2.2. The L1 phase voltage harmonics display screen

The following information is displayed:

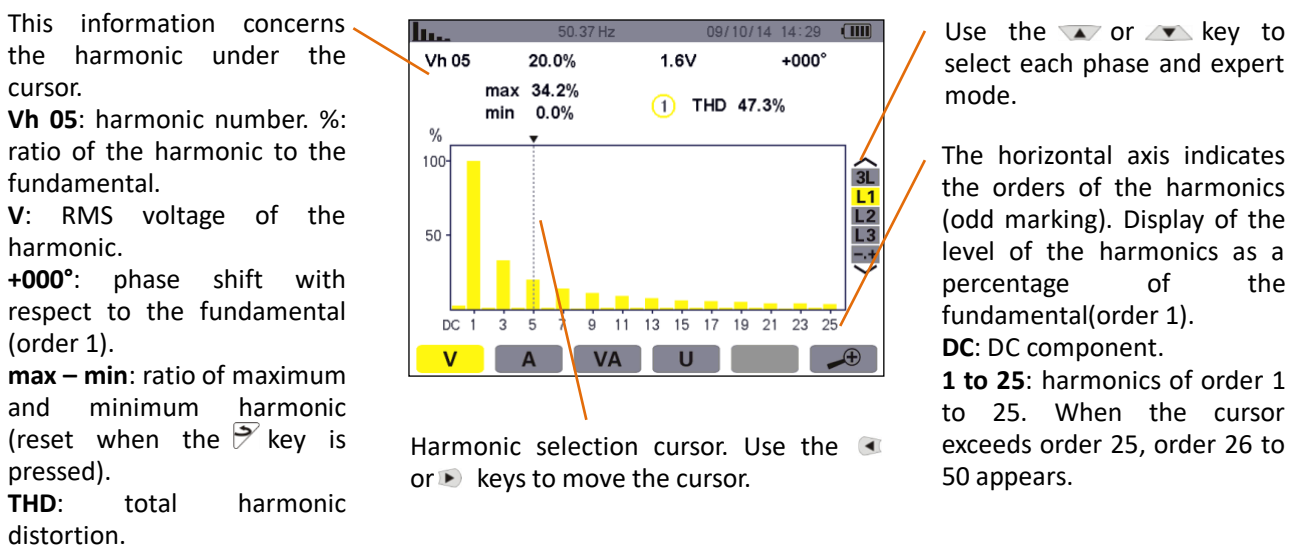

Figure 7-3: example of display of harmonics of L1 phase-to-neutral voltage

**Note:** Filters L2 and L3 display the harmonics of the phase-to-neutral voltage for phases 2 and 3, respectively. The screen is identical to the one displayed for filter L1.

### 7.3. Current

The **A** sub-menu displays the harmonics of the current.

### 7.3.1. The 3L current harmonics display screen

The following information is displayed:

- Reminder of mode used.
- Instantaneous frequency.
- This information concerns the harmonic under the cursor.
- Ah03**: harmonic number.
- %**:ratio of the harmonic to the fundamental.
- A**: RMS current of the harmonic.
- +000°**: phase shift with respect to the fundamental (order 1).

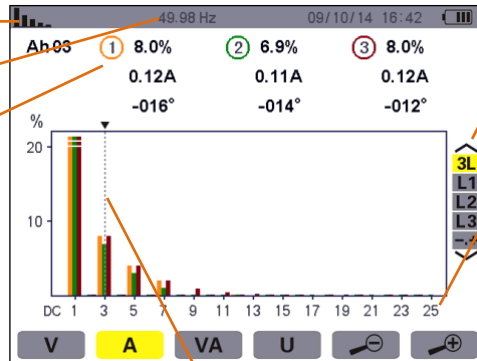

Use the  $\blacktriangle$  or  $\blacktriangledown$  key to select each phase and expert mode.

The horizontal axis indicates the orders of the harmonics (odd marking). Display of the level of the harmonics as a percentage of the fundamental(order 1).  
**1 to 25**: harmonics of order 1 to 25. When the cursor exceeds order 25, order 26 to 50 appears.

Harmonic selection cursor. Use the  $\blacktriangleleft$  or  $\blacktriangleright$  keys to move the cursor.

Figure 7-4: example of 3L display of current harmonics

### 7.3.2. The L1 current harmonics display screen

The following information is displayed:

- Reminder of mode used.
- Instantaneous frequency.
- This information concerns the harmonic under the cursor.
- Ah03**: harmonic number.
- %**:ratio of the harmonic to the fundamental.
- A**: RMS current of the harmonic.
- +000°**: phase shift with respect to the fundamental (order 1).

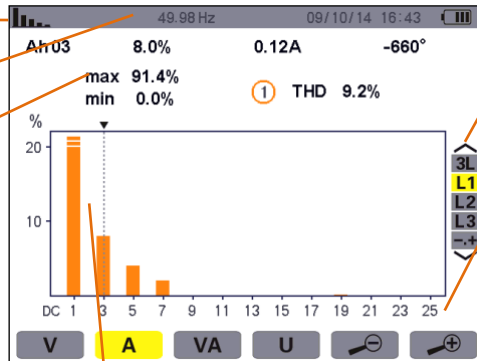

Use the  $\blacktriangle$  or  $\blacktriangledown$  key to select each phase and expert mode.

The horizontal axis indicates the orders of the harmonics (odd marking). Display of the level of the harmonics as a percentage of the fundamental(order 1).  
**1 to 25**: harmonics of order 1 to 25. When the cursor exceeds order 25, order 26 to 50 appears.

Harmonic selection cursor. Use the  $\blacktriangleleft$  or  $\blacktriangleright$  keys to move the cursor.

Figure 7-5: example of L1 display of current harmonics

**Note:** Filters L2 and L3 display the current harmonics of phases 2 and 3, respectively. The screen is identical to the one displayed for filter L1.

## 7.4. Apparent power

The **VA** sub-menu displays the harmonics of the apparent power.

### 7.4.1. The 3L apparent power harmonics display screen

The information is:

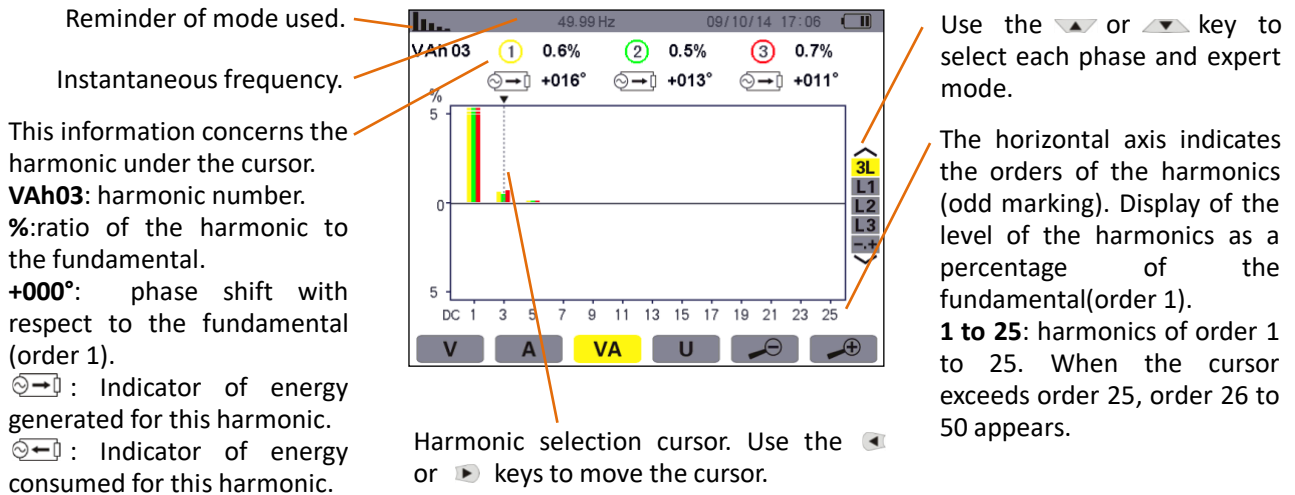

Figure 7-6: example of 3L apparent power harmonics display

### 7.4.2. The L1 apparent power harmonics display screen

The information is:

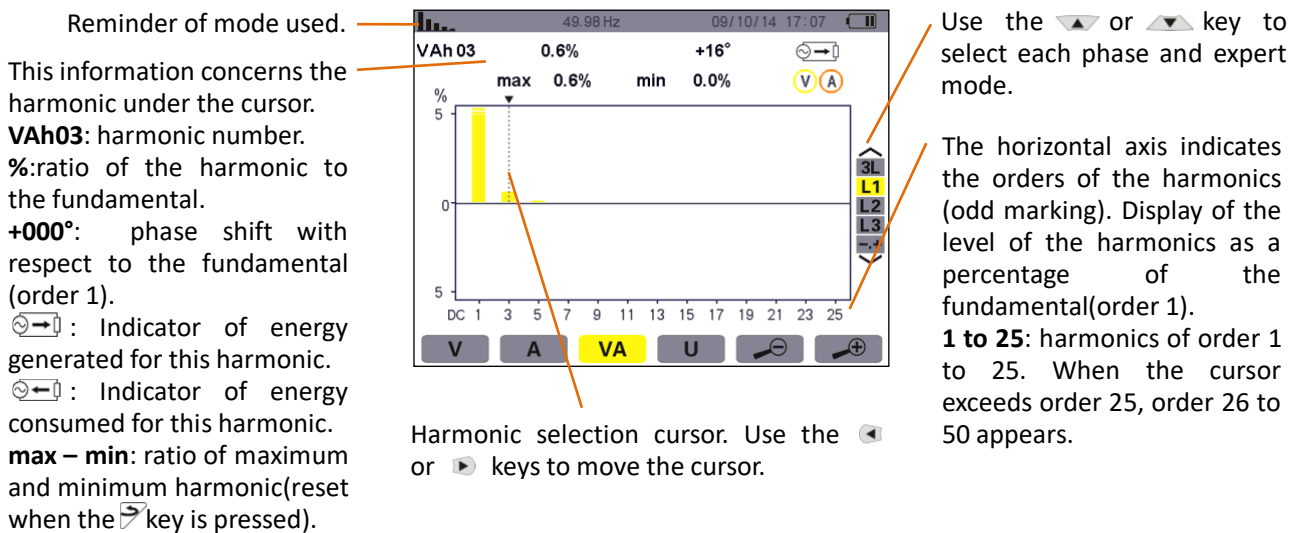

Figure 7-7: example of L1 apparent power harmonics display

**Note:** Filters L2 and L3 display the apparent power of the harmonics for phases 2 and 3, respectively. The screen is identical to the one displayed for filter L1.

## 7.5. Phase-to-phase voltage

The **U** sub-menu is available only for three-phase connections, when the voltage ratios of phases 1, 2, and 3 are equal. This sub-menu displays the harmonics of the phase-to-phase voltage.

### 7.5.1. The 3L phase-to-phase voltage harmonic display screen

The following information is displayed:

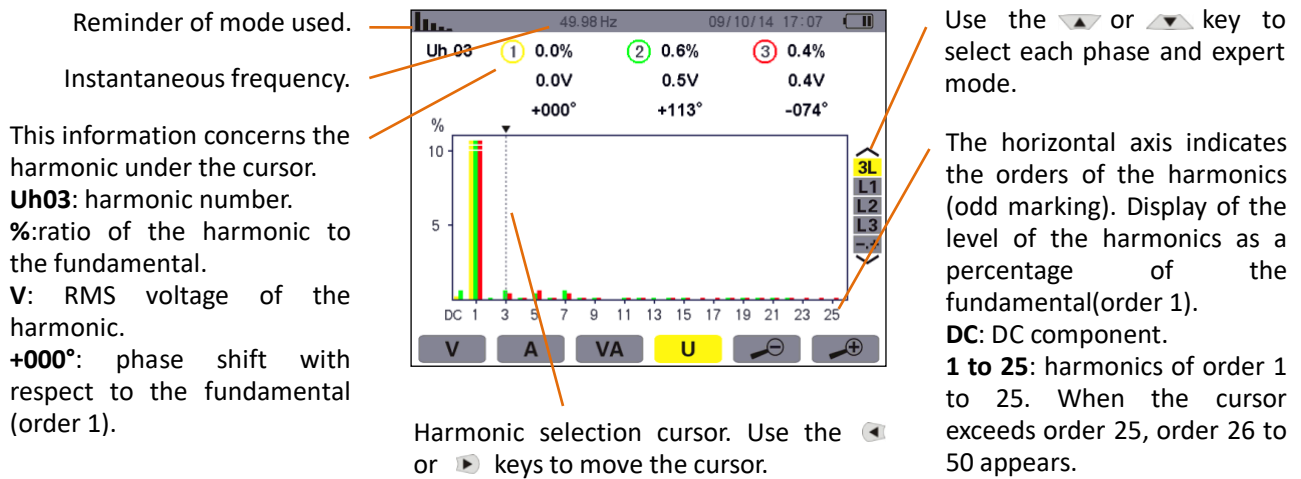

Figure 7-8: example of 3L phase-to-phase voltage harmonics display

### 7.5.2. The L1 phase-to-phase voltage harmonics display screen

The following information is displayed:

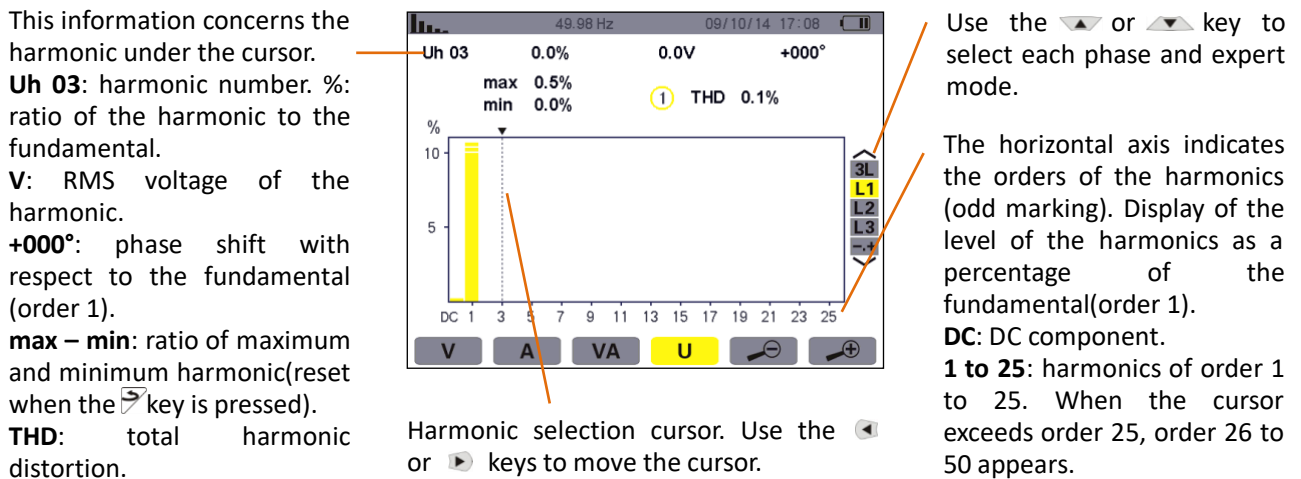

Figure 7-9: example of L1 phase-to-phase voltage harmonics display

## 7.6. Expert mode

The  $\square$  mode is available with a three-phase connection only, when the ratios of the three phases are equal. It is used to display the influence of the harmonics on the heating of the neutral and on rotating machines. To display expert mode press the  $\blacktriangle$  or  $\blacktriangledown$  keys of the keypad. The selection is highlighted in yellow and the screen simultaneously displays the expert mode.

From this screen, two sub-menus, **V** and **A**, are available (see next page).

### 7.6.1. The phase-to-phase voltage expert mode display screen

The **V** sub-menu displays the influence of the harmonics of the phase-to-neutral voltage on the heating of the neutral and on rotating machines.

The following information is displayed:

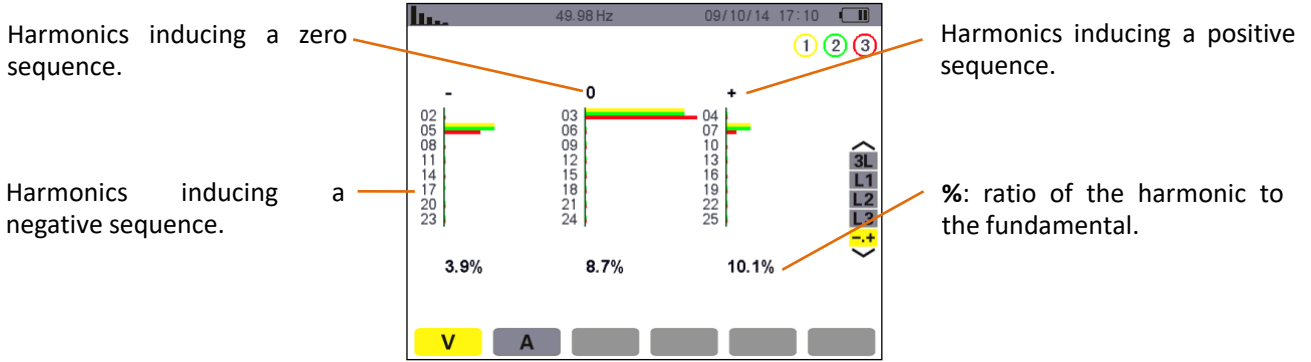

Figure 7-10: the phase-to-neutral voltage expert mode screen

### 7.6.2. The current expert mode display screen

The **A** sub-menu displays the influence of the harmonics of the current on the heating of the neutral and on rotating machines.

The following information is displayed:

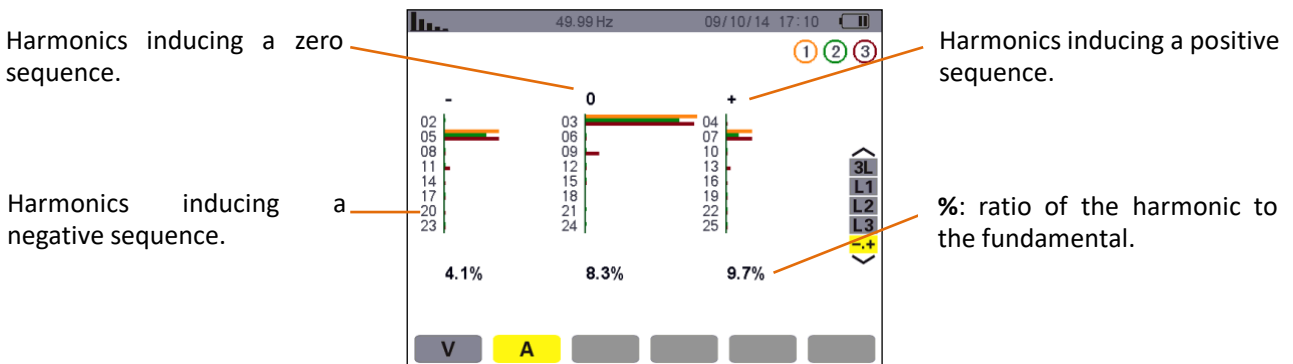



Figure 7-11: the current expert mode screen

## 8. Waveform Key

The  key is used to display the current and voltage curves, along with the values measured and those calculated from the voltages and currents (except for power, energy, and harmonics).

### 8.1. Available sub-menus

The sub-menus are listed on the screen below and described individually in the paragraphs that follow.

The type of measurement is selected using the yellow keys of the keypad below the screen.

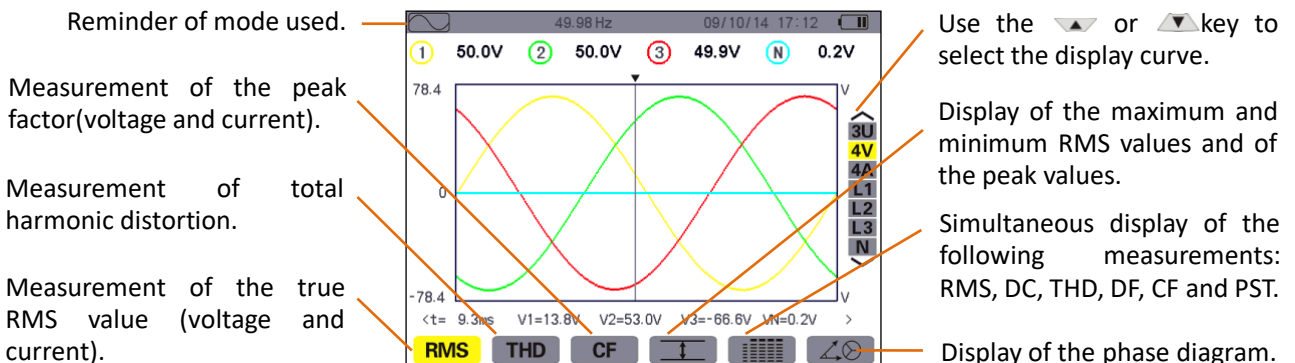

Figure 8-1: Waveform mode screen

## 8.2. Measurement of true RMS value

The **RMS** sub-menu displays the waveforms over one period of the signals measured and the true RMS voltage and current.

**Note:** The choice of curves to be displayed depends on the type of connection (see § 5.6):

- ◆ Single-phase: no choice (L1)
- ◆ Two-phase: 2V, 2A, L1, L2
- ◆ Three-phase, 3- or 4-wire: 3U, 3V, 3A, L1, L2, L3
- ◆ Three-phase, 5-wire:
  - ★ For **THD**, **CF** and  $\angle \otimes$ : 3U, 3V, 3A, L1, L2 and L3
  - ★ For **RMS**, **I** and  $\text{|||||}$ : 3U, 4V, 4A, L1, L2, L3 and N

The screen snapshots shown as examples are those obtained with a three-phase 5-wire connection.

### 8.2.1. The 3U display screen

This screen displays the three phase-to-neutral voltages of a three-phase system.

The following information is displayed:

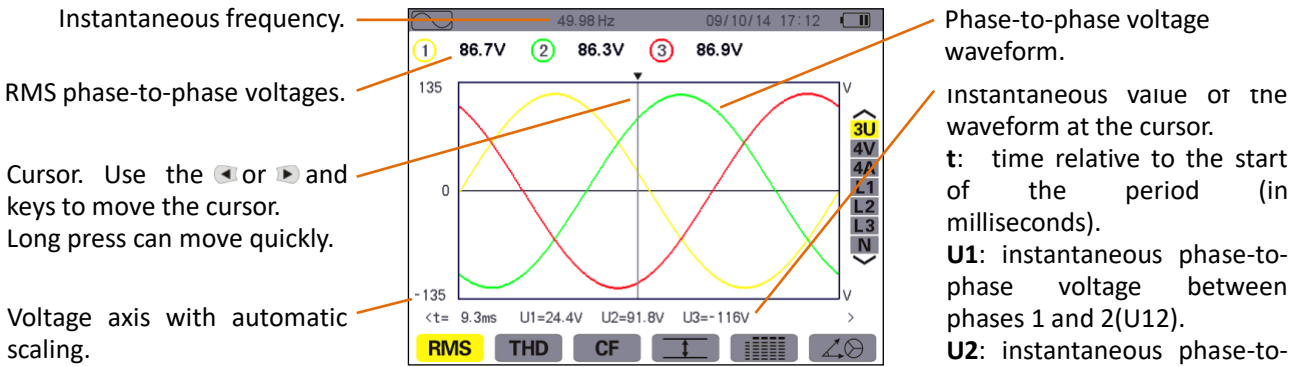

Figure 8-2: the 3U RMS display screen

### 8.2.2. The 4V RMS display screen

This screen displays the three phase-to-neutral voltages and the neutral-to-earth voltage of a three-phase system.

The following information is displayed:

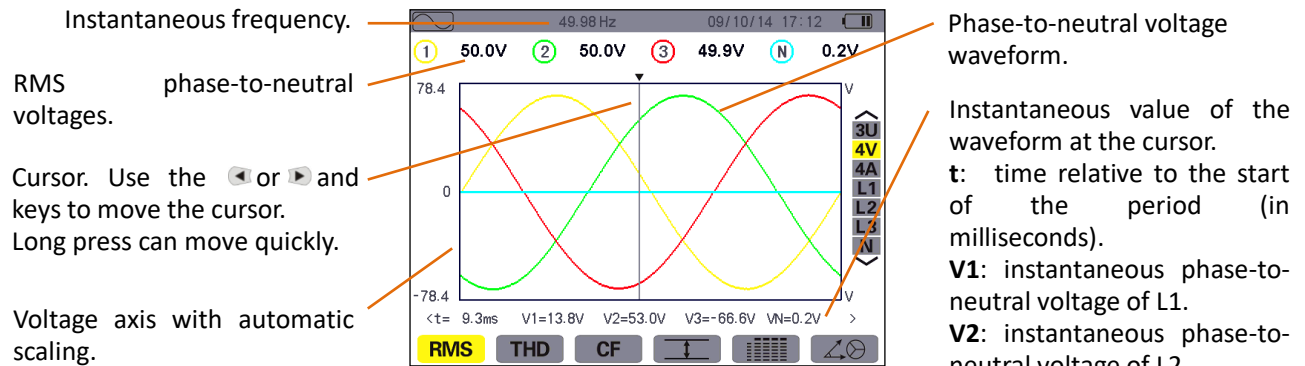

Figure 8-3: the 4V RMS display screen

### 8.2.3. The 4A RMS display screen

This screen displays the three phase currents and the neutral current of a three-phase system.

The following information is displayed:

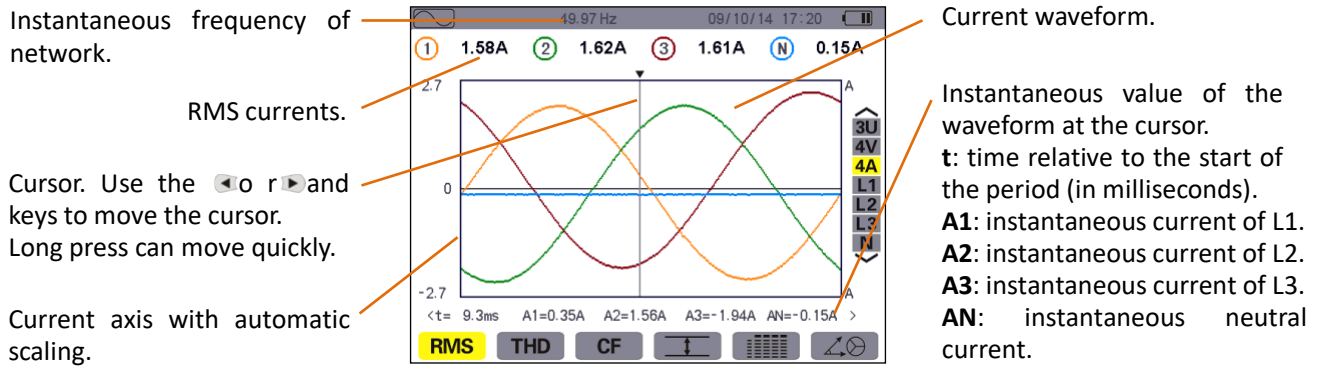

Figure 8-4: the 4A RMS display screen

### 8.2.4 The RMS display screen for neutral

This screen displays the neutral voltage with respect to earth and the neutral current.

The following information is displayed:

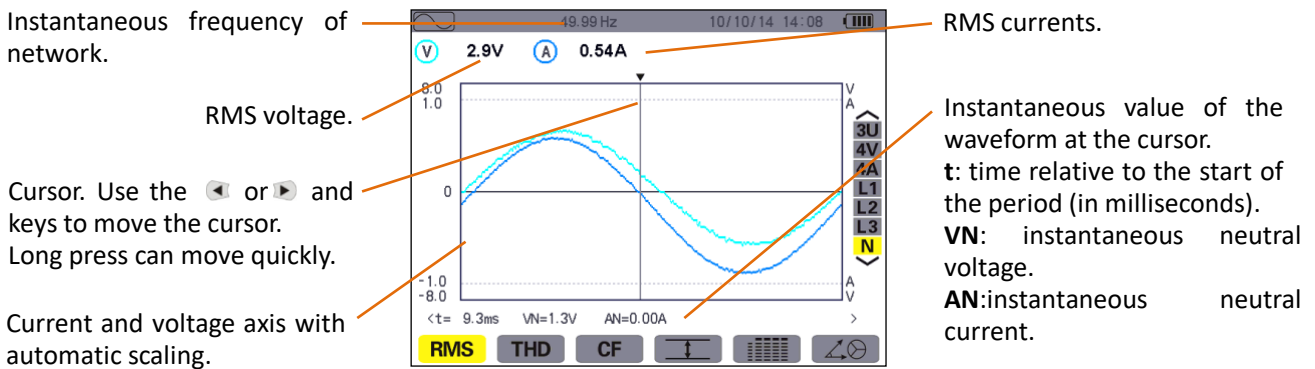

Figure 8-5: the RMS display screen for the neutral

**Note:** L1, L2, and L3 display the current and voltage in phases 1, 2, and 3, respectively. The screen is identical to the one displayed for the neutral.

## 8.3. Measurement of total harmonics distortion

The **THD** sub-menu displays the waveforms of the signals measured over one full cycle and the total voltage and current harmonic distortion.

### 8.3.1. The 3U display screen

This screen displays the phase-to-phase voltage waveforms for one period and the total harmonic distortion values.

The following information is displayed:

- Instantaneous frequency of network.
- Harmonic distortion for each curve.
- Cursor. Use the ◀ or ▶ and keys to move the cursor. Long press can move quickly.
- Voltage axis with automatic scaling.

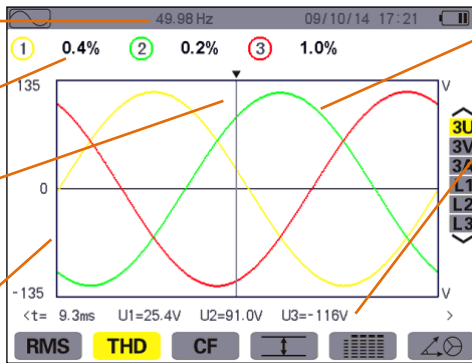

- Phase-to-phase voltage waveform.
- Instantaneous value of the waveform at the cursor.
- t: time relative to the start of the period (in milliseconds).
- U1: instantaneous phase-to-phase voltage between phases 1 and 2 (U12).
- U2: instantaneous phase-to-phase voltage between phases 2 and 3 (U23).
- U3: instantaneous phase-to-phase voltage between phases 3 and 1 (U31).

Figure 8-6: the 3U THD display screen

### 8.3.2. The 3V display screen

This screen displays the phase-to-neutral voltage waveforms for one period and the total harmonic distortion values.

The following information is displayed:

- Instantaneous frequency of network.
- Harmonic distortion for each curve.
- Cursor. Use the ◀ or ▶ and keys to move the cursor. Long press can move quickly.
- Voltage axis with automatic scaling.

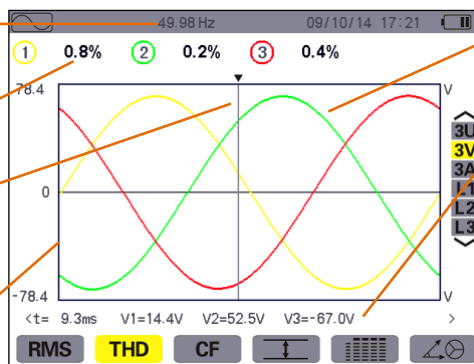

- Phase-to-neutral voltage waveform.
- Instantaneous value of the waveform at the cursor.
- t: time relative to the start of the period (in milliseconds).
- V1: instantaneous phase-to-neutral voltage of L1.
- V2: instantaneous phase-to-neutral voltage of L2.
- V3: instantaneous phase-to-neutral voltage of L3.

Figure 8-7: the 3V THD display screen

### 8.3.3. The 3A display screen

This screen displays the phase current waveforms for one period and the total harmonic distortion values.

The following information is displayed:

- Instantaneous frequency of network.
- Harmonic distortion for each curve.
- Cursor. Use the ◀ or ▶ and keys to move the cursor. Long press can move quickly.
- Current axis with automatic scaling.

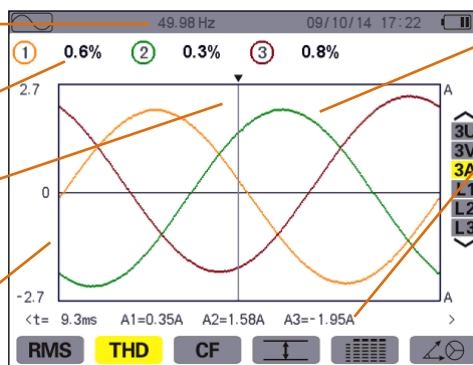

- Current waveform.
- Instantaneous value of the waveform at the cursor.
- t: time relative to the start of the period (in milliseconds).
- A1: instantaneous current of L1.
- A2: instantaneous current of L2.
- A3: instantaneous current of L3.

Figure 8-8: the 3A THD display screen

**Note:** L1, L2, and L3 display the total current and voltage harmonic distortion for phases 1, 2, and 3, respectively.

### 8.4. Measurement of the PEAK factor

The **CF** sub-menu displays the waveforms of the signals measured over one period and the voltage and current peak factors.

#### 8.4.1. The 3U CF display screen

This screen displays the phase-to-phase voltage waveforms of one period and the peak factors.

The following information is displayed:

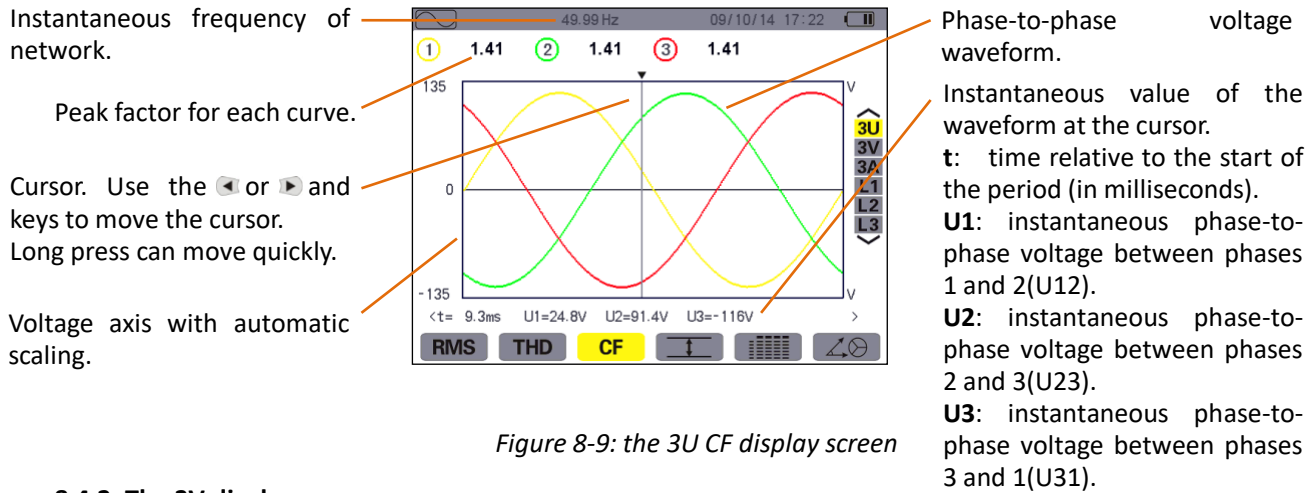

Figure 8-9: the 3U CF display screen

#### 8.4.2. The 3V display screen

This screen displays the phase-to-neutral voltage waveforms of one period and the peak factors.

The following information is displayed:

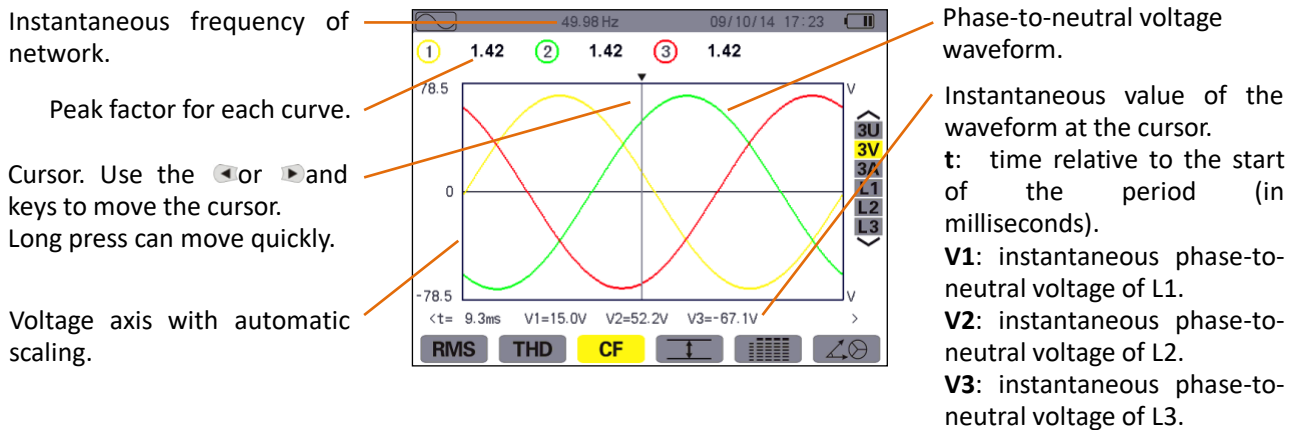

Figure 8-10: the 3V CF display screen

#### 8.4.3. The 3A CF display screen

This screen displays the current waveforms of one period and the peak factors.

The following information is displayed:

Instantaneous frequency of network.

Peak factor for each curve.

Cursor. Use the ◀ or ▶ and keys to move the cursor. Long press can move quickly.

Current axis with automatic scaling.

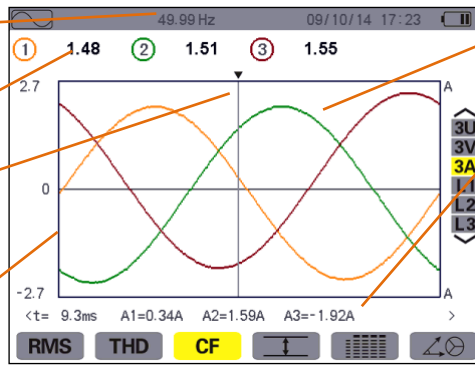

Current waveform.

Instantaneous value of the waveform at the cursor.  
**t**: time relative to the start of the period (in milliseconds).  
**A1**: instantaneous current of L1.  
**A2**: instantaneous current of L2.  
**A3**: instantaneous current of L3.

Figure 8-11: the 3A CF display screen

**Note:** L1, L2, and L3 display the current and voltage peak factors for phases 1, 2, and 3, respectively.

## 8.5. Measurement of extreme and mean voltage and current

The **I** sub-menu displays the maximum and minimum RMS voltage and current and the instantaneous positive and negative peak voltage and current.

### 8.5.1. The 3U Max.Min. -display screen

This screen displays the maximum and minimum RMS values and the instantaneous positive and negative phase-to-phase voltage peaks.

The following information is displayed:

Columns of values for each curve (1, 2, and 3).

**RMS**: true RMS phase-to-phase voltage.

**MAX**: maximum RMS phase-to-phase voltage (since the switching on of the HZCR5000 or since the last time the **S** or **A** key was pressed.)

**MIN**: maximum RMS phase-to-phase voltage (method as above).

**PK+**: maximum (positive) peak phase-to-phase voltage (method as above).

**PK-**: maximum (negative) peak phase-to-phase voltage (method as above).

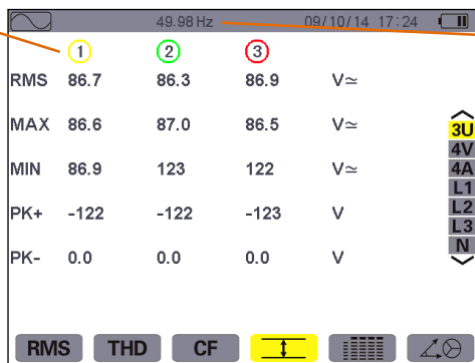

Instantaneous frequency of network.

Figure 8-12: the 3U Max.-Min. display screen

**Note:** The MAX. and MIN. RMS measurements are calculated every half cycle (i.e. every 10 ms for a 50-Hz signal). The measurements are refreshed every 300 ms.



### 8.5.2. The 4V Max.-Min. display screen

This screen displays the maximum and minimum RMS values and the instantaneous positive and negative peaks of the phase-to-neutral voltages and of the neutral.

The following information is displayed:

Columns of values for each curve (1, 2, and 3).

**RMS:** true RMS phase-to-neutral voltage.

**MAX:** maximum RMS phase-to-neutral voltage (since the switching on of the HZCR5000 or since the last time the  or  key was pressed.)

**MIN:** maximum RMS phase-to-neutral voltage (method as above).

**PK+:** maximum (positive) peak phase-to-neutral voltage (method as above).

**PK-:** maximum (negative) peak phase-to-neutral voltage (method as above).

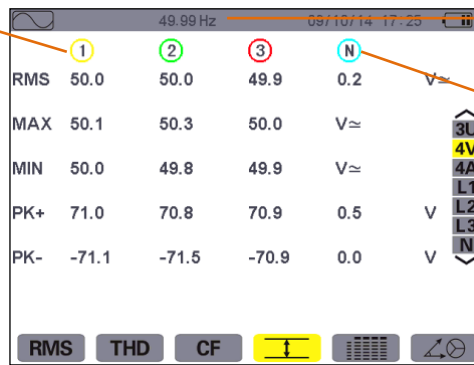

Instantaneous frequency of network.

Column of values for the neutral: RMS, PK+, PK-.

Figure 8-13: the 4V Max.-Min. display screen

measurements are calculated every half cycle (i.e. every 10 ms for a signal at 50 Hz). The measurements are refreshed every 300 ms.



### 8.5.3. The 4A Max.-Min. display screen

This screen displays the maximum and minimum RMS values and the positive and negative instantaneous peak values of the phase and neutral currents.

The following information is displayed:

Columns of values for each curve (1, 2, and 3).

**RMS:** true RMS current.

**MAX:** maximum RMS current (since the switching on of the HZCR5000 or since the last time the  or  key was pressed.)

**MIN:** maximum RMS current (method as above).

**PK+:** maximum (positive) peak current (method as above).

**PK-:** maximum (negative) peak current (method as above).

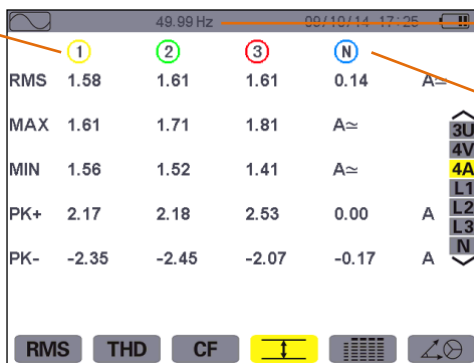

Instantaneous frequency of network.

Column of values for the neutral: RMS, PK+, PK-.

Figure 8-14: the 4A Max.-Min. display screen

**Note:** The Max. and Min. RMS measurements are calculated every half cycle (i.e. every 10 ms for a signal at 50 Hz). The measurements are refreshed every 300 ms.



### 8.5.4. The L1 Max.-Min. display screen

This screen displays the mean, maximum and minimum RMS values and the instantaneous positive and negative peaks of the phase-to-neutral voltage and of the current of phase 1.

The following information is displayed:

Column of voltage values.

**RMS:** true RMS phase-to-neutral voltage.

**MAX:** maximum RMS phase-to-neutral voltage (since the switching on of the HZCR5000 or since the last time the  or  key was pressed.)

**MIN:** maximum RMS phase-to-neutral voltage (method as above).

**PK+:** maximum (positive) peak phase-to-neutral voltage (method as above).

**PK-:** maximum (negative) peak phase-to-neutral voltage (method as above).

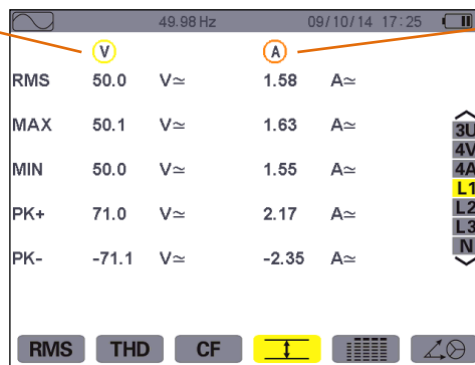

The same information as for the phase-to-neutral voltage, but for the current.

Figure 8-15: the L1 Max.-Min. display

**Note:** The Max. and Min. RMS measurements are calculated every half cycle (i.e. every 10 ms for a signal at 50 Hz). The measurements are refreshed every 300 ms.

L2, L3 and N display the maximum and minimum RMS values and the instantaneous positive and negative peaks of the phase-to-neutral voltage and of the current for phase 2, 3 and of the neutral-to-earth. The screen is identical to the one displayed for the L1.

## 8.6. Simultaneous display

The  sub-menu displays all of the voltage and current measurements (RMS, DC, THD, DF, CF, PST and KF).

### 8.6.1. 3U simultaneous display screen

This screen displays the RMS, DC, THD, DF, and CF values of the phase-to-phase voltages.

The following information is displayed:

Column of phase-to-phase voltages (phases 1, 2, and 3).

**RMS:** true RMS value calculated over 1 second.

**DC:** DC component.

**THD:** total harmonic distortion.

**DF:** distortion factor.

**CF:** peak factor calculated over 1 second.

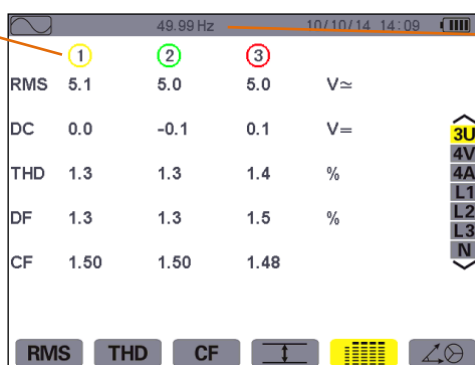

Instantaneous frequency of network.

Figure 8-16: 3U simultaneous display screen

### 8.6.2. 4V simultaneous display screen

This screen displays the RMS, DC, THD, DF, CF and PST values of the phase-to-neutral voltages and of the neutral.

The following information is displayed:

Column of phase-to-phase voltages (phases 1, 2, and 3).  
**RMS:** true RMS value calculated over 1 second.  
**DC:** DC component.  
**THD:** total harmonic distortion.  
**DF:** distortion factor.  
**CF:** peak factor calculated over 1 second.  
**PST:** short-term flicker calculated over 10 minutes.

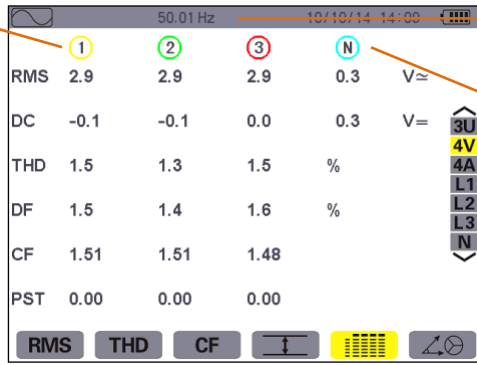

Instantaneous frequency of network.  
 Column of values for the neutral: **RMS, DC.**

Figure 8-17: 4V simultaneous display screen

### 8.6.3. 4A simultaneous display screen

This screen displays the RMS, DC, THD, DF, CF, and KF values of the phase and neutral currents.

The following information is displayed:

Column of phase-to-phase voltages (phases 1, 2, and 3).  
**RMS:** true RMS value calculated over 1 second.  
**DC:** DC component.  
**THD:** total harmonic distortion.  
**DF:** distortion factor.  
**CF:** peak actor calculated over 1 second.  
**KF:** transformer K factor.

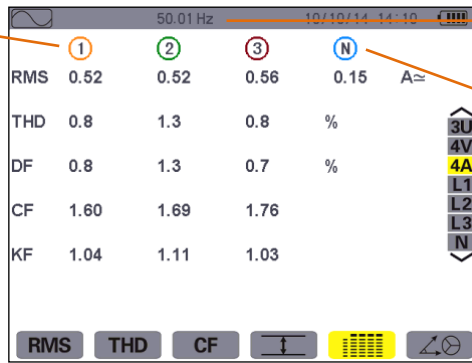

Instantaneous frequency of network.  
 Column of values for the neutral: **RMS.**

Figure 8-18: 4A simultaneous display screen

### 8.6.4. L1 simultaneous display screen

This screen displays the RMS, DC, THD, DF, CF, and KF values of the phase and neutral currents.

The following information is displayed:

Column of voltage values.  
**RMS:** true RMS value calculated over 1 second.  
**DC:** DC component.  
**THD:** total harmonic distortion.  
**DF:** distortion factor.  
**CF:** peak factor calculated over 1 second.  
**PST:** short-term flicker calculated over 10 minutes.

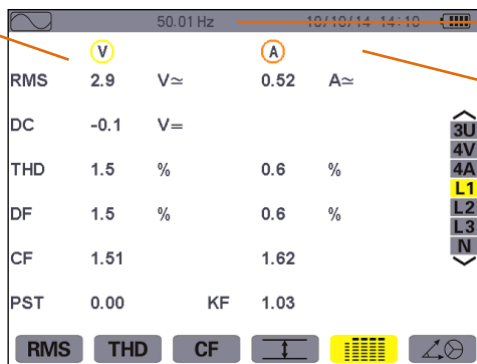

Instantaneous frequency of network.  
 Column of current values.  
**RMS:** true RMS value calculated over 1 second.  
**THD:** total harmonic distortion.  
**DF:** distortion factor.  
**CF:** peakfactor calculated over 1 second.  
**KF:** transformer K factor.

Figure 8-19: L1 simultaneous display screen

**Note:** L2 and L3 provide the simultaneous display of the current and voltage for phases 2 and 3, respectively.

### 8.6.5. Screen for simultaneous display of neutral

This screen displays the RMS voltage and current of the neutral, the DC component of the neutral voltage.

### 8.7. Display of phasor diagram

The  sub-menu displays a vector representation of the fundamentals. It indicates their associated quantities: the modulus of the vectors, phases and unbalances of the voltages and currents.

#### 8.7.1. The 3V phasor diagram display screen

This screen displays a vector representation of the fundamentals. It indicates their associated quantities: the modulus of the vectors and unbalances of the phase-to-neutral voltages, phase angle of phase-to-neutral voltage with respect to current.

The following information is displayed:

Column of values for each vector (1, 2, and 3).

**|V1|, |V2| and |V3|**: moduli of the vectors of the phase-to-neutral voltages (phases 1, 2 and 3).

**Φ 12**: phase angle of the fundamental of phase 1 with respect to the fundamental of phase 2.

**Φ 23**: phase angle of the fundamental of phase 2 with respect to the fundamental of phase 3.

**Φ 31**: phase angle of the fundamental of phase 3 with respect to the fundamental of phase 1.

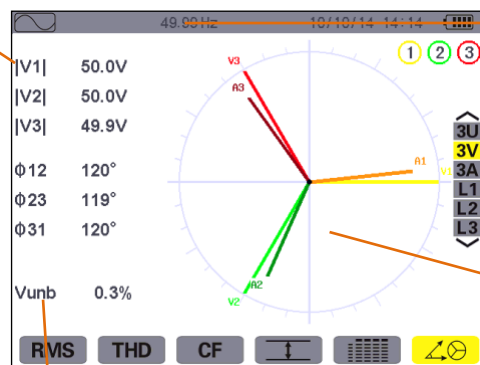

Instantaneous frequency of network.

Channel number and color.

Vector diagram.

**Vunb**: voltage unbalance.

Figure 8-20: the screen Displaying the Vector diagram in 3V

#### 8.7.2. The 3U phasor diagram display screen

This screen displays a vector representation of the fundamentals. It indicates their associated quantities: the modulus of the vectors, phase angle and unbalances of the phase-to-phase voltages.

The displayed information is identical to that described in § 8.7.1 but relative to the phase-to-phase voltages.

#### 8.7.3. The 3A phasor diagram display screen

This screen displays a vector representation of the fundamentals. It indicates their associated quantities: the modulus of the vectors, phase angle and unbalances of the currents.

The displayed information is identical to that described in § 8.7.1 but relative to the current.

#### 8.7.4. The L1 phasor diagram display screen

This screen displays a vector representation of the fundamentals. It indicates their associated quantities: the modulus of the vectors of voltage and current of phase 1, phase angle of voltage with respect to current of phase 1.

The following information is displayed:

- V1:** modulus of the vector of the fundamental of the phase-to-neutral voltage of phase 1.
- A1:** modulus of the vector of the fundamental of the current.
- φ VA:** phase angle of phase 1 with respect to current.

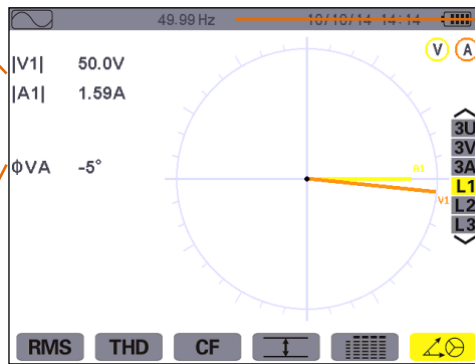

- Instantaneous frequency of network.
- Channel number and color.

Figure 8-21: the screen Displaying the Vector diagram in L1

**Note:** L2 and L3 displays a vector representation of the fundamentals. It indicates their associated quantities: the modulus of the vectors of voltage and current of phase 2 and 3, respectively, phase angle of voltage with respect to current of phase 2 and 3, respectively.

## 9. Alarm Mode Key

The  mode detects overshoots of thresholds (Vrms, Urms, Arms, PST, Vcf, Ucf, Acf, Vunb, Aunb, Hz, KF, Vthd, Uthd, Athd, |W|, |VAR|, VA, |cos Φ|, |PF|, |tan Φ| Vh, Uh, Ah, and |VAh|) programmed in the configuration mode.

The user should program an alarm threshold (hysteresis) first and then start the alarm campaign. The values to be monitored:

- ★ were defined by the *Configuration / Alarm mode* screen (see § 5.10).
- ★ select the setting parameters (red solid dot indicate selected, red hollow dot indicate not selected).

You can capture over 12,800 alarms. Stored alarms can subsequently be transferred to a PC to save and (see corresponding manual).

### 9.1. Available submenus

The submenus are listed on the screen below and described individually in the paragraphs that follow.

The sub-menus are selected using the yellow keys on the keypad below the screen.

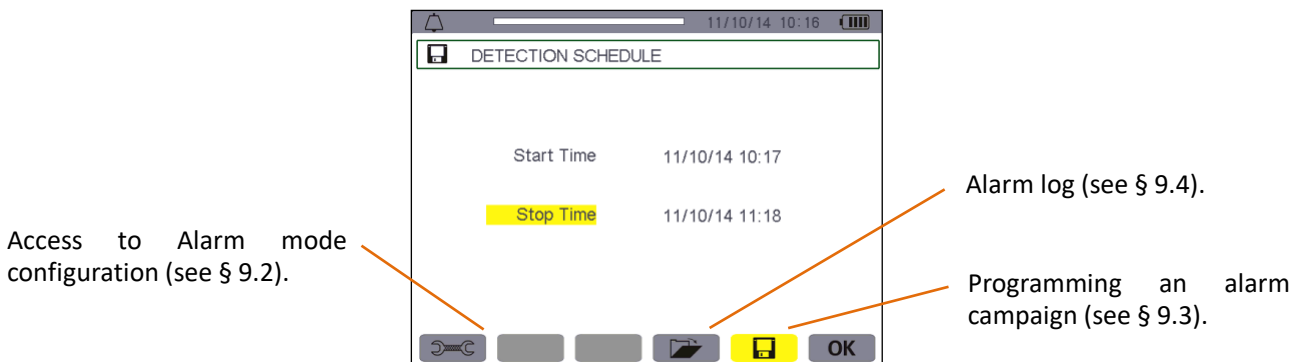





Figure 9-1: the Alarm Mode screen

The **OK** and  icons have the following functions:

- ★ **OK:** Validating the programming of a campaign and starting the alarm campaign (see § 9.3.2).
- ★ : Voluntary stoppage of alarm campaign (see § 9.3.3).

## 9.2. Alarm mode configuration

The  submenu displays the list of alarms configured (see § 5.10). This shortcut key lets you define or change alarm configurations.

The following information is displayed:

Reminder of the mode used.

Selected (red solid dot) or cancel the alarm Type of alarm (VAh, Ah, Uh, Vh, Tan, PF, Cos, VA, VAR, W, Athd, Uthd, Vthd, KF, Hz, Aunb, Vunb, Acf, Ucf, Vcf, PST, Arms, Urms, Vrms).

Order of harmonics (between 0 and 50, for Vah, Ah, Uh and Vh).

Alarm filter (3L: 3 phases monitored individually, or N: monitoring of neutral, or Σ: monitoring of the sum (VA, VAR, W), or  $\bar{x}$ : monitoring of the mean (Tan, PF, Cos).

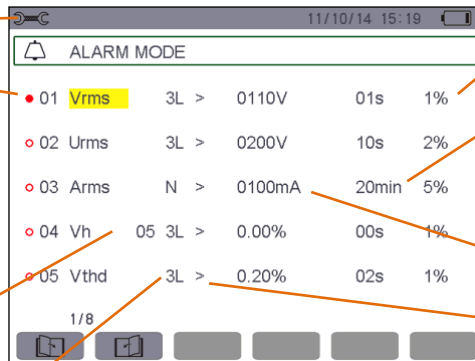

The hysteresis (choice values: 1%, 2%, 5% or 10%).





The minimum duration above or below the threshold required for alarm validation (can set 0 second to 99 minutes).

Alarm triggering threshold.







Alarm direction (> or < triggered when the trigger threshold).

Icon for browsing pages. Press the yellow keys corresponding to these icons to display the pages.

Figure 9-2: Alarm mode configuration screen

**Reminder:** Use the  or  keys to browse vertically in the fields. Use the  or  keys to browse horizontally in the fields.

Proceed as follows to configure an alarm:

- ★ Select the field by pressing . The arrows  appear.
- ★ Enter values by pressing  or , then validate via . The field is highlighted in yellow. Do the same for all values to be entered in the fields.
- ★ Activate the configured alarm by placing the yellow cursor on the browsing column and pressing . Red solid dot indicates selected. When the condition is met the alarm can be triggered, generate the alarm log.

**Note:** To deactivate the alarm, repeat the last step.

★ Press  to return to the *Programming a campaign* screen.

## 9.3. Programming an alarm campaign

The  submenu is used to specify the start and stop times for an alarm campaign.

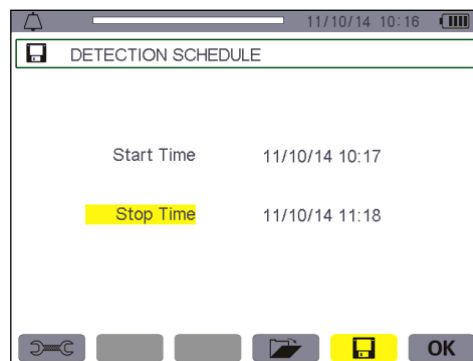

Figure 9-3: Example of an alarm campaign programming screen

### 9.3.1. Stage 1: programming the start/stop times

Proceed as follows:

- ★ Select the Start field using the or key. The selected field is highlighted in yellow. Press to enter the values. The arrows appear in the start date and time campaign programming field. Press or to increment or decrement a value and or to move to the next item.

**Note:** The start date and time must be after the current date and time.

- ★ Press to validate the programming of the Start date and time.
- ★ Select the Stop field using the or key. The selected field is highlighted in yellow. Press to enter the values. The arrows appear in the Stop date and time campaign programming field. Press or to increment or decrement a value and or to move to the next item.

**Note:** The Stop date and time must be after the start date and time.

- ★ Press to validate the programming of the Stop date and time.

### 9.3.2. Stage 2: starting the alarm campaign

Press the yellow key corresponding to the **OK** icon to start the alarm campaign between the start and stop times you specified.

- The **OK** icon disappears and the icon appears in its place.
- The *Campaign on standby* message is displayed while awaiting the start time and the icon blinks in the screen's top display bar.
- The *Campaign running* message is displayed when the Start time is reached.
- The *Campaign schedule* screen and **OK** icon are displayed when the Stop time is reached. You can then program another campaign.

### 9.3.3. Voluntary stoppage of alarm campaign

The alarm campaign can be voluntarily stopped before the Stop date and time by pressing the yellow key corresponding to the icon (bottom right-hand corner of the screen). The **OK** icon then reappears in its place.

## 9.4. Viewing the alarm log

The submenu displays the alarm log. The log can contain up to 12,800 alarms. Press the yellow key corresponding to the icon to view this alarm log.

**Note:** the type of connection selected in the mode does not affect which alarm filters can be chosen and which parameters monitored. Users are responsible for these choices.

The following information is displayed:

Alarm log memory usage. The black part of the bar corresponds to the fraction of memory used.

Alarm date and time.

Target of the alarm detected.

Parameter of the alarm detected.

Alarm date and time	Level	Target	Parameter	Threshold	Amplitude	Duration
08/10/13 09:25	L2	Uthd	KF	>0.2%	0.5%	3.00s
08/10/13 09:25	L3	Uthd	KF	>0.2%	0.5%	3.00s
08/10/13 09:25	L1	Vthd	KF	>0.2%	0.5%	3.00s
08/10/13 09:25	L2	Vthd	KF	>0.2%	0.5%	3.00s
08/10/13 09:25	L3	Vthd	KF	>0.2%	0.5%	3.00s
08/10/13 09:25	L1	KF	KF	>0.20	0.50	3.00s
08/10/13 09:25	L2	KF	KF	>0.20	0.50	3.00s
08/10/13 09:25	L3	KF	KF	>0.20	0.50	3.00s

Trigger threshold and trigger direction > or <.

Extremum of the alarm detected (minimum or maximum).

Press or to select to display the alarm log corresponding trigger phase.

Alarm duration.

Figure 9-4: Alarm list screen



**Reminder:** At alarm log, the default units of monitored parameters corresponding the trigger threshold and trigger amplitude as follows:

Table 9-1

Monitored parameters	Default units	Units with the suffix	Example
Arms	A	m: express mA k: express kA	2.5: express 2.5A 423m: express 423mA
Vrms/Urms	V	k: express kV	326: express 326V 1.2k: express 1.2kV
W/VAR/VA	W/Var/VA	K: express kW/kVar/kVA M: express MW/MVar/MVA	W parameter: 315 express 315W W parameter: 5.8k express 5.8kW
Hz	Hz		50.00: express 50.00Hz

### 9.5. Deleting the alarm log

The  submenu is used to delete the whole log. To do this, proceed as follows:

Select the submenu by pressing the yellow key corresponding to the  icon. The  icon displayed yellow indicate ready to delete, then press the yellow key corresponding to the icon to cancel the delete state. The icon displayed gray  indicate don't delete.

In the state of ready to delete, press  to delete the whole alarm log. The log is empty.

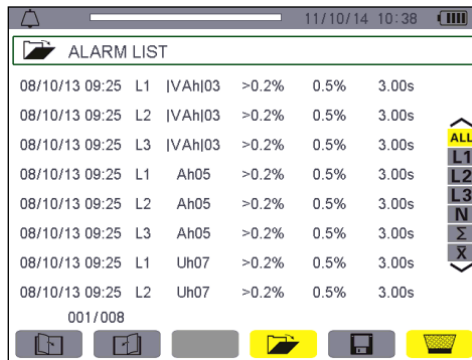



Figure 9-5: Alarm list screen in delete mode

## 10. Trend Mode Key

The  mode records changes to parameters previously specified in the Configuration/Trend mode screen (see § 5.9).

### 10.1. Available sub-menus

The sub-menus are listed in the screen below and described individually in the paragraphs that follow. The sub-menus are selected using the yellow keys on the keypad below the screen.

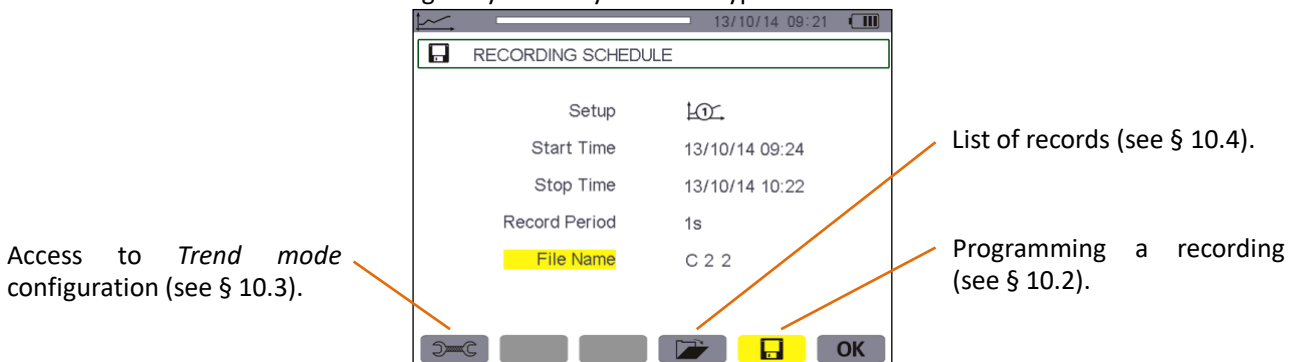



Figure 10-1 Trend mode screen

The **OK** icon confirms the programming of a recording (see § 10.2).

## 10.2. Programming and starting recording

The  submenu specifies the parameters of a new recording campaign.

SD memory card usage. The black part of the bar corresponds to the fraction of memory used.

Access to *Trend mode* configuration (see § 10.3).

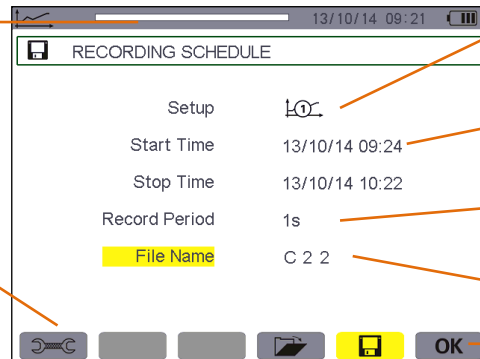

Select the recording parameters configuration (see § 10.3).

Start time and stop time of record.

Record period, that is the interval time.









File name.



Press yellow key corresponding to the **OK** to start recording.









Figure 10-2: Example of preset recording screen

### 10.2.1. Stage 1: programming of parameters











Proceed as follows:

- ★ Select the *Configuration* field using the  or  keys. The selected field is highlighted in yellow. Press  to enter the type of configuration. The arrows   appear.
- ★ Select the configuration to be used by browsing using the  or  keys. Press  to validate.









**Reminder:** Configurations  to  were defined in the *Configuration / Trend mode* screen (see § 5.9). The configuration procedure is also described in § 10.3.

- ★ Select the *Start* field using the  or  keys. The selected field is highlighted in yellow. Press  to enter the values. The arrows   appear in the recording start date and time programming field. Press  or  to increment or decrement a value and  or  to switch year, month, day, hour, minute.









**Note:** The start date and time must be later than the current date and time.

- ★ Press  to validate the programming of the **Start** date and time.
- ★ Select the **Stop** field using the  or  keys. The selected field is highlighted in yellow. Press  to enter the values. The arrows   appear in the recording stop date and time programming field. Press  or  to increment or decrement a value and  or  to switch year, month, day, hour, minute.



**Note:** The stop date and time must be later than the start date and time. The longest recording time can be programmed see § 10.6.4.

- ★ Press  to validate the programming of the **Stop** date and time.
- ★ Select the **Period** field using the  or  keys and press  to enter the value. The arrows   appear.
- ★ Press  or  to increment or decrement the possible values (1 s, 5 s, 20 s, 1 min, 2 min, 5 min, 10 min, or 15 min).
- ★ Press  to validate.

**Note:** The recording interval period is the time over which the measurements of each recorded value are averaged (arithmetic mean). That is how often a data record.

- ★ Press  or  to highlight the Name box in yellow and press  to enter edit mode. Enter the name of the recording (not more than 8 characters, records shall use a different name, file name intermediate cannot appear spaces).  
The available alphanumeric characters are the uppercase letters from A to Z and the digits from 0 to 9. Use the  or  keys to display a character and  or  to move to the adjacent character.
- ★ Press  to validate the name.

### 10.2.2. Stage 2: starting a programmed recording

- Press the yellow key corresponding to the **OK** icon (bottom right-hand corner of the screen) to begin recording between your specified start and stop times.  
The **OK** icon disappears and the  icon appears in its place.
- The Recording on standby message is displayed while awaiting the start time and the  icon blinks in the screen's top display bar.
- The Recording running message is displayed when the start time is reached.

Progress of active recording.





Recording can be voluntarily stopped by pressing the yellow key corresponding to the  icon.

Figure 10-3: Display screen while recording is in progress

- The Recording schedule screen and **OK** icon (bottom right-hand corner of the screen) reappear when the stop time is reached. The **OK** icon then reappears in its place.



### 10.2.3. Voluntary stoppage of recording in progress

Recording can be voluntarily stopped before the stop date and time by pressing the yellow key corresponding to the  icon (bottom right-hand corner of the screen). The **OK** icon then reappears in its place.

### 10.3. Trend mode configuration



The  submenu displays the list of trend recording configurations (see § 5.9). This shortcut key lets you specify or modify the trend recording configurations.

The following information is displayed:

List of monitoring parameters, press   to move the cursor, then press  to select or cancel select. Red solid dot indicates selected, red hollow dot indicates unselected.

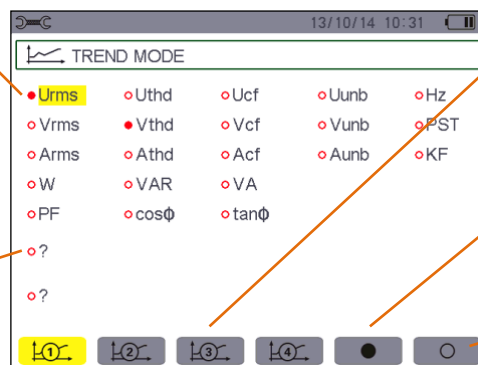
VAh, Ah, Vh, and Uh harmonics recording configuration. "?" indicate not select any harmonic



Type of configuration icons ( to .







Select all the parameters.

Cancel select all the parameters.

Figure 10-4: Trend mode monitoring parameter configuration screen

Proceed as follows to configure a recording:

Example for configuration 1:

- ★ Press the yellow key corresponding to the  icon. It is displayed on a yellow ground.
- ★ Select values by moving the yellow cursor using the  or  and  or  keys, then press  to validate. The red solid dot indicates validation.

Reminder: You can record the following values:

Unit	Designation
Urms	RMS phase-to-phase voltage(2 $\phi$ , 3 $\phi$ ).
Uthd	Total harmonic distortion of the phase-to-phase voltage(2 $\phi$ , 3 $\phi$ ).
Ucf	Crest (peak) factor of phase-to-phase voltage(2 $\phi$ , 3 $\phi$ ).
Uunb	Phase-to-Phase voltage unbalance(2 $\phi$ , 3 $\phi$ ).
Hz	Network frequency.
Vrms	RMS phase-to-neutral voltage.
Vthd	Total harmonic distortion of the phase-to-neutral voltage.
Vcf	Crest factor of phase-to-neutral voltage.
Vunb	Phase-to-neutral voltage unbalance(2 $\phi$ , 3 $\phi$ ).
PST	Short-term flicker.
Arms	RMS current.
Athd	Total harmonic distortion of the current.
Acf	Crest factor of current.
Aunb	Current unbalance(2 $\phi$ , 3 $\phi$ ).
KF	K factor.
W	Active power.
VAR	Reactive power.
VA	Apparent power.
PF	Power factor.
Cos $\phi$	Phase shift of power factor.
Tan $\phi$	Tangent.
?	See comment below.

Features specific to the last two lines.

These are recalled below:



Figure 10-5: These two lines involve harmonics

The starting harmonic order to be selected.

VAh, Ah, Vh, and Uh monitoring configuration. "?" indicates not select any harmonic

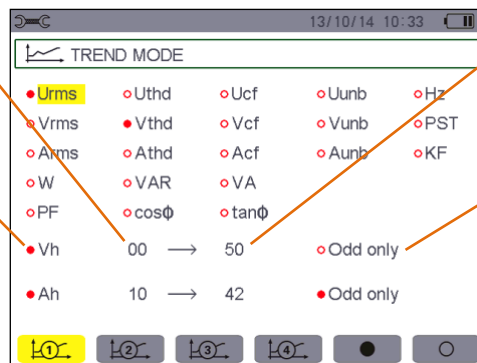

The last harmonic order to be selected.

Select recording odd only harmonics.

Figure 10-6: Trend mode recording parameter configuration screen

These two lines involve the recording of Vah, Ah, Vh and Uh variable harmonics. You can select the ranks of harmonics to be recorded (between 0 and 50) for each of these harmonics and odd only harmonics within this range. Proceed as follows:

- **To enter the value to be recorded:** with line o ? highlighted in yellow, press . The arrows appear. Select the value (Vah, Ah, Vh, and Uh) for which harmonics are to be recorded by pressing or . The red solid dot identifies your selection.

Confirm by pressing . The values field is highlighted in yellow.

- **To select the starting harmonic order:** with the field highlighted in yellow, press . The arrows appear. Select the order from which the harmonics are to be recorded by pressing or , then validate by pressing .

Press or to go to the next field.

- **To select the last harmonic:** with the second field (greater than or equal to the starting harmonic order) highlighted in yellow, press . Select the highest harmonic order to be recorded by pressing or , then validate by pressing .

Press or to go to the next field.

- **For the odd harmonics only:**

To select or deselect this function, press . The red solid dot identifies your selection:

- ★ selected, only odd harmonics between the two orders of harmonics specified in the previous points are recorded.
- ★ not selected, all harmonics (even and odd) between the two orders of harmonics specified in the previous points are recorded.

## 10.4. Viewing the recording list

The submenu displays recordings already made. Press the yellow key corresponding to the icon to see the list.

The following data is displayed:

Alarm log memory usage. The black part of the bar corresponds to the fraction of memory used.

Recording name.

Recording Name	Recording Start Time	Recording Stop Time
A	28/09/14 12:06	> 28/09/14 12:07
B	28/09/14 13:27	> 28/09/14 13:31
<b>A18</b>	<b>11/10/14 10:43</b>	<b>&gt; 11/10/14 10:46</b>

Recording stop time.

Recording start time.

Figure 10-7: Recording list display screen

## 10.5. Deleting recordings

The submenu is used to delete recordings. Proceed as follows:

- ★ Select the recording to be deleted using the or keys. The selected field is bolded.
- ★ Select the submenu by pressing the yellow key corresponding to the icon. The icon displayed yellow indicate ready to delete, then press the yellow key corresponding to the icon to cancel the delete state. The icon displayed gray indicate don't delete.
- ★ In the state of ready to delete, press to validate the deletion.

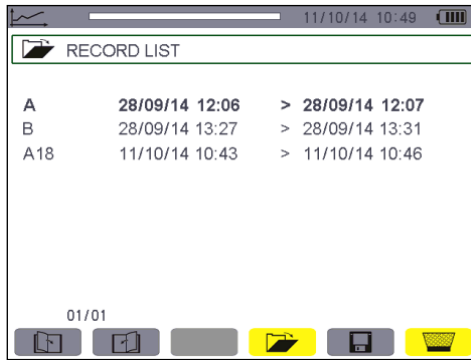

Figure 10-8: Recording list screen in delete mode.

## 10.6. Viewing the records

### 10.6.1. Characteristics of the record

Record parameters: name, start time, stop time, record period.

Monitoring parameters of selected records. Press the yellow key corresponding to the parameter icon to open the corresponding curve.

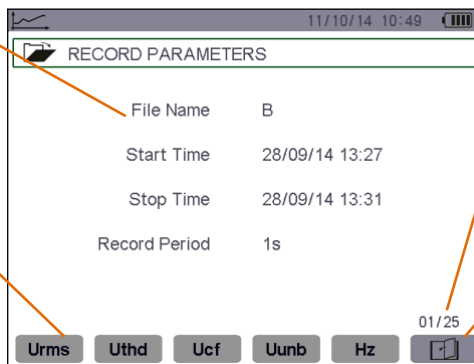

The page number and the number of pages.

Press the yellow key corresponding to the icon to navigate in the following screen pages. It is also possible to use the and

Figure 10-9: Recording list sub-menu screen in trend mode

### 10.6.2. Trend curves

Date of cursor.  
Recorded values of the cursor.  
There are trend curve on the left of the visible part.  
Cursor. Use the or and keys to move the cursor. Long press can move quickly.

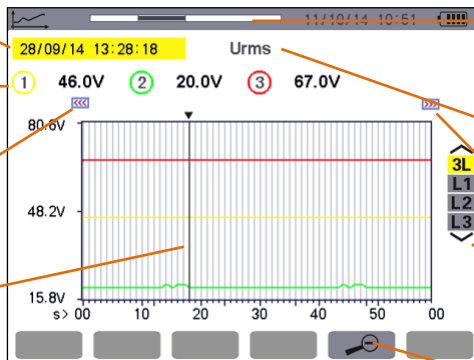

Position of the viewing window in the record, black represents the current screen.  
Parameter name of trend chart curves.  
There are trend curve on the right of the visible part.  
To select the display curve, press the or key.  
Zoom out, switch the time scale.

Figure 10-10: Vrms without MIN-AVG-MAX

**Remark:** Values of the cursor is dashes “----” indicate errors or missing values in the record.

The display period of this curve is 20 seconds. Since the period of the record is one second, each point of this curve corresponds to a value recorded in a one-second window once 20 seconds. There is therefore a substantial loss of information (19 values out of 20), but the display is rapid.

With the increase of the display period, the loss values will be more. This case the user can select to activate the MIN-AVG-MAX mode. After the MIN-AVG-MAX mode activated, each point of the curve represents the mean of the total sampling points every period (such as the display period is 20 seconds, sampling period is 1 second, each display point of the curve represents the mean of 20 values recorded every second.).

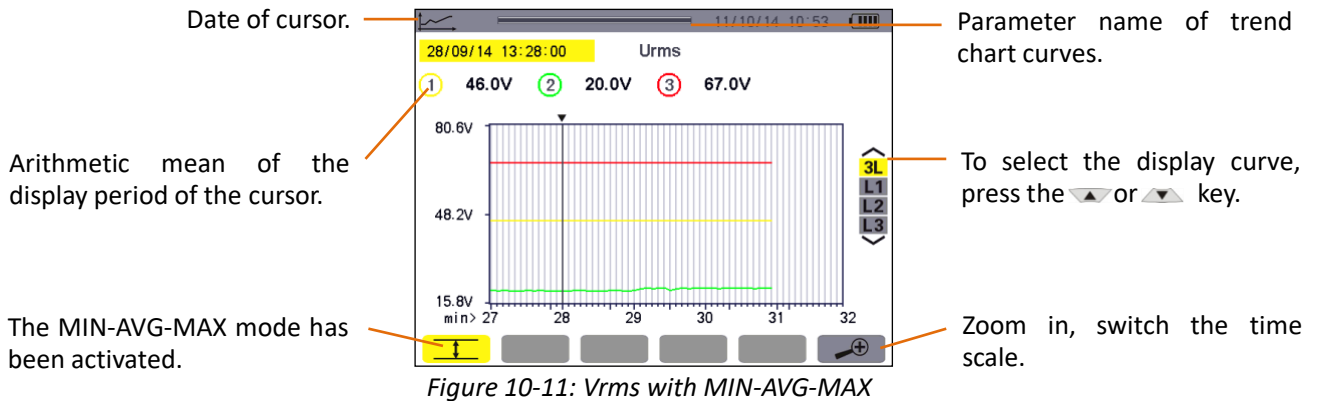

Figure 10-11: Vrms with MIN-AVG-MAX

With the MIN-AVG-MAX mode activated, each point of this curve represents the arithmetic mean of 60 values recorded. This display is therefore more precise, because there is no loss of information, but slower (display time see §10.6.3).

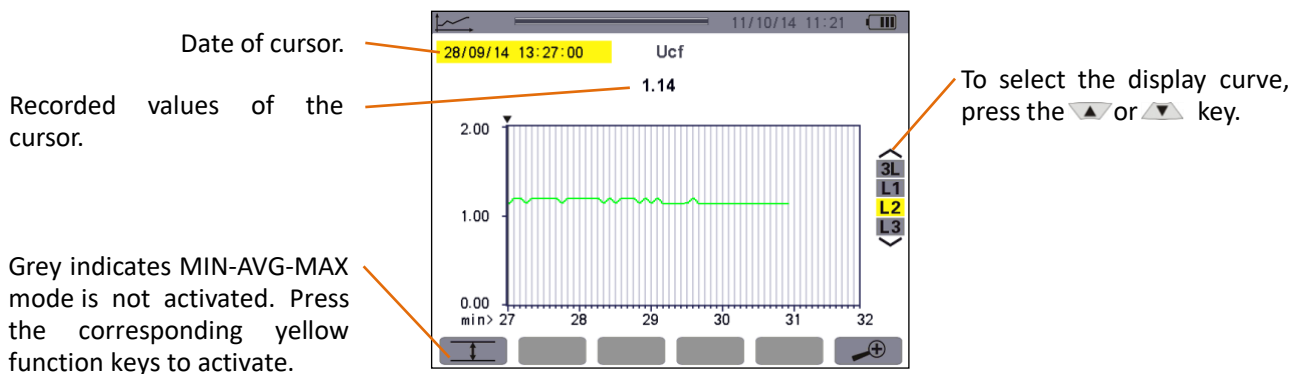

Figure 10-12: Ucf (L2) without MIN-AVG-MAX

With the MIN-AVG-MAX mode is not activated, display the curve of 60 values recorded of the cursor, the display is rapid.

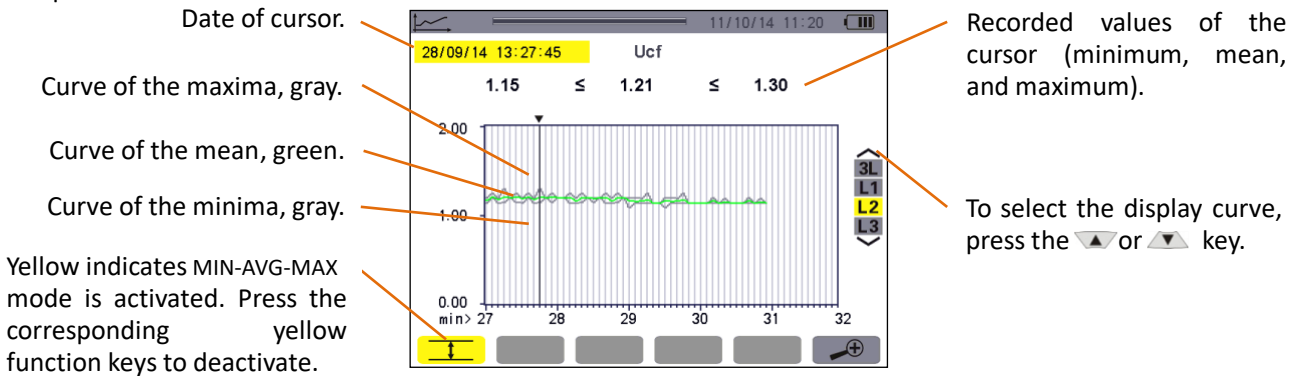

Figure 10-13: Ucf (L2) with MIN-AVG-MAX

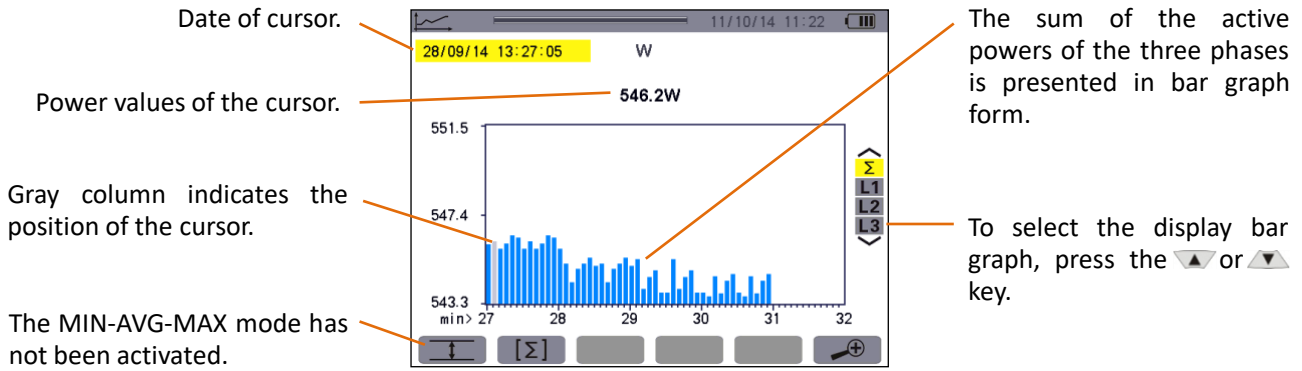

Figure 10-14: total active power without MIN-AVG-MAX

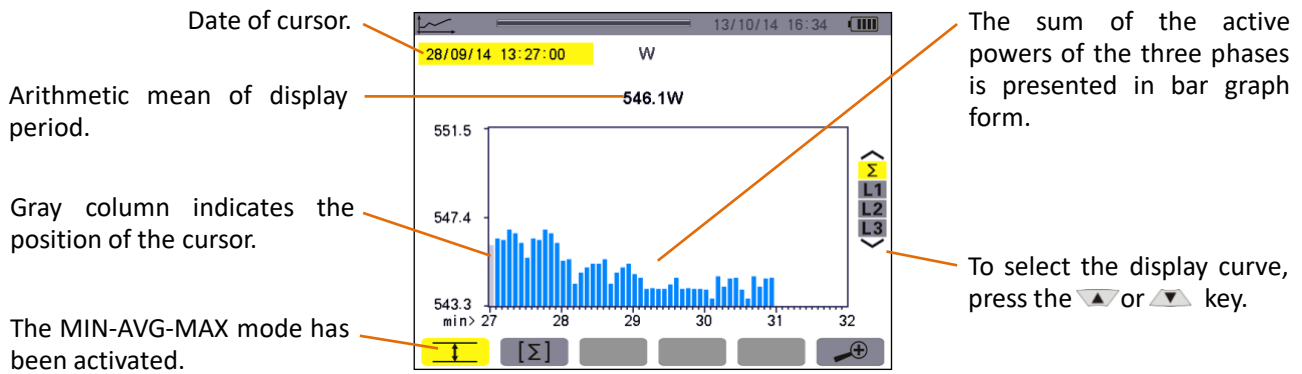

Figure 10-15: total active power with MIN-AVG-MAX

This curve differs slightly from the previous one because, with the MIN-AVG-MAX mode, there is no loss of information.

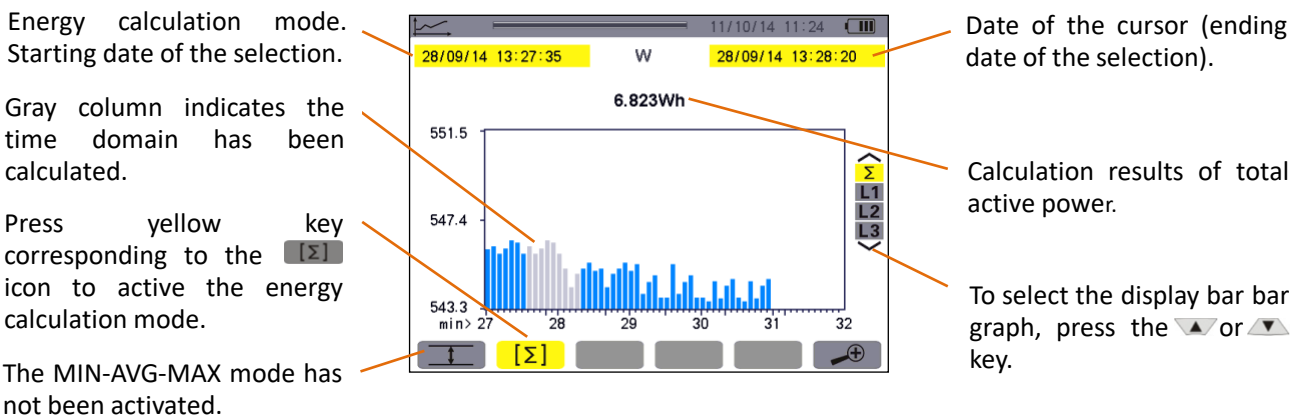

Figure 10-16: total active energy without MIN-AVG-MAX

Energy calculation steps:



- ★ Press yellow key corresponding to the  $\Sigma$  icon to activate the energy summation mode. The current cursor time is the starting time of the energy calculation.
- ★ Press the  $\blacktriangleleft$  or  $\blacktriangleright$  to move the cursor. The stopping time of the energy calculation pointing the cursor time, the device calculates the energy between the start time and stop time automatically.

**Note:** the cursor moves left cannot exceed the location of the starting time.



### 10.6.3. The needing time for display the curve in the different scale.

The following table indicates the time needed to display the curve on screen as a function of the width of the display window for a recording period of one second:

width of display window 60 points or increments)	Grid increment	Typical waiting time
5 days	2 hours	30 seconds
2.5 days	1 hour	15 seconds
15 hours	15 minutes	4 seconds
10 hours	10 minutes	2 seconds
5 hours	5 minutes	1 second
1 hour	1 minutes	1 second
20 minutes	10 seconds	1 second
5 minutes	5 seconds	1 second
1 minute	1 second	1 second

★ to press the  or  key to change the scale of the display

★ to press the  or  key to move the cursor

★ to press the  or  key to change the display phase curve.

But note that this may restart the loading/calculation of the values from the beginning.

### 10.6.4. The longest recording time can be programmed

The longest time is base on the number of the recording parameters selection and the sampling period, the typical condition as follows:

parameter of selected	sampling period	Typical longest time can be programmed
All parameters (total 123)	1 second	10 days
1~20 parameters	1 second	62 days
All parameters (total 123)	5 seconds	50 days
1~20 parameters	5 seconds	300 days
All parameters (total 123)	1 minutes	600 days
1~20 parameters	1 minutes	3600 days

The above table indicates that the selected parameters is less, the sampling period is greater, the longest recording time is longer.

## 11. Power And Energy Key

The **w** key displays power- and energy-related measurements.

### 11.1. Available sub-menus

The sub-menus are listed in the screen below and described individually in the paragraphs that follow.

The sub-menus are selected using the yellow keys on the keypad below the screen.

The date and time at which energy metering starts.

Display of energy generated.

Display of energy consumed.

Display of PF, DPF, and tan  $\Phi$ .

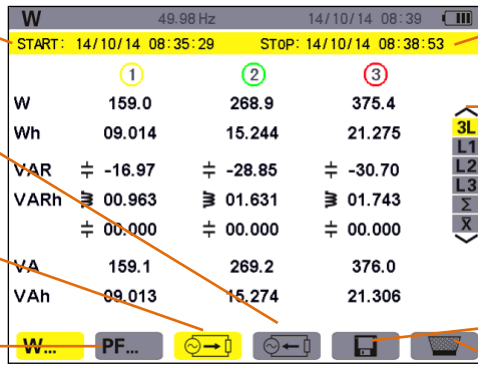

The date and time at which energy metering stops.

Select displayed corresponding power and energy, use ▲ or ▼.   
 $\Sigma$ : sum of 3 phases.   
 $\bar{X}$ : Arithmetic mean of 3 phases (such as PF)

Start of energy metering.

Reset of energy meter.

Figure 11-1: the Power and energy mode screen

## 11.2. Energy consumed

The sub-menu displays the active power, the reactive powers (capacitive and inductive), the apparent power.

### 11.2.1. The energies consumed screen for the 3 phases (3L)

This screen displays the following information:

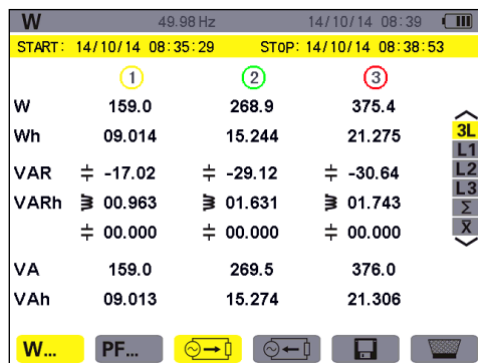

Figure 11-2: the energies consumed screen for the 3 phases (3L)

Unit	Designation
W	Active power.
Wh	Active energy consumed.
VAR	Reactive power (inductive $\Rightarrow$ or capacitive $\Leftarrow$ ).
VARh	Reactive energies consumed (inductive $\Rightarrow$ or capacitive $\Leftarrow$ ).
VA	Apparent power.
VAh	Apparent energy consumed.

### 11.2.2. The energies consumed screen for phase L1

This screen displays the following information:

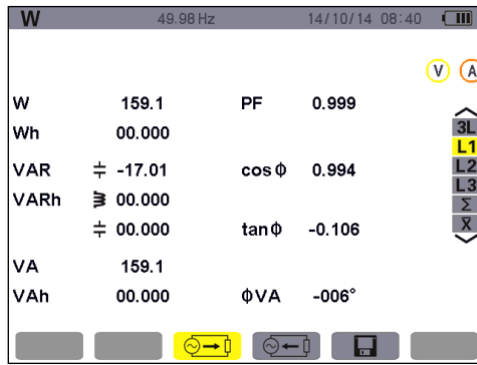

Figure 11-3: the energies consumed screen for phase L1

Unit	Designation
<b>W</b>	Active power.
<b>Wh</b>	Active energy consumed.
<b>VAR</b>	Reactive power(inductive ≡ or capacitive ±).
<b>VARh</b>	Reactive energies consumed(inductive ≡ or capacitive ±).
<b>VA</b>	Apparent power. (Σ: sum of 3 phases)
<b>VAh</b>	Apparent energy consumed.
<b>PF</b>	Power factor.
<b>Cosφ</b>	Phase shift of power factor
<b>Tanφ</b>	Tangent factor
<b>φVA</b>	Phase shift of phase-to-neutral voltage with respect to current.

**Note:** Filters L2 and L3 display the same information for phases 2 and 3. Σ screen display total power and energy consumed values for the 3 phases.

### 11.3. Power factor display screen

This screen page is available only with the 3L filter. To display the information, press the yellow key on the keypad corresponding to the **PF...** icon.

The following data is displayed:

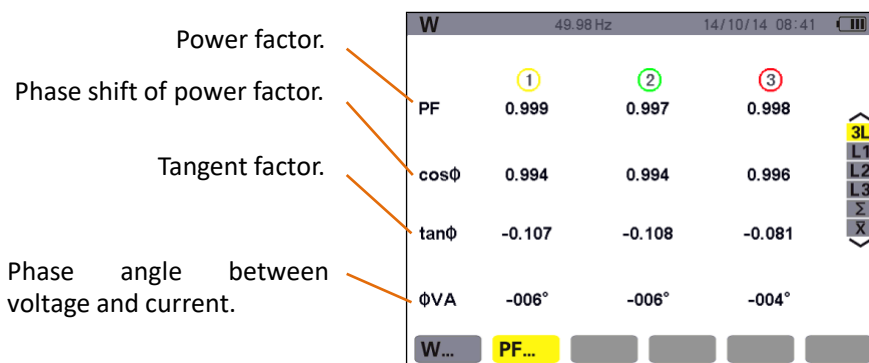

Figure 11-4: the Power factor screen for the 3 phases (3L)

### 11.4. The sums of energies consumed display screen

To display the information, select the Σ icon of the right-hand filter. This screen displays the following information:

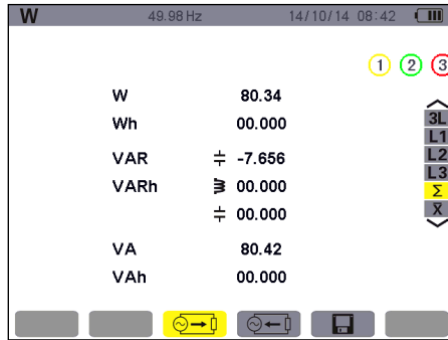

Figure 11-5: the sums of energies consumed display screen

Unit	Designation
W	Total active power.
Wh	Total active energy consumed.
VAR	Total reactive power, inductive $\sum$ or capacitive $\pm$ .
VARh	Total reactive energies consumed, inductive $\sum$ or capacitive $\pm$ .
VA	Total apparent power.
VAh	Total apparent energy consumed.

### 11.5. The arithmetic mean values of power factor display screen

To display the arithmetic mean values for the 3 phases (for power factor, phase shift of power factor and tangent), select the  $\bar{X}$  icon of the right-hand button.

This screen displays the following information:

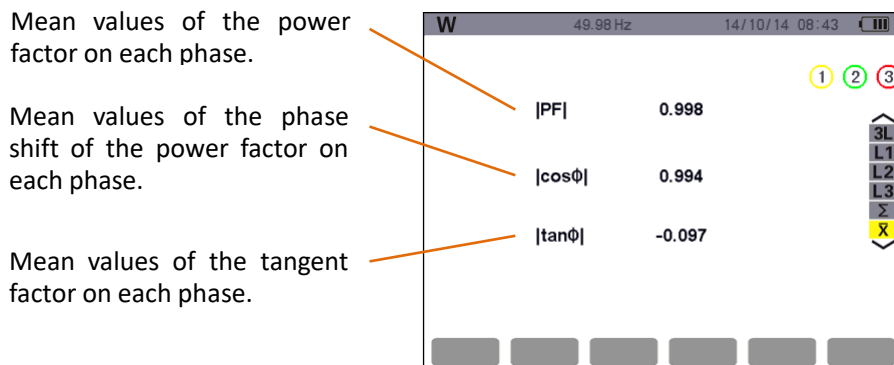

Figure 11-6: the Arithmetic mean values screen for the 3 phases

### 11.6. Energies generated

The  $\leftarrow$  sub-menu displays the active power, the reactive powers (capacitive and inductive), the apparent power, and all associated energies generated.

#### 11.6.1. The energies generated screen for the 3 phases (3L)

This screen displays the following information:

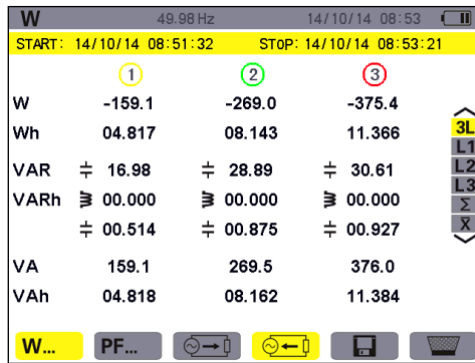

Figure 11-7: the Energies generated screen for the 3 phases (3L)

Unit	Designation
<b>W</b>	Active power.
<b>Wh</b>	Active energies generated.
<b>VAR</b>	Total reactive power, inductive $\equiv$ or capacitive $\pm$ .
<b>VARh</b>	Total reactive energies generated, inductive $\equiv$ or capacitive $\pm$ .
<b>VA</b>	Total apparent power.
<b>VAh</b>	Total apparent energy generated.

### 11.6.2. The energies generated display for phase L1

This screen displays the following information:

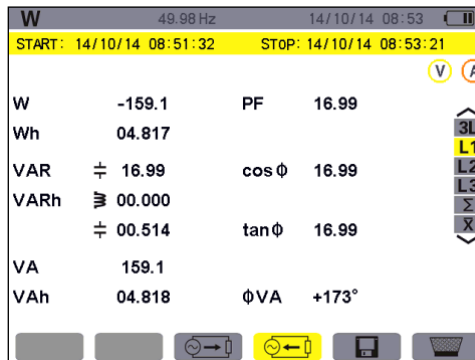

Figure 11-8: the energies generated display for phase L1

Unit	Designation
<b>W</b>	Active power.
<b>Wh</b>	Active energies generated.
<b>VAR</b>	Total reactive power, inductive $\equiv$ or capacitive $\pm$ .
<b>VARh</b>	Total reactive energies generated, inductive $\equiv$ or capacitive $\pm$ .
<b>VA</b>	Total apparent power.
<b>VAh</b>	Total apparent energy generated.
<b>PF</b>	Power factor.
<b>Cos φ</b>	Phase shift of power factor.
<b>Tan φ</b>	Tangent factor.
<b>φVA</b>	Phase angle between voltage and current.

**Note:** Filters L2 and L3 display the same information for phases 2 & 3.  $\Sigma$  screen display total power and energy generated values for the 3 phases.

### 11.6.3. The sums of energies generated display screen

To display the information, select the  $\Sigma$  icon.

This page displays:

- ★The total active power,
- ★The total active energy generated,
- ★The total reactive power, inductive  $\equiv$  or capacitive  $\neq$ ,
- ★The total reactive energies generated (inductive  $\equiv$  and capacitive  $\neq$ ),
- ★The total apparent power,
- ★The total apparent energy generated.

### 11.7. Starting energy metering

To start metering, press the yellow key on the keypad corresponding to the  icon:

The date and time at which energy metering starts.

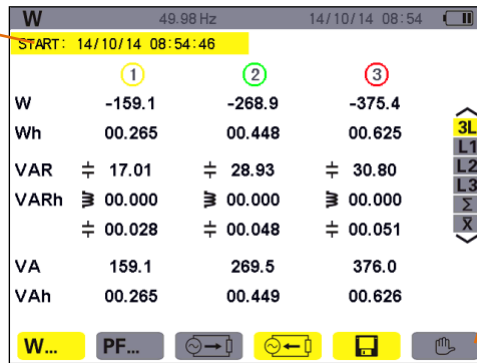



The  icon appears after metering starts, To stop energy metering, press the yellow key on the keypad corresponding to the  icon.

Figure 11-9: the Power and energies mode screen when energy metering is started

### 11.8. Stopping energy metering

To stop energy metering, press the yellow key on the keypad corresponding to the  icon.

The date and time at which energy metering starts.

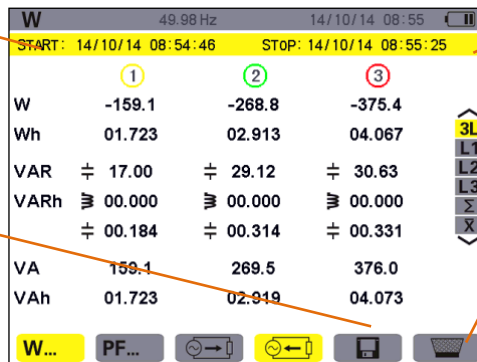

Display the date and time at which metering stops after press the  icon.

After stop metering, if no reset, press the yellow key corresponding to the  icon to continue metering.







The  icon appear after stop metering, press the yellow key corresponding to the  icon to reset metering.

Figure 11-10: the Power and energies mode screen when energy metering is stop

### 11.9. Reset of energy metering

To reset metering, press the yellow key on the keypad corresponding to the  icon, The  icon displayed yellow indicate ready to delete, then press the yellow key corresponding to the  icon to cancel the delete state.

In the state of ready to delete, press the  key to confirm. All energy values (consumed and generated) are reset.

**Note:** refer to the 4-quadrant power diagram in § 17.3.









## 12. Screen Snapshot Key









The  key can be used to:

- ★Capture a maximum of 60 screens for future reference (see § 12.1).
- ★display previously saved screen snapshots (see § 12.2).

Saved screens may then be transferred to a PC using the USB.

### 12.1. Screen snapshots

Press  for approx. 3 seconds to shoot any screen (including the , , , , ,  and  mode screens).

During the capture, the  icon appears in the top left corner of the screen instead of the icon for the active mode (, , , , , , ). The active mode icon reappears when you release the  key: the device has saved the image.

**Reminder:** the device can save a maximum of 60 screen snapshots. If the user attempt to take a 61st screen snapshot, first, upload the pictures you need to the computer through USB, then delete the device's snapshots before capture new pictures.

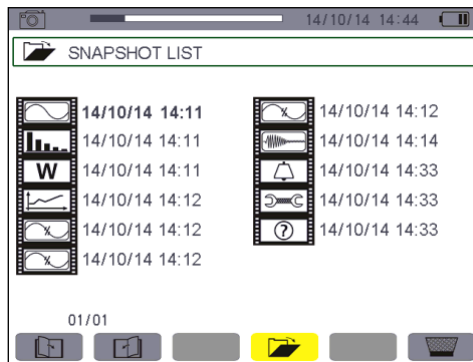

Figure 12-1: the snapshot list display screen

### 12.2. Handling of screen snapshots

This handling concerns stored screen snapshots, i.e.:

- ★ Display of the list of screen snapshots (see § 12.2.2).
- ★ Viewing of one of the screen snapshots (see § 12.2.3).
- ★ Deletion of one or more of the screen snapshots (see § 12.2.4).

#### 12.2.1. Available functions

To enter screen snapshot mode, briefly press the  key.

**Reminder:** holding the  key down for approximately 3 seconds triggers the screen snapshot function (See § 12.1).

Indicator of available image memory. The black bar represents memory used.

List of saved snapshots:  
The icons identify the type of snapshot saved (such as :harmonic mode).  
The date and time of each screen snapshot.

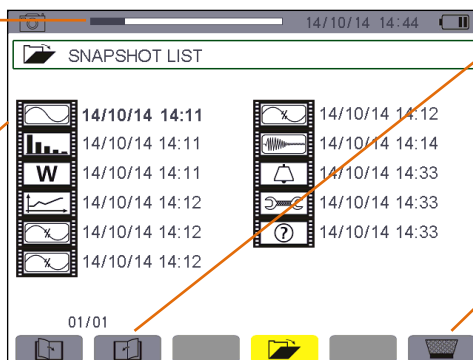

Screen page, the current page / total number of

Delete the snapshots of cursor.

Figure 12-2: example of the snapshot list display screen

#### 12.2.2. Viewing the list of snapshots

Press  briefly to display this list. The screen presents the list of snapshots (see figure 12-2).

### 12.2.3. Viewing a snapshot from the list

To view a snapshot, proceed as follows:

- ★ Press . The icon is active and the snapshot list screen is displayed (see figure 12-2).
- ★ Select the snapshot to be viewed using the or and or keys. The date and time of the selected snapshot are bolded.
- ★ Press to display the selected snapshot. The top left corner of the screen displays the icon, alternating with the icon corresponding to the active mode (such as :harmonic mode).
- ★ Press to return to the list of screen snapshots.

### 12.2.4. Deleting a snapshot from the list

To delete a snapshot, proceed as follows:

From the list of snapshots (see Figure 12-2 for example).

- ★ Select the snapshot to be deleted using the or and or keys. The date and time of the selected snapshot are bolded.
- ★ Press the yellow key on the keypad corresponding to the icon, The icon displayed yellow indicate ready to delete, then press the yellow key corresponding to the icon to cancel the delete state.
- ★ In the state of ready to delete, press the key to confirm.

Press to delete the selected snapshot. The snapshot is deleted from the list.

## 13. Help Key

The key provides information about the functions and symbols used in the current display mode. The following information is displayed:

The current mode and help mode icon.

Help page 2.

Help page 1.

List of help information.

V	Phase-to-neutral Voltage FFT
A	Line current FFT
VA	Phase-to-phase voltage FFT
U	Phase-to-phase voltage FFT
	Select display filter
	Expert mode (harmonic sequences)
	Zoom out
	Zoom in
	Select harmonic order[050]

Figure 13-1: example of the help page for the powers and energies mode, page 1

## 14. Data Uploaded To The Computer

To install a program, use the CD, then follow the on-screen instructions. Then connect the device to the PC using the USB cord supplied with the device, start the device, then open the data software to click on the computer's Power Quality Analyser.exe. Wait for software to automatically search and connect the device. For directions for using the data export software, refer to its user manual.

**Note:** Note: The transfer does not delete the data, just copy to the PC. At alarm/trend chart record/transient capture mode (pending or ongoing), PC cannot read the data.

## 15. General Specifications

### 15.1. Housing

<b>Housing</b>	Rigid shell overmoulded with a red thermo-adhesive elastomer.
<b>Connectors</b>	5 voltage measurement sockets.
	4 special current connectors.
	One connector for the specific mains power unit.
	One connector for the USB link.
	One connector for the SD memory card. This connector is located in the battery compartment on the back of the device.
<b>Keys</b>	Function, navigation, and mode. Can be used with gloves on.
<b>Hand strap</b>	Located on the side of the device, use to operation more convenient.
<b>Stand</b>	To hold the device in an inclined position.
<b>Battery cover</b>	To access the battery, on the back of the instrument.
<b>Dimensions</b>	Overall: 240×170×68mm Screen: 640×480 pixels W×H: 118mm×90mm; Diagonal: 148mm
<b>Weight</b>	Host: 1600 g (with battery).

### 15.2. Power supply

#### 15.2.1. External mains power supply

Range for use	Input AC100V-240V, 50Hz/60Hz, Output DC12V, Maximum output current 3A.
Maximum input power	36VA

#### 15.2.2. Battery supply

The device can be used without a connection to mains power. The battery also makes it possible to use the device during power outages.

<b>Battery</b>	Rechargeable lithium-ion battery pack 9.6V
<b>Capacity</b>	4500 mAh
<b>Life</b>	at least 500 charge-discharge cycles.
<b>Charging current</b>	approx. 0.6A
<b>Charging time</b>	approx. 8 hours
<b>Service T°</b>	[0 °C ; 50 °C].
<b>Charging T°</b>	[10 °C ; 35 °C].
<b>Storage T°</b>	Storage ≤30 days:[-20 °C ; 50 °C]
	storage for 30 to 90 days:[-20 °C ; 40 °C].
	storage for 90 days to 1 year: [-20 °C ; 30 °C].

#### 15.2.3. Consumption

At 10% luminosity	410 mA
At 50% luminosity	490 mA
At 100% luminosity	590 mA

### 15.3. Range for use

#### 15.3.1. Environmental conditions

##### 15.3.1.1. Climatic conditions

The following chart shows conditions relating to ambient temperature and humidity:

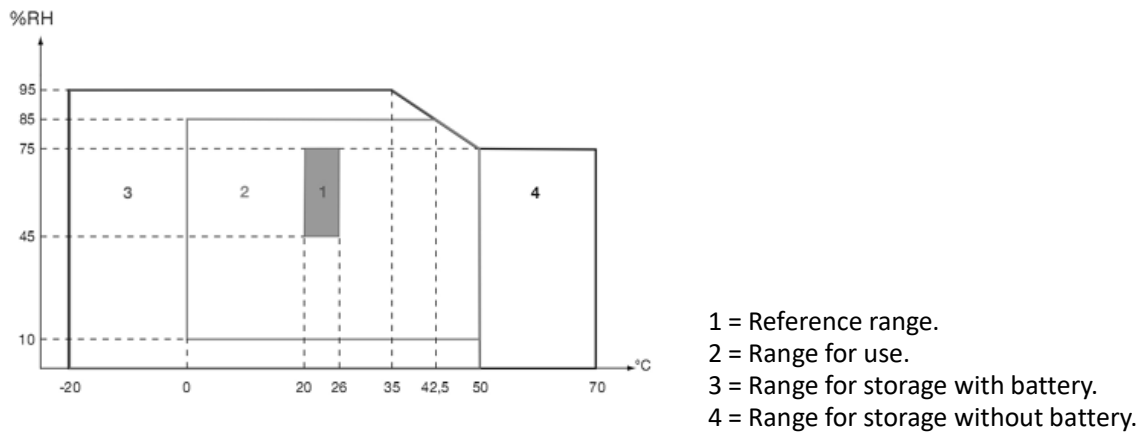

**Caution:** at temperatures above 40°C, the device must be powered by the battery alone OR by the mains power unit alone; use of the device with both the battery **AND** the mains power unit is **prohibited**.

##### 15.3.1.2. Altitude

Use: [0 m; 2 000 m]

Storage: [0 m; 10 000 m]

#### 15.3.2. Mechanical conditions

Under IEC 61010-1, the device is regarded as a **PORTABLE DEVICE (HAND-CARRIED)**.

- Operating position: any position.
- Reference position in operation: on a horizontal plane, resting on its stand or lying flat.
- Rigidity (IEC 61010-1): force of 30 N applied to any part of the housing, the device being supported (at 40°C).
- Fall (IEC 61010-1): 1 m in presumed worst-case position; the requirement is no permanent mechanical damage and no functional degradation.
- Tightness: IP 50 as per NF EN 60529 A1 (IP2X electrical protection for the terminals).

#### 15.3.3. EMC electromagnetic compatibility

##### 15.3.3.1. Immunity as per IEC 61326:1-2006

- Immunity to electrostatic discharges (as per IEC 61000-4-2)
  - 1<sup>st</sup> level: Severity: 4 kV in contact  
Requirements: CRITERION A
  - 2<sup>nd</sup> level: Severity: 8 kV in air  
Requirements: CRITERION A
- Immunity to radiated fields (as per IEC 61000-4-3 and IEC 61000-4-8)
  - Severity: 10V.m<sup>-1</sup>
  - Requirements: CRITERION B
- Immunity to rapid transients (IEC 61000-4-4)
  - Severity: 2 kV on voltage inputs and power supply  
1 kV on current input
  - Requirements: CRITERION A
- Immunity to electric shocks (as per IEC 61000-4-5)
  - Severity: 2 kV on voltage inputs in differential mode  
1 kV on voltage inputs in common mode

Requirements: CRITERION A

- Conducted RF interference (as per IEC 61000-4-6)  
Severity: 3 V on voltage inputs and power supply  
Requirements: CRITERION A
- Voltage interruption (as per IEC 61000-4-11)  
Severity: 100% loss over one period of the power supply  
Requirements: CRITERION A

#### 15.3.3.2. Emissions as per IEC 61326:1-2006

Class A equipment.

#### 15.4. User safety

- Application of safety rules as per IEC standard 61010-1 (protective impedances on voltage inputs).
- Pollution type 2.
- Double insulation on I/O with respect to earth (  symbol).
- Double insulation between the voltage inputs and power supply and the other I/O (  symbol).
- Indoor use.

## 16. Functional Characteristics

### 16.1. Reference conditions

This table indicates the reference conditions of the quantities to be used by default in the characteristics.

Ambient temperature	$(23\pm 2)^{\circ} C$
Humidity (relative humidity)	40%~ 60%
Atmospheric pressure	[860hPa~ 1060hPa]
Phase-to-neutral voltage	[(50±1%) Vrms; (500±1%) Vrms] without DC (< 0.5 %)
Frequency of electrical network	50Hz±0.1Hz, 60Hz±0.1Hz
Phase shift	0° (active power ), 90° (reactive power)
Harmonics	<0.1%
Voltage unbalance	<10%
Voltage ratio	1
Current ratio	1
Power supply	Battery only
Electric field	<1V/m
Magnetic field	<40A/m

### 16.2. Electrical characteristics

#### 16.2.1. Voltage input characteristics

0 Vrms to 1000 Vrms AC+DC phase-to-neutral and neutral-to-earth.

0 Vrms to 2000 Vrms AC+DC phase-to-phase. (on condition of compliance with 1000 Vrms with respect to earth in CAT III).

#### 16.2.2. Current input range

10A current clamp: 10mA~ 10A.

100A current clamp: 0.10A~ 100A.

1000A current clamp: 1.0A~ 1000A.

Optional current transformer: device input current 1mA~ 500mA.

#### 16.2.3. Characteristics of the device alone (excluding the current sensor)

Respectively introduce the following data (on the basis of base conditions and the ideal current sensors, perfectly linear, no phase shift).

Measurement	Range	Display resolution	The maximum error in the range of the reference
Frequency	40Hz~ 70Hz	0.01Hz	$\pm(0.03)\text{Hz}$
True RMS phase-to-neutral voltage	1.0V~ 1000V	Min resolution 0.1V	$\pm(0.5\%+5\text{dgt})$
True RMS phase-to phase voltage	1.0V~ 2000V	Min resolution 0.1V	$\pm(0.5\%+5\text{dgt})$
DC voltage	1.0V~ 1000V	Min resolution 0.1V	$\pm(1.0\%+5\text{dgt})$
True RMS current	10mA~ 1000A	Min resolution 1mA	$\pm(0.5\%+5\text{dgt})$
Peak of phase-to-neutral voltage	1.0V~ 1414V	Min resolution 0.1V	$\pm(1.0\%+5\text{dgt})$
Peak of phase-to-phase voltage	1.0V~ 2828V	Min resolution 0.1V	$\pm(1.0\%+5\text{dgt})$
Current peak	10mA~ 1414A	Min resolution 1mA	$\pm(1.0\%+5\text{dgt})$
Peak factor	1.00~ 3.99	0.01	$\pm(1\%+2\text{dgt})$
	4.00~ 9.99	0.01	$\pm(5\%+2\text{dgt})$
Active power	0.000W~ 9999.9kW	Min resolution 0.001W	$\pm(1\%+3\text{dgt})$ $\text{Cos}\phi\geq 0.8$
			$\pm(1.5\%+10\text{dgt})$ $0.2\leq\text{Cos}\phi<0.8$
Reactive power, inductive or capacitive	0.000VAR~ 9999.9kVAR	Min resolution 0.001VAR	$\pm(1\%+3\text{dgt})$ $\text{Sin}\phi\geq 0.5$
			$\pm(1.5\%+10\text{dgt})$ $0.2\leq\text{Sin}\phi<0.5$
Apparent power	0.000VA~ 9999.9kVA	Min resolution 0.001VA	$\pm(1\%+3\text{dgt})$
Power factor	-1.000~ 1.000	0.001	$\pm(1.5\%+3\text{dgt})$ $\text{Cos}\phi\geq 0.5$
			$\pm(1.5\%+10\text{dgt})$ $0.2\leq\text{Cos}\phi<0.5$
Active energy	0.000Wh~ 9999.9MWh	Min resolution 0.001Wh	$\pm(1\%+3\text{dgt})$ $\text{Cos}\phi\geq 0.8$
			$\pm(1.5\%+10\text{dgt})$ $0.2\leq\text{Cos}\phi<0.8$
Reactive energy, inductive or capacitive	0.000VARh~ 9999.9MVARh	Min resolution 0.001VARh	$\pm(1\%+3\text{dgt})$ $\text{Sin}\phi\geq 0.5$
			$\pm(1.5\%+10\text{dgt})$ $0.2\leq\text{Sin}\phi<0.5$
Papparent energy	0.000VAh~	Min resolution	$\pm(1\%+3\text{dgt})$

	9999.9MVAh	0.001VAh	
<b>Phase angle</b>	-179°~ 180°	1°	±(2°)
<b>Tanφ (VA≥50VA)</b>	-32.76~ 32.76	Min resolution 0.001	φ:±(1°)
<b>Phase shift of power factor (DPF)</b>	-1.000~ 1.000	0.001	φ:±(1°)
<b>Harmonic ratio (order 1 to 50) (Vrms&gt;50V)</b>	0.0%~ 99.9%	0.1%	±(1%+5dgt)
<b>Harmonic angle (Vrms&gt;50V)</b>	-179°~ 180°	1°	±(3°) harmonics of order 1 to 25
			±(10°) harmonics of order 26 to 50
<b>Total harmonic ratio (THD or THD-F)≤50</b>	0.0%~ 99.9%	0.1%	±(1%+5dgt)
<b>Distortion factor (DF or THD-R)≤50</b>	0.0%~ 99.9%	0.1%	±(1%+10dgt)
<b>Transformer K factor</b>	1.00~ 99.99	0.01	±(5%)
<b>3 phases unbalance</b>	0.0%~ 100%	0.1%	±(1%)

#### 16.2.4. Current sensor characteristics (after linearization)

Sensor errors are offset by a typical correction inside the device. This typical correction, applied to the phase and amplitude, depends on the type of sensor connected (detected automatically) and the gain in the current acquisition channel used.

<b>Type of current sensor</b>	<b>True RMS current</b>	<b>Max error of true RMS current</b>	<b>Max error of phase angleφ</b>
<b>10A current clamp</b>	10mA~ 99mA	±(1%+3dgt)	±(1.5°), Arms≥20mA
	100mA~ 10.0A	±(1%+3dgt)	±(1°)
<b>100A current clamp</b>	0.10A~ 0.99A	±(1%+3dgt)	±(1.5°)
	1.00A~ 100A	±(1%+3dgt)	±(1°)
<b>1000A current clamp</b>	1.0A~ 9.9A	±(2%+3dgt)	±(3°)
	10.0A~ 1000A	±(2%+3dgt)	±(2°)
<b>Optional transformer</b>	Instrument input current 1mA~ 500mA	The selected transformer error:±1%	The selected transformer error:±(1°)

# 17. Appendices

## 17.1. Mathematic formulae

### 17.1.1. Network frequency and sampling

Sampling is controlled by (locked to) the network frequency so as to deliver 256 samples per cycle from 40 Hz to 70 Hz. This locking is essential for the calculations of reactive power, unbalance, and harmonic ratio and angles.

The frequency is measured by analysing ten consecutive positive-going zero crossings in the first voltage channel (V1) or first current channel (I1) after digital low-pass filtering and digital suppression of the DC component.

The time of the zero crossing is determined precisely by linear interpolation between two samples to achieve resolution better than 0.002%.

The signals are acquired using a 16-bit converter and (for current acquisition) dynamic gain switches.

### 17.1.2. RMS values of half-cycle voltage and current (excluding neutral)

Half-cycle RMS phase-to-neutral voltage of phase (i+1)

$$V_{dem}[i] = \sqrt{\frac{1}{NechDemPer} \cdot \sum_{n=Zéro}^{(Zéro\ suivant)-1} V[i][n]^2}$$

Half-cycle RMS phase-to-phase voltage of phase (i+1)

$$U_{dem}[i] = \sqrt{\frac{1}{NechDemPer} \cdot \sum_{n=Zéro}^{(Zéro\ suivant)-1} U[i][n]^2}$$

Half-cycle RMS current of phase (i+1)

$$A_{dem}[i] = \sqrt{\frac{1}{NechDemPer} \cdot \sum_{n=Zéro}^{(Zéro\ suivant)-1} A[i][n]^2}$$



**Note:** these values are calculated for each half-cycle so as not to miss any fault.  
NechDemPer is the number of samples in the half cycle.

### 17.1.3. Minmum and maximum half-cycle RMS values (excluding neutral)

$$V_{max}[i] = \max(V_{dem}[i]), \quad V_{min}[i] = \min(V_{dem}[i])$$

$$U_{max}[i] = \max(U_{dem}[i]), \quad U_{min}[i] = \min(U_{dem}[i])$$

$$A_{max}[i] = \max(A_{dem}[i]), \quad A_{min}[i] = \min(A_{dem}[i])$$

**Note:** The duration of the evaluation is left to the user's discretion (reset by pressing the  or  key).

### 17.1.4. Short-term flicker (excluding neutral)

Method based on the IEC 61000-4-15 standard.

The input values are half-cycle phase-to-neutral voltages. The value is updated every 10 minutes.

### 17.1.5. Peak values (voltage and current)

$i = 3 \Leftrightarrow$  neutral(except Upp and Upm)

$$V_{pp}[i] = \max(V[i][n]), \quad V_{pm}[i] = \min(V[i][n]) \quad n \in [0 ; N]$$

$$U_{pp}[i] = \max(U[i][n]), \quad U_{pm}[i] = \min(U[i][n]) \quad n \in [0 ; N]$$

$$A_{pp}[i] = \max(A[i][n]), \quad A_{pm}[i] = \min(A[i][n]) \quad n \in [0 ; N]$$

### 17.1.6. Peak factors (excluding neutral)

Peak factor of phase-to-neutral voltage of phase (i+1)

$$V_{cf}[i] = \frac{\max(|V_{pp}[i]|, |V_{pm}[i]|)}{\sqrt{\frac{1}{NechPer} \cdot \sum_{n=0}^{NechPer-1} V[i][n]^2}}$$

Peak factor of phase-to-phase voltage of phase (i+1)

$$U_{cf}[i] = \frac{\max(|U_{pp}[i]|, |U_{pm}[i]|)}{\sqrt{\frac{1}{NechPer} \cdot \sum_{n=0}^{NechPer-1} U[i][n]^2}}$$

Peak factor of current of phase (i+1)

$$A_{cf}[i] = \frac{\max(|A_{pp}[i]|, |A_{pm}[i]|)}{\sqrt{\frac{1}{NechPer} \cdot \sum_{n=0}^{NechPer-1} A[i][n]^2}}$$

**Note:** NechPer is the number of samples in the half cycle.

### 17.1.7. RMS value (voltage and current)

$i = 3 \Leftrightarrow$  neutral(except Urms)

RMS phase-to-neutral voltage of phase (i+1)

$$V_{rms}[i] = \sqrt{\frac{1}{NechSec} \cdot \sum_{n=0}^{NechSec-1} V[i][n]^2}$$

RMS phase-to-phase voltage of phase (i+1)

$$U_{rms}[i] = \sqrt{\frac{1}{NechSec} \cdot \sum_{n=0}^{NechSec-1} U[i][n]^2}$$

RMS current of phase (i+1)

$$A_{rms}[i] = \sqrt{\frac{1}{NechSec} \cdot \sum_{n=0}^{NechSec-1} A[i][n]^2}$$

**Note:** NechSec is the number of samples in the second.

### 17.1.8. Unbalances (voltage and current)

These are calculated from the filtered RMS vector values (over one second) VFrms and AFrms (ideally the fundamental vectors of the signals).

**Note:** The formulas in complex notation with  $a = e^{j\frac{2\pi}{3}}$

$$V_{rms+} = \frac{1}{3} (VF_{rms}[0] + a \cdot VF_{rms}[1] + a^2 \cdot VF_{rms}[2])$$

$$V_{rms-} = \frac{1}{3} (VF_{rms}[0] + a^2 \cdot VF_{rms}[1] + a \cdot VF_{rms}[2])$$

$$V_{unb} = \frac{|V_{rms-}|}{|V_{rms+}|}$$

$$A_{rms+} = \frac{1}{3} (AF_{rms}[0] + a \cdot AF_{rms}[1] + a^2 \cdot AF_{rms}[2])$$

$$A_{rms-} = \frac{1}{3} (AF_{rms}[0] + a^2 \cdot AF_{rms}[1] + a \cdot AF_{rms}[2])$$

$$A_{unb} = \frac{|A_{rms-}|}{|A_{rms+}|}$$

### 17.1.9. Harmonic calculations (excluding neutral)

These calculations are carried out by FFT (16 bits), 1024 points over four cycles, with a rectangular window (see IEC 1000-4-7). From the real parts  $b_k$  and the imaginary parts  $a_k$ , the harmonic factor is calculated for each order and for each phase ( $V_{harm}[3][51]$ ,  $U_{harm}[3][51]$ , and  $A_{harm}[3][51]$ ) with respect to the fundamental and the angles  $V_{ph}[3][51]$ ,  $U_{ph}[3][51]$ , and  $A_{ph}[3][51]$  with respect to the fundamental.

This calculation is carried out according to the following principle:

The factor in percent [%]:  $\tau_k = \frac{c_k}{c_4} 100$

The angle in degrees [°]:  $\varphi_k = \arctan\left(\frac{a_k}{b_k}\right) - \varphi_4$

$$\begin{cases} c_k = |b_k + ja_k| = \sqrt{a_k^2 + b_k^2} \\ b_k = \frac{1}{512} \sum_{s=0}^{1024} F_s \cdot \sin\left(\frac{k\pi}{512} s + \varphi_k\right) \\ a_k = \frac{1}{512} \sum_{s=0}^{1024} F_s \cdot \cos\left(\frac{k\pi}{512} s + \varphi_k\right) \\ c_0 = \frac{1}{1024} \sum_{s=0}^{1024} F_s \end{cases}$$

$c_k$  : is the amplitude of the component of order  $j = \frac{k}{4}$  with a frequency  $f_k = \frac{k}{4} f_4$ .

$F_s$  : is the sampled signal at the fundamental frequency.

$C_o$  : Co: is the DC component.

K: is the number of the frequency spectrum (the order of the harmonic component is  $j = \frac{k}{4}$ )

### 17.1.10. Harmonic distortions (excluding neutral)

Two global values giving the relative quantity of harmonics are calculated: the THD as a proportion of the fundamental ("THD-F") and the DF as a proportion of the RMS value ("THD-R").

$$V_{thd}[i] = \frac{\sqrt{\sum_{n=2}^{50} V_{harm}[i][n]^2}}{V_{harm}[i][1]}, U_{thd}[i] = \frac{\sqrt{\sum_{n=2}^{50} U_{harm}[i][n]^2}}{U_{harm}[i][1]}, A_{thd}[i] = \frac{\sqrt{\sum_{n=2}^{50} A_{harm}[i][n]^2}}{A_{harm}[i][1]}$$

$$V_{df}[i] = \frac{\sqrt{\frac{\sum_{n=2}^{50} V_{harm}[i][n]^2}{\sum_{n=1}^{50} V_{harm}[i][n]^2}}}{\sqrt{\frac{\sum_{n=2}^{50} U_{harm}[i][n]^2}{\sum_{n=1}^{50} U_{harm}[i][n]^2}}}, U_{df}[i] = \frac{\sqrt{\frac{\sum_{n=2}^{50} U_{harm}[i][n]^2}{\sum_{n=1}^{50} U_{harm}[i][n]^2}}}{\sqrt{\frac{\sum_{n=2}^{50} A_{harm}[i][n]^2}{\sum_{n=1}^{50} A_{harm}[i][n]^2}}}, A_{df}[i] = \frac{\sqrt{\frac{\sum_{n=2}^{50} A_{harm}[i][n]^2}{\sum_{n=1}^{50} A_{harm}[i][n]^2}}}{\sqrt{\frac{\sum_{n=2}^{50} V_{harm}[i][n]^2}{\sum_{n=1}^{50} V_{harm}[i][n]^2}}}$$

Voltage harmonic distortion multiplied by current harmonic distortion equals apparent power harmonic ratio (VAharm[3][51]), voltage harmonic angle minus current harmonic angle equals power harmonic angle (VAph[3][51])

### 17.1.11. K factor

K factor for phase (i+1).

$$A_{kf}[i] = \frac{\sum_{n=1}^{n=50} n^2 \cdot A_{harm}[i][n]^2}{\sum_{n=1}^{n=50} A_{harm}[i][n]^2}$$

### 17.1.12. Sequence harmonics

Negative-sequence harmonics

$$V_{harm\_} = \frac{1}{3} \sum_{i=0}^2 \frac{\sum_{j=0}^7 V_{harm}[i][3j+2]}{V_{harm}[i][1]}, A_{harm\_} = \frac{1}{3} \sum_{i=0}^2 \frac{\sum_{j=0}^7 A_{harm}[i][3j+2]}{A_{harm}[i][1]}$$

Zero-sequence harmonics

$$V_{harm}_0 = \frac{1}{3} \sum_{i=0}^2 \frac{\sum_{j=0}^7 V_{harm}[i][3j+3]}{V_{harm}[i][1]}, A_{harm}_0 = \frac{1}{3} \sum_{i=0}^2 \frac{\sum_{j=0}^7 A_{harm}[i][3j+3]}{A_{harm}[i][1]}$$

Positive-sequence harmonics

$$V_{harm}_+ = \frac{1}{3} \sum_{i=0}^2 \frac{\sum_{j=0}^7 V_{harm}[i][3j+4]}{V_{harm}[i][1]}, A_{harm}_+ = \frac{1}{3} \sum_{i=0}^2 \frac{\sum_{j=0}^7 A_{harm}[i][3j+4]}{A_{harm}[i][1]}$$

### 17.1.13. LS powers (excluding neutral)

Active power of phase (i+1.)

$$W[i] = \frac{1}{N_{echSec}} \cdot \sum_{n=0}^{N_{echSec}-1} V[i][n] \cdot A[i][n]$$

Apparent power of phase (i+1).

$$VA[i] = V_{rms}[i] \cdot A_{rms}[i]$$

Reactive power (without harmonics) of phase (i+1).

$$VAR[i] = \frac{1}{NechSec} \cdot \sum_{n=0}^{NechSec-1} VF[i][n - \frac{NechPer}{4}] \cdot AF[i][n]$$

Reactive power (with harmonics) of phase (i+1).

$$VAR[i] = \sqrt{VA[i]^2 - W[i]^2}$$

Reactive powers are calculated using the filtered signals (without harmonics) in accordance with EDF (French national electricity company) rules or from the apparent and active powers (with harmonics). The choice of calculation is left up to the user.

Total active power.

$$W[3] = W[0] + W[1] + W[2]$$

Total apparent power.

$$VA[3] = VA[0] + VA[1] + VA[2]$$

Total reactive power.

$$VAR[3] = VAR[0] + VAR[1] + VAR[2]$$

#### 17.1.14. Power ratios

Power factor.

$$PF[i] = \frac{W[i]}{VA[i]}$$

Displacement power factor.

$$DPF[i] = \cos(\phi[i]) = \frac{\sum_{n=0}^{NechSec-1} VF[i][n] \cdot AF[i][n]}{\sqrt{\sum_{n=0}^{NechSec-1} VF[i][n]^2} \cdot \sqrt{\sum_{n=0}^{NechSec-1} AF[i][n]^2}}$$

Tangent.

$$\tan[i] = \tan(\phi[i]) = \frac{\sum_{n=0}^{NechSec-1} VF[i][n - \frac{NechPer}{4}] \cdot AF[i][n]}{\sum_{n=0}^{NechSec-1} VF[i][n] \cdot AF[i][n]}$$

Mean of 3 phase power factor.

$$PF[3] = \frac{|PF[0]| + |PF[1]| + |PF[2]|}{3}$$

Mean of 3 phase shift power factor.

$$DPF[3] = \frac{|DPF[0]| + |DPF[1]| + |DPF[2]|}{3}$$

Mean of tangent.

$$Tan[3] = \frac{|Tan[0]| + |Tan[1]| + |Tan[2]|}{3}$$

### 17.1.15. Energies (excluding neutral)

#### ◆ Consumed energies ( $w[i] \geq 0$ )

Consumed active energy of phase (i+1)

$$Wh[0][i] = \sum_{Tint} \frac{W[i]}{3600}$$

Consumed apparent energy of phase (i+1)

$$VAh[0][i] = \sum_{Tint} \frac{VA[i]}{3600}$$

Consumed inductive reactive energy of phase (i+1)(VAR[i]>=0)

$$VARhL[0][i] = \sum_{Tint} \frac{VAR[i]}{3600}$$

Consumed capacitive reactive energy of phase (i+1)(VAR[i]<=0)

$$VARhC[0][i] = \sum_{Tint} \frac{-VAR[i]}{3600}$$

Total consumed active energy

$$Wh[0][3] = Wh[0][0] + Wh[0][1] + Wh[0][2]$$

Total consumed apparent energy

$$VAh[0][3] = VAh[0][0] + VAh[0][1] + VAh[0][2]$$

Total consumed capacitive reactive energy

$$VARhL[0][3] = VARhL[0][0] + VARhL[0][1] + VARhL[0][2]$$

Total consumed inductive reactive energy

$$VARhC[0][3] = VARhC[0][0] + VARhC[0][1] + VARhC[0][2]$$

#### ◆ generated energies ( $w[i] < 0$ )

Generated active energy of phase( i + 1).

$$Wh[1][i] = \sum_{Tint} \frac{W[i]}{3600}$$

Generated apparent energy of phase (i+1)

$$VAh[1][i] = \sum_{T_{int}} \frac{VAR[i]}{3600}$$

Generated inductive reactive energy of phase (i+1) (VAR[i]>=0)

$$VARhL[1][i] = \sum_{T_{int}} \frac{-VAR[i]}{3600}$$

Generated capacitive reactive energy of phase (i+1) (VAR[i]<=0)

$$VARhC[1][i] = \sum_{T_{int}} \frac{VAR[i]}{3600}$$

Total generated active energy

$$Wh[1][3] = Wh[1][0] + Wh[1][1] + Wh[1][2]$$

Total generated apparent energy

$$VAh[1][3] = VAh[1][0] + VAh[1][1] + VAh[1][2]$$

Total generated inductive reactive energy

$$VARhL[1][3] = VARhL[1][0] + VARhL[1][1] + VARhL[1][2]$$

Total generated capacitive reactive energy

$$VARhC[1][3] = VARhC[1][0] + VARhC[1][1] + VARhC[1][2]$$

## 17.2. Hysteresis

Hysteresis is a screening principle that is often used after detection of a threshold stage in Alarm mode (See § 5.10) and in Inrush current mode (see § 6.3). A correct hysteresis setting avoids repeated changes of state when the measurement oscillates about the threshold.

### 17.2.1. Surge detection

With a hysteresis of 2%, for example, the return level for surge detection is equal to (100% - 2%) or 98% of the reference voltage threshold.

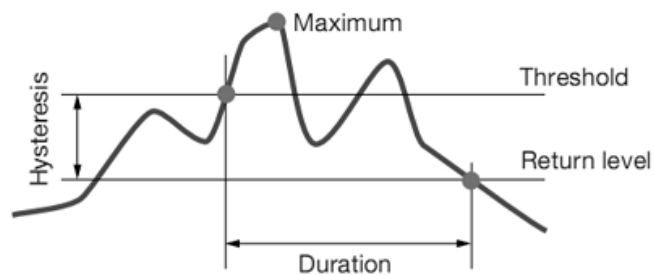

Figure 17-1: an example of return level for surge detection

### 17.2.2. Undervoltage or blackout detection

With a hysteresis of 2%, for example, the return level for undervoltage detection is equal to (100% + 2%) or 102% of the Uref voltage threshold.

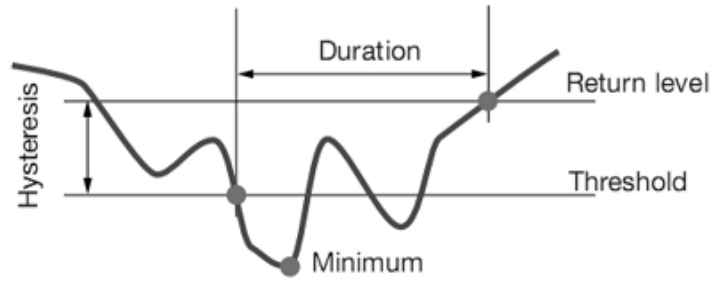

Figure 17-2: an example of return level for undervoltage detection

### 17.3. Four-quadrant diagram

This diagram is used for power and energy measurements **W** .

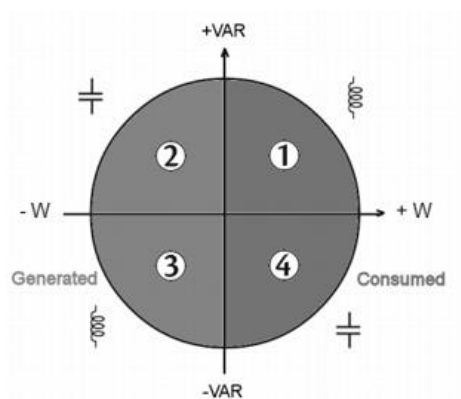

Figure 17-3: Four-quadrant diagram for power and energy

### 17.4. Mechanism for triggering transient captures

The sampling rate is a constant 256 samples per cycle. When a transient capture is started, each sample is compared to the sample from the preceding cycle. The preceding cycle defines the mid-point of the trigger envelope and is used as reference. As soon as a sample is outside the envelope, the triggering event occurs; the representation of the transient is then captured by the device. The cycle preceding the event and the three following cycles are saved to memory.

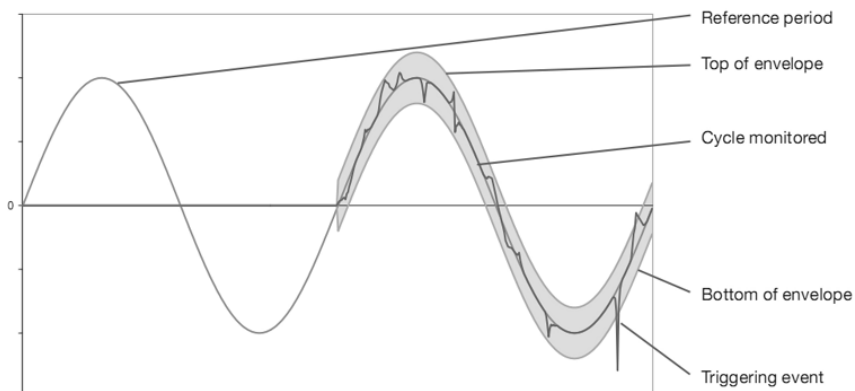

Figure 17-4: a graphic representation of the transient capture triggering mechanism

### 17.5. Capture conditions in inrush current current mode

**Reminder:** The capture depends on a triggering (start) event and a stop event. If a capture ends with a stop event or if the recording memory of the device is full, the capture stops automatically.

The capture stop threshold is calculated as follows:

$$[\text{Stop threshold [A]}] = [\text{Start threshold [A]}] \times (100 - [\text{stop hysteresis [\%]}]) \div 100$$

Here are the conditions for triggering and stopping captures:

Triggering channel	Triggering and stop conditions
A1	Triggering condition $\Leftrightarrow$ [A1 half-cycle RMS value] > [Triggering threshold] Stop condition $\Leftrightarrow$ [A1 half-cycle RMS value] < [Stop threshold]
A2	Triggering condition $\Leftrightarrow$ [A2 half-cycle RMS value] > [Triggering threshold] Stop condition $\Leftrightarrow$ [A2 half-cycle RMS value] < [Stop threshold]
A3	Triggering condition $\Leftrightarrow$ [A3 half-cycle RMS value] > [Triggering threshold] Stop condition $\Leftrightarrow$ [A3 half-cycle RMS value] < [Stop threshold]
3A	Triggering condition $\Leftrightarrow$ [[the half-cycle RMS value of one current channel] > [Triggering threshold]] Stop condition $\Leftrightarrow$ [the half-cycle RMS values of all current channels] < [Stop threshold]

## 18. Maintenance

### 18.1. Important recommendation

For maintenance, use only the spare parts specified. The manufacturer cannot be held liable for any accident that occurs following a repair not performed by its customer service department or by an approved repairer.

### 18.2. Recharging the battery

The battery charge is managed by the device when connected to the AC network via the mains power unit supplied.

- ★ For safety reasons and to ensure the correct operation of the charger, the storage battery must be replaced with the power off.
- ★ Do not throw the battery into a fire.
- ★ Do not expose the battery to a temperature in excess of 75°C.
- ★ Do not short-circuit the terminals of the battery.
- ★ When the battery fully recharged, please remove the power adapter (if do not use external power supply).

### 18.3. Replacing the battery

⚠ For safety reasons, advice that replace the battery only with the original model

To replace the battery, proceed as follows:

- ★ To eliminate all risk of electric shock, disconnect the power supply cord and connected devices.
- ★ Turn the device over.
- ★ Use a cross screwdriver to unscrew the two quarter-turn screws on the back of the housing. Then open the battery cover.
- ★ Gently remove the old battery, replace a new original battery (To avoid damage the battery connection, do not pull on the wires).
- ★ Put the battery compartment cover back in place and screw the 2 quarter-turn screws back in.
- ★ Reboot the device to confirm.

**Note:** If the battery is disconnected, it must then be fully recharged, even if it is not replaced, so that the device will know the battery charge condition (this information is lost when the battery is disconnected).

## 19. Packing List

No.	Item	Qty
1	Main engine	1
2	Power adapter	1
3	10A clamp meter	4
4	100A clamp meter OPTIONAL	4
5	1000A clamp meter OPTIONAL	4
6	6000A clamp meter OPTIONAL	4
7	Integrator	4
8	lithium battery	4
9	Test line (1 red 1green 1 yellow 1blue 1 black )	5
10	USB data cable	1
11	Test probe	5
12	Alligator clips	5
13	Software disc	1

## 20. Precautions

- ◆ Failure to comply with these precautions may result in an electric shock, explosion, or fire.
- ★ Under any circumstance, it shall pay special attention on safely in use of this device.
- ★ Pay attention to words and symbols stick on the panel and back of the device.
- ★ This measuring device is only to be used, disassembled, and repaired by qualified personnel with authorization.
- ★ When it may cause hazard by continuous use for the reason of the device itself, it shall immediately stop using it and deposit it at once, leaving it for disposal by authorized agency.
- ★ For risk of danger icon in manual, users must perform safely operations strictly in compliance with the manual content.
- ★ The user must strictly follow the instructions preceded by “danger symbol on the instrument and manual.
- ★ When removing and replacing the battery and/or the SD-Card, make sure that the device is disconnected and off.
- ★ Current clamp must be correspondingly connected with the device, if not the test error may increase.
- ★ The device must not be used if the “battery/SD Card” compartment cover is missing, damaged or incorrectly fitted.
- ★ The safety of any system incorporating this instrument is the responsibility of the system assembler.
- ★ For your safety, use only the compatible leads and accessories delivered with the instrument, which comply with IEC standard 61010-031 (2002). When sensors or accessories having a lower voltage rating and/or category are connected to the instrument, the lower voltage and/or category applies to the system so constituted.
- ★ Before each use, check that the leads, enclosures, and accessories are in perfect condition. Any lead, sensor or accessory of which the insulation is damaged (even partially) must be repaired or scrapped.
- ★ Comply with the environmental conditions(see 15.3.1)

- ★ We recommend using Personal Protection Equipment where required.
- ★ This device may be used on category IV installations for voltages that do not exceed 600 V (AC or DC) with respect to earth (as per IEC standard 61010-1), or on category III installations for voltages that do not exceed 1000 V. Never use it on networks of which the voltage or category exceeds those mentioned.
- ★ Use only the mains power adaptor and battery pack supplied by the manufacturer. They include specific safety features.
- ★ Do not reach past the physical guards on the accessories and sensors. Keep your hands away from unused terminals.
- ★ Some current sensors must not be placed on or removed from bare conductors at hazardous voltage.
- ◆ Connection procedure:
  - ★ Switch the instrument on.
  - ★ Configure the device for the measurement to be made and the type of network concerned.
  - ★ Connect the leads and current sensors to the unit.
  - ★ Connect the earth and/or neutral lead to the network earth and/or neutral and connect the corresponding current sensor.
  - ★ Connect the L1 phase lead to the network L1 phase and connect the corresponding current sensor.
  - ★ If applicable, repeat the procedure for phases L2, L3.

**Note:** complying with this procedure reduces connection errors to a minimum and avoids wasting time.

- ◆ Disconnection procedures:
  - ★ Proceed in the reverse of the order of connection, always finishing by disconnecting the neutral (when distributed).
  - ★ Disconnect the leads and switch the device off.
  - ★ Charging the battery and upload the test data when necessary.

USB is used as the data transmission, battery can be charged by the fringe special adapter.

#### ◆ Homonymous ends of the current clamp

- ★ The side of current clamp marks L1, L2, L3, N/D or has red dot is the current noninverting input, that is homonymous end.
- ★ The side of 10A current clamp has red dot is the current noninverting input, that is homonymous end.
- ★ The side of 100A, 1000A current clamp without screws is the current noninverting input, that is homonymous end.

Made in China

## FÖHR Group Electrical Measurement Equipment

MANUFACTURED BY H.E.M.B. CO.LTD

**CE/ISO/CNAS/IAF CERTIFIED**

[info@fohrgroup.com](mailto:info@fohrgroup.com)

[www.fohrgroup.com](http://www.fohrgroup.com)

### LEGAL DISCLAIMER AND LIMITATION OF LIABILITY

(Intellectual Property and Manufacturing Responsibility Statement) Effective Date: JANUARY 2025. This Legal Disclaimer and Limitation of Liability Statement ("Statement") is issued by FÖHR (the "Brand").

- Manufacturing Structure.** FÖHR is a commercial brand engaged in the marketing and distribution of electrical testing and industrial equipment. FÖHR does not design, engineer, develop, or manufacture the products directly. All products bearing the FÖHR brand name are manufactured, assembled, or produced by independent third-party original equipment manufacturers (OEMs) and contract manufacturers under private-label or contract manufacturing agreements. FÖHR operates solely as a brand owner and distributor.
- No Ownership of Underlying Technology.** FÖHR does not claim ownership of any underlying patents, utility models, industrial designs, trademarks, trade secrets, copyrights, proprietary software, firmware, embedded systems, or other intellectual property rights associated with the engineering or technological development of the products unless expressly stated in a separate written agreement. All intellectual property rights remain the sole responsibility of the respective manufacturers or lawful rights holders.
- Intellectual Property Compliance Responsibility.** Each independent manufacturer supplying products to FÖHR represents and warrants that: The products do not infringe any third-party patents, trademarks, copyrights, industrial designs, trade secrets, or other intellectual property rights. The products comply with applicable international intellectual property laws, including but not limited to: The TRIPS Agreement (WTO) The Paris Convention for the Protection of Industrial Property, The Berne Convention for the Protection of Literary and Artistic Works. Applicable national patent, trademark, and copyright laws in the jurisdictions where the products are manufactured or sold. FÖHR relies in good faith on such representations from its manufacturers.
- Disclaimer of Liability for Intellectual Property Claims.** To the fullest extent permitted by applicable law, FÖHR shall not be held liable for: Any alleged or actual patent infringement; Trademark violations; Copyright infringement; Misappropriation of trade secrets; Unauthorized use of proprietary technology; Design rights violations; Or any other intellectual property claim arising from the manufacture, design, engineering, or technological development of the products. Any claims relating to intellectual property infringement shall be directed exclusively to the original manufacturer responsible for the design and production of the goods.
- No Independent Technology Development.** FÖHR does not reverse engineer, modify core technologies, or alter proprietary engineering components supplied by its manufacturers. FÖHR does not independently develop internal circuitry, embedded firmware, measurement algorithms, or proprietary testing methodologies associated with the equipment.
- Indemnification by Manufacturers.** Manufacturers supplying products under the FÖHR brand are contractually required to indemnify, defend, and hold harmless FÖHR, its directors, officers, shareholders, affiliates, distributors, and agents from and against any claims, damages, liabilities, costs, or expenses arising from alleged intellectual property violations.
- Jurisdictional Limitation.** Nothing in this Statement shall exclude or limit liability where such exclusion is prohibited by mandatory law in any applicable jurisdiction. In jurisdictions where limitations of liability are restricted, FÖHR's liability shall be limited to the maximum extent permitted by law.
- No Admission of Liability.** This Statement does not constitute an admission of liability, infringement, wrongdoing, or legal responsibility of any kind.
- Governing Law.** This Statement shall be governed by and construed in accordance with the applicable commercial laws of the jurisdiction in which FÖHR is legally incorporated, without regard to conflict of law principles.