



# Variable Speed Drives Catalogue

Reliable made affordable





# About Himel

Himel is a multinational manufacturer and provider of electrical products successfully combining global expertise with local knowledge.

Founded by a Spanish entrepreneur in 1958, the company pioneered in exporting quality electrical enclosures, establishing Himel brand globally.

Today, our global footprint and technology enable us to provide the best combination of affordable and reliable offers for Low Voltage Power distribution, Industry Automation and Home Electric to our long-term customers and partners in over 50 countries where we are present.

**Himel. Reliable made affordable**



# Contents



## **Himel Variable Speed Drives** **04**

Himel Variable Speed Drives (VSD) Family	05
Your Benefits	06
Special Features and Benefits	07
Target Applications	09
Know Your Machine Better	11
Product Specification	13
Reference Selection	14
References & Mechanical Data	15
CAD Diagrams	17
Wiring Diagrams	18
Accessories	19
Accessory Selection	21

## **System Architecture** **23**

Options for System Integration	24
Circuit Breaker Selection	25
Contact Us	30



# Himel

## Variable Speed Drives (VSD)

Himel variable speed drives offer you a wide range of fully tested and ready-to-connect motor control possibilities. From simple pump and fan applications to complex, high-performance machines, we have a reliable affordable drive for you, no matter what you need.

High Performance

Improved Energy Savings

Multitude of Function

Easy to Use

Longer Lifetime





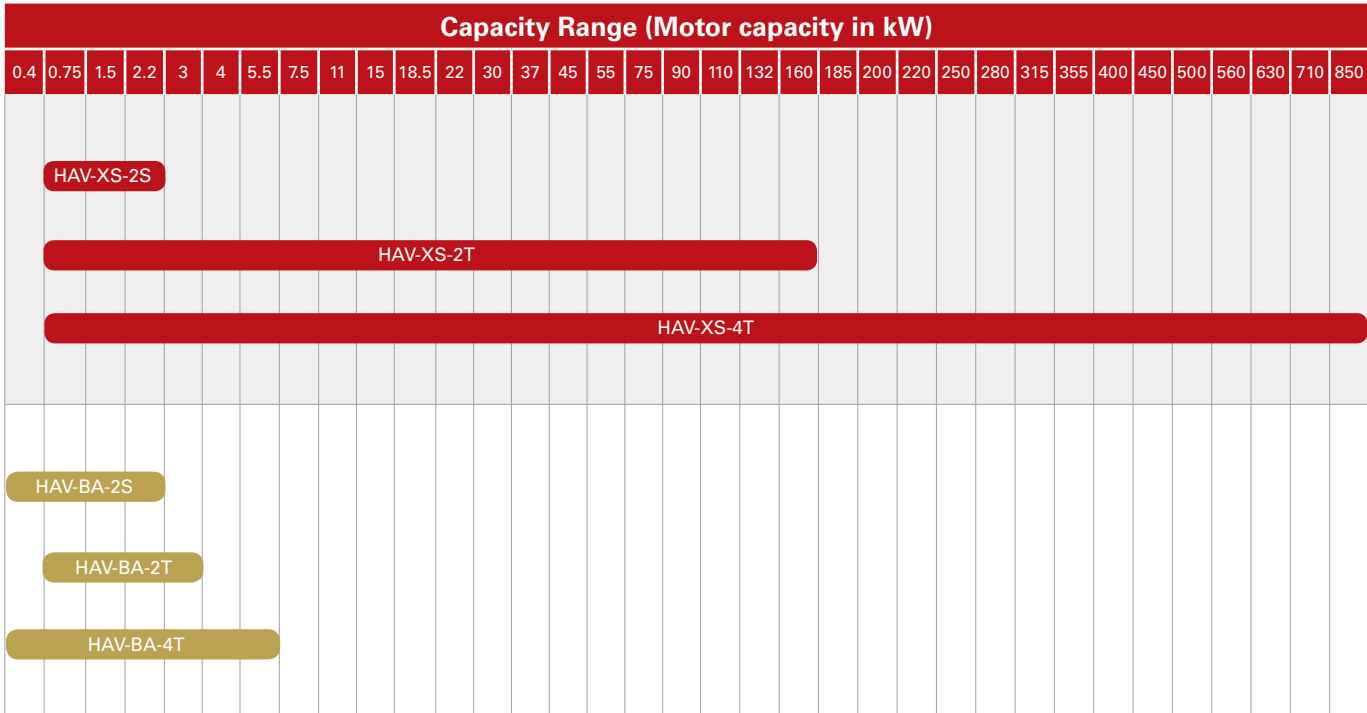

# Himel Variable Speed Drives (VSD) Family



\* 2S = 200-240V Single Phase, 2T = 200-240V Three Phase, 4T = 380-440V Three Phase



# Your Benefits

	Features	Your benefits
<b>High performance</b>		
	<ul style="list-style-type: none"> <li>◆ Excellent overload performance: 150% 60s, 180% 3s, 200% 1s (normal test environment)</li> <li>◆ High start torque performance: 0.5Hz, 150%</li> <li>◆ Excellent current control capability : The inverter provides sufficient stable output torque when the load is suddenly changed to avoid trip operation</li> </ul>	<ul style="list-style-type: none"> <li>◆ Improves productivity of machine</li> <li>◆ Less interruptions of the production line</li> </ul>
<b>Improved energy savings</b>		
	<ul style="list-style-type: none"> <li>◆ Integrated Eco-mode for V/f and V<sup>2</sup>/f automatically adapts the motor magnetic flux to save energy.</li> <li>◆ Improved special PID control with sleep mode helps to save more energy for pump application</li> </ul>	<ul style="list-style-type: none"> <li>◆ Energy savings during low dynamic load cycles such as pump and fan.</li> <li>◆ Increases the potential savings by up to 70%.</li> <li>◆ Greatly reduces the return time of investment.</li> </ul>
<b>Multitude of function</b>		
	<ul style="list-style-type: none"> <li>◆ With a new software platform, our VSDs offer more functions such as flexible V/F curve, 16 stage multi- speed control, command binding, industry specific functions, and many more.</li> <li>◆ Easy to communicate with upper controller via built-in RS485 Modbus protocol .</li> </ul>	<ul style="list-style-type: none"> <li>◆ No additional upper controller is needed for stand-alone machine, hence saving the system integration cost.</li> <li>◆ Easy to do the system integration for large production line and long distance communication</li> </ul>
<b>Easy to use</b>		
	<ul style="list-style-type: none"> <li>◆ Compact design and side-by-side mounting, din-rail installation.</li> <li>◆ High accuracy motor parameters self-tuning function</li> <li>◆ Supports pluggable keypad and extension keypad</li> <li>◆ Wall-through mounting</li> <li>◆ AVR (Automatic voltage regulation) technology</li> </ul>	<ul style="list-style-type: none"> <li>◆ Makes it possible to use in smaller cabinets</li> <li>◆ No need to set motor parameters anymore</li> <li>◆ Easy to operate and maintain</li> </ul>
<b>Longer lifetime</b>		
	<ul style="list-style-type: none"> <li>◆ Stable operation under main input voltage fluctuations. Reliable operation with net tensions between 380 V and 480 V (-15%/+10 %)</li> <li>◆ Fully coated PCB</li> <li>◆ Dust shield cover</li> <li>◆ Better cooling and removable fan design</li> </ul>	<ul style="list-style-type: none"> <li>◆ Wider voltage range, increases robustness of the drive in difficult environment</li> <li>◆ Automatic adaptation in case of unstable power supply</li> <li>◆ Longer life in high humid and high dust occasions</li> <li>◆ Easy to maintain</li> </ul>



# SPECIAL FEATURES & BENEFITS



## PID with sleep mode

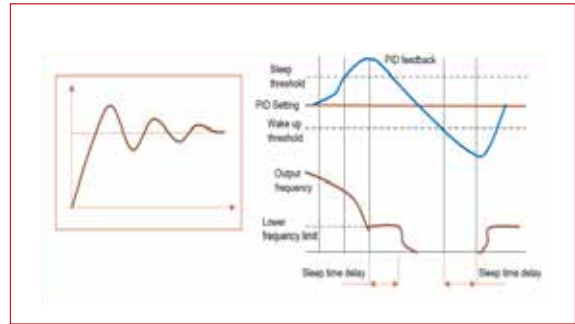

- ◆ Water supply PID adjustment: If the feedback pressure is higher than the set pressure, start the sleep detection to save more energy.
- ◆ After the sleep time delay, if the feedback pressure is still greater than the set pressure, the VSD enters into the sleep mode and slows down to the lower frequency
- ◆ When the feedback pressure reach to the wake up threshold and the wake up detection time passes, it will start automatically
- ◆ Target applications: Pump for HVAC, Water /Waste water

**E B**

## Simple PLC

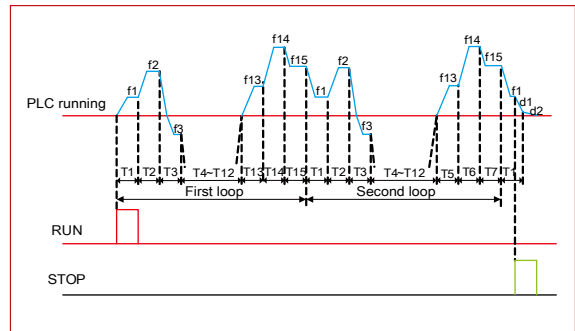

- ◆ Multistage speed control for up to 16 stages. Frequency, time, timer unit and direction for each stage can be set individually.
- ◆ PLC operation mode:
  - Single cycle (After a single cycle it keeps running at final value)
  - Continuous cycle
- ◆ No need for upper controller
- ◆ Target applications: Fan, ball mill, centrifuge

**E B**

## Fixed-length control

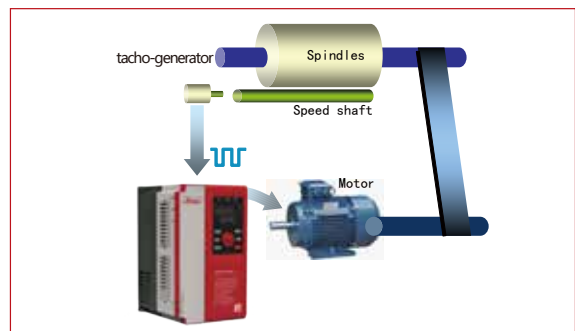

- ◆ Use DI4/DI5 (DI4/DI5 = 44 ) to input speed pulse for real-time length measurement. When the set length (set by FC.14) is reached, it triggers the length reached signal, and the fixed-length function is realized.
- ◆ Target applications: Textile machine, cable drawing machine

**E B**



## Non-stop function

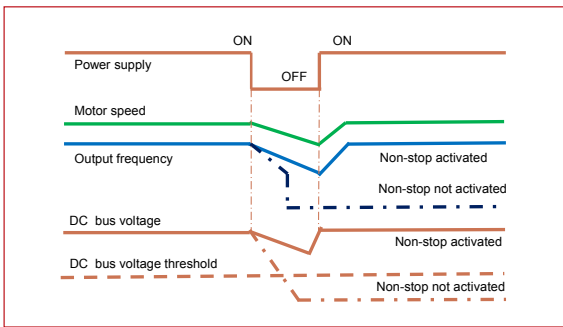

- ◆ When an instant power loss occurs, the VSD guarantees the continuous operation of the production line, which meets the continuous operation process requirement in conditions like lightning, large power grid impact and unstable power supply environments.
- ◆ Target applications: Chemical fiber, textile

**E B**

## Easy to add customized function like fixed point stop control

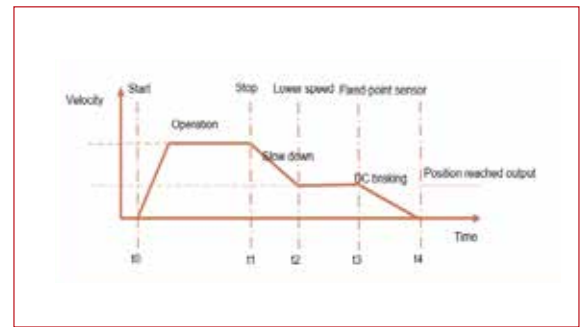

- ◆ Always stop at fixed point
- ◆ When there is a stop command, the motor slows down to the lower speed point, searches for a fixed stop point (usually connected to DI input by a sensor), stops at this point, and triggers an output position signal.
- ◆ Target applications: Needling machine, rotating table

**E**

## Main + auxiliary frequency set

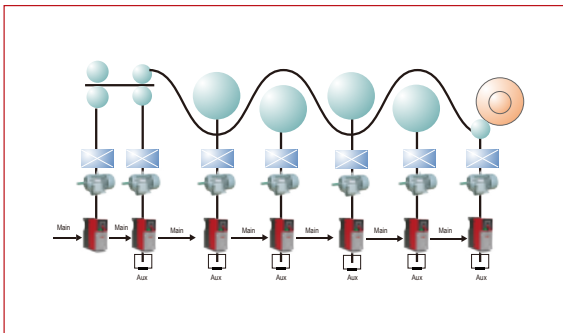

- ◆ Receives the frequency in any state, such as I/O, simple PLC, PI closed loop, multi-speed state. It uses auxiliary frequency for super precise speed.
- ◆ Target applications: Synchronization use case

**E B**

**E** Expert

**B** Basic

## Sagging function

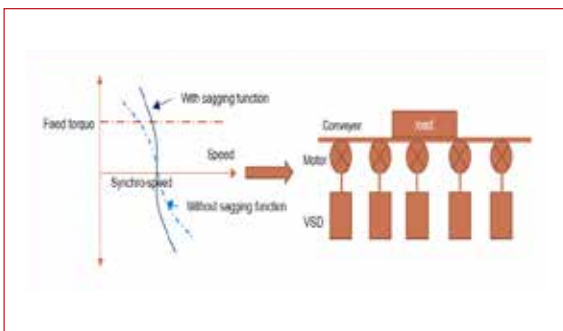

- ◆ When more than one motor drives the same load, this function can be used to adjust the speed of the motor for uniform distribution of load.
- ◆ Target applications: Tension control in chemical industry and roll control in glass and metallurgy industry

**E B**



# Wherever you need an efficient motor, a variable speed drive is a must...

**BASIC Series:** Small & Simple General Purpose Applications

**EXPERT Series:** Pumps, Fans & Advanced General Purpose Applications

0.4kW ~ 850kW  
220V | 380V-440V

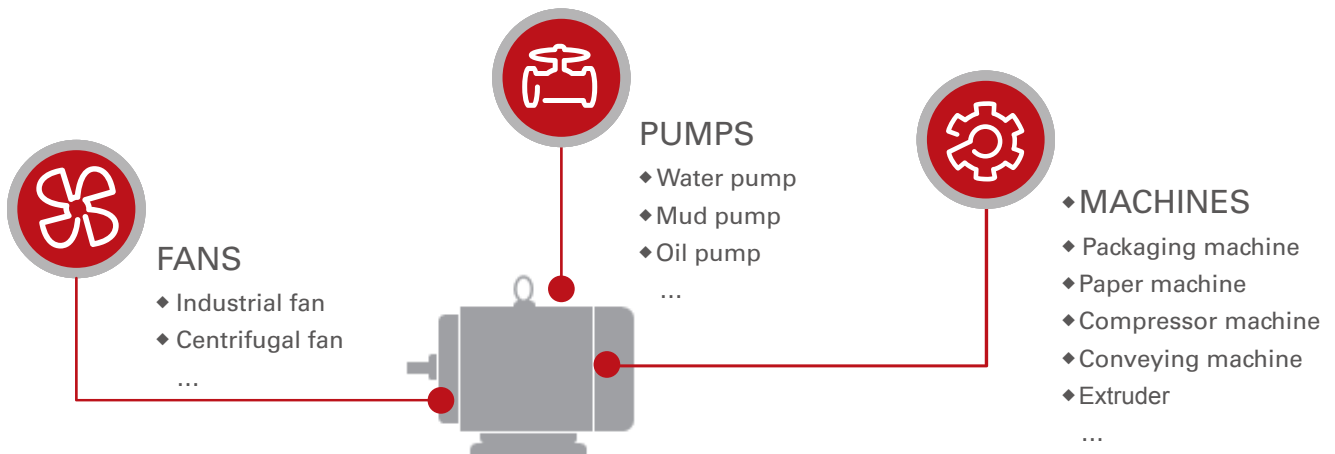

## Target Applications

### **BASIC Series**

#### Small machines:

- ◆ Bread machine
- ◆ Bag machine
- ◆ Carving machine

#### Simple applications:

- ◆ Small conveyor
- ◆ Small fan
- ...

### **EXPERT Series**

#### Pumps:

- ◆ Water pump
- ◆ Paper mill and pulp pump
- ◆ Sewage pump
- ◆ Fire patrol pump
- ◆ Rod pump

#### Fans:

- ◆ Industrial fan
- ◆ Air blower
- ◆ Ventilation

#### Heavy & complicated machines:

- ◆ Material handling machine
- ◆ Textile machine
- ◆ Material working machine
- ◆ Industrial washing machine
- ◆ Air compressor
- ◆ Construction elevator

#### Advanced applications:

- ◆ Metal & mining process
- ◆ Petrochemical

# Target Applications



■ Irrigation



■ Sewage



■ Fountain



■ Sand pump



■ Circulating pump



■ Photovoltaic pump



■ Rod pump

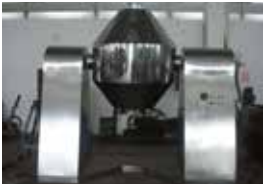

■ Drying



■ Ventilation



■ Dust removal



■ Air blowing



■ Hot surface treatment



■ Air supply fan for boiler



■ Industrial fan



■ Punching



■ Grinder



■ Textile

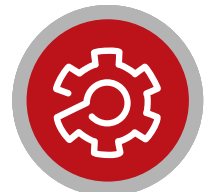

■ Carving



■ Sawing machine



■ Metal work



■ Plastic work



# KNOW YOUR MACHINE BETTER



## HVAC, Water and Waste Water



### Fans, Pumps, and Air Conditioning

- ◆ Integrated Eco-mode on V/f and V<sup>2</sup>/f control automatically adapts motor flux to save energy.
- ◆ Improved Special PID control with sleep mode for pump application can help to save more energy.
- ◆ Speed tracking: For smooth catching and restarting of a running fan.
- ◆ Dry pump protection, automatically detects a dry running pump to protect the equipment.

## Metal processing machinery



### Lathe, grinder, drill, planer, boring, cold forging, and engraving machine

- ◆ Compact design
- ◆ DIN rail mounting (up to 5.5 kW) and side by side mounting (up to 22 kW).
- ◆ High start torque, high frequency output (599Hz), and accurate speed control for highly dynamic applications to improve the productivity.
- ◆ Integrated brake chopper.
- ◆ Over excitation braking can help to reduce braking times by up to 50% without any external braking resistor.
- ◆ Sagging function
- ◆ Main + auxiliary frequency set

## Textile and Dyeing



E

Heat setting stenter, twister, air-flow spinning, spinning machine, thin-film machine, chemical fiber industry, and needling machine

- ◆ Separate cooling channel: Detachable cooling fan design makes it easy to clean cotton.
- ◆ Wall-through mounting option ( $\leq 185\text{kW}$ ), dust shield cover option ( $\leq 22\text{kW}$ ) and dust filter option
- ◆ Enhanced PCB coating
- ◆ Wide input voltage range, able to work for a long time under low voltage environments.
- ◆ Non-stop function to guarantee the continuous operation of production line.
- ◆ Fixed-length control and fixed-point stop control
- ◆ Main + auxiliary frequency set

## Woodworking machinery



E B

Wood and veneer cutting machines, planers, peeling machine, carving machines

- ◆ Integrated brake choppers: No need to purchase an external brake chopper.
- ◆ DIN rail mounting and quick I/O connection, quick and easy installation and maintenance.
- ◆ Multiple display options: Extendable LED/LCD display keypad. Integrated multi-stage speed control (16 steps) and simple PLC function without any additional PLC.
- ◆ High start torque, high frequency output (599Hz), accurate speed control for highly dynamic applications to improve the productivity .

## Food and packaging



E B

Conveyor, blow molding, blender, cutter, and labeling machines

- ◆ Compact design
- ◆ DIN rail mounting (up to 5.5 kW) and side by side mounting (up to 22 kW).
- ◆ Counter function using DI4/DI5
- ◆ Extendable LED/LCD display keypad support for convenient and safe monitoring and operation.
- ◆ Integrated multi-stage speed control (16 steps) and simple PLC function without any additional PLC.
- ◆ Fixed-length control for cutting process.
- ◆ Fixed-point stop control

## Rubber and plastic machinery





E B



Scroll extruder, pelletizer, and bagging machine

- ◆ Compact design
- ◆ DIN rail mounting (up to 5.5 kW) and side by side mounting (up to 22 kW), to save cabinet space.
- ◆ High start torque, high frequency output (599Hz), accurate speed control for highly dynamic applications to improve the productivity .
- ◆ Precise control to ensure the material thickness evenly, in order to save cost and ensure the quality of products.
- ◆ Torque limit and slip compensation, especially used for constant output torque. Minimize the torque fluctuations and improve the extrusion process quality.

# Product Specifications

Target Application		Small & Simple General Purpose Applications	P&F & Advanced General Purpose Applications
Range Name		BASIC	EXPERT XS
Design			
Capacity range	Single phase 200V Class	200V(-15%)-220V(+10%) 0.4~2.2kW	200V(-15%)-220V(+10%) 0.75~2.2kW
	Three phase 200V Class	—	200V(-15%)-240V(+10%) 0.75~160kW
	Three phase 400V Class	380V(-15%)-440V(+10%) 0.4~5.5kW	0.75~450kW [380V(-15%)~440V(+10%)] 500kW ~ 850kW (380V -15% +10%)
Frequency	Input frequency	50/60Hz	
	Output frequency	0-599Hz	0 - 550Hz
Overload capacity	Normal Duty	—	120% for 1min, 150% for 1s, 180% instant protection
	Heavy Duty	150% for 1min, 180% for 1s, 200% instant protection	150% for 1min, 180% for 3s, 200% instant protection
Control method	V/f	√	√
	Sensor less vector control		√
	Eco-mode control	√	√
Start torque		0.5Hz, 150%	
Inbuilt PID		√	√
Keypad		Fixed	Pluggable
Display		Single row LED	Double row LED
Multispeed control		Up to 16 stages in one cycle	
I/O	DI1-DI4	NPN/PNP, Input: 9-30VDC	
	DI5	NPN/PNP, Input: 15-30VDC, Pulse input: max. 50kHz	
	DO1	9-30VDC, max. 50mA	
	DO2	9-30VDC, max. 50mA Pulse output max. 50kHz	
	AI1	V: 0-10V I: 0-20mA Resolution: 1/1000	V: 0-10V I: 0-20mA Resolution: 1/1000
	AI2	V: 0-10V Resolution: 1/1000	
	AO1	V:0-10V	V:0-10V I: 0-20mA
	AO2	V:0-10V I: 0-20mA	
RO(Ta, Tb, Tc)	NO: 24VDC 3A / 250VAC 5A NC: 24VDC 3A / 250VAC 3A		
Inbuilt communication (Max. speed)		RS485, Modbus RTU (38.4kbps)	
Options	Extension I/O	—	DI/DO/AI/AO/RO/PT100/PT1000
	Extension keypad	Support, cable length:2m, 5m	
Installation Way		Wall mounted, cabinet, din-rail	Wall mounted, cabinet, flange installation
Dust Shields		—	Optional
EMC Filter	C3	—	External card available (≥ 30kW)
Braking unit		Built-in	Built-in (≤ 22W)
Environment	Operation temperature	-10-40 °C no capacity reduction, 40 °C -50°C capacity reduction	
	Humidity	≤90%RH	
	Altitude	≤1000m, no capacity reduction	
	IP level	IP20	
Standards		EN 61800-3: 2004 +A1: 2012 +A1: 2012, EN 55011: 2016+A1: 2017, EN 61000-6-2: 2005, EN 61000-3-2: 2014, EN 61000-3-3: 2013, EN 61000-4-2: 2009, EN 61000-4-3: 2006+A1: 2008+A2: 2010, EN 61000-4-4: 2012, EN 61000-4-5: 2014, EN 61000-4-6: 2014, EN 61000-4-8: 2010, EN 61000-4-11: 2004	
Certificates		CE	CE

# Product Specifications

Target Application		Small & Simple General Purpose Applications	P&F & Advanced General Purpose Applications
Range Name		BASIC	EXPERT XS
Design			
Features	Velocity ratio	1:100	
	Frequency precision	Digital setting: Max frequency X ±0.01% Analog setting: Max frequency X ±0.2%	
	Frequency resolution	Digital setting :Max frequency X ±0.01% Analog setting: Max frequency X ±0.1%	
	Torque rise	Integrated auto-torque rising function Manual- setting: 0.1%~30.0%	
	V/F control curve	Linear, Square, $V^{1.7}/F$ , $V^{1.2}/F$	
	Acceleration/Deceleration Time	4 types of ACC/DEC time selection; optional time unit selection (Min/s); setting range: 0~60hours;	
	DC braking	Start frequency: 0.00~60.00Hz; braking time: 0.0~30.0s; braking current: 0.0~100%	
	Automatic voltage regulation(AVR)	√	
	Auto current limitation	√	
	Auto PWM adjustment	√	
Protection	Prevent mis operation	—	√
	Protection function	Over-current, over-voltage, under-voltage, over-heat, over-load, short circuit.	
	Cooling	Air- cooling	
Warranty		24 months	

## Reference Selection

Range Name	Series Name	Input	Adaptation	AC Drive
<b>HAV</b>	<b>BA</b>	<b>4T</b>	<b>0015</b>	<b>G (- W)</b>
	↓	↓	↓	↓
	BA: BASIC XS: EXPERT Standard	2: 220V 4: 380V – 440V  S: Single-phase T: Three-phase	<b>Adaptation</b> 0015: 1.5kW 0075: 7.5kW 0110: 11kW 0185: 18.5kW 1100: 110kW .....	<b>AC Drive Type</b> G: Heavy Duty P: Normal Duty  W: Wall Mounted

# References & Mechanical Data

Range	Input Voltage	Commercial Reference	Heavy Duty G-type		Normal Duty P-Type		Dimensions(mm)			Mounting Dimensions (mm)					Mounting Hole Diameter (mm)	CAD Diagram
			Motor Power (kW)	Continuous Output Current (A)	Motor Power (kW)	Continuous Output Current (A)	W	H	D	W1	H1	D1	D2	D3		
BASIC	200-240V Single Phase	HAV-BA-2S0004G	0.4	2.4	-	-	80	150	136.5	68	138	133	-	-	5	(a)
		HAV-BA-2S0007G	0.75	4.5	-	-	80	150	136.5	68	138	133	-	-	5	
		HAV-BA-2S0015G	1.5	7.1	-	-	80	150	136.5	68	138	133	-	-	5	
		HAV-BA-2S0022G	2.2	9.8	-	-	106	200	148.5	94	188	144.6	-	-	6	(b)
	200-240V Three Phase	HAV-BA-2T-0007G	0.75	4.5	-	-	80	150	136.5	68	138	133	-	-	5	(a)
		HAV-BA-2T-0015G	1.5	7.1	-	-	80	150	136.5	68	138	133	-	-	5	
		HAV-BA-2T-0022G	2.2	9.8	-	-	106	200	148.5	94	188	144.6	-	-	5.5	(b)
	HAV-BA-2T-0030G	3	11.5	-	-	108	217	167	96	205	163	-	-	5.5		
	380-440V Three Phase	HAV-BA-4T0004G	0.4	1.5	-	-	80	150	136.5	68	138	133	-	-	5	(a)
		HAV-BA-4T0007G	0.75	2.3	-	-	80	150	136.5	68	138	133	-	-	5	
		HAV-BA-4T0015G	1.5	3.7	-	-	80	150	136.5	68	138	133	-	-	5	
		HAV-BA-4T0022G	2.2	5	-	-	80	150	136.5	68	138	133	-	-	5	
		HAV-BA-4T-0030G	3	6.7	-	-	106	200	148.5	94	188	144.6	-	-	5.5	(b)
		HAV-BA-4T0040G	4	8.8	-	-	106	200	148.5	94	188	144.6	-	-	6	
HAV-BA-4T0055G	5.5	13	-	-	106	200	148.5	94	188	144.6	-	-	6			
EXPERT XS	200-240V Single Phase	HAV-XS-2S0007G	0.75	5	-	-	120	215	158	109	204	133	85	-	5.5	(c)
		HAV-XS-2S0015G	1.5	7.8	-	-	120	215	158	109	204	133	85	-	5.5	
		HAV-XS-2S0022G	2.2	10.8	-	-	120	215	158	109	204	133	85	-	5.5	
	HAV-XS-2T0007G	0.75	5	-	-	120	215	158	109	204	133	85	-	5.5		
	HAV-XS-2T0015G	1.5	7.8	-	-	120	215	158	109	204	133	85	-	5.5		
	HAV-XS-2T0022G	2.2	10.8	-	-	120	215	158	109	204	133	85	-	5.5		
	HAV-XS-2T0030G	3	11.5	-	-	120	215	158	109	204	133	85	-	6.5		
	HAV-XS-2T0040G	4	16.2	-	-	150	259	183	138	248	176	150	105	5.5		
	HAV-XS-2T0055G	5.5	20.3	-	-	150	259	183	138	248	176	150	105	5.5		
	HAV-XS-2T0075G	7.5	26.7	-	-	205	322	219	188	305	210	168	143	6.5		
	200-240V Three Phase	HAV-XS-2T0110G	11	39	-	-	235	370	237	218	350	230	200	145	7	(d)
		HAV-XS-2T0150G	15	52.5	-	-	235	370	237	218	350	230	200	145	7	
		HAV-XS-2T0185G	18.5	62.4	-	-	305	490	270	200	470	235	207	-	10	
		HAV-XS-2T0220G	22	73.6	-	-	305	490	270	200	470	235	207	-	10	
		HAV-XS-2T0300G	30	98.7	-	-	320	560	302	197	543	275	237	-	10	
		HAV-XS-2T0370G	37	121	-	-	320	560	302	197	543	275	237	-	10	
		HAV-XS-2T0450G	45	147	-	-	320	560	302	197	543	275	237	-	10	
		HAV-XS-2T0550G	55	188	-	-	355	678	307	240	659	257	257	-	11	
		HAV-XS-2T0750G	75	256	-	-	355	678	307	240	659	257	257	-	11	
		HAV-XS-2T0900G	90	308	-	-	450	900	372	300	875	345	300	-	12	
200-240V Three Phase	HAV-XS-2T1100G	110	376	-	-	480	1070	412	-	-	400	313	-	-	(e)	
	HAV-XS-2T1320G	132	451	-	-	480	1070	412	-	-	400	313	-	-		
	HAV-XS-2T1600G	160	547	-	-	525	1300	438	-	-	425	335	-	-		



# References & Mechanical Data

Range	Input Voltage	Commercial Reference	Heavy Duty G-type		Normal Duty P-Type		Dimensions(mm)			Mounting Dimensions (mm)					Mounting Hole Diameter (mm)	CAD Diagram	
			Motor Power (kW)	Continuous Output Current (A)	Motor Power (kW)	Continuous Output Current (A)	W	H	D	W1	H1	D1	D2	D3			
EXPERT XS	380-440V Three Phase	HAV-XS-4T0007G	0.75	2.5	-	-	120	215	158	109	204	133	85	-	5.5	(c)	
		HAV-XS-4T0015G	1.5	4.1	-	-	120	215	158	109	204	133	85	-	5.5		
		HAV-XS-4T0022G	2.2	5.5	-	-	120	215	158	109	204	133	85	-	5.5		
		HAV-XS-4T-0030G	3	6.7	-	-	120	215	158	109	204	133	85	-	5.5		
		HAV-XS-4T0040G-0055P	4	9.6	5.5	13	120	215	158	109	204	133	85	-	5.5		
		HAV-XS-4T0055G-0075P	5.5	13	7.5	17	120	215	158	109	204	133	85	-	5.5		
		HAV-XS-4T0075G-0110P	7.5	17	11	25	150	259	183	138	248	176	150	105	5.5		
		HAV-XS-4T0110G-0150P	11	25	15	32	150	259	183	138	248	176	150	105	5.5		
		HAV-XS-4T0150G-0185P	15	32	18.5	37	205	322	219	188	305	210	168	143	6.5		
		HAV-XS-4T0185G-0220P	18.5	37	22	45	235	370	237	218	350	230	200	145	7		
		HAV-XS-4T0220G-0300P	22	45	30	60	235	370	237	218	350	230	200	145	7		
		HAV-XS-4T0300G-0370P	30	60	37	75	305	490	278	200	470	270	235	207	10	(d)	
		HAV-XS-4T0370G-0450P	37	75	45	90	305	490	278	200	470	270	235	207	10		
		HAV-XS-4T0450G-0550P	45	90	55	110	320	560	308	197	535	302	275	237	10		
		HAV-XS-4T0550G-0750P	55	110	75	157	320	560	308	197	535	302	275	237	10		
		HAV-XS-4T0750G-0900P	75	157	90	180	320	560	308	197	535	302	275	237	10		
		HAV-XS-4T0900G-1100P	90	180	110	214	355	678	320	240	659	307	257	257	11		
		HAV-XS-4T1100G-1320P	110	214	132	256	355	678	320	240	659	307	257	257	11		
		HAV-XS-4T1320G-1600P	132	256	160	307	355	678	320	240	659	307	257	257	11		
		HAV-XS-4T1600G-1850P	160	307	185	340	450	900	378	300	875	372	345	300	12		
		HAV-XS-4T1850G-2000P	185	340	200	385	450	900	378	300	875	372	345	300	12		
		HAV-XS-4T2000G-2200P	200	385	220	430	480	1070	412	-	-	400	313	-	-		(e)
		HAV-XS-4T2200G-2500P	220	430	250	465	480	1070	412	-	-	400	313	-	-		
		HAV-XS-4T2500G-2800P	250	465	280	525	525	1300	438	-	-	425	335	-	-		
		HAV-XS-4T2800G-3150P	280	525	315	590	525	1300	438	-	-	425	335	-	-		
		HAVXS-4T-3150G-3550P	315	600	355	645	525	1388	447	400	1357	447	440	350	-		
		HAVXS-4T-3550G-4000P	355	645	400	750	635	1577	482	450	1538	482	475	371	-		
		HAVXS-4T-4000G-4500P	400	750	450	850	635	1577	482	450	1538	482	475	371	-		
		HAVXS-4T-4500G-5000P	450	850	500	920	635	1577	482	450	1538	482	475	371	-		
		HAV-XS-4T2000G-2200P-W	200	385	220	430	480	1158	421	320	1127	414	329	-	12	(f)	
		HAV-XS-4T2200G-2500P-W	220	430	250	465	480	1158	421	320	1127	414	329	-	12		
		HAV-XS-4T2500G-2800P-W	250	465	280	525	525	1388	447	400	1357	440	350	-	12		
		HAV-XS-4T2800G-3150P-W	280	525	315	590	525	1388	447	400	1357	440	350	-	12		
		HAVXS-4T-3150G-3550P-W	315	600	355	645	525	1388	447	400	1357	440	350	-	12		
HAVXS-4T-3550G-4000P-W	355	645	400	750	635	1577	482	450	1538	475	371	-	16				
HAVXS-4T-4000G-4500P-W	400	750	450	850	635	1577	482	450	1538	475	371	-	16				
HAVXS-4T-4500G-5000P-W	450	850	500	920	635	1577	482	450	1538	475	371	-	16				
HAVXS-4T-5000G-5600P	500	920	560	1050	950	1812	490.5	900	1845	388.5	276	154	-	(g)			
HAVXS-4T-5600G-6300P	560	1050	630	1150	950	1812	490.5	900	1845	388.5	276	154	-				
HAVXS-4T-6300G-7100P	630	1150	710	1350	950	1812	490.5	900	1845	388.5	276	154	-	(h)			
HAVXS-4T-7100G-8500P	710	1350	850	1630	1200	1900	580.5	1150	1939	510	402.5	307	-				
HAVXS-4T-8500G	850	1630	-	-	1200	1900	580.5	1150	1939	510	402.5	307	-				

# CAD Diagrams

(a)

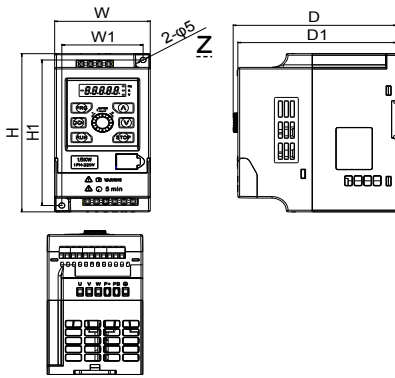

(b)

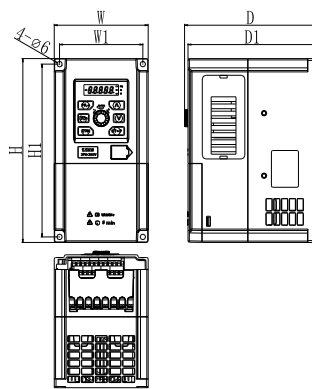

(c)

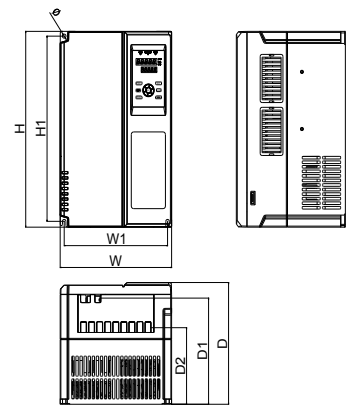

(d)

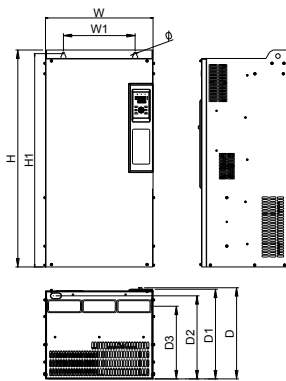

(e)

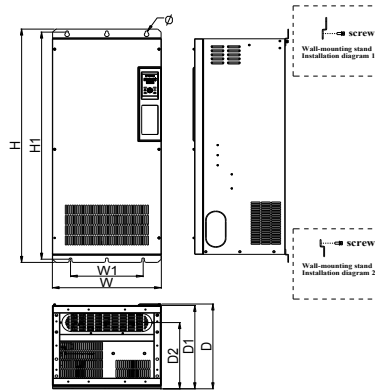

(f)

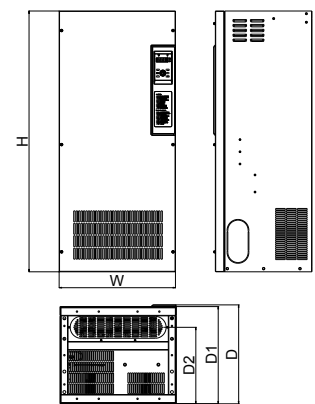

(g)

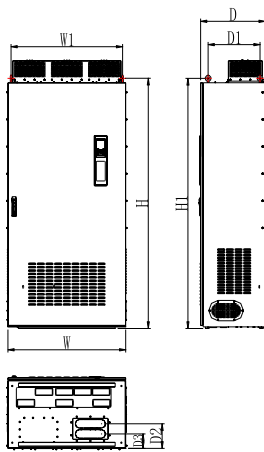

(h)

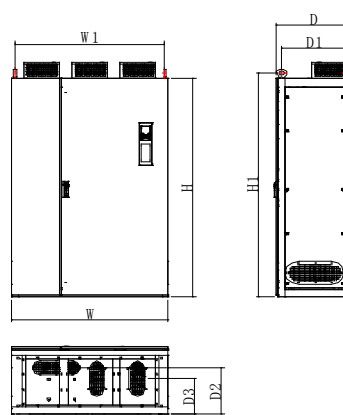

# Wiring Diagrams

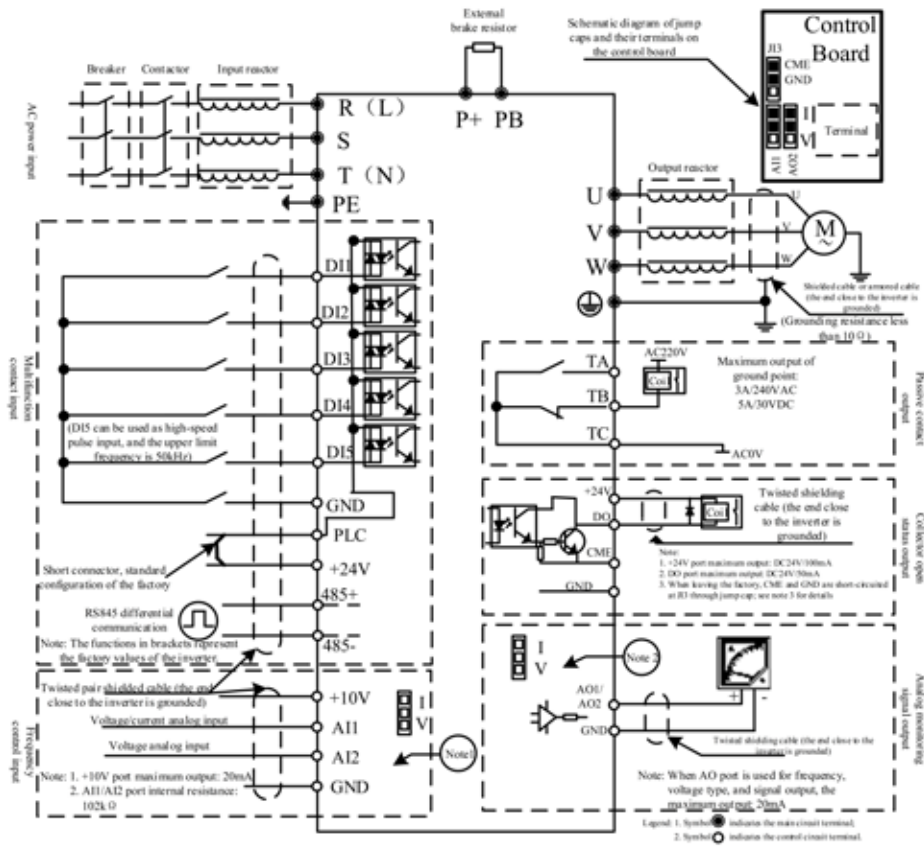

**BASIC Series**

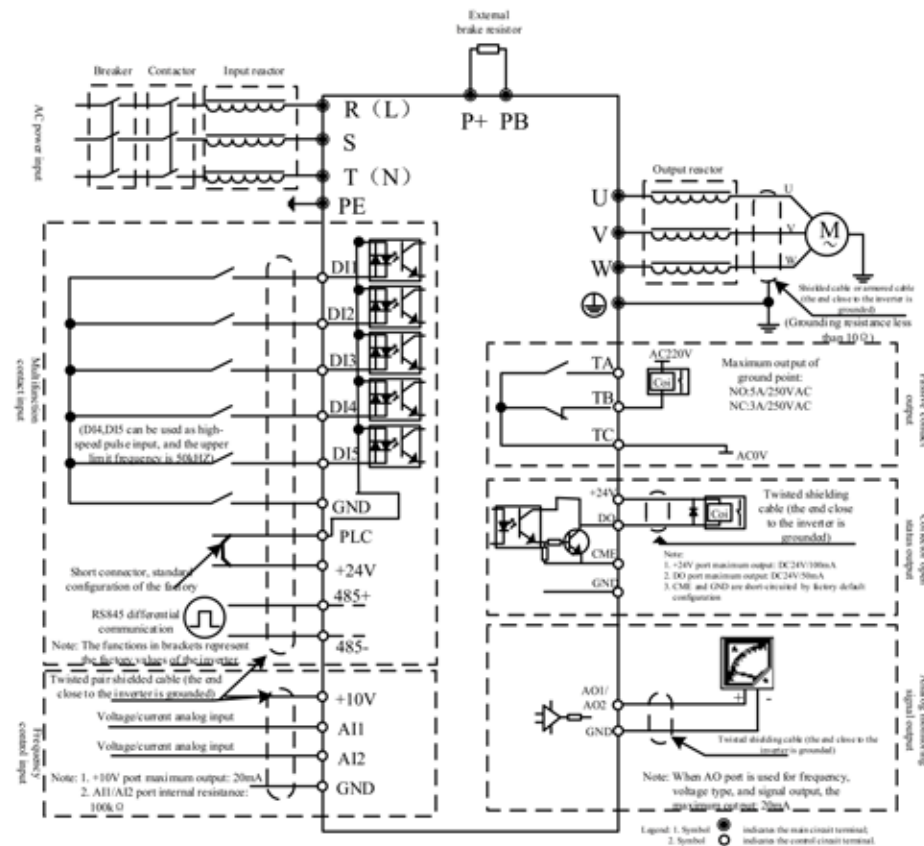

**EXPERT Series**

# Accessories

## Adapted for harsh environment

**Dust-proof design:** Comprehensive anti-corrosion coating and independent air duct design. Optional dust preventing accessories can also be installed to increase overall protection capabilities against high humid or excessively dusty environments.

**Target Applications:** Textile machines

### Dust Gauze



EXPERT Series

### Dust Shield



EXPERT Series  
XS

## Modular Design

**Easy fan replacement :** No need to disassemble the entire VSD for a quick fan replacement. This ease of fan change makes the VSD ideal for applications like wind machine that need regular cleaning of air ducts.

### Easy Maintenance



Modular plug-and-play fan design makes it easy to replace fan without dismantling the product.

### Modular Keypad Design



Operating keypad can be installed on the cabinet's door.

# Accessories

## Great adaptability to environment

**Power grid:** Suitable for neutral grounded power grids.

**EMC:** Enhanced electromagnetic interference immunity against disturbances like surge, electric noise, high frequency noise and static electricity etc.

### Power grid adaptability

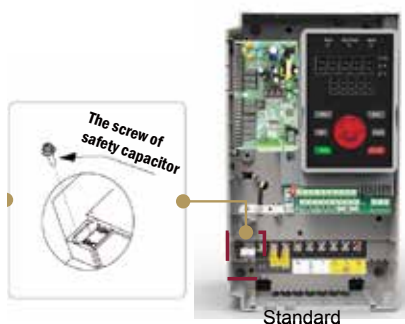

If installed in an IT system or an angular grounded TN system, remove the EMC screw to disconnect the safety capacitor in order to make it suitable for the grid system with neutral grounding.

### EMC



1. Special surge-proof design
2. The control board is completely isolated (COM-GND)
3. All inputs and outputs have optocoupler isolation.
4. Meets IEC61800-3 industrial standard

## Easy and comprehensive installation

**Comprehensive installation ways to fulfill all kinds of applications:**

- ◆ Cabinet
- ◆ Wall-mounting
- ◆ Din rail
- ◆ Flange mounting





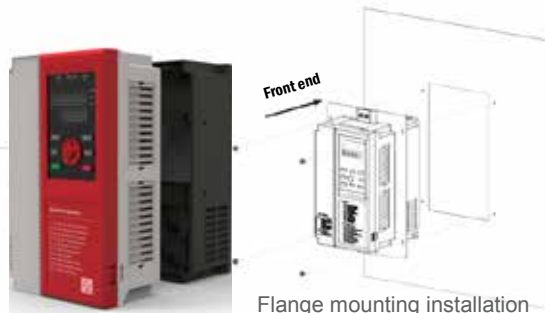
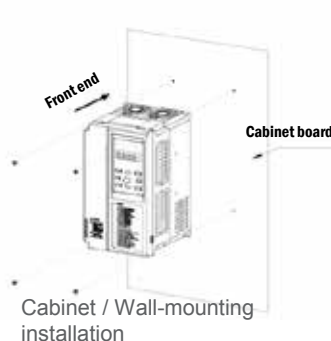



Wall-mounting / Din-rail installation



# Accessories Selection

Category	Type	Range	Commercial Reference	Short Description	Applicable Product		Pictures
					Applicable Commercial Reference	Specifications	
ADD-ON	EMC filter card	Expert XS	HAV-XS-4T0370G-FL	Simple EMC filter	HAV-XS-4T0300G-0370P ~ HAV-XS-4T0370G-0450P	4T*: 30 - 37kW	
			HAV-XS-4T0550G-FL		HAV-XS-4T0450G-0550P ~ HAV-XS-4T0550G-0750P	4T*: 45 - 55kW	
HAV-XS-4T1850G-FL			HAV-XS-4T0750G-0900P ~ HAV-XS-4T1850G-2000P		4T*: 75 - 185kW		
	IO extension card	Expert XS	HAV-XS-IO-3DI-R	IO extension card with 3 Di and 1 relay	HAV-XS-4T0007G ~ HAV-XS-4T2800G-3150P	4T*:0.4kW - 280kW	
Dust Preventive Accessories	Dust cover	EXPERT XS	HAV-XS-FCB	Dust prevention cover	HAV-XS-2S0007 ~ HAV-XS-2S0022G HAV-XS-2T0007G ~ HAV-XS-2T0220G-0300P HAV-XS-4T0007G ~ HAV-XS-4T0220G-0300P	2S*: 0.75 - 2.2kW 2T*: 0.75 - 22kW 4T*: 0.75 - 22kW	
		BASIC BA	HAV-BA-4T0040		HAV-BA-2S0022G HAV-BA-4T0040G HAV-BA-4T0055G	2S*: 2.2kW 4S*: 4kW, 5.5kW	
	Dust Guaze	Expert XS	HAV-XS-4T0075-FSB	Dust guaze for Expert Series	HAV-XS-4T0055G-0075P HAV-XS-4T0075G-0110P	4T*: 5.5kW , 7.5kW	
			HAV-XS-4T0150-FSB		HAV-XS-4T0110G-0150P HAV-XS-4T0150G-0180P	4T*: 11kW, 15kW	
			HAV-XS-4T0220-FSB		HAV-XS-4T0185G-0220P HAV-XS-4T0220G-0300P	4T*: 18.5kW, 22kW	
	Dust Sticker	BASIC BA	HAV-BA-4T0022	Dust sticker for BASIC Series	HAV-BA-2S0004G ~ HAV-BA-2S0022G HAV-BA-4T0004G ~ HAV-BA-4T0055G	2S*:0.4 - 2.2kW 4T*:0.4 - 5.5kW	

# Accessories Selection

Category	Type	Range	Commercial Reference	Short Description	Applicable Product		Pictures
					Applicable Commercial Reference	Specifications	
Installation Accessories	Flange-mounting	Expert XS	HAV-XS-4T0040-QRZJ	Embedded installation accessories	HAV-XS-4T0007G ~ HAV-XS-4T0040G-0055P HAV-XS-2T0007G ~ HAV-XS-2T1600G	4T*: 0.75 - 4kW 2S*: 0.75 - 2.2kW	
			HAV-XS-4T0075-QRZJ		HAV-XS-4T0055G-0075P ~ HAV-XS-4T0075G-0110P	4T*: 5.5 - 75kW	
			HAV-XS-4T0150-QRZJ		HAV-XS-4T0110G-0150P ~ HAV-XS-4T0150G-0185P	4T*: 11 - 15kW	
			HAV-XS-4T0220-QRZJ		HAV-XS-4T0185G-0220P ~ HAV-XS-4T0220G-0300P	4T*: 18.5 - 22kW	
			HAV-XS-4T0370-QRZJ		HAV-XS-4T0300G-0370P ~ HAV-XS-4T0370G-0450P	4T*: 30 - 37kW	
			HAV-XS-4T0750-QRZJ		HAV-XS-4T0450G-0550P ~ HAV-XS-4T0750G-0900P	4T*: 45 - 75kW	
			HAV-XS-4T1320-QRZJ		HAV-XS-4T0900G-1100P ~ HAV-XS-4T1320G-1600P	4T*: 90 - 132kW	
			HAV-XS-4T1600-QRZJ		HAV-XS-4T1600G-1850P ~ HAV-XS-4T8500G	4T*: 160 ~ 850kW	
	Wall-mounting	Expert XS	HAV-XS-4T2200-BGZJ	Accessory for wall mounting installation	HAV-XS-4T2000G-2200P ~ HAV-XS-4T2200G-2500P	4T*: 200 - 220kW	
			HAV-XS-4T2800-BGZJ		HAV-XS-4T2500G-2800P ~ HAV-XS-4T8500G	4T*: 250 ~ 850kW	
	Floor-standing	Expert XS	HAV-XS-4T0370-DZ	Accessory for floor-standing installation	HAV-XS-4T0300G-0370P ~ HAV-XS-4T0370G-0450P	4T*: 30 - 37kW	
			HAV-XS-4T0750-DZ		HAV-XS-4T0450G-0550P ~ HAV-XS-4T0750G-0900P	4T*: 45 - 75kW	
HAV-XS-4T1100-DZ			HAV-XS-4T0900G-1100P ~ HAV-XS-4T1320G-1600P		4T*: 90 - 132kW		
HAV-XS-4T1600-DZ			HAV-XS-4T1600G-1850P ~ HAV-XS-4T8500G		4T*: 160 ~ 850kW		
Keypad & Accessories	Keypad bracket	Expert XS	HAV-XS-JPT	Keypad holder for external keypad	HAV-XS-2S0007G ~ HAV-XS-2S0022G HAV-XS-2T0007G ~ HAV-XS-2T1600G HAV-XS-4T0007G ~ HAV-XS-4T8500G	2S*: 0.75 - 2.2kW 2T*: 4 - 7.5kW 4T*: 0.75kW - 850kW	
	External Keypad	BASIC BA	HAV-BA-LKD	External Keypad for BASIC	HAV-BA-2S0004G ~ HAV-BA-2S0022G HAV-BA-4T0004G ~ HAV-BA-4T0055G	2S*: 0.4 - 2.2kW 4T*: 0.4 - 5.5kW	
		EXPERT XS	HAV-XS-LKD	External Keypad for EXPERT XS	HAV-XS-2S0007G ~ HAV-XS-2S0022G HAV-XS-2T0007G ~ HAV-XS-2T1600G HAV-XS-4T0007G ~ HAV-XS-4T8500G	2S*: 0.75 - 22 kW 2T*: 4 - 7.5kW 4T*: 0.75 ~ 850kW	
	Keypad cable	BASIC Expert XS	HAV-XS-CAB2	Length 2m	Length 2m	HAV-BA-2S0004G ~ HAV-BA-2S0022G HAV-BA-4T0004G ~ HAV-BA-4T0055G	2S*: 0.4 - 2.2 kW 2T*: 0.75 - 160kW 4T*: 0.4 - 850kW
HAV-XS-CAB5			Length 5m	HAV-XS-2S0007G ~ HAV-XS-2S0022G HAV-XS-2T0007G ~ HAV-XS-2T1600G HAV-XS-4T0007G ~ HAV-XS-4T8500G			

\* 2S = 200-240V Single Phase, 2T = 200-240V Three Phase, 4T = 380-440V Three Phase

# System Architecture

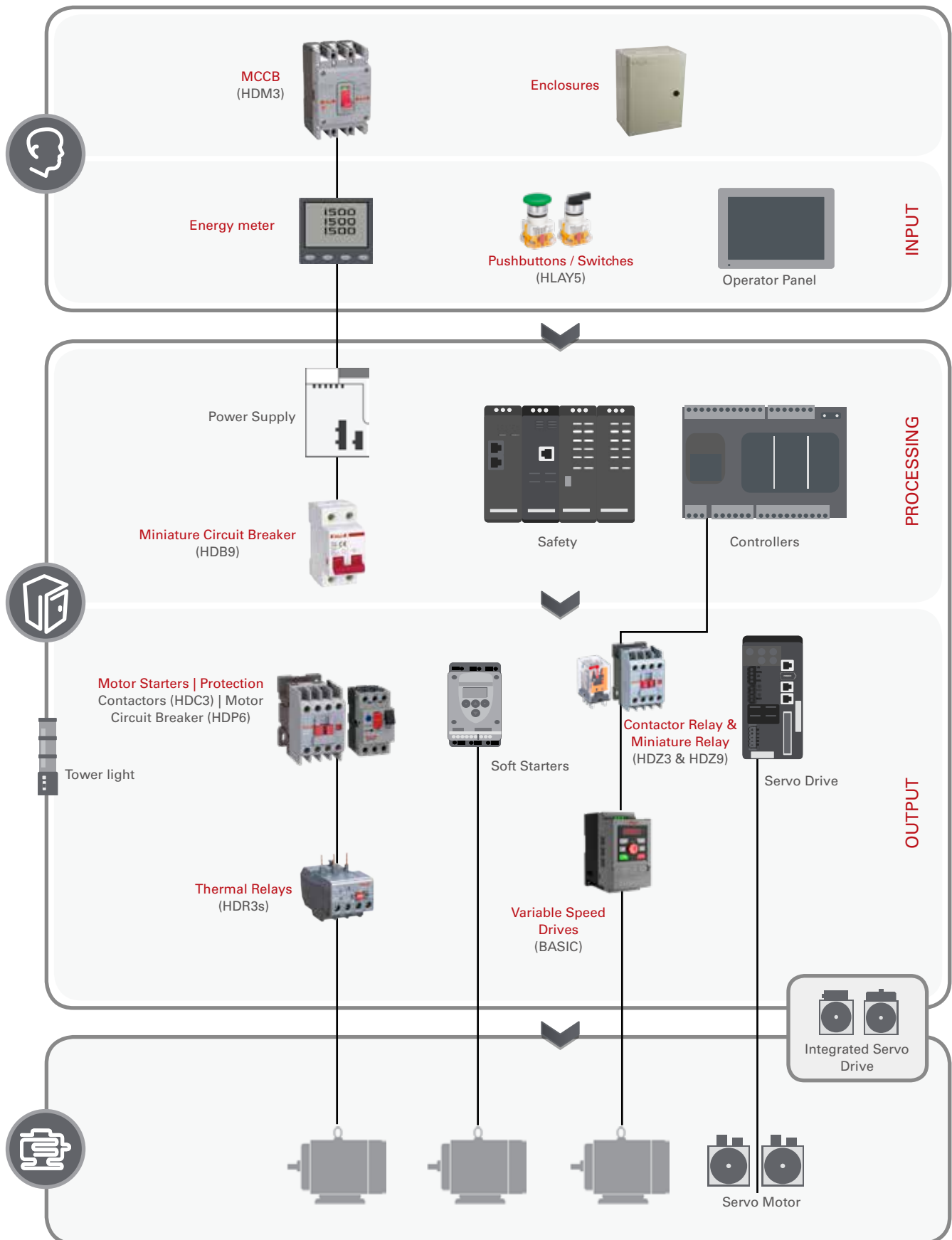



# Options for System Integration

## ■ Push Buttons (HLAY5)

- ◆ Degree of protection: IP44 (IP65 with protection cover)
- ◆ Type: Flush button / Mushroom / Selector switches / Key switches / Emergency stop / Illuminated / Double / Pilot light
- ◆ Drilling / Cut-out for mounting: Ø22mm
- ◆ Standard: IEC 60947-5-1



Push Button



Selector Switches



Push Button Switches



Indicator Light

## ■ Indication Light (HLD11)

- ◆ Degree of protection: IP65
- ◆ Type: Full cover head/ Half cover head/ Long terminal/ Short terminal
- ◆ Color: White/ Green/ Red/Yellow/ Blue
- ◆ Drilling or cut-out for mounting: Ø22mm
- ◆ Standard: IEC 60947-5-1

## ■ Relay (HDZ9)

Rated Current: 3A, 5A, 10A

- ◆ Poles: 2-pole, 3-pole, 4-pole
- ◆ Maximum Rated Operating Voltage: 690V
- ◆ Rated Operating Frequency: 50/60Hz
- ◆ Coil Specification: DC: 6V~220V; AC: 6V~380V
- ◆ Additional Feature: Rotary push button
- ◆ Certificate: CB, CE



## ■ Contactor Relay (HDZ3)

- ◆ Pole: 3-pole
- ◆ Coil Voltage: 24-440V
- ◆ Coil Frequency: 50Hz, 50/60Hz
- ◆ Certificate: CE



## ■ Miniature Circuit Breaker (HDB9)

- ◆ Elegant and clear indication window
- ◆ New clip design makes it easy to install
- ◆ Square terminal and connection holes makes it more secure to connect wiring
- ◆ Specifications
  - Rated Current: 1 – 63A
  - Breaking Capacity: 6kA, 10kA
  - Frame: 63A
  - Poles: 1P, 2P, 3P, 4P



## ■ Molded Case Circuit Breaker (HDM3)

- ◆ Easy Installation  
The double-deck cover design of the HDM3 series assures easy installation and removal of accessories.
- ◆ High Performance  
The patent design in HDM3 ensures quick extinguishing of arc.
- ◆ Secured Operation  
HDM3 is trustworthy and safe for use due to the double-deck cover design.
- ◆ Specifications
  - Frame: 63,100, 160, 250,400,630,800,1250A
  - Rated Voltage: 400/415V, 50/60 Hz
  - Breaking Capacity: 18kA - 85kA
  - Rated Current: 10A -1250A
  - Poles: 3P, 4P
  - Tripping type: Thermal Magnetic, Magnetic

Protection type: Power distribution, Motor protection  
 Connection: fixed-front connection, fixed-rear connection, plug-in connection, draw-out rear connection  
 Standard: IEC 60947-2  
 Certificates: CE, KEMA (TUV), CB  
 Operating Temp: 40°C & 50°C



# Circuit Breaker Selection

Range	Input Voltage	Commercial Reference	Motor Power(kW)	Circuit Breaker	Braking Unit		Braking Resistor		DC Choke
					Max. Braking Power	Max. DC Bus Voltage	Min. Resistance value to associate ( $\Omega$ )	Power (W)	
BASIC	200-240V Single Phase	HAV-BA-2S0004G	0.4	HDB3wN2C4	Built-in braking unit		200	75	-
		HAV-BA-2S0007G	0.75	HDB3wN2C6	Built-in braking unit		150	100	-
		HAV-BA-2S0015G	1.5	HDB3wN2C10	Built-in braking unit		100	200	-
		HAV-BA-2S0022G	2.2	HDB3wN2C10	Built-in braking unit		75	300	-
	200-240V Three Phase	HAV-BA-2T-0007G	0.75	HDB3wN3D5	Built-in braking unit		200	75	-
		HAV-BA-2T-0015G	1.5	HDB3wN3D8	Built-in braking unit		150	100	-
		HAV-BA-2T-0022G	2.2	HDB3wN3D10	Built-in braking unit		75	300	-
		HAV-BA-2T-0030G	3	HDB3wN3D13	Built-in braking unit		50	400	-
	380-440V Three Phase	HAV-BA-4T0004G	0.4	HDB3wN3D2	Built-in braking unit		750	75	-
		HAV-BA-4T0007G	0.75	HDB3wN3D3	Built-in braking unit		500	100	-
		HAV-BA-4T0015G	1.5	HDB3wN3D5	Built-in braking unit		300	200	-
		HAV-BA-4T0022G	2.2	HDB3wN3D6	Built-in braking unit		200	200	-
		HAV-BA-4T-0030G	3	HDB3wN3D8	Built-in braking unit		200	300	-
		HAV-BA-4T0040G	4	HDB3wN3D10	Built-in braking unit		200	300	-
		HAV-BA-4T0055G	5.5	HDB3wN3D13	Built-in braking unit		80	750	-
		EXPERT XS	200-240V Single Phase	HAV-XS-2S0007G	0.75	HDB3wN2C10	Built-in braking unit		150
HAV-XS-2S0015G	1.5			HDB3wN2C20	Built-in braking unit		100	200	-
HAV-XS-2S0022G	2.2			HDB3wN2C20	Built-in braking unit		75	300	-
200-240V Three Phase	HAV-XS-2T0007G		0.75	HDB3wN3D6	Built-in braking unit		150	100	-
	HAV-XS-2T0015G		1.5	HDB3wN3D10	Built-in braking unit		100	200	-
	HAV-XS-2T0022G		2.2	HDB3wN3D13	Built-in braking unit		75	300	-
	HAV-XS-2T0030G		3	HDB3wN3D20	Built-in braking unit		50	400	-
	HAV-XS-2T0040G		4	HDB3wN3D20	Built-in braking unit		50	400	-
	HAV-XS-2T0055G		5.5	HDB3wN3D32	Built-in braking unit		45	750	-
	HAV-XS-2T0075G		7.5	HDB3wN3D32	Built-in braking unit		30	1100	-
	HAV-XS-2T0110G		11	HDB3wN3D40	Built-in braking unit		30	1100	-
	HAV-XS-2T0150G		15	HDB3wN3D63	Built-in braking unit		18	1800	-
	HAV-XS-2T0185G		18.5	HDB3wN3D63	30kW*1	400V	5	1300	-
	HAV-XS-2T0220G		22	HDB3w125H3D80	30kW*2	400V	5	1300	-
	HAV-XS-2T0300G		30	HDB3w125H3D125	30kW*2	400V	4	1000	-
	HAV-XS-2T0370G		37	HDB3w125H3D125	30kW*2	400V	2.5	1000	-
	HAV-XS-2T0450G		45	HDM3160S16032XX2	30kW*3	400V	2.5	1000	-
	HAV-XS-2T0550G		55	HDM3250S20032XX2	30kW*4	400V	1.8	15300	-
	HAV-XS-2T0750G		75	HDM3400S31532XX2	30kW*4	400V	1.8	15300	-
	HAV-XS-2T0900G		90	HDM3400S31532XX2	30kW*6	400V	1.4	20900	-
HAV-XS-2T1100G	110	HDM3400S40032XX2	30kW*6	400V	10.8	8500*6	-		
HAV-XS-2T1320G	132	HDM3630S50032XX2	30kW*6	400V	10.8	8500*6	-		
HAV-XS-2T1600G	160	HDM3630S63032XX2	30kW*8	400V	10.8	8500*8	-		

# Circuit Breaker Selection

Range	Input Voltage	Commercial Reference	Motor Power (kW)	Circuit Breaker	Braking Unit		Braking Resistor		DC Choke
					Max. Braking Power	Max. DC Bus Voltage	Min. Resistance value to associate (Ω)	Power (W)	
EXPERT XS	380-440V Three Phase	HAV-XS-4T0007G	0.75	HDB3wN3D3	Built-in braking unit		500	100	-
		HAV-XS-4T0015G	1.5	HDB3wN3D5	Built-in braking unit		300	200	-
		HAV-XS-4T0022G	2.2	HDB3wN3D6	Built-in braking unit		200	200	-
		HAV-XS-4T-0030G	3	HDB3wN3D10	Built-in braking unit		200	300	-
		HAV-XS-4T0040G-0055P	4	HDB3wN3D10	Built-in braking unit		200	300	-
		HAV-XS-4T0055G-0075P	5.5	HDB3wN3D13	Built-in braking unit		80	750	-
		HAV-XS-4T0075G-0110P	7.5	HDB3wN3D20	Built-in braking unit		50	1100	-
		HAV-XS-4T0110G-0150P	11	HDB3wN3D25	Built-in braking unit		50	1500	-
		HAV-XS-4T0150G-0185P	15	HDB3wN3D32	Built-in braking unit		45	1800	-
		HAV-XS-4T0185G-0220P	18.5	HDB3wN3D40	Built-in braking unit		45	2200	-
		HAV-XS-4T0220G-0300P	22	HDB3wN3D50	Built-in braking unit		24	3000	HAV-DCL0300-G3
		HAV-XS-4T0300G-0370P	30	HDB3wN3D63	30kW*1	800V	26	3000	HAV-DCL0370-G3
		HAV-XS-4T0370G-0450P	37	HDB3w125H3D80	45kW*1	800V	16	4000	HAV-DCL0450-G3
		HAV-XS-4T0450G-0550P	45	HDB3w125H3D100	45kW*1	800V	15	4800	HAV-DCL0550-G3
		HAV-XS-4T0550G-0750P	55	HDB3w125H3D125	30kW*2	800V	13	6000	HAV-DCL0750-G3
		HAV-XS-4T0750G-0900P	75	HDM3160S16032XX2	45kW*2	800V	10.2	7200	HAV-DCL0900-G3
		HAV-XS-4T0900G-1100P	90	HDM3250S20032XX2	45kW*3	800V	7.5	9600	HAV-DCL1100-G3
		HAV-XS-4T1100G-1320P	110	HDM3250S25032XX2	220kW*1	800V	6.5	12000	HAV-DCL1320-G3
		HAV-XS-4T1320G-1600P	132	HDM3400S31532XX2	220kW*1	800V	6	12000	Built-in
		HAV-XS-4T1600G-1850P	160	HDM3400S31532XX2	220kW*1	800V	4	18000	Built-in
		HAV-XS-4T1850G-2000P	185	HDM3400S35032XX2	220kW*1	800V	4	18000	Built-in
		HAV-XS-4T2000G-2200P	200	HDM3400S40032XX2	220kW*1	800V	3.4	21000	Built-in
		HAV-XS-4T2200G-2500P	220	HDM3630S50032XX2	220kW*1	800V	3.4	21000	Built-in
		HAV-XS-4T2500G-2800P	250	HDM3630S50032XX2	420 kW	850 V	3.4	21000	Built-in
		HAV-XS-4T2800G-3150P	280	HDM3630S63032XX2	420 kW	850 V	3	24000	Built-in
		HAVXS-4T-3150G-3550P	315	HDM3630S63032XX2	420 kW	850 V	2	36000	Built-in
		HAVXS-4T-3550G-4000P	355	HDM3800M80032XX	750kW	850 V	2	36000	Built-in
		HAVXS-4T-4000G-4500P	400	HDM3800M80032XX	750kW	850 V	1.7	42000	Built-in
		HAVXS-4T-4500G-5000P	450	HDM31250N125032XX	750kW	850 V	0.7	112000	Built-in
		HAV-XS-4T2000G-2200P-W	200	HDM3400S40032XX2	220kW*1	800 V	2.1	44000	Built-in
		HAV-XS-4T2200G-2500P-W	220	HDM3630S50032XX2	220kW*1	800 V	2.1	44000	Built-in
		HAV-XS-4T2500G-2800P-W	250	HDM3630S50032XX2	420 kW	850 V	1.05	56000	Built-in
		HAV-XS-4T2800G-3150P-W	280	HDM3630S63032XX2	420 kW	850 V	1.05	75000	Built-in
		HAVXS-4T3150G-3550P-W	315	HDM3630S63032XX2	420 kW	850 V	1.05	75000	Built-in
HAVXS-4T3550G-4000P-W	355	HDM3800M80032XX	750kW	850 V	0.7	112000	Built-in		
HAVXS-4T4000G-4500P-W	400	HDM3800M80032XX	750kW	850 V	0.7	112000	Built-in		
HAVXS-4T4500G-5000P-W	450	HDM31250N125032XX	750kW	850 V	0.7	112000	Built-in		
HAVXS-4T-5000G-5600P	500	HDM31250N125032XX	750kW	850 V	0.7	112000	Built-in		
HAVXS-4T-5600G-6300P	560	HDM31250N125032XX	750kW	850 V	0.7	150000	Built-in		
HAVXS-4T-6300G-7100P	630	HDM31250N125032XX	750kW	850 V	0.7	150000	Built-in		
HAVXS-4T-7100G-8500P	710	-	1000kW	850 V	0.7	150000	Built-in		
HAVXS-4T-8500G	850	-	1000kW	850 V	0.7	150000	Built-in		





Notes

---

---

---

---

---

---

---

---

---

---

---

---

---

---

---

---

---

---

---

---

---

---

---

---

---

## Support and Consulting Services



## Training Services

## Spare Parts Services

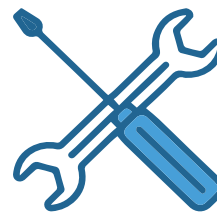
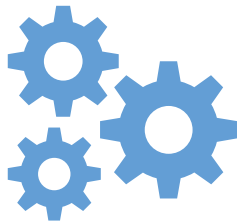

## Repair Services



## Contact Himel team

[support@himel.com](mailto:support@himel.com)



## Contact local distributor

Company name:

Contact:

Tel:

Email:

Address:

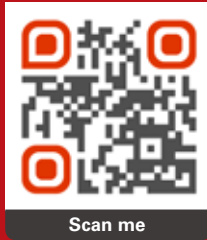

Himel  
[www.himel.com](http://www.himel.com)

May 2021



Copyright © 2021 Himel