

MINKO LIGHTING

LED PANEL LIGHT

LED

2025-2026
PRODUCT CATALOGUE

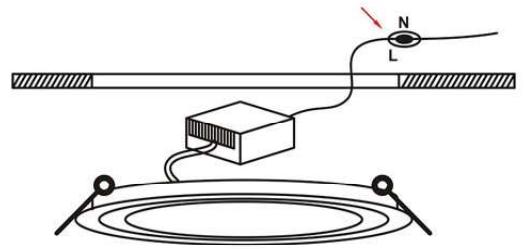
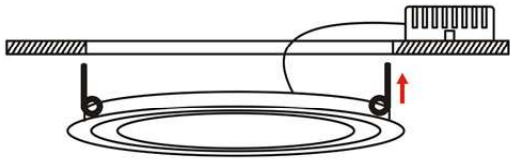
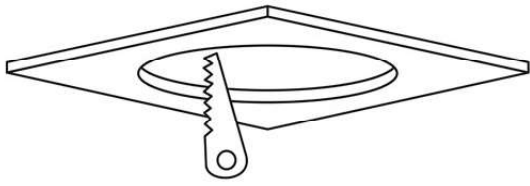

RECESSED LUMINAIRE

LED PANEL LIGHT SERIES

SURFACE MOUNTED LUMINAIRE

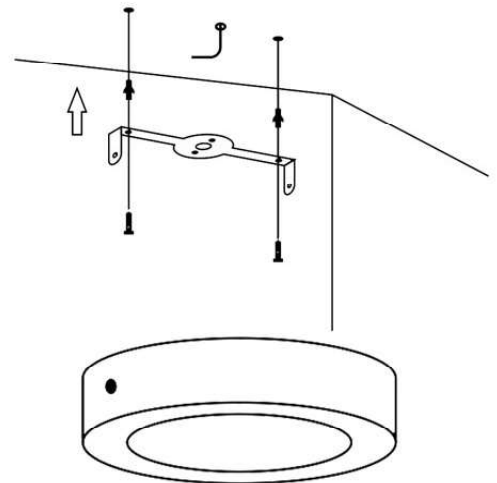
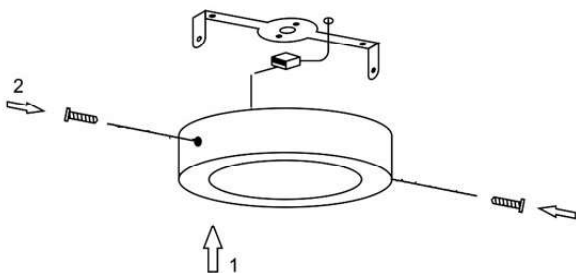
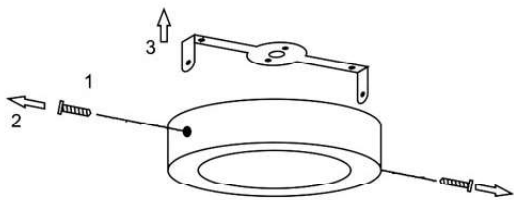

LED PANEL LIGHT

Recessed luminaire



PRI Voltage: 85-265V AC

Materials: Die-casting Aluminum

Framework Colour: White

LED SMD ✓

IP 20



ON/OFF

| | A(mm) | B(mm) | C(mm) | | | | |
|---------------|-------|-------|-------|-----|--------|--------|--------|
| MNK-PBR01-3W | 85 | 25 | 70 | 3W | 210lm | 20000H | ≥15000 |
| MNK-PBR03-6W | 120 | 25 | 105 | 6W | 450lm | 20000H | ≥15000 |
| MNK-PBR04-9W | 145 | 25 | 130 | 9W | 750lm | 20000H | ≥15000 |
| MNK-PBR05-12W | 170 | 25 | 155 | 12W | 960lm | 20000H | ≥15000 |
| MNK-PBR06-15W | 190 | 25 | 175 | 15W | 1350lm | 20000H | ≥15000 |
| MNK-PBR07-18W | 220 | 25 | 210 | 18W | 1620lm | 20000H | ≥15000 |
| MNK-PBR08-24W | 295 | 25 | 275 | 24W | 2160lm | 20000H | ≥15000 |

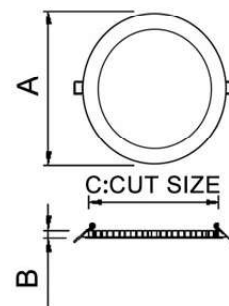

LED PANEL LIGHT

Recessed luminaire

PRI Voltage: 85-265V AC

Materials: Die-casting Aluminum

Framework Colour: White

LED SMD ✓

IP 20

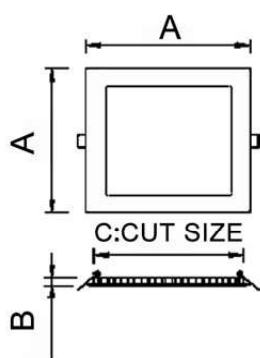

ON/OFF

| | A(mm) | B(mm) | C(mm) | | | | |
|---------------|-------|-------|-------|-----|--------|--------|--------|
| MNK-PBS01-3W | 85 | 25 | 70 | 3W | 210lm | 20000H | ≥15000 |
| MNK-PBS03-6W | 120 | 25 | 105 | 6W | 450lm | 20000H | ≥15000 |
| MNK-PBS04-9W | 145 | 25 | 130 | 9W | 750lm | 20000H | ≥15000 |
| MNK-PBS05-12W | 170 | 25 | 155 | 12W | 960lm | 20000H | ≥15000 |
| MNK-PBS06-15W | 190 | 25 | 175 | 15W | 1350lm | 20000H | ≥15000 |
| MNK-PBS07-18W | 225 | 25 | 210 | 18W | 1620lm | 20000H | ≥15000 |
| MNK-PBS08-24W | 300 | 25 | 280 | 24W | 2160lm | 20000H | ≥15000 |

LED PANEL LIGHT

Surface mounted luminaire

PRI Voltage: 175-265V AC

Materials: Die-casting Aluminum

Framework Colour: White

LED SMD ✓ **IP 20**

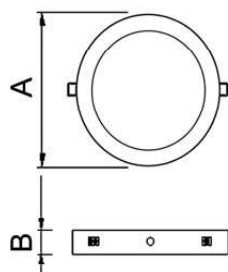

| | A(mm) | B(mm) | C(mm) | | | | ON/OFF |
|---------------|-------|-------|-------|-----|--------|--------|--------|
| MNK-SMR01-6W | 115 | 32 | - | 6W | 450lm | 20000H | ≥15000 |
| MNK-SMR02-12W | 170 | 32 | - | 12W | 1020lm | 20000H | ≥15000 |
| MNK-SMR03-18W | 225 | 32 | - | 18W | 1620lm | 20000H | ≥15000 |
| MNK-SMR04-24W | 295 | 32 | - | 24W | 2160lm | 20000H | ≥15000 |

LED PANEL LIGHT

Surface mounted luminaire

PRI Voltage: 175-265V AC

Materials: Die-casting Aluminum

Framework Colour: White

LED SMD ✓ **IP 20**



| | A(mm) | B(mm) | C(mm) | | | | ON/OFF |
|---------------|-------|-------|-------|-----|--------|--------|--------|
| MNK-SMS01-6W | 120 | 32 | - | 6W | 450lm | 20000H | ≥15000 |
| MNK-SMS02-12W | 175 | 32 | - | 12W | 1020lm | 20000H | ≥15000 |
| MNK-SMS03-18W | 228 | 32 | - | 18W | 1620lm | 20000H | ≥15000 |
| MNK-SMS04-24W | 300 | 32 | - | 24W | 2160lm | 20000H | ≥15000 |

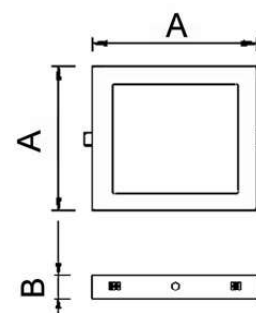

LED PANEL LIGHT Recessed luminaire



PRI Voltage: 175-265V AC

Materials: Aluminum

Framework Colour: White

LED SMD ✓ **IP 20**

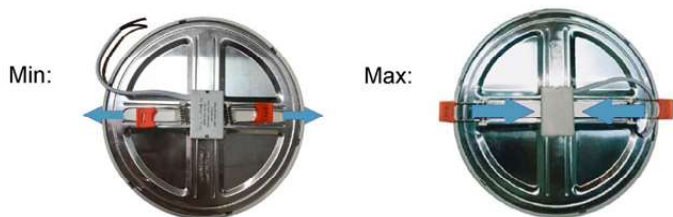

ADJUSTABLE CUTOUT



| | A(mm) | B(mm) | C(mm) | | | | ON/OFF |
|-------------|-------|-------|--------|-----|--------|--------|--------|
| MNK-2306-AY | 100 | 20 | 50~90 | 6W | 440lm | 20000H | ≥15000 |
| MNK-2308-AY | 118 | 20 | 50~100 | 8W | 680lm | 20000H | ≥15000 |
| MNK-2315-AY | 175 | 20 | 50~160 | 15W | 1450lm | 20000H | ≥15000 |
| MNK-2320-AY | 230 | 20 | 50~210 | 20W | 2000lm | 20000H | ≥15000 |

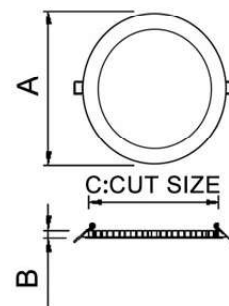

LED PANEL LIGHT Recessed luminaire

PRI Voltage: 175-265V AC

Materials: Aluminum

Framework Colour: White

LED SMD ✓ **IP 20**

ADJUSTABLE CUTOUT

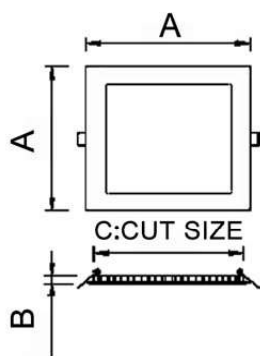
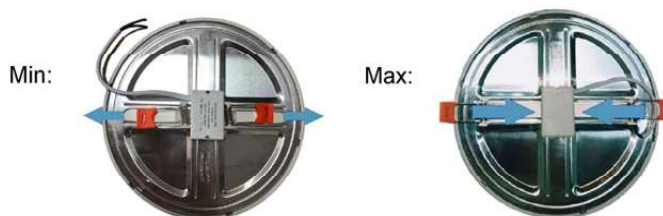

| | A(mm) | B(mm) | C(mm) | | | | ON/OFF |
|-------------|-------|-------|--------|-----|--------|--------|--------|
| MNK-2306-AF | 100 | 20 | 50~90 | 6W | 440lm | 20000H | ≥15000 |
| MNK-2308-AF | 118 | 20 | 50~100 | 8W | 640lm | 20000H | ≥15000 |
| MNK-2315-AF | 175 | 20 | 50~160 | 15W | 1450lm | 20000H | ≥15000 |
| MNK-2320-AF | 230 | 20 | 50~210 | 20W | 2000lm | 20000H | ≥15000 |

LED PANEL LIGHT

Recessed luminaire

PRI Voltage: 175-265V AC

Materials: Die-casting Aluminum

Framework Colour: White

LED SMD ✓

IP 20



GLASS RING

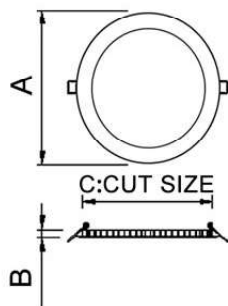

| | A(mm) | B(mm) | C(mm) | | | | | |
|-----------|-------|-------|-------|-----|--------|--------|--------|--|
| MNK-DFR01 | 100 | 35 | 75 | 6W | 480lm | 20000H | ≥15000 | |
| MNK-DFR01 | 110 | 35 | 75 | 6W | 480lm | 20000H | ≥15000 | |
| MNK-DFR02 | 120 | 35 | 95 | 9W | 720lm | 20000H | ≥15000 | |
| MNK-DFR03 | 160 | 35 | 125 | 12W | 960lm | 20000H | ≥15000 | |
| MNK-DFR04 | 200 | 35 | 165 | 18W | 1620lm | 20000H | ≥15000 | |
| MNK-DFR05 | 240 | 42 | 205 | 24W | 2240lm | 20000H | ≥15000 | |



LED PANEL LIGHT

Recessed luminaire

PRI Voltage: 175-265V AC

Materials: Die-casting Aluminum

Framework Colour: White

LED SMD ✓

IP 20

GLASS RING

| | A(mm) | B(mm) | C(mm) | | | | | |
|-----------|-------|-------|-------|-----|--------|--------|--------|--|
| MNK-DFS01 | 100 | 35 | 75 | 6W | 480lm | 20000H | ≥15000 | |
| MNK-DFS02 | 120 | 35 | 95 | 9W | 720lm | 20000H | >15000 | |
| MNK-DFS03 | 160 | 35 | 125 | 12W | 960lm | 20000H | ≥15000 | |
| MNK-DFS04 | 200 | 35 | 165 | 18W | 1620lm | 20000H | ≥15000 | |
| MNK-DFS05 | 240 | 42 | 205 | 24W | 2240lm | 20000H | ≥15000 | |

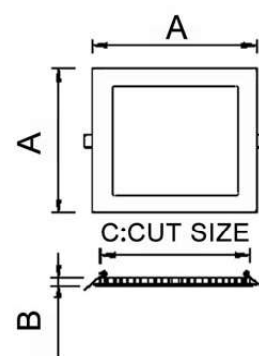

LED PANEL LIGHT

Recessed luminaire

DUAL COLOR



COLOR RING SECTION



different ring color: red/green/blue/pink/yellow

PRI Voltage: 175-265V AC

Materials: Die-casting Aluminum

Framework Colour: White

LED SMD ✓

IP 20

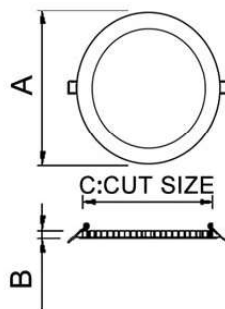

MNK-PL20151103R

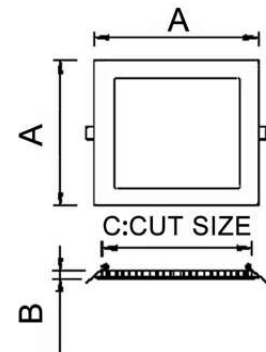

MNK-PL20151103S



| | A(mm) | B(mm) | C(mm) | | | | |
|-----------------|-------|-------|-------|-------|--------|--------|--------|
| MNK-PL20151103R | 105 | 30 | 75 | 3+3W | 360lm | 20000H | ≥15000 |
| MNK-PL20151103R | 145 | 30 | 110 | 6+3W | 680lm | 20000H | ≥15000 |
| MNK-PL20151103R | 190 | 30 | 160 | 12+4W | 1360lm | 20000H | ≥15000 |
| MNK-PL20151103R | 240 | 30 | 210 | 18+6W | 2160lm | 20000H | ≥15000 |
| MNK-PL20151103S | 105 | 30 | 75 | 3+3W | 390lm | 20000H | ≥15000 |
| MNK-PL20151103S | 145 | 30 | 110 | 6+3W | 720lm | 20000H | ≥15000 |
| MNK-PL20151103S | 190 | 30 | 160 | 12+4W | 1440lm | 20000H | ≥15000 |
| MNK-PL20151103S | 240 | 30 | 210 | 18+6W | 2280lm | 20000H | ≥15000 |

LED PANEL LIGHT

Surface mounted luminaire

PRI Voltage: 175-265V AC

Materials: Die-casting Aluminum

Framework Colour: White

LED SMD ✓ **IP 20**

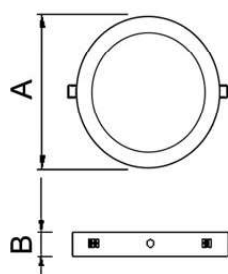

| | A(mm) | B(mm) | C(mm) | | | | | ON/OFF |
|-----------------|-------|-------|-------|-------|--------|--------|--------|--------|
| MNK-PL20151104R | 105 | 30 | - | 3+3W | 360lm | 20000H | ≥15000 | |
| MNK-PL20151104R | 145 | 30 | - | 6+3W | 680lm | 20000H | ≥15000 | |
| MNK-PL20151104R | 190 | 30 | - | 12+4W | 1360lm | 20000H | ≥15000 | |
| MNK-PL20151104R | 240 | 30 | - | 18+6W | 2160lm | 20000H | ≥15000 | |

LED PANEL LIGHT

Surface mounted luminaire

PRI Voltage: 175-265V AC

Materials: Die-casting Aluminum

Framework Colour: White

LED SMD ✓ **IP 20**



| | A(mm) | B(mm) | C(mm) | | | | | ON/OFF |
|-----------------|-------|-------|-------|-------|--------|--------|--------|--------|
| MNK-PL20151104S | 105 | 30 | - | 3+3W | 360lm | 20000H | ≥15000 | |
| MNK-PL20151104S | 145 | 30 | - | 6+3W | 680lm | 20000H | ≥15000 | |
| MNK-PL20151104S | 190 | 30 | - | 12+4W | 1440lm | 20000H | ≥15000 | |
| MNK-PL20151104S | 240 | 30 | - | 18+6W | 2160lm | 20000H | ≥15000 | |

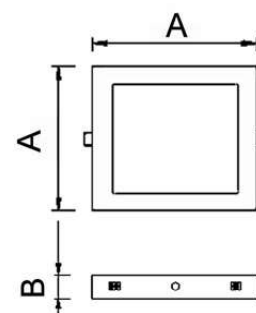

LED PANEL LIGHT

Recessed luminaire



PRI Voltage: 85-265V AC

Materials: 6063A Type Aluminum

Framework Colour: White

LED SMD ✓

IP 20



HANGING WIRE



CLIPS



SURFACE MOUNTED KIT



| | A(mm) | B(mm) | C(mm) | | | | |
|-----------------------|-------|-------|-------|-----|--------|--------|--------|
| MNK-PL151101-3030-8W | 295 | 10 | - | 8W | 640lm | 20000H | ≥15000 |
| MNK-PL151101-3030-12W | 295 | 10 | - | 12W | 960lm | 20000H | ≥15000 |
| MNK-PL151101-6060-36W | 595 | 10 | - | 36W | 3200lm | 20000H | ≥15000 |
| MNK-PL151101-6060-40W | 595 | 10 | - | 40W | 3600lm | 20000H | ≥15000 |
| MNK-PL151101-6060-48W | 595 | 10 | - | 48W | 4400lm | 20000H | ≥15000 |
| MNK-PL151101-6060-60W | 595 | 10 | - | 60W | 5600lm | 20000H | ≥15000 |
| MNK-PL151101-6060-72W | 595 | 10 | - | 72W | 6600lm | 20000H | ≥15000 |

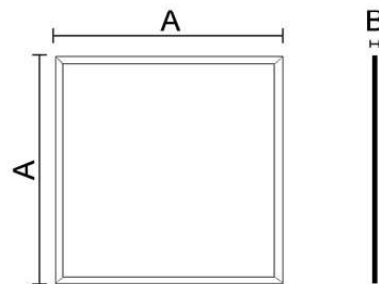

LED PANEL LIGHT

Recessed luminaire

PRI Voltage: 85-265V AC

Materials: 6063A Type Aluminum

Framework Colour: White

LED SMD ✓

IP 20



HANGING WIRE



CLIPS



SURFACE MOUNTED KIT



| | A(mm) | B(mm) | C(mm) | | | | |
|------------------------|-------|-------|-------|-----|--------|--------|--------|
| MNK-PL151101-3060-24W | 295 | 10 | 595 | 24W | 1920lm | 20000H | ≥15000 |
| MNK-PL151101-30120-36W | 295 | 10 | 1195 | 36W | 3200lm | 20000H | >15000 |
| MNK-PL151101-30120-40W | 295 | 10 | 1195 | 40W | 3600lm | 20000H | ≥15000 |
| MNK-PL151101-30120-48W | 295 | 10 | 1195 | 48W | 4400lm | 20000H | ≥15000 |
| MNK-PL151101-30120-72W | 295 | 10 | 1195 | 72W | 6600lm | 20000H | ≥15000 |
| MNK-PL151101-60120-60W | 595 | 10 | 1195 | 60W | 5800lm | 20000H | ≥15000 |
| MNK-PL151101-60120-72W | 595 | 10 | 1195 | 72W | 6900lm | 20000H | ≥15000 |

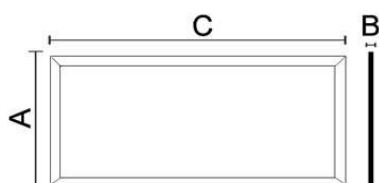



More about us in www.minkolighting.com

MINKO LIGHTING CO.,LTD.

Factory ADD: Floor 6,No.32, street 7,Gusan Industrial Road,Guzhen Town,Zhongshan City,Guangdong Province,China

Email:minko01@163.com/sales1@minkolighting.com

Phone/whatsapp:0086 15219945323