

Sistema tubular flexible

REMAK MEXICO



Remak Mexico

SISTEMAS INDUSTRIALES REMAK nuestra política de servicios es ofrecerle a nuestros clientes producto y servicio con la mejor calidad para mejorar continuamente lo cual ponemos a su consideración el siguiente catálogo de componentes en sistemas tubulares de la marca Samsung así como nuestros servicios de fabricación.

Los sistemas tubulares REMAK son la mejor herramienta para conseguir un flujo continuo en transferencia de materiales y en sistemas de almacenamiento para proporcionar facilidades a las líneas de producción cumpliendo con los criterios estandarizados de Lean Manufacturing. Describiendo visualmente todos los componentes que contiene nuestro catálogo así como ayuda de información técnica y algunas aplicaciones fabricadas por nuestra empresa.

ÍNDICE

- 1 **PORTADA**
- 3 **ÍNDICE**
- 4 **SAMSUNG PIPE JOIN SYSTEM**
 - 5 TUBOS / PIPES
 - 6 METAL JOINTS
 - 9 METAL JOINT SET
 - 12 METAL ACCESSORIES
 - 15 BUSHINGS
 - 16 ROLLER TRACKS
 - 17 MOUNTING BRACKETS
 - 19 PVC & PLATIC ACCESSORIES

- 22 **ALLUMINIUM PIPE SYSTEM**
- 25 **CASTERS**
- 29 **CATÁLOGO DE APLICACIONES**
- 32 **FICHAS TÉCNICAS**

REMAK

PIPE JOIN SYSTEM

TUBOS

PIPES



SSP2807-SS



SSP2810-SS



CP2810-G



CP2810-IV



CP2810-BK

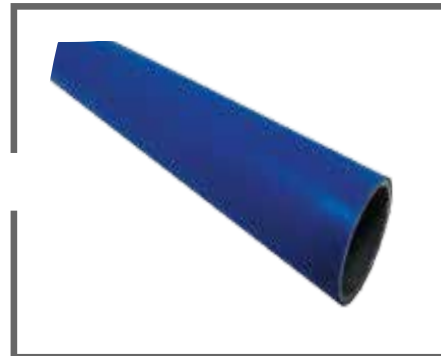

CP2810-BL

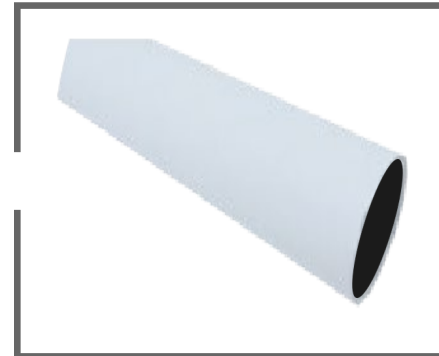

CP2810-WH

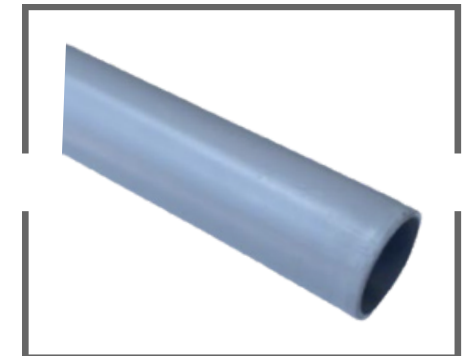

CP2810-LG

Especificaciones:

- Recubrimiento: ABS
- Diam. Exterior: 28 mm
- Longitud: 4mts
- Espesor de 1.0 mm
- Acero Rolado en Frio
- Peso: 2.6 kg/Tramo
- Atado: 10 Tramos

Restricciones:

ABS no usar a interperie, ambiente de soldadura, ni exponer a solventes o aceites solubles como thinner.

COATED PIPES COLOR CODE

COLOR CODE NUMBERING SYSTEM FOR COATED PIPES

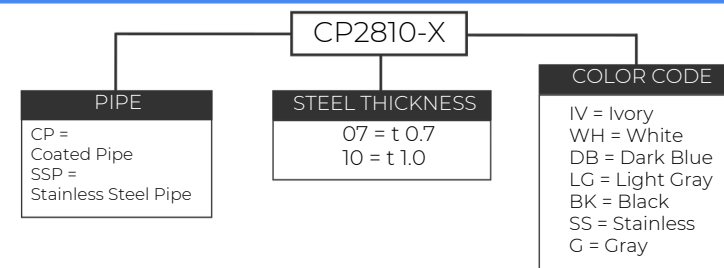

Lean Manufacturing

Servicios & Fabricación

Sistema Tubular ALM

TEL: 7229133999

✉ Ventas@remakmexico.com

remakmexico.com

METAL JOINTS

*B=Black *Z = Zinc



H-1



H-1A



H-2



H-3G (Gripe Type)



H-4



H-6



H-6A



H-7A



H-7B

Lean Manufacturing

Servicios & Fabricación

Sistema Tubular ALM

METAL JOINTS

*B=Black *Z = Zinc



H-8



H-10



H-11



H-12



H-13A



H-13B



H-14



H-15



H-16

Lean Manufacturing

Servicios & Fabricación

Sistema Tubular ALM

METAL JOINTS

*B=Black *Z = Zinc



H-17



H-45



H-60



H-90

METAL JOINT SET

*B = Black *Z = Zinc



HJ-1



HJ-1A



HJ-2

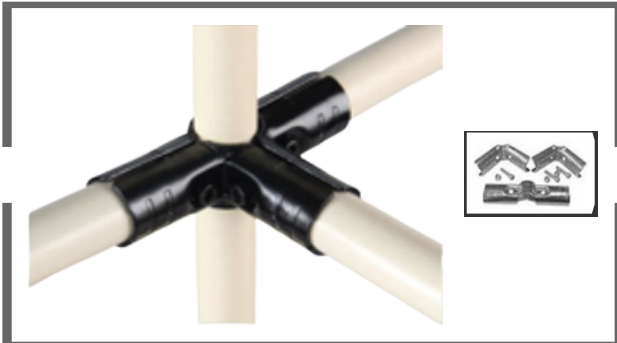

HJ-3



HJ-4



HJ-5



HJ-6



HJ-6A



HJ-7

Lean Manufacturing

Servicios & Fabricación

Sistema Tubular ALM

METAL JOINT SET

*B = Black *Z = Zinc



HJ-8



HJ-10

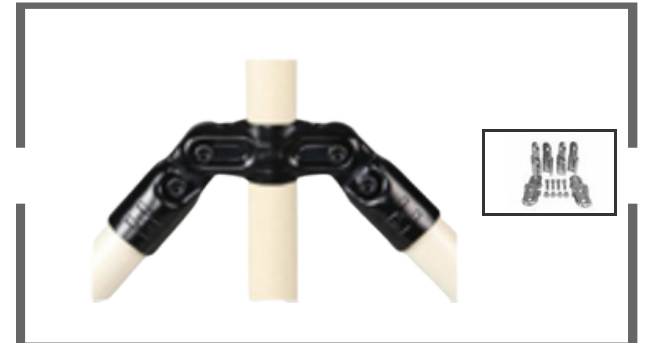

HJ-11

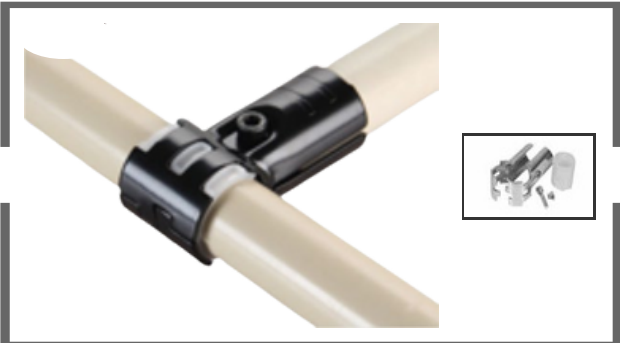

HJ-12

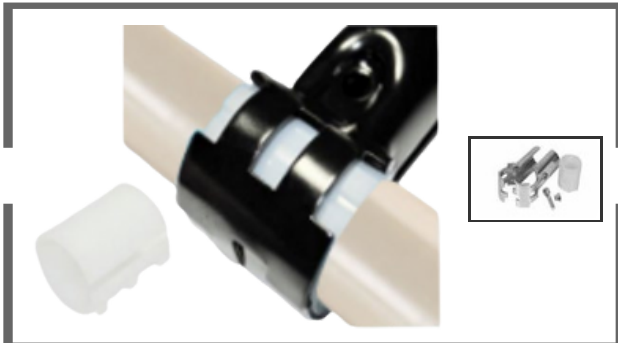

GAP 12



HJ-13B



HJ-14



HJ-15



HJ-16

Lean Manufacturing

Servicios & Fabricación

Sistema Tubular ALM

METAL JOINT SET

*B = Black *Z = Zinc

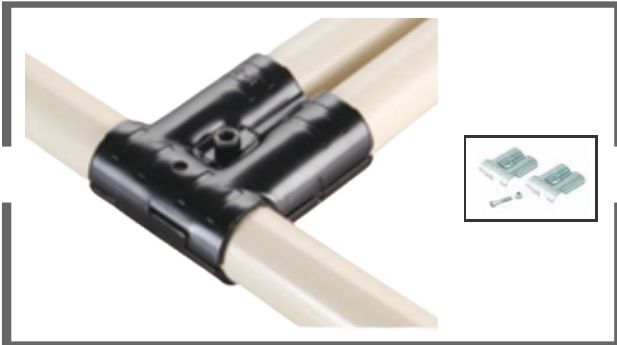

HJ-17



HJ-45

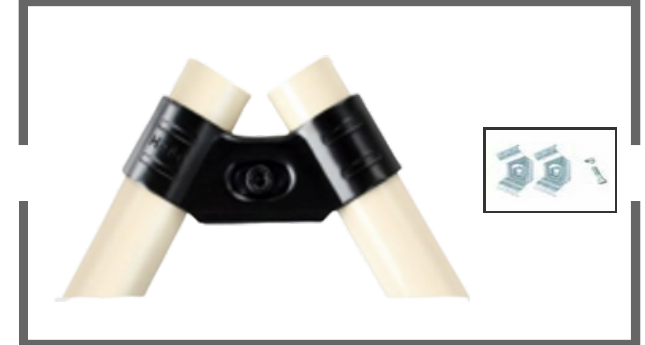

HJ-60



HJ-90

METAL ACCESSORIES

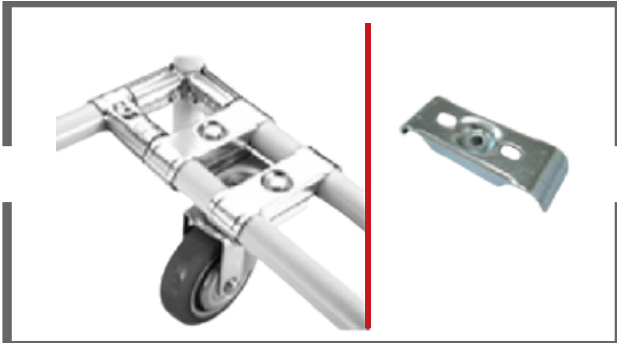

CM-100

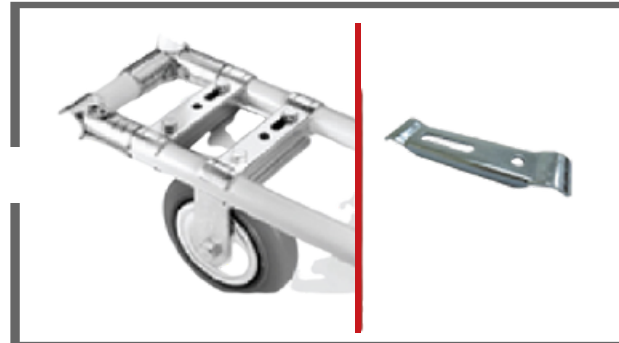

CM-200

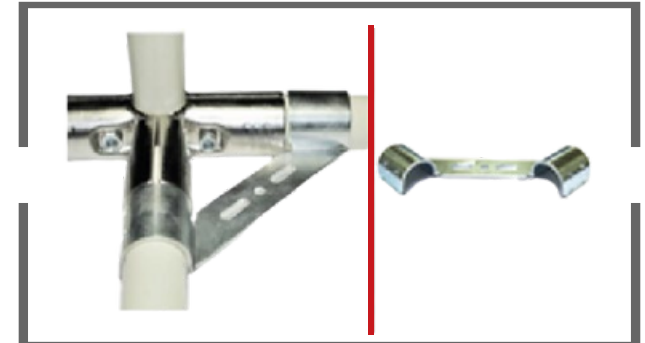

CM-A

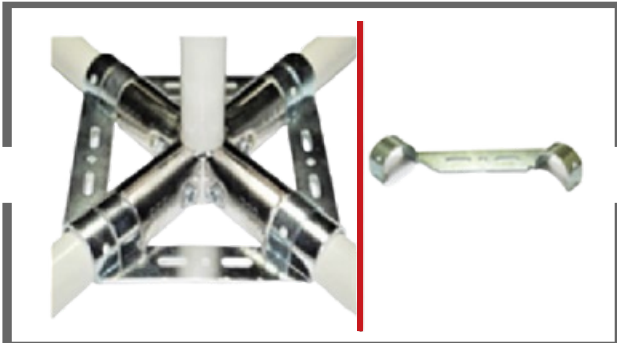

CM-B

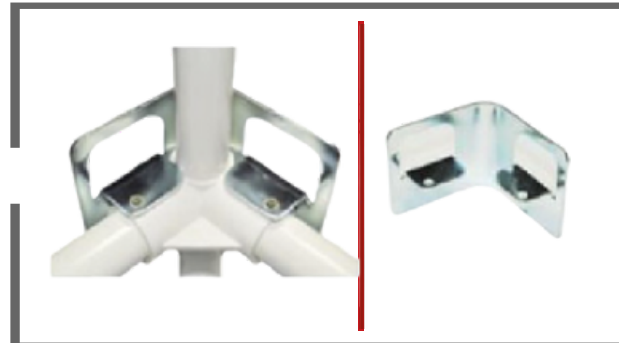

CM-C



TH-8L

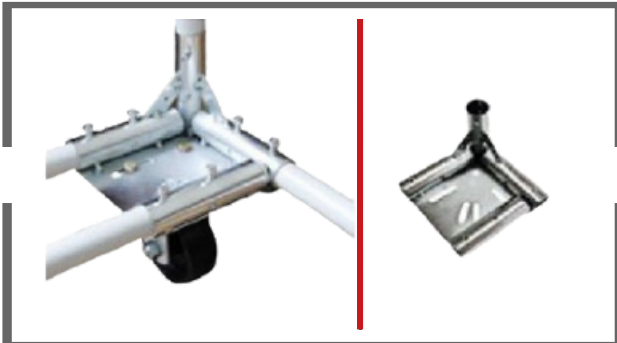

MCP-AL

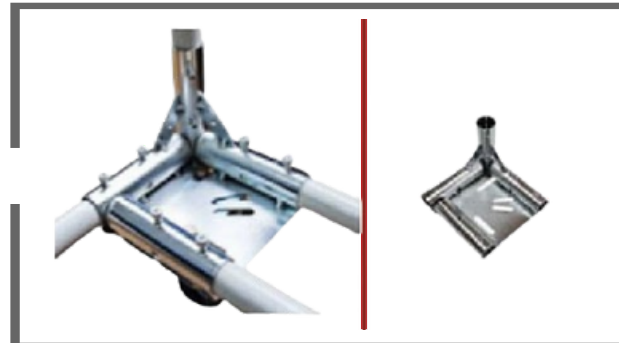

MCP-AR

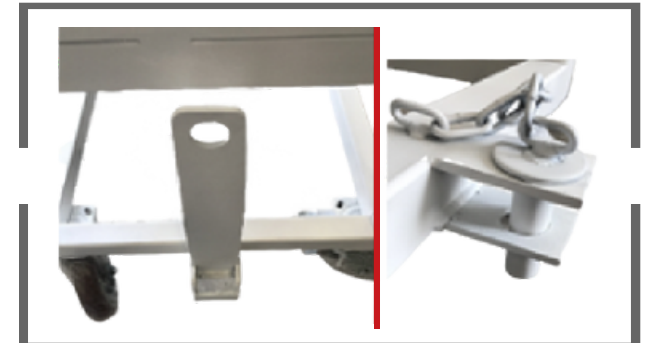

Tir-jal: Metal

Lean Manufacturing

Servicios & Fabricación

Sistema Tubular ALM

METAL ACCESSORIES



Tir-Jal: Tubular

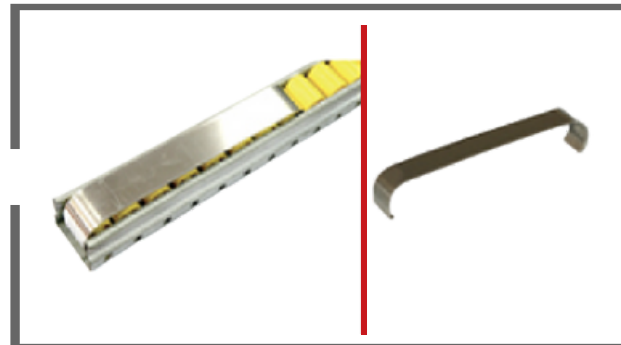

EWS-A

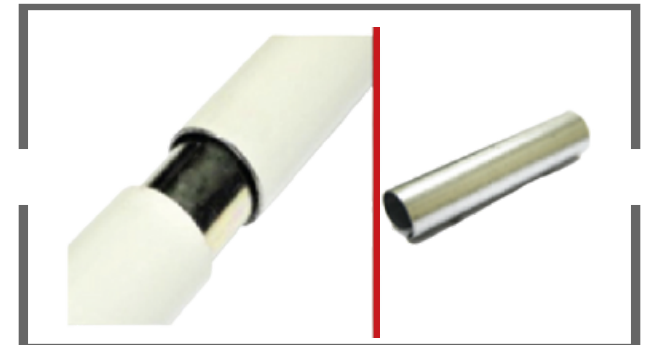

P-CON-A

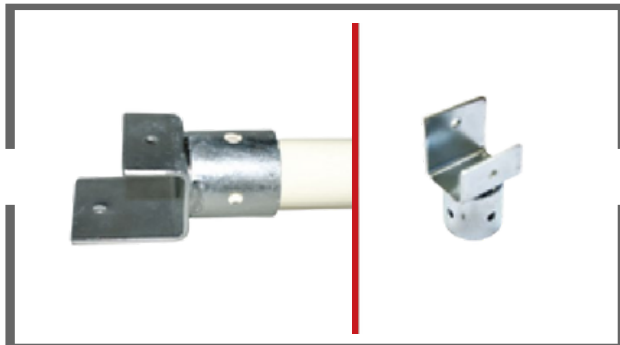

PR-A

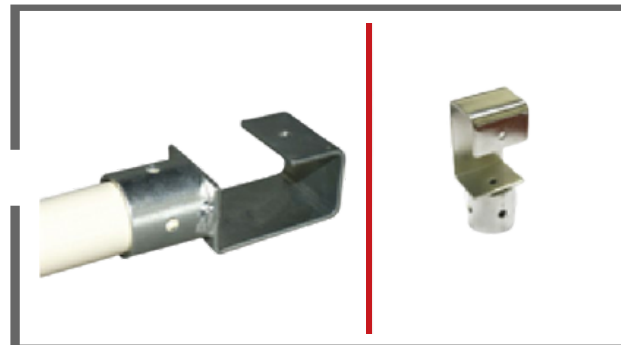

PR-B

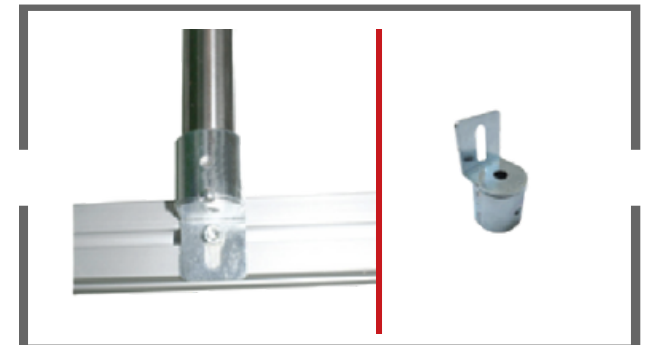

PR-L

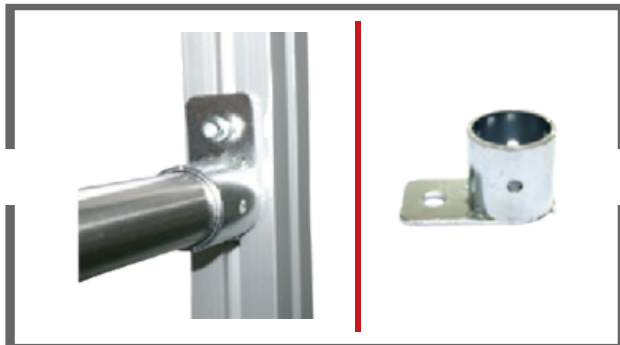

PR-S



SA



SA-S

Manufacturing

Servicios & Fabricacion

Sistema Tubular ALM

METAL ACCESSORIES

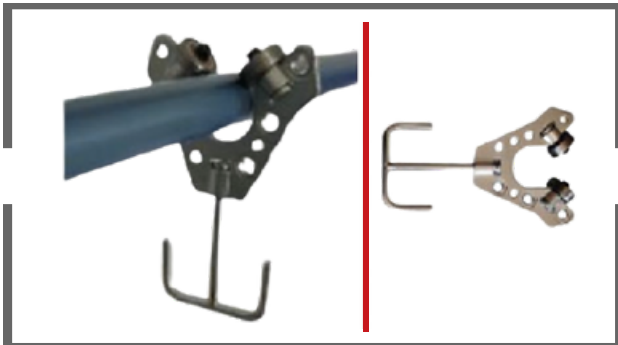

MR-2

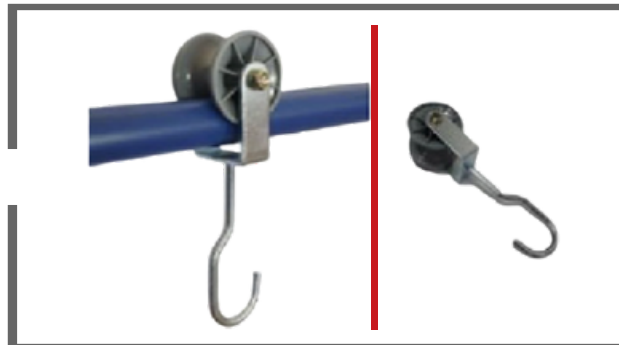

MR-3

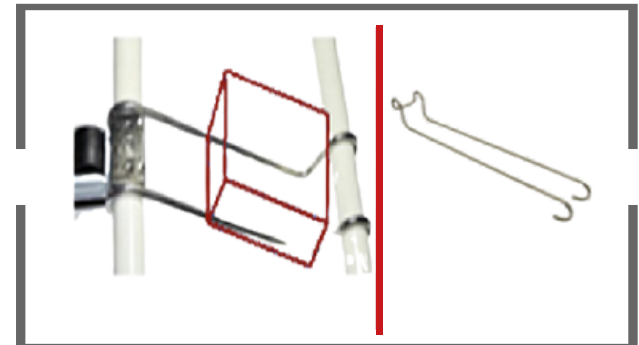

TB-300

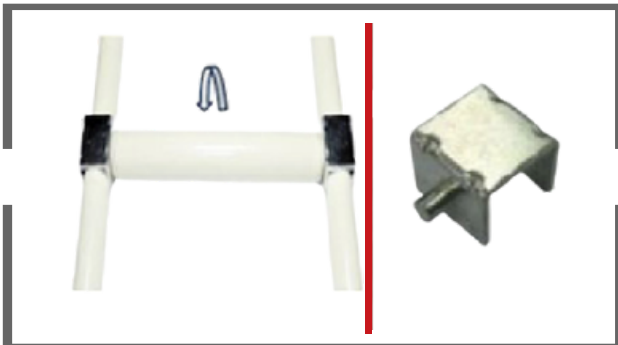

GS-RA

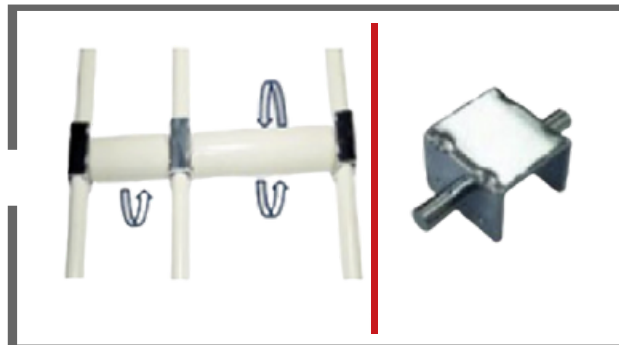

GS-RB

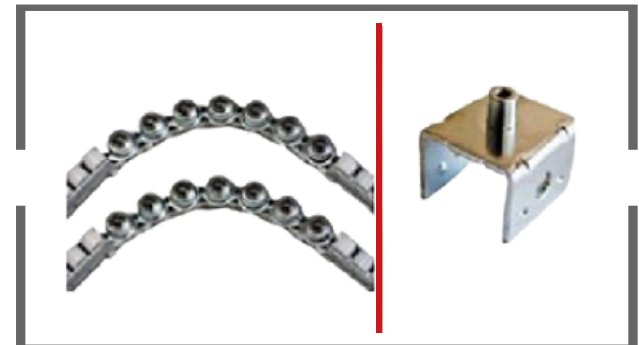

GS-RC



BT-1

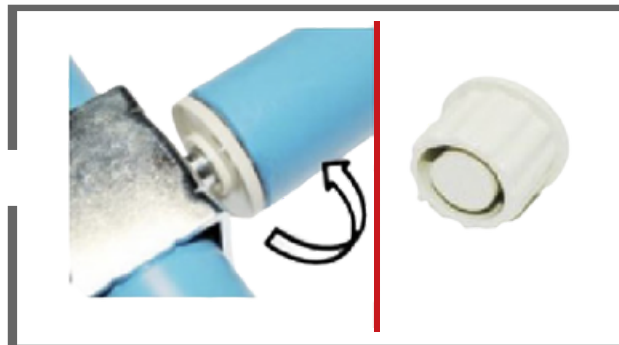

GAP-10A



GAP-12S

BUSHINGS



BS-2810-A



BS-2810-B



AD-SM



AD-SMS



RL5



DA50



50 JUEGOS

KTT06B



RL8 Pata Redonda

Manufacturing

Servicios & Fabricación

Sistema Tubular ALM

ROLLER TRACKS

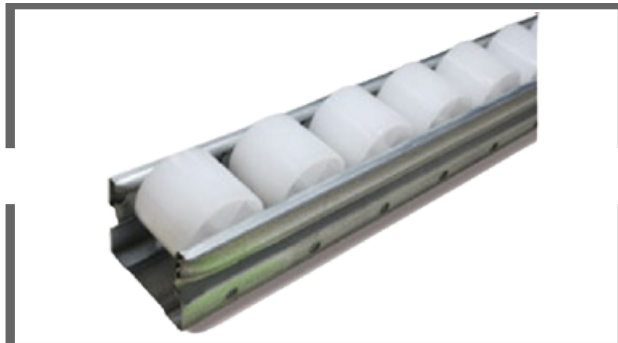

RT-40WH



RT-40BK

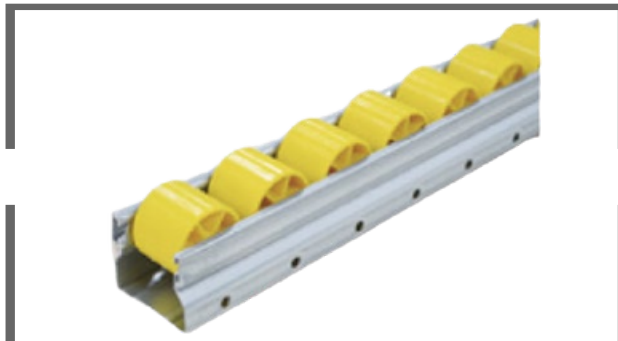

RT-4YE

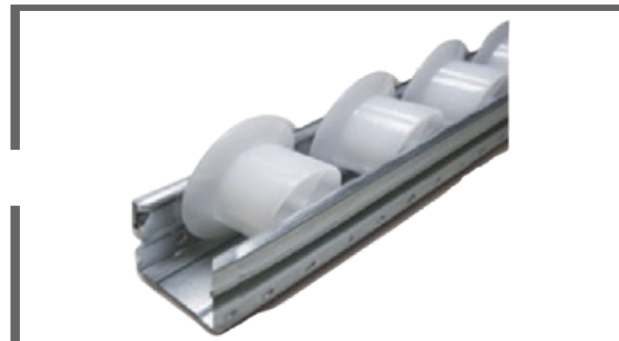

RT-40WHG

STANDAR LENGTH = 4000MM

COLOR = WH, BK, YE.

LOAD CAPACITY = 150 KG.

ROLLER DIAMETER = 32 MM.

SHAFT DIAMETER = 4 MM.

ROLLER PITCH = 22 MM.

GALVANISED STEEL (SPCC) / PE

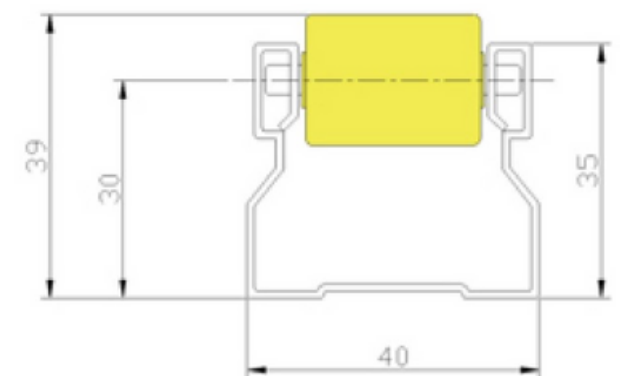

MOUNTING BRACKETS

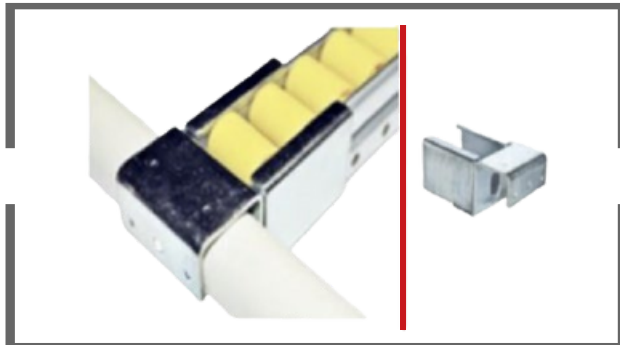

GP-A

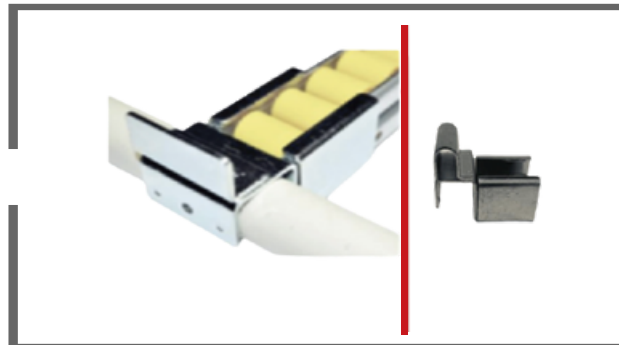

GP-B

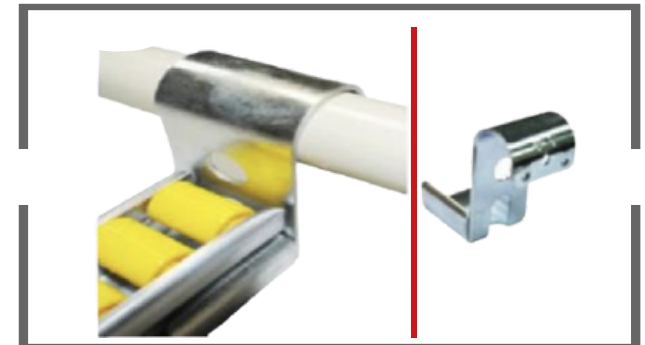

GP-D

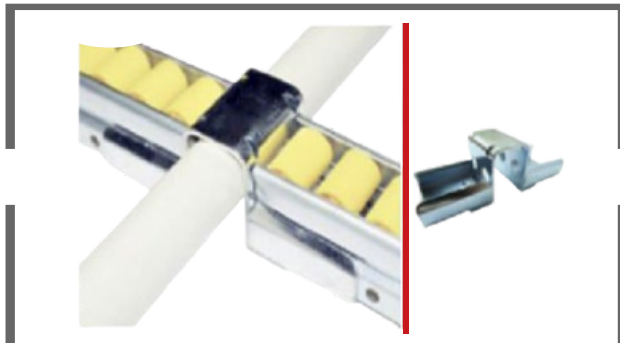

GP-H

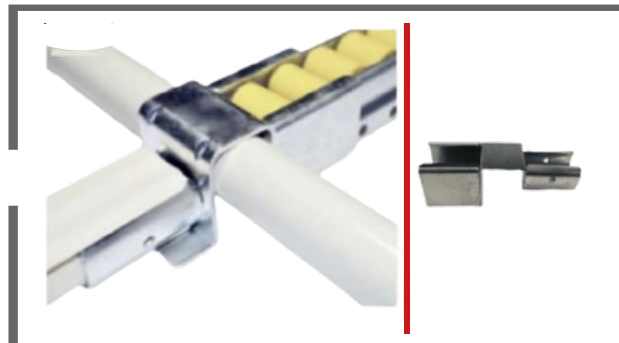

GP-J



GP-C1

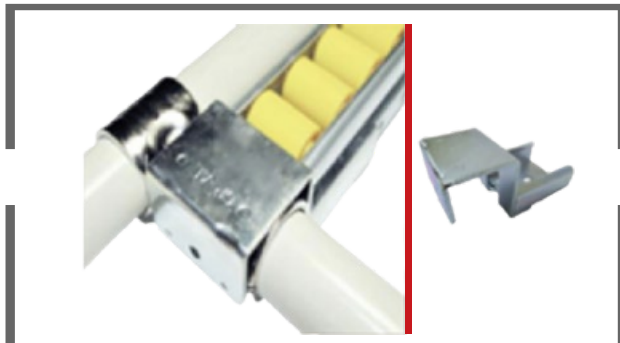

GP-AL

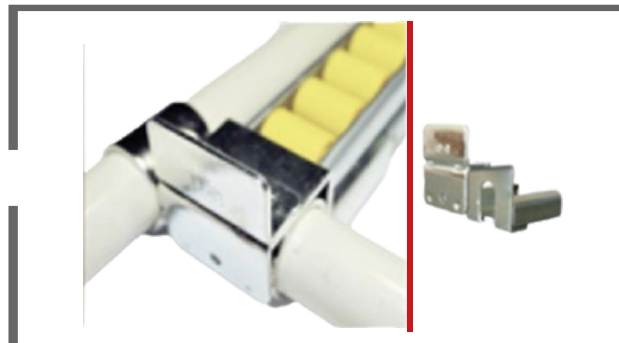

GP-BL

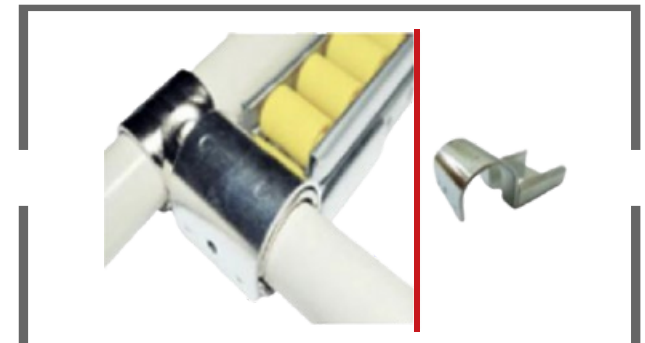

GP-ARL

Lean Manufacturing

Servicios & Fabricación

Sistema Tubular ALM

MOUNTING BRACKETS

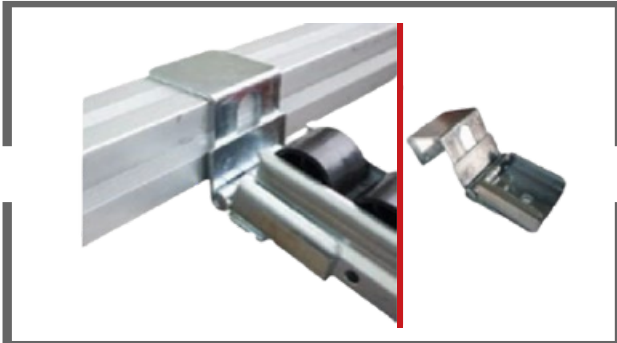

APL-M40A

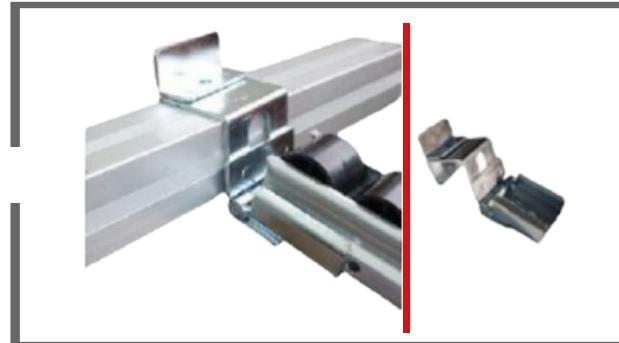

APL-M40B

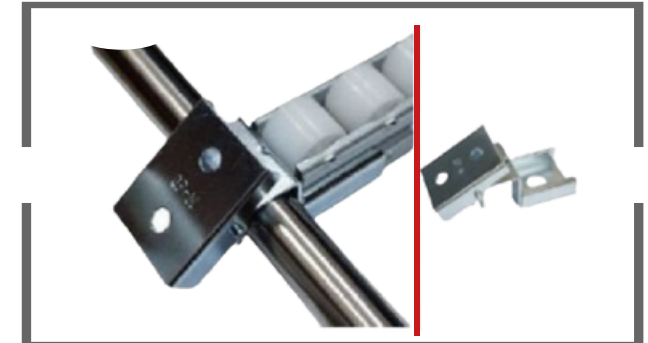

GP-M

PVC & PLASTIC ACCESSORIES

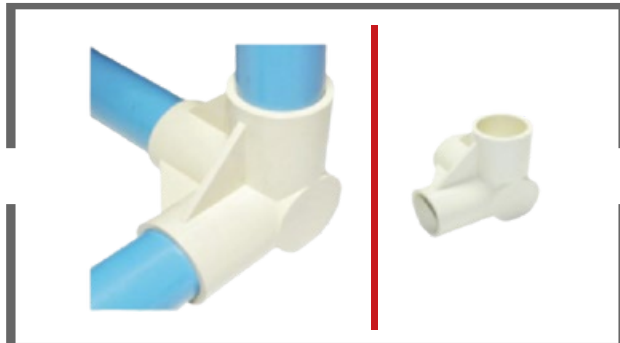

GAP-02A



GAP-05



GAP-13

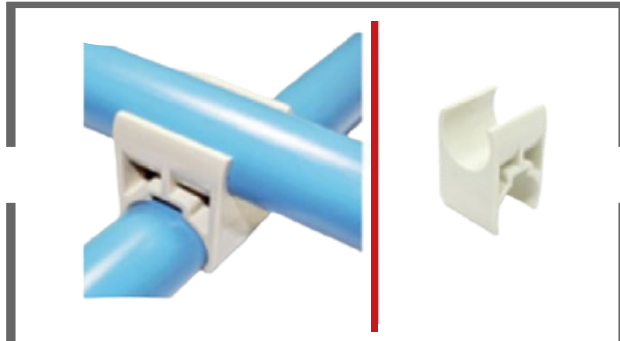

GAP-16

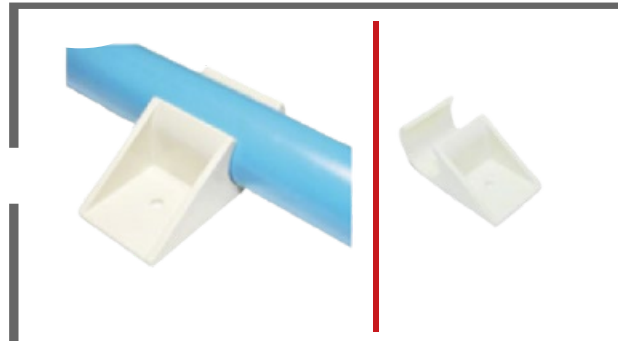

GAP-17

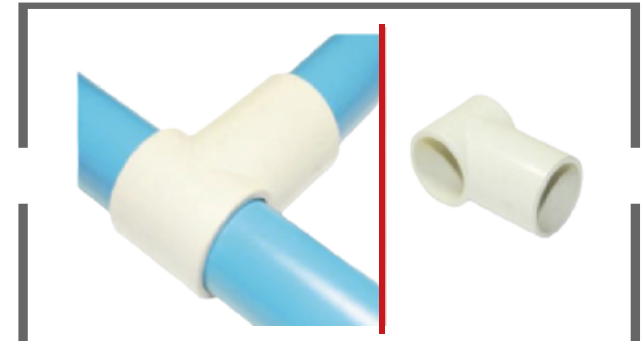

GAP-18

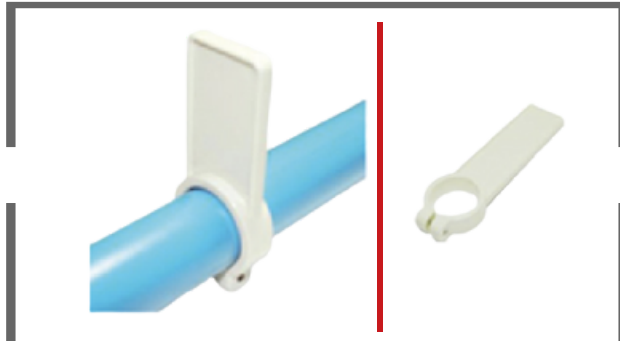

GAP-19A

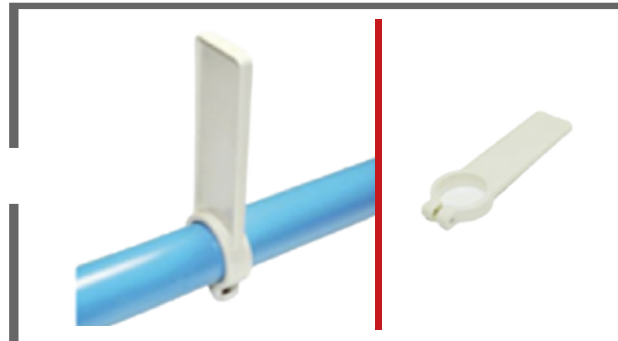

GAP-19B

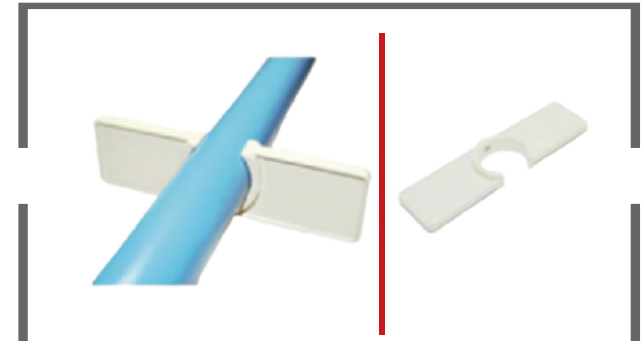

GAP-19C

Lean Manufacturing

Servicios & Fabricación

Sistema Tubular ALM

PVC & PLASTIC ACCESSORIES

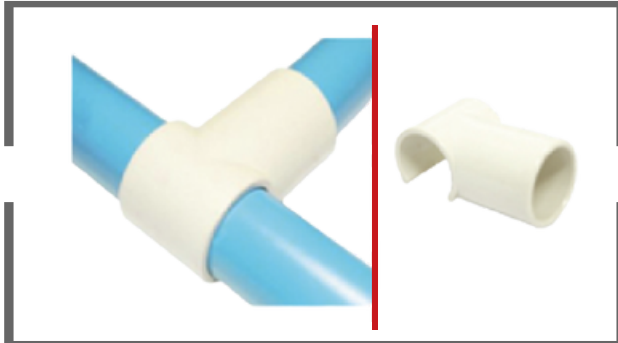

GAP-20

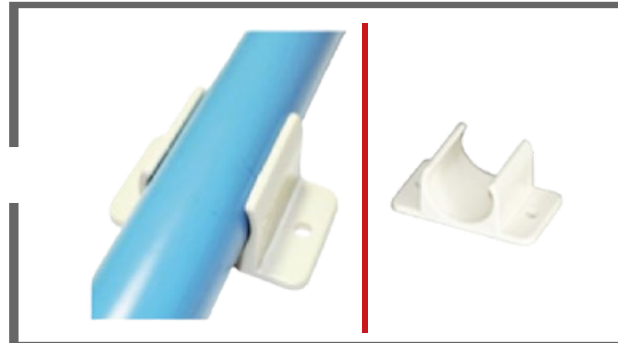

GAP-49

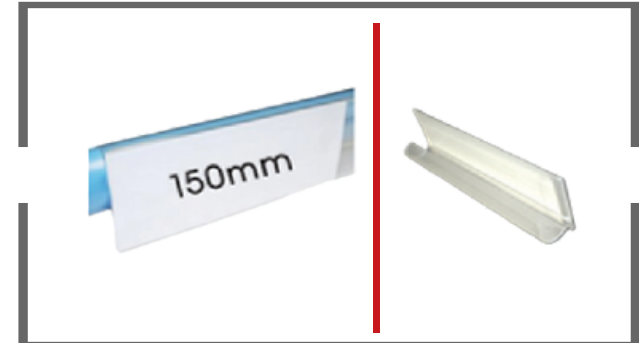

NP-150

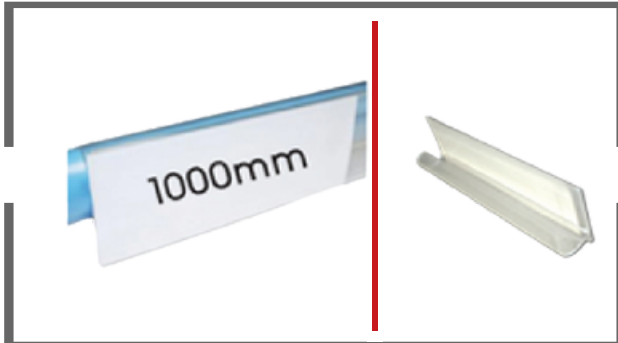

NP-150

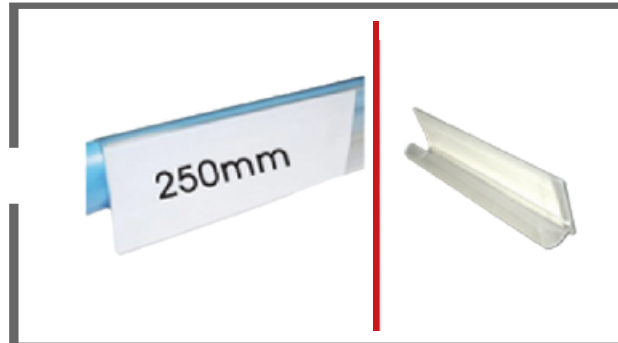

NP-250



GAP-12 CAP

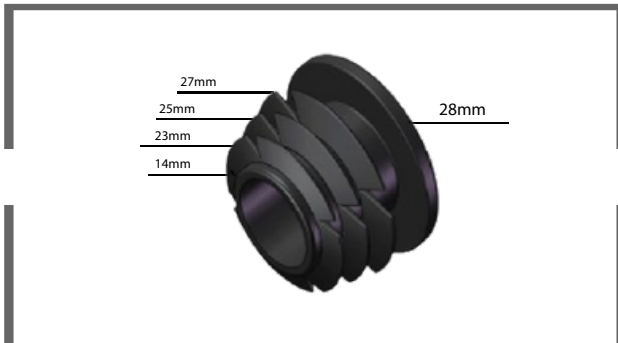

CAP-01 BK



CAP-03 IV



DPC14 3.0 mts.

RTG-3 4.0 mts.

Lean Manufacturing

Servicios & Fabricación

Sistema Tubular ALM

PVC & PLASTIC ACCESSORIES

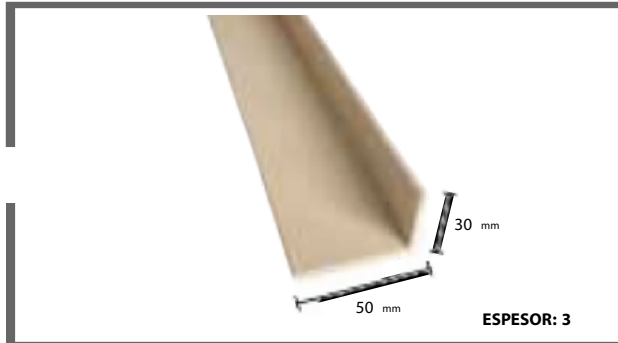

DPC1

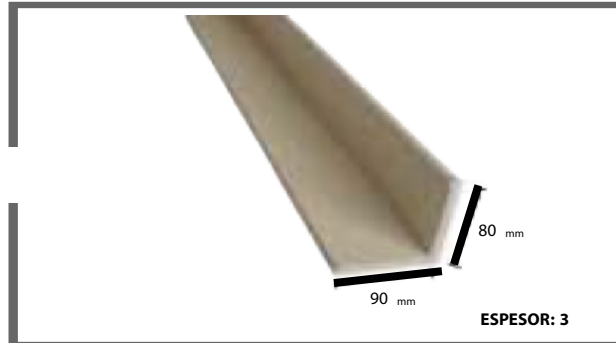

DPC3

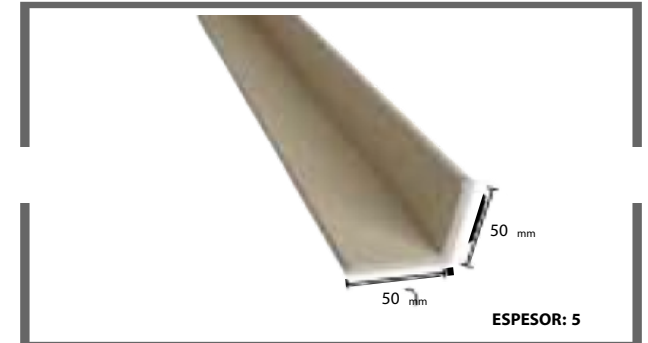

DPC5

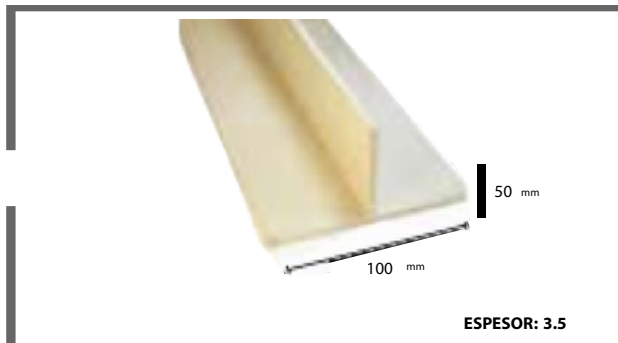

DPC9A

REMAK

ALLUMINIUM

PIPE SYSTEM

ALLUMINIUM PIPE SYSTEM



A-1



A-2



A-3



A-4

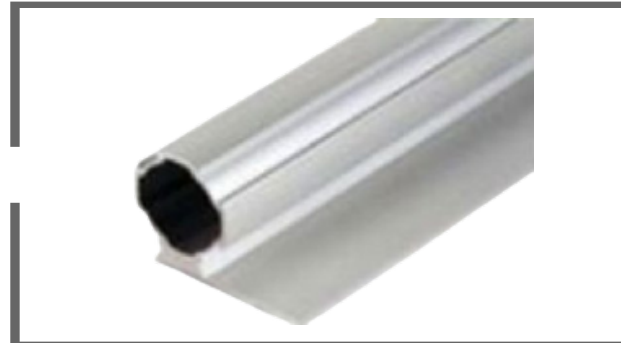

A-5



A-H1



A-H2



A-H3



A-H4

Lean Manufacturing

Servicios & Fabricación

Sistema Tubular ALM

ALLUMINIUM PIPE SYSTEM



A-H5



A-H6



A-H7



A-H8



AP-1 Tapón



A-P2



ALLUP-12G Inserto

REMAK
CASTERS

CASTERS

95-GURY150TL

TOTAL LOCK GIRATORIA

LOADCAPACITY 350KG COLOR RED

SHOCK ABSORBER
CASTER

6" X 2"

POLIURETANO CON
RIN DE ACERO

RESORTES ALTA
RESISTENCIA
HERRAJE DE ACERO
REFORZADO



94-GURY150TL

TOP PLATE FIJA

LOADCAPACITY 350KG COLOR RED

SHOCK ABSORBER
CASTER

6" X 2"

POLIURETANO CON
RIN DE ACERO

RESORTES ALTA
RESISTENCIA
HERRAJE DE ACERO
REFORZADO



271URY075T12

SWIVEL VASTAGO 1/2"

LOADCAPACITY 90KG COLOR RED

STEM SWIVEL
CASTER

3" X 1 1/4"

POLIURETANO

DOBLE BALERO
PRECISIÓN

SIN MARCAS EN EL
PISO



273URY075T12

TOTAL BRAKE VASTAGO 1/2"

LOADCAPACITY 90KG COLOR RED

STEM SWIVEL
CASTER

3" X 1 1/4"

POLIURETANO

DOBLE BALERO
PRECISIÓN

SIN MARCAS EN EL
PISO



CASTERS

271URY100T12

SWIVEL VASTAGO 1/2"

LOADCAPACITY 100KG **COLOR** RED

STEM SWIVEL
CASTER

4" X 1 1/4"

POLIURETANO
DOBLE BALERO
PRECISIÓN
SIN MARCAS EN EL
PISO



273URY100T12

TOTAL BRAKE VASTAGO 1/2"

LOADCAPACITY 100KG **COLOR** RED

STEM SWIVEL
CASTER

4" X 1 1/4"

POLIURETANO
DOBLE BALERO
PRECISIÓN
SIN MARCAS EN EL
PISO



274URY075TPL

TOTAL BRAKE GIRATORIA

LOADCAPACITY 100KG **COLOR** RED

TOP PLATE
CASTER

3" X 1 1/4"

POLIURETANO
DOBLE BALERO
PRECISIÓN
RODAJE CON
PLACA BASE



274URR075TPL

TOP PLATE FIJA

LOAD CAPACITY 100KG **COLOR** RED

TOP PLATE
CASTER

3" X 1 1/4"

POLIURETANO
DOBLE BALERO
PRECISIÓN
RODAJE CON
PLACA BASE



CASTERS

274URY100TPL
274URY075TPL

TOTAL BRAKE GIRATORIA

LOADCAPACITY 110KG COLOR RED

274URR100TPL
RR075TPL

TOP PLATE FIJA

LOAD CAPACITY 110KG COLOR RED

TOP PLATE
CASTER

4" X 1 1/4"

POLIURETANO
DOBLE BALERO
PRECISIÓN
RODAJE CON
PLACA BASE



TOP PLATE
CASTER

4" X 1 1/4"

POLIURETANO
DOBLE BALERO
PRECISIÓN
RODAJE CON
PLACA BASE



REMAK

CATÁLOGO DE APLICACIONES

CATÁLOGO DE APLICACIONES



Lean Manufacturing

Servicios & Fabricación

Sistema Tubular ALM

SOLUCIONESPARAMEJORA CONTINUA

CATÁLOGO DE APLICACIONES

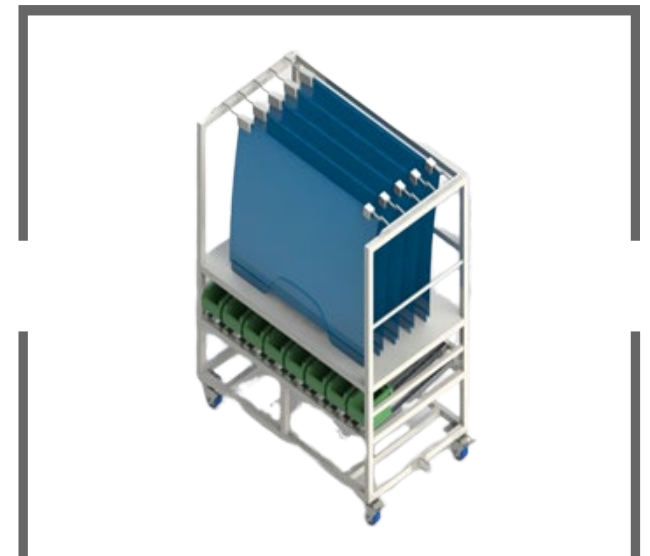

Lean Manufacturing

Servicios & Fabricación

Sistema Tubular ALM

FICHA TÉCNICA

CAPACIDAD DE CARGA DEL TUBO

CARGA PUNTUAL

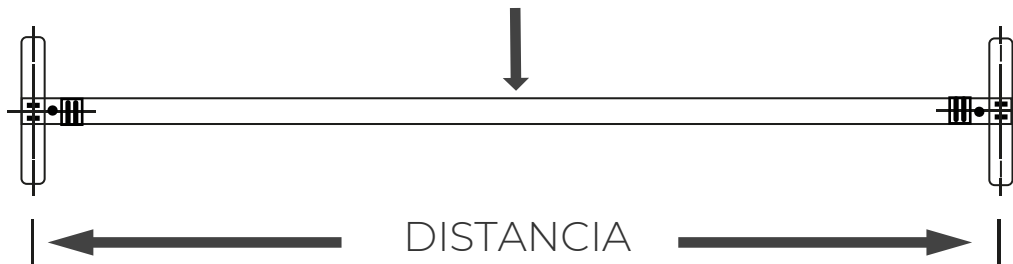

CARGA DISTRIBUIDA



TUBO DND 0.9mm ESPESOR CARGA MÁXIMA

| DISTANCIA | C PUNTUAL | C |
|-----------|-----------|--------------|
| mm | kg. | DISTRIBUCIÓN |
| 205 | 221 | kg. |
| 405 | 112 | 441 |
| 605 | 75 | 221 |
| 805 | 57 | 148 |
| 1005 | 46 | 112 |
| 1205 | 39 | 90 |
| 1405 | 33 | 75 |
| 1605 | 29 | 65 |
| 1805 | 26 | 57 |

51

FICHA TÉCNICA

RESISTENCIA A LA FLEXIÓN DE RIEL CON RUEDA

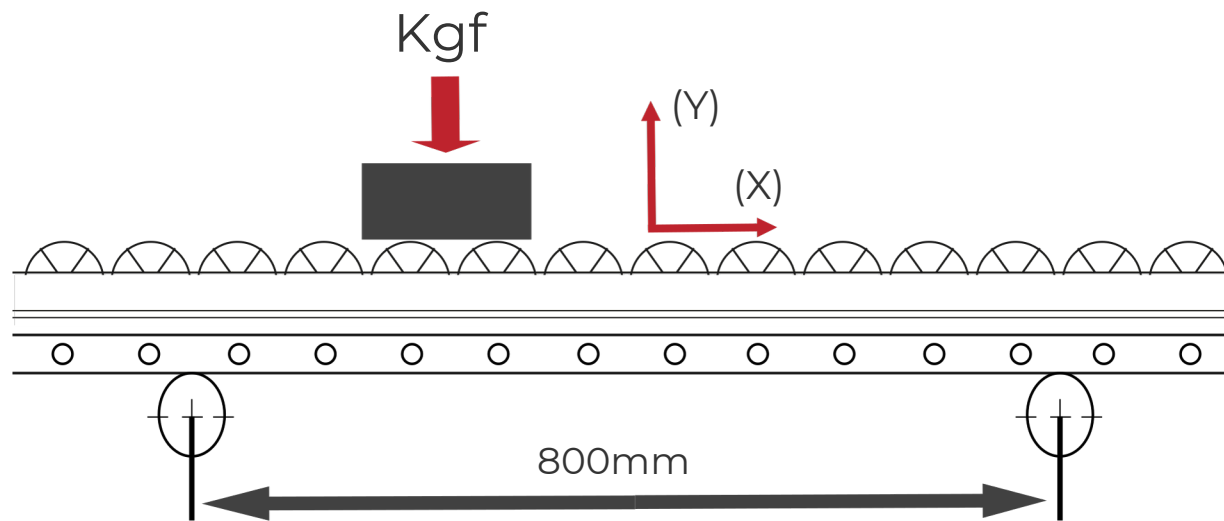

LONGITUD DE CENTRO A CENTRO (800 mm)

UNIT: kgf

PWC-40A

185

REMAK

SOLUCIONES PARA MEJORA CONTINUA

SISTEMAS TUBULARES

Advanced Lean Manufacturing

remakmexico.com



TEL:7229133999



 Ventas@remakmexico.com