

# GIAM

INNOVANDO



TRANSFORMANDO

CORPORATIVO



ACERO INOXIDABLE



CARPINTERÍA



GASTROGIAM



*"Del compromiso individual al esfuerzo de un equipo, eso hace que un equipo funcione, eso hace que una sociedad funcione, eso hace que una compañía funcione"*

Vince Lombardi

GRUPOGIAM  
WWW.GRUPOGIAM.COM



# GIAMM

INNOVANDO  TRANSFORMANDO



## CATÁLOGO LÍNEA GASTRONOMICA

*La cocina de autor es poner toda tu personalidad en lo que cocinas, y ese sentimiento convierte el platillo en algo distinto*  
ferran Adria



MOBILIARIA AREA COCCION

MOBILIARIO  
ESTUFA MAESTRA  
PARILLA 6 QUEMADORES  
COMAL TORTILLERO  
FOGON ALTO 2 PLAZAS  
PLANCHA  
FOGON BAJO PARA OLLAS



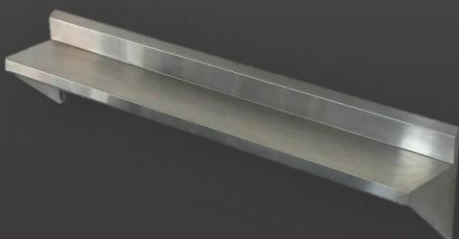
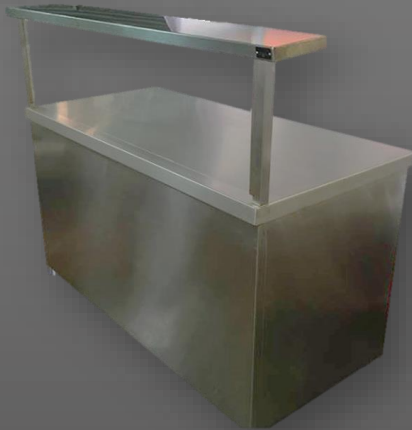

MOBILIARIO  
MESA TIPO GABINETE  
MESA TIPO ISLA  
MESA ISLA MOBIL  
MESA GABINETE CON REPISA  
MESA A PARED  
REPISA GARABATO  
REPISA



MOBILIARIA AREA LAVADO

MOBILIARIO  
GABINETE TARJA DERECHA  
TARJA TIPO ISLA DERECHA  
TARJA A PARED  
LAVAMANOS  
TARJA DOBLE CENTRAL  
TARJA TRIPLE CENTRAL



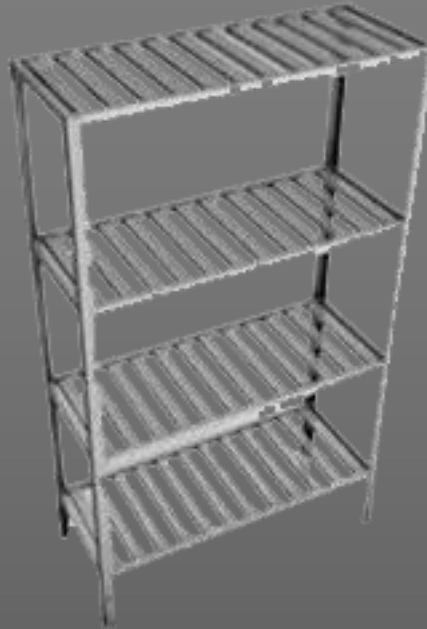

MOBILIARIA AREA ALMACENAJE Y  
GUARDADO

MOBILIARIO  
ALACENAS  
ANAQUEL TIPO MARIMBA  
ESPIGUERO MOBIL  
GABINETE GUARDADO  
ANAQUEL  
GABINETE ALTO CON PUERTAS  
ALACENAS



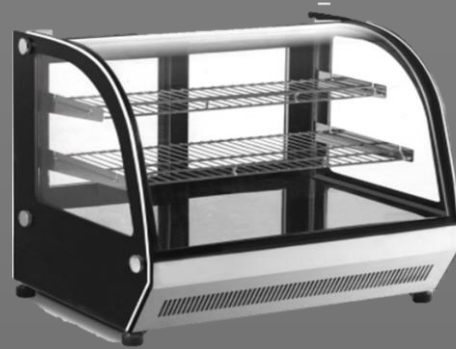

MOBILIARIA EQUIPAMIENTO

MOBILIARIO  
MESA SANDWICHERA  
VITRINA FRIA  
FREIDORA ELECTRICA  
BAÑO MARIA 3NG  
BASE REFRIGERADA  
FABRICA DE HIELO  
HORNO





MOBILIARIA UTENCILIOS  
DE COCINA

MOBILIARIO  
CUCHARONES  
INSERTOS GN  
EXTRACTOR DE JUGOS  
LICUADORA  
CREPERAS  
CUCHILLOS  
WAFLERAS EXHIBIDORAS  
ESQUIMERAS



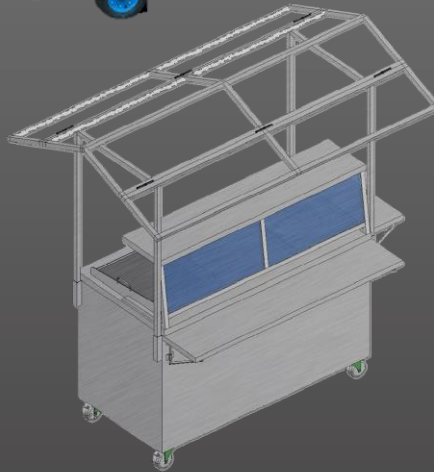
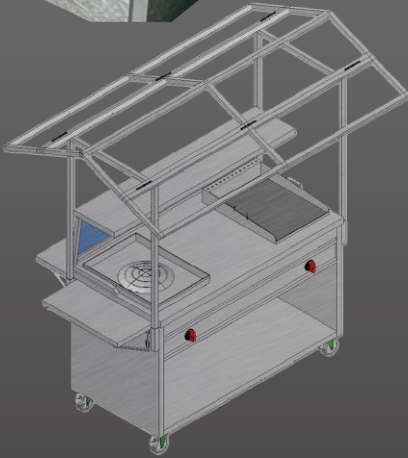

MOBILIARIO  
DONERAKYS  
MODULOS DE SERVICIO  
CARROS DE MULTISERVICIOS  
CARROS COMAL Y PLANCHA  
COCINA MOVIL

MOBILIARIA CARROS DE SERVICIO





# CATÁLOGO

## LÍNEA CLÍNICA / HOSPITALARIA

*El médico es el hombre que se mantiene a la cabecera del enfermo hasta que la medicina lo cureo o la naturaleza lo mate .*

Jean-Batiste Poquelin Molière

MODULO RECEPCION



ARCHIVO CLINICO



ESTACION DE ENFERMERIA



ESTACION DE ENFERMERIA



ESTACION DE DE TRABAJO

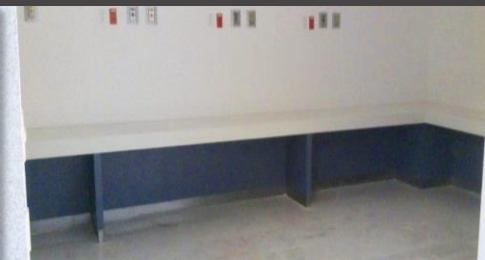

MATERIALES EMPLEADOS:  
SUPERFICIE SOLIDA  
LAMINADO PLASTICO  
MADERA DE PINO  
TRIPLAY DE PINO  
PEGAMENTOS DE CONTACTO  
ACERO INOXIDABLE  
HERRAJES DE USO

MOBILIARIO ADMINISTRATIVO  
OPERACIONAL



MODULO RECEPCION



ESTACION DE ENFERMERIA



ESTACION DE ENFERMERIA



ARCHIVO CLINICO



MODULO RECEPCION



MATERIALES EMPLEADOS:  
SUPERFICIE SOLIDA  
LAMINADO PLASTICO  
MADERA DE PINO  
TRIPLAY DE PINO  
PEGAMENTOS DE CONTACTO  
ACERO INOXIDABLE  
HERRAJES DE USO

MOBILIARIO ADMINISTRATIVO  
OPERACIONAL



PUERTAS DE HABITACION



PUERTAS DE QUIROFANOS



PUERTAS DE SERVICIO



PUERTAS DE ACCESOS



MATERIALES EMPLEADOS:  
LAMINADO PLASTICO  
MADERA DE PINO  
TRIPLAY DE PINO  
PEGAMENTOS DE CONTACTO  
ACERO INOXIDABLE  
VIDRIO TEMPLADO  
HERRAJES DE USO

MOBILIARIO OPERACIONAL



PUERTAS DE  
HABITACION



PUERTAS DE  
QUIROFANOS



PUERTAS DE  
SERVICIO



PUERTAS DE  
ACCESOS



MATERIALES EMPLEADOS:  
PINTURA FONDO / LACA  
MADERA DE PINO  
TRIPLAY DE PINO  
PEGAMENTOS DE CONTACTO  
ACERO INOXIDABLE  
VIDRIO TEMPLADO  
HERRAJES DE USO

MOBILIARIO OPERACIONAL



## BARANDALES



MATERIALES EMPLEADOS:  
TUBO DE 2" DE ACERO INOX  
TUBO DE 1" DE ACERO INOX  
SOLERA DE 1 ¼" X 2 " DE  
ACERO INOX  
BARRA SOLIDA DE ½" DE  
ACERO INOX.

MOBILIARIO OPERACIONAL



LABORATORIO  
CLINICO



MOBILIARIO  
MESAS DE EXPLORACION  
MASCARILLAS DE EQUIPOS  
REPISAS GARABATOS  
GABINETES DE TRABAJO  
ALACENAS  
MESAS DE TRABAJO  
CARROS DE TRANSPORTE

MOBILIARIO LABORATORIO CLINICO



ENFERMERIA Y  
ASISTENCIA



MOBILIARIO  
FREGADEROS DOBLES  
LABAMANOS  
PORTACOMODOS MOVIL  
BAÑOS DE ARTEZA  
GABINETE TRAMPAS DE YESOS  
SEPTICOS  
REPISAS SEPTICOS

MOBILIARIO ENFERMERIA Y ASISTENCIA



ENFERMERIA Y  
ASISTENCIA

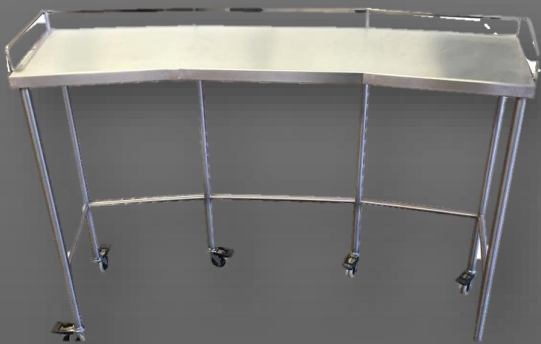

MOBILIARIO  
TRANSFER  
MESA MAYO  
MESA RIÑÓN  
LAVABO DE CIRUJANO  
CARRO DE CURACIONES  
CARRO DE EXPLORACION

MOBILIARIO ENFERMERIA Y ASISTENCIA





CARTERA DE CLIENTES



## **CORPORATIVO**

MANUEL SILICEO NO. 51 COL VICENTE RIVA  
PALACIOS MORELIA, MICHOACAN

TEL (443) 962 6098

MAIL: [oraciovaladez@hotmail.com](mailto:oraciovaladez@hotmail.com)  
[compras@giam-mexico.com](mailto:compras@giam-mexico.com)

## **OFICINAS CARPINTERIA**

MARIPOSA NO. 68 COL AMPLIACION GERTRUDIS  
SANCHES MORELIA, MICHOACAN

TEL (443) 690 8910

MAIL: [albertogarcianiето@hotmail.com](mailto:albertogarcianiето@hotmail.com)  
[goskinn@gmail.com](mailto:goskinn@gmail.com)

## **TIENDA GASTROGIAM**

MANUELA MEDINA NO. 167 COL GERTRUDIS  
BOCANEGRA MORELIA, MICHOACAN

TEL (443) 327 2088

MAIL [ventasgastrogiam@gmail.com](mailto:ventasgastrogiam@gmail.com)

CONTACTANOS

