

Professional Kitchen Equipment from Hungary

Valid from November 2022



BUSINESS
Superbrands^{7x}

'16 '17 '18 '19 '20 '21 '22

GASZTRO METÁL

Since 1951

www.gasztrometal.hu

Certificates



ABOUT US

Gasztrometál Zrt. Experience and competence since 1951

Gasztrometál Zrt. is a supplier of professional kitchen equipment. The plant with its site of 6 hectares is situated in Tatabánya, halfway between Budapest and Vienna close to the highway. We are the only producers in Hungary of boiling and tilting bratt pans (electric, gas, and steam units), potato peeling machines and vegetable cutters. Besides that we also produce gas and electric stock pot cookers, static ovens and stainless steel furniture, all of them are planned by our Development Department. An expanded network of resellers and service partners support our work, and make our product easy-accessible to our customers. Of course we also support our partners with annual service trainings and with continuous availability of spare parts. We are also the manufacturer of special stainless steel equipments like brewery tanks, paint mixing tanks and storage tank. Also a wide range of stainless steel furniture units can be ordered from our catalog, of course they are all customizable regarding to individual ideas.

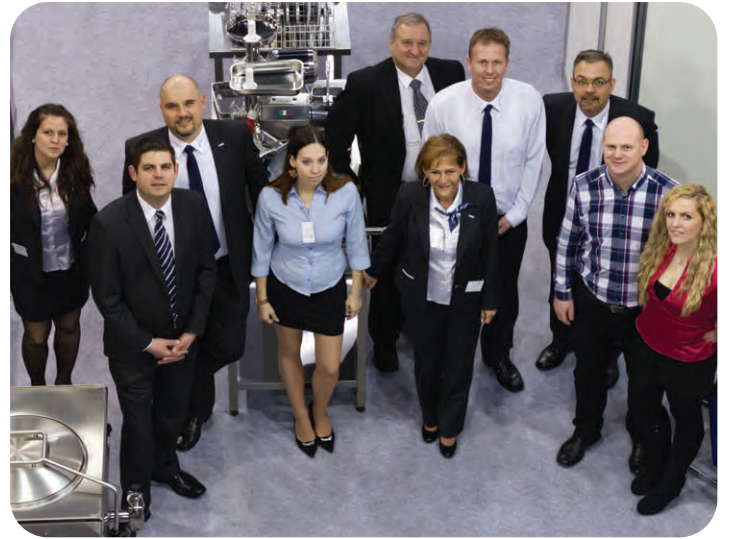

ABOUT US



Our strong points are Quality, Precision, Reliability and our Experience in stainless steel processing since more than 50 years.

Our professional team of 250 employees guarantee you the highest quality.

Feel free to contact us today and we make your ideas come true! In our well-equipped plant we can fulfill even the most special requests.



Professional Kitchen Equipment from Hungary

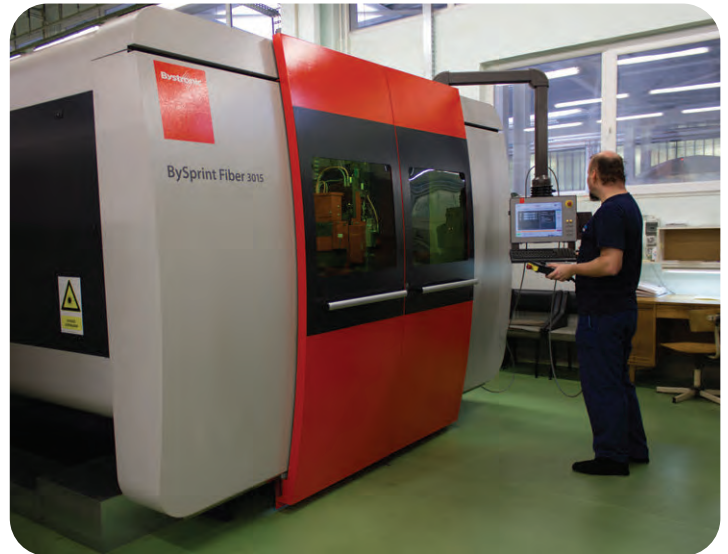
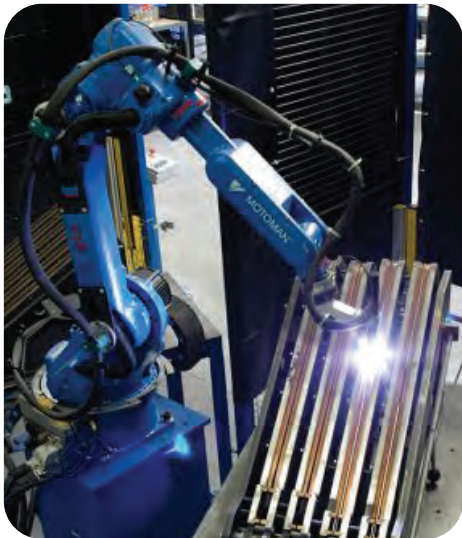





BOILING PANS

Nearly 50 years of manufacturing experience of boiling pans. They can be fitted into lines 700 and 900. Boiling pans are made of stainless steel from the base frame to the outer casing. Non-combustion use is guaranteed by indirect heating. Products harmless and long-term operation is ensured by dual security system and professional grade parts.



BOILING PANS

GAS BOILING PANS, CLASSIC CONTROLS

Code	Description	Capacity	Power	Voltage	Product image	List price (EUR)
GLR-782	Gas boiling pan, LPG and natural gas operation, TÜV certified Heating: indirect Ignition: piezo Water filling: manual Weight: 93 kg Size: 800x700x900 mm	80 liter	12.5 kW	-		5 200
GLR-102	Gas boiling pan, LPG and natural gas operation, TÜV certified Heating: indirect Ignition: ionization Water filling: automatic Weight: 128 kg Size: 900x900x900 mm	100 liter	14.5 kW	~1 N x 230 V, 50 Hz		6 000
GLR-152	Gas boiling pan, LPG and natural gas operation, TÜV certified Heating: indirect Ignition: ionization Water filling: automatic Weight: 139 kg Size: 900x900x900 mm	150 liter	19 kW	~1 N x 230 V, 50 Hz		6 200
GLF-202	Gas boiling pan, LPG and natural gas operation, TÜV certified Heating: indirect Ignition: ionization Water filling: automatic Weight: 209 kg Size: 1350x900x900 mm	200 liter	25 kW	~1 N x 230 V, 50 Hz		7 800
GLF-302	Gas boiling pan, LPG and natural gas operation, TÜV certified Heating: indirect Ignition: ionization Water filling: automatic Weight: 220 kg Size: 1350x900x900 mm	300 liter	32 kW	~1 N x 230 V, 50 Hz		8 000

Our boiling pans listed below can be ordered with a special, removable mixer:

**GLR-102; GLR-105;
GLR-152; GLR-155**

**ELR-101; ELR-105;
ELR-151; ELR-155**

NLR-101; NLR-151







BOILING PANS

GAS BOILING PANS, TOUCHSCREEN CONTROLS

Safer and more user-friendly usage

- Touch control • Multilingual support • On-screen cooking information
- Timed cooking function • Stepless temperature control • Service options menu
- Warning alert when inspection is necessary • Operation logging • Diagnostic test
- On-screen error codes • Operating hours counter • HACCP stats • Optional e-mail sending

Code	Description	Capacity	Power	Voltage	Product image	List price (EUR)
GLR-785	Gas boiling pan, LPG and natural gas operation, TÜV certified Heating: indirect Ignition: ionization Water filling: automatic Weight: 93 kg Size: 800x700x900 mm	80 liter	12.5 kW	-		5 600
GLR-105	Gas boiling pan, LPG and natural gas operation, TÜV certified Heating: indirect Ignition: ionization Water filling: automatic Weight: 128 kg Size: 900x900x900 mm	100 liter	14.5 kW	~1 N x 230 V, 50 Hz		6 400
GLR-155	Gas boiling pan, LPG and natural gas operation, TÜV certified Heating: indirect Ignition: ionization Water filling: automatic Weight: 139 kg Size: 900x900x900 mm	150 liter	19 kW	~1 N x 230 V, 50 Hz		6 600
GLF-205	Gas boiling pan, LPG and natural gas operation, TÜV certified Heating: indirect Ignition: ionization Water filling: automatic Weight: 209 kg Size: 1350x900x900 mm	200 liter	25 kW	~1 N x 230 V, 50 Hz		8 200
GLF-305	Gas boiling pan, LPG and natural gas operation, TÜV certified Heating: indirect Ignition: ionization Water filling: automatic Weight: 220 kg Size: 1350x900x900 mm	300 liter	32 kW	~1 N x 230 V, 50 Hz		8 400

Our boiling pans listed below can be ordered with a special, removable mixer:

**GLR-102; GLR-105;
GLR-152; GLR-155**





**ELR-101; ELR-105;
ELR-151; ELR-155**

NLR-101; NLR-151



BOILING PANS

ELECTRIC BOILING PANS, CLASSIC CONTROLS

Code	Description	Capacity	Power	Voltage	Product image	List price (EUR)
ELR-782	Electric boiling pan Heating: indirect Water filling: manual Weight: 82 kg Size: 800x700x900 mm	80 liter	12 kW	~3 N x 400 V, 50 Hz		4 800
ELR-101	Electric boiling pan Heating: indirect Water filling: automatic Weight: 117 kg Size: 900x900x900 mm	100 liter	18 kW	~3 N x 400 V, 50 Hz		5 400
ELR-151	Electric boiling pan Heating: indirect Water filling: automatic Weight: 127 kg Size: 900x900x900 mm	150 liter	24 kW	~3 N x 400 V, 50 Hz		5 600
ELF-201	Electric boiling pan Heating: indirect Water filling: automatic Weight: 182 kg Size: 1350x900x900 mm	200 liter	30 kW	~3 N x 400 V, 50 Hz		7 000
ELF-301	Electric boiling pan Heating: indirect Water filling: automatic Weight: 190 kg Size: 1350x900x900 mm	300 liter	36 kW	~3 N x 400 V, 50 Hz		7 200

Our boiling pans listed below can be ordered with a special, removable mixer:

**GLR-102; GLR-105;
GLR-152; GLR-155**

**ELR-101; ELR-105;
ELR-151; ELR-155**

NLR-101; NLR-151

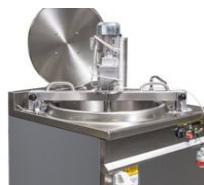





BOILING PANS

ELECTRIC BOILING PANS, TOUCHSCREEN CONTROLS

Safer and more user-friendly usage

- Touch control • Multilingual support • On-screen cooking information
- Timed cooking function • Stepless temperature control • Service options menu
- Warning alert when inspection is necessary • Operation logging • Diagnostic test
- On-screen error codes • Operating hours counter • HACCP stats • Optional e-mail sending

Code	Description	Capacity	Power	Voltage	Product image	List price (EUR)
ELR-785	Electric boiling pan Heating: indirect Water filling: automatic Weight: 82 kg Size: 800x700x900 mm	80 liter	12 kW	~3 N x 400 V, 50 Hz		5 200
ELR-105	Electric boiling pan Heating: indirect Water filling: automatic Weight: 117 kg Size: 900x900x900 mm	100 liter	18 kW	~3 N x 400 V, 50 Hz		5 800
ELR-155	Electric boiling pan Heating: indirect Water filling: automatic Weight: 127 kg Size: 900x900x900 mm	150 liter	24 kW	~3 N x 400 V, 50 Hz		6 000
ELF-205	Electric boiling pan Heating: indirect Water filling: automatic Weight: 182 kg Size: 1350x900x900 mm	200 liter	30 kW	~3 N x 400 V, 50 Hz		7 400
ELF-305	Electric boiling pan Heating: indirect Water filling: automatic Weight: 190 kg Size: 1350x900x900 mm	300 liter	36 kW	~3 N x 400 V, 50 Hz		7 600

Our boiling pans listed below can be ordered with a special, removable mixer:

**GLR-102; GLR-105;
GLR-152; GLR-155**





**ELR-101; ELR-105;
ELR-151; ELR-155**

NLR-101; NLR-151



BOILING PANS

STEAM BOILING PANS

Code	Description	Capacity	Steam cons.	Voltage	Product image	List price (EUR)
NLR-101	Steam boiling pan Heating: indirect Water filling: manual Weight: 110 kg Size: 900x900x900 mm	100 liter	max. 100 kg/h	-		5 200
NLR-151	Steam boiling pan Heating: indirect Water filling: manual Weight: 119 kg Size: 900x900x900 mm	150 liter	max. 100 kg/h	-		5 400
NLF-201	Steam boiling pan Heating: indirect Water filling: manual Weight: 172 kg Size: 1350x900x900 mm	200 liter	max. 100 kg/h	-		7 200
NLF-301	Steam boiling pan Heating: indirect Water filling: manual Weight: 183 kg Size: 1350x900x900 mm	300 liter	max. 100 kg/h	-		7 400

Our boiling pans listed below can be ordered with a special, removable mixer:









**GLR-102; GLR-105;
GLR-152; GLR-155**

**ELR-101; ELR-105;
ELR-151; ELR-155**

NLR-101; NLR-151







BOILING PAN ACCESSORIES

Code	Description	Capacity	Power	Voltage	Product image	List price (EUR)
GLR-151-11000	Flue gas pipe for GLR-102; GLR-105; GLR-152; GLR-155	-	-	-		264
GLF-201-11000	Flue gas pipe for GLF-202; GLF-205; GLF-302; GLF-305	-	-	-		312
SZU500-000A	Filter for boiling pans (prevent from clogging) ELR-782; ELR-785; GLR-782; GLR-785	-	-	-		88
SZU630-000B	Filter for boiling pans (prevent from clogging) GLR-102; GLR-105; ELR-101; ELR-105; NLR-101; GLR-152; GLR-155; ELR-151; ELR-155; NLR-151	-	-	-		88
SZU300-000B	Filter for boiling pans (prevent from clogging) GLF-202; GLF-205; GLF-302; GLF-305; ELF-201; ELF-205; ELF-301; ELF-305; NLF-201; NLF-301	-	-	-		88
GLR101-00003	Dipstick ELR-101; ELR-105; GLR-102; GLR-105; NLR-101	-	-	-		72
GLR151-00003	Dipstick ELR-151; ELR-155; GLR-152; GLR-155; NLR-151	-	-	-		80
GLF201-00003	Dipstick ELF-201; ELF-205; GLF-202; GLF-205; NLF-201	-	-	-		72
GLF301-00003	Dipstick ELF-301; ELF-305; GLF-302; GLF-305; NLF-301	-	-	-		80

ROUND BOILING PANS

GAS BOILING PANS, CLASSIC CONTROLS

Code	Description	Capacity	Power GAS/LPG	Voltage	Product image	List price (EUR)
RKG-200	Gas boiling pan, LPG and natural gas operation, TÜV certified Heating: indirect Ignition: piezo Water filling: manual Weight: 171 kg Size: 1070x1140x900 mm	200 liter	31.5 kW / 30 kW	~1 N x 230 V, 50 Hz		9 200
RKG-301	Gas boiling pan, LPG and natural gas operation, TÜV certified Heating: indirect Ignition: ionization Water filling: automatic Weight: 230 kg Size: 1320x1330x940 mm	300 liter	48 kW / 48 kW	~1 N x 230 V, 50 Hz		10 800
RKG-401	Gas boiling pan, LPG and natural gas operation, TÜV certified Heating: indirect Ignition: ionization Water filling: automatic Weight: 240 kg Size: 1320x1330x1070 mm	400 liter	48 kW / 48 kW	~1 N x 230 V, 50 Hz		11 200
RKG-501	Gas boiling pan, LPG and natural gas operation, TÜV certified Heating: indirect Ignition: ionization Water filling: automatic Weight: 250 kg Size: 1320x1330x1180 mm	500 liter	48 kW / 48 kW	~1 N x 230 V, 50 Hz		11 600

Our boiling pans listed below can be ordered with a special, built-in mixer:

**RKG-200; RKG-301; RKG-305;
RKG-401; RKG-405; RKG-501;
RKG-505**

RKE-305 - RKE 405 - RKE 505

**RKD-200 - RKD-301 - RKD-401
RKD-501**





ROUND BOILING PANS

GAS BOILING PANS, TOUCHSCREEN CONTROLS

Safer and more user-friendly usage

- Touch control • Multilingual support • On-screen cooking information
- Timed cooking function • Stepless temperature control • Service options menu
- Warning alert when inspection is necessary • Operation logging • Diagnostic test
- On-screen error codes • Operating hours counter • HACCP stats • Optional e-mail sending

Code	Description	Capacity	Power GAS/LPG	Voltage	Product image	List price (EUR)
RKG-305	Gas boiling pan, LPG and natural gas operation, TÜV certified Heating: indirect Ignition: ionization Water filling: automatic Weight: 230 kg Size: 1320x1330x940 mm	300 liter	48 kW / 48 kW	~1 N x 230 V, 50 Hz		11 200
RKG-405	Gas boiling pan, LPG and natural gas operation, TÜV certified Heating: indirect Ignition: ionization Water filling: automatic Weight: 240 kg Size: 1320x1330x1070 mm	400 liter	48 kW / 48 kW	~1 N x 230 V, 50 Hz		11 600
RKG-505	Gas boiling pan, LPG and natural gas operation, TÜV certified Heating: indirect Ignition: ionization Water filling: automatic Weight: 250 kg Size: 1320x1330x1180 mm	500 liter	48 kW / 48 kW	~1 N x 230 V, 50 Hz		12 000

Our boiling pans listed below can be ordered with a special, built-in mixer:

**RKG-200; RKG-301; RKG-305;
RKG-401; RKG-405; RKG-501;
RKG-505**

RKE-305 - RKE 405 - RKE 505

**RKD-200 - RKD-301 - RKD-401
RKD-501**





ROUND BOILING PANS

ELECTRIC BOILING PANS, TOUCHSCREEN CONTROLS

Safer and more user-friendly usage

- Touch control • Multilingual support • On-screen cooking information
- Timed cooking function • Stepless temperature control • Service options menu
- Warning alert when inspection is necessary • Operation logging • Diagnostic test
- On-screen error codes • Operating hours counter • HACCP stats • Optional e-mail sending

Code	Description	Capacity	Power	Voltage	Product image	List price (EUR)
RKE-305	Electric boiling pan, Heating: indirect Water filling: automatic Weight: 230 kg Size: 1320x1330x940 mm	300 liter	36 kW	~3 N x 400 V, 50 Hz		11 000
RKE-405	Electric boiling pan, Heating: indirect Water filling: automatic Weight: 240 kg Size: 1320x1330x1070 mm	400 liter	42 kW	~3 N x 400 V, 50 Hz		11 400
RKE-505	Electric boiling pan, Heating: indirect Water filling: automatic Weight: 250 kg Size: 1320x1330x1180 mm	500 liter	48 kW	~3 N x 400 V, 50 Hz		11 800

Our boiling pans listed below can be ordered with a special, built-in mixer:

**RKG-200; RKG-205;
RKG-301; RKG-305;
RKG-401; RKG-405;
RKG-501; RKG-505**



RKE-305; RKE 405; RKE 505

**RKD-200; RKD-301; RKD-401;
RKD-501**



BOILING PANS

STEAM BOILING PANS

Code	Description	Capacity	Steam cons.	Voltage	Product image	List price (EUR)
RKD-200	Steam boiling pan Heating: indirect Water filling: manual Weight: 160 kg Size: 990x1020x890 mm	200 liter	max. 70 kg/h	-		8 800
RKD-301	Steam boiling pan Heating: indirect Water filling: manual Weight: 210 kg Size: 1290x1240x940 mm	300 liter	max. 170 kg/h	-		10 000
RKD-401	Steam boiling pan Heating: indirect Water filling: manual Weight: 220 kg Size: 1290x1240x1070 mm	400 liter	max. 170 kg/h	-		10 400
RKD-501	Steam boiling pan Heating: indirect Water filling: manual Weight: 230 kg Size: 1290x1240x1180 mm	500 liter	max. 170 kg/h	-		10 800

Our boiling pans listed below can be ordered with a special, built-in mixer:









**RKG-200; RKG-205;
RKG-301; RKG-305;
RKG-401; RKG-405;
RKG-501; RKG-505**

RKE-305; RKE 405; RKE 505

**RKD-200; RKD-301; RKD-401;
RKD-501**



BOILING PAN ACCESSORIES

RKG-01-00	Flue gas pipe for RKG-200	-	-	-		312
RKG-501-01-00	Flue gas pipe for RKG-301; RKG-305; RKG-401; RKG-405; RKG-501; RKG-505	-	-	-		320
SZU1000-000B	Filter for boiling pans (prevent from clogging) RKG-301; RKG-305; RKE-305; RKG-401; RKE-405; RKG-405; RKG-501; RKG-505; RKE-505; RKD-301; RKD-401	-	-	-		88
SZU800-000B	Filter for boiling pans (prevent from clogging) RKG-200; RKD-200; RKG-280	-	-	-		88
RKG200-00003	Dipstick RKG-200, RKD-200	-	-	-		72
RKG301-00003	Dipstick RKG-301; RKG-305; RKE-305; RKD-301	-	-	-		80
RKG400-00003	Dipstick RKG-401; RKG-405; RKE-405; RKD-401	-	-	-		92
RKG501-00003	Dipstick RKG-501; RKG-505; RKE-505; RKD-501	-	-	-		100







TILTING BRATT PANS

Products can be fitted into lines of 700 and 900 as well. Tilting bratt pans can be ordered with carbon steel or stainless inox bottom. They are available in 3 different sizes and capacity (50 L, 80 L, 120 L). The lid can be opened with a lever guided to the side to avoid damage caused by condensing steam.









TILTING BRATT PANS

GAS BRATT PAN - MANUAL TILTING

Code	Description	Capacity	Power	Voltage	Product image	List price (EUR)
GBS55.78	Gas bratt pan - manual tilting, LPG and natural gas operation, TÜV certified Ignition: electronic Bottom: carbon steel Weight: 122 kg Size: 800x700x900 mm	50 liter	12 kW	~1 N x 230 V, 50 Hz		5 300
GBS55.78 Inox	Gas bratt pan - manual tilting, LPG and natural gas operation, TÜV certified Ignition: electronic Bottom: inox Weight: 122 kg Size: 800x700x900 mm	50 liter	12 kW	~1 N x 230 V, 50 Hz		5 300
GBS85.98	Gas bratt pan - manual tilting, LPG and natural gas operation, TÜV certified Ignition: electronic Bottom: carbon steel Weight: 140 kg Size: 800x900x900 mm	80 liter	16 kW	~1 N x 230 V, 50 Hz		5 700
GBS85.98 Inox	Gas bratt pan - manual tilting, LPG and natural gas operation, TÜV certified Ignition: electronic Bottom: inox Weight: 140 kg Size: 800x900x900 mm	80 liter	16 kW	~1 N x 230 V, 50 Hz		5 700
GBS125.912	Gas bratt pan - manual tilting, LPG and natural gas operation, TÜV certified Ignition: electronic Bottom: carbon steel Weight: 179 kg Size: 1200x900x900 mm	120 liter	27 kW	~1 N x 230 V, 50 Hz		6 500
GBS125.912 Inox	Gas bratt pan - manual tilting, LPG and natural gas operation, TÜV certified Ignition: electronic Bottom: inox Weight: 179 kg Size: 1200x900x900 mm	120 liter	27 kW	~1 N x 230 V, 50 Hz		6 500

TILTING BRATT PANS

ELECTRIC BRATT PAN - MANUAL TILTING

Code	Description	Capacity	Power	Voltage	Product image	List price (EUR)
EBS55.78	Electric bratt pan - manual tilting Bottom: carbon steel Weight: 122 kg Size: 800x700x900 mm	50 liter	7.76 kW	~3 N x 400 V, 50 Hz		4 900
EBS55.78 Inox	Electric bratt pan - manual tilting Bottom: inox Weight: 122 kg Size: 800x700x900 mm	50 liter	7.76 kW	~3 N x 400 V, 50 Hz		4 900
EBS85.98	Electric bratt pan - manual tilting Bottom: carbon steel Weight: 145 kg Size: 800x900x900 mm	80 liter	12 kW	~3 N x 400 V, 50 Hz		5 300
EBS85.98 Inox	Electric bratt pan - manual tilting Bottom: inox Weight: 145 kg Size: 800x900x900 mm	80 liter	12 kW	~3 N x 400 V, 50 Hz		5 300
EBS125.912	Electric bratt pan - manual tilting Bottom: carbon steel Weight: 191 kg Size: 1200x900x900 mm	120 liter	18 kW	~3 N x 400 V, 50 Hz		6 100
EBS125.912 Inox	Electric bratt pan - manual tilting Bottom: inox Weight: 191 kg Size: 1200x900x900 mm	120 liter	18 kW	~3 N x 400 V, 50 Hz		6 100

STOCK POT STOVES

Gas Stock Pot Stoves

By using modern burner, it can also be used outdoors, unlike cast iron structures. The massive and stainless construction makes the appliance suitable for using large capacity and heavy dishes.





Electric Stock Pot Stoves

6 level of temperature controller and built in overheat protection.





STOCK POT STOVES

GAS STOCK POT STOVES

Code	Description	Load	Power	Voltage	Product image	List price (EUR)
GZST10	Gas stock pot stove, LPG and natural gas operation, TÜV certified Ignition: piezo Gas consumption: 0,993 m ³ / h LPG consumption: 0,333 m ³ / h Weight: 27 kg Size:520x520x460 mm	max. 100 kg	10 kW	-		680
ZSL10	Stand for GZST10 Weight: 3 kg Size: 500x500x400 mm	-	-	-		180
GZST14	Gas stock pot stove, LPG and natural gas operation, TÜV certified Ignition: piezo Gas consumption: 1,628 m ³ / h LPG consumption: 0,406 m ³ / h Weight: 37 kg Size: 600x600x460 mm	max. 100 kg	14 kW	-		850
ZSL14	Stand for GZST14 Weight: 3,5 kg Size: 600x600x400 mm	-	-	-		200

ELECTRIC STOCK POT STOVE

Code	Description	Load	Power	Voltage	Product image	List price (EUR)
EZS7	Electric stock pot stove Plate size: 400x400 mm Weight: 35 kg Size: 600x600x400 mm	max. 100 kg	7 kW	~3 N x 400 V, 50 Hz		1 000
ZSL14	Stand for EZS7 Weight: 3,5 kg Size: 600x600x400 mm	-	-	-		200

PREPARATION MACHINES

Potato Peelers

Nearly 50 years of manufacturing experience of potato peelers. Fast and efficient abrasion is ensured by the combined use of the bottom and side plate abrasive surfaces.







Universal Kitchen Machines

By simply installing additional tools on the basic machine, you can grind meat, tenderize, cut vegetables, dice, grate or mash, knead dough, whisk, grind spices or poppy seeds, or even sharpen knives. With the help of the mobile rack, the machine can be practically installed in the kitchen, according to the necessary operation.









PREPARATION MACHINES

POTATO PEELERS

Code	Description	Capacity	Power, electric connection	Product image	List price (EUR)
KG-510	Potato peeler Duct connection: 50 mm Weight: 30 kg Size: 740x385x465 mm	~4-5 kg / load ~70-100 kg / h	0.37 kW ~1 N x 230 V, 50 Hz		1 960
KG-510 Stand	Potato peeler stand Weight: 5 kg Size: 410x560x665 mm	-	-		290
KG-503	Potato peeler Duct connection: 70 mm Weight: 48,5 kg Size: 622x529x867 mm	~10-12 kg / load ~200-300 kg / h	0.75 kW ~3 N x 400 V, 50 Hz		2 400
KG-501	Potato peeler Duct connection: 70 mm Weight: 58 kg Size: 734x634x913 mm	~18-20 kg / load ~400-500 kg / h	0.75 kW ~3 N x 400 V, 50 Hz		2 700

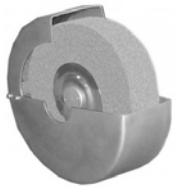

PREPARATION MACHINES

UNIVERSAL KITCHEN MACHINE

Code	Description	Capacity	Power, electric connection	Product image	List price (EUR)
MA-753	Universal kitchen machine base with 3-speed (gear) Weight: 27 kg Size: 577x205x260 mm	Depends on the attachment	1.3 kW ~3 N x 400 V, 50 Hz		1 940
KF-605	Stainless steel meat grinder attachment Weight: 6 kg Size: 380x284x318 mm	~150-240 kg / h	-		1 290
F-10	Spice grinding attachment Weight: 5 kg Size: 220x180x380 mm	~10 kg / h	-		530
M-20	Poppy-seed grinding attachment Weight: 5 kg Size: 220x180x380 mm	~20 kg / h	-		530
KÉ-1	Knife sharpener attachment Weight: 5 kg Size: 180x240x245 mm	-	-		340
PSZK-150	Stainless mashing-, slicing-, dicing attachment stainless steel discs, 5 different discs and 2 rollers - adjustable slicer disc 0.5 mm - 7 mm - julienne disc 10 mm - julienne (for pumpkin) disc 4 mm - disc for cubes 15x15 mm - grating disc - grating roller - mashing roller Weight: 27 kg Size: 375x394x480 mm	~150-240 kg / h	-		2 160

PREPARATION MACHINES

UNIVERSAL KITCHEN MACHINE

Code	Description	Capacity	Power, Voltage	Product image	List price (EUR)
RC 21	Stainless steel tenderizer attachment Weight: 9 kg Size: 400x260x140 mm	-	-		1 060
HD-16	Stainless steel mixer attachment knead, whip and whisk Capacity: 16 liter Weight: 25 kg Size: 370x360x560 mm	-	-		2 240
HGA-150	Stainless steel stand 2 fixed wheels and grid for dishes Max load during moving: 100 kg Max load of the grid: 50 kg Weight: 5 kg Size: 450x650x665 mm	-	-		480

ELECTRIC STATIC OVENS

Products are entirely made of stainless steel. Size of tray capacity is GN 2/1. They have doubled, panoramic security door glasses that can be cleaned in a dishwasher. The direction of the door opening can be changed arbitrarily (left or right). Inside oven lighting. The temperature range can be controlled continuously from 50 °C to 270 °C, and optional separate lower or upper heating at 320 °C.

Different size of stands can be ordered for ovens, it is optional to choose a tray-keeper splinting.

GES-001 can be built on the top of each other, maximum quantity of 4.



GES-001





GES-002



GES-003



STATIC OVENS

ELECTRIC STATIC OVENS

Code	Description	Capacity	Power, electric connection	Product image	List price (EUR)
GES-001	Electric static oven can be stacked for 2-3-4 chamber configurations Weight: 52 kg Size: 800x900x400 mm	1xGN 2/1	3.45 kW ~1 N x 230 V, 50 Hz		1 500
GES-002	Electric static oven tower 2 chamber built-in Weight: 106 kg Size: 800x900x1050 mm	2xGN 2/1	6.9 kW ~3 N x 400 V, 50 Hz		2 600
GES-003	Electric static oven tower 3 chamber built-in Weight: 160 kg Size: 800x900x1600 mm	3xGN 2/1	10.35 kW ~3 N x 400 V, 50 Hz		3 500





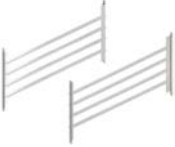

STATIC OVEN ACCESSORY

OVEN SUPPORT

Code	Description	Capacity	Power, Voltage	Product image	List price (EUR)
GES-7000	Oven support pan holder kit optional Compatible: GES-001 Weight: 10,5 kg Size: 800x800x900 mm	-	-		320
GES-7000T	Pan holder kit Compatible: GES-7000 Weight: 4 kg Rails: 7	-	-		140
GES-10000	Oven support pan holder kit optional Compatible: GES-001 Weight: 9 kg Size: 800x800x650 mm	-	-		280
GES-10000T	Pan holder kit Compatible: GES-10000 Weight: 2,5 kg Rails: 4	-	-		120





STOVES

GAS STOVES, SERIES 900

Code	Description	Power	Voltage	Product image	List price (EUR)
GT2.94F	Gas stove top 2 burners: 1x5.3 kW 1x8.3 kW Weight: 31 kg Size: 400x900x280 mm	13.6 kW	-		1 500
GT2.94SE	Gas stove 2 burners: 1x5.3 kW 1x8.3 kW opened cabinet Weight: 40 kg Size: 400x900x900 mm	13.6 kW	-		1 760
GT2.94S	Gas stove 2 burners: 1x5.3 kW 1x8.3 kW 3 sides closed cabinet Weight: 47 kg Size: 400x900x900 mm	13.6 kW	-		1 840
GT4.98F	Gas stove top 4 burners: 2x5.3 kW 2x8.3 kW Weight: 56 kg Size: 800x900x280 mm	27.2 kW	-		2 460
GT4.98SE	Gas stove 4 burners: 2x5.3 kW 2x8.3 kW opened cabinet Weight: 68 kg Size: 800x900x900 mm	27.2 kW	-		2 800
GT4.98S	Gas stove 4 burners: 2x5.3 kW 2x8.3 kW 3 sides closed cabinet Weight: 78 kg Size: 800x900x900 mm	27.2 kW	-		2 900

STOVES

GAS STOVES, SERIES 900

Code	Description	Power	Voltage	Product image	List price (EUR)
GT4.98GES	Gas stove 4 burners: 2x5.3 kW 2x8.3 kW GN 2/1 electric static oven built-in Oven power: 3.45 kW Weight: 118 kg Size: 800x900x900 mm	27.2 kW	~1 N x 230 V, 50 Hz		3 900
GT6.912F	Gas stove top 6 burners: 3x5.3 kW 3x8.3 kW Weight: 81 kg Size: 1200x900x280 mm	40.8 kW	-		3 450
GT6.912SE	Gas stove 6 burners: 3x5.3 kW 3x8.3 kW opened cabinet Weight: 97 kg Size: 1200x900x900 mm	40.8 kW	-		3 850
GT6.912S	Gas stove 6 burners: 3x5.3 kW 3x8.3 kW 3 sides closed cabinet Weight: 110 kg Size: 1200x900x900 mm	40.8 kW	-		3 960
GT6.912GES	Gas stove 6 burners: 3x5.3 kW 3x8.3 kW GN 2/1 electric static oven built-in, 3 sides closed cabinet Oven power: 3.45 kW Weight: 154 kg Size: 1200x900x900 mm	40.8 kW	~1 N x 230 V, 50 Hz		5 050

GAS STOVE ACCESSORY

Code	Description	Power	Voltage	Product image	List price (EUR)
ZT900	Closed top grate for gas burners Weight: 9 kg Size: 360x360x42 mm	-	-		170

NEUTRAL UNITS

SERIES 900

Code	Description	Power	Voltage	Product image	List price (EUR)
SF94	Neutral top unit Size: 400x900x240 mm	-	-		340
SF98	Neutral top unit Size: 800x900x240 mm	-	-		580
SE904	Neutral unit, opened Size: 400x900x600 mm	-	-		384
S904	Neutral unit, 3 sides closed Size: 400x900x600 mm	-	-		500
SE908	Neutral unit, opened Size: 800x900x600 mm	-	-		440
S908	Neutral unit, 3 sides closed Size: 800x900x600 mm	-	-		640
SE912	Neutral unit, opened Size: 1200x900x600 mm	-	-		520
S912	Neutral unit, 3 sides closed Size: 1200x900x600 mm	-	-		860

STAINLESS STEEL FURNITURE

Sturdy, stiffened furnitures with high load capacity.
Custom sized furnitures are available on customer demand.

WORKTABLES

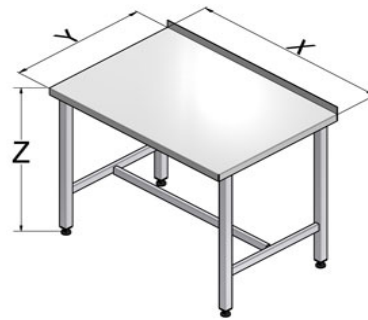
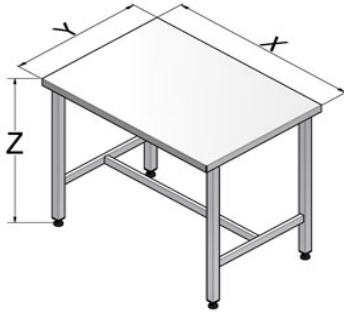

Stainless steel worktable with adjustable legs

Stainless steel worktable with upstand and adjustable legs

600

600

Code	Size X x Y x Z	List price (EUR)	Code	Size X x Y x Z	List price (EUR)
GA 10-086-00	800x600x850 mm	400	GA 10-086-01	800x600x850 mm	408
GA 10-106-00	1000x600x850 mm	420	GA 10-106-01	1000x600x850 mm	429
GA 10-126-00	1200x600x850 mm	440	GA 10-126-01	1200x600x850 mm	451
GA 10-146-00	1400x600x850 mm	470	GA 10-146-01	1400x600x850 mm	480
GA 10-156-00	1500x600x850 mm	480	GA 10-156-01	1500x600x850 mm	488
GA 10-166-00	1600x600x850 mm	490	GA 10-166-01	1600x600x850 mm	505
GA 10-186-00	1800x600x850 mm	510	GA 10-186-01	1800x600x850 mm	522
GA 10-206-00	2000x600x850 mm	540	GA 10-206-01	2000x600x850 mm	556

700

700

Code	Size X x Y x Z	List price (EUR)	Code	Size X x Y x Z	List price (EUR)
GA 10-087-00	800x700x850 mm	404	GA 10-087-01	800x700x850 mm	421
GA 10-107-00	1000x700x850 mm	429	GA 10-107-01	1000x700x850 mm	446
GA 10-127-00	1200x700x850 mm	451	GA 10-127-01	1200x700x850 mm	467
GA 10-147-00	1400x700x850 mm	476	GA 10-147-01	1400x700x850 mm	493
GA 10-157-00	1500x700x850 mm	488	GA 10-157-01	1500x700x850 mm	505
GA 10-167-00	1600x700x850 mm	501	GA 10-167-01	1600x700x850 mm	518
GA 10-187-00	1800x700x850 mm	522	GA 10-187-01	1800x700x850 mm	539
GA 10-207-00	2000x700x850 mm	556	GA 10-207-01	2000x700x850 mm	573

STAINLESS STEEL FURNITURE

WORKTABLES

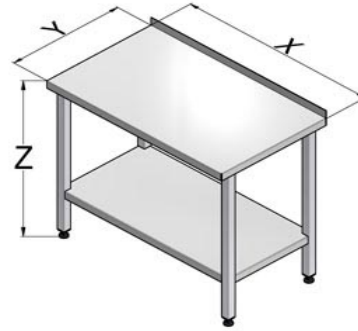
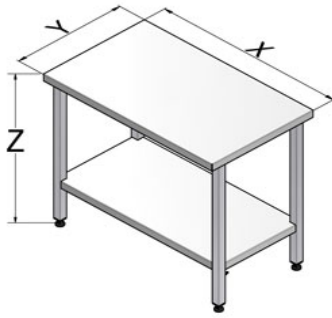

Stainless steel worktable with bottom shelf and adjustable legs

Stainless steel worktable with bottom shelf, upstand and adjustable legs

600

600

Code	Size X x Y x Z	List price (EUR)	Code	Size X x Y x Z	List price (EUR)
GA 20-086-00	800x600x850 mm	460	GA 20-086-01	800x600x850 mm	480
GA 20-106-00	1000x600x850 mm	490	GA 20-106-01	1000x600x850 mm	510
GA 20-126-00	1200x600x850 mm	510	GA 20-126-01	1200x600x850 mm	530
GA 20-146-00	1400x600x850 mm	540	GA 20-146-01	1400x600x850 mm	560
GA 20-156-00	1500x600x850 mm	570	GA 20-156-01	1500x600x850 mm	590
GA 20-166-00	1600x600x850 mm	590	GA 20-166-01	1600x600x850 mm	610
GA 20-186-00	1800x600x850 mm	630	GA 20-186-01	1800x600x850 mm	640
GA 20-206-00	2000x600x850 mm	660	GA 20-206-01	2000x600x850 mm	670
700			700		
Code	Size X x Y x Z	List price (EUR)	Code	Size X x Y x Z	List price (EUR)
GA 20-087-00	800x700x850 mm	490	GA 20-087-01	800x700x850 mm	510
GA 20-107-00	1000x700x850 mm	510	GA 20-107-01	1000x700x850 mm	530
GA 20-127-00	1200x700x850 mm	540	GA 20-127-01	1200x700x850 mm	560
GA 20-147-00	1400x700x850 mm	570	GA 20-147-01	1400x700x850 mm	590
GA 20-157-00	1500x700x850 mm	600	GA 20-157-01	1500x700x850 mm	620
GA 20-167-00	1600x700x850 mm	620	GA 20-167-01	1600x700x850 mm	640
GA 20-187-00	1800x700x850 mm	650	GA 20-187-01	1800x700x850 mm	670
GA 20-207-00	2000x700x850 mm	680	GA 20-207-01	2000x700x850 mm	700

STAINLESS STEEL FURNITURE

WORKTABLES

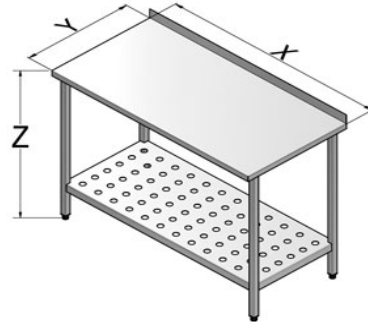
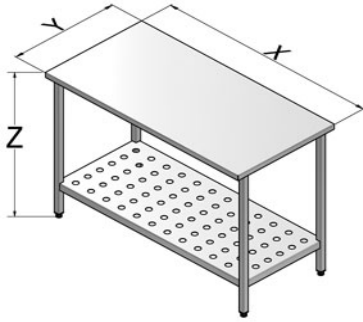

Stainless steel worktable with perforated bottom shelf and adjustable legs

Stainless steel worktable with perforated bottom shelf, upstand and adjustable legs

600

600

Code	Size X x Y x Z	List price (EUR)	Code	Size X x Y x Z	List price (EUR)
GAR-086-00	800x600x850 mm	490	GAR-086-01	800x600x850 mm	520
GAR-106-00	1000x600x850 mm	540	GAR-106-01	1000x600x850 mm	560
GAR-126-00	1200x600x850 mm	570	GAR-126-01	1200x600x850 mm	590
GAR-146-00	1400x600x850 mm	600	GAR-146-01	1400x600x850 mm	620
GAR-156-00	1500x600x850 mm	620	GAR-156-01	1500x600x850 mm	640
GAR-166-00	1600x600x850 mm	640	GAR-166-01	1600x600x850 mm	660
GAR-186-00	1800x600x850 mm	680	GAR-186-01	1800x600x850 mm	700
GAR-206-00	2000x600x850 mm	720	GAR-206-01	2000x600x850 mm	740

700

700

Code	Size X x Y x Z	List price (EUR)	Code	Size X x Y x Z	List price (EUR)
GAR-087-00	800x700x850 mm	540	GAR-087-01	800x700x850 mm	550
GAR-107-00	1000x700x850 mm	560	GAR-107-01	1000x700x850 mm	580
GAR-127-00	1200x700x850 mm	590	GAR-127-01	1200x700x850 mm	610
GAR-147-00	1400x700x850 mm	620	GAR-147-01	1400x700x850 mm	640
GAR-157-00	1500x700x850 mm	640	GAR-157-01	1500x700x850 mm	660
GAR-167-00	1600x700x850 mm	670	GAR-167-01	1600x700x850 mm	690
GAR-187-00	1800x700x850 mm	700	GAR-187-01	1800x700x850 mm	720
GAR-207-00	2000x700x850 mm	750	GAR-207-01	2000x700x850 mm	760

STAINLESS STEEL FURNITURE

MEAT CUTTING TABLES / DRAWER

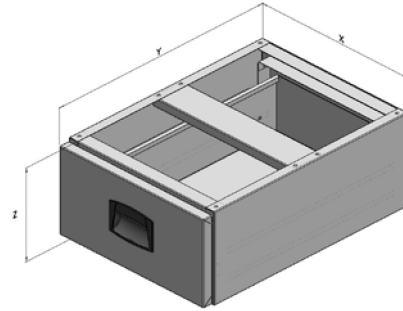

Stainless steel meat cutting table with upstand and adjustable legs, 400x300x20 mm polyethylen cutting board

Stainless steel drawer for tables

600

GN 1/1

Code	Size X x Y x Z	List price (EUR)	Code	Size	List price (EUR)
GAH-106-01	1000x600x850 mm	610	AF-00-150	GN 1/1	300
GAH-126-01	1200x600x850 mm	640			
GAH-146-01	1400x600x850 mm	680			
GAH-166-01	1600x600x850 mm	720			
GAH-186-01	1800x600x850 mm	770			
GAH-206-01	2000x600x850 mm	820			
700					
Code	Size X x Y x Z	List price (EUR)			
GAH-107-01	1000x700x850 mm	630			
GAH-127-01	1200x700x850 mm	670			
GAH-147-01	1400x700x850 mm	710			
GAH-167-01	1600x700x850 mm	750			
GAH-187-01	1800x700x850 mm	800			
GAH-207-01	2000x700x850 mm	840			

STAINLESS STEEL FURNITURE

CUPBOARDS

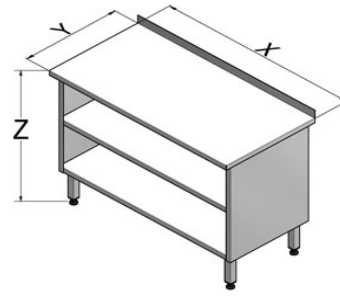
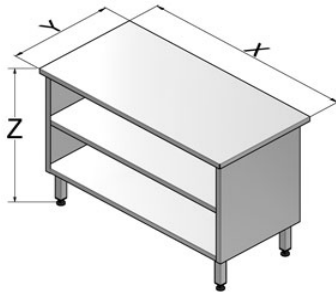

3 sides closed stainless steel open cupboard with interior shelf and adjustable legs

3 sides closed stainless steel open cupboard with interior shelf, adjustable legs and upstand

600

600

Code	Size X x Y x Z	List price (EUR)	Code	Size X x Y x Z	List price (EUR)
GASZ-06-081	800x600x850 mm	820	GASZ-06-081-01	800x600x850 mm	830
GASZ-06-101	1000x600x850 mm	840	GASZ-06-101-01	1000x600x850 mm	860
GASZ-06-121	1200x600x850 mm	910	GASZ-06-121-01	1200x600x850 mm	930
GASZ-06-141	1400x600x850 mm	970	GASZ-06-141-01	1400x600x850 mm	990
GASZ-06-161	1600x600x850 mm	1 040	GASZ-06-161-01	1600x600x850 mm	1 060
GASZ-06-181	1800x600x850 mm	1 100	GASZ-06-181-01	1800x600x850 mm	1 120
GASZ-06-201	2000x600x850 mm	1 180	GASZ-06-201-01	2000x600x850 mm	1 190

700

700

Code	Size X x Y x Z	List price (EUR)	Code	Size X x Y x Z	List price (EUR)
GASZ-07-081	800x700x850 mm	870	GASZ-07-081-01	800x700x850 mm	890
GASZ-07-101	1000x700x850 mm	900	GASZ-07-101-01	1000x700x850 mm	910
GASZ-07-121	1200x700x850 mm	960	GASZ-07-121-01	1200x700x850 mm	980
GASZ-07-141	1400x700x850 mm	1 020	GASZ-07-141-01	1400x700x850 mm	1 040
GASZ-07-161	1600x700x850 mm	1 100	GASZ-07-161-01	1600x700x850 mm	1 120
GASZ-07-181	1800x700x850 mm	1 150	GASZ-07-181-01	1800x700x850 mm	1 170
GASZ-07-201	2000x700x850 mm	1 230	GASZ-07-201-01	2000x700x850 mm	1 240

900

900

Code	Size X x Y x Z	List price (EUR)	Code	Size X x Y x Z	List price (EUR)
GASZ-09-081	800x900x850 mm	970	GASZ-09-081-01	800x900x850 mm	990
GASZ-09-101	1000x900x850 mm	1 000	GASZ-09-101-01	1000x900x850 mm	1 020
GASZ-09-121	1200x900x850 mm	1 070	GASZ-09-121-01	1200x900x850 mm	1 080
GASZ-09-141	1400x900x850 mm	1 120	GASZ-09-141-01	1400x900x850 mm	1 140
GASZ-09-161	1600x900x850 mm	1 200	GASZ-09-161-01	1600x900x850 mm	1 220
GASZ-09-181	1800x900x850 mm	1 260	GASZ-09-181-01	1800x900x850 mm	1 270
GASZ-09-201	2000x900x850 mm	1 330	GASZ-09-201-01	2000x900x850 mm	1 340

STAINLESS STEEL FURNITURE

CUPBOARDS

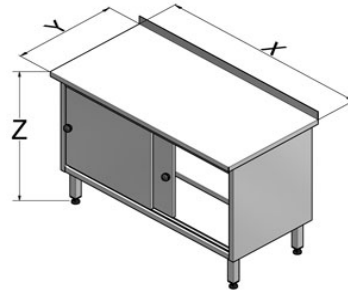
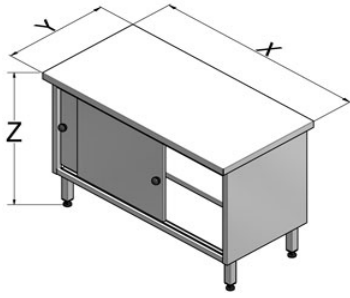

3 sides closed stainless steel cupboard with 2 sliding doors, interior shelf and adjustable legs

3 sides closed stainless steel cupboard with 2 sliding doors, interior shelf, adjustable legs and upstand

600

600

Code	Size X x Y x Z	List price (EUR)	Code	Size X x Y x Z	List price (EUR)
GASZ-06-082	800x600x850 mm	1 180	GASZ-06-082-01	800x600x850 mm	1 200
GASZ-06-102	1000x600x850 mm	1 260	GASZ-06-102-01	1000x600x850 mm	1 270
GASZ-06-122	1200x600x850 mm	1 330	GASZ-06-122-01	1200x600x850 mm	1 350
GASZ-06-142	1400x600x850 mm	1 410	GASZ-06-142-01	1400x600x850 mm	1 420
GASZ-06-162	1600x600x850 mm	1 480	GASZ-06-162-01	1600x600x850 mm	1 500
GASZ-06-182	1800x600x850 mm	1 550	GASZ-06-182-01	1800x600x850 mm	1 570
GASZ-06-202	2000x600x850 mm	1 630	GASZ-06-202-01	2000x600x850 mm	1 650

700

700

Code	Size X x Y x Z	List price (EUR)	Code	Size X x Y x Z	List price (EUR)
GASZ-07-082	800x700x850 mm	1 230	GASZ-07-082-01	800x700x850 mm	1 240
GASZ-07-102	1000x700x850 mm	1 310	GASZ-07-102-01	1000x700x850 mm	1 320
GASZ-07-122	1200x700x850 mm	1 380	GASZ-07-122-01	1200x700x850 mm	1 400
GASZ-07-142	1400x700x850 mm	1 460	GASZ-07-142-01	1400x700x850 mm	1 470
GASZ-07-162	1600x700x850 mm	1 530	GASZ-07-162-01	1600x700x850 mm	1 550
GASZ-07-182	1800x700x850 mm	1 610	GASZ-07-182-01	1800x700x850 mm	1 630
GASZ-07-202	2000x700x850 mm	1 680	GASZ-07-202-01	2000x700x850 mm	1 700

900

900

Code	Size X x Y x Z	List price (EUR)	Code	Size X x Y x Z	List price (EUR)
GASZ-09-082	800x900x850 mm	1 330	GASZ-09-082-01	800x900x850 mm	1 340
GASZ-09-102	1000x900x850 mm	1 410	GASZ-09-102-01	1000x900x850 mm	1 420
GASZ-09-122	1200x900x850 mm	1 480	GASZ-09-122-01	1200x900x850 mm	1 500
GASZ-09-142	1400x900x850 mm	1 560	GASZ-09-142-01	1400x900x850 mm	1 580
GASZ-09-162	1600x900x850 mm	1 630	GASZ-09-162-01	1600x900x850 mm	1 650
GASZ-09-182	1800x900x850 mm	1 710	GASZ-09-182-01	1800x900x850 mm	1 720
GASZ-09-202	2000x900x850 mm	1 790	GASZ-09-202-01	2000x900x850 mm	1 800

STAINLESS STEEL FURNITURE

WALL SHELVES

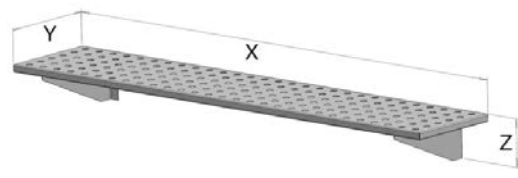
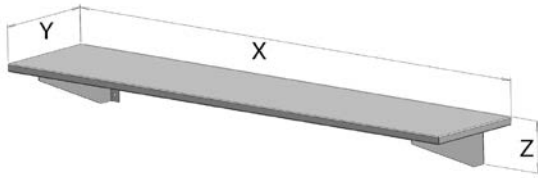

Stainless steel shelf, applicable to wall with 2 brackets
(3 brackets included after 1600 mm length)

Stainless steel perforated shelf, applicable to wall with 2
brackets
(3 brackets included after 1600 mm length)

300

300

Code	Size X x Y x Z	List price (EUR)	Code	Size X x Y x Z	List price (EUR)
FP 060-00-030	600x300x160 mm	140	FP 060-01-030	600x300x160 mm	160
FP 080-00-030	800x300x160 mm	150	FP 080-01-030	800x300x160 mm	180
FP 100-00-030	1000x300x160 mm	160	FP 100-01-030	1000x300x160 mm	190
FP 120-00-030	1200x300x160 mm	170	FP 120-01-030	1200x300x160 mm	190
FP 140-00-030	1400x300x160 mm	190	FP 140-01-030	1400x300x160 mm	210
FP 160-00-030	1600x300x160 mm	200	FP 160-01-030	1600x300x160 mm	230
FP 180-00-030	1800x300x160 mm	210	FP 180-01-030	1800x300x160 mm	240
FP 200-00-030	2000x300x160 mm	220	FP 200-01-030	2000x300x160 mm	250

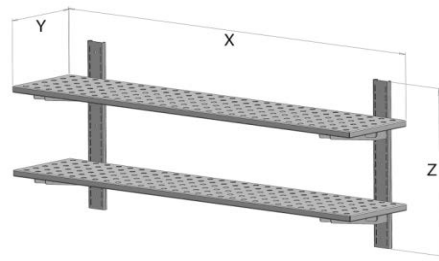
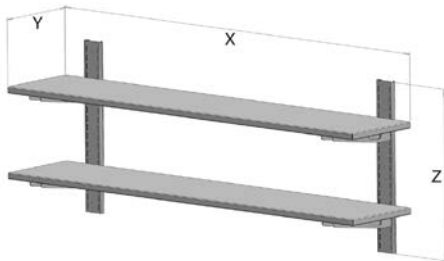

Stainless steel double shelf, applicable to wall with 2 rails +
brackets
(3 rails + brackets included after 1600 mm length)

Stainless steel perforated double shelf, applicable to wall
with 2 rails + brackets
(3 rails + brackets included after 1600 mm length)

318

318

Code	Size X x Y x Z	List price (EUR)	Code	Size X x Y x Z	List price (EUR)
FP2 060-00-030	600x318x650 mm	190	FP2 060-01-030	600x318x650 mm	230
FP2 080-00-030	800x318x650 mm	200	FP2 080-01-030	800x318x650 mm	236
FP2 100-00-030	1000x318x650 mm	210	FP2 100-01-030	1000x318x650 mm	240
FP2 120-00-030	1200x318x650 mm	220	FP2 120-01-030	1200x318x650 mm	250
FP2 140-00-030	1400x318x650 mm	230	FP2 140-01-030	1400x318x650 mm	270
FP2 160-00-030	1600x318x650 mm	270	FP2 160-01-030	1600x318x650 mm	310
FP2 180-00-030	1800x318x650 mm	280	FP2 180-01-030	1800x318x650 mm	320
FP2 200-00-030	2000x318x650 mm	300	FP2 200-01-030	2000x318x650 mm	330

STAINLESS STEEL FURNITURE

WALL SHELVES

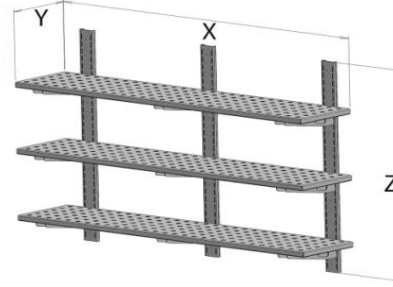
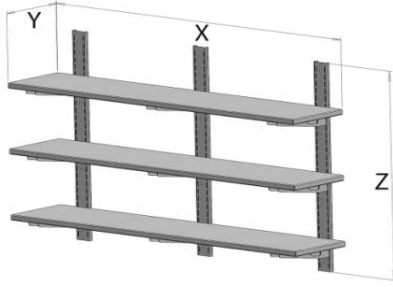

Stainless steel triple shelf, applicable to wall with 3 rails + brackets (3 rails + brackets included)

Stainless steel perforated triple shelf, applicable to wall with 3 rails + brackets (3 rails + brackets included)

318

318

Code	Size X x Y x Z	List price (EUR)	Code	Size X x Y x Z	List price (EUR)
FP3 060-00-030	600x318x950 mm	320	FP3 060-01-030	600x318x950 mm	380
FP3 080-00-030	800x318x950 mm	350	FP3 080-01-030	800x318x950 mm	400
FP3 100-00-030	1000x318x950 mm	370	FP3 100-01-030	1000x318x950 mm	420
FP3 120-00-030	1200x318x950 mm	390	FP3 120-01-030	1200x318x950 mm	440
FP3 140-00-030	1400x318x950 mm	420	FP3 140-01-030	1400x318x950 mm	470
FP3 160-00-030	1600x318x950 mm	440	FP3 160-01-030	1600x318x950 mm	490
FP3 180-00-030	1800x318x950 mm	470	FP3 180-01-030	1800x318x950 mm	520
FP3 200-00-030	2000x318x950 mm	500	FP3 200-01-030	2000x318x950 mm	550

WALL SHELVES

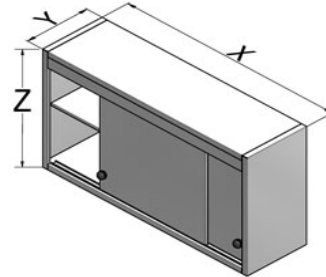
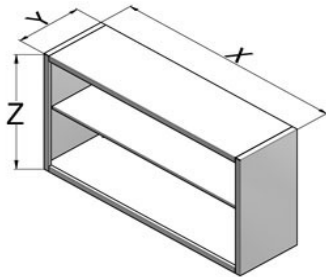

3 sides closed stainless steel wall shelf with interior shelf

3 sides closed stainless steel wall shelf with sliding doors and interior shelf

350

350

Code	Size X x Y x Z	List price (EUR)	Code	Size X x Y x Z	List price (EUR)
79FP-0863	800x350x650 mm	400	80FP-0863	800x350x650mm	670
79FP-1063	1000x350x650 mm	430	80FP-1063	1000x350x650 mm	720
79FP-1263	1200x350x650 mm	490	80FP-1263	1200x350x650 mm	780
79FP-1463	1400x350x650 mm	530	80FP-1463	1400x350x650 mm	840
79FP-1663	1600x350x650 mm	560	80FP-1663	1600x350x650 mm	910
79FP-1863	1800x350x650 mm	620	80FP-1863	1800x350x650 mm	970
79FP-2063	2000x350x650 mm	670	80FP-2063	2000x350x650 mm	1 080

STAINLESS STEEL FURNITURE

SHELVING UNITS

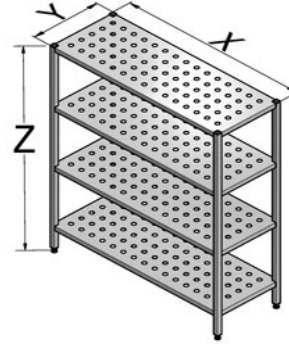
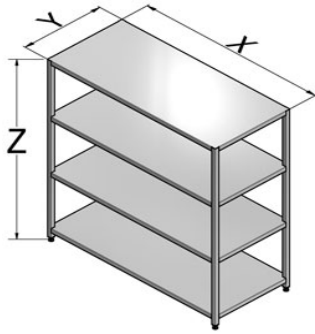

Stainless steel shelving unit with 4 shelves and adjustable legs

Stainless steel perforated shelving unit with 4 shelves and adjustable legs

500

500

Code	Size X x Y x Z	List price (EUR)	Code	Size X x Y x Z	List price (EUR)
81 T 105	1000x500x1800 mm	580	82 T 105	1000x500x1800 mm	630
81 T 125	1200x500x1800 mm	640	82 T 125	1200x500x1800 mm	680
81 T 145	1400x500x1800 mm	680	82 T 145	1400x500x1800 mm	730
81 T 165	1600x500x1800 mm	730	82 T 165	1600x500x1800 mm	780
81 T 185	1800x500x1800 mm	780	82 T 185	1800x500x1800 mm	830

600

600

Code	Size X x Y x Z	List price (EUR)	Code	Size X x Y x Z	List price (EUR)
81 T 106	1000x600x1800 mm	620	82 T 106	1000x600x1800 mm	690
81 T 126	1200x600x1800 mm	670	82 T 126	1200x600x1800 mm	740
81 T 146	1400x600x1800 mm	740	82 T 146	1400x600x1800 mm	800
81 T 166	1600x600x1800 mm	780	82 T 166	1600x600x1800 mm	840
81 T 186	1800x600x1800 mm	840	82 T 186	1800x600x1800 mm	890

FLOOR DRAIN, STEPPING GRID

FLOOR DRAIN WITH SEALANT COLLAR

Stainless steel, chrome nickel, non-skidding floor drain and stepping grid with sealant collar, riffle, odour siphon.

Please note in the order which filter you need!

Stump Ø: NA 100

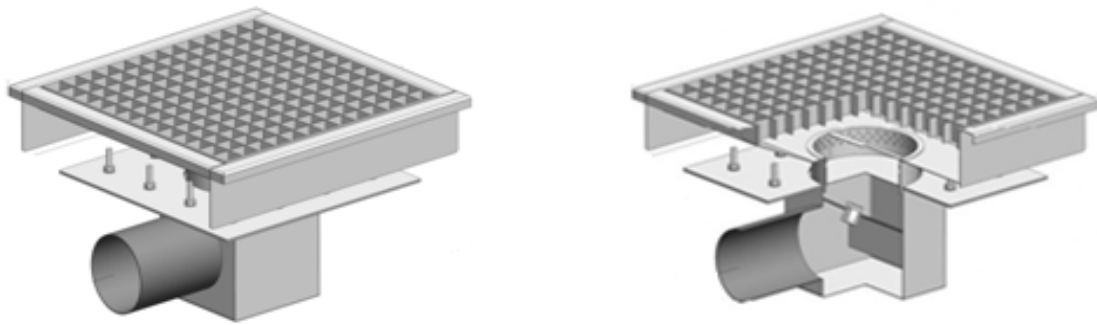

WITH SIDE PIPE

Code	Description	List price (EUR)
PSZO 460	460 x 460 x 245 - 280 mm (with filter 265 mm)	630
PSZO 460 x rm	running meter	1110 EUR / rm

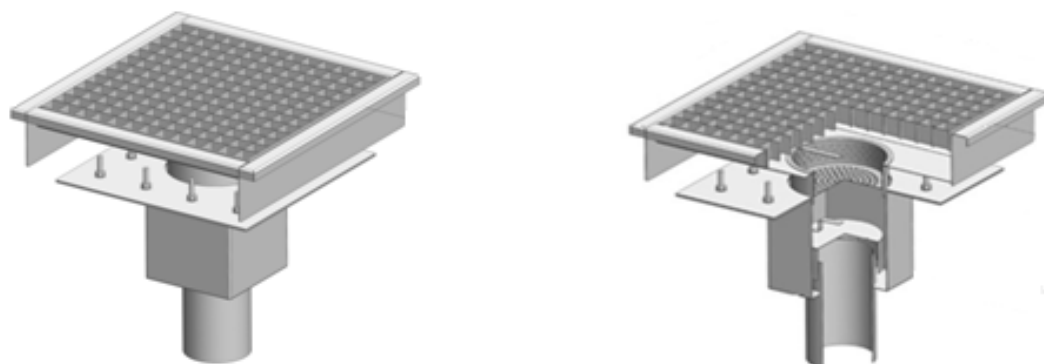

WITH LOWER PIPE

Code	Description	List price (EUR)
PSZA 460	460 x 460 x 245 - 280 mm	630
PSZA 460 x rm	running meter	1110 EUR / rm

FLOOR DRAIN, STEPPING GRID

CIRCULAR FILTER FOR PASTA, CIRCULAR FILTER FOR SAND (PSZO, PSZA COMPATIBLES)

Stainless steel, chrome nickel circular pasta and sand filters

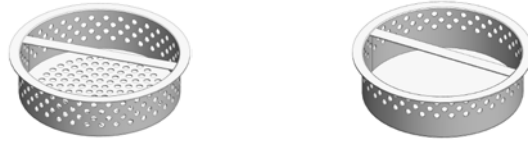

Code	Description	List price (EUR)
TF-PSZ-150	Ø 164 x 40 mm	80
HF-PSZ-150	Ø 164 x 40 mm	80

NON-SKIDDING STEPPING GRID

Stainless steel, chrome nickel non-skidding stepping grid

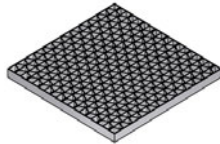

Code	Description	List price (EUR)
PT 395	400 x 400 x 30 mm	230
PT 395 x rm	running meter	410 EUR / rm

FLOOR DRAIN, STEPPING GRID

FLOOR DRAIN

Stainless steel, chrome-nickel, non-skidding, complete floor drain and stepping grid, with riffle, odour siphon and filters for pasta or sand.

Please note in the order which filter you need!

Stump Ø: NA 100

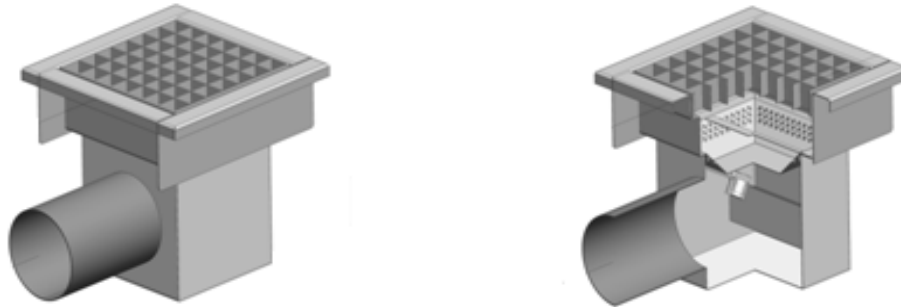

WITH SIDE PIPE

Code	Description	List price (EUR)
PLO - 260	260 x 260 x 240 mm	410
PLO - 260 x rm	running meter	760 EUR / rm

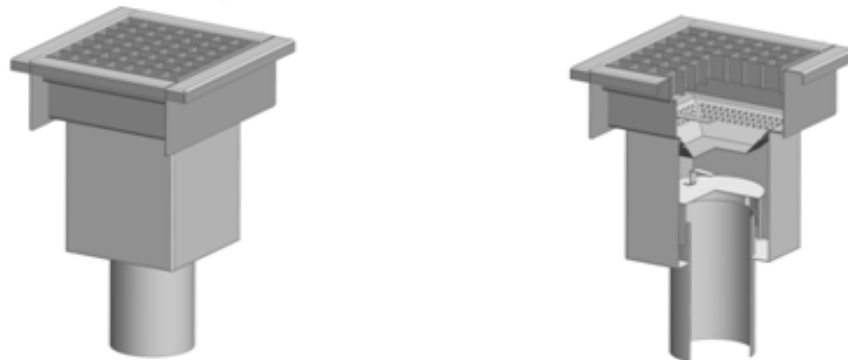

WITH LOWER PIPE

Code	Description	List price (EUR)
PLA - 260	260 x 260 x 240 mm	410
PLA - 260 x rm	running meter	760 EUR / rm

FLOOR DRAIN, STEPPING GRID

FLOOR DRAIN

Stainless steel, chrome-nickel, non-skidding, complete floor drain and stepping grid, with riffle, odour siphon and filters for pasta or sand.

Please note in the order which filter you need!

Stump Ø: NA 100

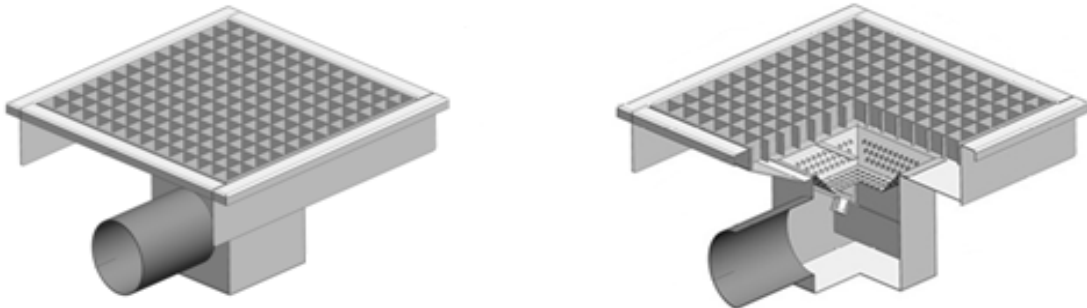

WITH SIDE PIPE

Code	Description	List price (EUR)
PLO - 460	460 x 460 x 240 mm	550
PLO - 460 x rm	running meter	1000 EUR / rm

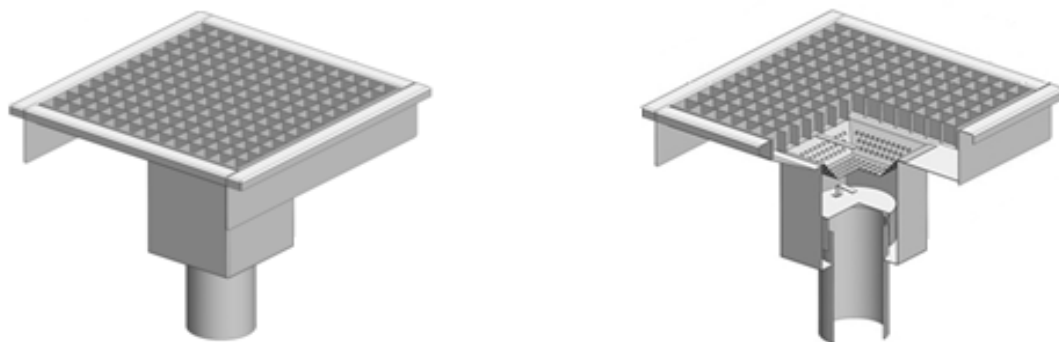

WITH LOWER PIPE

Code	Description	List price (EUR)
PLA - 460	460 x 460 x 240 mm	550
PLA - 460 x rm	running meter	1000 EUR / rm

FLOOR DRAIN, STEPPING GRID

ANGULAR FILTER FOR PASTA, ANGULAR FILTER FOR SAND (PLO, PLA COMPATIBLES)

Angular stainless steel, chrome nickel pasta and sand filters



Code	Description	List price (EUR)
TF-PL-160	183 x 167 x 35 mm	80
HF-PL-160	183 x 167 x 35 mm	80

NON-SKIDDING STEPPING GRID

Stainless steel, chrome nickel, non-skidding stepping grid



Code	Description	List price (EUR)
PT 195	200 x 200 x 30 mm	140
PT 195 x rm	running meter	280
PT 395	400 x 400 x 30 mm	230
PT 395 x rm	running meter	410

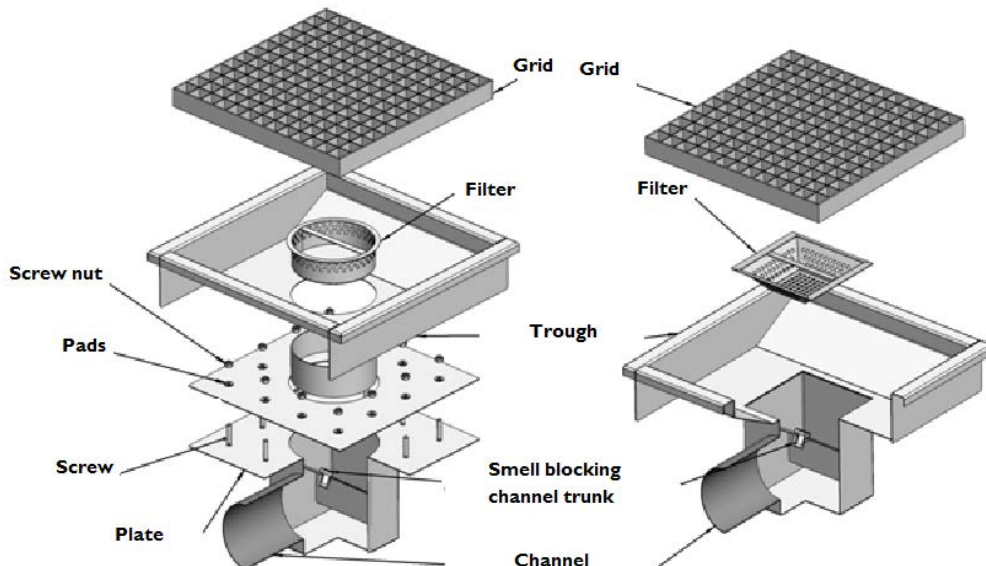

HOODS

Extractor hoods

"Snack" stainless steel wall extractor hood with grease filter and grease release tap

Snag: Ø 250x150 mm

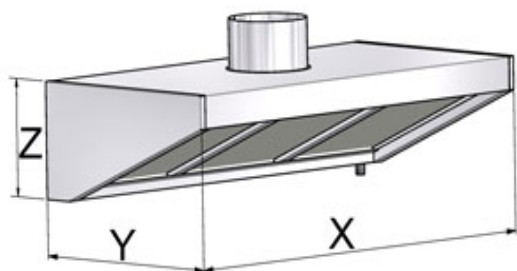

"Standard" stainless steel wall extractor hood with grease filter and grease release tap

Snag: Ø 250x150 mm

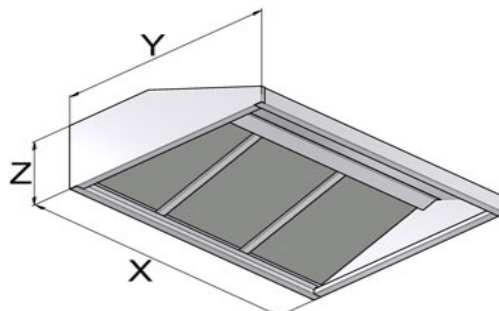

Code	Size X x Y x Z	List price (EUR)	Code	Size X x Y x Z	List price (EUR)
EL 080-00-070	800x700x350 mm	990	EL 100-10-110	1000x1100x400 mm	1 070
EL 100-00-070	1000x700x350 mm	1 040	EL 140-10-110	1400x1100x400 mm	1 260
EL 120-00-070	1200x700x350 mm	1 070	EL 180-10-110	1800x1100x400 mm	1 390
EL 140-00-070	1400x700x350 mm	1 170	EL 220-10-110	2200x1100x400 mm	1 530
EL 160-00-070	1600x700x350 mm	1 210	EL 260-10-110	2600x1100x400 mm	1 710
EL 180-00-070	1800x700x350 mm	1 280	EL 300-10-110	3000x1100x400 mm	1 960
EL 200-00-070	2000x700x350 mm	1 390			
EL 220-00-070	2200x700x350 mm	1 510			

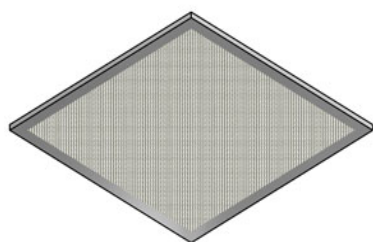

Stainless steel grease filter
(Can be cleaned in dishwasher)

Code	Size X x Y x Z	List price (EUR)
ZS 000-40-40	400x400x12 mm	110
ZS 000-40-50	400x500x12 mm	130
ZS 000-50-50	500x500x12 mm	150

Snag size and place can be changed!
Required extraction: 2500-3000 m³/h for 1 m²
Extractor snag required on every 1400 mm
Lighting on request
Fan and motor not included

HOODS

"Island" extractor hoods

"Island" stainless steel extractor hood with grease filter and grease release tap

Snag: Ø 300x150 mm

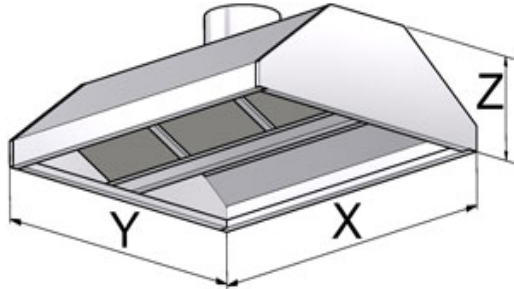

"Double island" stainless steel extractor hood with grease filter and grease release tap

Snag: Ø 300x150 mm

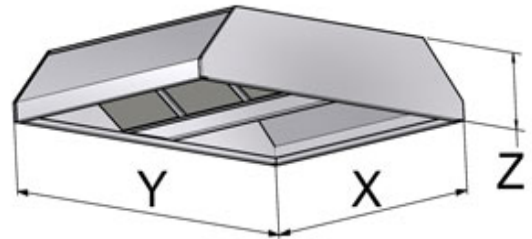

Code	Size X x Y x Z	List price (EUR)	Code	Size X x Y x Z	List price (EUR)
EL 100-20-120	1000x1200x400 mm	1 290	EL 100-30-210	1000x2100x400 mm	2 150
EL 140-20-120	1400x1200x400 mm	1 420	EL 140-30-210	1400x2100x400 mm	2 360
EL 180-20-120	1800x1200x400 mm	1 930	EL 180-30-210	1800x2100x400 mm	2 740
EL 220-20-120	2200x1200x400 mm	2 280	EL 220-30-210	2200x2100x400 mm	3 040
EL 260-20-120	2600x1200x400 mm	2 400	EL 260-30-210	2600x2100x400 mm	3 460
EL 300-20-120	3000x1200x400 mm	2 760	EL 300-30-210	3000x2100x400 mm	3 840

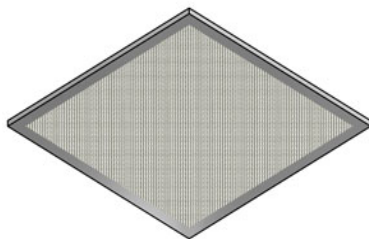

Stainless steel grease filter
(Can be cleaned in dishwasher)

Code	Size X x Y x Z	List price (EUR)
ZS 000-40-40	400x400x12 mm	110
ZS 000-40-50	400x500x12 mm	130
ZS 000-50-50	500x500x12 mm	150

Snag size and place can be changed!
Required extraction: 2500-3000 m³/h for 1 m²
Extractor snag required on every 1400 mm
Lighting on request
Fan and motor not included

Gasztrometál Gép- és Berendezésgyártó Zrt.

**Hungary, 2800 Tatabánya
Vágóhíd u. 4.**

Tel.: +36-34/514-661
E-mail: sales@gasztrometal.hu
Web: www.gasztrometal.hu



We reserve the right to change prices. Prices are not include VAT.

Due to continuous technical developement Gasztrometál Zrt. reserves the rights to change technical and formal parameters of its products.