









700.0

American Standard
WATER HEATERS

GN SERIES-ULTRA LOW NO_x ATMOSPHERIC
SÉRIE GN-ATMOSPHÉRIQUE À TRÈS FAIBLES ÉMISSIONS DE NO_x

GAS STORAGE RESIDENTIAL WATER HEATER
CHAUFFE-EAU RÉSIDENTIEL À ACCUMULATION AU GAZ



-  **TRADITIONAL MECHANICAL GAS VALVE FOR SIMPLE AND MAINTENANCE FREE OPERATION**
VANNE À GAZ MÉCANIQUE TRADITIONNELLE POUR UN FONCTIONNEMENT SIMPLE ET SANS ENTRETIEN
-  **DURA-GLAS™ LINED, HEAVY GAUGE STEEL TANK FOR OPTIMUM PROTECTION AGAINST CORROSION**
RÉSERVOIR EN ACIER ÉPAIS DOUBLÉ DE DURA-GLAS™ POUR UNE PROTECTION OPTIMALE CONTRE LA CORROSION
-  **T&P VALVE INCLUDED FOR EASY INSTALLATION**
SOUPAPE DE SÉCURITÉ INCLUSE POUR UNE INSTALLATION FACILE
-  **FVIR COMPLIANT**
CONFORME À LA DIRECTIVE SUR LES VÉHICULES À MOTEUR (FVIR)

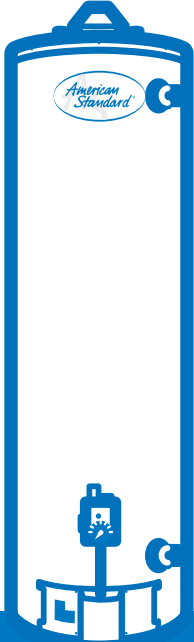

420062073500

540.0

Precision level for dimentions without tolerance indication:	Drawing format: A4	Volume (in³):	Date:
+ - 3 MM	Sheet: 1/1		05/11/2025
Critical characteristics = 0 = 0 = 0	Scale: 1:5	Weight (lb):	Designer:
Conformity requirements see document "R&D.TB005Tt"			Carlo Garcia
	Material: PAPEL COUCHÉ 130 G CON ADHESIVO DIMASSA MORADO		
	Treatment:		
	Finishing:		
 ARISTON GROUP BLVD ISIDRO LOPEZ ZERTUCHE NO. 1839, COL. UNIVERSIDAD, 25260, SALTILLO, COAHUILA	Description: PÓSTER GSN 640 X 700	Code: 420062073500	
BY TERM LAWS WE RESERVE THE PROPERTY OF THIS DRAWING WITH PROHIBITION OF USE AND REPRODUCTION			

GN SERIES-ULTRA LOW NO_x ATMOSPHERIC SÉRIE GN-ATMOSPHÉRIQUE À TRÈS FAIBLES ÉMISSIONS DE NO_x

GAS STORAGE RESIDENTIAL WATER HEATER
CHAUFFE-EAU RÉSIDENTIEL À ACCUMULATION AU GAZ

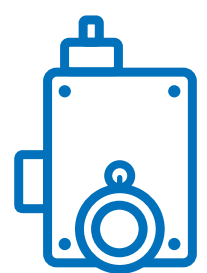

TRADITIONAL MECHANICAL GAS VALVE FOR SIMPLE AND MAINTENANCE FREE OPERATION

VANNE À GAZ MÉCANIQUE TRADITIONNELLE POUR UN FONCTIONNEMENT SIMPLE ET SANS ENTRETIEN

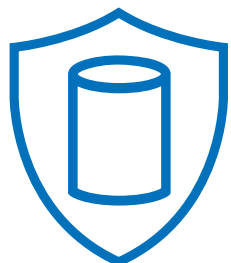

DURA-GLAS™ LINED, HEAVY GAUGE STEEL TANK FOR OPTIMUM PROTECTION AGAINST CORROSION

RÉSERVOIR EN ACIER ÉPAIS DOUBLÉ DE DURA-GLAS™ POUR UNE PROTECTION OPTIMALE CONTRE LA CORROSION

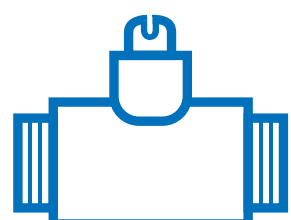

T&P VALVE INCLUDED FOR EASY INSTALLATION

SOUPAPE DE SÉCURITÉ INCLUSE POUR UNE INSTALLATION FACILE



FVIR COMPLIANT

CONFORME À LA DIRECTIVE SUR LES VÉHICULES À MOTEUR (FVIR)

