



300.0





WATER HEATERS

POINT OF USE POINT D'UTILISATION

RESIDENTIAL ELECTRIC WATER HEATER CHAUFFE-EAU ÉLECTRIQUE RÉSIDENTIEL

- 



TOP AND SIDE CONNECTIONS*
RACCORDEMENT SUPÉRIEUR ET LATÉRAL*
- 

LOW-WATT DENSITY INCOLOY HEATING ELEMENT
DEUX ÉLÉMENTS CHAUFFANTS EN INCOLOY À FAIBLE DENSITÉ DE WATTS
- 

FACTORY INSTALLED T&P AND HIGH-FLOW BRASS BALL DRAIN VALVES
ROBINET DE VIDANGE EN LAITON À HAUT DÉBIT ET SOUPAPE DE DÉCHARGE DE PRESSION ET DE TEMPÉRATURE INSTALLÉS EN USINE
- 

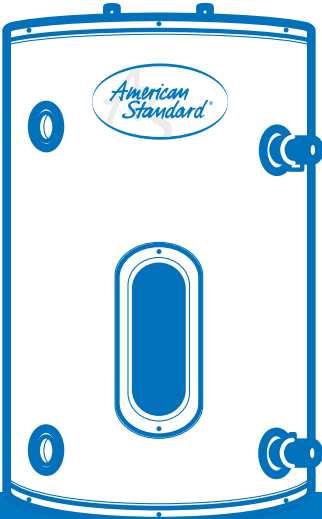
DURA-GLAS™ LINED, HEAVY GAUGE STEEL TANK FOR OPTIMUM PROTECTION AGAINST CORROSION
RÉSERVOIR EN ACIER ÉPAIS DOUBLÉ DE DURA-GLAS™ POUR UNE PROTECTION OPTIMALE CONTRE LA CORROSION





* 10, 20 GAL MODELS
MODELES 6, 11, 20 GAL.

420062063900

400.0

Precision level for dimentions without tolerance indication: +- 3 mm <div style="display: flex; justify-content: space-around; width: 100%;"> = 0 = 0 = 0 </div>	Drawing format: A4 Sheet: 1/1 Scale: 1:5 	Volume (in³): Weight (lb):	Date: 05/11/2025 Designer: Carlo Garcia
Material: PAPEL COUCHÉ 130 G CON ADHESIVO DIMASSA MORADO Treatment:		Finishing: Description: PÓSTER 400 X 300 MM Code: 420062063900	
 <p>BLVD ISIDRO LOPEZ ZERTUCHE NO. 1839, COL. UNIVERSIDAD, 25260, SALTILLO, COAHUILA</p>		<p>BY TERM LAWS WE RESERVE THE PROPERTY OF THIS DRAWING WITH PROHIBITION OF USE AND REPRODUCTION</p>	

POINT OF USE POINT D'UTILISATION

RESIDENTIAL ELECTRIC WATER HEATER CHAUFFE-EAU ÉLECTRIQUE RÉSIDENTIEL

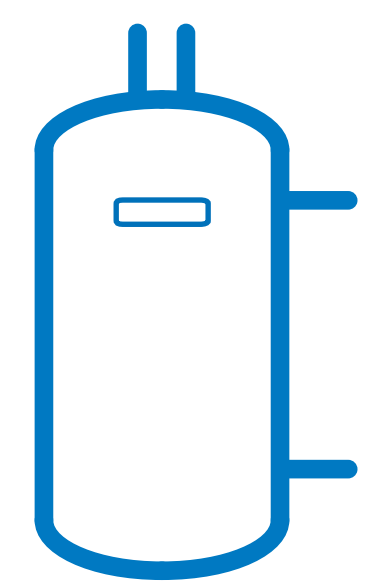

TOP AND SIDE CONNECTIONS*
RACCORDEMENT SUPÉRIEUR ET LATÉRAL*

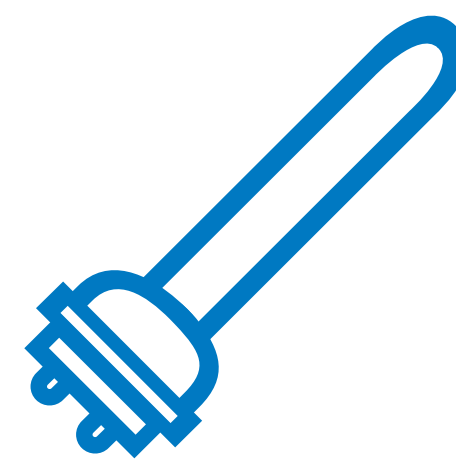

LOW-WATT DENSITY INCOLOY HEATING ELEMENT
DEUX ÉLÉMENTS CHAUFFANTS EN INCOLOY À
FAIBLE DENSITÉ DE WATTS

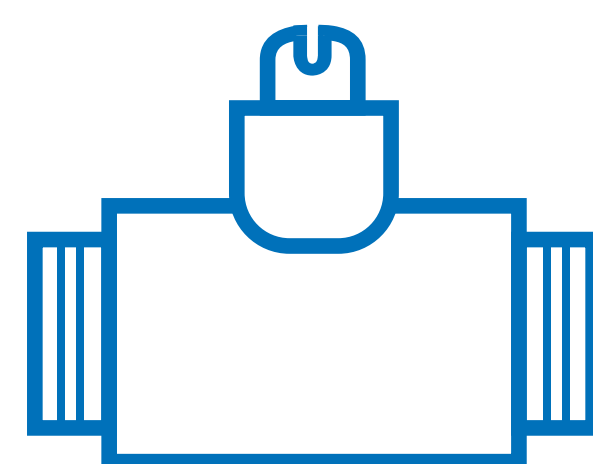

FACTORY INSTALLED T&P AND HIGH-FLOW BRASS
BALL DRAIN VALVES
ROBINET DE VIDANGE EN LAITON À HAUT DÉBIT
ET SOUPEPE DE DÉCHARGE DE PRESSION ET DE
TEMPÉRATURE INSTALLÉS EN USINE

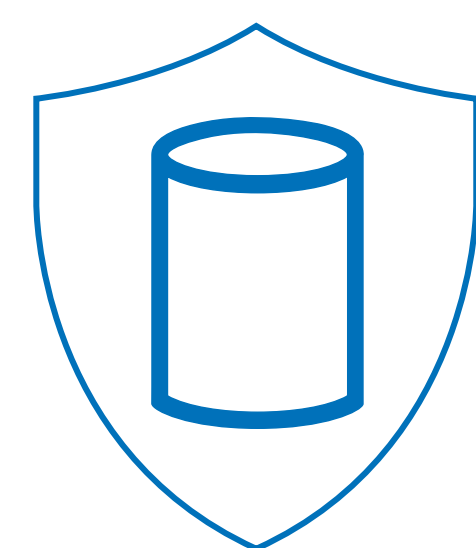

DURA-GLAS™ LINED, HEAVY GAUGE STEEL TANK
FOR OPTIMUM PROTECTION AGAINST CORROSION
RÉSERVOIR EN ACIER ÉPAIS DOUBLÉ DE DURA-GLAS™
POUR UNE PROTECTION OPTIMALE CONTRE LA
CORROSION

