

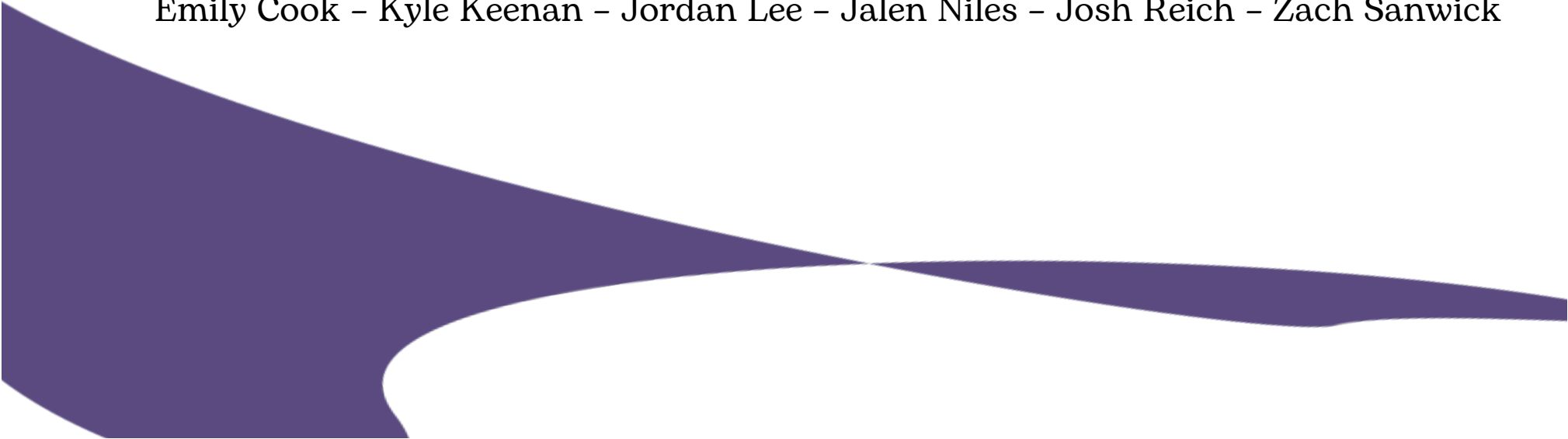

MOMENTÜ

LOMA TECH PACK

Emily Cook – Kyle Keenan – Jordan Lee – Jalen Niles – Josh Reich – Zach Sanwick



Model: LOMA	Season: SPRING 25	Date: 3/5/24
Style Code: 092350	Colorway: BLUEBERRY SUNSHINE	Revision: A
Sample Size: W8	Factory Name: MY SAMPLE FACTORY	

Table of Contents **Page 2**

Section	Page #
Colorway	3
Multiple Views	4
Component Callouts <ul style="list-style-type: none"> Lateral // Medial // Heel // Top View 	5
Material Callouts <ul style="list-style-type: none"> Lateral // Medial // Heel // Top View 	9
Construction Callouts <ul style="list-style-type: none"> Lateral // Heel View 	13
Tongue & Tongue Flap <ul style="list-style-type: none"> Component Callouts Construction Callouts Measurements Layering Color & Deco Construction 	15
Shell Pattern	23
Measurements <ul style="list-style-type: none"> Lateral // Heel View 	24

Section	Page #
Tooling	26
Factory Tooling	27
Sock Liner	28
Reference Images	29
Color Information	34
Bill of Materials	35
Document Revision Notes	37

MOMENTÜ

Model: LOMA

Season: SPRING 25

Date: 3/5/24

Style Code: 092350

Colorway: BLUEBERRY SUNSHINE

Revision: A

Sample Size: W8

Factory Name: MY SAMPLE FACTORY

Colorway

Page 3

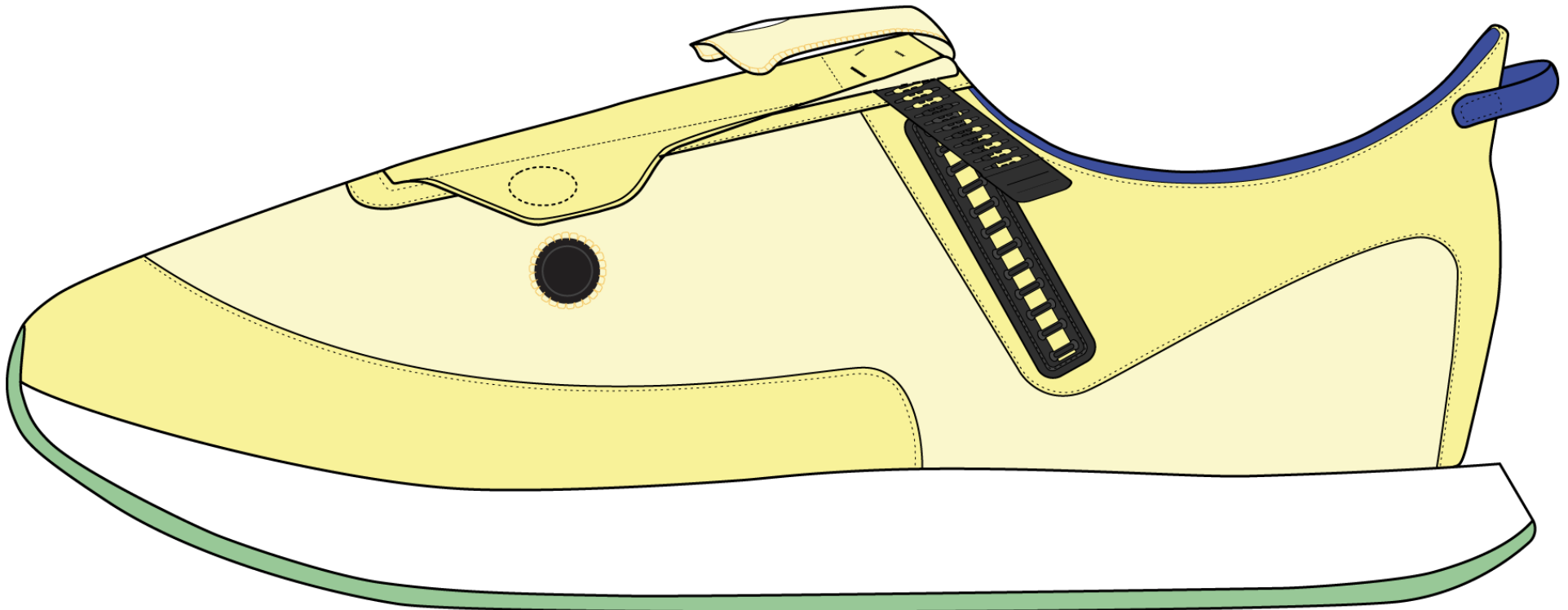

LATERAL VIEW (TONGUE FOLDED/STRAP UP)

MOMENTÜ

Model: LOMA

Season: SPRING 25

Date: 3/5/24

Style Code: 092350

Colorway: BLUEBERRY SUNSHINE

Revision: A

Sample Size: W8

Factory Name: MY SAMPLE FACTORY

Multiple Views // Lateral, Medial, Top Down, Heel, Bottom

Page 4

LATERAL VIEW (TONGUE FOLDED)

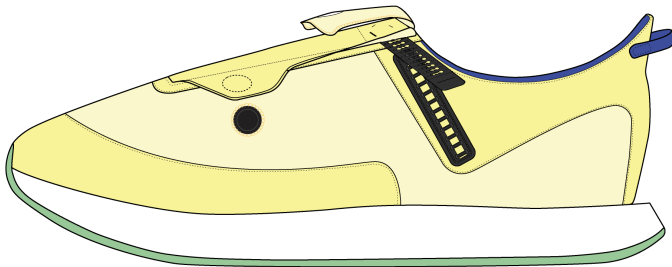

LATERAL VIEW (TONGUE UP)

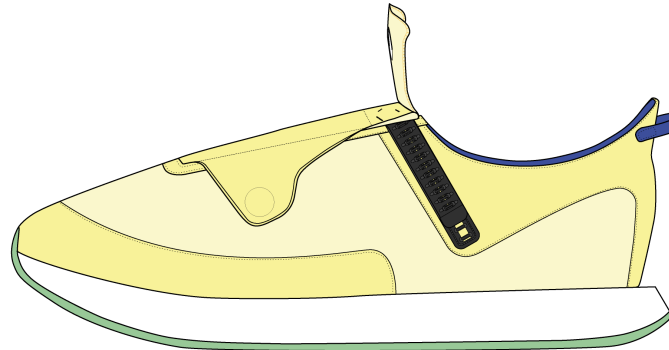

MEDIAL VIEW (TONGUE FOLDED)

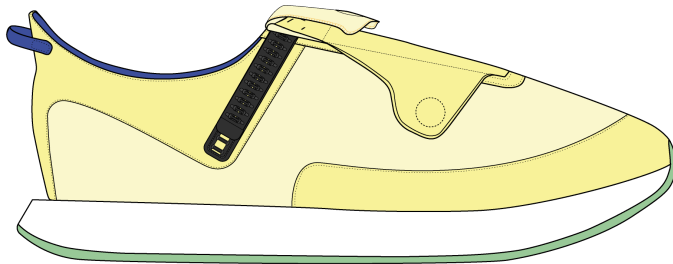

TOP DOWN VIEW

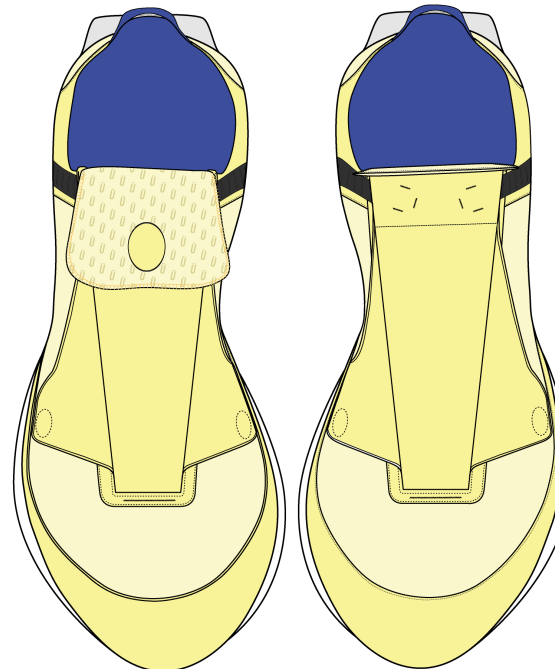

OUTSOLE VIEW

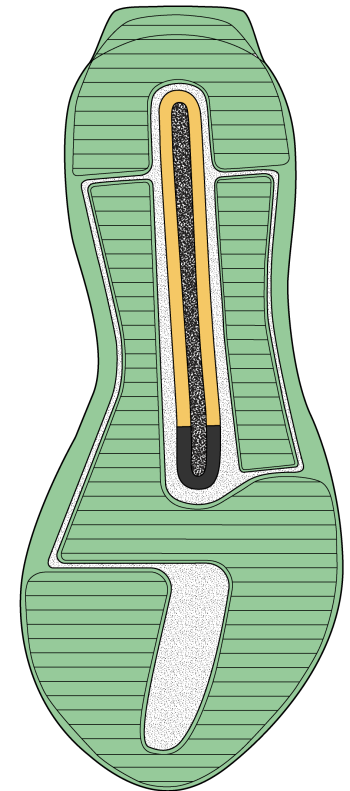

HEEL VIEW (TONGUE FOLDED)

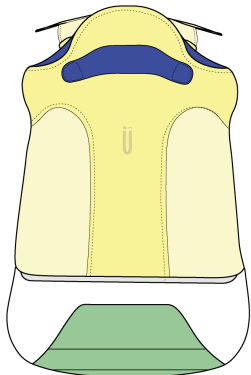

FRONT VIEW (TONGUE FOLDED)

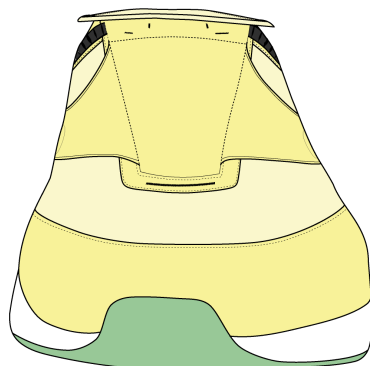

Model: LOMA	Season: SPRING 25	Date: 3/5/24
Style Code: 092350	Colorway: BLUEBERRY SUNSHINE	Revision: A
Sample Size: W8	Factory Name: MY SAMPLE FACTORY	

Component Callouts // Lateral

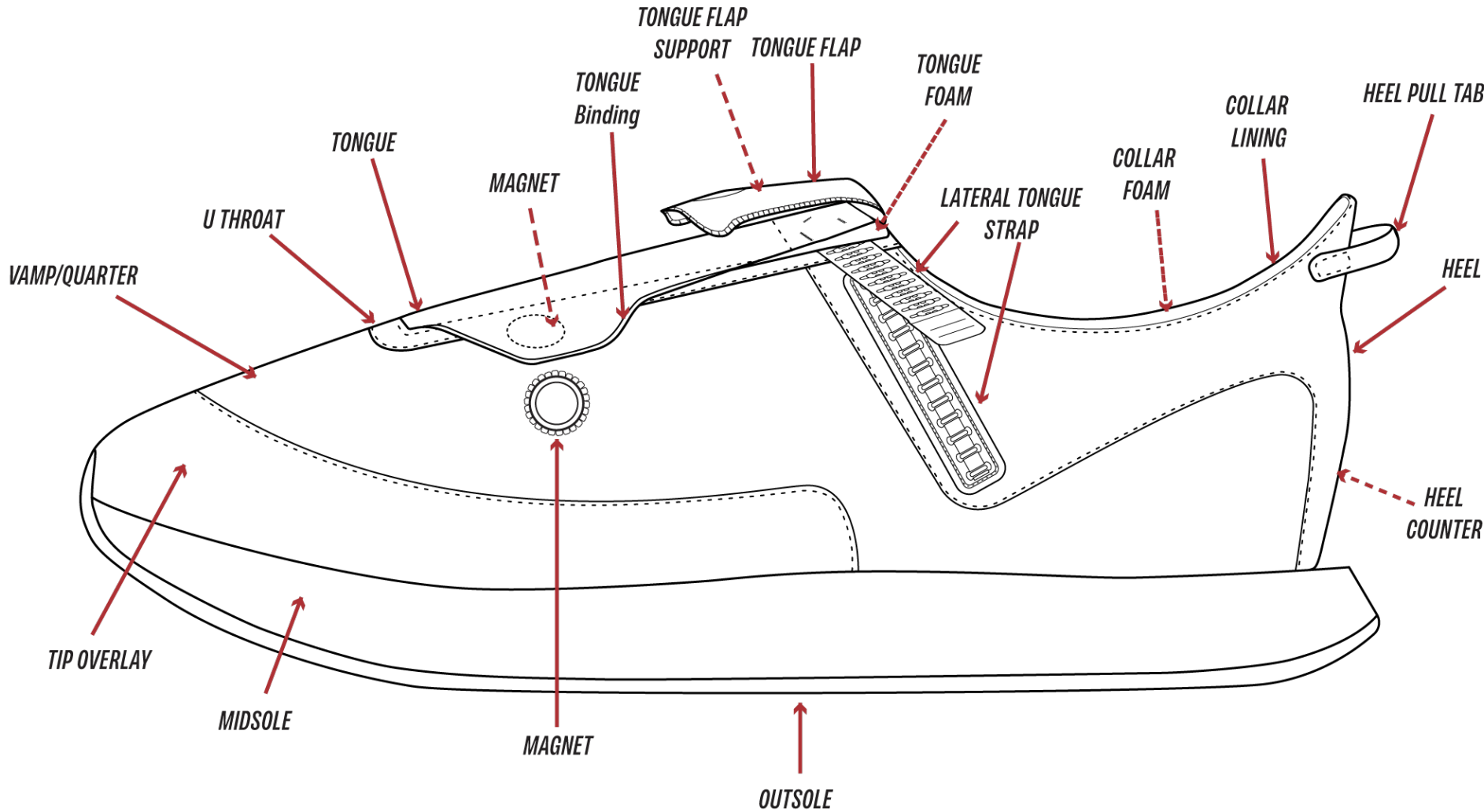

LATERAL VIEW (TONGUE FOLDED/STRAP UP)
COMPONENT CALLOUTS

Model: LOMA	Season: SPRING 25	Date: 3/5/24
Style Code: 092350	Colorway: BLUEBERRY SUNSHINE	Revision: A
Sample Size: W8	Factory Name: MY SAMPLE FACTORY	

Component Callouts // Medial

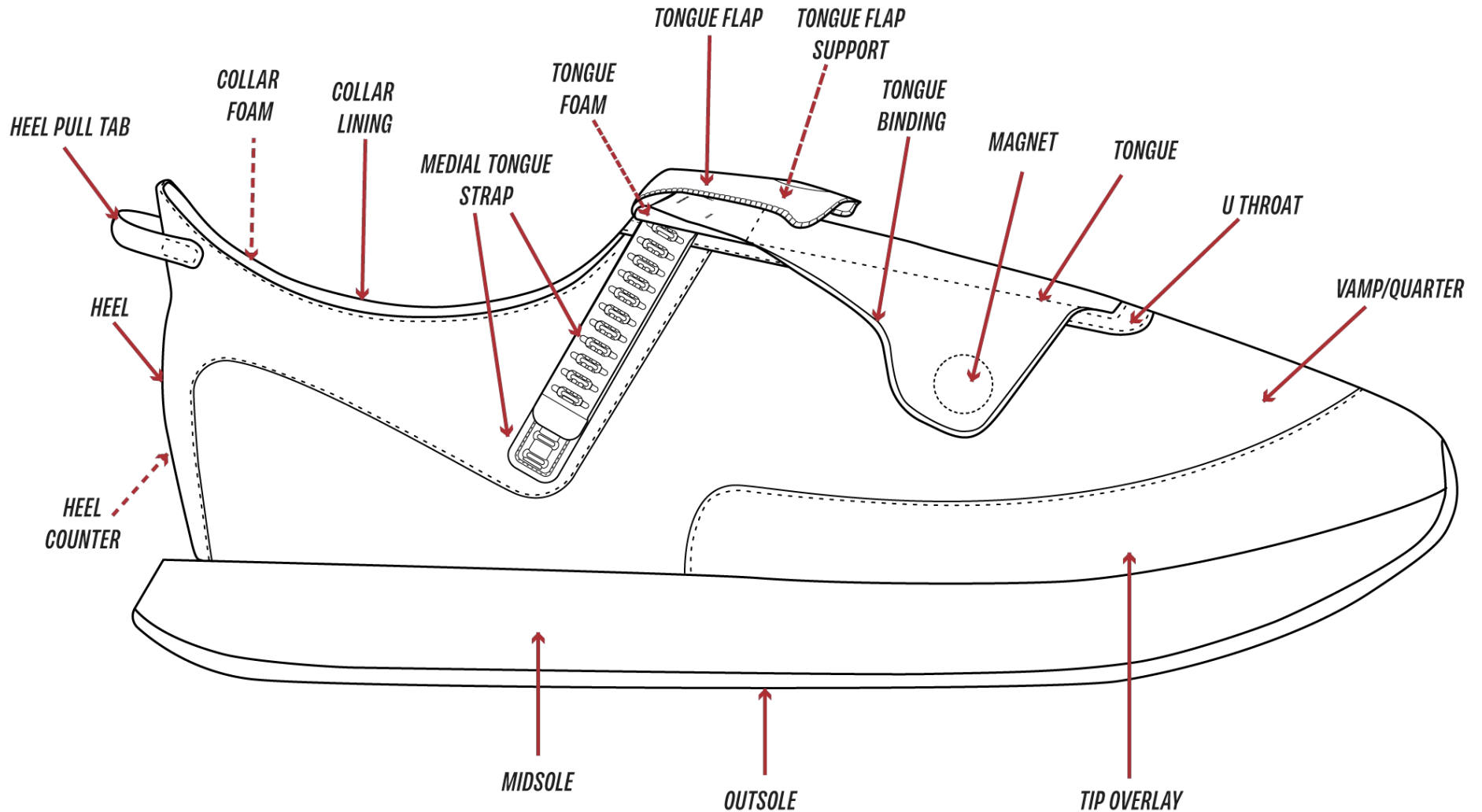

**MEDIAL VIEW (TONGUE FOLDED/STRAP DOWN)
COMPONENT CALLOUTS**

Component Callouts // Top View

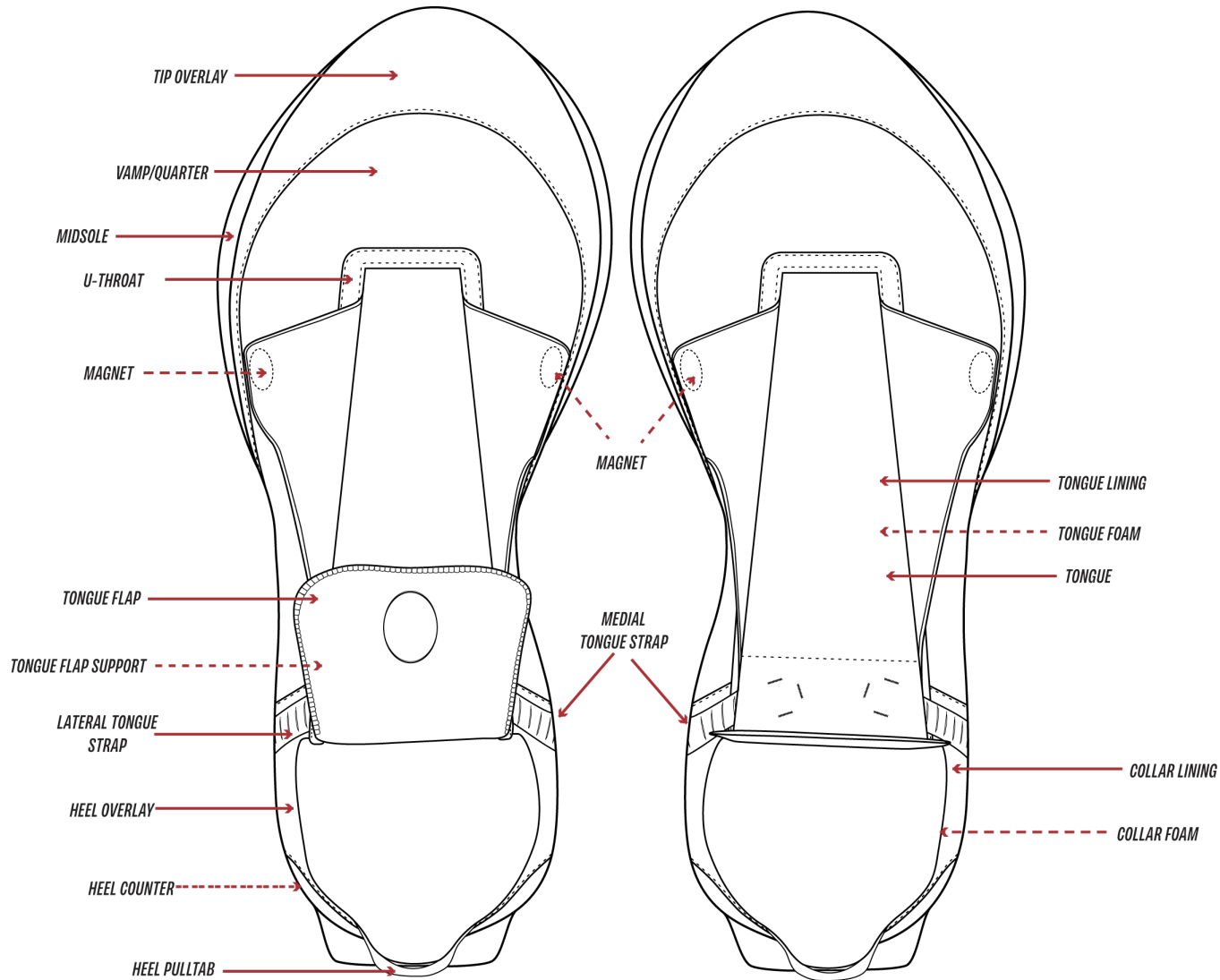

TOP VIEW - COMPONENT CALLOUTS

Model: LOMA	Season: SPRING 25	Date: 3/5/24
Style Code: 092350	Colorway: BLUEBERRY SUNSHINE	Revision: A
Sample Size: W8	Factory Name: MY SAMPLE FACTORY	

Component Callouts // Heel View

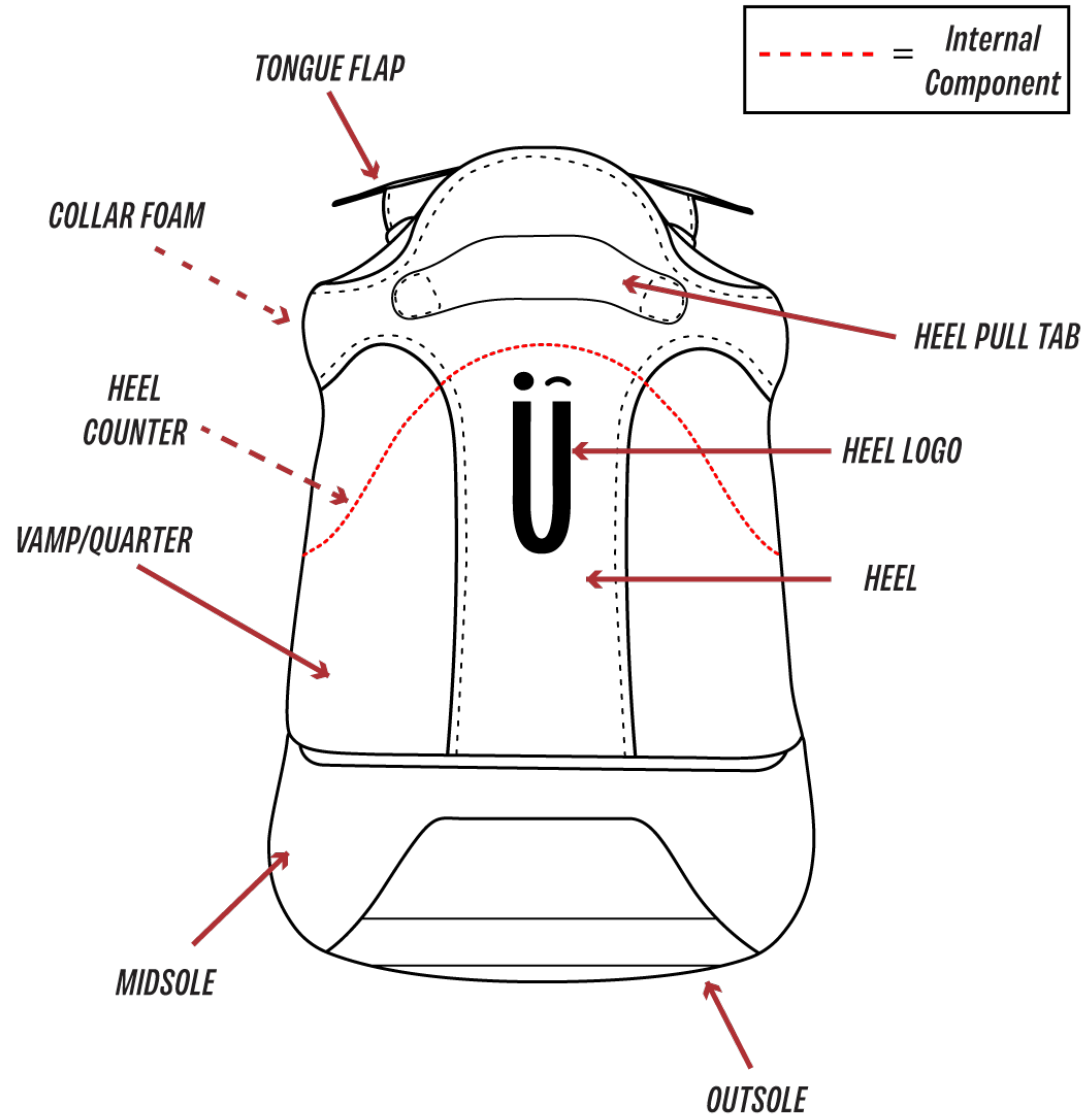

HEEL VIEW COMPONENT CALLOUTS

Model: LOMA	Season: SPRING 25	Date: 3/5/24
Style Code: 092350	Colorway: BLUEBERRY SUNSHINE	Revision: A
Sample Size: W8	Factory Name: MY SAMPLE FACTORY	

Material Callouts // Lateral

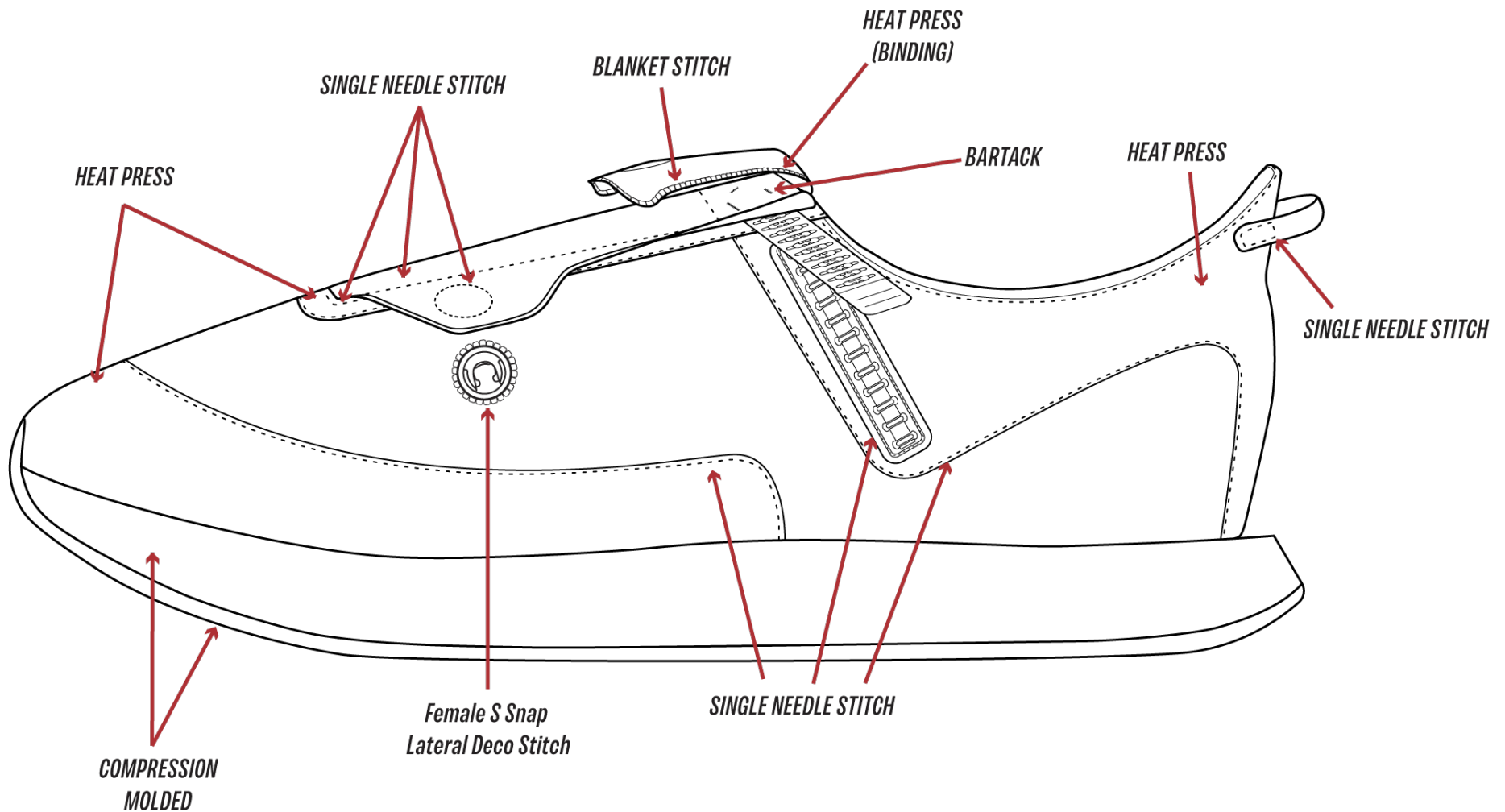

LATERAL VIEW (TONGUE FOLDED/STRAP UP)
CONSTRUCTION CALLOUTS

Model: LOMA	Season: SPRING 25	Date: 3/5/24
Style Code: 092350	Colorway: BLUEBERRY SUNSHINE	Revision: A
Sample Size: W8	Factory Name: MY SAMPLE FACTORY	

Material Callouts // Medial

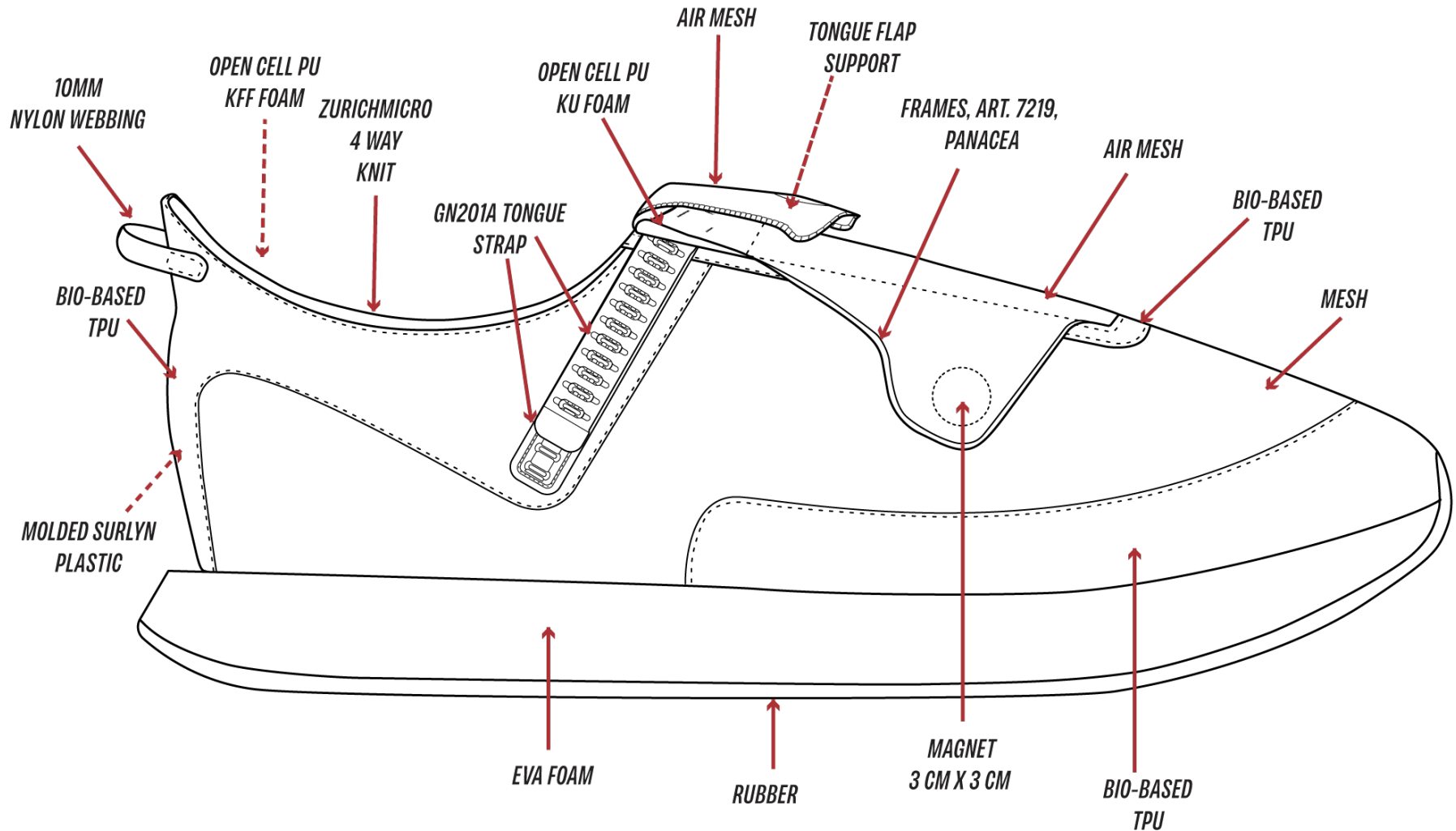

**MEDIAL VIEW (TONGUE FOLDED/STRAP DOWN)
MATERIAL CALLOUTS**

Material Callouts // Top View

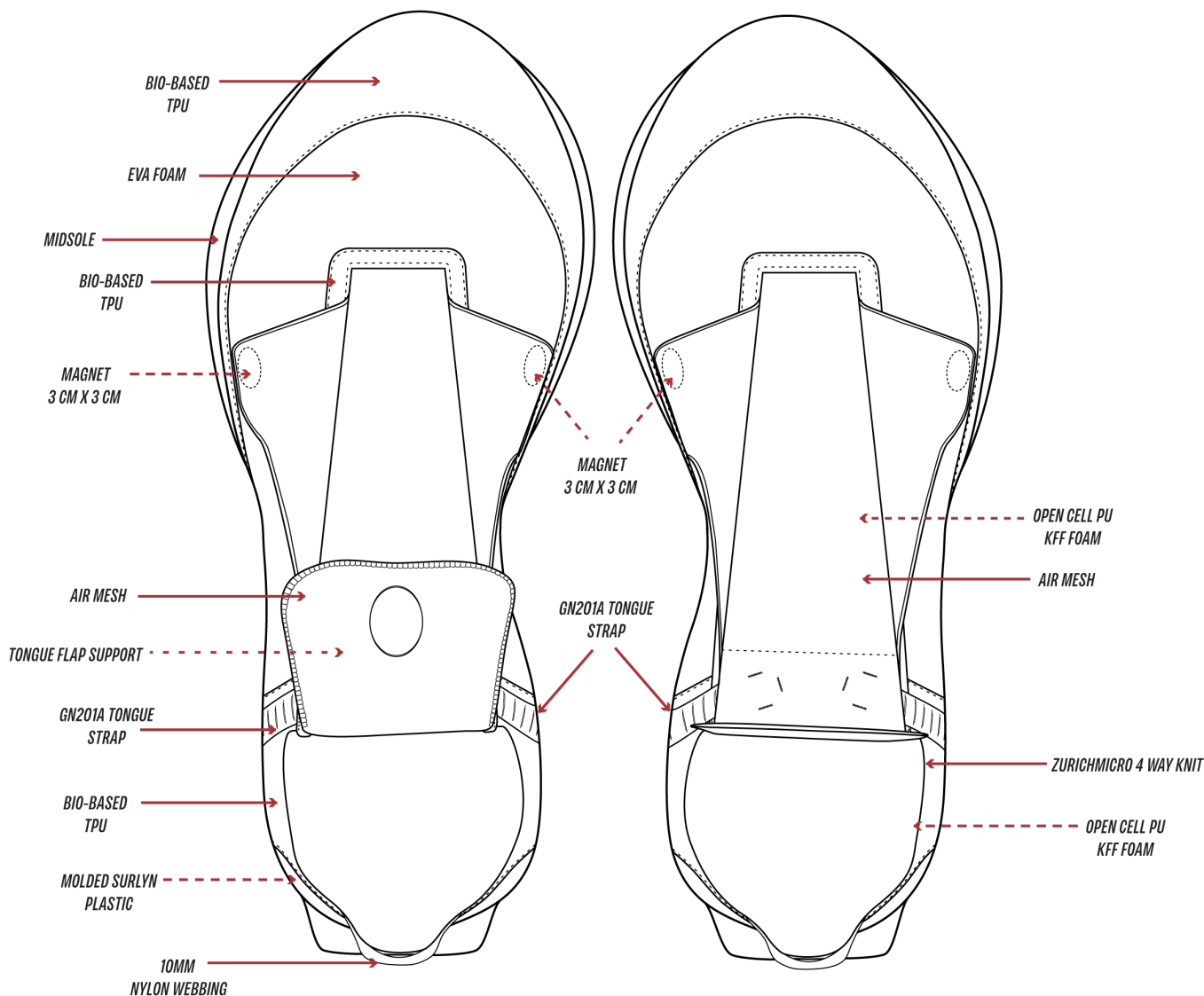

TOP VIEW - MATERIAL CALLOUTS

Model: LOMA	Season: SPRING 25	Date: 3/5/24
Style Code: 092350	Colorway: BLUEBERRY SUNSHINE	Revision: A
Sample Size: W8	Factory Name: MY SAMPLE FACTORY	

Material Callouts // Heel View

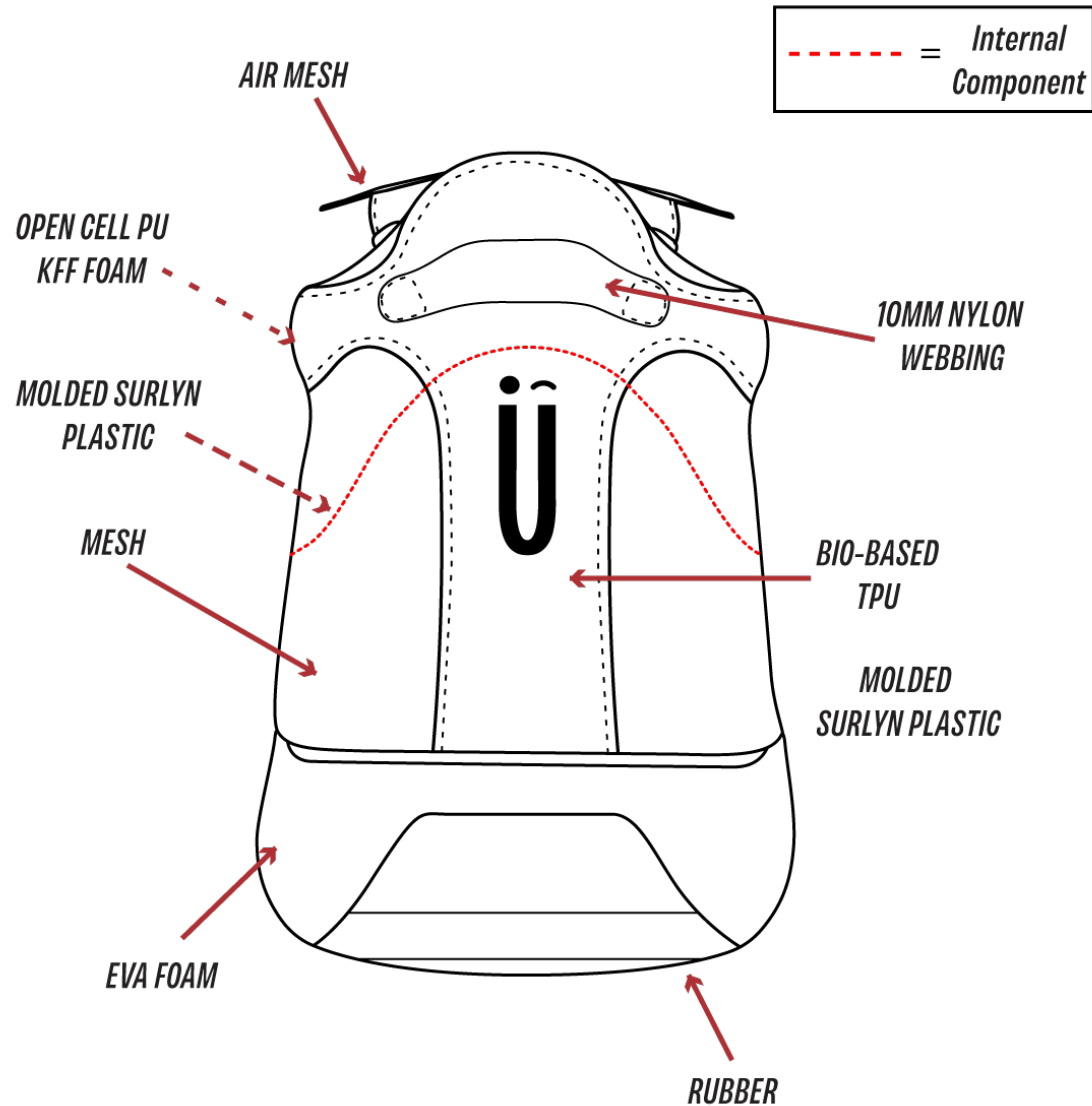

HEEL VIEW MATERIAL CALLOUTS

Model: LOMA	Season: SPRING 25	Date: 3/5/24
Style Code: 092350	Colorway: BLUEBERRY SUNSHINE	Revision: A
Sample Size: W8	Factory Name: MY SAMPLE FACTORY	

Construction Callouts // Lateral

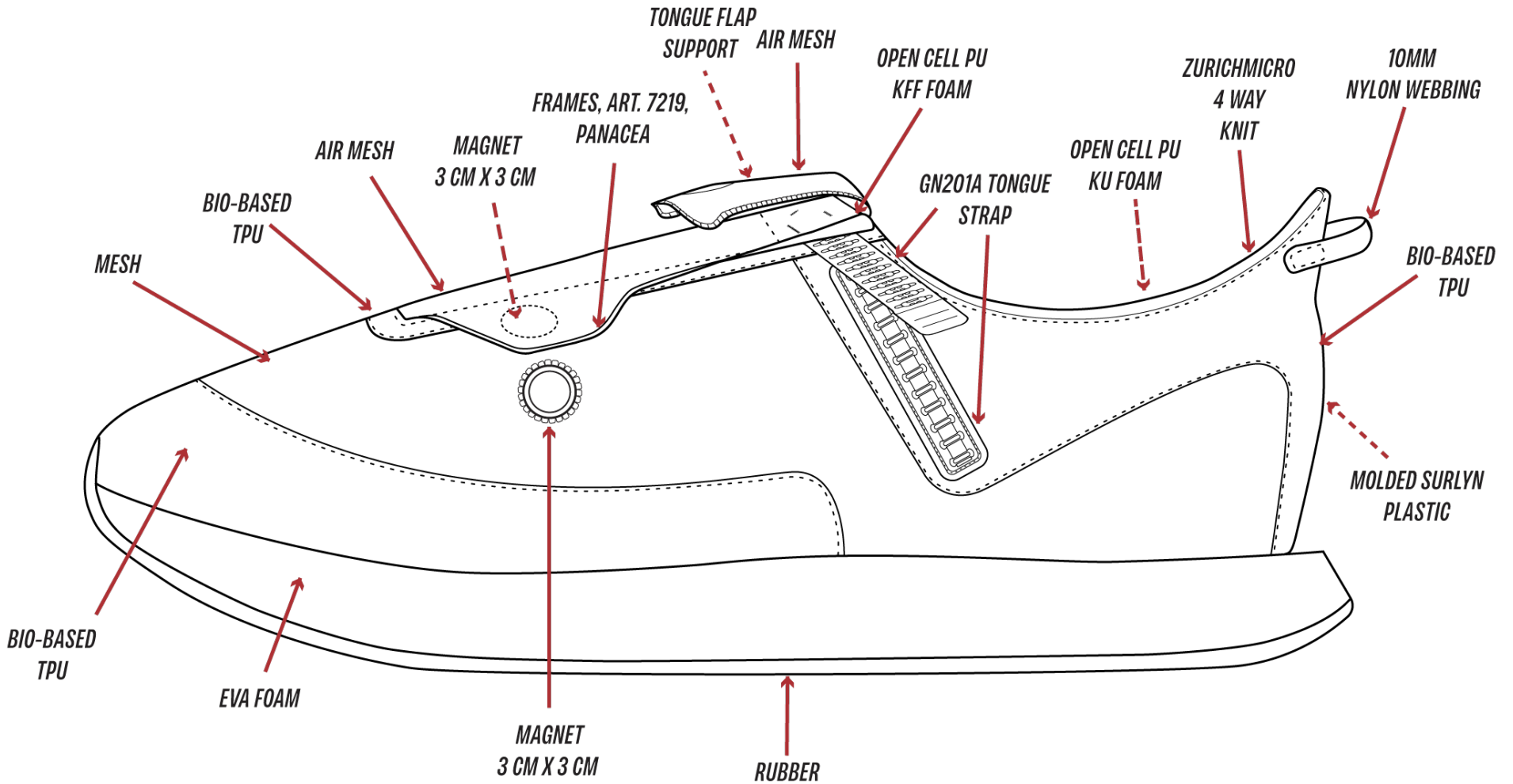

LATERAL VIEW (TONGUE FOLDED/STRAP UP)
MATERIAL CALLOUTS

Construction Callouts // Heel

--- = Internal Component

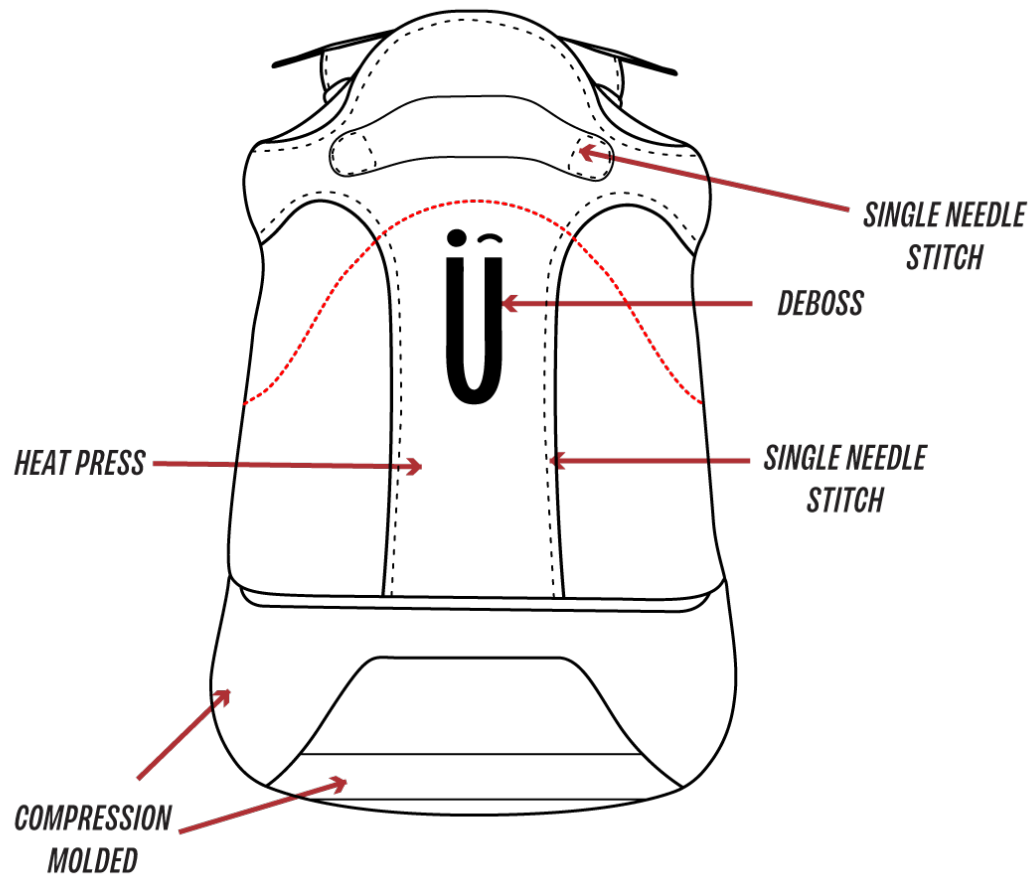

HEEL VIEW CONSTRUCTION CALLOUTS

Tongue // Component Callouts

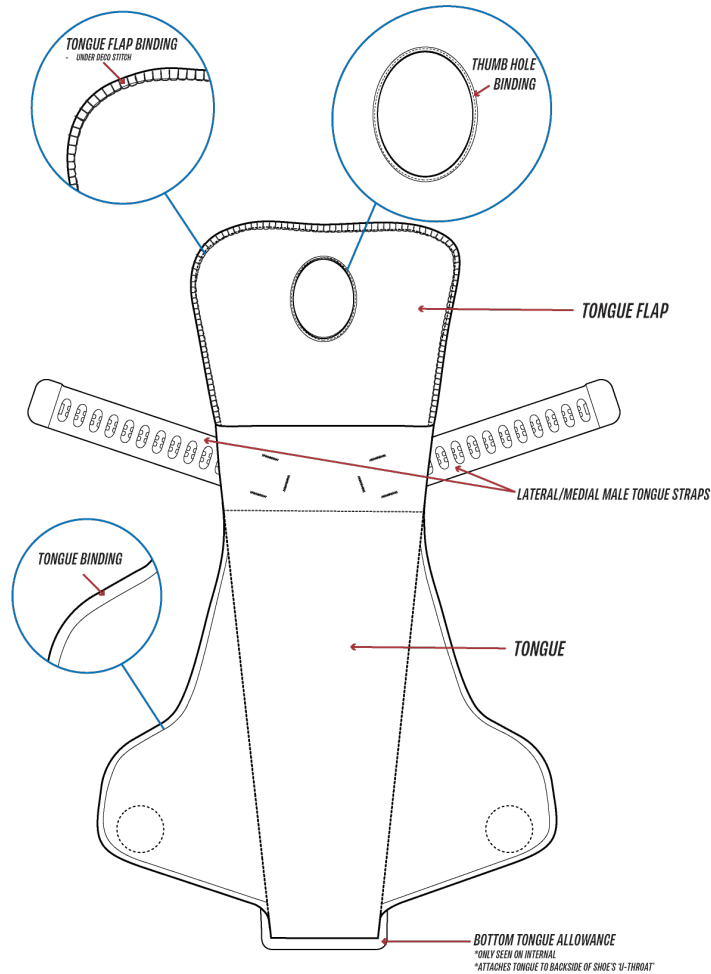

SHOWING FRONTSIDE OF TONGUE

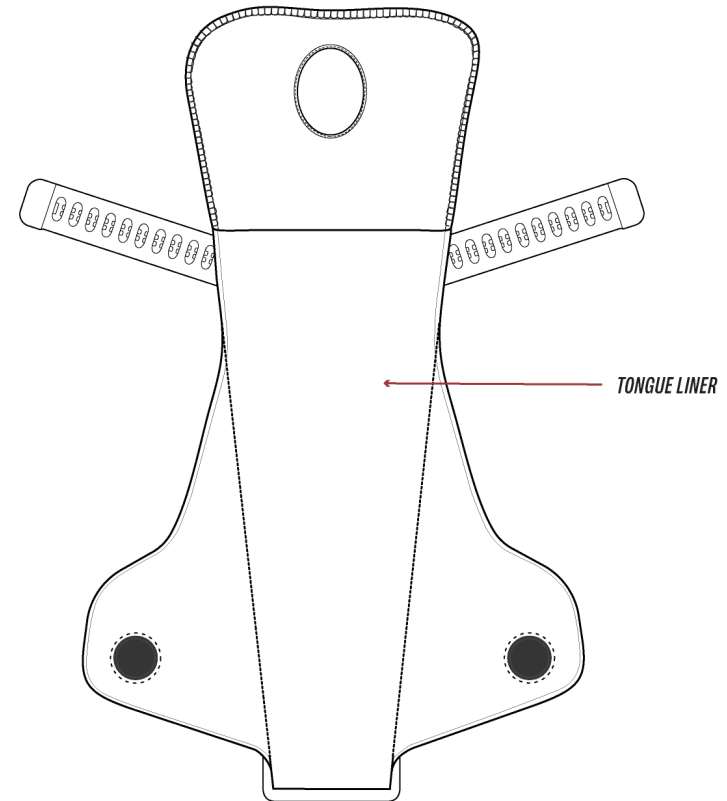

SHOWING BACKSIDE OF TONGUE WITH LINING

TONGUE AND TONGUE FLAP- COMPONENT CALLOUTS

Tongue // Component Callouts

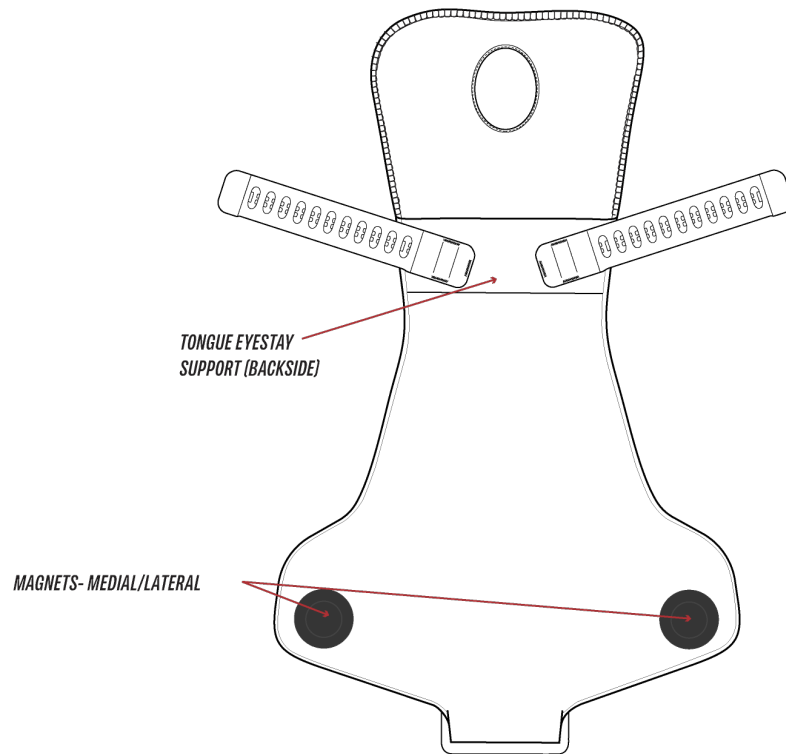

SHOWING BACKSIDE OF TONGUE *WITHOUT TONGUE BACKSIDE LINING
 - VIEWING FROM UNDER THE TONGUE'S BACKSIDE LINING

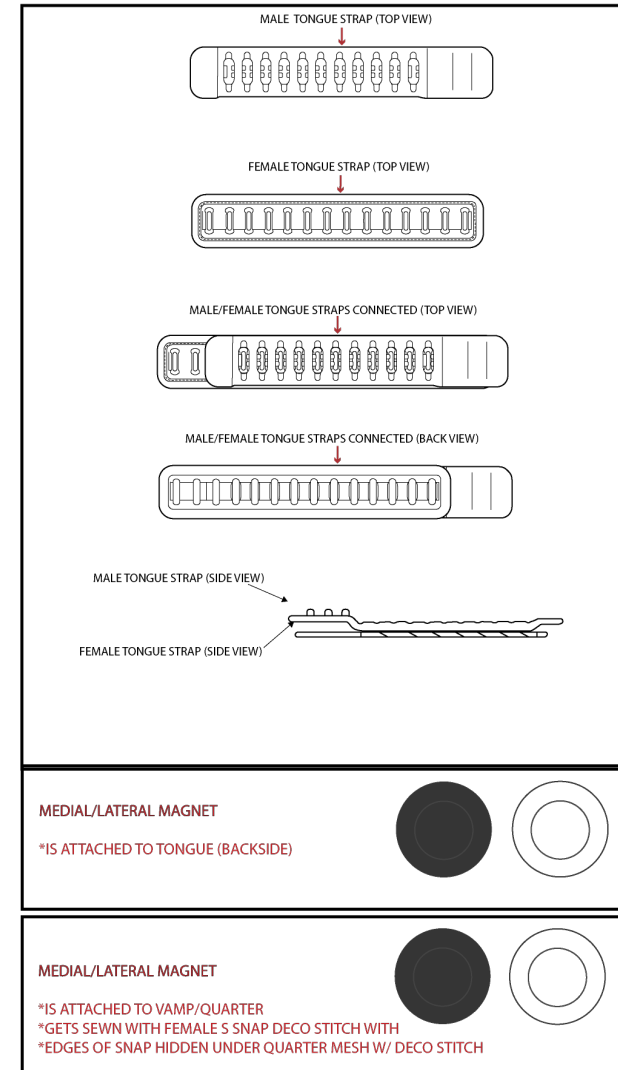

TONGUE AND TONGUE FLAP- COMPONENT CALLOUTS

Model: LOMA	Season: SPRING 25	Date: 3/6/24
Style Code: 092350	Colorway: BLUEBERRY SUNSHINE	Revision: A
Sample Size: W8	Factory Name: MY SAMPLE FACTORY	

Tongue // Construction Callouts

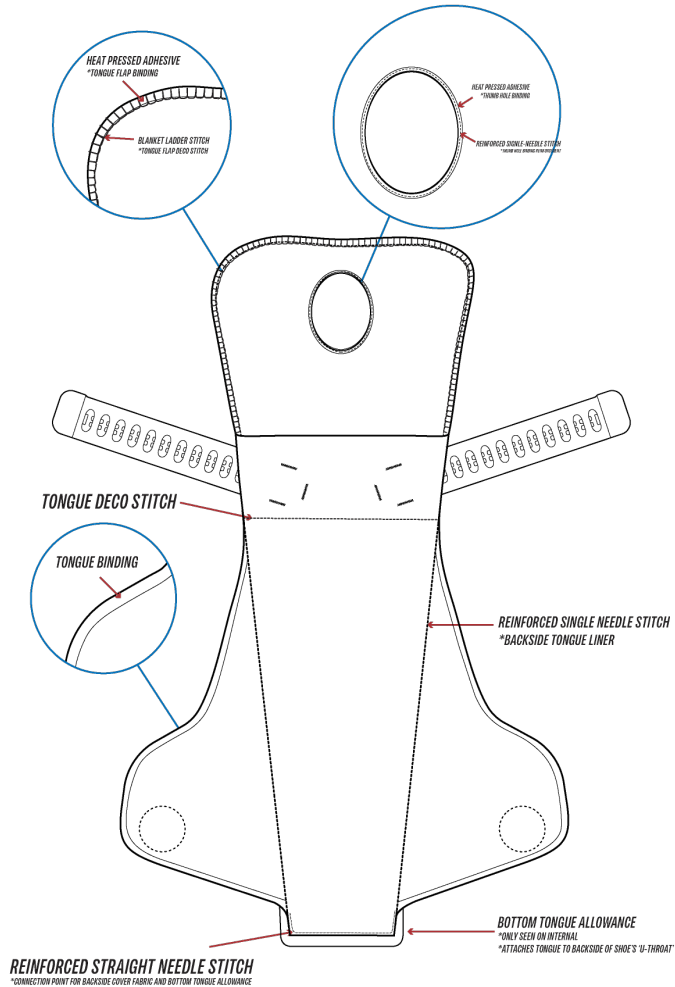

SHOWING FRONTSIDE OF TONGUE

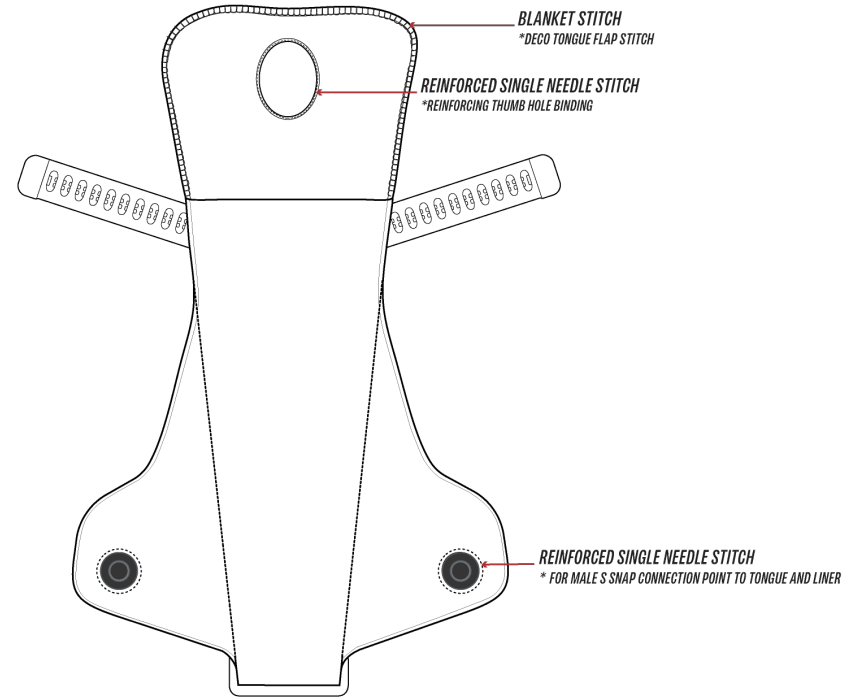

SHOWING BACKSIDE OF TONGUE WITH LINING

- VIEWING HOW MEDIAL/LATERAL STRAP SEW CONNECTION POINTS ARE HIDDEN UNDER LINER
- VIEWING HOW MEDIAL/LATERAL MALE SNAPS ARE SEWN IN *WITH EDGES SEWN AND HIDDEN UNDER TONGUE LINER

TONGUE AND TONGUE FLAP- CONSTRUCTION CALLOUTS

Tongue // Construction Callouts

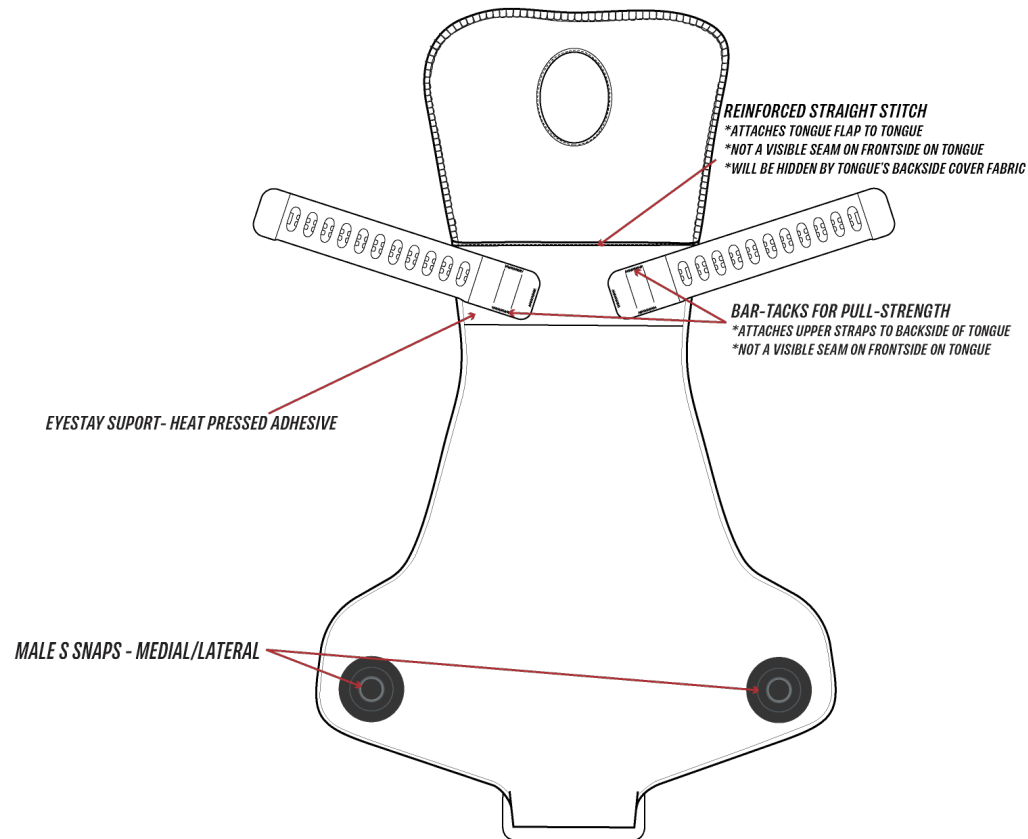

SHOWING BACKSIDE OF TONGUE *WITHOUT TONGUE BACKSIDE LINING

- VIEWING FROM UNDER THE TONGUE'S BACKSIDE LINING
- VIEWING THE SEW CONNECTION POINTS FOR MEDIAL/LATERAL STRAPS
- VIEWING HOW MEDIAL/LATERAL SNAPS ARE NOT YET SEWN IN, JUST PLACED

TONGUE AND TONGUE FLAP- CONSTRUCTION CALLOUTS

Tongue // Measurements

TONGUE BACK VIEWS - MEASUREMENTS

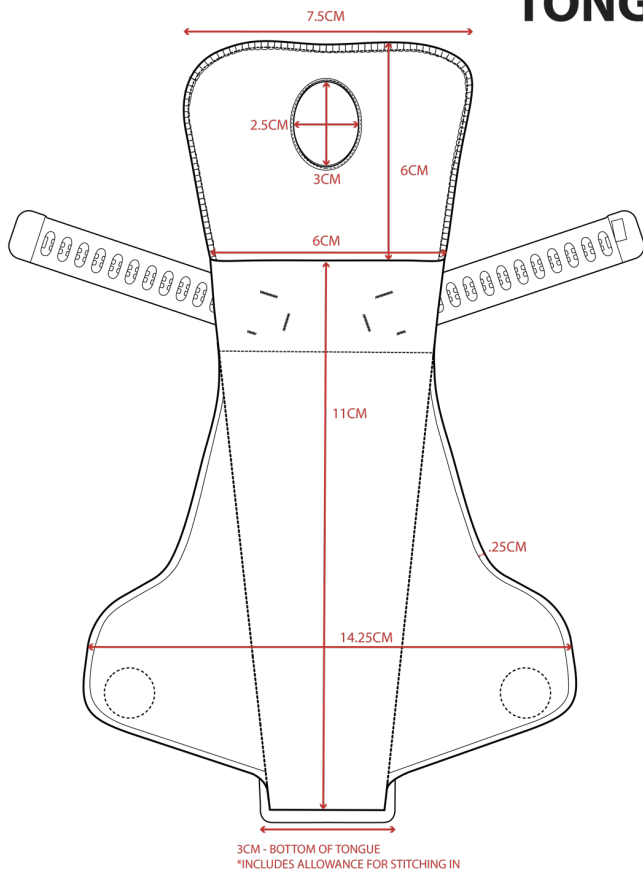

COVER FABRIC ON BACK OF TONGUE
- COVERING THE SEW IN POINTS OF TOP AND BOTTOM TONGUE STRAPS

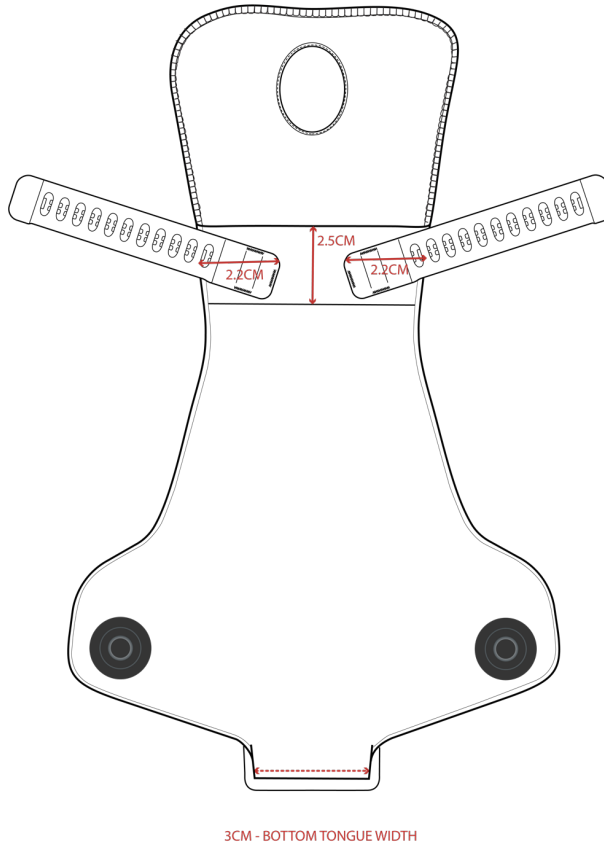

SHOWING HOW TONGUE STRAPS ARE SEWN IN
- VIEWING FROM UNDER THE TONGUE'S BACKSIDE COVER FABRIC

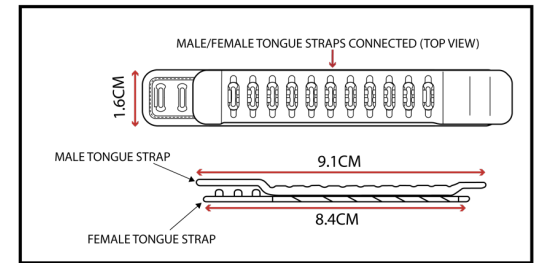

MEDIAL/LATERAL MALE S SNAP SPECS:
 Dimensions (Ø; height) - 27.0 mm; 8.0 mm
 Assembly: sewing
 Punch hole in tongue liner for assembly 17.0 mm
 *IS ATTACHED TO TONGUE (BACKSIDE)

MEDIAL/LATERAL FEMALE S SNAP SPECS:
 Dimensions (Ø; height) - 30,0 mm; min. 8,5 mm
 Assembly: sewing
 Punch hole in tongue liner for assembly -19,6 mm
 *IS ATTACHED TO VAMP/QUARTER
 *GETS SEWN WITH FEMALE S SNAP DECO STITCH WITH
 *EDGES OF SNAP HIDDEN UNDER QUARTER MESH

Tongue // Layering

TONGUE LAYERING

TONGUE



TONGUE EYESTAY SUPPORT
*(SUPPORT FOR TONGUE STRAPS)



TONGUE STRAPS
*(LATERAL AND MEDIAL)



MAGNETS



TONGUE LINING (BACKSIDE)
*CONCEALS UPPER AND LOWER TONGUE STRAPS
*COVERS THE TONGUE AND STRAP SEWN CONNECTION POINTS



Step 1

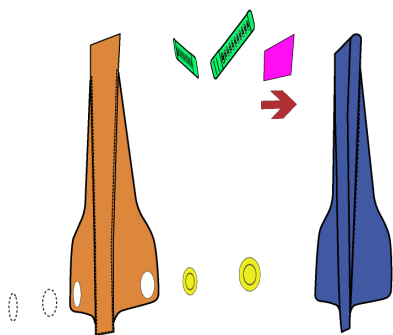

Step 2

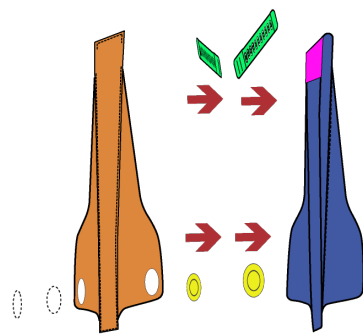

Step 3

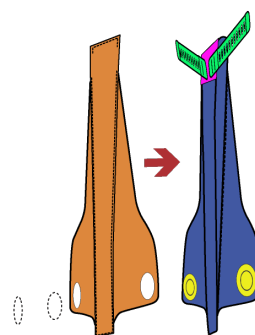

Step 4

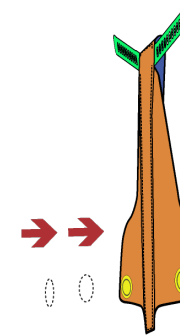

Step 5

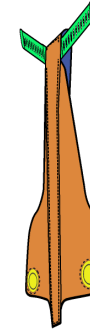

SHOWING BACKSIDE OF TONGUE LAYERS STEP BY STEP

-VIEWING A BACKSIDE PERSPECTIVE OF THE TONGUE, MEDIAL/LATERAL STRAPS & MALE SNAPS, TONGUE LINING, AND MEDIAL/LATERAL MALE SNAP REINFORCED STRIGHT STITCH

Tongue Flap // Layering

TONGUE FLAP LAYERS AND CONSTRUCTION CALLOUTS

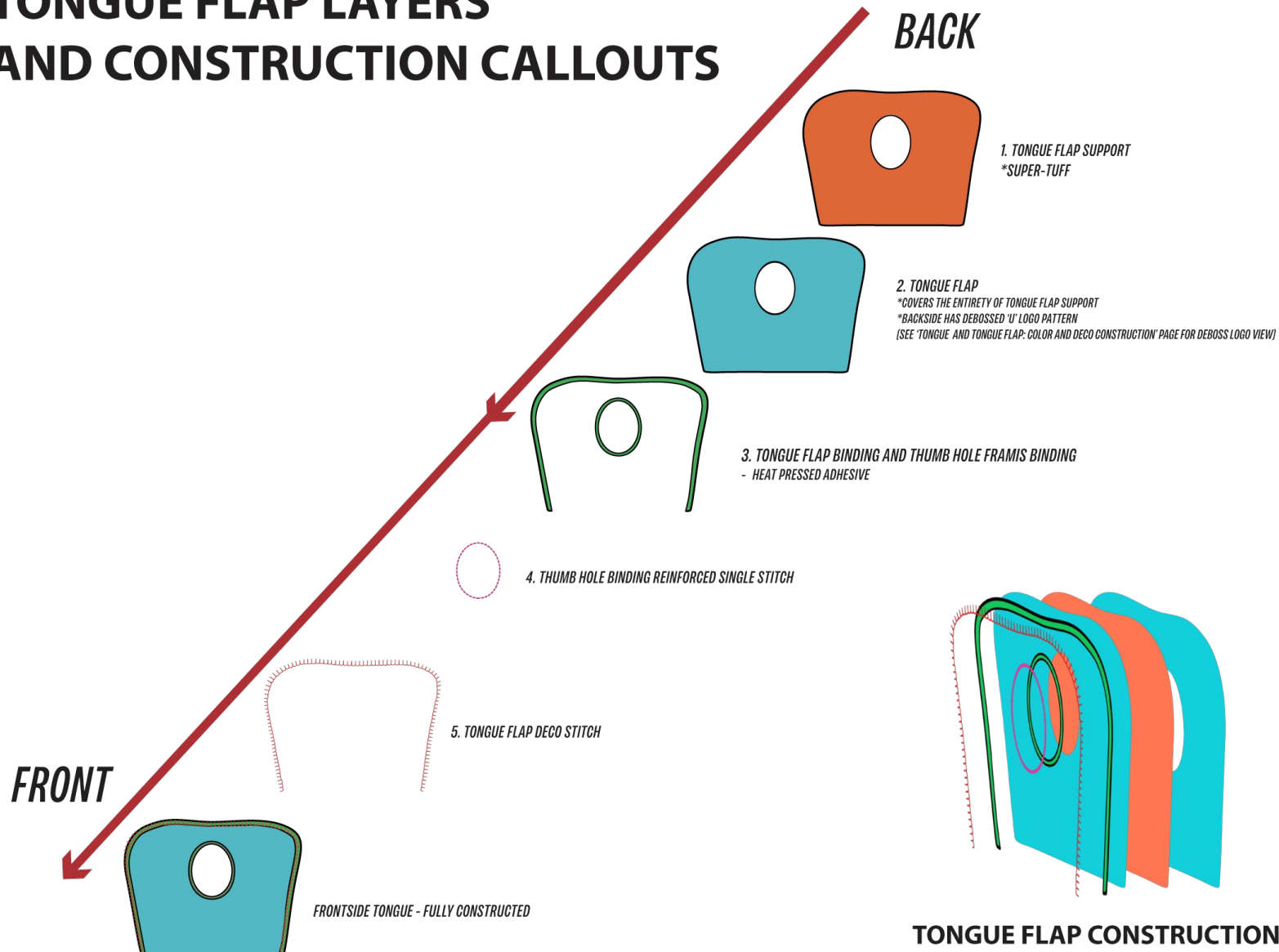

TONGUE FLAP CONSTRUCTION

- SHOWING HOW EACH TONGUE FLAP COMPONENT LAYS AND COMES TOGETHER
- SAME LAYERING FRONT/BACKSIDE OF TONGUE FLAP

Tongue & Tongue Flap // Color & Deco Construction

FRONT SIDE OF TONGUE

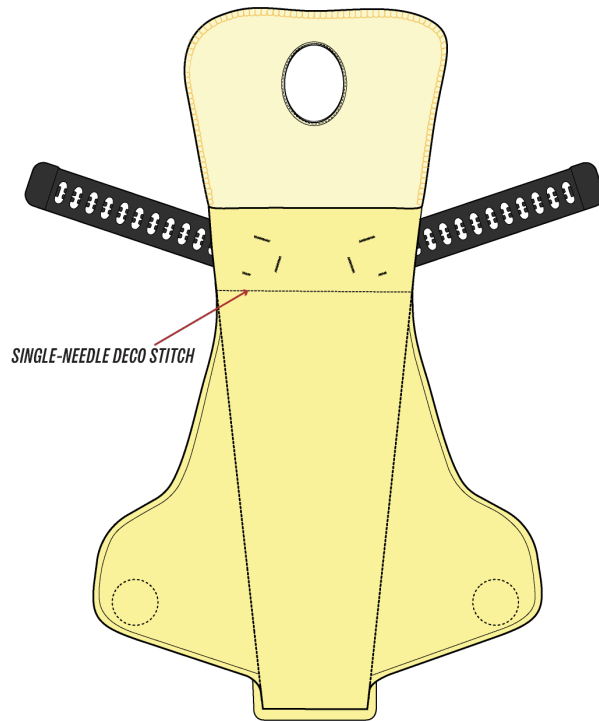

FRONTSIDE OF TONGUE WITH FOLDED TONGUE FLAP

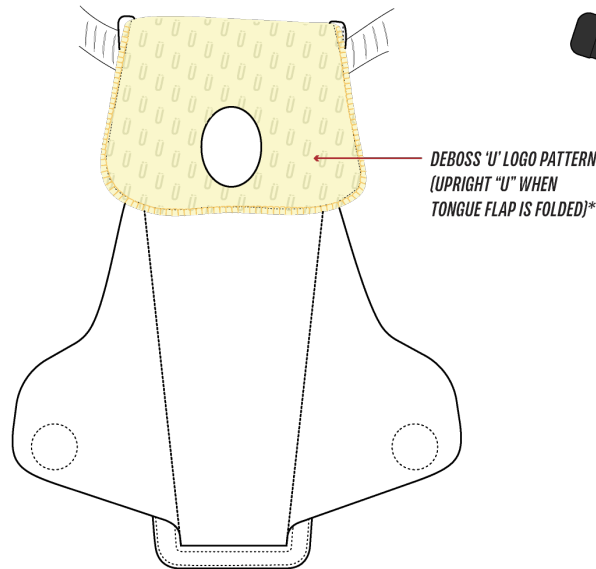

BACKSIDE OF TONGUE

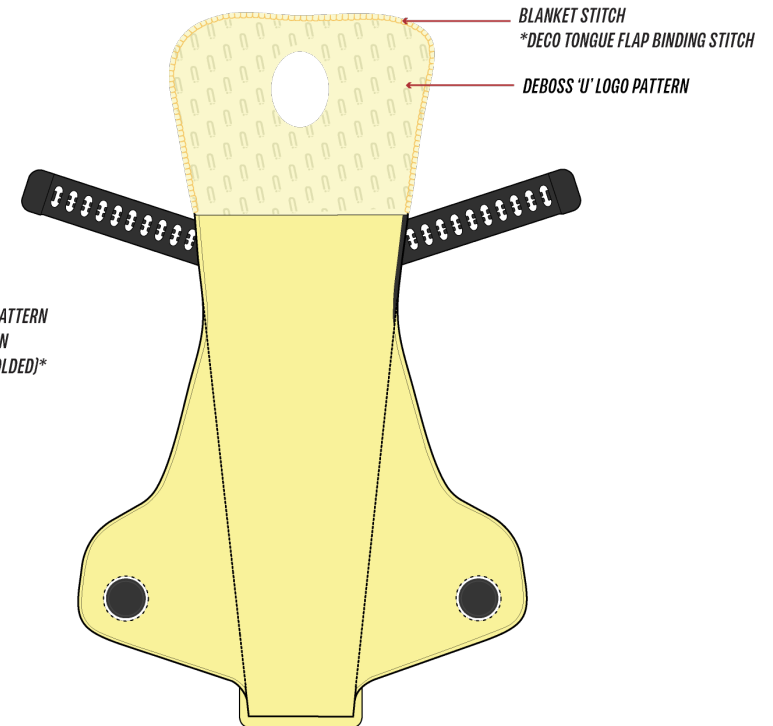

TONGUE AND TONGUE FLAP: COLOR AND DECO CONSTRUCTION

MOMENTÜ

Model: LOMA

Season: SPRING 25

Date: 3/5/24

Style Code: 092350

Colorway: BLUEBERRY SUNSHINE

Revision: A

Sample Size: W8

Factory Name: MY SAMPLE FACTORY

Shell Pattern

Page 23

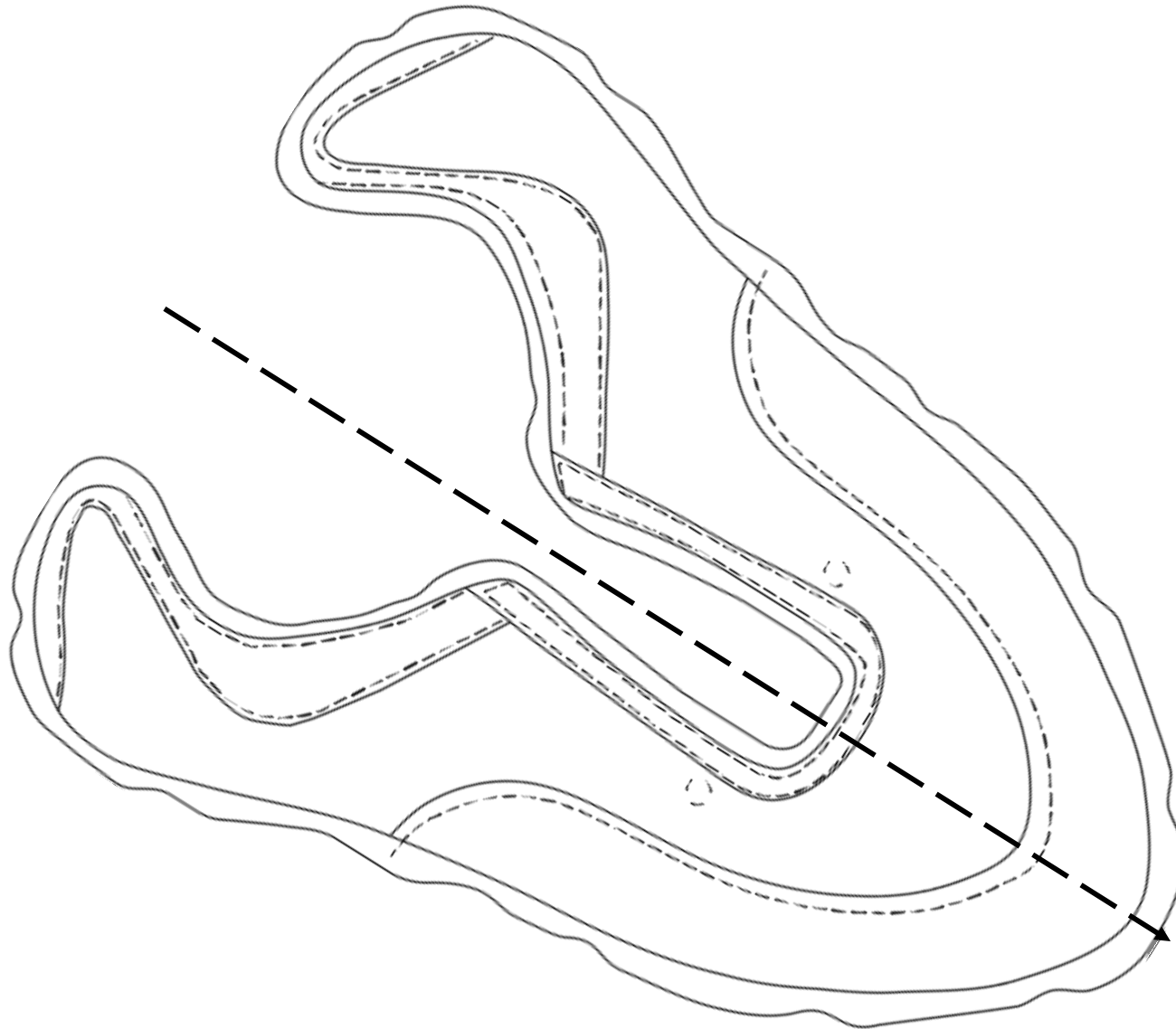

Measurements

LEFT SHOE - LATERAL VIEW (TONGUE UP) MEASUREMENTS

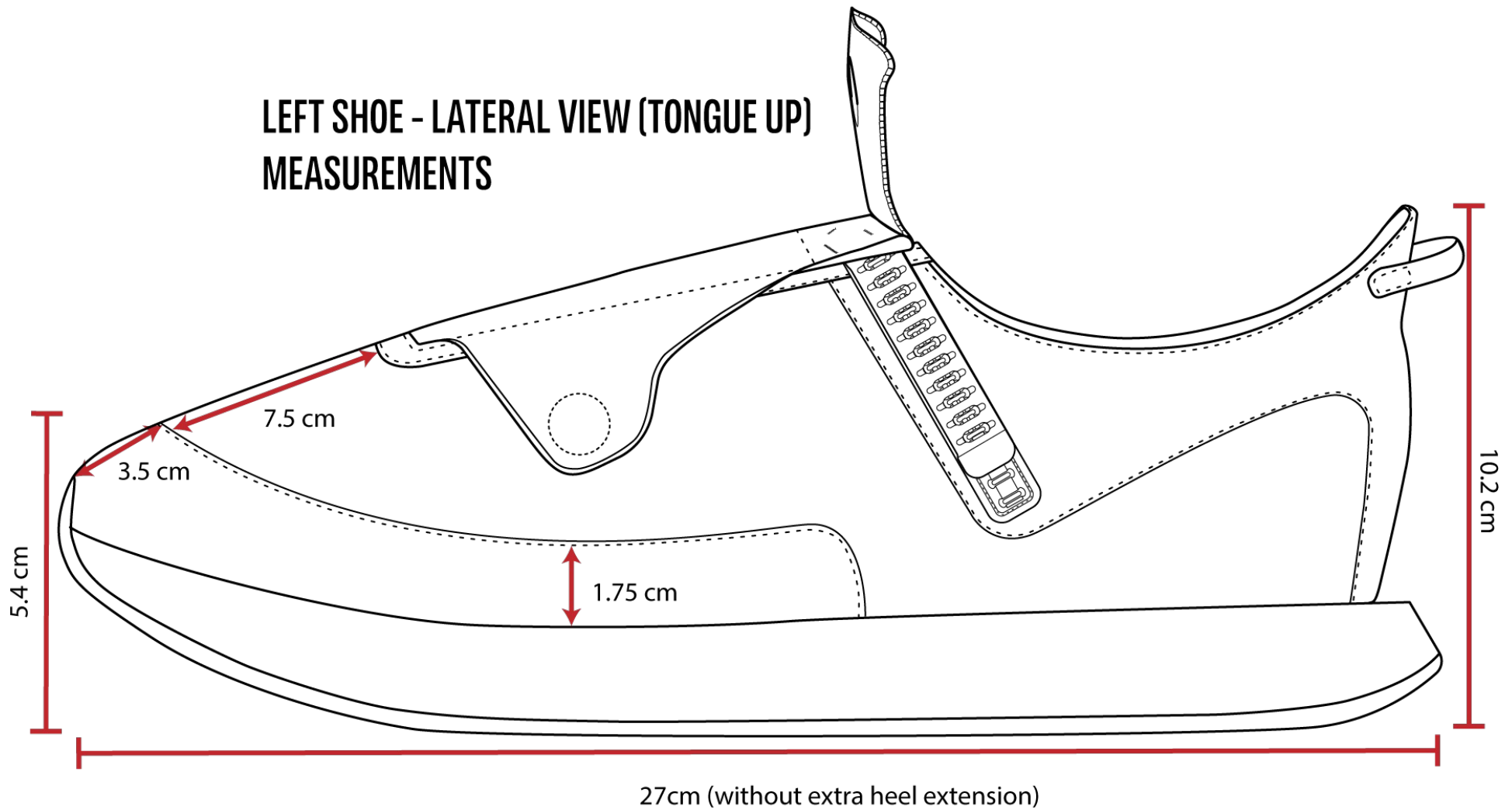

Measurements

HEEL VIEW MEASUREMENTS

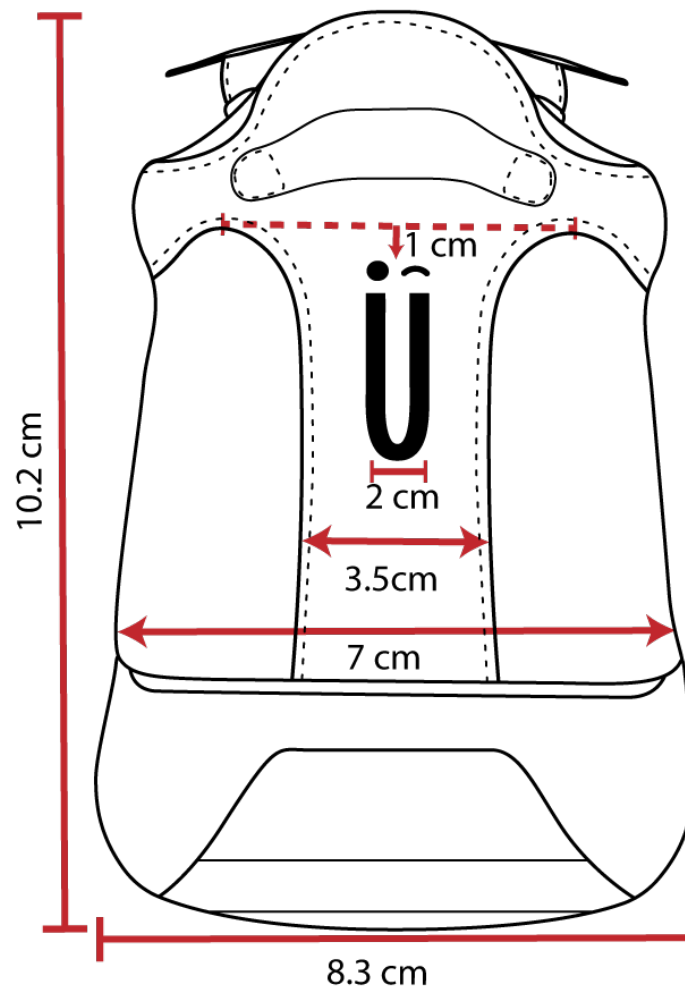

Tooling

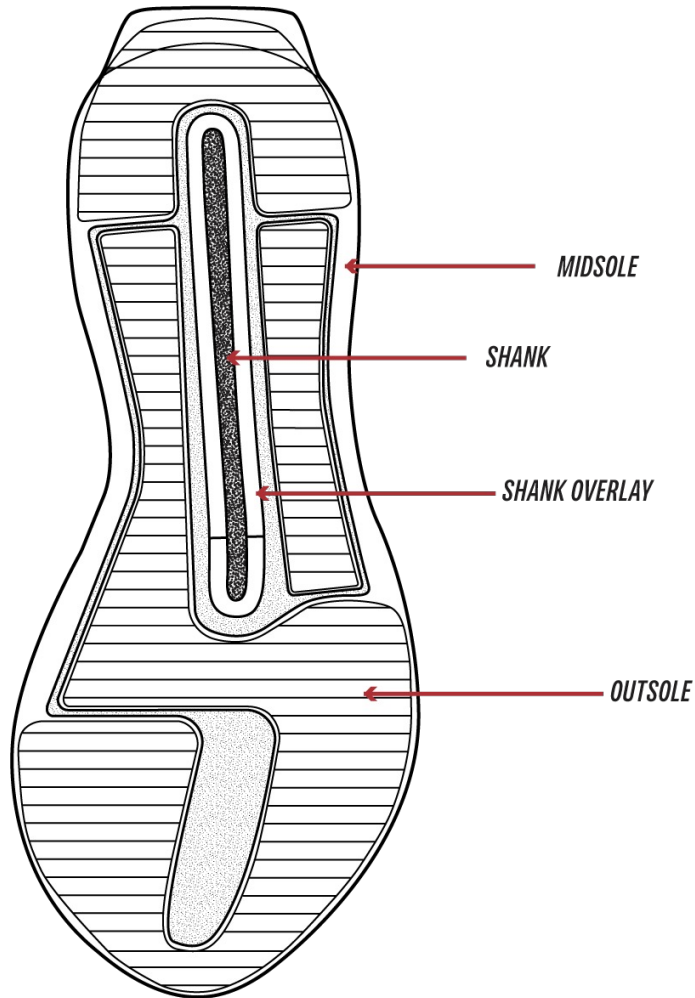

**BOTTOM VIEW
COMPONENT CALLOUTS**

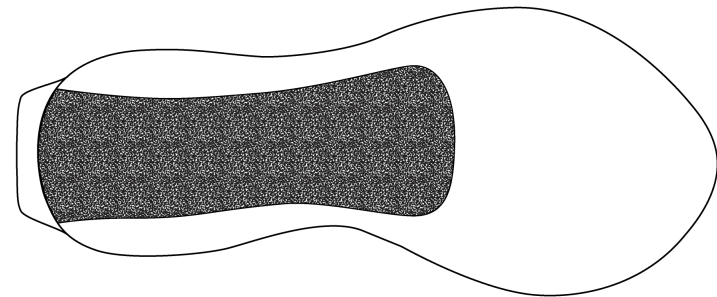

LEFT SHOE - INTERNAL 3/4 SHANK VIEW

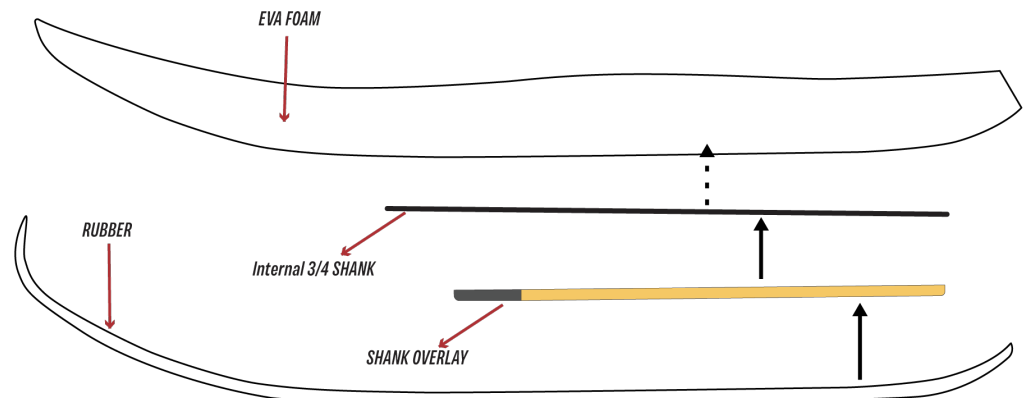

LATERAL EXPLODED VIEW

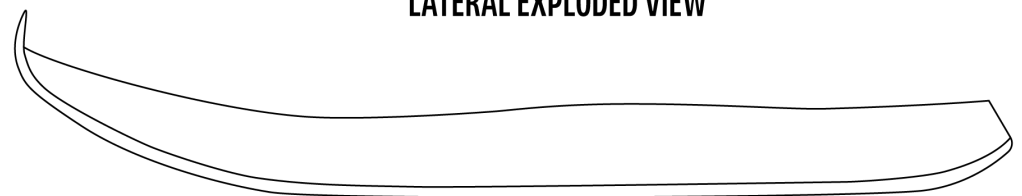

LATERAL VIEW

MOMENTÜ

Model: LOMA

Season: SPRING 25

Date: 3/5/24

Style Code: 092350

Colorway: BLUEBERRY SUNSHINE

Revision: A

Sample Size: W8

Factory Name: MY SAMPLE FACTORY

Factory Tooling

Page 27



PLEASE USE SUGGESTED TOOLING

STANDARD SOCK LINER

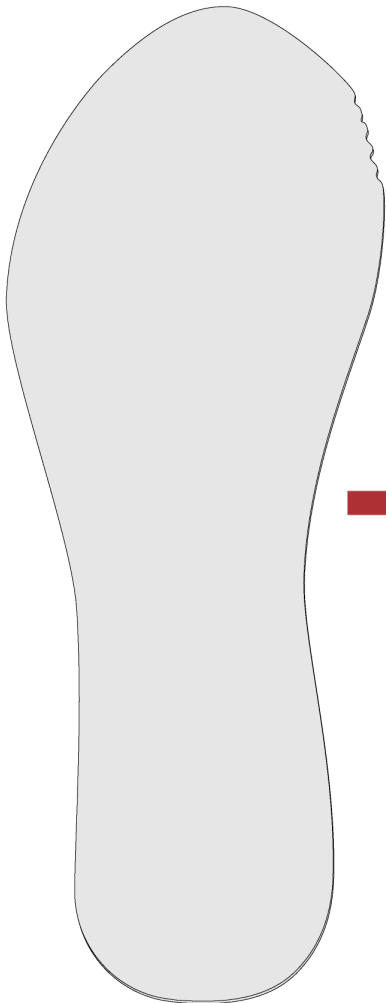

SOCK LINER GRAPHIC

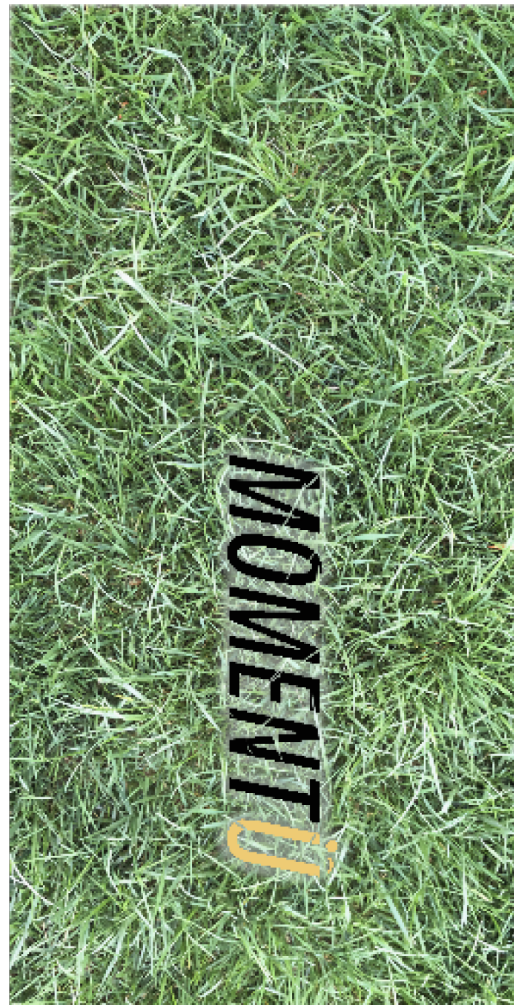

SUBLIMATED SOCK LINER



2.54 CM FROM CENTER OF HEEL

Reference Images - Construction

TOP VIEW - CONSTRUCTION CALLOUTS

DESIGN INSPO: THE WAY THE TONGUE LOOKS FROM A TOP VIEW WHEN FOLDED DOWN.



-DESIGN INSPO: TIP OVERLAY POSITIONING ONTO THE VAMP/QUARTER

-OUR SHOE DOESN'T HAVE SAME TIP OVERLAY DESIGN, BUT RISES ON TO THE VAMP/QUARTER IN A SIMILAR WAY

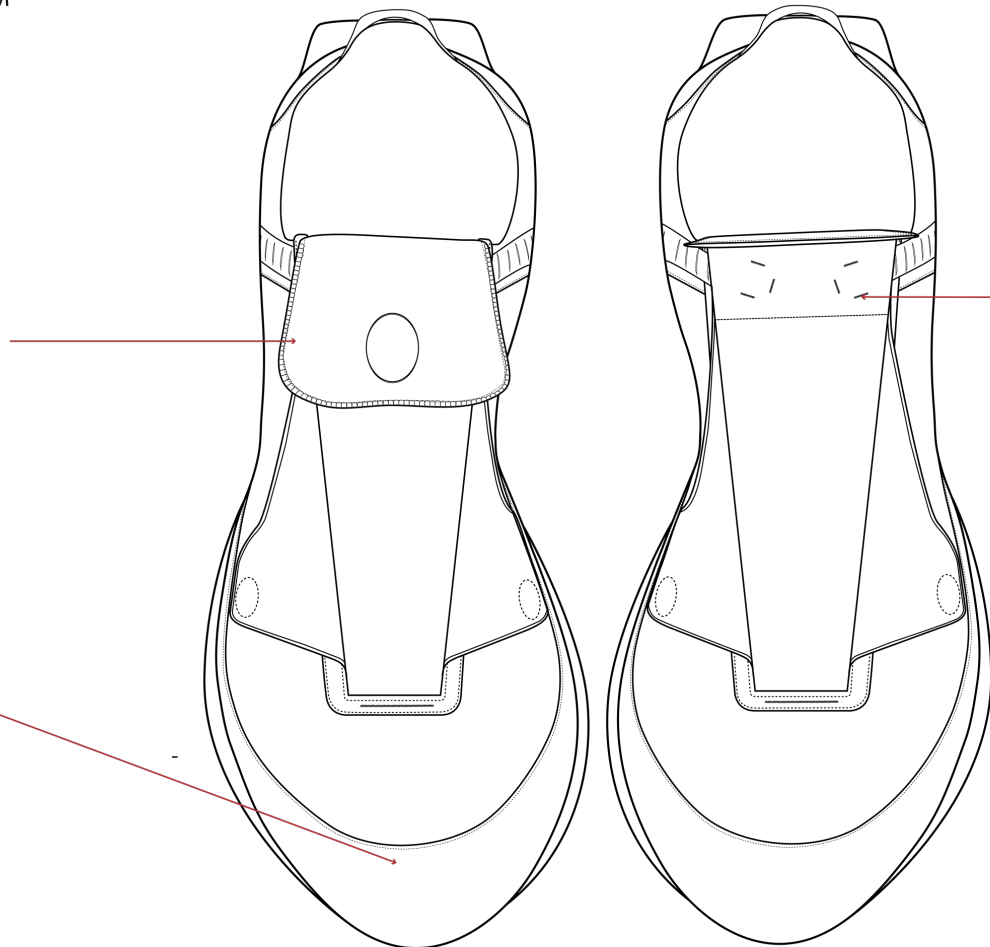

Reference Images - Construction

LEFT SHOE - LATERAL VIEW (TONGUE UP)
CONSTRUCTION CALLOUTS

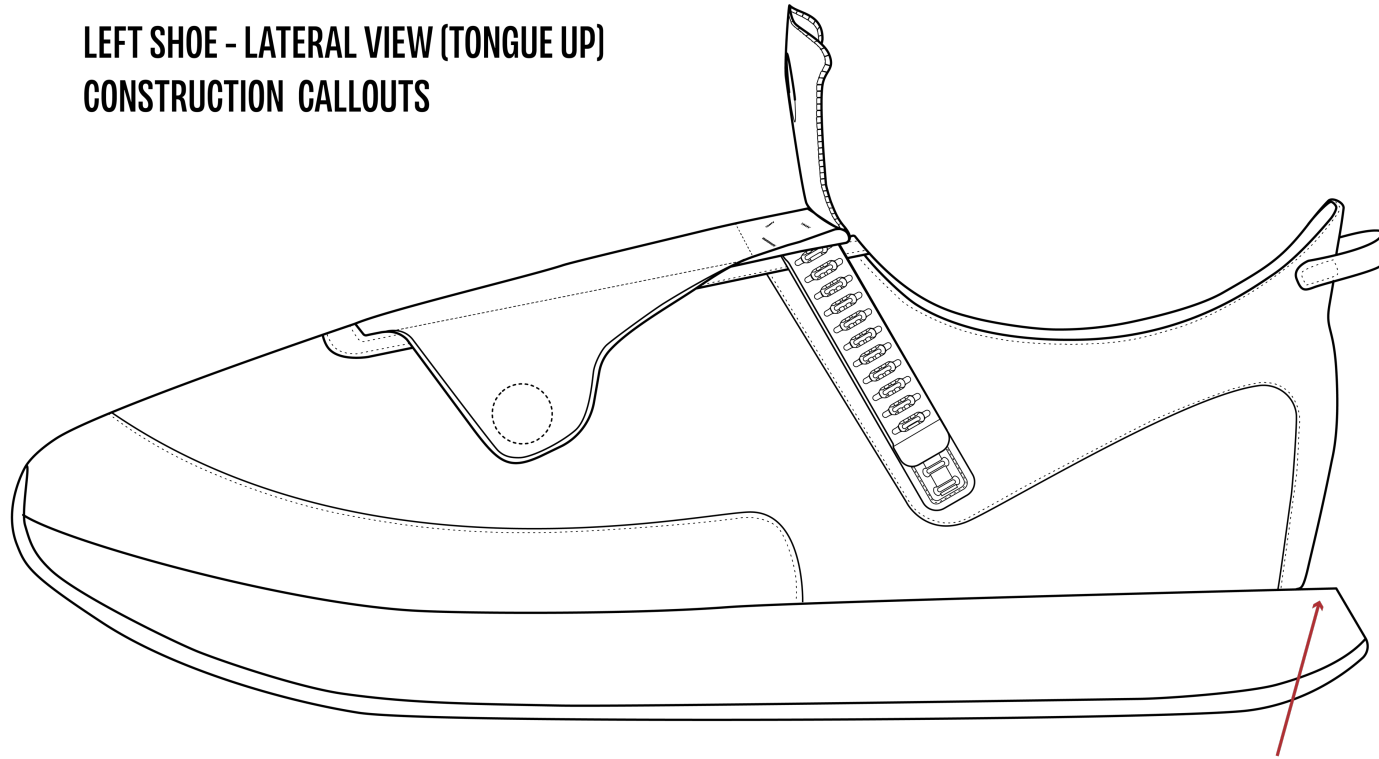

- DESIGN INSPO: THE EXTENSION OF MIDSOLE
- WILL HAVE SIMILAR CONSTRUCTION AND BE USED TO HELP KICK SHOE OFF WITH FOOT



Model: LOMA	Season: SPRING 25	Date: 3/5/24
Style Code: 092350	Colorway: BLUEBERRY SUNSHINE	Revision: A
Sample Size: W8	Factory Name: MY SAMPLE FACTORY	

Reference Images - Construction



- DESIGN INSPO: THE WAY THE TONGUE LAYS ON TOP OF THE EYESTAYS



- DESIGN INSPO: THE WAY THE TONGUE FLAP LAYS AND FOLDS ON TO TONGUE BASE

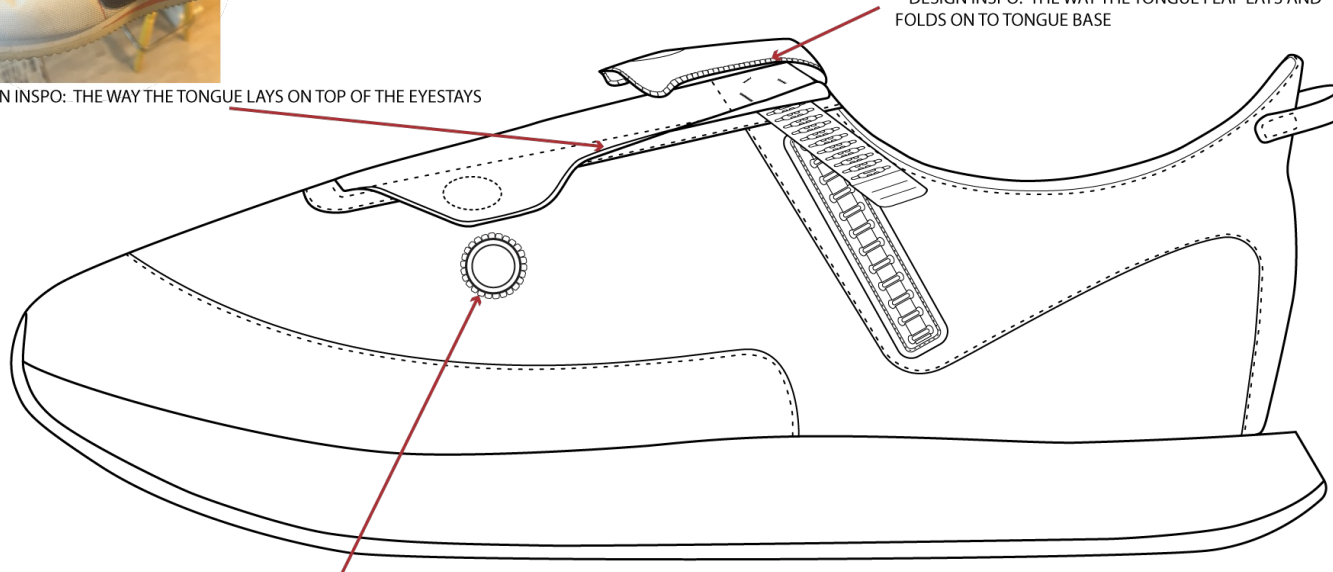

- DESIGN INSPO: THE FLOWERS INSPIRED THE DECO STITCHING FOR THE FEMALE S SNAPS.
- THE DECO STITCHING USED TO SECURE THE FEMALE S SNAPS SHOULD RESEMBLE THE PETALS
- THE FEMALE S SNAP AS THE FLOWER'S CENTER.



**LEFT SHOE - LATERAL UNDER TRIM VIEW (TONGUE FOLDED)
CONSTRUCTION CALLOUTS**

TONGUE AND TONGUE FLAP: COLOR AND DECO CONSTRUCTION



- DESIGN INSPO: DECO STITCHING FOR TONGUE FLAP
- SHOULD LOOK VERY SIMILAR TO THIS REFERENCE IMAGE
- ADDITIONALLY, SHOULD RESEMBLE THE PETAL DECO STICTHING OF OUR SHOE'S FEMALE S SNAPS

FRONTSIDE OF TONGUE WITH FOLDED TONGUE FLAP

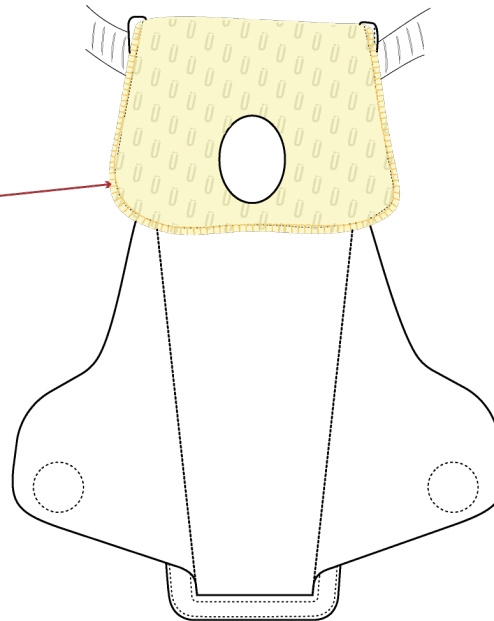

BACKSIDE OF TONGUE

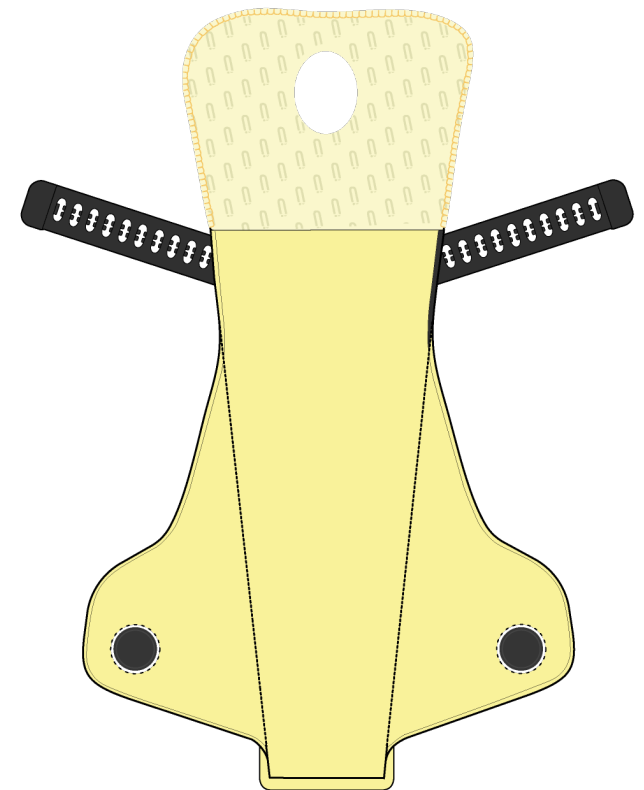

Model: LOMA	Season: SPRING 25	Date: 3/5/24
Style Code: 092350	Colorway: BLUEBERRY SUNSHINE	Revision: A
Sample Size: W8	Factory Name: MY SAMPLE FACTORY	

Reference Images – Care Content Label

LOMA INTERNAL CARE CONTENT

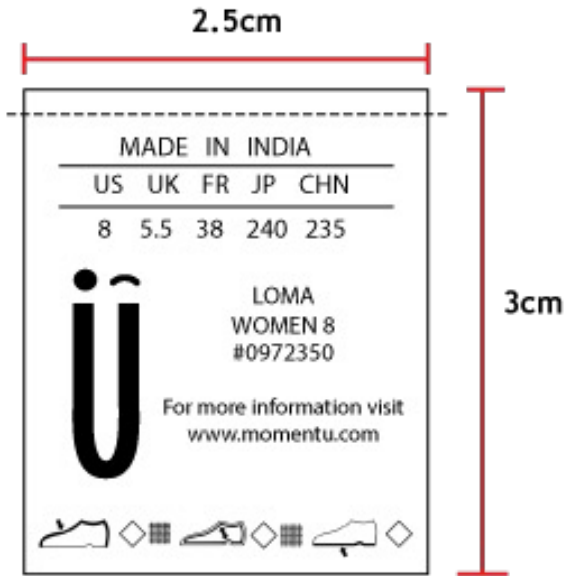

INTERNAL CARE CONTENT LABEL PLACEMENT MEDIAL VIEW (TONGUE FOLDED)

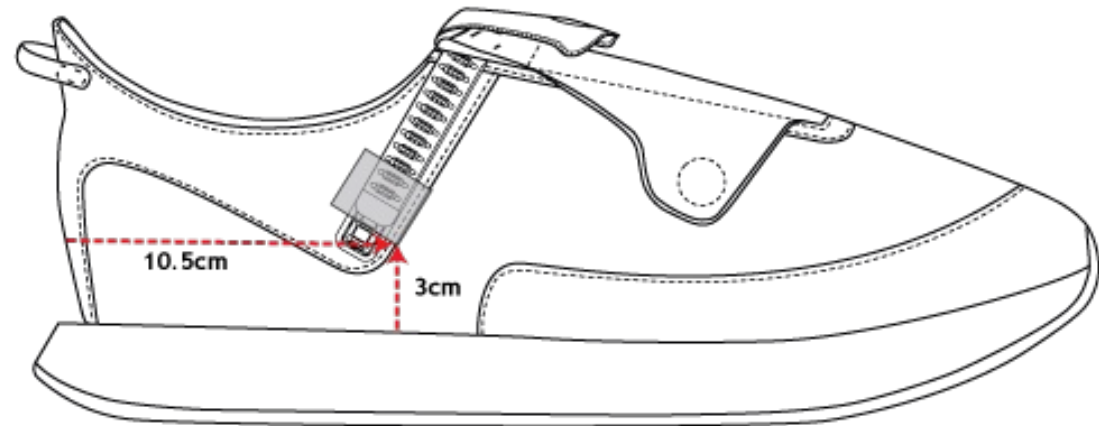

Top of care content label will be stitched along internal heel lining seam on medial side with text facing toward internal lateral side



Reference image for care content placement and construction

Color Information

SWATCH
COLOR

PANTONE NAME
HEX CODE



PANTONE P 139-4 C
#96CA9A



PANTONE 9120 C
#F1EFB7



PANTONE REFLEX BLUE U
#39499c



PANTONE 600 U
#F9F29D



BLACK
#000000



PANTONE 141 C
#F2C763



WHITE
#FFFFFF

Bill of Materials

ID#	Part Type	Component	Material	Mtl. Comment	Color	Comments	Vendor	Qty/Pair
UPPER								
1	Upper	Tip Overlay	Bio-Based TPU	0.25mm	Pantone 600 U	Suede-like hand	Mahalaxmi Overseas	2
2	Upper	Vamp/Quarter	Mesh	65% polyester, 35% nylon, 495 GSM	Pantone 9120 C	400-500 GSM preferred	Greatex Synthetics	2
3	Upper	U-Throat	Bio-Based TPU	0.5mm	Pantone 600 U	Suede-like hand	Mahalaxmi Overseas	2
4	Upper	Tongue	Air Mesh	100% Polyester, 500 GSM	Pantone 600 U	Same pattern as Tongue Flap	Trustknit Private Limited	2
5	Upper	Tongue Foam	Open Cell PU KFF Foam	7.5mm, 1lbs density	Pantone 9120 C	Material is cut to be tapered down to 2.5mm at end of length. Leave exposed as specified in tech pack.	Shri Adinath Exports	2
6	Upper	Tongue Lining	ZurichMicro 4 Way Knit	92% Polyester, 8% Spandex, 220 GSM	Pantone 600 U		Joyous Trendz Limited	2
7	Upper	Tounge Binding	Framis, art. 7219, Panarea	16 mm	Pantone 600 U			
9	Upper	Lateral Female S Snap	PA6, PA66GF15	Size S, Sewable	Black	Use Stock if available	Fidlock	2
10	Upper	Medial Female S Snap	PA6, PA66GF16	Size S, Sewable	Black	Use Stock if available	Fidlock	2
11	Upper	Female S Snap Lateral Deco Stitch	Coats Dual Duty EcoVerde	8 Wt., Open Chain Stitch	Pantone 141 C		Coats	
12	Upper	Female S Snap Medial Deco Stitch	Coats Dual Duty EcoVerde	8 Wt., Open Chain Stitch	Pantone 141 C		Coats	
13	Upper	Magnet		Sewable, 3 cm x 3 cm, 1.5 cm diameter				8
15	Upper	Lateral Tongue Strap	GN 201A TPU Strap		Black	2-part strap	Nifco	2
16	Upper	Medial Tongue Strap	GN 201A TPU Strap		Black	2-part strap	Nifco	2
18	Upper	Tongue Flap	Air Mesh	100% Polyester, 250 GSM	Pantone 9120 C	Same pattern as Tongue	Trustknit Private Limited	2
19	Upper	Tongue Flap Support	Super-Tuff	0.05mm		Internal		2
20	Upper	Tounge Flap Binding	Framis	Smooth, Matte,	Pantone 9120 C			
21	Upper	Tounge Flap Deco Stitch	Coats Dual Duty EcoVerde	8 Wt., Blanket Stitch	Pantone 141 C		Coats	

Model: LOMA	Season: SPRING 25	Date: 3/5/24
Style Code: 092350	Colorway: BLUEBERRY SUNSHINE	Revision: A
Sample Size: W8	Factory Name: MY SAMPLE FACTORY	

Bill of Materials

ID#	Part Type	Component	Material	Mtl. Comment	Color	Comments	Vendor	Qty/Pair
22	Upper	Thumb Hole Binding	Framis	Smooth, Matte,	Pantone 9120 C			
23	Upper	Thumb Hole Reinforcement Stitch	Single Needle		Pantone 9120 C			
24	Upper	Tongue Logo Pattern	Deboss	MomentÜ Smiley Face logo		Shown when flap is folded down	In Factory	2
25	Upper	Heel	0.5mm Bio-Based TPU		Pantone 600 U		Mahalaxmi Overseas	2
26	Upper	Heel Logo	Deboss			MomentÜ Smiley Face logo	In Factory	2
27	Upper	Heel Pull Tab	10mm Nylon Webbing		Pantone Reflex Blue U	Use Stock if available	Western Fashion Accessories	2
28	Upper	Heel Counter	Molded Surlyn Plastic Fiber Board	1mm		Internal	Trinity	2
29	Upper	Collar Lining	ZurichMicro 4 Way Knit	92% Polyester, 8% Spandex, 220 GSM	Pantone Reflex Blue U		Joyous Trendz Limited	2
30	Upper	Collar Foam	Open Cell PU KFF Foam	7.5mm, 1lbs density			Shri Adinath Exports	2
31	Upper	Sock Liner	Generic Sockliner		Pantone Reflex Blue U		Factory	2
32	Upper	Sock Liner Wordmark	Screen Print		Refer to tech pack	MomentÜ Smiley Face workmark	In Factory	2
33	Upper	Strobel	Stitch bonded polyester	1mm, 200 GSM		Internal	Dynamic Wool Tex	2
34	Upper	Heel Foam	Open Cell PU KFF Foam	7.5mm, 1lbs density		Internal	Shri Adinath Exports	2
35	Upper	Thread	Bonded nylon M8	400D	Tonal		Coats Thread	1
36	Upper	Medial Info/Size Tag			Per Callout	Internal		
MIDSOLE								
36	Midsole	Midsole	EVA Foam	150g	White		Leather Shoe Tech	2
37	Midsole	Shank	Carbonfiber shank				Vaishnavi Sourcing	1
38	Midsole	Shank Overlay	PU Plastic		Black/Pantone 141 C		Komal Enterprises India	2
OUTSOLE								
39	Outsole	Outsole	Rubber	10mm	Pantone P 139-4C		Sameko Industries	2



Model: LOMA	Season: SPRING 25	Date: 3/5/24
Style Code: 092350	Colorway: BLUEBERRY SUNSHINE	Revision: A
Sample Size: W8	Factory Name: MY SAMPLE FACTORY	

Document Revision Notes **Page 37**

Rev	Date	Name	Notes
A	3/5/2024	MOMENTU	



THANKÜ

Emily Cook – Kyle Keenan – Jordan Lee – Jalen Niles – Josh Reich – Zach Sanwick