

TOSHIBA



SMMS 
SUPER MODULAR MULTI SYSTEM



INDEX

SMMS-e features Energy saving

Capacity range	4
SMMS wave tool	6
DC twin-rotary compressor	8
Heat exchanger	9
Piping design flexibility	10
Slimmer pipe size	12
Fan Design & E.S.P.	13
Reliability	14
VRF AHU Connectivity	15

Outdoor units

Outdoor units line-up	16
Outdoor units specifications	16
Outdoor units external view drawings	21

Safety precautions	24
---------------------------	-----------



Toshiba solutions

At Toshiba, we believe that "Evolution is leading the path to a better future". Through the decades, we have been constantly creating innovative and high-quality electrical appliances to increase our consumers' satisfaction. Now, with Toshiba "SMMS-e", the latest commercial air conditioning for various buildings,

The SMMS-e has been creatively developed and designed under the concept Excellence, Expansion, and Experience to ensure your utmost comfort and convenience like never before.

With the latest technology improved and developed to make SMMS-e the top commercial air conditioning for any solution that intelligently meets your needs, Toshiba will stop at nothing to create innovation to evolution of the future, where life is a step away from perfection.

TOSHIBA

SMMS
SUPER MODULAR MULTI SYSTEM

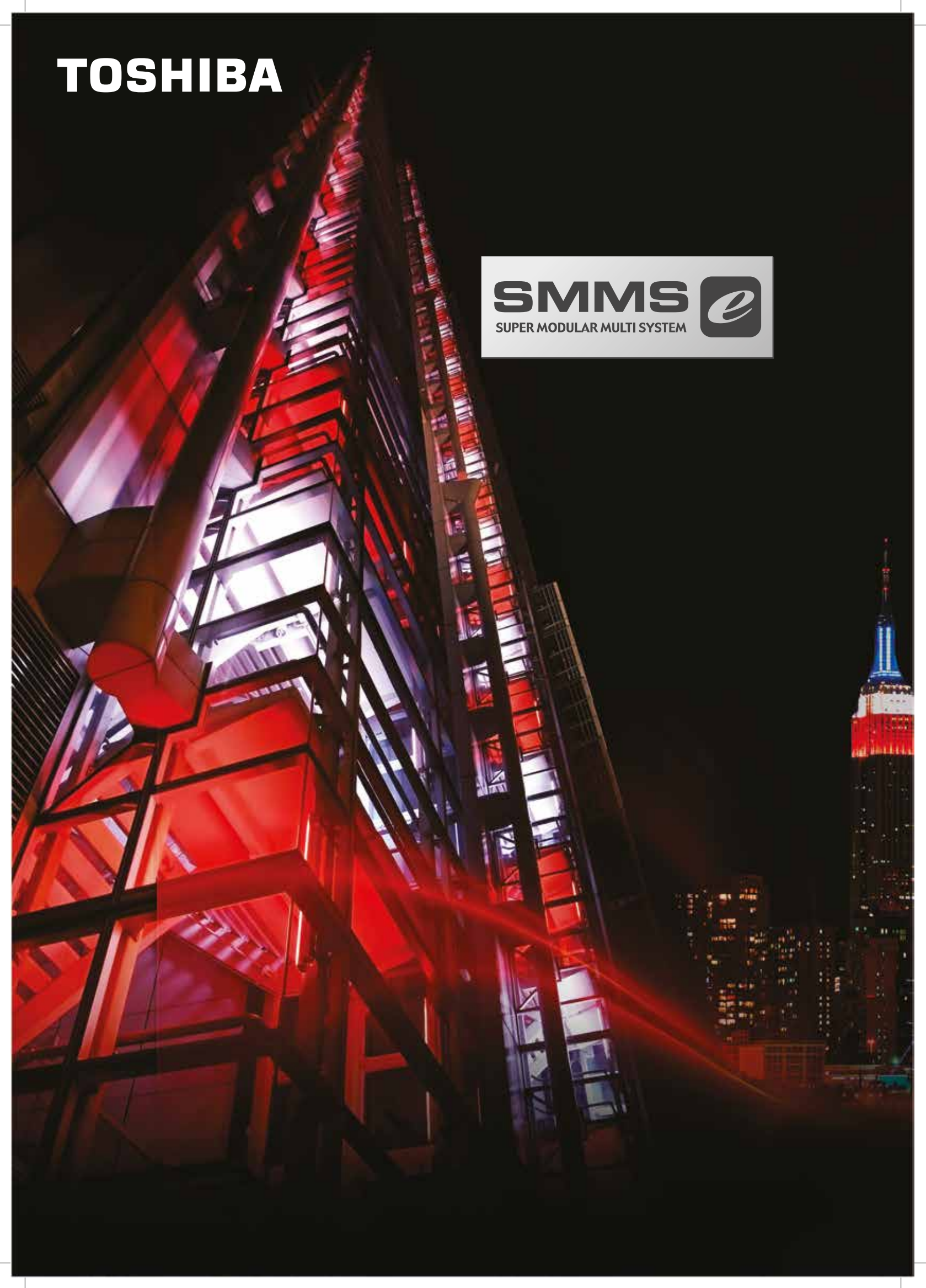

Air Conditioning for large buildings

EXCELLENCE

EXPANSION

EXPERIENCE





CAPACITY RANGE

Single unit capacity expanded

SMMS-e comes with 3 new larger capacity units, producing up to 22HP on a single module platform.



Industry-leading installation flexibility

Outdoor units improve performance to achieve greater space efficiency that defies their compact module size to deliver greater freedom in layout design. This minimizes weight-related restrictions and allows for quicker installation.

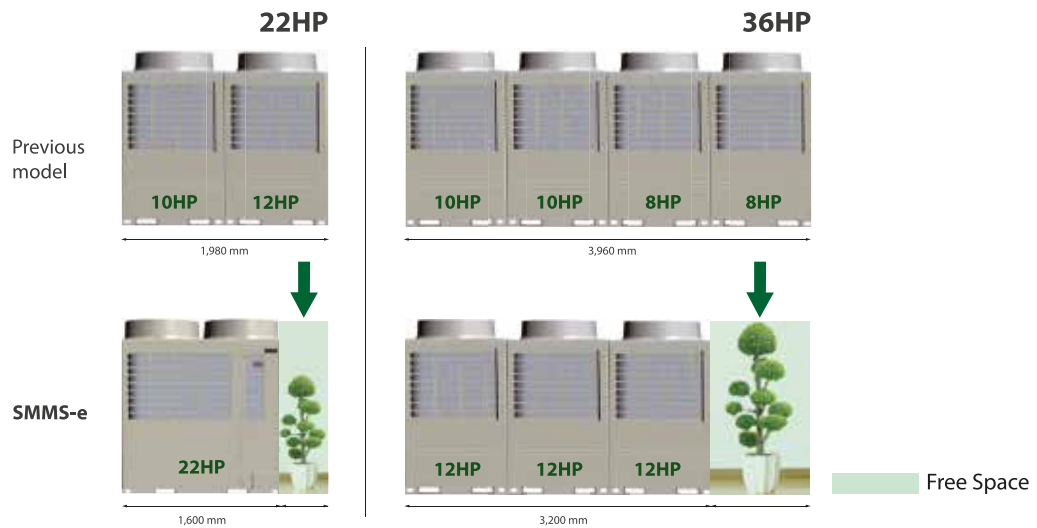



System capacity expanded

With the SMMS-e, it is now possible to connect up to 60HP in one system, with up to 64 connectable indoor units.

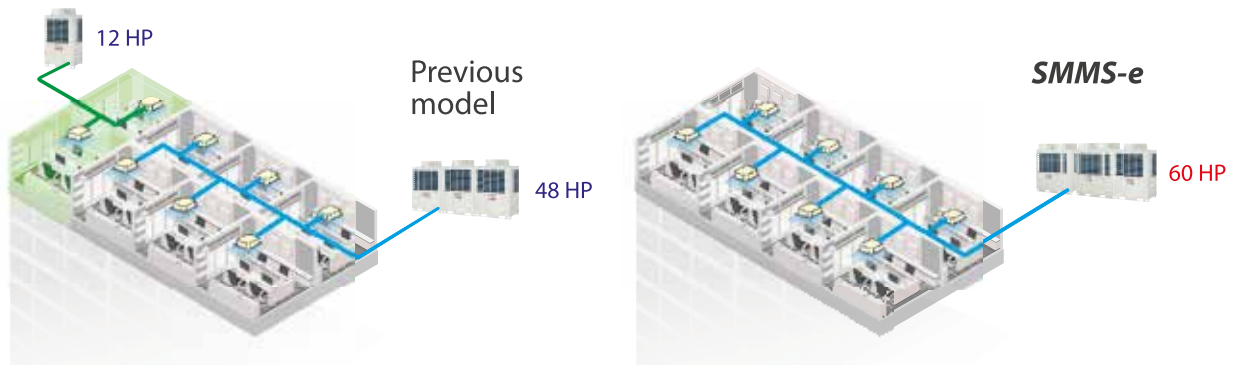

Installation flexibility

While expanding the maximum combination from 48 to 60HP in one system. This helps save more time and expense on additional unit system required in the previous model. The new compact unit design also increases more flexibility on installation with less foot print.

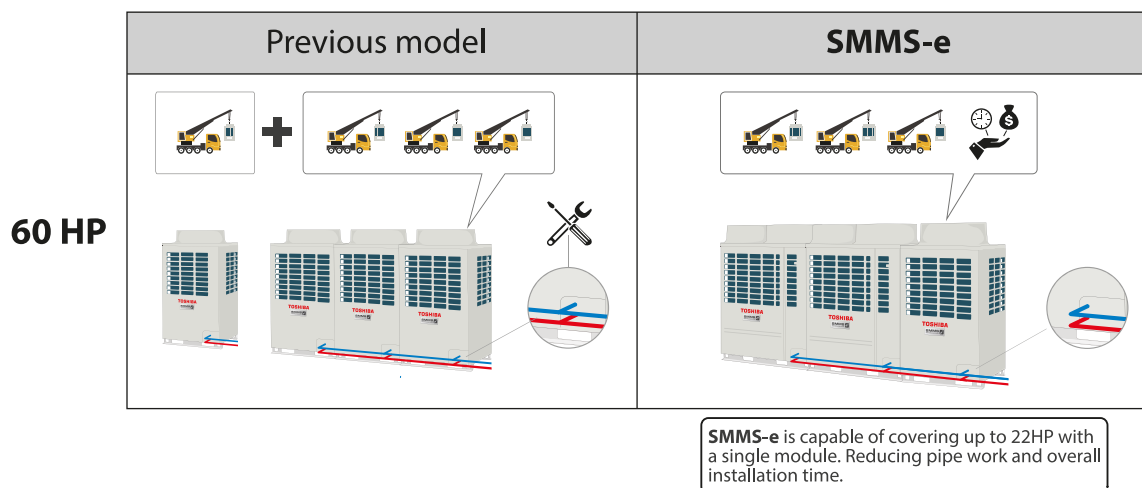

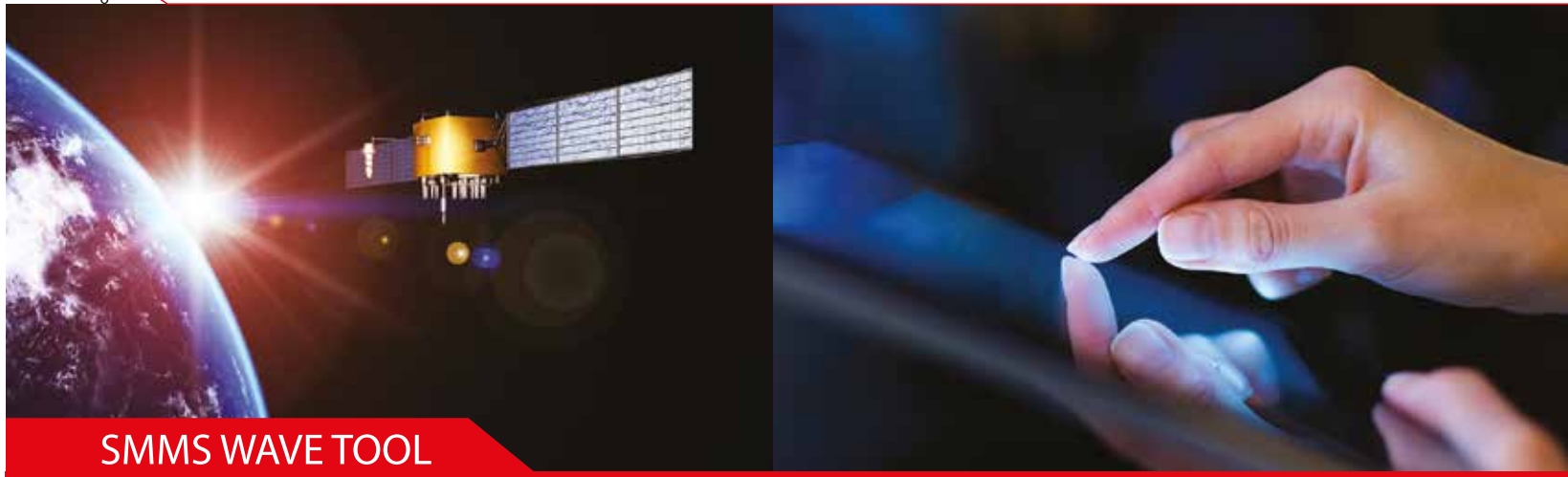

SMMS wave tool

With SMMS wave Tool, you can read and write data from outdoor unit directly on your smart phone without the needs of connecting PC or opening cabinet.

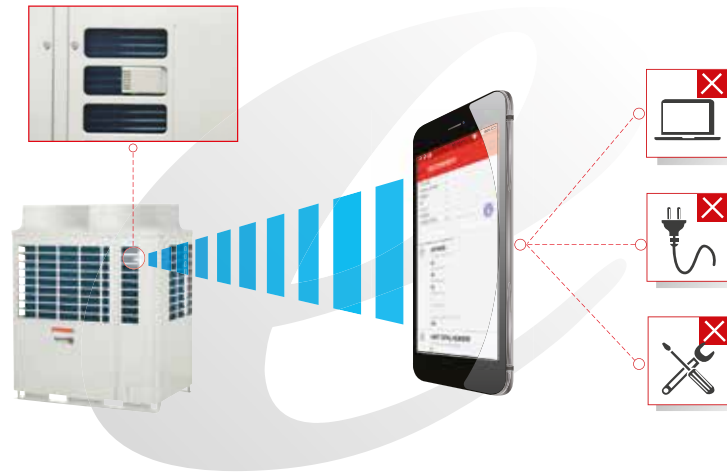

By the new smart phone application, the testing and commissioning can be done without opening the cabinet.



* Smartphone specification with NFC : Android TM OS 5.0

Available data

Whether the product data, system data, fault history or testing and commissioning, all can be obtained easily even in case of under service maintenance or power failure. The data can be easily sent to the distant office via email. Possible to receive system data by e-mail without moving from your office and the operation conditions can be checked in the office.

In case of below situation

- ✓ Installation
- ✓ Service maintenance
- ✓ Power failure

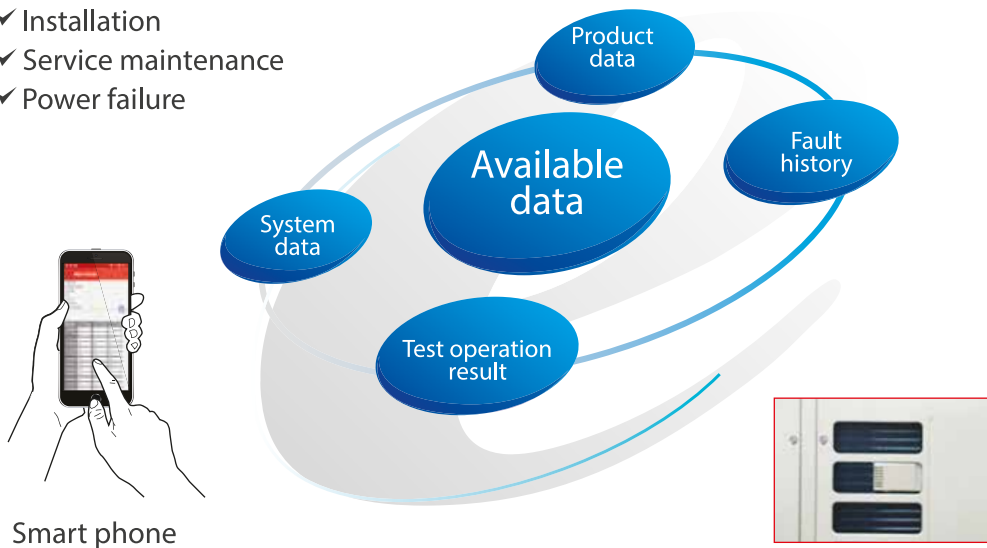

Smart phone



The Site

The office





DC TWIN-ROTARY COMPRESSOR

Wide range compressor

More powerful and efficient with the cutting-edge technology of compressor – DC Twin-Rotary operates in wider range of rotation speed.

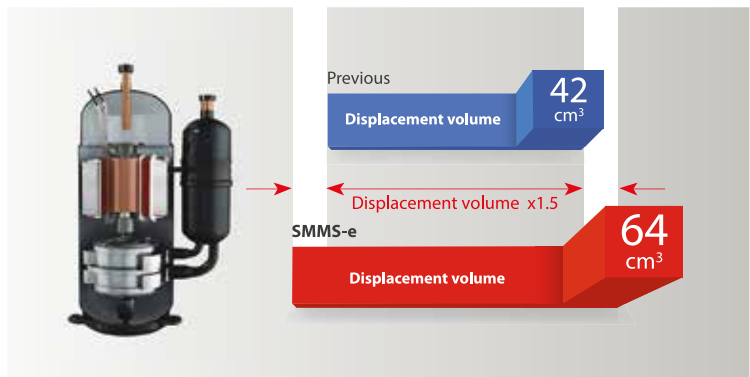

DLC coated vane

Increased hardness of the DLC coated vane reduces friction and increase both reliability and performance.

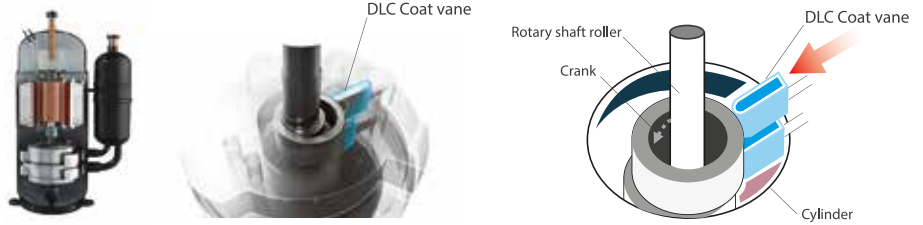

* DLC: Diamond Like Carbon

2-stage vane

With 2-stage vane innovatively designed to reduce friction while increasing hardness and enhancing performance at its best.

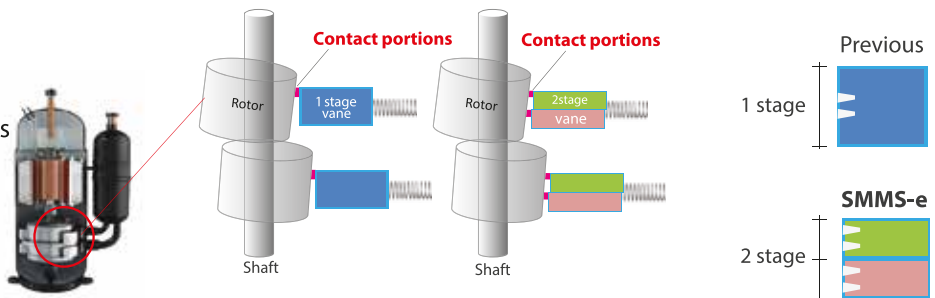



HEAT EXCHANGER

New heat exchanger

New heat exchanger of SMMS-e increases from 2 to 3 rows, providing even more surface area of the total pipe up to 13%.

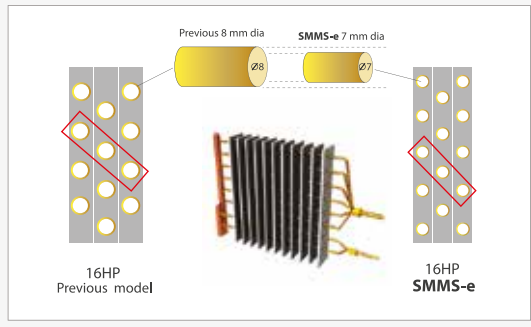
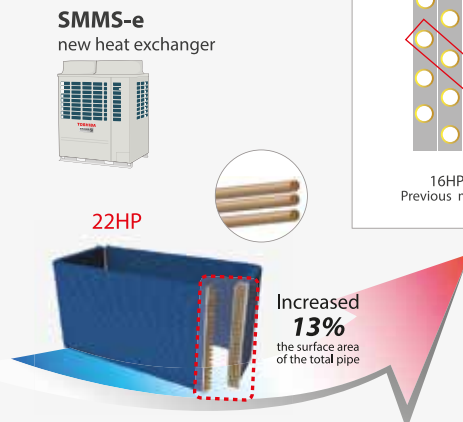
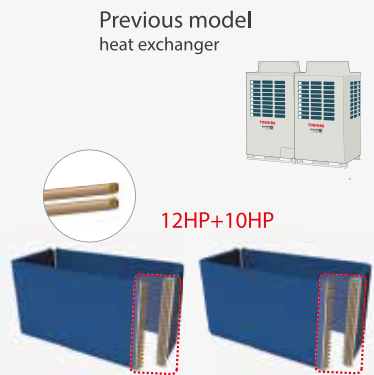

Variable heat exchanger

New system controls allows the outdoor unit to select the most efficient heat exchanger size, which matches the capacity load in order to provide higher energy savings.

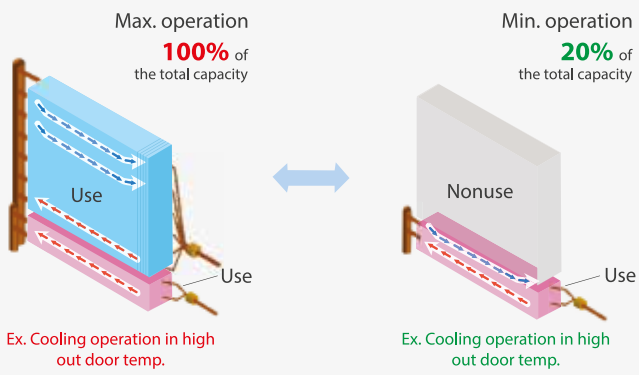

4-way heat exchanger can realize balanced airflow

Heat exchangers are located on all four sides of the outdoor unit, ensuring air flow is equal in all directions.

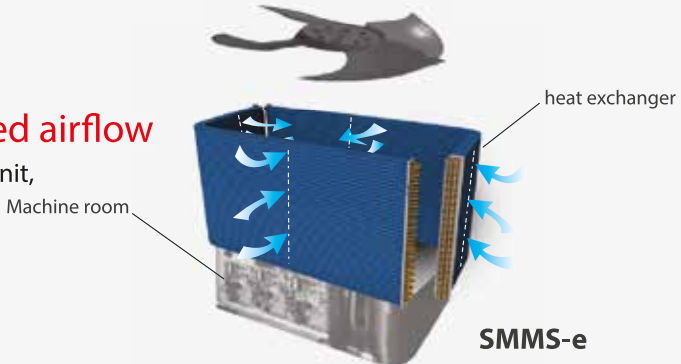



PIPING DESIGN FLEXIBILITY

Total piping length

Applied with Toshiba's unique and greatly improved technology, SMMS-e can reach up to 1,000 meters maximum piping length.

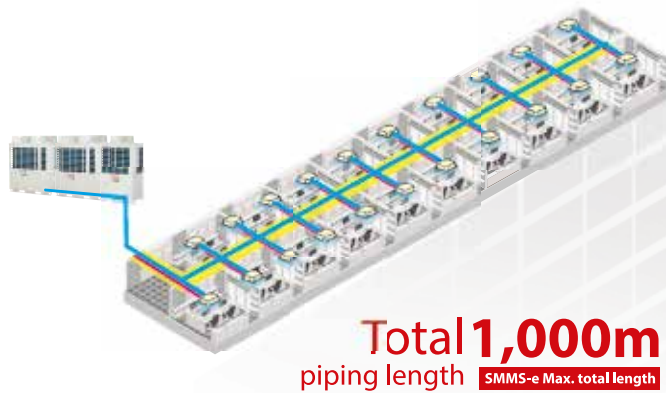

Farthest pipe from 1st branch

Even more convenient with the piping distance from the first branch to the furthest indoor unit at 90 meters, increasing the flexibility of the installation within the hotel or office building.

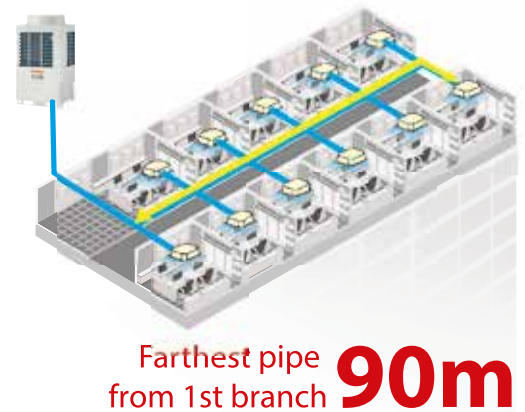

Farthest equivalent length

The maximum equivalent distance between outdoor unit and farthest indoor unit tops at 235 meters, which tops the industry class.

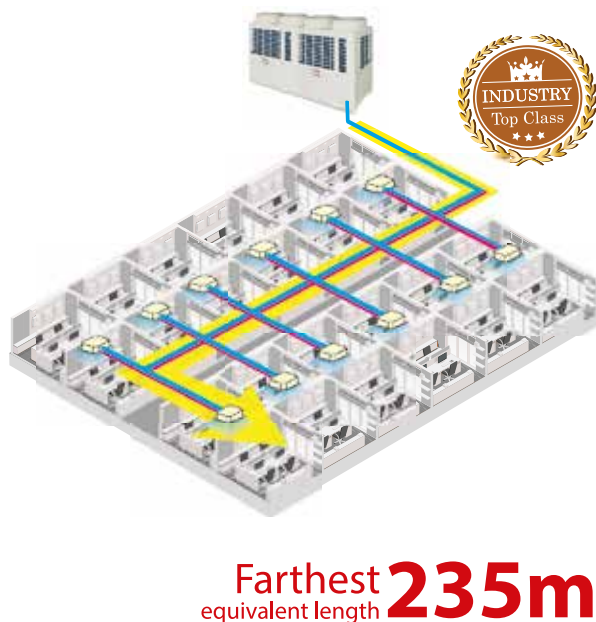

Height between indoor units

Another industry's top class is a maximum vertical distance between indoor units which reaches up to 40 meters, equal to an entire 11-storied building. SMMS-e's enhanced piping capabilities result in more benefits for the system design, installation flexibility, as well as the less installation cost.



Piping capabilities summary

Piping capability can provide more benefits for the system design, the installation flexibility, and the installation cost.

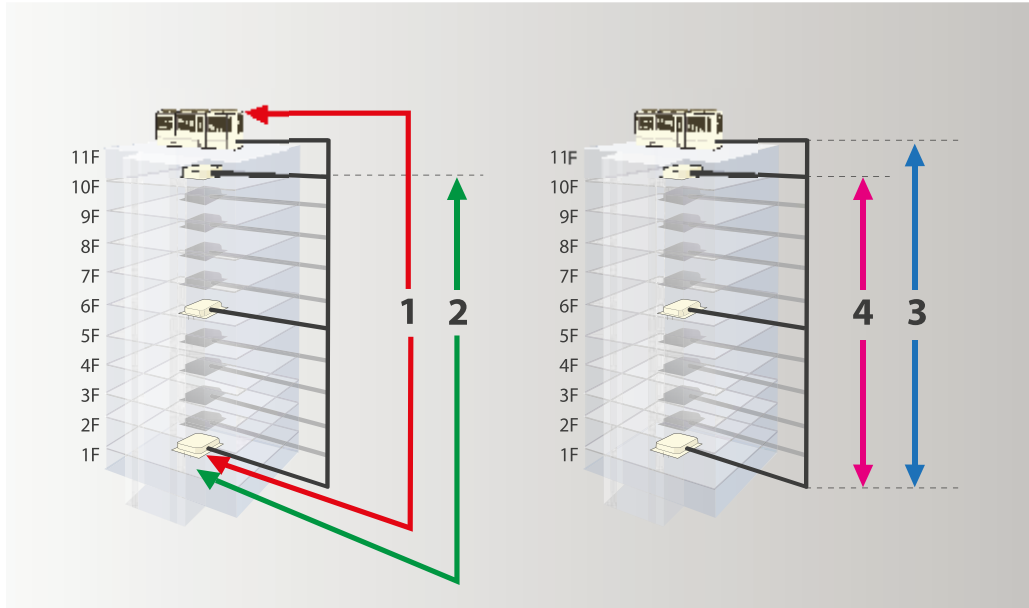

Total length	1,000m*
1. Farthest equivalent length	235m
2. Farthest pipe from 1 st branch	90m*
3. Height between outdoor unit - indoor unit (outdoor unit above/below)	90m* 40m
4. Height between indoor unit - indoor unit	40m

*Be sure to refer to the engineering data book for details of these conditions and requirements and discuss your requirements with sales team.





SLIMMER PIPE SIZE

Piping saving costs

With the sub-cool heat exchanger less refrigerant is needed therefore now it is possible to use smaller pipes and save in installation costs.

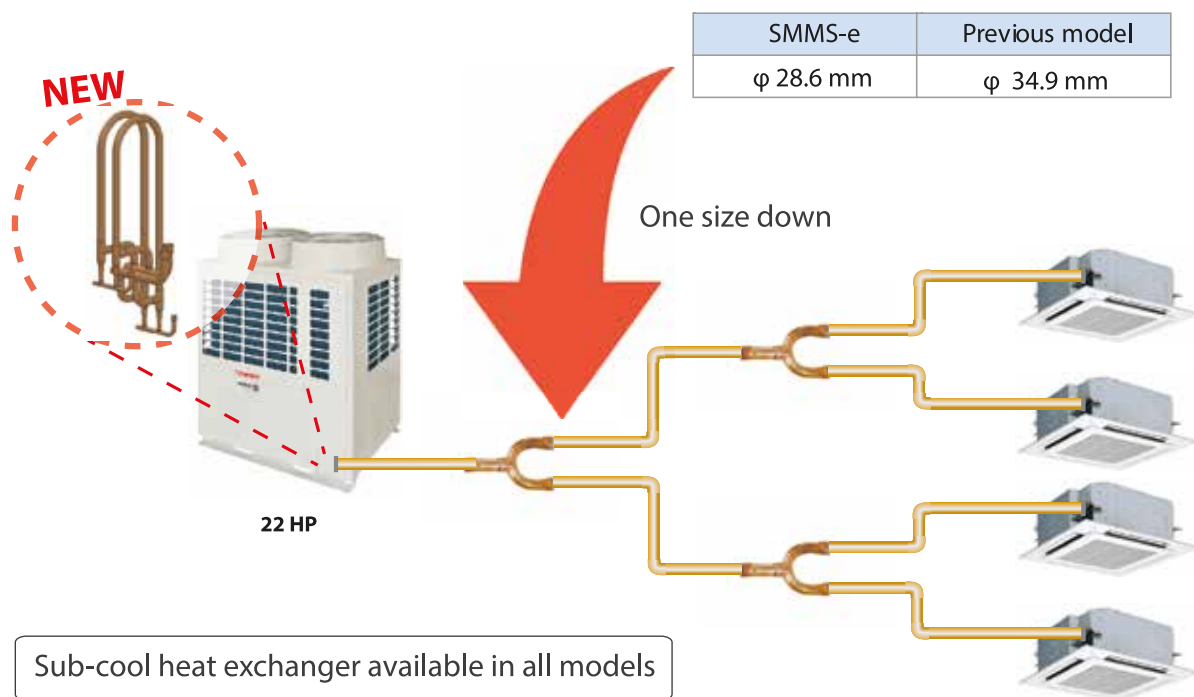

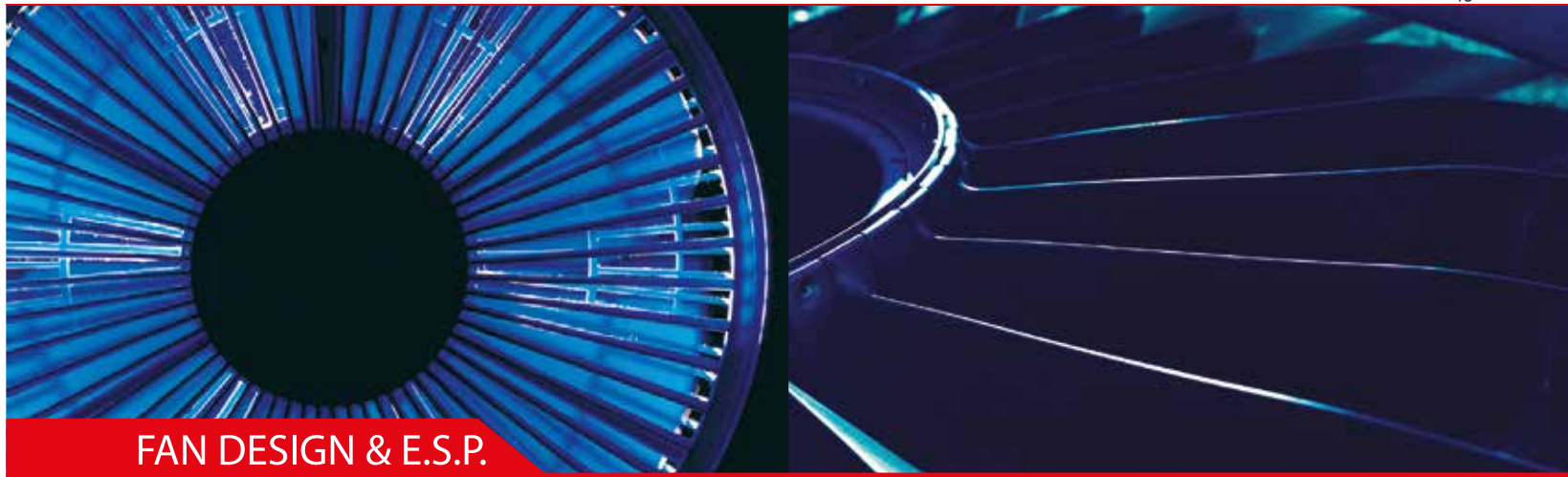



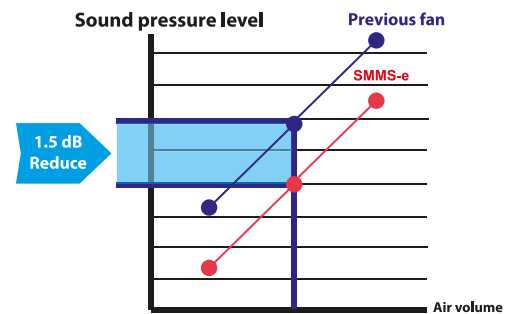

FAN DESIGN & E.S.P.

Every single blade is designed with a unique profile, a solution that guarantees a smoother air flow without turbulences. The new propeller deliver the same amount of air with less sound pressure level.

In the same working condition the new design of the propeller ensure a reduction of 1.5 dB compared to the previous models

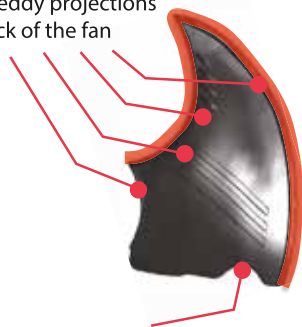

Each blade has a unique profile	Design improvements
<p>A </p> <p>B </p> <p>C </p> <p>D </p>	<p>New anti-eddy projections on the back of the fan </p> <p>New profiles of the reverse-arc shaped wings</p>

The external static pressure

New SMMSe has higher external static pressure up to 60Pa* which makes it more suitable for high rise buildings having cowl design or having requirement for cowl design.

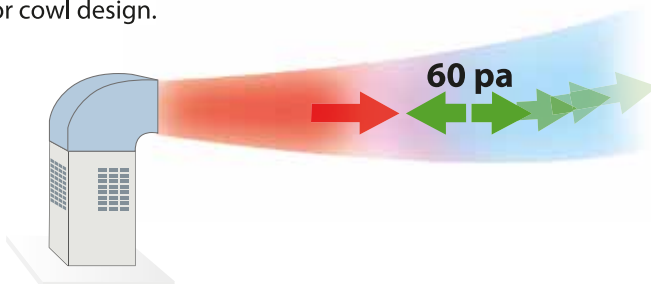

*Be sure to refer to the engineering data book for details of these conditions and requirements and discuss your requirements with sales team

Air flow simulation diagram

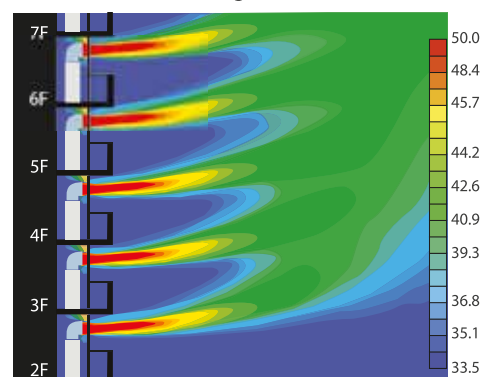

Note : This result is analytical simulation, that does not guarantee actual temperatures.

RELIABILITY

Backup operation

In case of a compressor failure, SMMS-e can keep working with the backup operation under All Inverter Control to compensate a failed compressor or header unit. This backup operation is available in both a single system or as a module.

Single outdoor unit backup

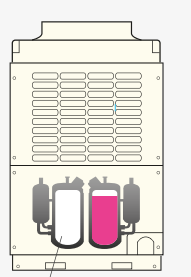

Failed compressor

Module outdoor unit backup

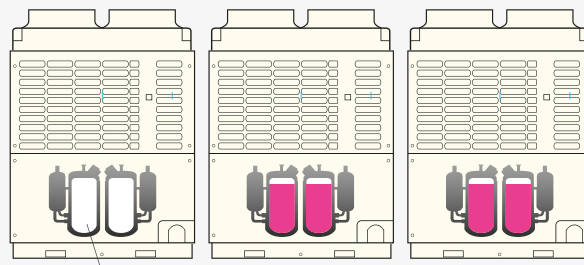

Failed outdoor unit

Reliability rotational control

The rotational control in SMMS-e is designed to improve system reliability by controlling the operation of each compressor to work equally under variable conditions.

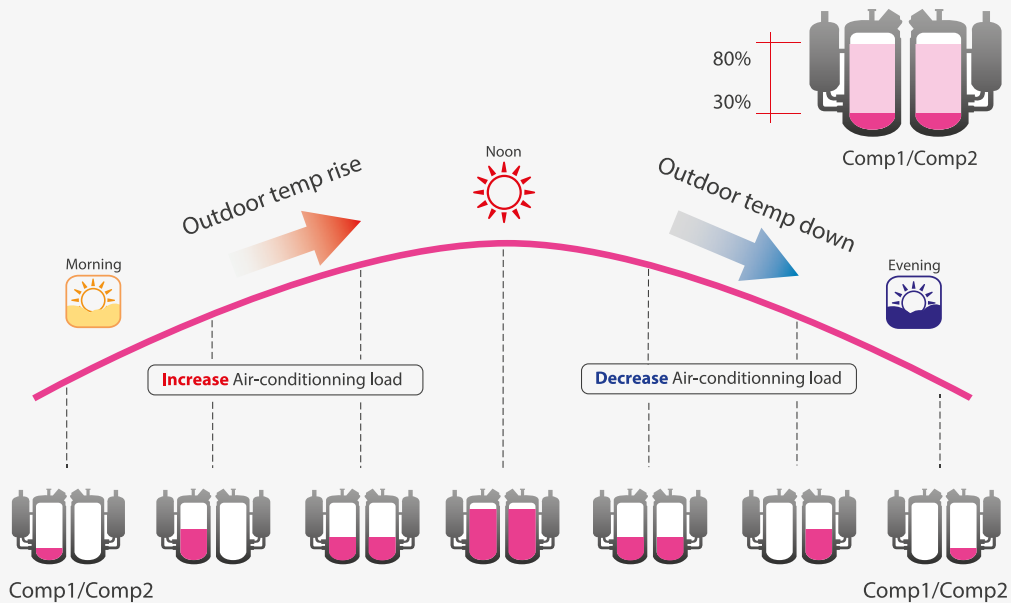



VRF AHU connectivity

Toshiba's design flexibility offers customised solutions to applications like large commercial buildings, shopping malls, Hotels, offices etc..



The DX coil interface integrates the DX Heat Exchanger of AHU's with the SMMS outdoor unit

Maximum capacity of connectable AHU (Return Air Type):
Single : 8 ~ 20 HP
System: Up to 60 HP

Maximum capacity of connectable AHU (Fresh Air Type):
Single : 8 ~ 40 HP

Connectable to various types of Dx-coil.

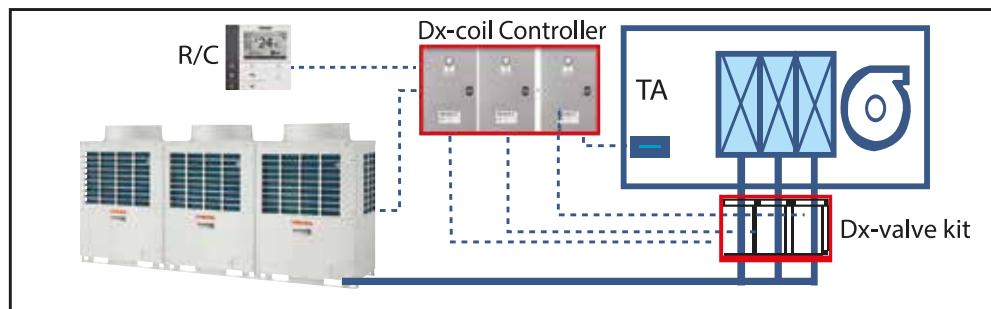

Type	AHU DX COIL INTERFACE						
	Model Name	TA Type			DDC Type		
		Controller	DX Valve Kit		Controller	DX Valve Kit	
Connectable AHU Capacity	8HP	TCB-4FTA201E	RBM-A101VAE*	RBM-A201VAE*	TCB-4FDDC201E	RBM-A101VAE*	RBM-A201VAE*
	10HP	1	1	-	1	1	-
	16HP	1	-	1	1	-	1
	18HP	1	-	1	1	-	1
	20HP	1	-	1	1	-	1
	32HP	1	-	2	1	-	2
	36HP	1	-	2	1	-	2
	40HP	1	-	2	1	-	2
	48HP	3	-	3	-	-	-
	54HP	3	-	3	-	-	-
60HP	3	-	3	-	-	-	

Notes:
1) Field capacity setting required
2) TA type connectivity up to 60HP
3) DDC type connectivity up to 40HP
4) Suitable for indoor installations
5) Not connectable to dedicated charge units



DX-coil controller
- 2 types (TA & DDC)
- PCB & Sensors
- Connector for external R/P & O/P
- Control PMV of the Valve kit & VRF ODU

DX Valve kit
- PMV (Pulse Motor Valve) is included to control refrigerant flow.
- 2 types according to the capacity.

	Y-shape branching joint				Branch headers				Outdoor unit connection piping kit	
Appearance										
Model name	RBM-BY55E	RBM-BY105E	RBM-BY205E	RBM-BY305E	RBM-HY1043E	RBM-HY2043E	RBM-HY1083E	RBM-HY2083E	RBM-BT14E	RBM-BT24E
Usage (Classification according to indoor unit capacity code)	Total below 6.4	Total 6.4 or more and below 14.2	Total 14.2 or more and below 25.2	Total 25.2 or more	Max.4 branches		Max.8 branches		Total below 26.0	Total 26.0 or more
					Total below 14.2	Total 14.2 or more and below 25.2	Total below 14.2	Total 14.2 or more and below 25.2		

Outdoor units

Heat Pump Model

									
Capacity		8HP	10HP	12HP	14HP	16HP	18HP	20HP	22HP
Model Name (MMY-)	50 Hz	MAP0806HT8D-XA	MAP1006HT8D-XA	MAP1206HT8D-XA	MAP1406HT8D-XA	MAP1606HT8D-XA	MAP1806HT8P-XA	MAP2006HT8P-XA	MAP2206HT8P-XA
Cooling capacity (kW)		22.4	28.0	33.5	40.0	45.0	50.4	56.0	61.5
Heating capacity (kW)		25.0	31.5	37.5	45.0	50.0	56.0	63.0	64.0

									
Capacity		24HP	26HP	28HP	30HP	32HP	34HP	36HP	38HP
Model Name (MMY-)	50 Hz	AP2416HT8D-XA	AP2616HT8D-XA	AP2816HT8D-XA	AP3016HT8D-XA	AP3216HT8D-XA	AP3416HT8X-XA	AP3616HT8X-XA	AP3816HT8X-XA
Units in combination (MMY-MAP)		1206HT8D-XA 1206HT8D-XA	1406HT8D-XA 1206HT8D-XA	1606HT8D-XA 1206HT8D-XA	1606HT8D-XA 1406HT8D-XA	1606HT8D-XA 1606HT8D-XA	1806HT8P-XA 1606HT8D-XA	2006HT8P-XA 1606HT8D-XA	2206HT8P-XA 1606HT8D-XA
Cooling capacity (kW)		67.0	73.5	78.5	85.0	90.0	95.4	101.0	106.5
Heating capacity (kW)		75.0	82.5	87.5	95.0	100.0	106.0	113.0	114.0

							
Capacity		40HP	42HP	44HP	46HP	48HP	
Model Name (MMY-)	50 Hz	AP4016HT8P-XA	AP4216HT8P-XA	AP4416HT8P-XA	AP4616HT8D-XA	AP4816HT8D-XA	
Units in combination (MMY-MAP)		2006HT8P-XA 2006HT8P-XA	2206HT8P-XA 2006HT8P-XA	2206HT8P-XA 2206HT8P-XA	1606HT8D-XA 1606HT8D-XA 1406HT8D-XA	1606HT8D-XA 1606HT8D-XA 1606HT8D-XA	
Cooling capacity (kW)		112.0	117.5	123.0	130.0	135.0	
Heating capacity (kW)		126.0	127.0	128.0	145.0	150.0	

							
Capacity		50HP	52HP	54HP	56HP	58HP	60HP
Model Name (MMY-)	50 Hz	AP5016HT8X-XA	AP5216HT8X-XA	AP5416HT8X-XA	AP5616HT8X-XA	AP5816HT8X-XA	AP6016HT8X-XA
Units in combination (MMY-MAP)		1806HT8P-XA 1606HT8D-XA 1606HT8D-XA	2006HT8P-XA 1606HT8D-XA 1606HT8D-XA	2206HT8P-XA 1606HT8D-XA 1606HT8D-XA	2006HT8P-XA 2006HT8P-XA 1606HT8D-XA	2206HT8P-XA 2006HT8P-XA 1606HT8D-XA	2206HT8P-XA 2206HT8P-XA 1606HT8D-XA
Cooling capacity (kW)		140.4	146.0	151.5	157.0	162.5	168.0
Heating capacity (kW)		156.0	163.0	164.0	176.0	177.0	178.0

* Power: 3-phase 50 Hz 400V (380 - 415V)
 * The source voltage must not fluctuate more than ±10%.
 * Rated conditions
 Cooling: Indoor air temperature 27°C DB/19°C WB, outdoor air temperature 35°C DB
 Heating: Indoor air temperature 20°C DB, outdoor air temperature 7°C DB/6°C WB

Outdoor unit specifications

Heat pump model (Single unit)

Technical specifications

Equivalent HP				8HP	10HP	12HP	14HP	16HP
Model name	Heat Pump	50Hz	(MMY-)	MAP0806HT8D-XA	MAP1006HT8D-XA	MAP1206HT8D-XA	MAP1406HT8D-XA	MAP1606HT8D-XA
Outdoor unit type				Inverter				
Power supply (*1)				3phase 4wires 50Hz 400V (380-415V)				
Cooling capacity 100% (*2)		(kW)		22.4	28.0	33.5	40.0	45.0
Heating capacity 100% (*2)		(kW)		25.0	31.5	37.5	45.0	50.0
External dimensions (Height / Width / Depth)		(m)		1.8 / 0.99 / 0.78	1.8 / 0.99 / 0.78	1.8 / 0.99 / 0.78	1.8 / 1.2 / 0.78	1.8 / 1.2 / 0.78
Total weight	Heat Pump	(kg)		242	242	242	299	299
Compressor	Motor output	(kW)		2.1 x 2	3.1 x 2	3.9 x 2	4.8 x 2	5.8 x 2
	Motor output	(kW)		1.0	1.0	1.0	1.0	1.0
Fan unit	Air volume	(m ³ /s)		2.7	2.7	3.4	3.4	3.5
	Refrigerant piping	Main pipe diameter	Gas side	(cm)	ø 1.9	ø 2.2	ø 2.9	ø 2.9
Liquid side			(cm)	ø 1.3	ø 1.3	ø 1.3	ø 1.6	ø 1.6
Balance pipe			(cm)	ø .95	ø .95	ø .95	ø .95	ø .95
Sound pressure level (Cooling/Heating)		(dB(A))		55 / 56	57 / 58	59 / 61	60 / 62	62 / 64



Single unit

Technical specifications

Equivalent HP				18HP	20HP	22HP
Model name	Heat Pump	50Hz	MMY-	MAP1806HT8P-XA	MAP2006HT8P-XA	MAP2206HT8P-XA
Outdoor unit type				Inverter		
Power supply (*1)				3phase 4wires 50Hz 400V (380-415V)		
Cooling capacity 100% (*2)		(kW)		50.4	56.0	61.5
Heating capacity 100% (*2)		(kW)		56.0	63.0	64.0
External dimensions (Height / Width / Depth)		m		1.8 / 1.6 / 0.78	1.8 / 1.6 / 0.78	1.8 / 1.6 / 0.78
Total weight	Heat Pump	(kg)		370	370	370
Compressor	Motor output	(kW)		6.5 x 2	7.6 x 2	9.0 x 2
	Motor output	(kW)		2.0	2.0	2.0
Fan unit	Air volume	(m ³ /s)		4.8	5.0	5.1
	Refrigerant piping	Main pipe diameter	Gas side	(cm)	ø 2.9	ø 2.9
Liquid side			(cm)	ø 1.6	ø 1.6	ø 1.9
Balance pipe			(cm)	ø .95	ø .95	ø .95
Sound pressure level (Cooling/Heating)		(dB(A))		60.0 / 61.0	61.0 / 62.0	61.0 / 62.0

*1 The source voltage must not flucture more than ±10%.

*2 Rated conditions Cooling : Indoor air temperature 27°C DB/19°C WB, Outdoor air temperature 35°C DB
 Heating : Indoor air temperature 20°C DB, Outdoor air temperature 7°C DB/6°C WB
 Based on equivalent piping length of 7.5 m and piping height difference of 0 m.

Combination

Equivalent HP				24HP				26HP		28HP	
Model name	Heat Pump	50Hz	MMY-	AP2416HT8D-XA		AP2616HT8D-XA		AP2816HT8D-XA			
Outdoor unit type				Inverter							
Power supply (*1)				3phase 4wires 50Hz 400V (380-415V)							
Outdoor unit model	Heat Pump	50Hz	MMY-	MAP1206HT8D-XA	MAP1206HT8D-XA	MAP1406HT8D-XA	MAP1206HT8D-XA	MAP1606HT8P	MAP1606HT8P		
Cooling capacity 100% ^{(*)2}				(kW)		67.0		73.5		78.5	
Heating capacity 100% ^{(*)2}				(kW)		75.0		82.5		87.5	
Total weight	Heat Pump			(kg)		242	242	299	242	299	242
Compressor	Motor output			(kW)		3.9 x 2	3.9 x 2	4.8 x 2	3.9 x 2	5.8 x 2	4.8 x 2
Fan unit	Motor output			(kW)		1.0	1.0	1.0	1.0	1.0	1.0
	Air volume			(m ³ /s)		3.4	3.4	3.4	3.4	3.5	3.4
Refrigerant piping	Main pipe diameter	Gas side		(cm)		ø 3.5		ø 3.5		ø 3.5	
		Liquid side		(cm)		ø 1.9		ø 1.9		ø 1.9	
		Balance pipe		(cm)		ø .95		ø .95		ø .95	
Sound pressure level (Cooling/Heating)				(dB(A))		62.5 / 64.5		63.0 / 65.0		64.0 / 66.0	

Combination

Equivalent HP				30HP		32HP		34HP			
Model name	Heat Pump	50Hz	MMY-	AP3016HT8D-XA		AP3216HT8D-XA		AP3416HT8X-XA			
Outdoor unit type				Inverter							
Power supply (*1)				3phase 4wires 50Hz 400V (380-415V)							
Outdoor unit model	Heat Pump	50Hz	MMY-	MAP1606HT8D-XA	MAP1406HT8D-XA	MAP1606HT8D-XA	MAP1606HT8D-XA	MAP1806HT8P-XA	MAP1606HT8D-XA		
Cooling capacity 100% ^{(*)2}				(kW)		85.0		90.0		95.4	
Heating capacity 100% ^{(*)2}				(kW)		95.0		100.0		106.0	
Total weight	Heat Pump			(kg)		299	299	299	299	370	299
Compressor	Motor output			(kW)		5.8 x 2	4.8 x 2	5.8 x 2	5.8 x 2	6.5 x 2	5.8 x 2
Fan unit	Motor output			(kW)		1.0	1.0	1.0	1.0	2.0	1.0
	Air volume			(m ³ /s)		3.4	3.4	3.4	3.4	4.8	3.5
Refrigerant piping	Main pipe diameter	Gas side		(cm)		ø 34.9		ø 34.9		ø 34.9	
		Liquid side		(cm)		ø 19.1		ø 19.1		ø 19.1	
		Balance pipe		(cm)		ø 9.5		ø 9.5		ø 9.5	
Sound pressure level (Cooling/Heating)				(dB(A))		64.5 / 66.5		65.5 / 67.5		64.5 / 66.0	

Combination

Equivalent HP				36HP		38HP		40HP			
Model name	Heat Pump	50Hz	MMY-	AP3616HT8X-XA		AP3816HT8X-XA		AP4016HT8P-XA			
Outdoor unit type				Inverter							
Power supply (*1)				3phase 4wires 50Hz 400V (380-415V)							
Outdoor unit model	Heat Pump	50Hz	MMY-	MAP2006HT8P-XA	MAP1606HT8D-XA	MAP2206HT8P-XA	MAP1606HT8D-XA	MAP2006HT8P-XA	MAP2006HT8P-XA		
Cooling capacity 100% ^{(*)2}				(kW)		101.0		106.5		112.0	
Heating capacity 100% ^{(*)2}				(kW)		113.0		114.0		126.0	
Total weight	Heat Pump			(kg)		370	299	370	299	370	370
Compressor	Motor output			(kW)		7.6 x 2	5.8 x 2	9.0 x 2	5.8 x 2	7.6 x 2	7.6 x 2
Fan unit	Motor output			(kW)		2.0	1.0	2.0	1.0	2.0	2.0
	Air volume			(m ³ /s)		5.0	3.5	5.1	3.5	5.0	5.0
Refrigerant piping	Main pipe diameter	Gas side		(cm)		ø 4.1		ø 4.1		ø 4.1	
		Liquid side		(cm)		ø 2.2		ø 2.2		ø 2.2	
		Balance pipe		(cm)		ø .95		ø .95		ø .95	
Sound pressure level (Cooling/Heating)				(dB(A))		65.0 / 66.5		65.0 / 66.5		64.5 / 65.5	

*1 The source voltage must not flucture more than ±10%.

*2 Rated conditions Cooling : Indoor air temperature 27°C DB/19°C WB, Outdoor air temperature 35°C DB
 Heating : Indoor air temperature 20°C DB, Outdoor air temperature 7°C DB/6°C WB
 Based on equivalent piping length of 7.5 m and piping height difference of 0 m.

Combination

Technical specifications

Equivalent HP				42HP			44HP		46HP			48HP			
Model name	Heat Pump	50Hz	MMY-	AP4216HT8P-XA			AP4416HT8P-XA		AP4616HT8D-XA			AP4816HT8D-XA			
Outdoor unit type				Inverter											
Power supply (*1)				3phase 4wires 50Hz 400V (380-415V)											
Outdoor unit model	Heat Pump	50Hz	MMY-	MAP2206HT8P-XA	MAP2006HT8P-XA	MAP2206HT8P-XA	MAP2206HT8P-XA	MAP1606HT8D-XA	MAP1606HT8D-XA	MAP1406HT8D-XA	MAP1606HT8D-XA	MAP1606HT8D-XA	MAP1606HT8D-XA		
Cooling capacity 100% (*2)				117.5			123.0		130.0			135.0			
Heating capacity 100% (*2)				127.0			128.0		145.0			150.0			
Total weight	Heat Pump			(kg)	370	370	370	370	299	299	299	299	299		
Compressor	Motor output			(kW)	9.0 x 2	7.6 x 2	9.0 x 2	9.0 x 2	5.8 x 2	5.8 x 2	4.8 x 2	5.8 x 2	5.8 x 2		
Fan unit	Motor output			(kW)	2.0	2.0	2.0	2.0	1.0	1.0	1.0	1.0	1.0		
	Air volume			(m ³ /s)	5.1	5.0	5.1	5.1	3.5	3.5	3.4	3.5	3.5		
Refrigerant piping	Main pipe diameter	Gas side			(cm)	ø 4.1		ø 4.1		ø 4.1			ø 4.1		
		Liquid side			(cm)	ø 2.2		ø 2.2		ø 2.2			ø 2.2		
		Balance pipe			(cm)	ø .95		ø .95		ø .95			ø .95		
Sound pressure level (Cooling/Heating)						(dB(A))		64.5 / 65.5		64.5 / 65.5		66.5 / 68.5		67.0 / 69.0	

Combination

Technical specifications

Equivalent HP				50HP			52HP			54HP				
Model name	Heat Pump	50Hz	MMY-	AP5016HT8X-XA			AP5216HT8X-XA			AP5416HT8X-XA				
Outdoor unit type				Inverter										
Power supply (*2)				3phase 4wires 50Hz 400V (380-415V)										
Outdoor unit model	Heat Pump	50Hz	MMY-	MAP1806HT8P-XA	MAP1606HT8D-XA	MAP1606HT8D-XA	MAP2006HT8P-XA	MAP1606HT8D-XA	MAP1606HT8D-XA	MAP2206HT8P-XA	MAP1606HT8D-XA	MAP1606HT8D-XA		
Cooling capacity 100% (*2)				140.4			146.0			151.5				
Heating capacity 100% (*2)				156.5			163.0			164.0				
Total weight	Heat Pump			(kg)	370	299	299	370	299	299	370	229	299	
Compressor	Motor output			(kW)	6.5 x 2	5.8 x 2	5.8 x 2	7.6 x 2	5.8 x 2	5.8 x 2	9.0 x 2	5.8 x 2	5.8 x 2	
Fan unit	Motor output			(kW)	2.0	1.0	1.0	2.0	1.0	1.0	2.0	1.0	1.0	
	Air volume			(m ³ /s)	4.8	3.5	3.5	5.0	3.5	3.5	5.1	3.5	3.5	
Refrigerant piping	Main pipe diameter	Gas side			(cm)	ø 4.1		ø 4.1		ø 4.1			ø 4.1	
		Liquid side			(cm)	ø 2.2		ø 2.2		ø 2.2			ø 2.2	
		Balance pipe			(cm)	ø .95		ø .95		ø .95			ø .95	
Sound pressure level (Cooling/Heating)						(dB(A))		66.5 / 68.0		66.5 / 68.5		66.5 / 68.5		

Combination

Technical specifications

Equivalent HP				56HP			58HP			60HP				
Model name	Heat Pump	50Hz	MMY-	AP5616HT8X-XA			AP5816HT8X-XA			AP6016HT8X-XA				
Outdoor unit type				Inverter										
Power supply (*2)				3phase 4wires 50Hz 400V (380-415V)										
Outdoor unit model	Heat Pump	50Hz	MMY-	MAP2006HT8P-XA	MAP2006HT8P-XA	MAP1606HT8D-XA	MAP2206HT8P-XA	MAP2006HT8P-XA	MAP1606HT8D-XA	MAP2206HT8P-XA	MAP2206HT8P-XA	MAP1606HT8D-XA		
Cooling capacity 100% (*2)				157.0			162.5			168.0				
Heating capacity 100% (*2)				176.0			177.0			178.0				
Total weight	Heat Pump			(kg)	370	370	299	370	370	299	370	370	299	
Compressor	Motor output			(kW)	7.6 x 2	7.6 x 2	5.8 x 2	9.0 x 2	7.6 x 2	5.8 x 2	9.0 x 2	9.0 x 2	5.8 x 2	
Fan unit	Motor output			(kW)	2.0	2.0	1.0	2.0	2.0	1.0	2.0	2.0	1.0	
	Air volume			(m ³ /s)	5.0	5.0	3.5	5.1	5.0	3.5	5.1	5.1	3.5	
Refrigerant piping	Main pipe diameter	Gas side			(cm)	ø 4.1		ø 4.1		ø 4.1			ø 4.1	
		Liquid side			(cm)	ø 2.2		ø 2.2		ø 2.2			ø 2.2	
		Balance pipe			(cm)	ø .95		ø .95		ø .95			ø .95	
Sound pressure level (Cooling/Heating)						(dB(A))		66.5 / 68.0		66.5 / 68.0		66.5 / 68.0		

*1 The source voltage must not flucture more than ±10%.

*2 Rated conditions Cooling : Indoor air temperature 27°C DB/19°C WB, Outdoor air temperature 35°C DB
 Heating : Indoor air temperature 20°C DB, Outdoor air temperature 7°C DB/6°C WB
 The standard piping means that main pipe length is 5m, branching pipe length is 2.5m of branch piping connected with a 0 meter height.

*1 The source voltage must not flucture more than ±10%.

*2 Rated conditions Cooling : Indoor air temperature 27°C DB/19°C WB, Outdoor air temperature 35°C DB
 Heating : Indoor air temperature 20°C DB, Outdoor air temperature 7°C DB/6°C WB
 Based on equivalent piping length of 7.5 m and piping height difference of 0 m.

Outdoor units external drawings

**Model : MMY-MAP0806HT8D-XA
MMY-MAP1006HT8D-XA
MMY-MAP1206HT8D-XA**

Model Name	Liquid Pipe	Gas Pipe
MAP0806 type	Ø12.7	Ø19.1
MAP1006 type	Ø12.7	Ø22.2
MAP1206 type	Ø12.7	Ø28.6
MAP14B6 type	Ø15.9	Ø28.6

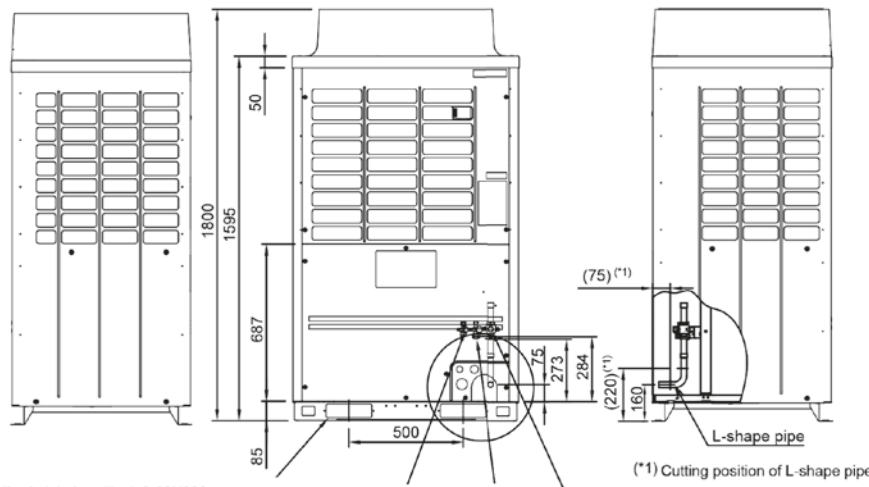
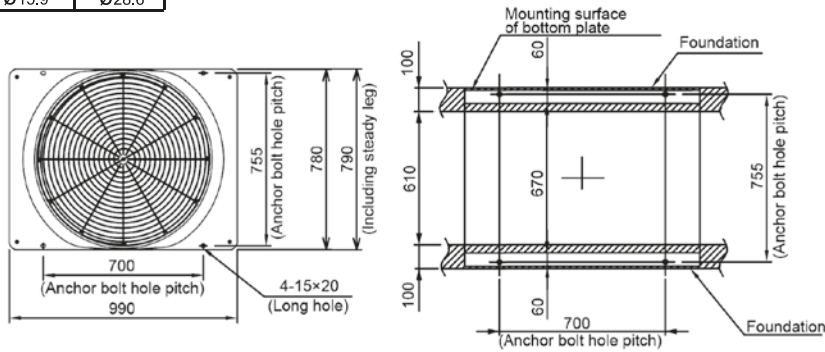

Square hole (for freight handling) 2-60X200

Balance pipe connection port $\phi 9.5$

Gas pipe connection port ϕA

Liquid pipe connection port $\phi 12.7$

(Note)

1. If there is an obstacle at the upper side of the outdoor unit, set the top end of the outdoor unit 2000mm apart from the obstacle.
2. Limit the height of the obstacle surrounding the outdoor unit to 800mm or less from the bottom end of the outdoor unit.
3. Draw out the pipe procured locally to the front of the outdoor unit horizontally, and keep 500mm or more between the outdoor unit and traversing pipe if placing pipe transversely.
4. Dimensional drawing of corrosion heavy protection model is the same as that of standard model.

(Unit:mm)

**Model : MMY-MAP1406HT8D-XA
MMY-MAP1606HT8D-XA**

Model Name	Liquid Pipe	Gas Pipe
MAP1406 type	Ø15.9	Ø28.6
MAP1606 type	Ø15.9	Ø28.6
MAP18B6 type	Ø15.9	Ø28.6

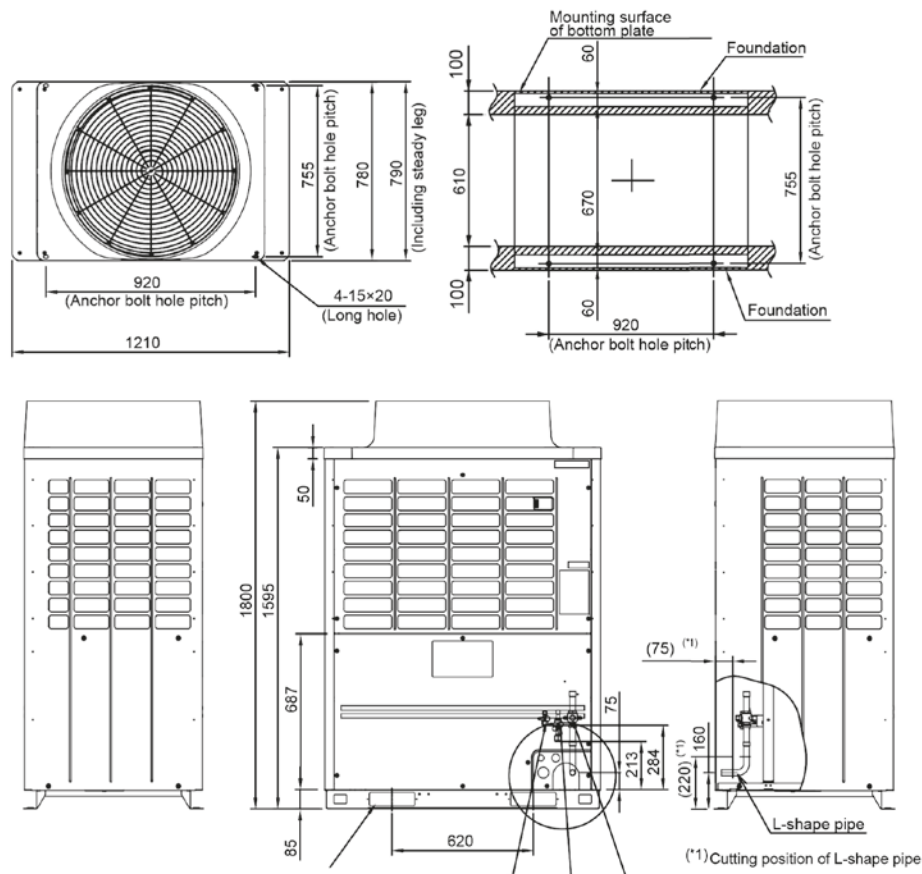

Square hole (for freight handling) 2-60X200

Balance pipe connection port $\phi 9.5$

Gas pipe connection port $\phi 28.6$

Liquid pipe connection port $\phi 15.9$

(Note)

1. If there is an obstacle at the upper side of the outdoor unit, set the top end of the outdoor unit 2000mm apart from the obstacle.
2. Limit the height of the obstacle surrounding the outdoor unit to 800mm or less from the bottom end of the outdoor unit.
3. Draw out the pipe procured locally to the front of the outdoor unit horizontally, and keep 500mm or more between the outdoor unit and traversing pipe if placing pipe transversely.
4. Dimensional drawing of corrosion heavy protection model is the same as that of standard model.

(Unit:mm)

**Model : MMY-MAP1806HT8P-XA
MMY-MAP2006HT8P-XA
MMY-MAP2206HT8P-XA**

Model Name	Liquid Pipe	Gas Pipe
MAP1806 type	Ø15.9	Ø28.6
MAP2006 type	Ø15.9	Ø28.6
MAP2206 type	Ø19.1	Ø28.6

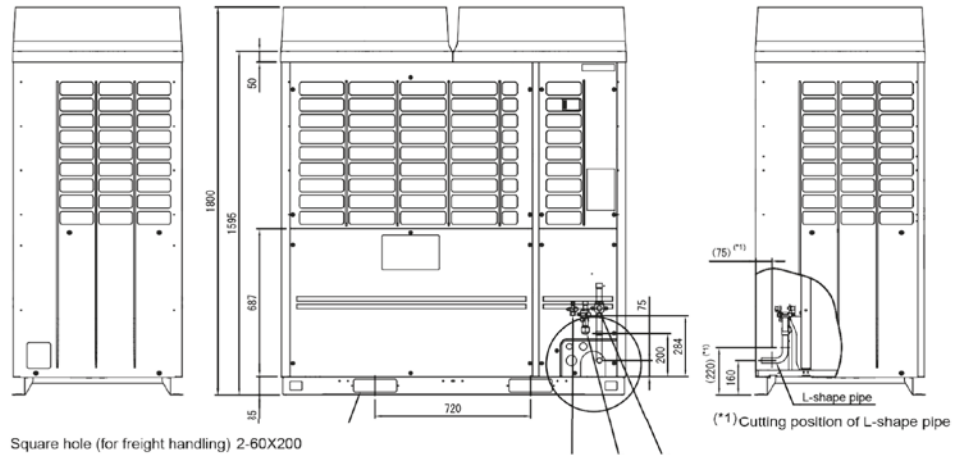
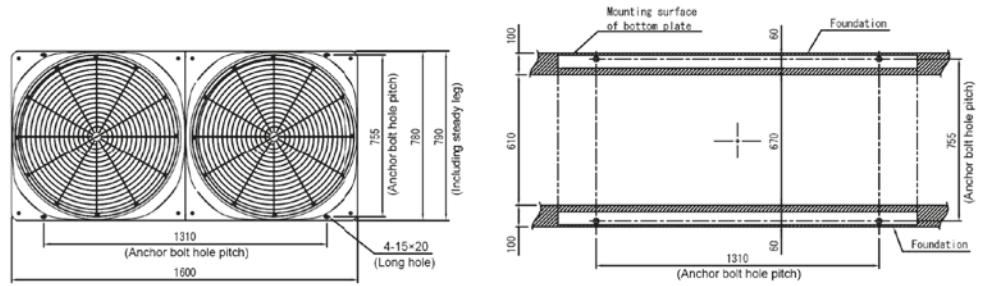

Square hole (for freight handling) 2-60X200

Balance pipe connection port Ø9.5

Gas pipe connection port Ø28.6

Liquid pipe connection port ØA

(Unit:mm)

(Note)

1. If there is an obstacle at the upper side of the outdoor unit, set the top end of the outdoor unit 2000mm apart from the obstacle.
2. Limit the height of the obstacle surrounding the outdoor unit to 800mm or less from the bottom end of the outdoor unit.
3. Draw out the pipe procured locally to the front of the outdoor unit horizontally, and keep 500mm or more between the outdoor unit and traversing pipe if placing pipe transversely.
4. Dimensional drawing of corrosion heavy protection model is the same as that of standard model.



Installation and the use of refrigerants not specified by Toshiba Carrier Corporation

Toshiba refrigeration and air-conditioning units are designed and manufactured on the assumption that the product is used with a specific refrigerant suitable for each unit.

We have recently seen some cases where the type of refrigerant used is different from the one originally installed in the product. Such actions may cause mechanical defects, malfunctions, failures and in some cases result in a serious safety issue. Therefore do not install any refrigerant other than the one specified by Toshiba Carrier Corporation for its respective products.

The type of the refrigerant used for each of our products is shown in the accompanying owners manual, or on the product label attached on the product itself.

Toshiba Carrier Corporation shall not assume any liability for failures, malfunctions or safety in its products if the refrigerant used is different from the one specified.

SAFETY PRECAUTIONS

For operation:

- Before use, read through the operating instructions to ensure proper use.

Concerning the purpose for which the air conditioners are to be used

- The air conditioners presented in this catalogue are air conditioning/heating units to be used solely by general consumers.
 - Do not use these air conditioners for special applications such as for the storage of food items, animals, plants, precision machines or works of art. Doing so may degrade the quality of the items.
 - Do not use these air conditioners for air-conditioning applications in vehicles or ships. Doing so may cause water and/or power leakages.

Precautions for using air conditioners

Concerning the automatic defrosting unit

When the outdoor air temperature drops, frost may form on the heat exchanger of the outdoor unit. In such cases, the automatic defrosting unit will be activated, and it will take 5 to 8 minutes for the heating operation to be restored.

Concerning the air conditioner's operating conditions and their selection

(1) Avoid using the air conditioner in the following locations.

- Locations with acidic or alkaline atmospheres (locations at which highly acidic or alkaline air is directly drawn in, such as in hot springs areas from which sulfur gases are given off, or where chemicals, vinegar, exhaust air from burners, etc., are given off) The heat exchangers and other parts may become corroded.
- Locations with atmospheres filled with coolant or other machine oil or steam exhaust (such as at food preparation factories or machine plants). The heat exchangers may corrode; frost may form as a result of heat exchanger malfunction; air conditioner operating performance may be compromised or condensation may form as a result of clogged filters; plastic parts may incur damage; heat-insulation materials may become separated, etc.

(2) Before using an air conditioner in any of the following locations, consult with your dealer or a qualified contractor.

- Locations where vapors from edible oils are given off (such as in bakeries or kitchens and restaurants that use edible oils) ...The air conditioner's operating performance may be compromised or condensation may form as a result of clogged filters, and the plastic parts may incur damage. In line with the prevailing conditions, take countermeasures such as tailoring the installation conditions in accordance with the conditions, using air conditioners designed for kitchens or oil guard filters, etc.
- Locations with disinfectant-induced chlorine atmospheres (water tanks, etc.) The metal parts in the heat exchangers, motors, etc., may become corroded.
- Locations with high salinity (coastal areas, etc.) Corrosion may occur so use outdoor units specifically designed to withstand exposure to salt.

- Locations where power is supplied from independent power generators. The power line frequency and/or voltage may fluctuate, possibly causing the air conditioner to malfunction.
- Locations where high frequencies or electrical noise is generated (from high-frequency welders used for vinyl welding and processing, high-frequency therapeutic devices used for thermotherapy, etc.) The electronic components may be adversely affected, possibly causing the air conditioner to malfunction.
- Locations where electronic equipment is installed. Electrical noise may adversely affect the operation of the electronic equipment.

(3) Concerning use in locations with high ceilings

- In locations with high ceilings, use of circulators for improving the temperature distribution during heating is recommended.

(4) Concerning use in high-humidity environments

- When the ceiling-recessed type of indoor unit is installed in a location, such as those described below, and it is very hot and humid inside the ceiling, condensation may form on the external surfaces of the indoor unit and drip down. In such cases, add external heat-insulating materials.
 - Locations such as food preparation sites in which the areas above the ceilings are hot and humid
 - Locations in which outside air is drawn in and routed above the ceiling
 - Above ceilings with a slate roof or tiled roof overhead

(5) Even when an air conditioner is shut down, it will still consume a small amount of power to protect the unit. If the air conditioner will not be used for a prolonged period, turn OFF the main switch (ground fault circuit breaker). However, before the unit is to be used again, turn ON the main switch (ground fault circuit breaker) for at least 12 hours in order to prevent trouble.

TOSHIBA



CARE
CONCERN
COMMITMENT

TOSHIBA SERVICE HELPLINE
1800 3000 3545

For more details, please contact our sales office:

Corporate & Regd. Office: Carrier Airconditioning & Refrigeration Ltd, Narsinghpur, Kherki Daula Post, Gurgaon 122004, Haryana, India.
Tel: 0124-4825500, Fax: 0124-2372230

Sales Offices:-- **Delhi/NCR:** 0124-4873200 **Ghaziabad:** 0120-4183260 **Lucknow:** 0522-4158703/4158710 **Chandigarh:** 0172-5007549/ 5007550 **Jaipur:** 0141-6612022 **Indore:** 0731-2445200 **Mumbai:** 022-61700700 **Ahmedabad:** 079-44820400 **Pune:** 020-67045100 **Kolkata:** 033-40524354 **Chennai:** 044-66448888
Bangalore: 080-43442000 **Hyderabad:** 040-41100222 **Cochin:** 0484-4029001/0 **Bhubaneshwar:** 7381002850

CIN: U74999HR1992FLC036104/ **Website:** www.carrierindia.com, www.toshibaac.in/ **E-mail:** info@toshibaac.in

TOTALINE



ISO 9001
Quality
Management

ISO 14001
Environmental
Management

OHSAS
18001
Occupational
Health & Safety
Management



This catalogue provides certain general information and is intended for general guidance only and Carrier is not liable for any damage arising out of the use of the catalogue.

The Manufacturer reserves the right to change any product specification without prior notice.

All Proprietary Rights Reserved.