



SCE2800A

SANY Crawler Crane

280 Tons Lifting Capacity

Quality Changes the World



The parameters, pictures and standard/optional equipment are only for reference in this brochure, the actual machine is based on the effective price list and contract.

■ www.sanyglobal.com



Crawler Crane Series
SCE2800A

P03	Main Characteristics	<ul style="list-style-type: none"> ▪ Driver's Cab ▪ Upperworks ▪ Lowerworks ▪ Counterweight ▪ Hydraulic System ▪ Operating Weight ▪ Ground Pressure ▪ Gradeability ▪ Operating Equipment ▪ Safety Devices
P10	Technical Parameters	<ul style="list-style-type: none"> ▪ Main Performance Parameters ▪ Basic Dimensions of Crane ▪ Transportation Dimensions ▪ Transport Plan ▪ Schematics for Assembly/Disassembly
P24	Combination of Working Conditions	<ul style="list-style-type: none"> ▪ Boom Combination ▪ H Configuration ▪ FJ Configuration ▪ LJ Configuration



SCE2800A
SANY CRAWLER CRANE
280 TONS LIFTING CAPACITY

QUALITY CHANGES THE WORLD

Main Characteristics

- Page 04 Driver's Cab
- Page 04 Upperworks
- Page 05 Lowerworks
- Page 06 Counterweight
- Page 06 Hydraulic System
- Page 06 Operating Weight
- Page 06 Ground Pressure
- Page 06 Gradeability
- Page 07 Operating Equipment
- Page 08 Safety Devices

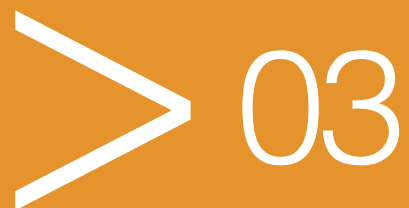

Driver's cab



Exterior

- The cab's industrial design is made by PORSCHE with smooth outline in aesthetic novelty. The great breakthrough marks it from the traditional engineering machinery, building a distinct brand identification. Sliding door structure is adopted, that is perfectly suitable on the crawler crane for the operator to sliding on and off the door. Fully-enclosed steel frame is applied with large faces of high-strength tempered glass on front, side and top ceiling, admitting sufficient lights. Furthermore, the cab is capacious and bright, offering wider view for the operator.

Comfortability

- Multimode and multilevel adjustable suspension seat with minimum vibration and noise is mounted, providing the most comfortable driving experience for the operator. Air conditioning and heater are provided to adjust the indoor temperature to a perfect level, dropping from 55°C to 27.5°C within 20 minutes. The right and left armrests as well as the auxiliary operating panel are installed with operating handles, control buttons, ignition lock and other components. The seat, handles and buttons are laid out ergonomically with full consideration given to the operator's needs and habits. The control box and seat can be adjusted to the most comfortable position for the operator to make operation at ease. The driver's cab can tilt 25° upward or downward as needed for the work, or rotate to the dead ahead of the platform to facilitate the transportation.

Upperworks



Engine

- Cummins (Europe Stage V)
- Rated power: 298kW;
- Rated speed: 2100rpm;
- Max. output torque: 2169N·m;
- Speed at maximum output torque: 1,400rpm.

Hoisting Mechanism

- The main and aux. winch mechanism are driven independently, which is featured in compact structure, easy assembly. The hardly-worn and maintenance-free embedded wet brake ensures the winch safety.
- The hydraulic motor with variable displacement can match the load with automatic adjustment of displacement to achieve highest winch speed.
- Quality anti-twisting wire rope is selected to ensure the safety of load lifting and longer service life.
- Wire rope lug is adopted for easier and convenient rope assembly and disassembly.

Main Hoisting Mechanism	Drum diameter (non free fall)	630mm
	Drum diameter (free fall)	837mm
	Rope speed on the outermost work layer (non free fall)	0~125m/min
	Rope speed on the outermost work layer (free fall)	0~117m/min
	Wire rope diameter	28mm
	Wire rope length for main hoisting winch	480m
	Rated single line pull	15t
Auxiliary Hoisting Mechanism	Drum diameter (non free fall)	630mm
	Drum diameter (free fall)	837mm
	Rope speed on the outermost work layer (non free fall)	0~125m/min
	Rope speed on the outermost work layer (free fall)	0~117m/min
	Wire rope diameter	28mm
	Wire rope length for aux. hoisting winch	390m
	Rated single line pull	15t



Upperworks

Luffing Winch Mechanism

- Including: luffing mechanisms of the boom and jib;
- Drums with folded-line grooves are adopted for all luffing devices. Hydraulic motor drives the planetary gear reducer to realize multiple composite actions and it is equipped with good inching performance.

Boom Luffing Mechanism	Drum diameter	630mm
	Rope speed on the outermost work layer	0~130m/min
	Wire rope diameter	28mm
	Wire rope length of boom luffing winch	288m
	Rated single line pull	20.6t
Jib Luffing Mechanism	Drum diameter	440mm
	Rope speed on the outermost work layer	0~77m/min
	Wire rope diameter	20mm
	Wire rope length of jib luffing winch	410m
	Rated single line pull	10.5t

Slewing Mechanism

- Large motor is adopted for the slewing hydraulic system to drive through a planetary gear reducer and enables 360° rotation. The slewing speed is 0~1.8rpm, which can realize infinitely variable speed. The slewing, free of starting and stopping impact, operates steadily and is equipped with neutral free slipping function. When the control handle is in neutral position and no slewing speed is pick up, slewing mechanism is locked to prevent backlash during crane walking or transport. Slewing bearing device: three-row roller external gear slewing bearing is adopted



Lowerworks

Car-body

- The hydraulic cylinder drives power pin to be connected with track frame to facilitate the assembly and disassembly. Frame structures are welded by high-strength steel. Larger chassis design greatly improves the stability of the crane.

Crawler Assembly

- Track frame: each track frame is equipped with an independent travel driving device. A hydraulic travel motor drives the planetary gear reducer and realizes independent traveling through the transmission of driving wheel. The travel system is configured with four speed options to meet various requirements: sufficient traction is provided in low speed to realize 100% pick and carry, while faster job-site transfer is possible in high travel speed. Infinite variable speed can be realized in travel driving system.
- Track shoe: it is manufactured by advanced casting techniques and materials with high strength and good wear resistance. After assembled on the machine, the tension can be adjusted by a hydraulic jack with shims used to secure the crawler position.

Counterweight



- Include Carbody Counterweight, Rear Counterweight

Name	Quantity	Length	Width	Height	Unit Weight
Carbody counterweight	2	5.48m	1.97m	0.6m	20t
Rear counterweight	14	2.17m	1.96m	0.5m	6t
Rear counterweight Tray	1	7.5m	1.96m	0.7m	16t

Hydraulic System



- The whole hydraulic system includes that of hoisting, traveling, slewing, luffing, servo, back-stop, cooling system, and auxiliary hydraulic system. Major hydraulic components are original imports.
- Features: the main system is open circuit and load-sensitive system, which can realize flow distribution irrelevant from load. The hydraulic proportional pilot control is used for agile operation and excellent inching performance. System pressure is 32MPa.
- Electrically-controlled proportional control components are adopted for the servo system to realize precise and intelligent control.
- External controlled and outflow balance valve is adopted for the back-stop system, which ensures the safety and reliability.
- The cooling hydraulic system consists with large independent power radiator and three-in-one radiator, featured with large heat exchange power and good cooling effect.

Operating Weight



- The operating weight is about 255t, including the Upperworks, lowerworks, rear counterweight of basic machine, carbody counterweight, 20m basic boom and 260t hook.

Ground Pressure



- The average ground pressure of machine with basic boom is 0.14MPa.

Gradeability



- The gradeability of the track base boom machine with basic boom is 30%.



Operating Equipment

All operating equipment adopt high-strength steel pipe, so do the steel plates. The sheaves used on boom/jib tip and hooks are all rolled material and welded structure.

Boom

- The boom is a spatial lattice structure with equal section areas for inserts and tapered section areas for both ends. With pipes welded together, and boom tip and root strengthened with steel plates, it can better transfer the load.
- The length of the boom ranges from that 20m of the base boom to the maximum length 92m and it can be increased progressively by 3m.
- Composition: boom base 10m×1, transitional insert 6m×1, boom top 1m×1, insert section 3m×1, and insert section 6m×2 and 12m×5.

Fixed Jib

- The fixed jib is a spatial lattice structure with equal section areas for inserts and tapered section areas for both ends. With pipes welded together, and boom tip and root strengthened with steel plates, it can better transfer the load.
- The length of fixed jib ranges from 13m to 42m, which can be increased progressively by 6m and can be installed on boom from 29m-62m.
- Composition: jib base 6.5m×1, jib insert 6m×1 and 11.5m×2, and jib top 6.5m×1.

Luffing Jib

- The luffing jib is a spatial lattice structure with equal section areas for inserts and tapered section areas for both ends. With pipes welded together, and boom tip and root strengthened with steel plates, it can better transfer the load.
- The length of the luffing jib ranges from 21m to 63m, increased by 3m progressively, which can be installed on boom from 26m-62m.
- Composition: jib base 6m×1, jib insert 3m×1, 6m×2, jib insert 12m×3, and jib top 6m×1. The upper boom point is installed on jib top.

Hook Block

- There are five hook capacity for options:

Hook Type	Max. lifting weight	QTY	No. of sheaves	Unit weight
260t	260t	1	9	4.82t
160t	160t	1	5	3.02t
100t	100t	1	3	2.14t
50t	50t	1	1	1.68t
16t ball hook	16t	1	None	0.92t

Safety Devices



Load Moment Indicator

- The proprietary load moment indicator is independently developed by SANY, which is a specially designed over-load protective system for SCC series crawler crane, with performance structural parameters of all series of crawler cranes directly stored inside, such as bearing curve, boom and jib weight, center of gravity, and other geometrical parameters. Moment calculation adopts the targeted optimization model and combines SANY technology accumulated in crawler crane industry for many years. Having the customized advantage, this system maximizes the utilization efficiency of the crane while guaranteeing the lifting safety so as to avoid the technology disconnection and different after-sales service due to the separation between the crane and LMI, thus improving the overall quality of the crane.
- As independent safety control system fully controlled by computer, the LMI can automatically detect the load weight, work radius, and boom angle, compare rated capacity with actual load, actual radius and actual boom angle. In normal operation, the LMI can intelligently determine and cut off the crane from the dangerous direction. It also has black box function and record overload information.
- LMI consists of large colourful display, main machine, angle sensor, load sensor and pressure sensor.

Over-hoist Protection of the Main and Auxiliary Hooks

- It is used to prevent the over-hoist of the hook. When the lifting hook is raised to a certain height, the limit switch will start working, and hook will be automatically cut off from moving up by the control system. Meanwhile, the display and the buzzer will give alarms. At this moment, only hook lowering is allowed to prevent over-hoist action.

Over-release Protection Device of the Main and Auxiliary Hook

- It is used to prevent the wire rope over-release. When the wire rope is released to the last three wraps, the limit switch will start working, and the releasing of rope will be automatically stopped by the control system. Meanwhile, the display and the buzzer will give alarms. At this moment, only rope retraction is allowed to prevent over release action.

Assembly/Work Mode Switch

- In assembly mode, some of the safety devices are ineffective for helping crane assembly, for example, jib lower limit, LMI boom angle limit and overload.
- In work mode, all safety devices can work.

Crane Boom/Jib Limit Device

- When the elevation angle of the boom exceeds 85° or 88° (LJ configuration) jib angle exceeds 75°, corresponding limit switch will be triggered, and the control system will automatically cut off the boom hoisting. Meanwhile, the display and the buzzer will give alarm. At this moment, boom/jib luffing winch won't hoist but it can still lower down.
- When the boom down angle is less than 30° or jib down angle is less than 15°, the control system will automatically cut off the boom/jib from further lowering. Meanwhile, the display and the buzzer will give alarms. At this moment, boom/jib luffing winch won't be able to lower. This protection is automatically controlled by Load Moment Limiter.

Back-stop Device

- The boom and the jib are respectively equipped with a pair of back-stop cylinders. The high pressure of the cylinder shall be overcome when the boom tilts backwards, and high pressure oil will be supplemented automatically when the boom swings forwards to increase the tension and prevent the boom vibration and shaking back. When the jib reaches to an angle too small with the boom, the back-stop device can prevent it tipping back.

Hoisting Mechanism Brake

- All hoisting brakes are spring loaded normally closed disc brakes, which are featured with large braking force, maintenance-free, safe and reliable use, and long service life.

Closed Circuit Monitoring System(zoom camera)

- High-definition camera on boom tip, on each winch, at the rear of rotating bed and dual displays consist the CCTV monitoring system, which can display four photos at the same time. Real-time monitoring of each winch mechanism wire rope reeving and circumstances around the equipment is provided to make sure the operator can understand clearly and make sure the load safety. The camera can zoom in/out as needed.
- Components of the camera: wireless remote transmitter, wireless remote receiver, zoom camera.
- The video recorder can store the monitoring video for as long as 76hs.
- Crane operation can be stored.



Safety Devices

Fault Auto-Diagnosis System

- Faults can be conveniently eliminated based on the fault code.

Black Box

- It is able to record the operation data and machine movement, and analyze the remaining running conditions and service life of machine based on the actual performance.

Pharos

- It is mounted on the top of the boom/jib and alerts in air during night.

Anemometer

- It is mounted on the top of the boom/jib to monitor the wind speed in real time and display relative data on the monitor.

Electronic Level Indicator

- It displays the tilting angle of the crane on the monitor in real time and protects the safe operation of the crane.

Lightning Protection Device

- It includes the lightning protection device and the surge protection device, which can effectively protect the electric system elements and workers from lightning.

Boom Angle Indicator

- It is a pendulum-type angle indicator fixed on one side of the boom base.

Hook Latch

- The lifting hook is installed with a baffle plate to prevent wire rope from falling off.

Swing and Traveling Alarm

- During swing and traveling, the alarm horn will be blown per certain frequency to alert the personnel around the crane. The horn can be shut off through the display.

Function Lock

- The operation will be locked by pulling up the function locking lever on the right side of the seat inside the driver's cab or when the operator left the seat, after which no operating handles will be working so that improper operation caused by the body collision when getting on and off the crane can be avoided.

Regulation of Engine Power Ultimate Load and Stalling Protection

- The controller can monitor the engine power so as to prevent stalling.

Remote Monitoring System

- It monitors and analyzes the operation data so as to realize remote diagnosis of faults and timely solution.

Proactive Safety Control Technology

- Reduce the slewing speed automatically based on boom length and make it safer;
- Flexible safety protection: reduce the action speed when approaching safety limit, making it stable and reliable;
- Real-time monitor of hydraulic oil temperature. Limit the activity according to hydraulic temperature and protect the hydraulic components effectively;
- In man-machine interface, this protection can be set valid or invalid, and provide more human-friendly design.



SCE2800A
SANY CRAWLER CRANE
280 TONS LIFTING CAPACITY

QUALITY CHANGES THE WORLD

Technical Parameters

- Page 11 Main Performance Parameters
- Page 12 Basic Dimensions of Crane
- Page 13 Transportation Dimensions
- Page 18 Transport Plan
- Page 21 Schematics for Assembly/Disassembly

> 10

Main Performance Parameters

Major Performance Specifications of SCE2800A			
Performance Indicators		Unit	Parameter
H Configuration	Max. rated lifting capacity	t	280
	Max. rated lifting moment	t·m	187.5×8=1500
	Boom length	m	20~92
	Boom angle	°	30~85
FJ Configuration	Longest boom + longest fixed jib	m	62+42
	Boom to jib angle	°	10, 30
Luffing jib	Largest lifting moment	t·m	102×12=1224
	Longest boom + longest luffing jib	m	62+63
	Boom luffing angle	°	65~88
Speed	Speed of single rope of the main hoist (outermost work layer)	m/min	0~125
	Max speed of single rope of the main hoist (free fall) (optional)	m/min	0~117
	Max speed of single rope of the Aux. hoist	m/min	0~110
	Boom hoist winch speed (outermost layer)	m/min	0~132
	Jib hoist winch speed (outermost layer)	m/min	0~77
	Slewing speed	rpm	0~1.8
	Travel speed	km/h	0~1.0
Gradeability	%	30	
Machine weight	Basic boom, 100t rear counterweight, 40t carbody counterweight, 260t hook	t	255
Engine	Rated power	kW	298
	Rated speed	rpm	2100
	Max. set speed	rpm	1800
Transport	Max. transport weight of single part (with main and aux. hoist winches)	t	45.7
	Max. transport dimension of single part(L × W × H)	mm	13320×3000×3200
	Average ground pressure	MPa	0.14

Note: Any change in the technical parameters and configuration due to advancement in technology may occur without prior notice.

Basic Dimensions of Crane

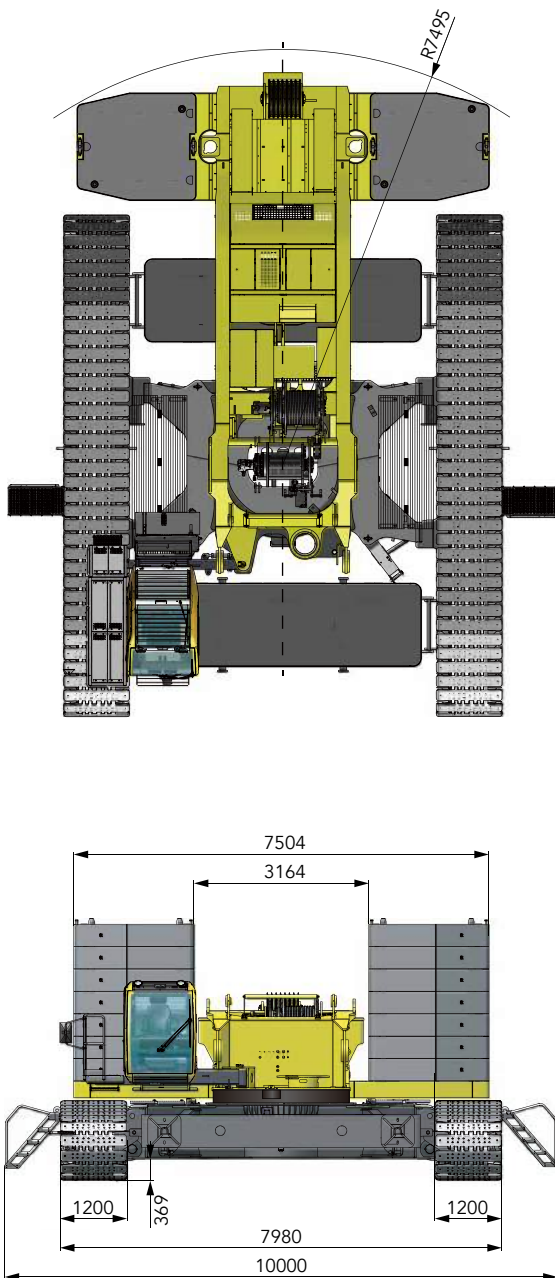

Transportation Dimensions

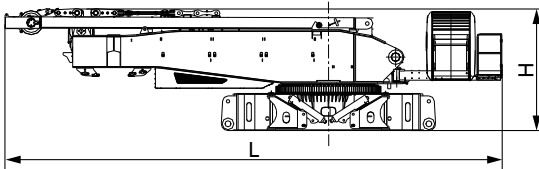

Basic Machine	×1
Length (L)	13.32m
Width (W)	3.00m
Height (H)	3.20m
Weight	45.7t

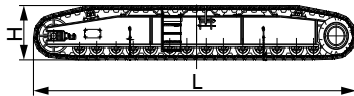

Crawler Assembly	×2
Length (L)	9.15m
Width (W)	1.20m
Height (H)	1.40m
Weight	22.0t

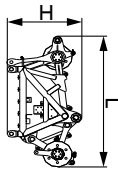

Boom Tip (with sheave block)	×1
Length (L)	3.24m
Width (W)	2.07m
Height (H)	1.62m
Weight	3.11t

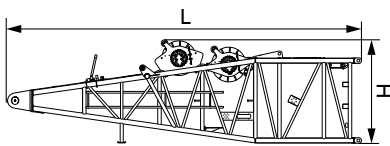

Boom Base (with main/ aux. hoist winch)	×1
Length (L)	10.35m
Width (W)	2.52m
Height (H)	2.99m
Weight	13.88t

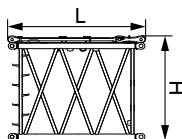

3m Boom insert	×1
Length (L)	3.18m
Width (W)	2.52m
Height (H)	2.66m
Weight	1.20t

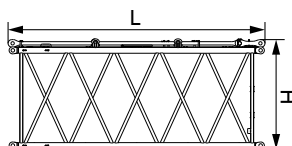

6m Boom insert	×2
Length (L)	6.18m
Width (W)	2.52m
Height (H)	2.66m
Weight	1.80t

Transportation Dimensions

12m boom insert ×5

Length (L)	12.18m
Width (W)	2.52m
Height (H)	2.66m
Weight	3.16t

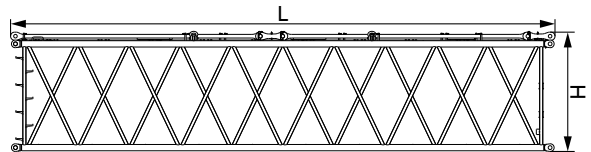

6m tapered boom insert ×1

Length (L)	6.20m
Width (W)	2.52m
Height (H)	2.66m
Weight	2.20t

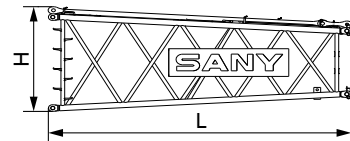

Luffing jib top ×1

Length (L)	6.46m
Width (W)	2.12m
Height (H)	2.10m
Weight	2.28t

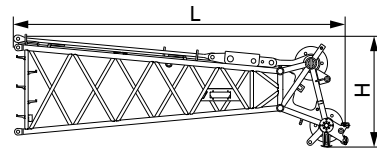

3m Luffing jib insert ×1

Length (L)	3.17m
Width (W)	2.12m
Height (H)	1.91m
Weight	0.67t

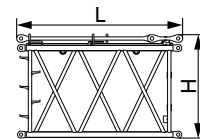

6m Luffing jib insert ×1

Length (L)	6.17m
Width (W)	2.12m
Height (H)	1.91m
Weight	1.09t

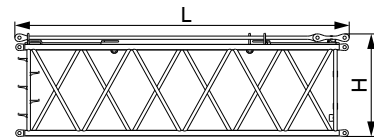

6m luffing jib insert ×1

Length (L)	6.17m
Width (W)	2.12m
Height (H)	1.91m
Weight	1.14t

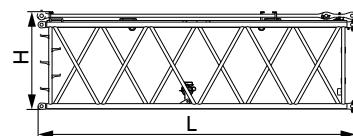

Transportation Dimensions

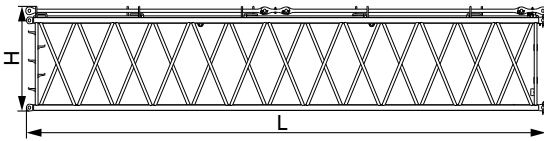

12m Luffing jib insert ×3

Length (L)	12.17m
Width (W)	2.12m
Height (H)	1.91m
Weight	1.97t

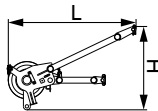

Extension jib ×1

Length (L)	2.2m
Width (W)	0.95m
Height (H)	1.44m
Weight	0.36t

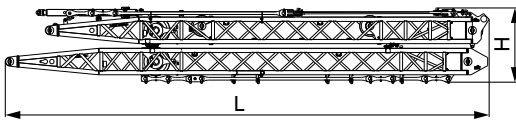

Front and rear mast of luffing jib ×1

Length (L)	10.88m
Width (W)	1.64m
Height (H)	1.70m
Weight	4.08t

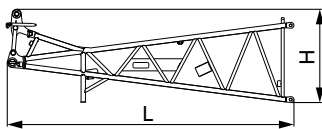

Luffing jib base ×1

Length (L)	6.18m
Width (W)	2.23m
Height (H)	2.01m
Weight	2.02t

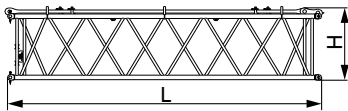

6m fixed jib insert ×1

Length (L)	6.11m
Width (W)	1.50m
Height (H)	1.42m
Weight	0.77t

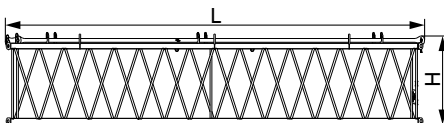

11.5m fixed jib insert ×2

Length (L)	11.67m
Width (W)	1.50m
Height (H)	1.42m
Weight	1.33t

Transportation Dimensions

Fixed jib base and mast ×1

Length (L)	6.70m
Width (W)	1.42m
Height (H)	2.00m
Weight	1.7t

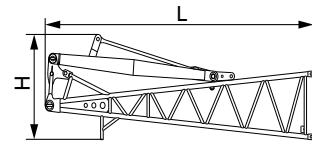

Fixed jib top ×1

Length (L)	7.10m
Width (W)	1.42m
Height (H)	1.43m
Weight	1.75t

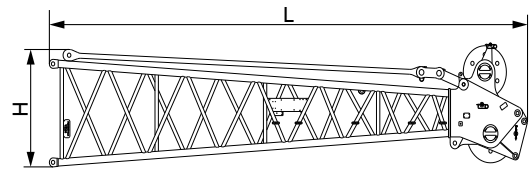

Carbody counterweight ×2

Length (L)	5.48m
Width (W)	1.97m
Height (H)	0.60m
Weight	20.0t

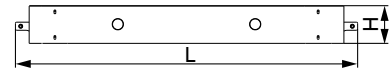

Rear counterweight tray ×1

Length (L)	7.50m
Width (W)	1.96m
Height (H)	0.70m
Weight	16.0t

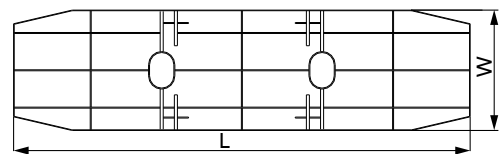

6t counterweight block ×14

Length (L)	2.17m
Width (W)	1.96m
Height (H)	0.50m
Weight	6.0t

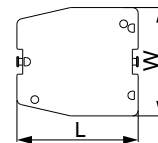

Trolley ×1

Length (L)	1.53m
Width (W)	1.48m
Height (H)	1.15m
Weight	0.34t

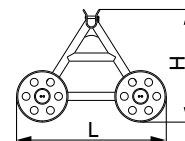

Transportation Dimensions

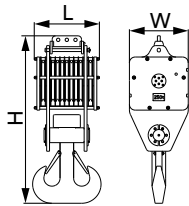

260t Hook		×1
Length (L)	1.04m	
Width (W)	1.02m	
Height (H)	2.93m	
Weight (with hoist)	4.82t	

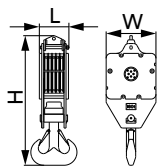

160t Hook		×1
Length (L)	0.60m	
Width (W)	1.02m	
Height (H)	2.64m	
Weight	3.02t	

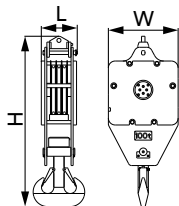

100t Hook		×1
Length (L)	0.51m	
Width (W)	1.02m	
Height (H)	2.48m	
Weight	2.14t	

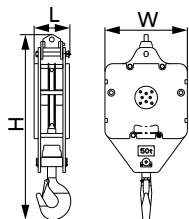

50t Hook		×1
Length (L)	0.44m	
Width (W)	1.02m	
Height (H)	2.27m	
Weight	1.68t	

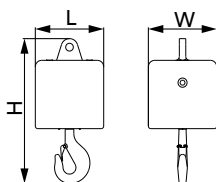

16t Hook		×1
Length (L)	0.53m	
Width (W)	0.53m	
Height (H)	1.10m	
Weight	0.92t	

Note:

1. The transport dimensions of each part in the table are schematic, not proportional to the real parts. The dimensions are designed value without package considered.
2. Weight is designed value that the actual manufactured part may deviate a little.
3. The dimensions and weight of each part may change due to product upgrading. The final values are subject to the new product.

Transport Plan

Transported Parts	▪ Basic Machine Mode 1
Transport weight	▪ 45.7t
Quantity	▪ 1

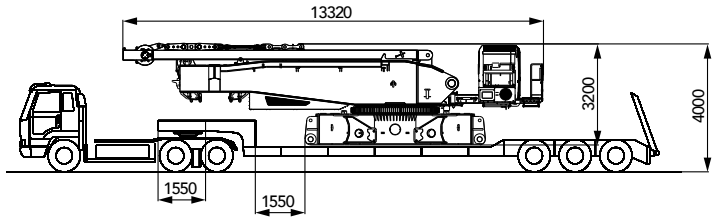

Transported Parts	Basic Machine Mode 2 (without outriggers and pads)
Transport weight	▪ 43.7t
Quantity	▪ 1

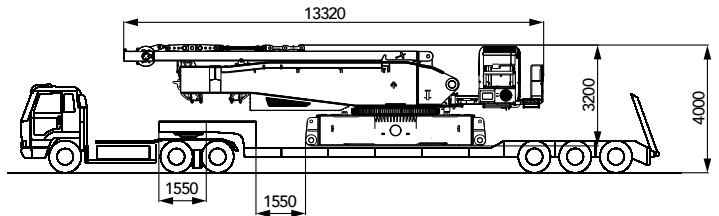

Transported Parts	▪ Right crawler assembly x1
Transport weight	▪ 22t
Quantity	▪ 1

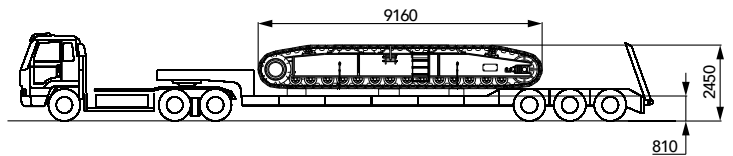

Transported Parts	▪ Left crawler assembly x1
Transport weight	▪ 22t
Quantity	▪ 1

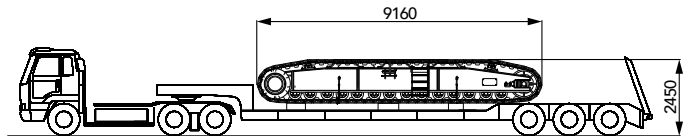

Transported Parts	▪ 6m jib insert I x1 ▪ 6m jib insert x1 ▪ Rear counterweight tray x1
Transport weight	▪ 18.2t
Quantity	▪ 1

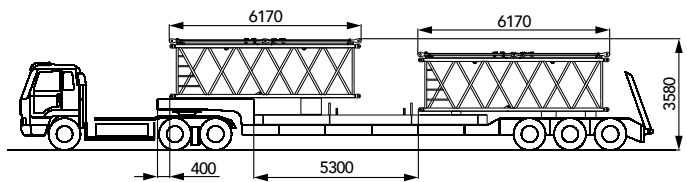

Transported Parts	▪ 6t counterweight block x2 ▪ 12m boom insert x1 ▪ 12m jib insert x1
Transport weight	▪ 17.2t
Quantity	▪ 3

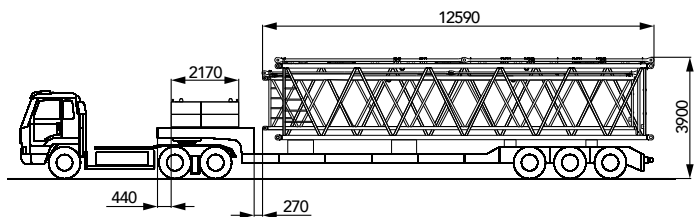

Transport Plan

Transported Parts	<ul style="list-style-type: none"> 6t counterweight block x2 12m boom insert x1 11.5m fixed jib insert x1 Attachment tools x1
Transport weight	17.1t
Quantity	2

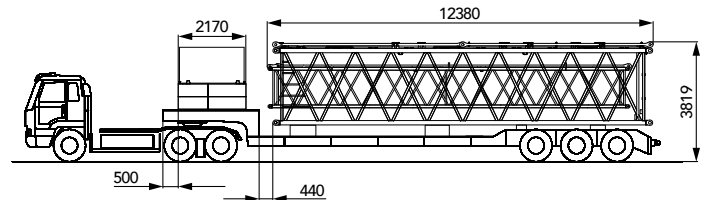

Transported Parts	Carbody counterweight x1
Transport weight	20t
Quantity	2

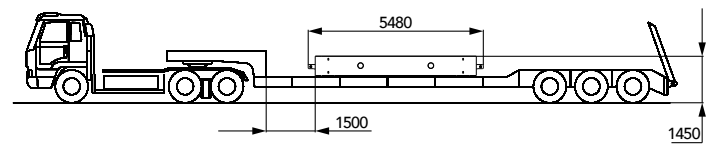

Transported Parts	<ul style="list-style-type: none"> 260t hook x1 Boom base(with main. aux hoist winch) x1 Trolley x1
Transport weight	19.1t
Quantity	1

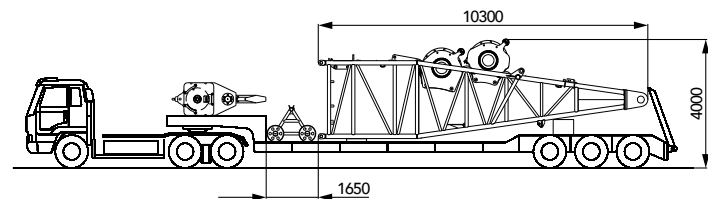

Transported Parts	<ul style="list-style-type: none"> 6t counterweight block x2 6m boom insert x2
Transport weight	15.6t
Quantity	1

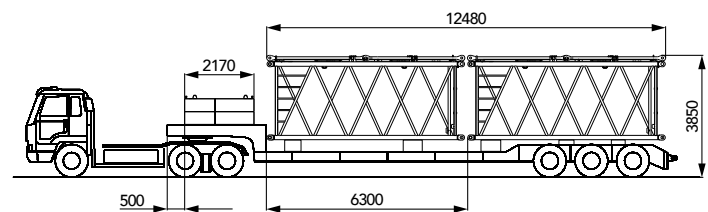

Transported Parts	<ul style="list-style-type: none"> 6t counterweight block x2 Fixed jib base(with fixed jib mast) x1 Fixed jib top x1
Transport weight	15.5t
Quantity	1

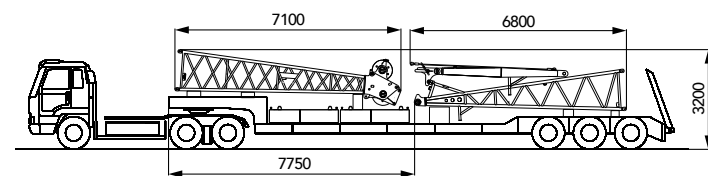

Transported Parts	<ul style="list-style-type: none"> (Tapered boom insert+boom tip+sheave block) x1 Extension jib x1 3m boom insert x1
Transport weight	6.9t
Quantity	1

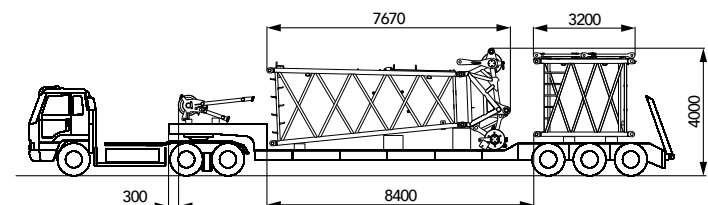

Transport Plan

Transported Parts	<ul style="list-style-type: none"> ▪ Front and rear mast of luffing jib ×1 ▪ 160t hook ×1 ▪ 16t hook ×1
Transport weight	▪ 8t
Quantity	▪ 1

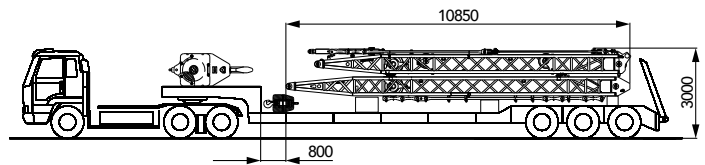

Transported Parts	<ul style="list-style-type: none"> ▪ 50t hook ×1 ▪ Luffing jib top ×1 ▪ Luffing jib base ×1
Transport weight	▪ 6t
Quantity	▪ 1

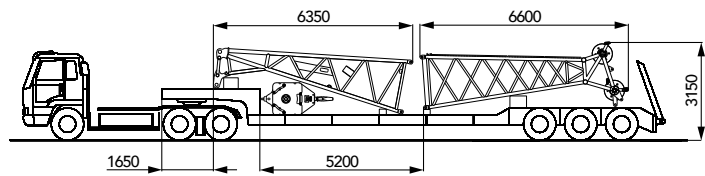

Transported Parts	<ul style="list-style-type: none"> ▪ 100t hook ×1 ▪ 6m fixed jib insert ×1 ▪ 3m jib insert ×1
Transport weight	▪ 4t
Quantity	▪ 1

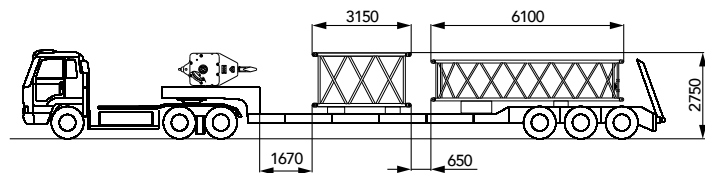

Schematics for Assembly/Disassembly

Schematics for self-assembly of basic machine

1) Self-assembly of basic machine

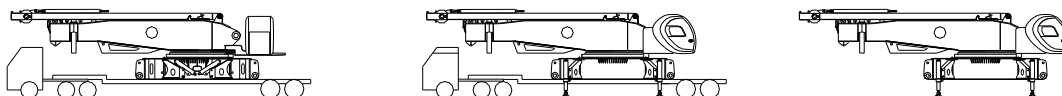

2) Self-assembly of track frame

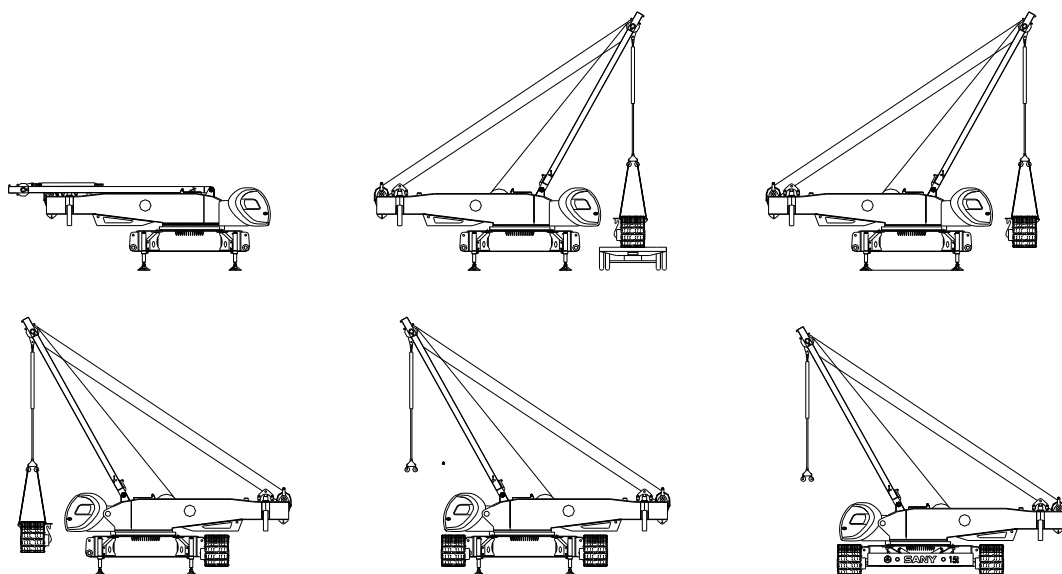

3) Self-assembly of counterweight and boom base

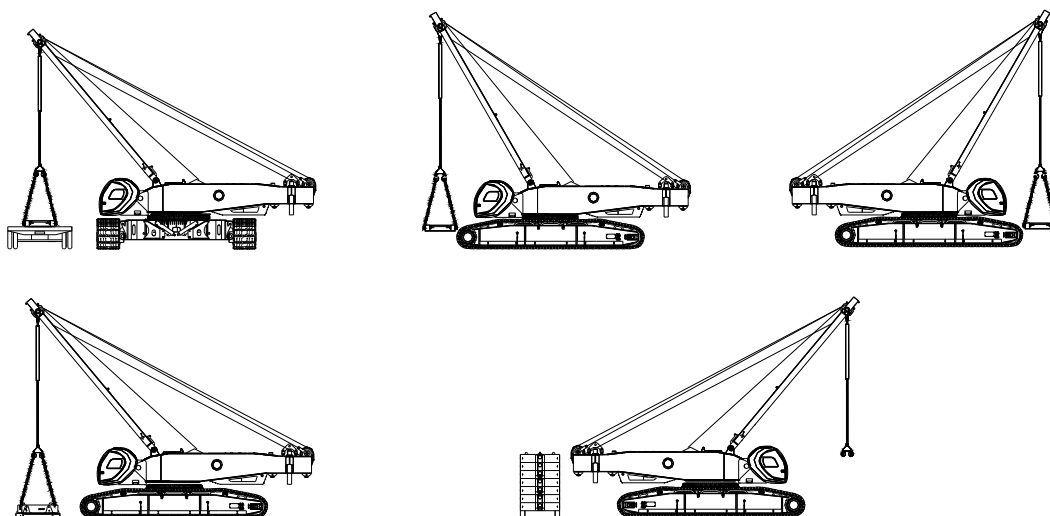

Schematics for Assembly/Disassembly

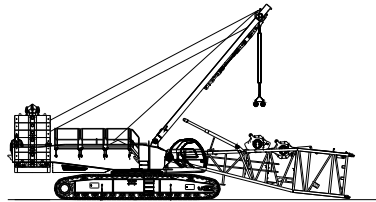
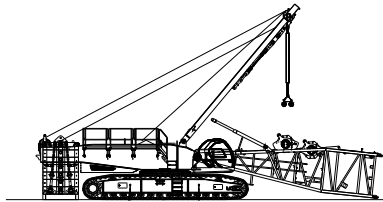
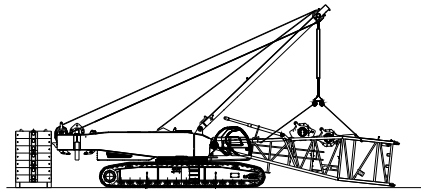
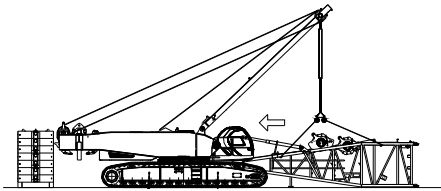

Schematics of boom assembly

1) Boom assembly

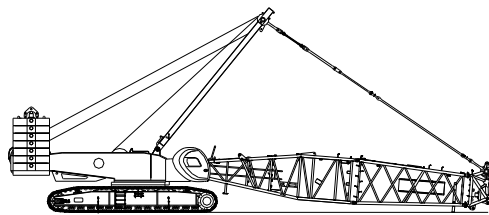
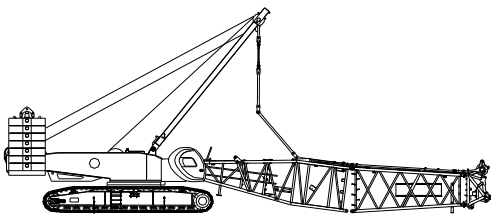

2) Luffing jib assembly

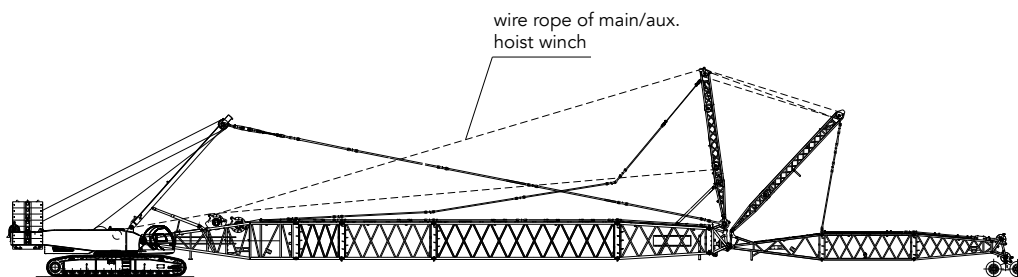
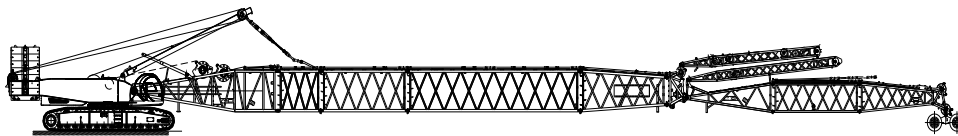

Schematics for Assembly/Disassembly

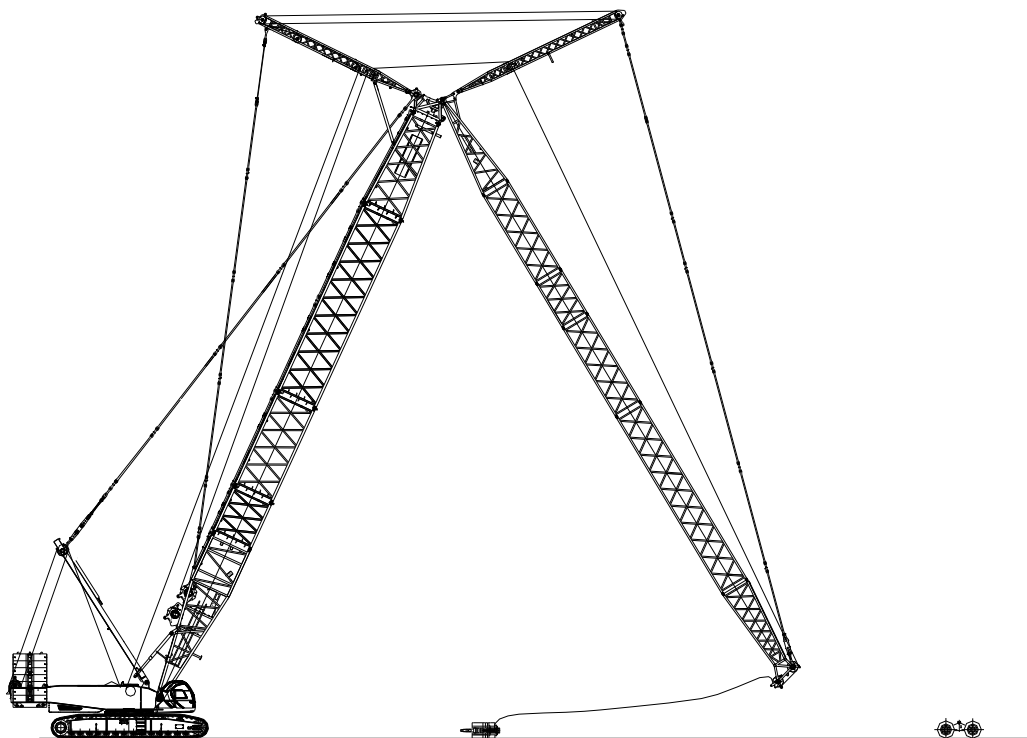

3) Fixed jib assembly

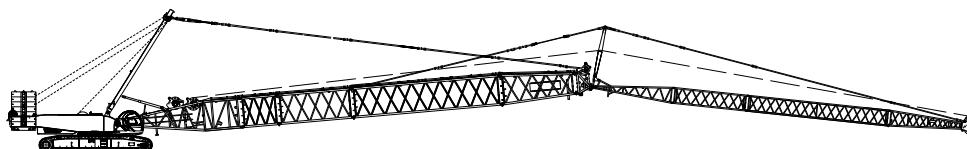
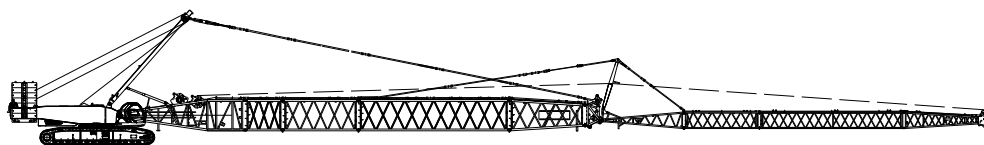



SCE2800A
SANY CRAWLER CRANE
280 TONS LIFTING CAPACITY

QUALITY CHANGES THE WORLD

Configurations

- Page 25 Boom Combination
- Page 26 H Configuration
- Page 30 FJ Configuration
- Page 41 LJ Configuration

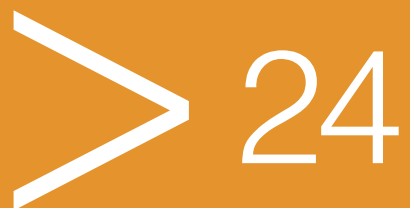

Boom combination

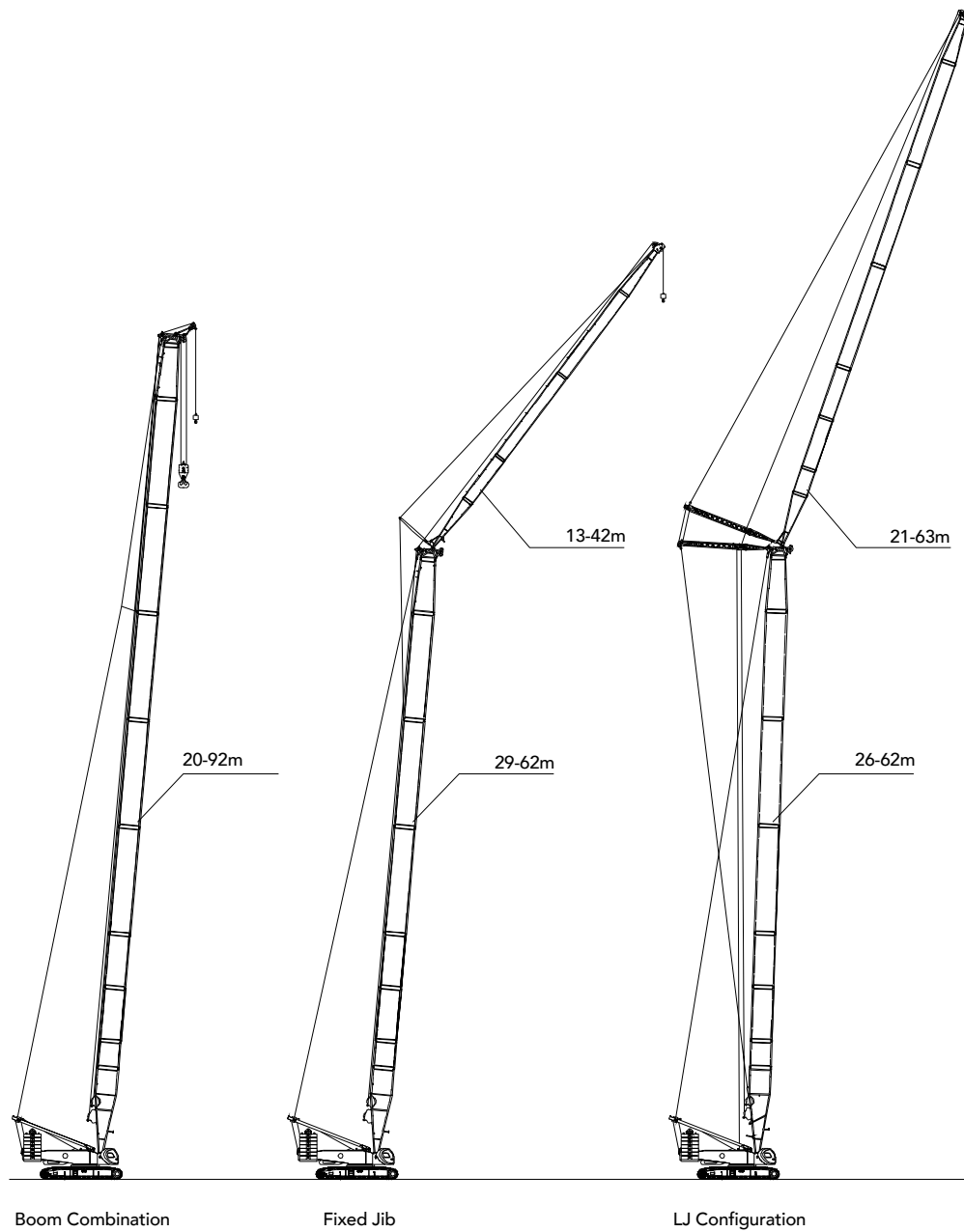

Boom Configuration (H)

Boom Configuration (H)			
Boom length (m)	Insert		
	3m	6m	12m
20	1	-	-
23	-	1	-
26	1	1	-
29	-	-	1
32	1	-	1
35	-	1	1
38	1	1	1
41	-	-	2
44	1	-	2
47	-	1	2
50	1	1	2
53	-	-	3
56	1	-	3
59	-	1	3
62	1	1	3
65	-	-	4
68	1	-	4
71	-	1	4
74	1	1	4
77	-	-	5
80	1	-	5
83	-	1	5
86	1	1	5
89	-	2	5
92	1	2	5

Note: 20m basic boom consists of 10m boom section, 3m boom insert, 6m transition section and 1m boom head.

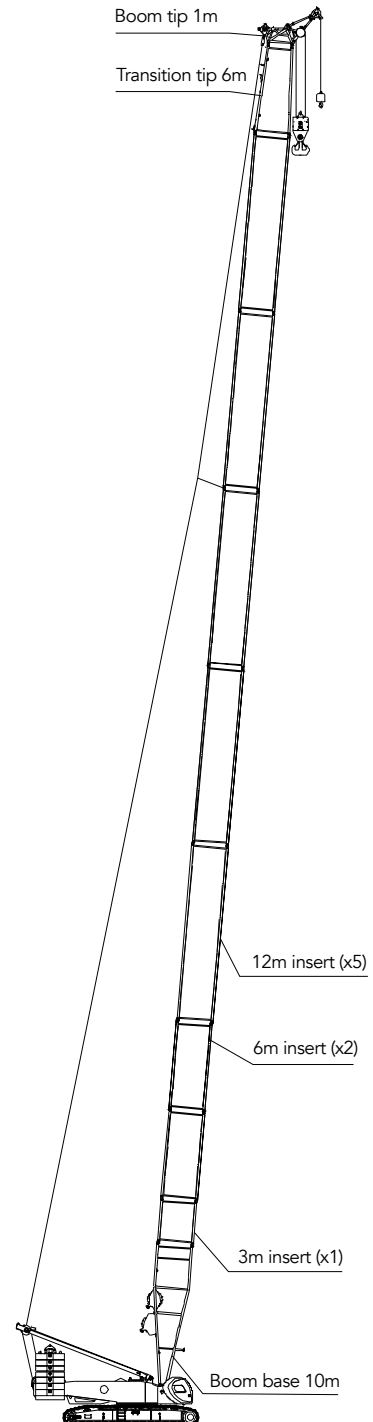

Working Radius in H Configuration

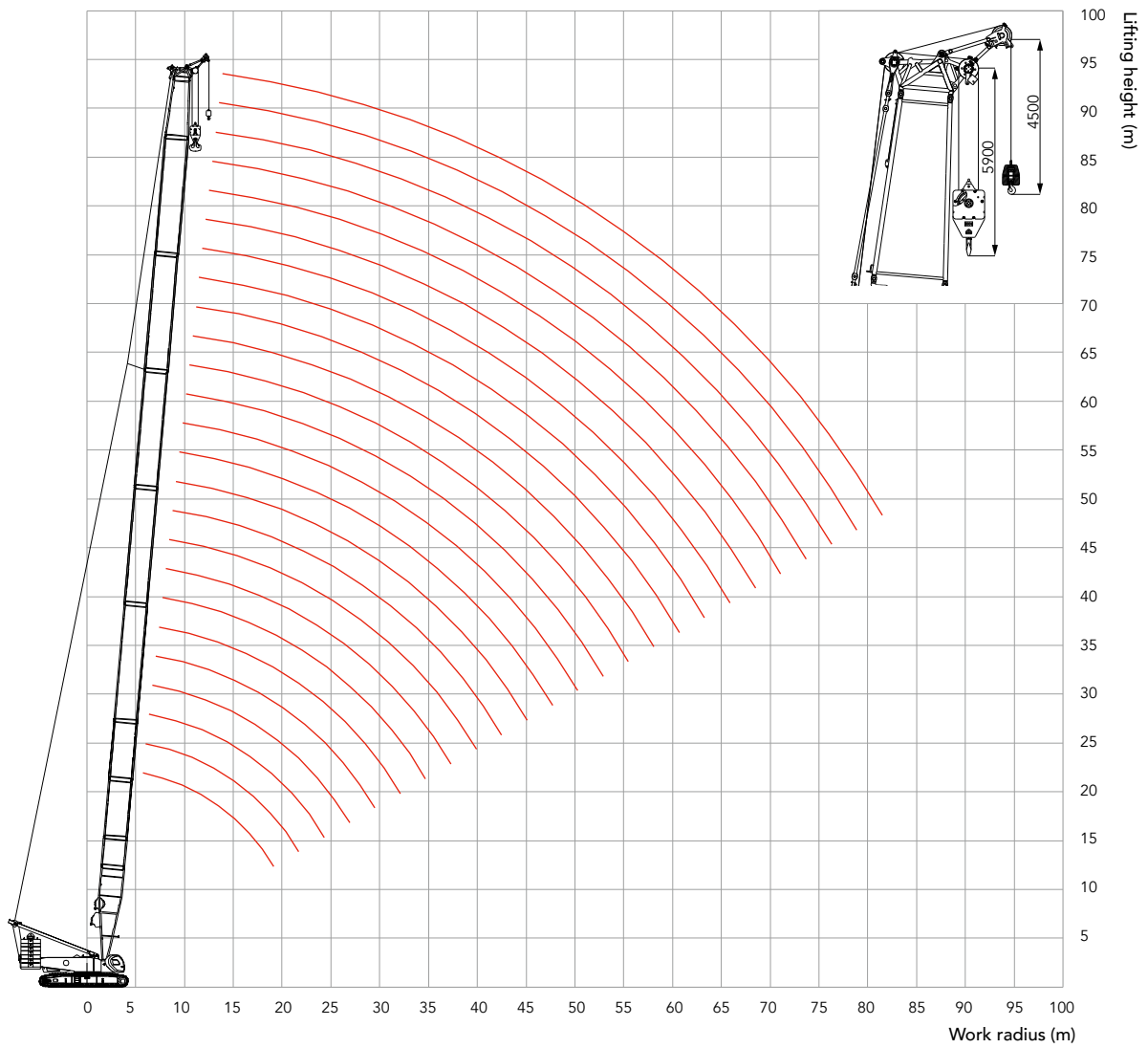

Load Chart of H Configuration

Load chart - H (Boom 20~92m, Rear counterweight 100t, Carbody counterweight 40t) 1/2														
Boom length (m) Radius (m)	20	23	26	29	32	35	38	41	44	47	50	53	56	Boom length (m) Radius (m)
5	280													5
6	238.4	224.9	223.6	204.2	194									6
7	207.9	207.6	202.2	191.4	174.4	169.1	165	158						7
8	187.5	178.3	174.4	170.6	166.3	157.9	156.5	141.8	126.3	125	124	122		8
9	156.1	153.4	149.4	145.4	142.7	142.7	141.3	130.2	122.1	117.6	115	114	114	9
10	141.2	137.8	135.7	132.2	130.1	129.2	128	125.8	115.5	115.5	107.1	104.9	92	10
12	119	120	119	116	114	111	109	107	104	102	100	98.2	91	12
14	95.2	95.7	95.8	96	95.3	93.5	91.6	89.9	88.1	86.4	84.6	83.1	81.4	14
16	78.4	78.9	79	79.3	79.3	79.3	78.4	77.1	75.6	74.3	72.8	71.6	70.2	16
18	66	66.7	66.8	67.1	67.1	67.1	66.9	67	65.9	64.8	63.6	62.6	61.4	18
20		57.3	57.5	57.8	57.8	57.8	57.6	57.7	57.5	57.2	56.2	55.3	54.3	20
22		49.8	50.1	50.5	50.5	50.5	50.3	50.3	50.1	50	49.8	49.3	48.4	22
24			44.1	44.5	44.5	44.6	44.4	44.4	44.2	44.1	43.8	43.8	43.4	24
26				39.6	39.6	39.7	39.5	39.6	39.3	39.2	39	38.9	38.6	26
28					35.5	35.5	35.4	35.4	35.2	35.1	34.9	34.8	34.5	28
30					31.9	32	31.9	31.9	31.7	31.6	31.4	31.3	31	30
32						28.9	28.8	28.9	28.7	28.6	28.3	28.3	28	32
34							26.2	26.3	26.1	26	25.7	25.6	25.4	34
36								23.9	23.8	23.7	23.4	23.3	23.1	36
38									21.7	21.6	21.4	21.3	21	38
40									19.8	19.8	19.5	19.5	19.2	40
44											16.3	16.3	16	44
48												13.7	13.4	48
52														52
56														56
60														60
64														64
68														68
72														72

Unit: t

Load Chart of H Configuration

Load chart - H (Boom 20~92m, Rear counterweight 100t, Carbody counterweight 40t) 2/2													
Boom length (m) Radius (m)	59	62	65	68	71	74	77	80	83	86	89	92	Boom length (m) Radius (m)
5													5
6													6
7													7
8													8
9	101	98.9	98.9										9
10	90	90	90	85	83.3	80	72						10
12	87.2	85.6	76.8	72.8	67	63.7	60.4	60	57.4	53	47.9	44.1	12
14	79.9	78.3	76.8	71.8	65.1	60.3	54.9	51.8	51.2	50	45.9	42.1	14
16	68.9	67.6	66.4	65.1	63.9	54.9	52.1	48.2	47.5	46	42	40	16
18	60.3	59.2	58.2	57	56	54.9	47.7	45.5	44.9	39	35.5	32.4	18
20	53.3	52.3	51.4	50.5	49.5	48.6	47.7	42.9	39.4	35.9	31.1	28.8	20
22	47.5	46.6	45.9	45	44.2	43.3	42.5	41.7	36.6	32.1	27.1	25.1	22
24	42.7	41.8	41.2	40.4	39.6	38.8	38.1	37.3	36.6	31.1	26.3	23.9	24
26	38.4	37.8	37.2	36.4	35.7	35	34.4	33.6	32.9	28.7	25.3	22.7	26
28	34.3	34	33.7	33	32.3	31.6	31.1	30.4	29.7	27.4	24.2	21.8	28
30	30.8	30.5	30.4	30	29.4	28.7	28.2	27.5	26.9	26.3	23.1	21.1	30
32	27.8	27.5	27.4	27.1	26.8	26.1	25.6	25	24.4	23.8	21.7	20.1	32
34	25.2	24.9	24.7	24.4	24.2	23.8	23.4	22.8	22.2	21.6	21.1	18.9	34
36	22.9	22.6	22.4	22.1	21.9	21.6	21.3	20.7	20.2	19.6	19.1	18.5	36
38	20.8	20.5	20.4	20.1	19.8	19.5	19.3	18.9	18.4	17.9	17.3	16.8	38
40	19	18.7	18.6	18.2	18	17.7	17.5	17.2	16.8	16.2	15.7	15.2	40
44	15.9	15.6	15.4	15.1	14.9	14.6	14.4	14.1	13.8	13.4	13	12.4	44
48	13.3	13	12.9	12.5	12.3	12	11.8	11.5	11.2	10.9	10.6	10.1	48
52	11.1	10.8	10.7	10.4	10.2	9.8	9.7	9.3	9.1	8.7	8.5	8.1	52
56		8.9	8.8	8.5	8.3	8	7.8	7.5	7.2	6.9	6.6	6.3	56
60				6.9	6.7	6.4	6.2	5.9	5.7	5.3	5	4.7	60
64						5	4.8	4.5	4.3	3.9	3.7	3.3	64
68							3.6	3.3	3	2.7	2.4	2.1	68
72									2	1.6	1.4	1	72

FJ Fixed Jib

Fixed Jib				
Jib Length (m)	Insert		Boom Length (m)	Boom to jib angle
	6m	11.5m		
13	-	-	29m~62m	10° , 30°
19	1	-	29m~62m	10° , 30°
24.5	-	1	29m~62m	10° , 30°
30.5	1	1	29m~62m	10° , 30°
36	-	2	29m~62m	10° , 30°
42	1	2	29m~62m	10° , 30°

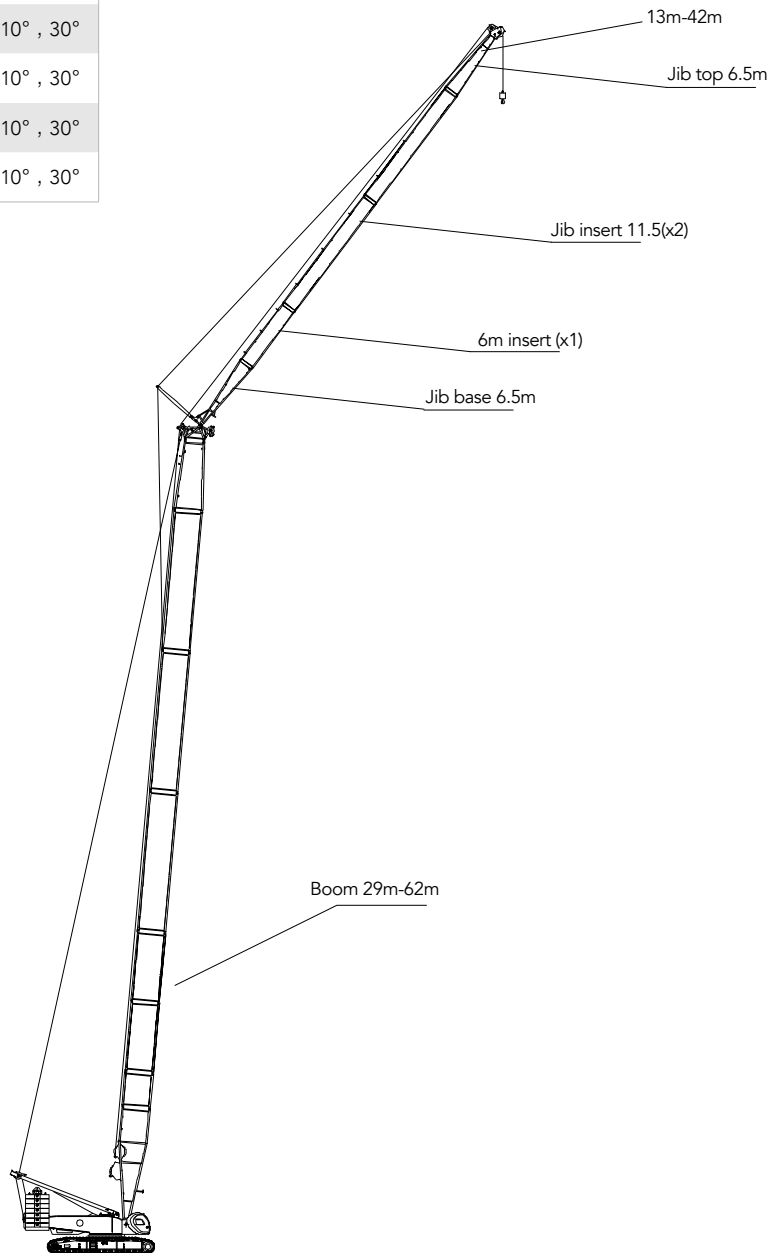

Working Radius in FJ Configuration

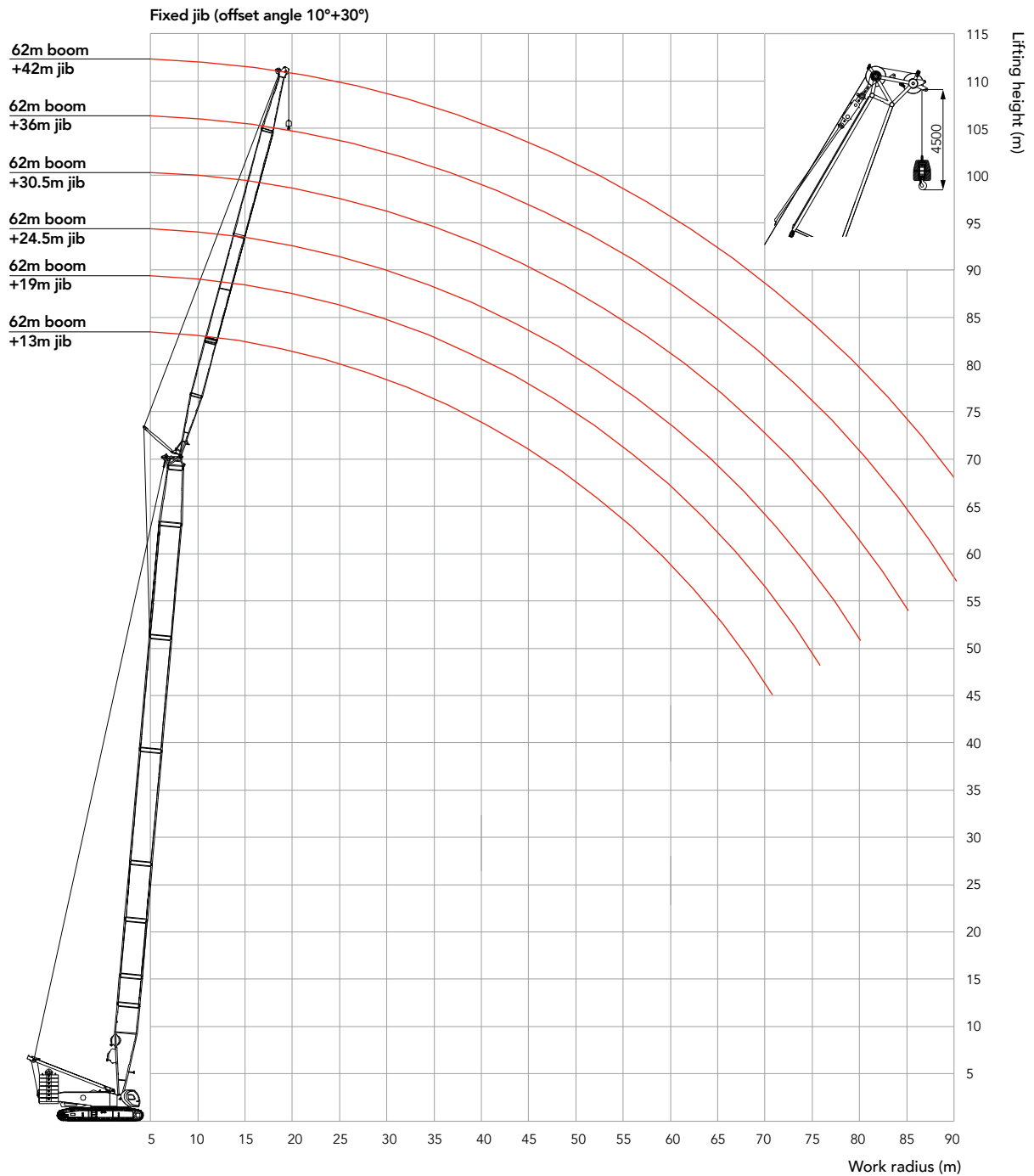

Fixed jib load

Load chart - FJ (Boom to jib angle 10°, Boom 29~62m, Carbody counterweight 40t, Rear counterweight 100t)1/6													
Jib 13m													
Boom length (m) Radius (m)	29	32	35	38	41	44	47	50	53	56	59	62	Boom length (m) Radius (m)
9	74.2												9
10	74.7	74	74.1	73.4	72.7								10
11	73.7	73.8	73.2	73.2	72.5	71.8	70.8	70					11
12	72.8	72.9	72.3	72.3	71.9	71.3	70.5	69.6	69.2	68.2	66.9	66	12
14	71.6	71.7	71.1	71.2	70.5	70.5	69.8	68.8	68.2	67.6	66.3	65.6	14
16	67.8	70	69.8	69.5	69.6	69.5	68.4	67.9	67.2	66.2	65	63.8	16
18	59.3	62.1	66	64.7	63.6	62.4	61.3	60.2	59.1	58	57	55.9	18
20	52.6	55.8	58.3	57.2	56.3	55.2	54.2	53.2	52.3	51.3	50.4	49.4	20
22	47.3	50.2	51.4	51	50.2	49.3	48.4	47.5	46.7	45.8	44.9	44	22
24	43	45.5	45.3	45.1	44.9	44.2	43.5	42.6	41.9	41	40.3	39.5	24
26	39	40.5	40.4	40.1	39.9	39.6	39.3	38.5	37.8	37	36.3	35.5	26
28	36	36.4	36.2	35.9	35.7	35.4	35.2	34.9	34.3	33.5	32.9	32.1	28
30	33.1	32.8	32.6	32.3	32.2	31.9	31.6	31.3	31.2	30.5	29.9	29.2	30
32	30	29.7	29.5	29.2	29.1	28.8	28.6	28.3	28.1	27.8	27.2	26.5	32
34	27.3	27	26.8	26.5	26.4	26.1	25.9	25.6	25.4	25.1	24.8	24.2	34
36	24.9	24.6	24.5	24.2	24	23.7	23.5	23.2	23	22.7	22.5	22.1	36
38	22.8	22.5	22.4	22.1	22	21.6	21.4	21.1	20.9	20.6	20.4	20	38
40		20.6	20.5	20.2	20.1	19.8	19.5	19.2	19.1	18.7	18.5	18.2	40
44			17.2	17	16.9	16.6	16.3	16	15.8	15.5	15.3	14.9	44
48					14.2	13.9	13.7	13.4	13.2	12.9	12.6	12.3	48
52						11.6	11.4	11.1	11	10.7	10.4	10.1	52
56								9.2	9.1	8.7	8.5	8.2	56
60									7.4	7.1	6.9	6.5	60
64											5.4	5.1	64
68												3.8	68

Unit: t

Fixed jib load

Load chart - FJ (Boom to jib angle 10°, Boom 29~62m, Carbody counterweight 40t, Rear counterweight 100t)2/6													
Jib 19m													
Boom length (m) Radius (m)	29	32	35	38	41	44	47	50	53	56	59	62	Boom length (m) Radius (m)
11	61.7	63.2	63.7										11
12	56.9	58.2	59	60	60.6	61.7	61.6						12
14	48.4	50.2	51.5	52.6	53.5	54.4	54.8	55.5	56.1	56.3	56.3	56.6	14
16	42.4	44.1	45.3	46.3	47.4	48.7	49.5	50	50.9	51.4	51.7	51.7	16
18	37.6	39.1	40.2	41.6	42.6	44	44.6	45.4	46.2	46.8	47.5	48	18
20	33.5	35.2	36.5	37.4	38.8	39.8	40.8	41.8	42.4	43.2	43.6	44.3	20
22	30.3	31.7	33.1	34.2	35.3	36.3	37.5	38.4	39	40	40.6	41	22
24	27.5	29	30.2	31.4	32.6	33.5	34.7	35.5	36.3	37.3	38	38.5	24
26	25.4	26.6	27.9	28.9	30	31.3	31.9	32.9	33.7	34.5	35.4	35.5	26
28	23.3	24.5	25.7	26.9	28	28.9	30.1	30.7	31.7	32.4	32.9	32.2	28
30	21.6	22.8	23.9	25	25.9	27	27.9	28.8	29.7	30.4	29.9	29.3	30
32	20.1	21.2	22.3	23.3	24.3	25.4	26.2	27.2	27.8	27.9	27.3	26.7	32
34	18.7	19.9	21	21.8	23	23.8	24.8	25.6	26	25.6	25	24.4	34
36	17.6	18.6	19.6	20.6	21.5	22.4	23.3	23.8	23.6	23.3	22.9	22.3	36
38	16.6	17.5	18.5	19.5	20.4	21.2	22.1	21.7	21.5	21.2	21	20.4	38
40	15.6	16.6	17.6	18.4	19.3	20.2	20.2	19.8	19.6	19.3	19.1	18.7	40
44	14.1	14.8	15.7	16.5	17.4	17.2	17	16.6	16.4	16.1	15.8	15.5	44
48		13.6	14.3	15	14.9	14.5	14.3	14	13.8	13.4	13.2	12.8	48
52				12.7	12.6	12.3	12.1	11.7	11.5	11.2	10.9	10.6	52
56						10.4	10.1	9.8	9.6	9.3	9	8.7	56
60							8.4	8.1	8	7.6	7.4	7.1	60
64									6.5	6.2	5.9	5.6	64
68										4.9	4.7	4.3	68
72												3.2	72

Fixed jib load

Load chart - FJ (Boom to jib angle 10°, Boom 29~62m, Carbody counterweight 40t, Rear counterweight 100t)3/6													
Jib 24.5m													
Boom length (m) Radius (m)	29	32	35	38	41	44	47	50	53	56	59	62	Boom length (m) Radius (m)
14	36.3	37.3	37.8	38.4	39.3	39.5							14
16	31.9	32.7	33.7	34.3	35	35.5	36	36.5	37	37.2	37.6	37.7	16
18	28.4	29.4	30.1	30.8	31.5	32	32.7	33.3	33.7	34	34.6	34.8	18
20	25.5	26.3	27.4	28	28.6	29.3	29.7	30.5	31	31.5	31.7	32.2	20
22	23.1	24	24.7	25.6	26.2	26.8	27.5	28.1	28.6	29	29.6	29.9	22
24	20.9	21.8	22.6	23.3	24.3	24.8	25.4	26	26.5	27	27.5	27.9	24
26	19.1	20	20.9	21.6	22.3	23.2	23.5	24	24.6	25.2	25.5	26	26
28	17.7	18.4	19.3	20.1	20.8	21.3	22.1	22.5	23	23.5	24.1	24.6	28
30	16.3	17.2	17.9	18.6	19.3	19.9	20.5	21.4	21.6	22.1	22.7	23	30
32	15.2	15.9	16.6	17.4	18.1	18.7	19.4	19.9	20.6	20.9	21.3	21.9	32
34	14.2	15	15.5	16.4	16.9	17.5	18.2	18.8	19.4	19.9	20.3	20.6	34
36	13.2	13.9	14.7	15.3	15.8	16.5	17.1	17.6	18.3	18.9	19.2	19.6	36
38	12.5	13.1	13.8	14.3	15	15.6	16.2	16.7	17.3	17.9	18.4	18.6	38
40	11.8	12.3	13.1	13.6	14.3	14.8	15.3	15.9	16.5	16.9	17.5	17.9	40
44	10.4	11.1	11.6	12.3	12.8	13.4	13.8	14.4	14.9	15.4	15.9	16.2	44
48	9.4	10	10.5	11.1	11.6	12.1	12.7	13.1	13.6	14.1	13.8	13.5	48
52		9.1	9.5	10.1	10.6	11.1	11.6	12	12.2	11.8	11.6	11.3	52
56			8.8	9.2	9.7	10.2	10.6	10.4	10.2	9.9	9.7	9.3	56
60					8.9	9.3	9.1	8.8	8.6	8.2	8	7.7	60
64							7.6	7.3	7.1	6.8	6.5	6.2	64
68								6	5.8	5.5	5.2	4.9	68
72										4.3	4.1	3.7	72
76											3	2.7	76

Unit: t

Fixed jib load

Load chart - FJ (Boom to jib angle 10°, Boom 29~62m, Carbody counterweight 40t, Rear counterweight 100t)4/6													
Jib 30.5m													
Boom length (m) Radius (m)	29	32	35	38	41	44	47	50	53	56	59	62	Boom length (m) Radius (m)
14	29.2												14
16	25.7	26.3	26.6	27.3	27.5	28	28.4	28.6	28.9				16
18	22.8	23.3	24	24.4	24.8	25.3	25.6	25.9	26.3	26.5	26.8	26.9	18
20	20.4	20.9	21.6	22.1	22.7	23	23.4	23.7	24	24.4	24.7	24.9	20
22	18.6	19.2	19.7	20.1	20.6	21	21.4	21.9	22.3	22.6	22.8	23.2	22
24	16.9	17.5	18.1	18.6	18.8	19.3	19.8	20.3	20.5	21	21.3	21.6	24
26	15.4	16.1	16.5	17.1	17.7	18	18.3	18.8	19.1	19.5	19.9	20.1	26
28	14.2	14.8	15.3	15.9	16.3	16.8	17.2	17.5	17.9	18.3	18.6	19	28
30	13.1	13.6	14.2	14.7	15.2	15.7	16.1	16.5	16.7	17.1	17.5	17.7	30
32	12.1	12.7	13.2	13.7	14.1	14.6	15.1	15.5	15.7	16.1	16.4	16.7	32
34	11.2	11.8	12.3	12.8	13.3	13.6	14.1	14.5	15	15.2	15.5	15.9	34
36	10.5	11	11.5	11.9	12.5	12.9	13.4	13.8	14.1	14.5	14.6	15.1	36
38	9.8	10.3	10.8	11.2	11.6	12.2	12.6	12.9	13.4	13.7	14.2	14.3	38
40	9.2	9.7	10.1	10.5	11	11.5	11.8	12.3	12.6	13.1	13.4	13.7	40
44	8.2	8.5	9.1	9.4	9.9	10.2	10.6	11	11.4	11.7	12.1	12.4	44
48	7.2	7.7	8.1	8.5	8.9	9.2	9.6	10	10.3	10.7	11	11.4	48
52	6.5	6.9	7.3	7.7	8	8.3	8.8	9.1	9.4	9.7	10.1	10.4	52
56	5.9	6.3	6.6	7	7.4	7.7	8	8.3	8.6	8.9	9.3	9.6	56
60			6	6.4	6.7	7	7.3	7.7	8	8.2	8.3	7.9	60
64				5.8	6.2	6.5	6.8	7.1	7.3	7.1	6.8	6.5	64
68						5.9	6.2	6.3	6.1	5.8	5.5	5.2	68
72							5.5	5.2	5	4.6	4.4	4	72
76									3.9	3.6	3.3	3	76
80											2.4	2.1	80
84												1.2	84

Fixed jib load

Load chart - FJ (Boom to jib angle 10°, Boom 29~62m, Carbody counterweight 40t, Rear counterweight 100t)5/6													
Jib 36m													
Boom length (m) Radius (m)	29	32	35	38	41	44	47	50	53	56	59	62	Boom length (m) Radius (m)
16	21.8	22.3											16
18	19.3	19.7	20.1	20.5	20.8	21	21.4	21.5	21.6				18
20	17.2	17.7	18.1	18.6	18.9	19.2	19.4	19.6	19.8	20	20.4	20.4	20
22	15.5	16	16.5	16.9	17.1	17.5	17.7	18.1	18.4	18.7	18.9	19	22
24	14.1	14.6	15	15.3	15.7	16.1	16.4	16.7	17	17.3	17.5	17.7	24
26	12.9	13.4	13.7	14.2	14.4	14.8	15.2	15.5	15.7	16	16.2	16.5	26
28	11.8	12.3	12.6	13.1	13.4	13.8	14.1	14.5	14.7	14.9	15.3	15.5	28
30	10.9	11.2	11.7	12	12.4	12.8	13.1	13.5	13.7	14	14.2	14.4	30
32	10.1	10.4	10.9	11.2	11.5	11.9	12.2	12.5	12.8	13.1	13.4	13.6	32
34	9.3	9.7	10.1	10.4	10.7	11.2	11.4	11.8	12.1	12.4	12.7	12.9	34
36	8.6	9	9.3	9.7	10.1	10.4	10.7	11	11.4	11.7	11.9	12.1	36
38	8	8.5	8.8	9.1	9.4	9.8	10.1	10.3	10.7	11	11.2	11.5	38
40	7.4	7.9	8.3	8.6	8.9	9.2	9.4	9.8	10	10.3	10.6	10.9	40
44	6.6	6.9	7.3	7.6	7.9	8.2	8.5	8.8	9.1	9.2	9.5	9.8	44
48	5.8	6.1	6.4	6.7	7	7.3	7.6	7.9	8.2	8.5	8.6	8.9	48
52	5.1	5.4	5.7	6	6.4	6.7	7	7.2	7.5	7.8	8.1	8.3	52
56	4.6	4.9	5.2	5.5	5.7	6.1	6.3	6.6	6.8	7.1	7.3	7.6	56
60	4.1	4.4	4.7	5	5.2	5.5	5.7	6	6.2	6.4	6.7	7	60
64		4	4.2	4.5	4.7	5	5.2	5.5	5.7	5.9	6.2	6.4	64
68				4.1	4.3	4.6	4.8	5	5.2	5.5	5.7	5.3	68
72					4	4.2	4.4	4.6	4.8	5	4.8	4.2	72
76							4	4.2	4.3	4	3.7	3.3	76
80								3.5	3.4	3	2.8	2.5	80
84										2.2	1.9	1.6	84
88												0.8	88

Unit: t

Fixed jib load

Load chart - FJ (Boom to jib angle 10°, Boom 29~62m, Carbody counterweight 40t, Rear counterweight 100t)6/6													
Jib 42m													
Boom length (m) Radius (m)	29	32	35	38	41	44	47	50	53	56	59	62	Boom length (m) Radius (m)
18	16.5												18
20	14.8	15	15.3	15.5	15.8	16.1	16.2	16.4	16.5				20
22	13.2	13.6	13.9	14.1	14.4	14.7	14.8	15	15.3	15.4	15.6	15.7	22
24	11.9	12.3	12.6	12.9	13.2	13.4	13.6	13.9	14	14.2	14.4	14.6	24
26	10.9	11.2	11.5	11.8	12	12.4	12.5	12.8	13	13.2	13.4	13.5	26
28	9.9	10.2	10.5	10.8	11.1	11.4	11.6	11.8	12.1	12.3	12.4	12.7	28
30	9	9.4	9.7	10	10.3	10.5	10.8	11.1	11.2	11.4	11.6	11.8	30
32	8.3	8.6	8.9	9.3	9.5	9.7	10	10.2	10.5	10.7	10.9	11	32
34	7.6	7.9	8.3	8.5	8.8	9.1	9.3	9.6	9.8	10	10.2	10.4	34
36	7.1	7.3	7.7	7.9	8.2	8.4	8.7	8.9	9.1	9.4	9.6	9.8	36
38	6.5	6.8	7.1	7.4	7.6	7.9	8.2	8.4	8.6	8.8	9.1	9.2	38
40	6.1	6.3	6.6	6.9	7.1	7.4	7.7	7.9	8.1	8.3	8.6	8.8	40
44	5.2	5.5	5.7	6	6.3	6.5	6.7	6.9	7.2	7.4	7.6	7.8	44
48	4.5	4.7	5	5.3	5.5	5.7	6	6.2	6.4	6.6	6.8	7	48
52	3.9	4.2	4.4	4.7	4.9	5.1	5.3	5.5	5.7	5.9	6.1	6.3	52
56	3.4	3.6	3.9	4	4.3	4.5	4.7	5	5.1	5.3	5.5	5.7	56
60	2.9	3.2	3.4	3.6	3.8	4	4.2	4.4	4.6	4.8	5	5.2	60
64	2.6	2.8	3	3.2	3.4	3.6	3.8	4	4.2	4.4	4.5	4.7	64
68		2.5	2.6	2.8	3	3.2	3.4	3.6	3.7	3.9	4.1	4.3	68
72			2.3	2.5	2.7	2.9	3	3.2	3.4	3.6	3.7	3.9	72
76					2.4	2.6	2.7	2.9	3.1	3.2	3.4	3.3	76
80						2.3	2.5	2.6	2.8	2.9	3	2.5	80
84								2.4	2.5	2.4	2.2	1.7	84
88									1.9	1.6	1.4	1	88
92											0.6	0.3	92

Fixed jib load

Load chart-FJ(Boom to jib angle 30°, Boom 29~62m, Carbody counterweight 40t, Rear counterweight 100t)1/6

Jib 13m													
Boom length (m) Radius (m)	29	32	35	38	41	44	47	50	53	56	59	62	Boom length (m) Radius (m)
14	43.7	44.4	45.1	45.8									14
16	40.1	40.9	41.3	42.4	42.8	43.4	43.6	44	44	44.1	44.3	44.3	16
18	37.2	38	38.8	39.3	40.4	40.6	41	41.6	41.8	41.9	42.3	42.3	18
20	34.6	35.5	36.3	37.1	37.6	38.6	38.9	39.4	40	40.1	40.6	40.6	20
22	32.3	33.5	34	34.9	35.6	36.2	37.1	37.7	38.2	38.4	38.7	38.9	22
24	30.5	31.3	32.2	33	33.8	34.3	35.5	35.8	36.3	36.7	37.2	37.6	24
26	28.9	29.8	30.7	31.5	32.3	32.8	33.5	34.3	34.7	35.4	35.5	35.9	26
28	27.5	28.3	29.2	30	30.8	31.4	32.1	32.6	33.4	34	34.2	33.9	28
30	26.2	27	27.8	28.6	29.4	30.1	30.8	31.3	32.1	31.9	31.4	30.7	30
32	25	25.8	26.6	27.6	28.1	29.1	29.6	29.4	29.3	29	28.6	28	32
34	23.8	24.7	25.6	26.4	27.1	27	26.8	26.6	26.4	26.2	26	25.5	34
36	22.9	23.7	24.8	24.8	24.8	24.5	24.4	24.1	24	23.7	23.5	23.3	36
38	22.1	22.9	22.8	22.6	22.6	22.3	22.2	21.9	21.8	21.5	21.3	21.1	38
40	20.9	20.9	20.8	20.6	20.6	20.4	20.2	19.9	19.8	19.6	19.3	19.1	40
44			17.3	17.2	17.2	17	16.8	16.6	16.4	16.2	16	15.7	44
48				14.2	14.3	14.1	14	13.8	13.7	13.4	13.2	12.9	48
52						11.7	11.6	11.4	11.3	11	10.8	10.6	52
56							9.5	9.3	9.2	9	8.8	8.5	56
60									7.4	7.2	7	6.8	60
64											5.5	5.2	64
68												3.8	68

Load chart-FJ(Boom to jib angle 30°, Boom 29~62m, Carbody counterweight 40t, Rear counterweight 100t)2/6

Jib 19m													
Boom length (m) Radius (m)	29	32	35	38	41	44	47	50	53	56	59	62	Boom length (m) Radius (m)
18	23.8	24	24.5	24.6	24.8	24.9							18
20	22.2	22.5	22.9	23.2	23.4	23.5	23.7	24	24	24.1	24.2	24.3	20
22	20.8	21.1	21.6	21.8	22	22.5	22.6	22.8	22.9	23.1	23.2	23.4	22
24	19.5	19.9	20.3	20.6	21	21.3	21.7	21.9	22.1	22.2	22.4	22.5	24
26	18.4	18.9	19.2	19.7	19.9	20.4	20.6	20.8	21.2	21.3	21.5	21.7	26
28	17.3	17.8	18.3	18.6	19.1	19.3	19.7	20	20.3	20.5	20.7	20.9	28
30	16.6	16.9	17.4	17.9	18.2	18.6	18.8	19.3	19.5	19.7	20	20.1	30
32	15.7	16.2	16.7	17	17.5	17.9	18.1	18.5	18.7	19	19.3	19.5	32
34	15.1	15.6	15.9	16.4	16.8	17.1	17.5	17.9	18.1	18.3	18.7	18.8	34
36	14.4	14.8	15.3	15.8	16.2	16.4	16.9	17.1	17.5	17.8	18	18.3	36
38	13.9	14.3	14.8	15.2	15.6	15.9	16.3	16.7	16.9	17.2	17.5	17.8	38
40	13.4	13.8	14.3	14.7	14.9	15.4	15.8	16	16.4	16.8	16.9	17.3	40
44	12.6	13	13.4	13.8	14	14.4	14.8	15.2	15.4	15.8	15.9	16.3	44
48		12.4	12.6	13.1	13.3	13.6	14	14.3	14.6	14.4	14.2	13.9	48
52				12.4	12.7	12.8	12.6	12.4	12.2	12	11.8	11.5	52
56					10.8	10.6	10.5	10.3	10.2	9.9	9.7	9.4	56
60							8.6	8.4	8.3	8.1	7.9	7.6	60
64								6.8	6.7	6.5	6.3	6.1	64
68										5	4.9	4.6	68
72											3.6	3.3	72

Unit: t

Fixed jib load

Load chart-FJ(Boom to jib angle 30°, Boom 29~62m, Carbody counterweight 40t, Rear counterweight 100t)3/6													
Jib 24.5m													
Boom length (m) Radius (m)	29	32	35	38	41	44	47	50	53	56	59	62	Boom length (m) Radius (m)
22	15.4	15.7	15.8	16	16.1	16.3	16.5						22
24	14.5	14.7	15	15.1	15.3	15.5	15.6	15.8	15.7	15.9	15.9	16	24
26	13.6	14	14.1	14.3	14.5	14.7	14.9	15.1	15.2	15.2	15.3	15.4	26
28	12.8	13.2	13.3	13.6	13.8	14.1	14.2	14.3	14.6	14.7	14.7	14.7	28
30	12.1	12.4	12.8	12.9	13.2	13.4	13.6	13.8	14	14.1	14.2	14.3	30
32	11.6	11.8	12.1	12.4	12.6	12.8	13	13.3	13.4	13.6	13.8	13.8	32
34	11	11.3	11.6	11.8	12.1	12.4	12.5	12.8	12.9	13.1	13.2	13.5	34
36	10.5	10.8	11	11.3	11.6	11.8	12	12.2	12.5	12.6	12.9	13	36
38	10	10.3	10.6	10.9	11.1	11.3	11.6	11.8	12	12.2	12.4	12.5	38
40	9.6	9.9	10.2	10.5	10.7	11	11.2	11.4	11.6	11.8	11.9	12.2	40
44	8.9	9.1	9.4	9.7	10	10.2	10.4	10.6	10.9	11	11.2	11.4	44
48	8.4	8.6	8.8	9.1	9.4	9.6	9.9	10	10.3	10.4	10.6	10.8	48
52		8.2	8.4	8.6	8.8	9.1	9.3	9.5	9.7	9.9	10	10.2	52
56			8.1	8.2	8.4	8.6	8.8	9	9.3	9.4	9.6	9.8	56
60					8.1	8.2	8.4	8.6	8.8	9	8.8	8.5	60
64						7.9	7.9	7.7	7.6	7.4	7.2	6.9	64
68								6.2	6.1	5.9	5.7	5.5	68
72									4.7	4.5	4.4	4.2	72
76											3.2	3	76
80												1.8	80

Load chart-FJ(Boom to jib angle 30°, Boom 29~62m, Carbody counterweight 40t, Rear counterweight 100t)4/6													
Jib 30.5m													
Boom length (m) Radius (m)	29	32	35	38	41	44	47	50	53	56	59	62	Boom length (m) Radius (m)
24	11.4	11.5	11.6										24
26	10.7	10.8	11	11.1	11.1	11.2	11.2	11.3	11.5	11.5			26
28	10	10.2	10.3	10.5	10.6	10.6	10.7	10.9	10.9	11	11	11.1	28
30	9.4	9.6	9.7	9.9	10	10.1	10.3	10.3	10.4	10.6	10.6	10.6	30
32	8.9	9.1	9.3	9.4	9.6	9.8	9.8	10	10	10.1	10.2	10.2	32
34	8.4	8.7	8.9	9.1	9.3	9.3	9.4	9.6	9.6	9.7	9.8	9.9	34
36	8	8.2	8.4	8.6	8.8	8.9	9.1	9.3	9.4	9.4	9.5	9.5	36
38	7.6	7.9	8	8.2	8.4	8.6	8.8	8.9	8.9	9.1	9.2	9.2	38
40	7.2	7.5	7.7	7.9	8	8.2	8.4	8.5	8.6	8.8	8.9	9	40
44	6.6	6.8	7.1	7.2	7.4	7.6	7.8	7.9	8	8.2	8.4	8.4	44
48	6.1	6.3	6.5	6.7	6.8	7.1	7.2	7.4	7.5	7.6	7.8	7.9	48
52	5.7	5.9	6.1	6.3	6.4	6.6	6.8	6.9	7.1	7.2	7.3	7.5	52
56	5.4	5.6	5.7	5.9	6	6.2	6.4	6.5	6.6	6.8	6.9	7	56
60		5.3	5.4	5.6	5.7	5.8	6	6.1	6.3	6.4	6.5	6.7	60
64				5.3	5.5	5.6	5.7	5.9	6	6.1	6.2	6.3	64
68					5.3	5.4	5.5	5.6	5.7	5.9	5.9	6	68
72							5.3	5.4	5.5	5.2	5	4.8	72
76								4.2	4.2	4	3.8	3.6	76
80										2.8	2.7	2.5	80
84												1.5	84

Fixed jib load

Load chart-FJ(Boom to jib angle 30°, Boom 29~62m, Carbody counterweight 40t, Rear counterweight 100t)5/6

Jib 36m													
Boom length (m) Radius (m)	29	32	35	38	41	44	47	50	53	56	59	62	Boom length (m) Radius (m)
28	8.2	8.2	8.3	8.4									28
30	7.6	7.8	7.8	7.9	7.9	8.1	8.2	8.2	8.3	8.3	8.3	8.3	30
32	7.2	7.2	7.4	7.5	7.6	7.6	7.7	7.9	7.9	7.9	8	8	32
34	6.8	6.9	7	7.1	7.2	7.3	7.4	7.5	7.5	7.6	7.6	7.7	34
36	6.3	6.5	6.6	6.7	6.9	6.9	7	7.2	7.2	7.3	7.3	7.4	36
38	6	6.1	6.3	6.4	6.5	6.6	6.7	6.9	6.9	7	7	7.1	38
40	5.7	5.8	6	6	6.2	6.3	6.4	6.6	6.6	6.7	6.8	6.9	40
44	5.1	5.3	5.4	5.5	5.7	5.8	5.9	6	6.1	6.2	6.3	6.4	44
48	4.6	4.8	4.9	5	5.2	5.3	5.5	5.5	5.6	5.8	5.8	5.9	48
52	4.2	4.4	4.5	4.6	4.8	4.9	5	5.1	5.3	5.3	5.4	5.5	52
56	3.9	4	4.2	4.3	4.4	4.6	4.6	4.8	4.9	5	5.1	5.2	56
60	3.6	3.7	3.9	4	4.1	4.2	4.4	4.4	4.6	4.6	4.8	5	60
64		3.6	3.6	3.8	3.9	4	4.2	4.3	4.4	4.5	4.6	4.7	64
68			3.6	3.6	3.7	3.8	4	4	4.1	4.2	4.3	4.4	68
72					3.6	3.7	3.7	3.8	4	4	4.1	4.2	72
76						3.6	3.6	3.7	3.8	3.8	4	4	76
80								3.6	3.6	3.5	3.4	3.1	80
84									2.6	2.5	2.3	2.1	84
88											1.3	1.1	88

Load chart-FJ(Boom to jib angle 30°, Boom 29~62m, Carbody counterweight 40t, Rear counterweight 100t)6/6

Jib 42m													
Boom length (m) Radius (m)	29	32	35	38	41	44	47	50	53	56	59	62	Boom length (m) Radius (m)
32	5.7	5.7	5.9	5.9									32
34	5.3	5.3	5.5	5.5	5.6	5.7	5.7	5.8	5.8	5.8	5.8	5.9	34
36	4.9	5.1	5.1	5.2	5.3	5.3	5.4	5.4	5.5	5.6	5.6	5.6	36
38	4.6	4.7	4.8	4.9	5	5.1	5.1	5.2	5.2	5.3	5.4	5.4	38
40	4.4	4.4	4.5	4.6	4.7	4.8	4.8	4.9	5	5	5.1	5.2	40
44	3.8	3.9	4.1	4.1	4.2	4.3	4.4	4.4	4.5	4.6	4.6	4.7	44
48	3.4	3.5	3.6	3.7	3.8	3.9	4	4.1	4.1	4.2	4.3	4.3	48
52	3	3.1	3.2	3.3	3.4	3.5	3.6	3.7	3.8	3.8	3.9	4	52
56	2.7	2.8	2.9	3	3.1	3.2	3.3	3.4	3.4	3.5	3.6	3.7	56
60	2.4	2.5	2.6	2.7	2.8	2.9	3	3	3.1	3.3	3.3	3.4	60
64	2.1	2.2	2.4	2.5	2.6	2.7	2.7	2.8	2.9	3	3	3.1	64
68	2	2.1	2.1	2.2	2.3	2.4	2.5	2.6	2.7	2.8	2.8	2.9	68
72			2	2.1	2.1	2.2	2.3	2.4	2.5	2.6	2.6	2.7	72
76				2	2	2.1	2.1	2.2	2.3	2.4	2.5	2.5	76
80						2	2.1	2.1	2.2	2.2	2.3	2.4	80
84							2	2	2.1	2.1	2.2	2.2	84
88									2	2	1.9	1.7	88
92										1.1	1	0.8	92

LJ Configuration

LJ Configuration					
Jib length (m)	Insert			Boom Length(m)	Boom Angle
	3m	6m	12m		
21	1	1	-	26m~62m	65°~88°
24	-	2	-	26m~62m	65°~88°
27	1	2	-	26m~62m	65°~88°
30	-	1	1	26m~62m	65°~88°
33	1	1	1	26m~62m	65°~88°
36	-	2	1	26m~62m	65°~88°
39	1	2	1	26m~62m	65°~88°
42	-	1	2	26m~62m	65°~88°
45	1	1	2	26m~62m	65°~88°
48	-	2	2	26m~62m	65°~88°
51	1	2	2	26m~62m	65°~88°
54	-	1	3	26m~62m	65°~88°
57	1	1	3	26m~62m	65°~88°
60	-	2	3	26m~62m	65°~88°
63	1	2	3	26m~62m	65°~88°

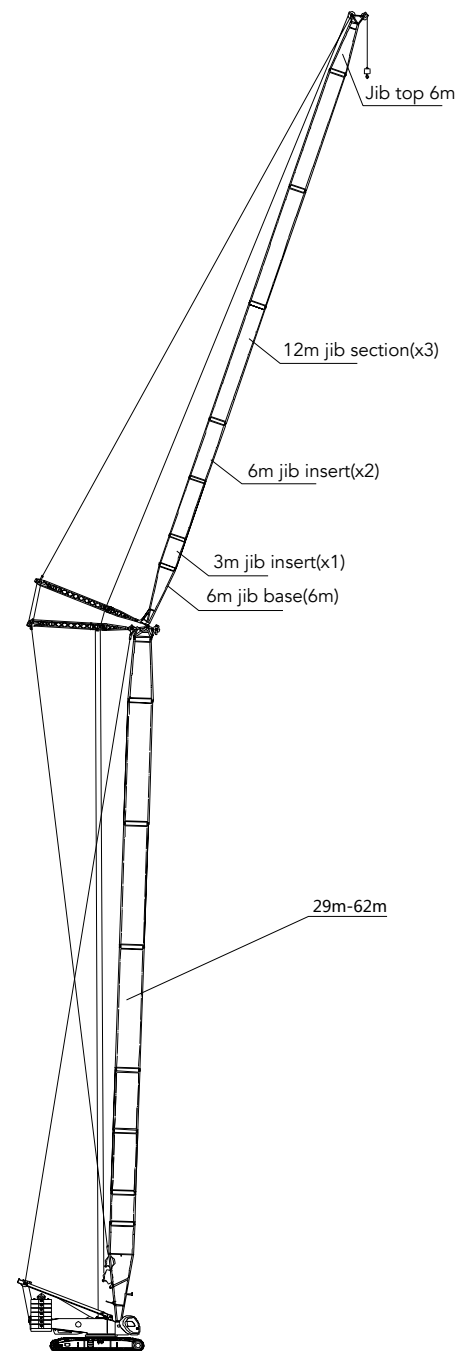

Luffing jib combination

Luffing Jib Working Radius

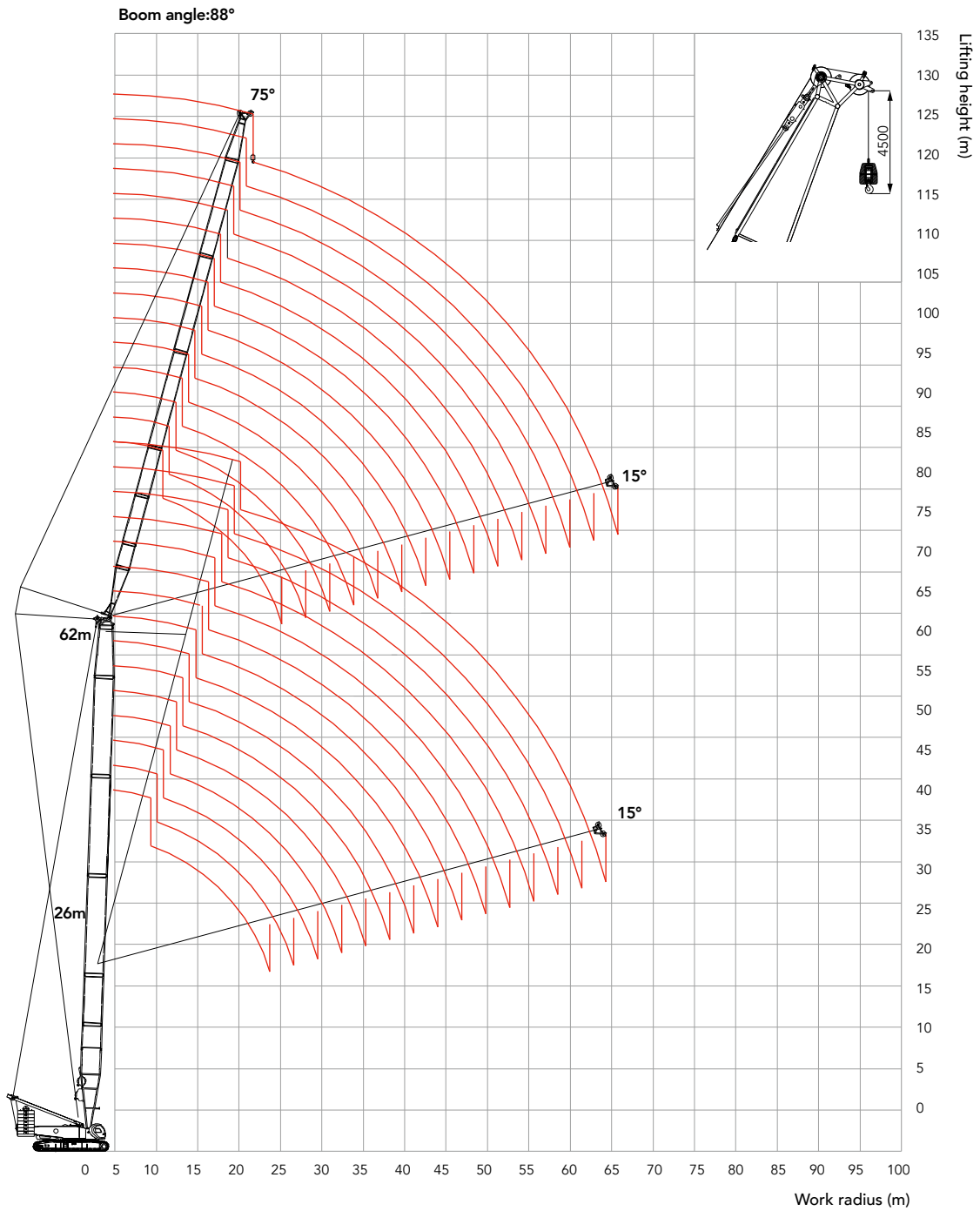

Unit: t

Load Chart for Luffing Jib

Load chart - LJ (Jib 21-63m,Rear counterweight 100t,Carbody counterweight 40t) 1/5																				
Boom 26m																				
Jib	21						24						27						Jib	
Angle	88	85	80	75	70	65	88	85	80	75	70	65	88	85	80	75	70	65	Angle	
10	107																			10
11	110						110													11
12	102						101						99.8							12
14	84.9	92.6					84.3	90.8					83.5							14
16	71.1	81					71.1	79.5					70.6	78						16
18	61.9	67.7	69.3				61.2	69.2	68.1				61.3	69.4						18
20	52.7	60	62.3				52.2	58.7	61.2				53.5	59.7	60.1					20
22	43.8	50.5	55.5	53.7			47.4	50.2	55.4	53.5			46.4	51.5	54.6					22
24		41.8	49.8	48.2	46.5		40.5	45.7	49.7	48			42.8	44.8	49.4	47.7				24
26			44.2	43.6	42.1		35.9	39.1	44.9	43.4	41.9		37.2	41.5	44.7	43.2				26
28				39.7	38.4	37.1			40.9	39.6	38.2		32	36.1	40.6	39.3	37.9			28
30					35.2	34			36.3	36.3	35	33.8		30.9	37.4	36.1	34.8			30
32						31.3				33.4	32.3	31.2			32.5	33.2	32	30.9		32
34											29.9	28.9				30.8	29.7	28.6		34
36												26.8					27.6	26.5		36
38																		24.7		38
40																				40
42																				42
44																				44
46																				46
48																				48
50																				50
52																				52
54																				54
56																				56
58																				58
60																				60
62																				62
64																				64
66																				66
68																				68
70																				70
72																				72
74																				74

Load Chart for Luffing Jib

Load chart - LJ (Jib 21-63m,Rear counterweight 100t,Carbody counterweight 40t) 2/5																				
Boom 26m																				
Jib	30						33						36						Jib	
Angle	88	85	80	75	70	65	88	85	80	75	70	65	88	85	80	75	70	65	Angle	
14	82.4						80.6													14
16	69.9	76.8					69.1						68.2							16
18	61.2	67					60.2	66.6					59.4	66.1						18
20	53.9	60.3					52.7	59.8					52.2	59.5						20
22	47.5	52.5	53.9				47.1	52.1	52.9				46.8	52.5						22
24	41.7	46	49.3				41.6	45.7	48.4				42	46.2	47.6					24
26	38.8	40.5	44.7	43.1			38.5	40.4	44.4				37.5	41	43.9					26
28	34.5	38	40.7	39.3			34.7	35.9	40.5	39			34.7	36.6	40.3	38.8				28
30	30.2	33.6	37.1	36	34.7		30.9	33.9	37.1	35.8			31.9	32.7	36.9	35.6				30
32	27.5	29.4	34.5	33.2	32		27.3	30.2	33.1	33	31.7		28.6	31.2	33.8	32.8				32
34			30.7	30.8	29.7	28.5	25.3	26.6	31.4	30.5	29.4		25.5	28	30.4	30.3	29.1			34
36				28.6	27.6	26.5		24.6	27.9	28.4	27.3	26.2	24.1	25	29.1	28.2	27.1			36
38				26.7	25.7	24.7			24.3	26.5	25.5	24.4	20.7	23.6	26.1	26.3	25.3	24.2		38
40					24	23.1				24.7	23.8	22.9			23.2	24.6	23.6	22.7		40
42						21.7					22.3	21.4				23.1	22.2	21.2		42
44												20.1					20.8	20		44
46																	19.6	18.8		46
48																		17.7		48
50																				50
52																				52
54																				54
56																				56
58																				58
60																				60
62																				62
64																				64
66																				66
68																				68
70																				70
72																				72
74																				74

Unit: t

Load Chart for Luffing Jib

Load chart - LJ (Jib 21-63m,Rear counterweight 100t,Carbody counterweight 40t) 3/5																				
Boom 26m																				
Jib	39						42						45						Jib	
Angle	88	85	80	75	70	65	88	85	80	75	70	65	88	85	80	75	70	65	Angle	
16	67.1																			16
18	58.8						57.8						57							18
20	51.6	57.3					51.3	57.5					50.5							20
22	46.3	52.3					45.8	50.1					45.2	50.1						22
24	41.7	46.4	46.8				41.3	46.4					40.7	44.2						24
26	37.9	41.3	43.1				37.6	41.6	42.6				37.1	41.5						26
28	34	36.9	39.9				34.3	37.3	39.4				33.8	37.4	38.7					28
30	30.6	33.2	36.7	35.3			31.1	33.6	36.6				31	33.7	36					30
32	29.1	29.9	33.8	32.5			28.2	30.4	33.7	32.4			28.4	30.6	33.5					32
34	26.5	28.7	30.8	30.1			26.7	27.6	31.2	30			25.9	27.8	31	29.7				34
36	23.8	26	27.9	27.9	26.8		24.7	26.7	28.4	27.8	26.7		24.6	25.4	28.6	27.6				36
38	21.3	23.4	26.9	26	25		22.4	24.3	25.9	26	24.9		22.8	24.7	26.1	25.7	24.6			38
40	20	20.9	24.3	24.4	23.3	22.3	20.2	22	25.1	24.3	23.3		20.9	22.6	23.9	24	23			40
42		19.5	21.8	22.8	21.9	20.9	19.3	19.8	22.8	22.8	21.8	20.9	18.9	20.6	21.8	22.5	21.5			42
44			19.3	21.5	20.6	19.7		18.9	20.7	21.4	20.5	19.6	17	18.7	21.3	21.1	20.2	19.3		44
46				20.2	19.3	18.5			18.5	20.2	19.3	18.4	16.2	16.8	19.4	19.9	19	18.1		46
48					18.2	17.4				19	18.2	17.4		15.8	17.5	18.8	17.9	17.1		48
50						16.5					17.2	16.4			15.6	17.7	16.9	16.1		50
52												15.5				16.3	16	15.2		52
54												14.7						15.1	14.4	54
56																			13.6	56
58																				58
60																				60
62																				62
64																				64
66																				66
68																				68
70																				70
72																				72
74																				74

Load Chart for Luffing Jib

Load chart - LJ (Jib 21-63m, Rear counterweight 100t, Carbody counterweight 40t) 4/5

Boom 26m																				
Jib	48						51						54						Jib	
Angle	88	85	80	75	70	65	88	85	80	75	70	65	88	85	80	75	70	65	Angle	
18	55.9																			18
20	50						49.1						46.1							20
22	44.6	50.1					43.9						43.2							22
24	40.2	44.3					39.6	44.2					39.1	44.2						24
26	36.6	39.4					36	39.4					35.5	39.4						26
28	33.3	37.4	38.1				32.8	37					32.6	35.4						28
30	30.8	33.9	35.5				30.2	33.8	34.8				30	33.6						30
32	28.3	30.7	33.1				27.9	30.8	32.5				27.5	30.8	32.1					32
34	26.1	28	30.8	29.5			25.8	28.1	30.4				25.5	28.2	29.7					34
36	23.9	25.6	28.6	27.3			23.9	25.7	28.3	27.1			23.8	25.8	28.2					36
38	22.7	23.4	26.3	25.5			22	23.6	26.3	25.2			22.1	23.7	26.2	25.1				38
40	21.1	21.5	24.1	23.8	22.7		20.9	21.6	24.2	23.5			20.4	21.8	24.3	23.4				40
42	19.5	21	22.1	22.3	21.3		19.5	19.9	22.2	22	21		19.4	20.1	22.4	21.9				42
44	17.8	19.2	20.3	20.9	20		18.2	19.6	20.5	20.7	19.7		18.1	18.6	20.7	20.6	19.6			44
46	16.1	17.6	19.9	19.7	18.8	17.9	16.6	18	18.8	19.4	18.5		17	18.3	19.1	19.3	18.4			46
48	15.6	15.9	18.2	18.6	17.7	16.9	15.2	16.4	18.6	18.3	17.4	16.6	15.7	16.9	17.6	18.2	17.3			48
50		15.3	16.6	17.5	16.7	15.9	13.7	15	17.1	17.3	16.4	15.6	14.4	15.5	16.3	17.2	16.3	15.5		50
52			14.9	16.6	15.8	15	13.1	13.5	15.6	16.3	15.5	14.7	13	14.2	16.1	16.2	15.4	14.6		52
54				15.6	15	14.2			14.2	15.5	14.7	13.9	12.7	12.9	14.8	15.4	14.6	13.8		54
56					14.2	13.5			12.6	14.6	13.9	13.2		12.5	13.5	14.6	13.8	13.1		56
58						12.8					13.2	13.2	12.5			12.2	13.8	13.1	12.4	58
60												12.5	11.8				12.7	12.4	11.7	60
62													11.2					11.8	11.1	62
64																			10.6	64
66																				66
68																				68
70																				70
72																				72
74																				74

Load Chart for Luffing Jib

Load chart - LJ (Jib 21-63m, Rear counterweight 100t, Carbody counterweight 40t) 5/5																			
Boom 26m																			
Jib	57						60						63						Jib
Angle	88	85	80	75	70	65	88	85	80	75	70	65	88	85	80	75	70	65	Angle
22	40.7						36.6												22
24	38.5						35.9						32.2						24
26	34.8	39.3					34.3	35.7					31.6						26
28	32.1	35.3					31.4	35.1					30.8	31.5					28
30	29.5	32					29	31.9					28.6	30.9					30
32	27.2	30.4	31.5				26.6	29					26.2	29					32
34	25.1	27.9	29.5				24.7	27.7	29				24.3	26.5					34
36	23.3	25.8	27.1				22.9	25.5	27				22.6	25.3	26.7				36
38	21.8	23.7	26				21.5	23.7	24.8				20.9	23.2	24.7				38
40	20.3	21.9	24.2	23.1			19.9	21.9	24	22.9			19.6	21.6	22.7				40
42	18.9	20.2	22.4	21.6			18.6	20.2	22.4	21.4			18.3	20.2	22.2	21.1			42
44	17.4	18.6	20.7	20.3			17.3	18.7	20.7	20.1			17.1	18.7	20.7	19.8			44
46	16.6	17.2	19.1	19	18.1		16.2	17.3	19.1	18.8			16	17.3	19.2	18.5			46
48	15.6	16.9	17.7	17.9	17		15.4	16	17.7	17.7	16.8		15	16.1	17.8	17.4	16.5		48
50	14.6	15.8	16.4	16.9	16		14.4	15.7	16.4	16.7	15.8		14.1	14.9	16.5	16.4	15.5		50
52	13.5	14.5	15.1	16	15.1	14.3	13.5	14.7	15.2	15.8	14.9		13.2	13.8	15.3	15.5	14.6		52
54	12.3	13.3	15	15.1	14.3	13.5	12.7	13.6	14.1	14.9	14.1	13.3	12.4	13.6	14.2	14.6	13.8		54
56	11.1	12.1	13.9	14.3	13.5	12.8	11.6	12.6	14.1	14.1	13.3	12.6	11.7	12.7	13.2	13.8	13	12.3	56
58		10.9	12.7	13.5	12.8	12.1	10.5	11.5	13	13.3	12.6	11.9	10.8	11.7	13.2	13.1	12.3	11.6	58
60			11.5	12.8	12.1	11.5	10.3	10.4	12	12.4	11.9	11.2	9.9	10.8	12.2	12.4	11.7	10.9	60
62			10.2	12	11.5	10.9		10.2	11	12	11.3	10.6	9.4	9.8	11.2	11.6	11	10.3	62
64				10.8	10.9	10.3			9.8	11.4	10.7	10.1	8.5	8.8	10.3	11.1	10.5	9.8	64
66					10.4	9.7				10.4	10.2	9.5			9.3	10.6	9.9	9.3	66
68						9.2					9.6	9				9.8	9.4	8.8	68
70												8.6				8.7	8.9	8.3	70
72																	8.4	7.9	72
74																		7.4	74

Load Chart for Luffing Jib

Load chart - LJ (Jib 21-63m, Rear counterweight 100t, Carbody counterweight 40t) 1/5																			
Boom 44m																			
Jib	21						24						27						Jib
Angle	88	85	80	75	70	65	88	85	80	75	70	65	88	85	80	75	70	65	Angle
11	93																		11
12	90.4						77.6												12
14	82.7	81.4					80.1						77.4						14
16	74.8	71.9					73.5	70.6					71.3	69.3					16
18	66.4	64.3					64.6	63.2					64.6	62					18
20	55.8	58.1	54.3				58.1	57.2					56.1	56.1					20
22	49.6	53	49.5				49.8	52.1	48.7				51.4	51.2	47.7				22
24	40.1	48.7	45.4				42.7	47.9	44.7				44.8	47	43.8				24
26		42.5	42	39.1			38.4	44.3	41.3				39	43.5	40.4				26
28			39	36.3				40.1	38.3	35.6			36	40.3	37.5	34.9			28
30			36	33.8	31.4				35.8	33.2			30	35	35	32.5			30
32				31.1	29.1				33.1	31	28.8			31.6	32.8	30.4			32
34				28.8	26.9					28.7	26.7				30.4	28.4	26.3		34
36					25	23.2				26.6	24.8				28.2	26.4	24.5		36
38						21.6					23.1	21.4				24.6	22.8		38
40						20.2					21.6	20					21.3	19.7	40
42												18.8					20	18.4	42
44												17.6						17.3	44
46																		16.2	46
48																			48
50																			50
52																			52
54																			54
56																			56
58																			58
60																			60
62																			62
64																			64
66																			66
68																			68
70																			70
72																			72
74																			74

Load Chart for Luffing Jib

Load chart - LJ (Jib 21-63m,Rear counterweight 100t,Carbody counterweight 40t) 2/5																			
Boom 44m																			
Jib	30						33						36						Jib
Angle	88	85	80	75	70	65	88	85	80	75	70	65	88	85	80	75	70	65	Angle
14	74.7																		14
16	69.3						66.8						62.3						16
18	63.7	61.2					62.6	60.1					60.3						18
20	57	55.4					56.6	54.4					55.8	53.5					20
22	49.6	50.5					49.3	49.6					49.7	48.9					22
24	46.1	46.5	43.3				45.9	45.6					43.9	44.9					24
26	40.7	43	40				40.7	42.2	39.2				41.3	41.5	38.5				26
28	36	39.9	37.1				36.1	39.2	36.4				36.9	38.5	35.8				28
30	31.6	37	34.6	32.1			32.1	36.6	33.9				33.1	36	33.3				30
32	29.2	32.7	32.4	30			30.4	33.1	31.7	29.4			29.7	33.7	31.2				32
34		30.4	30.4	28.2			26.7	29.4	29.8	27.5			26.6	30.5	29.3	27			34
36			28.3	26.4	24.4			27.7	28	25.9			25.2	27.4	27.6	25.4			36
38			26.4	24.6	22.8			23.7	26.2	24.3	22.4		22	26.1	26	24			38
40				23	21.3				24.5	22.7	21			22.9	24.3	22.5	20.7		40
42				21.5	20	18.4				21.3	19.6				22.8	21.1	19.4		42
44					18.8	17.3				20	18.4	16.9			21.4	19.8	18.2		44
46					17.6	16.2					17.4	15.9				18.7	17.1	15.7	46
48						15.3					16.3	15				17.6	16.2	14.7	48
50						14.4						14.1					15.2	13.9	50
52												13.3					14.4	13.1	52
54																		12.4	54
56																			56
58																			58
60																			60
62																			62
64																			64
66																			66
68																			68
70																			70
72																			72
74																			74

Load Chart for Luffing Jib

Load chart - LJ (Jib 21-63m, Rear counterweight 100t, Carbody counterweight 40t) 3/5

Boom 44m																				
Jib	39						42						45						Jib	
Angle	88	85	80	75	70	65	88	85	80	75	70	65	88	85	80	75	70	65	Angle	
16	58.1																		16	
18	56.8						52.3						47.7						18	
20	54.6						51.2						46.8						20	
22	50	48					49.5	47.4					45.9						22	
24	44.1	44.1					44.5	43.6					44.7	42.8					24	
26	39.3	40.8					39.7	40.3					39.9	39.6					26	
28	37.4	37.8	35.1				35.6	37.4					35.9	36.7					28	
30	33.6	35.3	32.7				34.1	34.9	32.3				32.4	34.2	31.6				30	
32	30.4	33	30.5				30.9	32.6	30.2				31.3	32	29.6				32	
34	27.4	31	28.6	26.4			28.1	30.6	28.3				28.5	30.1	27.7				34	
36	24.7	28.1	27	24.8			25.5	28.8	26.6	24.5			26	28.3	26				36	
38	23.7	25.4	25.4	23.4			23.1	26.2	25.1	23.1			23.7	26.6	24.6	22.5			38	
40	21	22.9	24	22.1			22.5	23.8	23.7	21.8			21.6	24.3	23.2	21.2			40	
42		21.8	22.5	20.8	19		20.2	21.6	22.5	20.6			19.7	22.2	22	20.1			42	
44			21.2	19.5	17.9		17.7	20.9	21.1	19.4	17.8		19.1	20.2	20.8	19	17.3		44	
46			19.9	18.4	16.8			18.5	19.9	18.3	16.7		17	18.3	19.6	18	16.4		46	
48				17.3	15.8	14.4			18.8	17.3	15.8			17.7	18.5	17	15.4		48	
50				16.3	14.9	13.6			17.7	16.3	14.9	13.5			17.5	16	14.5		50	
52					14.1	12.8				15.4	14	12.7			16.5	15.1	13.7	12.4	52	
54					13.3	12.1				14.6	13.3	12				14.3	13	11.7	54	
56						11.4					12.6	11.4				13.5	12.3	11	56	
58						10.8						11.9	10.7					11.6	10.4	58
60												10.2						11	9.9	60
62																			9.3	62
64																			8.8	64
66																				66
68																				68
70																				70
72																				72
74																				74

Load Chart for Luffing Jib

Load chart - LJ (Jib 21-63m,Rear counterweight 100t,Carbody counterweight 40t) 4/5																			
Boom 44m																			
Jib	48						51						54						Jib
Angle	88	85	80	75	70	65	88	85	80	75	70	65	88	85	80	75	70	65	Angle
20	42.8						39												20
22	42.1						38.4						35.1						22
24	41.3	42.1					37.7						34.5						24
26	40	38.9					37.1	38.2					34	35.2					26
28	36	36.1					36	35.5					33.4	34.8					28
30	32.6	33.7					32.6	33.1					32.7	32.7					30
32	29.6	31.5	29				29.7	30.9					29.8	30.5					32
34	28.7	29.6	27.2				27.1	29	26.6				27.2	28.6	26.3				34
36	26.3	27.6	25.6				26.4	27.3	25				25	26.9	24.7				36
38	24.1	25.2	24.1				24.2	25.3	23.5				22.9	25.4	23.2				38
40	22.1	24.6	22.8	20.8			22.3	23.2	22.2	20.2			22.5	23.4	21.9				40
42	20.2	22.6	21.5	19.6			20.5	22.8	21	19.1			20.8	21.5	20.7	18.8			42
44	18.4	20.7	20.4	18.6			18.8	20.9	19.9	18.1			19.2	21.2	19.6	17.8			44
46	18	19	19.4	17.6	16		17.2	19.3	18.9	17.1			17.7	19.6	18.6	16.9			46
48	16.3	17.3	18.3	16.7	15.1		15.7	17.7	18	16.3	14.6		16.2	18.1	17.7	16			48
50	14.3	16.8	17.3	15.8	14.3		15.4	16.2	17	15.4	13.9		14.9	16.7	16.8	15.2	13.6		50
52		15	16.3	14.9	13.5		13.8	15.9	16.1	14.6	13.2		14.7	15.3	16	14.5	12.9		52
54			15.5	14.1	12.7	11.4		14.3	15.2	13.8	12.4		13.3	14	15.1	13.7	12.3		54
56			14.6	13.3	12	10.8			14.4	13.1	11.7	10.4	11.7	13.7	14.3	13	11.6		56
58				12.6	11.4	10.2			13.6	12.4	11.1	9.8		12.2	13.6	12.3	11	9.7	58
60				12	10.8	9.6				11.7	10.5	9.3			12.9	11.6	10.4	9.2	60
62					10.2	9.1				11.1	9.9	8.8			12.2	11	9.8	8.7	62
64						8.6					9.4	8.3				10.5	9.3	8.2	64
66						8.1					8.9	7.8				9.9	8.8	7.7	66
68												7.4					8.3	7.3	68
70												7						6.9	70
72																		6.5	72
74																			74

Load Chart for Luffing Jib

Load chart - LJ (Jib 21-63m, Rear counterweight 100t, Carbody counterweight 40t) 5/5

Boom 44m																				
Jib	57						60						63						Jib	
Angle	88	85	80	75	70	65	88	85	80	75	70	65	88	85	80	75	70	65	Angle	
22	32						29.1												22	
24	31.4						28.6						26.1						24	
26	30.9						28.2						25.6						26	
28	30.4	31.5					27.7	28.6					25.2						28	
30	29.9	31.1					27.3	28.2					24.8	25.6					30	
32	29.4	30					26.8	27.9					24.4	25.3					32	
34	27.2	28.1					26.4	27.5					24	24.9					34	
36	25	26.4	24.1				25	25.9	23.7				23.6	24.6					36	
38	22.9	24.9	22.7				23	24.4	22.3				22.9	23.9	21.7				38	
40	21.1	23.4	21.4				21.2	23	21				21.1	22.5	20.5				40	
42	20.9	21.5	20.2				19.5	21.6	19.8				19.5	21.3	19.3				42	
44	19.3	19.9	19.1	17.3			19.4	19.9	18.7				18	19.9	18.2				44	
46	17.8	19.7	18.1	16.4			17.9	18.4	17.7	16			17.9	18.4	17.3	15.5			46	
48	16.4	18.2	17.2	15.5			16.6	18.3	16.8	15.1			16.6	17	16.4	14.6			48	
50	15.2	16.8	16.4	14.7			15.4	17	16	14.3			15.4	17	15.5	13.9			50	
52	13.9	15.5	15.6	14	12.5		14.2	15.7	15.2	13.6			14.3	15.7	14.7	13.1			52	
54	13.8	14.3	14.8	13.3	11.8		13.1	14.5	14.5	12.9	11.4		13.2	14.6	14	12.5			54	
56	12.6	13.1	14.1	12.7	11.2		12	13.4	13.8	12.3	10.9		12.2	13.5	13.3	11.8	10.4		56	
58	11.2	13	13.3	12	10.7		11.9	12.3	13.1	11.7	10.3		11.2	12.5	12.7	11.2	9.8		58	
60		11.7	12.6	11.3	10.1	8.8	10.7	11.3	12.4	11.1	9.8		11.2	11.5	12.1	10.7	9.3		60	
62			12	10.7	9.5	8.3		11.1	11.8	10.5	9.3	8	10.1	10.6	11.5	10.2	8.8	7.6	62	
64			11.4	10.2	9	7.9		9.9	11.2	10	8.8	7.6	9	10.5	10.9	9.7	8.4	7.2	64	
66				9.6	8.5	7.4			10.6	9.4	8.3	7.2		9.4	10.3	9.2	8	6.8	66	
68				9.1	8.1	7			10.1	8.9	7.8	6.7			9.8	8.7	7.5	6.4	68	
70					7.6	6.6				8.5	7.4	6.3			9.3	8.2	7.1	6	70	
72					7.2	6.2					7	6				7.8	6.7	5.7	72	
74						5.8					6.6	5.6				7.3	6.3	5.3	74	
76						5.5							5.3					5.9	5	76
78													5					5.6	4.7	78
80																			4.3	80

Load Chart for Luffing Jib

Load chart - LJ (Jib 21-63m,Rear counterweight 100t,Carbody counterweight 40t) 1/5																				
Boom 62m																				
Jib	21						24						27						Jib	
Angle	88	85	80	75	70	65	88	85	80	75	70	65	88	85	80	75	70	65	Angle	
12	60.9																			12
14	57.8						54.3						50.7							14
16	54.8	59.1					51.7						48.5							16
18	52.1	56.5					49.2	53.2					46.3	49.8						18
20	49.6	51.7					46.9	50.9					44.2	47.8						20
22	47.5	47.4					44.8	46.6					42.3	45.7						22
24	43.9	43.7	39				43	42.9	38.3				40.6	42.1						24
26		40.6	36				41.2	39.8	35.4				39	39	34.7					26
28		37.9	33.5					37.1	32.9				37.6	36.4	32.2					28
30			31.3	27.7				34.8	30.8				32.6	34	30.1					30
32			29.4	25.9					28.8	25.4				32	28.2					32
34				24.3					27.1	23.8					26.5	23.2				34
36				22.9					25.7	22.4					25	21.8				36
38				21.6	18.8					21.2	18.3				23.6	20.6				38
40					17.8					20	17.3					19.4	16.7			40
42					16.8						16.4					18.4	15.8			42
44						13.6					15.5					17.5	15			44
46						12.9					14.7	12.5					14.2			46
48						12.2						11.8					13.5	11.3		48
50												11.2						10.7		50
52																		10.1		52
54																		9.6		54
56																				56
58																				58
60																				60
62																				62
64																				64
66																				66
68																				68
70																				70
72																				72
74																				74

Load Chart for Luffing Jib

Load chart - LJ (Jib 21-63m, Rear counterweight 100t, Carbody counterweight 40t) 2/5

Boom 62m																			
Jib	30						33						36						Jib
Angle	88	85	80	75	70	65	88	85	80	75	70	65	88	85	80	75	70	65	Angle
14	47.7																		14
16	45.7						42.8						40.1						16
18	43.8						41.1						38.7						18
20	42	45.3					39.5	42.4					37.3						20
22	40.3	43.7					38	41					35.9	38.5					22
24	38.6	41.6					36.5	39.6					34.6	37.3					24
26	37.1	38.6					35.1	37.8					33.4	36.1					26
28	35.8	35.9	31.8				33.9	35.2	31.1				32.2	34.6					28
30	34.6	33.6	29.7				32.7	32.9	29				31.1	32.4	28.5				30
32	31.1	31.6	27.8				31.7	30.9	27.2				30	30.3	26.7				32
34		29.7	26.2	22.9			28.3	29.1	25.6				29.1	28.5	25.1				34
36		28.1	24.7	21.5			24.4	27.5	24.1	20.9			26.6	26.9	23.6				36
38			23.3	20.3				26	22.7	19.7			23.4	25.5	22.3	19.3			38
40			22.1	19.2					21.5	18.6				24.2	21.1	18.2			40
42			21	18.2	15.6				20.4	17.6				22.5	20	17.2			42
44				17.3	14.8				19.4	16.7	14.2				19	16.3			44
46				16.4	14					15.9	13.5				18.1	15.5	13		46
48					13.3					15.1	12.8					14.7	12.4		48
50					12.6	10.5				14.4	12.1					14	11.7		50
52					12	10					11.5	9.5				13.4	11.1		52
54						9.5					11	9					10.6	8.6	54
56						9						8.5					10.1	8.1	56
58												8.1					9.6	7.7	58
60												7.7						7.3	60
62																		6.9	62
64																			64
66																			66
68																			68
70																			70
72																			72
74																			74

Load Chart for Luffing Jib

Load chart - LJ (Jib 21-63m,Rear counterweight 100t,Carbody counterweight 40t) 3/5																			
Boom 62m																			
Jib	39						42						45						Jib
Angle	88	85	80	75	70	65	88	85	80	75	70	65	88	85	80	75	70	65	Angle
18	36.2						33.9												18
20	34.9						32.9						30.7						20
22	33.8	36					31.8						29.8						22
24	32.6	35					30.8	32.9					28.9	30.6					24
26	31.5	33.9					29.8	32					28	29.9					26
28	30.4	32.9					28.9	31.1					27.1	29.1					28
30	29.4	31.7					27.9	30.2					26.3	28.3					30
32	28.4	29.7	26.1				27.1	29.3	25.7				25.5	27.6					32
34	27.5	27.9	24.4				26.2	27.6	24.1				24.8	26.8	23.5				34
36	26.7	26.3	23				25.4	26	22.7				24	25.5	22.1				36
38	24.9	24.9	21.7				24.2	24.6	21.4				23.3	24	20.9				38
40	22.2	23.6	20.5	17.6			23.5	23.3	20.2	17.4			22.5	22.8	19.7				40
42	19.4	22.4	19.4	16.6			21.2	22.1	19.2	16.4			21.7	21.6	18.6	15.9			42
44		21.4	18.4	15.8			18.8	21	18.2	15.5			19.9	20.5	17.7	15			44
46			17.5	14.9				20.1	17.3	14.7			17.9	19.5	16.8	14.2			46
48			16.7	14.2	11.8			18.2	16.5	14			15.7	18.6	16	13.5			48
50			16	13.5	11.2				15.7	13.3	11			17.4	15.2	12.8	10.5		50
52				12.8	10.6				15	12.6	10.4				14.5	12.1	9.9		52
54				12.2	10.1					12	9.9				13.8	11.5	9.4		54
56				11.7	9.6	7.6				11.5	9.4				13.2	11	8.9		56
58					9.1	7.2				11	8.9	7				10.5	8.4	6.5	58
60					8.7	6.8					8.5	6.7				10	8	6.2	60
62						6.5					8.1	6.3					7.6	5.8	62
64						6.1					7.7	6					7.2	5.5	64
66						5.8						5.6					6.9	5.2	66
68												5.3						4.9	68
70																		4.6	70
72																		4.3	72
74																			74

Load Chart for Luffing Jib

Load chart - LJ (Jib 21-63m, Rear counterweight 100t, Carbody counterweight 40t) 4/5

Boom 62m																			
Jib	48						51						54						Jib
Angle	88	85	80	75	70	65	88	85	80	75	70	65	88	85	80	75	70	65	Angle
20	28.6						26.5												20
22	27.8						25.8						24.1						22
24	27						25.2						23.5						24
26	26.3	27.9					24.5	25.8					22.9						26
28	25.5	27.2					23.8	25.3					22.3	23.6					28
30	24.8	26.5					23.2	24.7					21.8	23.2					30
32	24	25.9					22.5	24.2					21.3	22.7					32
34	23.4	25.2	23.1				22	23.6					20.7	22.2					34
36	22.7	24.6	21.7				21.4	23.1	21.1				20.2	21.7					36
38	22	23.6	20.4				20.8	22.5	19.9				19.6	21.2	19.6				38
40	21.4	22.3	19.3				20.2	21.8	18.7				19.1	20.7	18.5				40
42	20.9	21.2	18.2				19.7	20.6	17.7				18.6	20.2	17.4				42
44	20	20.1	17.3	14.6			19.2	19.6	16.7				18.2	19.3	16.5				44
46	18.8	19.1	16.4	13.8			17.9	18.6	15.9	13.3			17.7	18.3	15.6	13			46
48	17	18.2	15.6	13.1			17.6	17.7	15.1	12.5			16.8	17.4	14.8	12.3			48
50	15.2	17.4	14.8	12.4			16.1	16.9	14.3	11.9			16.3	16.6	14.1	11.7			50
52		16.6	14.1	11.8	9.5		14.5	16.1	13.6	11.3			15.3	15.9	13.4	11			52
54		14.7	13.5	11.2	9			15.4	13	10.7	8.5		13.9	15.1	12.7	10.5			54
56			12.8	10.6	8.5			14.1	12.4	10.1	8		12.4	14.5	12.1	9.9	7.8		56
58			12.3	10.1	8.1				11.8	9.6	7.6			13.6	11.6	9.4	7.4		58
60				9.6	7.7	5.8			11.3	9.2	7.2				11.1	9	7		60
62				9.2	7.3	5.4			10.8	8.7	6.8	4.9			10.6	8.5	6.6		62
64				8.8	6.9	5.1				8.3	6.4	4.6			10.1	8.1	6.2	4.4	64
66					6.5	4.8				7.9	6.1	4.3				7.7	5.9	4.1	66
68					6.2	4.5					5.7	4				7.4	5.6	3.9	68
70					5.9	4.2					5.4	3.8				7	5.2	3.6	70
72						4					5.1	3.5					5	3.3	72
74						3.7						3.3					4.7	3.1	74
76												3						2.9	76
78																		2.6	78
80																		2.4	80

Load Chart for Luffing Jib

Load chart - LJ (Jib 21-63m,Rear counterweight 100t,Carbody counterweight 40t) 5/5																					
Boom 62m																					
Jib	57						60						63						Jib		
Angle	88	85	80	75	70	65	88	85	80	75	70	65	88	85	80	75	70	65	Angle		
22	22.3																		22		
24	21.8						20.2						18.5						24		
26	21.3						19.7						18.1						26		
28	20.8	21.9					19.3						17.8						28		
30	20.3	21.4					18.8	19.8					17.4	18.2					30		
32	19.8	21					18.4	19.4					17	17.9					32		
34	19.3	20.6					17.9	19.1					16.6	17.5					34		
36	18.8	20.2					17.5	18.7					16.2	17.2					36		
38	18.3	19.7	19				17.1	18.3					15.8	16.9					38		
40	17.9	19.3	17.9				16.7	17.9	17.5				15.5	16.5					40		
42	17.4	18.8	16.9				16.3	17.5	16.5				15.1	16.2	16				42		
44	17	18.4	16				15.9	17.2	15.6				14.8	15.9	15.1				44		
46	16.6	17.9	15.1				15.5	16.7	14.7				14.4	15.6	14.3				46		
48	16.2	17	14.3	11.8			15.2	16.4	14				14.1	15.3	13.5				48		
50	15.7	16.2	13.6	11.2			14.8	15.8	13.2	10.8			13.7	14.9	12.8				50		
52	15	15.4	12.9	10.6			14.5	15	12.5	10.2			13.4	14.6	12.1	9.7			52		
54	14.4	14.7	12.3	10			13.6	14.3	11.9	9.6			13.1	13.9	11.5	9.1			54		
56	13.1	14	11.7	9.5			13.4	13.7	11.3	9.1			12.6	13.2	10.9	8.6			56		
58	11.9	13.4	11.1	9	6.9		12.4	13	10.8	8.6			12.4	12.6	10.3	8.1			58		
60		12.8	10.6	8.5	6.5		11.3	12.5	10.3	8.2	6.1		11.7	12	9.8	7.7			60		
62		11.5	10.1	8.1	6.1		10.1	11.9	9.8	7.7	5.8		10.6	11.5	9.3	7.3	5.3		62		
64			9.7	7.7	5.8			11	9.3	7.3	5.4		9.6	11	8.9	6.9	4.9		64		
66			9.2	7.3	5.4	3.7			8.9	6.9	5.1			10.4	8.4	6.5	4.6		66		
68			8.8	6.9	5.1	3.4			8.5	6.6	4.8	3		9.3	8	6.1	4.3		68		
70				6.6	4.8	3.1			8.1	6.2	4.5	2.8			7.7	5.8	4	2.3	70		
72				6.2	4.5	2.9				5.9	4.2	2.5			7.3	5.5	3.7	2.1	72		
74					4.2	2.6				5.6	3.9	2.3			7	5.2	3.5	1.8	74		
76					4	2.4				5.3	3.6	2.1				4.9	3.2	1.6	76		
78					3.7	2.2					3.4	1.9				4.6	3	1.4	78		
80						2						3.2	1.7					2.7	1.2	80	
84													1.3						2.3	0.8	84
88																				0.5	88



Zhejiang Sany Equipment Co.,LTD

SANY Crawler Crane Industrial Park, No. 2188 Daishan Road, Wuxing District, Huzhou City, Zhejiang Province, P. R. China Zip 313028

Consulting sanycrane@sanygroup.com (Crane BU) / crd@sany.com.cn (IHQ)

After-sales Service 0086-400 6098 318

Reminder:

Any change in the technical parameters and configuration due to product modification or upgrade may occur without prior notice. The machine in the picture may include additional equipment. This brochure is for reference only, and goods in kind shall prevail.

Copyright at SANY. No part of this brochure may be copied or used for any purpose without written approval from SANY.

© Edited in June 2023

