

TKI-LL620K / TKI-LL620U / TKI-LL620X

6,200 ANSI lm 4K@60Hz 5,000,000:1

6,200 ANSI lm WUXGA 5,000,000:1

6,200 ANSI lm XGA 5,000,000:1



Multi-purpose Installation type LCD Laser Projector with Powerful Performance

Excellent Performance and Versatile Functions

□ Long-life Eco-friendly Laser Source

- Long Lifetime : 30,000 hours (ECO)
- Clear Image by High Brightness Source
- Mercury-free and Eco-friendly

□ 4K Ultra High Resolution Image

- TKI-LL620K : 4K@60Hz INPUT/OUT
- TKI-LL620U/X : 4K INPUT support
- Pixel Sharpness and Color Enhanced

□ The Best Brightness and Contrast Ratio

- Brightness : 6,200 ANSI lms
- Contrast Ratio : 5,000,000:1

□ Optical Zoom / Digital Zoom

- Manual Optical Zoom : 1.6x
- Digital Zoom : 33x

□ Various Input/Output Support

- HDMI x2 / RGB x1
- Audio / USB
- RJ45 / RS232

□ Versatile Convenience Features

- USB memory viewer / display function
- Network control / display function
- Security, Automatic setting function, etc.

Easy Installation and Maintenance

□ Powerful Keystone Function

- Support various surface with 6 Corners, Curved Correction, Grid Correction, etc

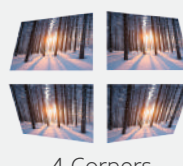
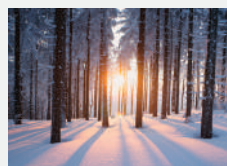

4 Corners



Horizontal/Vertical



Pincushion/Barrel

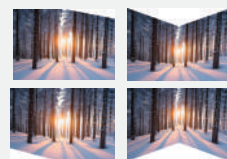

6 Corners



Grid Correction (187 points)

□ Tilt Free

- 360° Free Installation

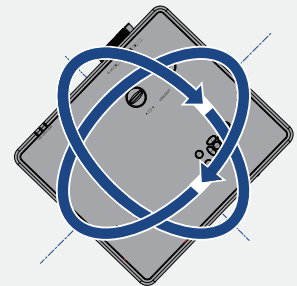

□ Lens Shift

- Vertical 0~+50%/0~+60%
- Horizontal ±22%/±30%

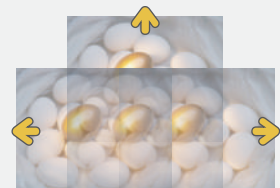

□ 16W Built-in Speaker

□ Excellent Anti-dust System

- Longer Device and Light Source Life Time

□ Edge Blending

- Panoramic Image Support

Multi-purpose LCD Laser Projector with Powerful Performance

TKI-LL620K 6,200 ANSI lms 4K@60Hz 5,000,000:1

TKI-LL620U 6,200 ANSI lms WUXGA 5,000,000:1

TKI-LL620X 6,200 ANSI lms XGA 5,000,000:1

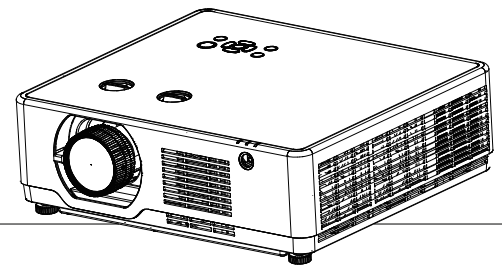

Terminals

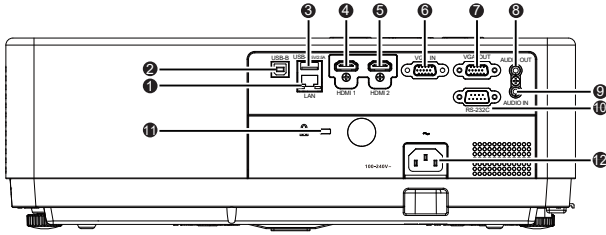

① LAN ② USB-B IN ③ USB-A IN ④ HDMI 1 IN ⑤ HDMI 2 IN ⑥ VGA IN ⑦ VGA OUT
⑧ Audio OUT ⑨ Audio IN ⑩ RS232C ⑪ Kensington Lock ⑫ Power IN

Dimensions

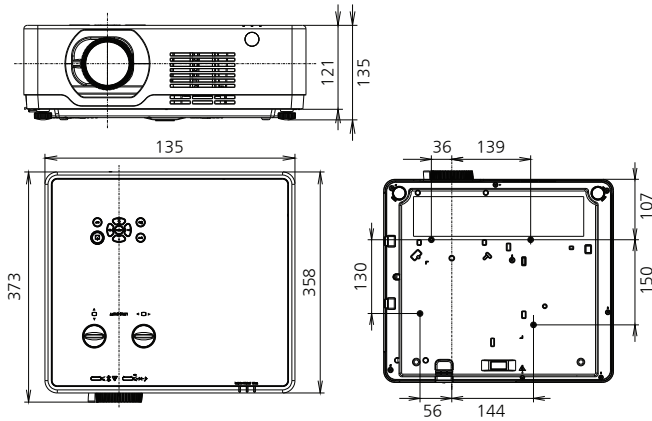

Projection Distance

Model	TKI-LL620K / TKI-LL620U					
Resolution	WUXGA					
Ratio	16:10			16:9		
Screen	Size	Min	Max	Size	Min	Max
30 inch	0.6 x 0.4	0.8	1.2	0.7 x 0.4	0.8	1.2
100 inch	2.2 x 1.3	2.7	4.2	2.2 x 1.2	2.8	4.3
150 inch	3.2 x 2.0	4.0	6.4	3.3 x 1.9	4.1	6.6
200 inch	4.3 x 2.7	5.3	8.5	4.4 x 2.5	5.5	8.8
300 inch	6.5 x 4.0	8.0	12.2	6.6 x 3.7	8.2	13.2

Model	TKI-LL620X					
Resolution	XGA					
Ratio	4:3			16:9		
Screen	Size	Min	Max	Size	Min	Max
30 inch	0.6 x 0.5	0.8	1.3	0.7 x 0.4	0.8	1.4
100 inch	2.0 x 1.5	2.8	4.5	2.2 x 1.2	3.0	4.8
150 inch	3.0 x 2.3	4.2	6.8	3.3 x 1.9	4.4	7.3
200 inch	4.1 x 3.0	5.6	9.1	4.4 x 2.5	5.9	9.7
300 inch	6.1 x 4.6	8.4	13.8	6.6 x 3.7	8.9	14.6

* Unit: m / All measurements are approximate and may vary from the actual size(±7%)

Specification

Model	TKI-LL620K	TKI-LL620U	TKI-LL620X	
Brightness	6,200 ANSI lumens			
Panel	Projection	LCD		
	Type	3x 0.64"		
	Resolution	4K Enhanced	WUXGA	XGA
	Support	4K@60hz	4K	4K
Contrast Ratio	5,000,000:1			
Aspect Ratio(Compatible)	16:9(4:3)	16:10 (4:3/16:9)	4:3 (16:9)	
	Type	Laser		
	Mode	Normal / ECO		
Light Source	Lifetime	Normal 20,000 Hrs / ECO 30,000 Hrs		
	Screen Size	30"~300"		
	Throw Ratio	1.08~1.76:1	1.22~1.98:1	1.34~2.24:1
Lens	Zoom/Focus	Manual(Optical 1.6x / Digital 33x)		
	F	1.58~2.02	1.70~2.21	1.50~2.08
	f	15.3~24.6 mm	17.4~29.0 mm	17.2~27.7mm
	Lens Shift	V +55% H ±22%	V +60% H ±30%	V +60% H ±30%
	Keystone	Vertical	±30° (Manual)	
Horizontal		±30° (Manual)		
Support		Pincushion/Barrel, 4 Corners, 6 Corners, Grid		
I/O	IN	2x HDMI		
		1x VGA (15 pin Mini D-sub RGB)		
		1x Audio (L/R RCA)		
		1x RJ45 (Display)		
		1x USB A (Display)		
	1x USB B			
OUT	1x VGA (15 pin Mini D-sub RGB)			
		1x Audio (3.5mm Stereo Mini Jack)		
Control	1x RS232C (D-sub 9 pin)			
		1x RJ45 (Control)		
		1x USB B (Upgrade)		
Functions	Auto Ceiling, Auto Keystone, Freeze, Blank, Tilt Free, Auto Search, Auto Suspend, Auto PC Setup, etc.			
Speaker	1x 16W			
Noise	38 dB (28 dB)	37 dB (27 dB)		
Temperature	5~40°C (Normal)			
Rated Voltage	100~240V@50/60Hz			
Power Consumption	390W (170W)	350W (230W)		
Standby Power	<0.5W			
Dimension	405 x 358 x 136 mm			
Weight	7.9 Kg			

Best in Class + Cost Effective
Cost Effective e-Whiteboard
Future Education Environment
Durable Charging Cabinet

Twokey® Projector
Twokey® Canvas
Twokey® System
Twokey® Cabinet

Twokey® Projector
THAILAND

มาตรฐานผลิตภัณฑ์
ประเทศไทย
STANDARD OF SOUTH KOREA

โปรดเกล้าฯ
อย่างเป็นทางการในประเทศไทย

บริษัท เทคโนโลยี อิมมูตี จำกัด | TECH INFINITY EDUCATION CO., LTD.
เลขทะเบียนผู้เสียภาษี (TAX ID) : 0105564121880
สำนักงานใหญ่ (HQ) : เลขที่ 1 อาคารเอ็มโพร์ ชั้น 47 ถนนสุขุมวิท
แขวงวัฒนา แขวง เขตสาทร กรุงเทพมหานคร 10120 ประเทศไทย