



METALL-CODE

Quality is the best policy



Company Profile

VISION

- *Driven by our belief that **Quality is the Best Policy**,*

we aim to be an impacting image in surgical instrument

manufacturing. Our vision is to deliver innovative,

reliable, and safe medical tools that empower healthcare

professionals to provide exceptional patient care. We

are dedicated to setting new standards of excellence and

trust in the medical field, ensuring that every product

reflects our unwavering commitment to quality.



Dr. Shahid Siddique

CEO: SNA Exports & Manufacturing Co.

Manufacturing Cycle

Our surgical instruments manufacturing process focuses on precision, quality, and compliance with SFDA and GSO guidelines. By following key standards like ISO 10993, ISO 13485, ISO 14971, and ISO 11607, we ensure our instruments meet high safety and performance requirements for healthcare professionals in Saudi Arabia.



• Table of Content

Page

1.	Dental Items	5
2.	Needle Holders	16
3.	Scissors	24
4.	Forceps	37
5.	Artery Forceps	59
6.	Ligators	65
7.	Eye & Nasal Specula	67
8.	Vaginal Specula	73
9.	Scalpels & Blades	76
10.	Plaster Instruments	81
11.	Hooks Retractors & Elevators	84
12.	Podiatry Clippers	90
13.	Suction & irrigation	94
14.	Biopsy Instruments	98
15.	Ring Cutters	101
16.	Dilators	103
17.	Towel Clips	106
18.	Probes	108
19.	Ronguers & Rasps	113
20.	Hollowware stainless steel	115
21.	Hollowware polypropylene Tuning forks, reflex hammers, • penlights, tapes, and miscellaneous	121
22.	Personal care instruments	126
23.	Vet surgical kits	130



Dental

Elevators

Extracting Forceps

Tooth Forceps

Wire Cutting Forceps

Extracting Forceps

For lower molars with decayed or broken crowns either side molars
180mm long

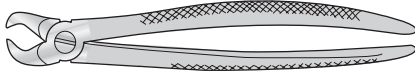

Code	Description
SC-DEN/8578	No 87



Extracting Forceps

For lower molars either side
165mm long

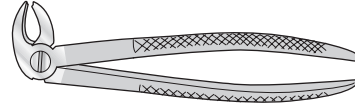

Code	Description
SC-DEN/8522	No 22

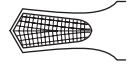

Extracting Forceps

For upper roots
180mm long

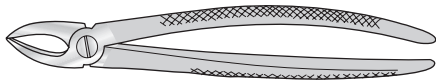

Code	Description
SC-DEN/8530	No 30

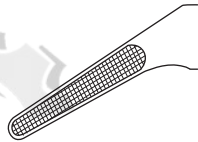

Extracting Forceps

For upper roots and incisors
165mm long

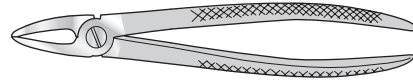

Code	Description
SC-DEN/8522a	No 29

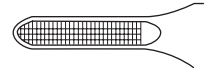

Extracting Forceps

For upper molars
180mm long



Code	Description
SC-DEN/8588	No 89
SC-DEN/8590	No 90

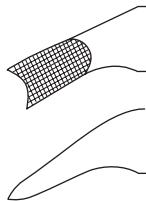

Extracting Forceps

For upper laterals and canines
170mm long

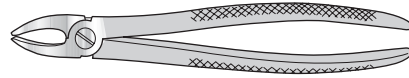

Code	Description
SC-DEN/8500	No 1, 6mm wide
SC-DEN/8502	No 1, 5mm wide

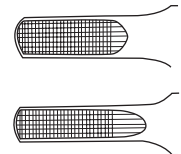

Extracting Forceps

For lower molars
165mm long

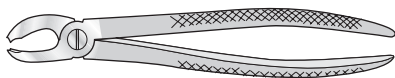

Code	Description
SC-DEN/8520	No 21

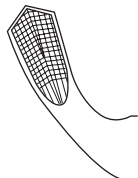

Extracting Forceps

For lower incisors and canines
170mm long

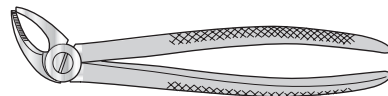

Code	Description
SC-DEN/8504	No 4, 4mm wide

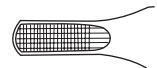

Extracting Forceps

For lower premolars
170mm long

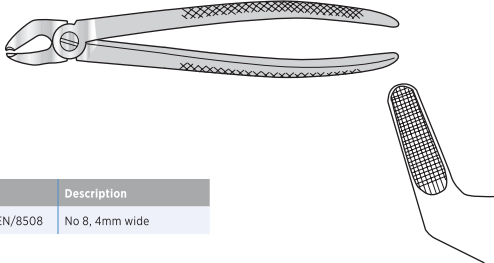

Code	Description
SC-DEN/8508	No 8, 4mm wide

Extracting Forceps

For lower molars
150mm long

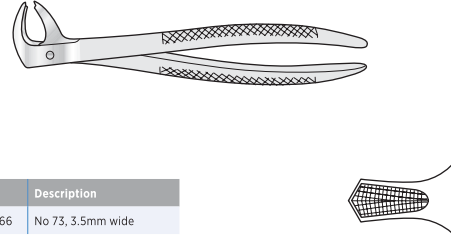

Code	Description
SC-DEN/8566	No 73, 3.5mm wide

Extracting Forceps

For lower bicuspid and canines
170mm long

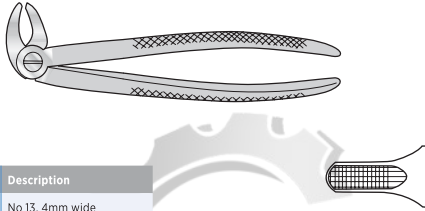

Code	Description
SC-DEN/8512	No 13, 4mm wide

Extracting Forceps

For lower roots
150mm long

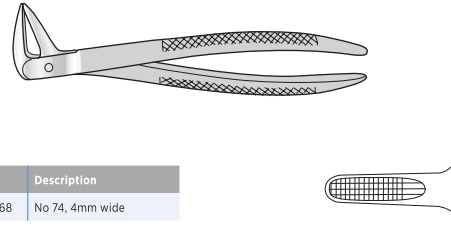

Code	Description
SC-DEN/8568	No 74, 4mm wide

Extracting Forceps

For upper premolar
180mm long

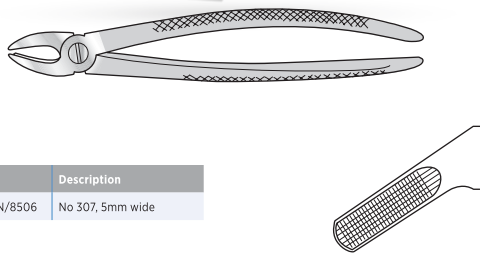

Code	Description
SC-DEN/8506	No 307, 5mm wide

Extracting Forceps

For lower roots and premolars
150mm long

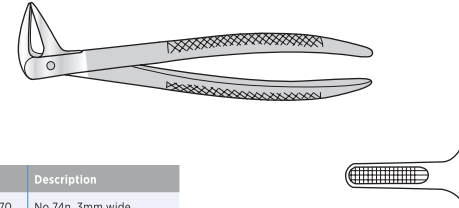

Code	Description
SC-DEN/8570	No 74n, 3mm wide

Extracting Forceps

For upper molars
180mm long

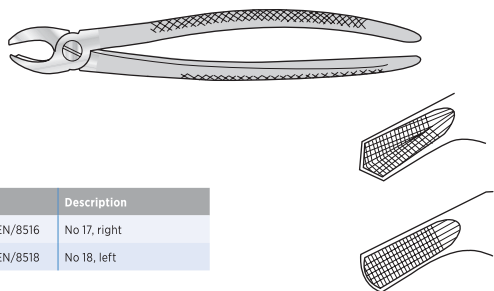

Code	Description
SC-DEN/8516	No 17, right
SC-DEN/8518	No 18, left

Extracting Forceps

For lower bicuspid and canines
150mm long

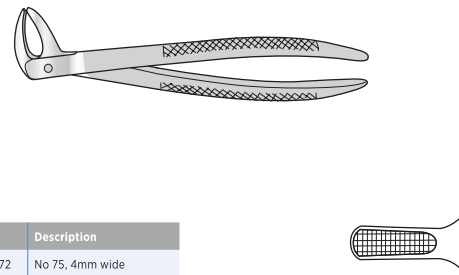

Code	Description
SC-DEN/8572	No 75, 4mm wide



Woakes Eustachian Catheters

Silver, Luer, 140mm



Code	Description	Code	Description
SC-ENT/015	7 F.G.	SC-ENT/015c	10 F.G.
SC-ENT/015a	8 F.G.	SC-ENT/015d	11 F.G.
SC-ENT/015b	9 F.G.		

Kramer Eustachian Catheters

Silver, Luer, 140mm

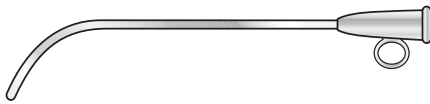

Code	Description	Code	Description
SC-ENT/014	7 F.G.	SC-ENT/014c	10 F.G.
SC-ENT/014a	8 F.G.	SC-ENT/014d	11 F.G.
SC-ENT/014b	9 F.G.		

Myles Naso-Antral Perforator

171mm long

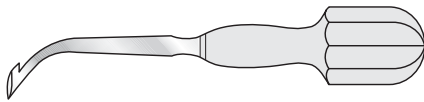

Code	Description
SC-ENT/103a	16 F.G.
SC-ENT/103b	19 F.G.

Tilley Antrum Burrs

171mm long

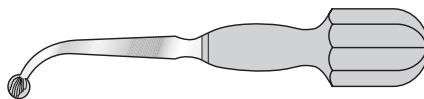

Code	Description
SC-ENT/131a	6mm ø
SC-ENT/131b	7mm ø
SC-ENT/131c	8mm ø

Laryngeal Mirror

Mirror only, 130mm long

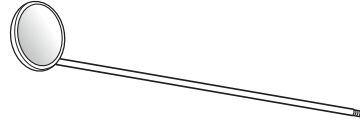

Code	Description	Code	Description
SC-ENT/191-6	6mm ø	SC-ENT/191-20	20mm ø
SC-ENT/191-8	8mm ø	SC-ENT/191-22	22mm ø
SC-ENT/191-10	10mm ø	SC-ENT/191-24	24mm ø
SC-ENT/191-12	12mm ø	SC-ENT/191-26	26mm ø
SC-ENT/191-14	14mm ø	SC-ENT/191-28	28mm ø
SC-ENT/191-16	16mm ø	SC-ENT/191-30	30mm ø
SC-ENT/191-18	18mm ø		

Laryngeal Mirror

Complete with metal handle, 260mm long

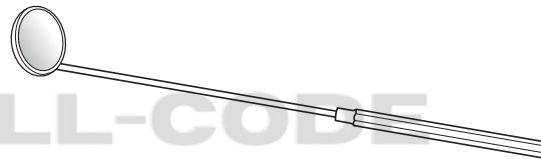

Code	Description	Code	Description
SC-ENT/192-6	6mm ø	SC-ENT/192-20	20mm ø
SC-ENT/192-8	8mm ø	SC-ENT/192-22	22mm ø
SC-ENT/192-10	10mm ø	SC-ENT/192-24	24mm ø
SC-ENT/192-12	12mm ø	SC-ENT/192-26	26mm ø
SC-ENT/192-14	14mm ø	SC-ENT/192-28	28mm ø
SC-ENT/192-16	16mm ø	SC-ENT/192-30	30mm ø
SC-ENT/192-18	18mm ø		

Mitchell Trimmer



Code	Description
SC-ENT/013	165mm



Miscellaneous

Metal-Code by SNA
Manufacturing & Exports Co.

Extracting Forceps

For lower molars with decayed or broken crowns either side
150mm long

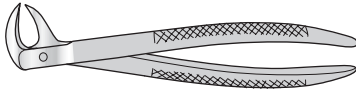

Code	Description
SC-DEN/8576	No 86a



Extracting Forceps

For upper roots, narrow
185mm long

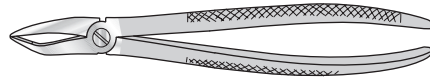

Code	Description
SC-DEN/8552	No 51a, 3mm wide

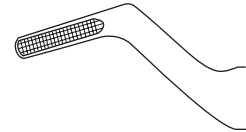

Extracting Forceps

For lower roots either side
165mm long

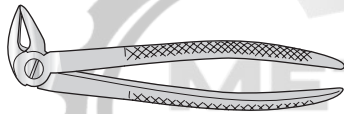

Code	Description
SC-DEN/8532	No 33, 3.5mm wide

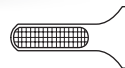

Extracting Forceps

For upper wisdoms either side
185mm long

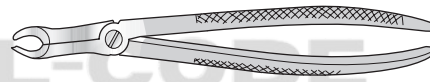

Code	Description
SC-DEN/8560	No 67, 7mm wide

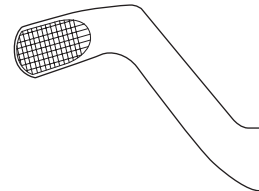

Extracting Forceps

For upper roots
185mm long

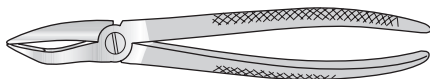

Code	Description
SC-DEN/8550	No 51, 4mm wide

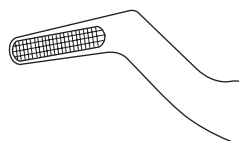

Extracting Forceps

For lower wisdoms either side
185mm long

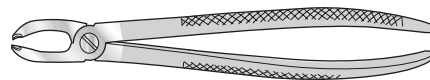

Code	Description
SC-DEN/8574	No 79, 5mm wide

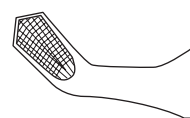

Cryer Tooth Forceps

For upper incisors and roots
185mm long

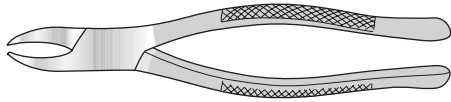

Code
SC-DEN/8010

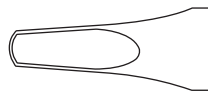

Cryer Tooth Forceps

For incisors and roots
185mm long

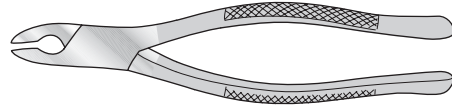

Code	Description
SC-DEN/8013	No 150a

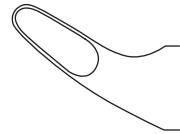

Cryer Tooth Forceps

For incisors and roots
185mm long



Code	Description
SC-DEN/8014	No 62

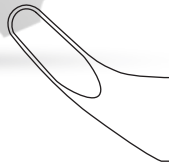

Tooth Forceps

For lower incisors, bicuspid and roots
185mm long

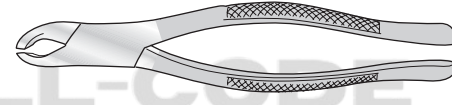

Code	Description
SC-DEN/8036	No 203



Cryer Tooth Forceps

For upper incisors and roots
185mm long

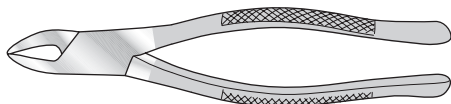

Code	Description
SC-DEN/8012	No 150

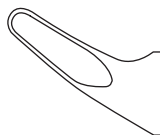

Tooth Forceps

For lower molars either side
185mm long

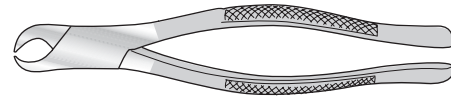

Code	Description
SC-DEN/8039	No 23



Tooth Forceps

For lower molars
185mm long

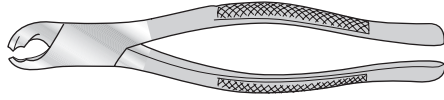

Code	Description
SC-DEN/8042	No 17

Tooth Forceps

For lower roots, incisors and bicuspid
175mm long

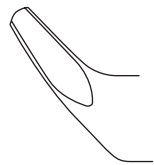
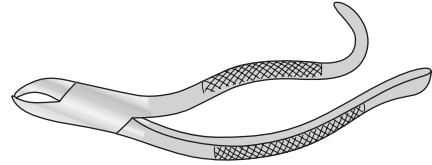

Code	Description
SC-DEN/8045	No 103

Tooth Forceps

For lower wisdom teeth
185mm long

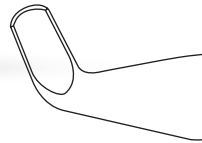
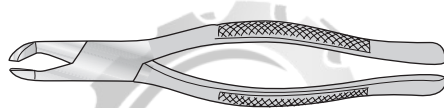

Code	Description
SC-DEN/8043	No 222

Tooth Forceps for Children

160mm long

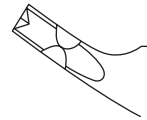
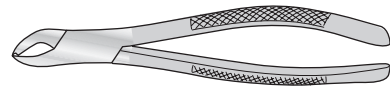

Code	Description
SC-DEN/8037	No 151as, for lower teeth

Code	Description
SC-DEN/8017	No 150as, for upper teeth

Tooth Forceps

For lower molars either side
175mm long

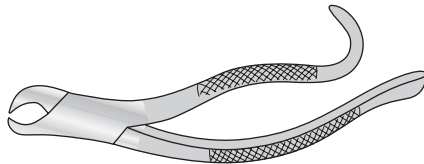

Code	Description
SC-DEN/8040	No 16

Cryer Tooth Forceps for Children

For upper incisors, canines and bicuspid,
160mm long

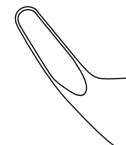
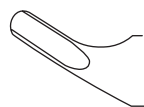
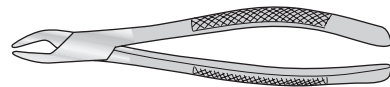

Code	Description
SC-DEN/8011	No 1505

Code	Description
SC-DEN/8033	No 1515

Top Cutting Forceps

Tungsten carbide edge, for bone pins up to 2.5mm ø gold handles

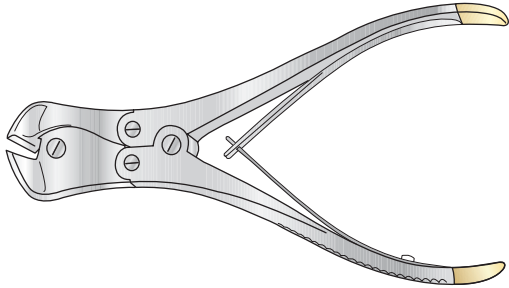

Code	Description
SC-OR/06	215mm long

Side Cutting Forceps

Tungsten carbide edge, for bone pins up to 2.2mm ø gold handles

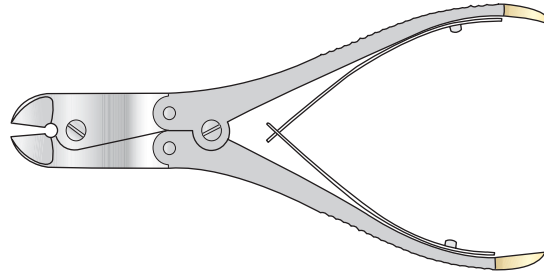

Code	Description
SC-OR/332	230mm long

Top Cutting Forceps

Tungsten carbide edge, for arthrodesis wire up to 1.5mm ø gold handles

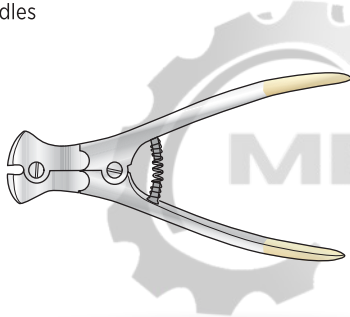

Code	Description
SC-OR/06a	145mm long



Wire Cutting Forceps

Metal-Code by SNA
Manufacturing & Exports Co.

Bein Elevator

140mm long

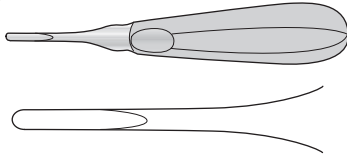

Straight

Code	Description
SC-DEN/8348	2mm wide
SC-DEN/8346	2.5mm wide
SC-DEN/8344	3mm wide
SC-DEN/8342	3.5mm wide
SC-DEN/8340	4mm wide

Curved

Code	Description
SC-DEN/8352	2mm wide
SC-DEN/8347	2.5mm wide
SC-DEN/8345	3mm wide
SC-DEN/8343	3.5mm wide
SC-DEN/8341	4mm wide

Cryer-White Elevator

150mm long

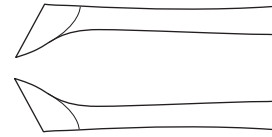

Code	Description
SC-DEN/8261	Left
SC-DEN/8263	Right

Cryer Elevator

150mm long

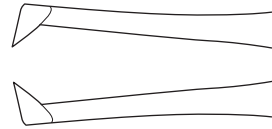
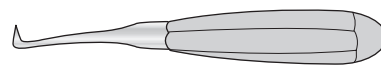

Code	Description
SC-PL/069	Right
SC-PL/069a	Left

Coleman Elevator

145mm long



Code	Description
SC-DEN/8294	Left

Code	Description
SC-DEN/8295	Right

Warwick-James Elevator

150mm long

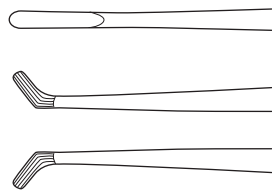

Code	Description
SC-DEN/8275	Straight
SC-DEN/8249	Left
SC-DEN/8251	Right

Coupland Elevator

Curved, 150mm long

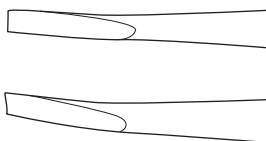
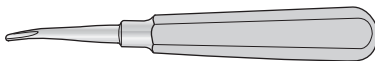

Code	Description
SC-PL/068	3mm wide - Ash no1
SC-PL/068a	4mm wide - Ash no2
SC-PL/068b	5mm wide - Ash no3

Winter Elevator

105mm long

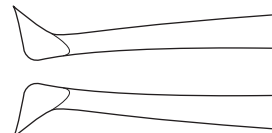
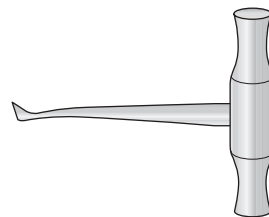

Code	Description
SC-DEN/8338	Left
SC-DEN/8358	Right

Silicone Matting

Medical grade for storage, sterilisation and transportation of instruments.

Cushion, protect, and organise delicate surgical instruments during storage, transportation, and sterilisation. Perforations allow for ventilation during the sterilisation process. The silicone mat can be cut to fit any size container.

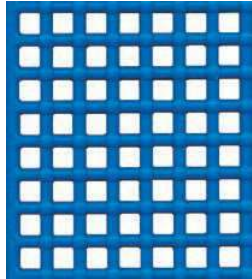

502mm long x 242mm wide
7mm holes, 10mm between holes

Code
BES/1004M

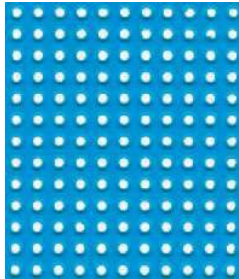

515mm long x 240mm wide
3mm holes, 6mm between holes

Code
BES/1001M

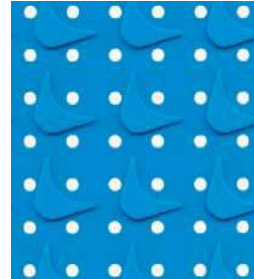

570mm long x 550mm wide
4mm holes, 13mm between holes

Code
BES/1002M

Sterilising Baskets

DIN Basket

Wire mesh base with perforated sides and two carrying handles

Code	Description
SC-GI/CO006	230 x 130 x 60mm
SC-GI/CO007	240 x 130 x 50mm
SC-GI/CO008	240 x 130 x 60mm
SC-GI/CO009	240 x 250 x 50mm
SC-GI/CO010	240 x 250 x 60mm
SC-GI/CO014	300 x 300 x 50mm
SC-GI/CO015	350 x 350 x 60mm
SC-GI/CO011	480 x 250 x 50mm
SC-GI/CO012	480 x 250 x 60mm

Code	Description
SC-GI/CO013	480 x 250 x 70mm
SC-GI/CO016	480 x 400 x 60mm
SC-GI/CO017	480 x 480 x 50mm
SC-GI/CO018	480 x 480 x 60mm
SC-GI/CO019	500 x 300 x 50mm
SC-GI/CO020	550 x 430 x 50mm
SC-GI/CO021	600 x 300 x 60mm



DIN Basket

Wire mesh basket with two carrying handles

Code	Description
SC-GI/CO022	240 x 250 x 50mm
SC-GI/CO023	240 x 250 x 60mm
SC-GI/CO024	240 x 250 x 70mm
SC-GI/CO031	300 x 300 x 60mm
SC-GI/CO025	480 x 250 x 50mm

Code	Description
SC-GI/CO026	480 x 250 x 60mm
SC-GI/CO027	480 x 250 x 70mm
SC-GI/CO028	480 x 250 x 100mm
SC-GI/CO029	480 x 480 x 50mm
SC-GI/CO030	480 x 480 x 70mm

DIN Basket Lids

For perforated and wire mesh baskets

Code	Description
SC-GI/CO032	240 x 250mm
SC-GI/CO033	300 x 300mm
SC-GI/CO034	480 x 250mm
SC-GI/CO035	480 x 480mm

ENT Basket

Wire mesh base with perforated sides and two carrying handles, supplied with lid

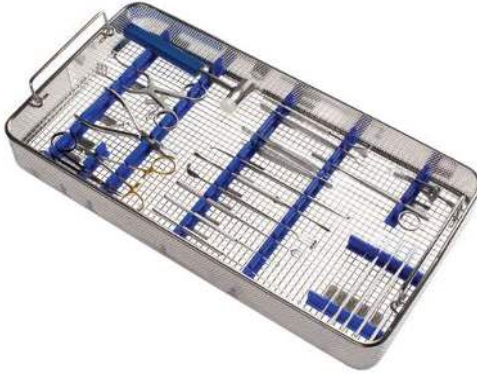

Code	Description
SC-G /CO036	480 x 250 x 160mm
SC-GI/CO037	Fixing clamps

Sieve

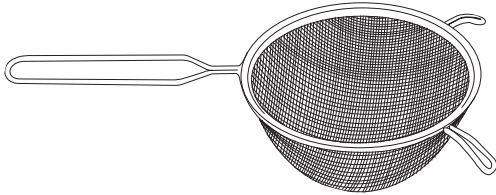

Code	Description
SC-GI/5071	203mm x 50mm ø

Arthroscope Basket

Wire mesh base with two fixing clamps



Code	Description
SC-GI/CO001	290 x 80 x 52mm

Endoscope Basket

With small lens basket

Code	Description
SC-GI/CO002	6400 x 150 x 77mm

wire mesh base with two fixing clamps

Code	Description
SC-GI/CO003	S - 460 x 80 x 52mm
SC-GI/CO004	D - 480 x 80 x 52mm
SC-GI/CO005	D - 680 x 80 x 52mm

Fine Mesh Basket



With hinged take off / lockable lid

Code	Description
SC-GI/CO041	120 x 155 x 40mm
SC-GI/CO044	120 x 155 x 50mm
SC-GI/CO042	235 x 155 x 40mm
SC-GI/CO045	235 x 155 x 50mm
SC-GI/CO043	375 x 260 x 40mm

With separate lid

Code	Description
SC-GI/CO038	120 x 155 x 40mm
SC-GI/CO039	235 x 155 x 40mm
SC-GI/CO040	375 x 260 x 40mm

Needle Holders

Metall-Code by
SNA Manufacturing & Exports Co.
Co.



Castroviejo	8
Castroviejo Tungsten Carbide	8
Collier	7
Converse	8
Crile-Wood	4
Crile-Wood Tungsten Carbide	4
Debakey Tungsten Carbide	9
Derf	5
Derf Tungsten Carbide	5
Gillies	6
Gillies Tungsten Carbide	6
Halsey	5
Halsey Tungsten Carbide	5
Hegar-Baumgartner Tungsten Carbide	9
Kilner Tungsten Carbide	6
Mathieu	7
Mathieu Tungsten Carbide	7
Mayo-Hegar	3
Mayo-Hegar Tungsten carbide	3
Micro Barraquer	9
Nievert	9
Olsen-Hegar	3
Olsen-Hegar Tungsten Carbide	4
Ryder (Vascular) Tungsten Carbide	7
Webster	6

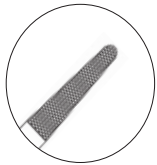

MAYO-HEGAR

Mayo-Hegar needle holders are amongst the most popular locking needle holders used. They have a cross-hatched pattern on the jaws which provides a secure grip on suture needles.

14cm	A4201
16cm	A4203
18cm	A4205
20cm	A4208
23cm	
24cm	A4210
26cm	A4211

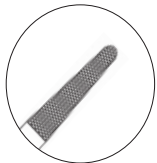

MAYO-HEGAR TUNGSTEN CARBIDE, (LEFT HANDED)

Tungsten carbide mayo-hegar needle holders are amongst the most popular locking needle holders used. They have a cross-hatched pattern on the jaws which provides a secure grip on suture needles. The tungsten carbide inserts in the jaws which provide a better feel of the suturing procedure and a secure grip on the suture needles.

14cm	A4220
16cm	A4221

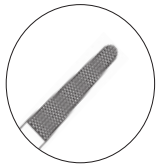

MAYO-HEGAR TUNGSTEN CARBIDE

Tungsten carbide mayo-hegar needle holders are amongst the most popular locking needle holders used. They have a cross-hatched pattern on the jaws which provides a secure grip on suture needles. The tungsten carbide inserts in the jaws which provide a better feel of the suturing procedure and a secure grip on the suture needles.

14cm	A4202
16cm	A4207
18cm	A4204
20cm	A4209
24cm	A4206
26cm	A4212



OLSEN-HEGAR

Olsen-Hegar needle holders are characterised for having a cutting edge behind the jaws which enable the user to cut the suture and grasp the suture needle without changing instruments. These needle holders are available with tungsten carbide Inserts in the jaws which provides a better feel of the suturing procedure and a secure grip on the suture needles. These needle holders have the feel of scissors but lock as well.

11cm	A4306
14cm	A4300
18cm	A4301





OLSEN-HEGAR TUNGSTEN CARBIDE, (LEFT HANDED)

Tungsten carbide olsen-hegar needle holders are characterised for having a cutting edge behind the jaws which enable the user to cut the suture and grasp the suture needle without changing instruments. The tungsten carbide inserts in the jaws which provide a better feel of the suturing procedure and a secure grip on the suture needles. These needle holders have the feel of scissors but lock as well.

14cm	A4320
16cm	A4321



OLSEN-HEGAR TUNGSTEN CARBIDE

Tungsten carbide olsen-hegar needle holders are characterised for having a cutting edge behind the jaws which enable the user to cut the suture and grasp the suture needle without changing instruments. The tungsten carbide inserts in the jaws which provide a better feel of the suturing procedure and a secure grip on the suture needles. These needle holders have the feel of scissors but lock as well.

11cm	A4303
14cm	A4305
16cm	A4302
18cm	A4304



CRILE-WOOD

Crile-Wood needle holders are ideally suited to small to medium size needles.

15cm	A4413
18cm	A4417
20cm	A4419



CRILE-WOOD TUNGSTEN CARBIDE

Tungsten carbide crile-wood needle holders are ideally suited to small to medium size needles. The tungsten carbide inserts in the jaws which provide a better feel of the suturing procedure and a secure grip on the suture needles.

15cm	A4414
18cm	A4418
20cm	A4420
23cm	



DERF

Derf needle holders features short jaws and a fine cross hatched pattern on the jaws that are suitable for small suture needles (commonly 5-0 and 6-0 sutures). Often utilized in ophthalmic, dental, or plastic surgery procedures.

12.5cm ----- **A4500**



DERF TUNGSTEN CARBIDE

Tungsten carbide derf needle holders features short jaws and a fine cross hatched pattern on the jaws that are suitable for small suture needles (commonly 5-0 and 6-0 sutures). Often utilized in ophthalmic, dental, or plastic surgery procedures. The tungsten carbide inserts in the jaws which provide a better feel of the suturing procedure and a secure grip on the suture needles.

12.5cm ----- **A4501**

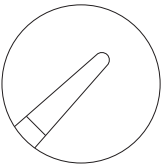
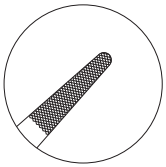

HALSEY

Halsey needle holders are used for holding small suture needles. Commonly used for plastic surgery and delicate procedures such as dermatology. They have fine cross hatched jaws.

SERRATED JAW
13cm ----- **A4105**

SMOOTH JAW (WEBSTER)
13cm ----- **A4107**

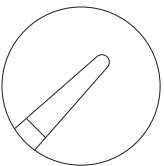
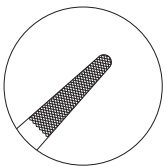

HALSEY TUNGSTEN CARBIDE

Tungsten carbide halsey needle holders are used for holding small suture needles. Commonly used for plastic surgery and delicate procedures such as dermatology. They have fine cross hatched jaws. The tungsten carbide inserts in the jaws which provide a better feel of the suturing procedure and a secure grip on the suture needles.

SERRATED JAW
13cm ----- **A4106**

SMOOTH JAW
13cm -----

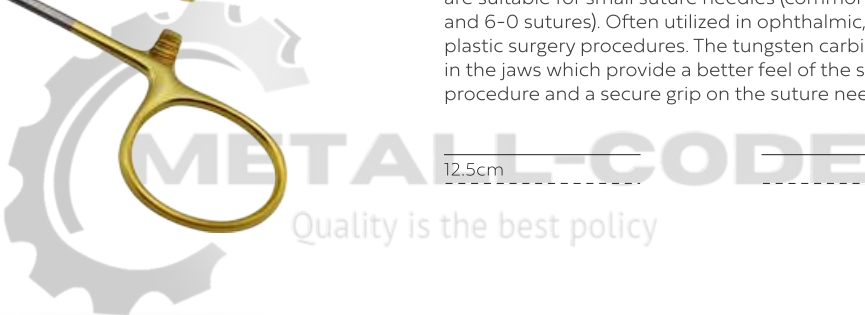



WEBSTER

The Webster needed holder has smooth jaws in a delicate or extra delicate pattern offering a firm hold for the suture needle. The handles are ratcheted to further secure the grasp of the needle and prevent rotation while suturing.

SERRATED JAW	
13cm	A4105
SMOOTH JAW	
13cm	A4107



GILLIES

Gillies needle holders are designed for use with delicate suture needles. They are characterised for having an offset design with curved, cross-hatched jaws with scissors incorporated making it a versatile instrument. This needle holder does not have a locking mechanism.

RIGHT HAND	
16cm	A4102
LEFT HAND	
16cm	A4103



GILLIES TUNGSTEN CARBIDE

Tungsten carbide gillies needle holders are designed for use with delicate suture needles. They are characterised for having an offset design with curved, cross-hatched jaws with scissors incorporated making it a versatile instrument. This needle holder does not have a locking mechanism. The tungsten carbide inserts in the jaws which provide a better feel of the suturing procedure and a secure grip on the suture needles.

RIGHT HAND - TUNGSTEN CARBIDE	
12cm (mini)	A4100
16cm	A4104
LEFT HAND - TUNGSTEN CARBIDE	
16cm	A4101



KILNER TUNGSTEN CARBIDE

Kilner needle holder are characterised for having an S curve on the length of the handle which offsets the cross-hatched jaws from the handles by approximately 10mm. The kilner needle holder is commonly used in delicate procedures.

14cm	A4146
------	--------------





MATHIEU

Mathieu needle holders are sprung needle holders with a handle grip that curves inward at the bottom with a ratchet locking mechanism at the base of the handles. They are squeezed to lock and unlock the cross-hatched jaws. They are available in lengths from 14cm up to 19cm.

14cm	A4150
17cm	A4151
19cm	A4152



MATHIEU TUNGSTEN CARBIDE

Mathieu needle holders are sprung needle holders with a handle grip that curves inward at the bottom with a ratchet locking mechanism at the base of the handles. They are squeezed to lock and unlock the cross-hatched jaws. They are available in lengths from 14m up to 19cm. The tungsten carbide inserts in the jaws which provide a better feel of the suturing procedure and a secure grip on the suture needles.

14cm	A4153
17cm	A4149
20cm	A4148



RYDER (VASCULAR) TUNGSTEN CARBIDE

Ryder (vascular) needle holders are characterised with having narrow cross-hatched jaws and are commonly used with very small suture needles in cardiovascular, plastic, and neurosurgical procedures.

STRAIGHT	
16cm	A4154



COLLIER

Collier needle holders are lockable small needle holders with cross-hatched and grooved out (fenestrated) jaws.

12.5cm	A4502
--------	-------



CONVERSE

Converse needle holders are lockable and are similar to Halsey/Webster needle holders but have unique jaw serrations running parallel to each other. Often used in plastic surgery procedures.

12.5cm	A4499
--------	-------



CASTROVIEJO

Castroviejo needle holders are double sprung instruments used for holding small, delicate suture needles in various microsurgical and ophthalmic procedures. Available in 13cm and 16cm lengths with or without locking mechanism and also curved or straight.

STRAIGHT, WITH LOCK	
13cm	A4250
16cm	A4252
CURVED, WITH LOCK	
13cm	A4251
STRAIGHT, WITHOUT LOCK	
13cm	A4260
CURVED, WITHOUT LOCK	
13cm	A4261

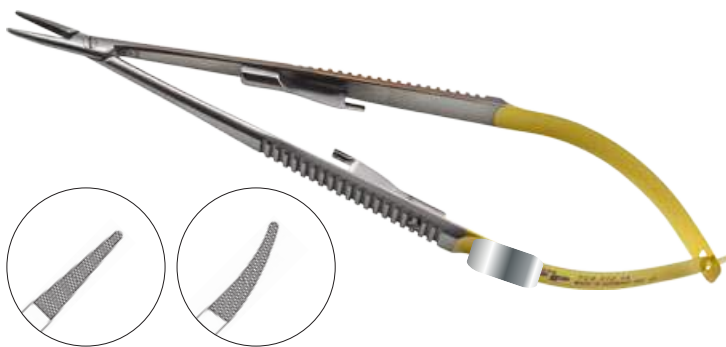

CASTROVIEJO TUNGSTEN CARBIDE

Castroviejo needle holders are double sprung instruments used for holding small, delicate suture needles in various microsurgical and ophthalmic procedures. Available in 13cm and 16cm lengths with or without locking mechanism and also curved or straight. The tungsten carbide inserts in the jaws which provide a better feel of the suturing procedure and a secure grip on the suture needles.

STRAIGHT, WITH LOCK	
14cm	
STRAIGHT, WITHOUT LOCK	
13cm	A4270
CURVED, WITHOUT LOCK	
13cm	A4271



**HEGAR-BAUMGARTNER
TUNGSTEN CARBIDE**

Hegar-Baumgartner needle holders feature heavy serrations on the jaws which make this instrument capable of firmly holding larger suture needles. The tungsten carbide inserts in the jaws which provide a better feel of the suturing procedure and a secure grip on the suture needles.

13cm A4147



DEBAKEY TUNGSTEN CARBIDE

Debakey needle holders are lockable instruments used for holding suture needles in cardiovascular procedures they have tungsten carbide jaws which provide a better feel of the suturing procedure and a secure grip on the suture needles.

18cm A4498
20cm A4497
23cm A4496



MICRO BARRAQUER

The Micro Barraquer needle Holder is used for holding needles they have a reliable, smooth grip jaw necessary for microsurgical and ophthalmic procedures where primarily fine needles are used.

STRAIGHT
12cm A4275
CURVED
12cm A4276



NIEVERT

The Nievert needle holder is a ratcheted finger ring instrument with a smooth jaw and handle lock to prevent needle slippage. Grip comfort is achieved via the one offset angled ring of the handle.

13cm A4108



Scissors

Metal-Code by
SNA Manufacturing & Exports Co.





LISTER BANDAGE SCISSORS

Lister Bandage Scissors are used for trimming dressings and removing bandages as well as cutting tougher material such as plaster and fabric. The blades are angled, and the lower blade is slightly longer. Available in 14.5cm, 18cm and 20cm lengths.

14.5cm	A3138
18cm	A3139
20cm	A3140



UNIVERSAL SCISSORS

Universal/Trauma scissors are used by paramedics and other emergency medical personnel to cut clothing. They have a large finger ring for easy handling and angled serrated blade for precise cutting. They are autoclavable and have coloured handles and plastic tip.

19cm - LARGE	
Black	380 Black
Green	380 Green
Red	380 Red
Pink	380 Pink
16cm - SMALL	
Black	310 Black
Green	310 Green
Red	310 Red
Blue	310 Blue
Orange	310 Orange
Pink	310 Pink
Purple	310 Purple
Yellow	310 Yellow



WARD SCISSORS

Ward scissors are general purpose scissors commonly used for cutting bandages and gauze, available with or without black rubber coated handle.

20cm	379
20cm	379B



CUTICLE SCISSORS

Cuticle scissors are finely pointed and thin with a small blade in order to trim tiny hangnails or frayed tissue around the nail.

STRAIGHT	
9cm	A1946
CURVED	
9cm	A1947



NAIL SCISSORS

Nail scissors are small scissors with a slender shaft and strong blades that are used for shaping and trimming fingernails.

STRAIGHT	
9cm	A1948
CURVED	
9cm	A1949



CASTROVIEJO SCISSORS

Castroviejo scissors are double spring ophthalmic scissors commonly used during iridectomy and corneal surgery. Available in 10cm length with blunt or sharp tips.

BLUNT/BLUNT CURVED	
10cm	A3144
SHARP/SHARP CURVED	
10cm	A3145



Scissors

05

Metal-Code by SNA
Manufacturing & Exports Co.



IRIS SCISSORS

Iris scissors are surgical scissors with short sharp tips. Ideal for precision tasks and ophthalmic applications.

STRAIGHT	
9cm	A3150
11cm	A3152
CURVED	
9cm	A3151
11cm	A3153



IRIS SCISSORS TUNGSTEN CARBIDE

Ward scissors are general purpose scissors commonly used for cutting bandages and gauze, available with or without black rubber coated handle.

STRAIGHT	
11cm	A3149
CURVED	
11cm	A3148



IRIS SUPERCUT SCISSORS

Iris scissors are surgical scissors with short sharp tips. Ideal for precision tasks and ophthalmic applications.

STRAIGHT	
11cm	AS3152
CURVED	
11cm	AS3153



KILNER SCISSORS

Kilner scissors are used for the dissecting and cutting of delicate tissue. They are available in 13cm length with straight or curved blades. **Also available with supercut blades, please see our supercut scissors catalogue**

STRAIGHT	
13cm	A3155
CURVED	
13cm	A3156



KILNER SUPERCUT SCISSORS

Kilner scissors are used for the dissecting and cutting of delicate tissue. They are available in 13cm length with straight or curved blades.

CURVED	
13cm	AS3156



STRABISMUS SCISSORS

Strabismus scissors are blunt tipped scissors used for ophthalmic dissection. Available in straight or curved in 11cm length.

STRAIGHT	
11cm	A3157
CURVED	
11cm	A3158



KELLY SCISSORS

Kelly scissors are sharp tipped and are used to grasp and dissect fascia and soft tissue.

STRAIGHT	
16cm	A3159
CURVED	
16cm	A3160



STEVENS SCISSORS

Stevens Tenotomy Scissors are used for delicate dissection and cutting, usually in ophthalmic, neurological, and plastic surgery procedures. These scissors have 11cm long handles with small blades, straight or curved.

STRAIGHT	
11cm	A3161
CURVED	
11cm	A3162



STEVENS SUPERCUT SCISSORS

Stevens Tenotomy Scissors are used for delicate dissection and cutting, usually in ophthalmic, neurological, and plastic surgery procedures. These scissors have 11cm long handles with small blades, straight or curved.

STRAIGHT	
11.5cm	A3161
CURVED	
11.5cm	A3162



O'BRIEN SCISSORS

O'Brien Scissors are primarily used for suture removal.

9cm	
11.5cm	A3163



FERGUSSON SCISSORS

Ferguson Abdominal Scissors, have an angled profile and are used for multipurpose cutting and dissecting.

	HIPP	KLINI	ARMO
18cm		K1.047.18	
21cm			A3179



BRAUN STADLER SCISSORS

Braun-Stadler Episiotomy Scissors are used to perform episiotomies during labour and delivery. Available in 14.5cm and 22cm lengths with blunt tips.

14.5cm	A3180
22cm	A3181



UMBILICAL SCISSORS

Umbilical scissors used for cutting the umbilical cord. These 10.5cm long scissors have wide, straight, curved blades.

10.5cm	A3182
12.5cm	A3183



SIMS UTERINE SCISSORS

Sims (Uterine) scissors have long blades, primarily used for deep tissue dissection. These scissors are available with blunt tips with straight or curved blades in 20cm and 23cm length.

STRAIGHT	
20cm	A3184
CURVED	
20cm	A3185
23cm	A3178





MAYO SCISSORS

Mayo Scissors have blunt ends and are generally used for cutting sutures and ligatures or trimming the skin around a wound. Mayo scissors are available in lengths from 14.5cm up to 22cm with or without tungsten carbide blades with straight or curved blades.

STRAIGHT	
14.5cm	A3202
16cm	A3204
18cm	A3207
20cm	A3208
22cm	A3215
CURVED	
14.5cm	A3203
16cm	A3205
18cm	A3209
20cm	A3211
22cm	A3214



MAYO SCISSORS TUNGSTEN CARBIDE

Mayo Scissors have blunt ends and are generally used for cutting sutures and ligatures or trimming the skin around a wound. Mayo scissors are available in lengths from 14.5cm up to 22cm with or without tungsten carbide blades with straight or curved blades.

STRAIGHT	
14.5cm	A3200
18cm	A3206
22cm	A3212
CURVED	
14.5cm	A3201
17cm	A3210
22cm	A3213



MAYO SUPERCUT SCISSORS

Mayo Scissors have blunt ends and are generally used for cutting sutures and ligatures or trimming the skin around a wound.

STRAIGHT	
14cm	AS3202
17cm	AS3207
20cm	AS3208
CURVED	
14cm	AS3203
17cm	AS3209



MAYO HARRINGTON SCISSORS

Mayo Harrington Dissecting Scissors have flat sharp blades with blunt tips and are available in straight or curved in a 22cm length.

STRAIGHT	
22cm	1.030.22
CURVED	
22cm	1.031.22



METZENBAUM SCISSORS

Metzenbaum scissors are surgical scissors designed for cutting delicate tissue and blunt dissection. These scissors feature a more delicate profile than the standard metzenbaum scissor.

STRAIGHT	
12cm	A3249
14cm	A3253
16cm	A3255
18cm	A3257
20cm	A3262
22cm	A3263
CURVED	
12cm	A3250
14cm	A3254
16cm	A3256
18cm	A3258
20cm	A3264
22cm	A3265
28cm	A3248



METZENBAUM SCISSORS FINE

Metzenbaum scissors are surgical scissors designed for cutting delicate tissue and blunt dissection. They are finer and more delicate than Mayo scissors.

FINE TIP STRAIGHT	
15cm	A3246
FINE TIP CURVED	
15cm	A3247





**METZENBAUM SCISSORS
TUNGSTEN CARBIDE**

Tungsten carbide metzenbaum scissors are surgical scissors designed for cutting delicate tissue and blunt dissection. They are finer and more delicate than mayo scissors. Having the blades infused with tungsten carbide allows for greater durability of the scissor.

STRAIGHT	
14cm	A3251
18cm	A3266
20cm	A3267
22cm	A3260
CURVED	
14cm	A3252
18cm	A3259
20cm	A3268
22cm	A3261

METALL-CODE

Quality is the best policy



METZENBAUM SUPERCUT SCISSORS

Supercut metzenbaum scissors are surgical scissors designed for cutting delicate tissue and blunt dissection. They are finer and more delicate than Mayo scissors.

STRAIGHT	
SHARP/BLUNT	
14cm	AS3166
18cm	AS3167
BLUNT/BLUNT	
11cm	
14cm	AS3253
18cm	AS3257
CURVED	
SHARP/BLUNT	
14cm	AS3168
18cm	AS3169
BLUNT/BLUNT	
11cm	AS3250
14cm	AS3254
18cm	AS3258

sharp/blunt

blunt/blunt



SURGICAL SCISSORS

Surgical or operating scissors are used for general cutting and dissecting of tissue, bandages and gauze. They are available with blunt or sharp blades or a combination of both. Surgical scissors are available in lengths from 11cm up to 20cm with straight or curved blades.



sharp/sharp

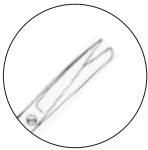

sharp/blunt



blunt/blunt



sharp/probe



sharp/sharp

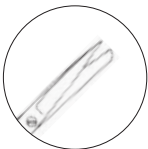

sharp/blunt

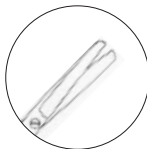

blunt/blunt

STRAIGHT

SHARP/SHARP

11cm	A3296
13cm	A3302
14cm	A3290
16cm	A3320
18cm	A3323
20cm	A3346

SHARP/BLUNT

11cm	A3297
13cm	A3301
14cm	A3292
16cm	A3319
18cm	A3339

BLUNT/BLUNT

11cm	A3298
13cm	A3300
14cm	A3294
16cm	A3318
18cm	

SHARP/PROBE

13cm	A3306
------	-------

CURVED

SHARP/SHARP

11cm	A3295
13cm	A3305
14cm	A3289
16cm	A3317
18cm	A3332
20cm	

SHARP/BLUNT

11cm	
13cm	A3304
14cm	A3291
16cm	A3316
18cm	A3331

BLUNT/BLUNT

11cm	A3299
13cm	A3303
14cm	A3293
16cm	A3315
18cm	A3330



Scissors

13

Metal-Code by SNA
Manufacturing & Exports Co.



**SURGICAL SCISSORS
TUNGSTEN CARBIDE**

Tungsten carbide surgical or operating scissors are used for general cutting and dissecting of tissue, bandages and gauze. They are available with blunt or sharp blades or a combination of both. Having the blades infused with tungsten carbide allows for greater durability of the scissor.

STRAIGHT	
SHARP/SHARP	
14cm	A3307
16cm	A3324
18cm	A3333
SHARP/BLUNT	
14cm	A3308
16cm	A3325
18cm	A3335
BLUNT/BLUNT	
14cm	A3309
16cm	A3326
18cm	A3337

CURVED	
SHARP/SHARP	
14cm	A3310
16cm	A3327
18cm	A3334
SHARP/BLUNT	
14cm	A3311
16cm	A3328
18cm	A3336
BLUNT/BLUNT	
14cm	A3312
16cm	A3329
18cm	A3338

SPENCER SUTURE SCISSORS

Spencer Scissors are primarily used for suture removal. These scissors have a hook shaped tip on one blade that slides under sutures to slightly lift them before cutting. This hook also prevents the suture from slipping off the blade prior to cutting.

9cm	A3400
12cm	A3401
14cm	A3402



GOLDMANN FOX SUPERCUT SCISSORS

Goldmann Fox Scissors are used in dental procedures to trim gingival tissue. They are also used in plastic surgery or hemorrhoidectomy. They have curved, bevelled blades, one of which is serrated, that taper into sharp, fine tips. Available in 13cm length with Supercut blades

CURVED	
13cm	AS3165



REYNOLDS SUPERCUT SCISSORS

Reynolds scissors are characterised by having narrow, tenotomy style tips, generally used for cutting tissue as well as dissection. Available in 15cm length with curved supercut blades.

CURVED	
15cm	AS3147



WAGNER SUPERCUT SCISSORS

Wagner Scissors are used in procedures requiring delicate or precise cutting, particularly plastic surgery. Available in 12cm length with straight or curved Supercut blades.

STRAIGHT	
12cm	AS3163
CURVED	
12cm	AS3164



Scissors

15

Metal-Code by SNA
Manufacturing & Exports Co.

Forceps

Metall-Code by
SNA Manufacturing & Exports Co.

VERSION 11



Contents (by kind)	2
Contents (alphabetically ordered)	2

Aural Dressing Forceps	12
Catheter Forceps	13
Dental Forceps	14
Dissecting Forceps	15
Dressing Forceps	4
Entomological/Jewellers Forceps	15
Eye Forceps	16
First Aid & Splinter Forceps	10
Intestinal Clamps/Forceps	20
Sponge Holding Forceps	21
Steriliser Forceps	22
Tissue Forceps	6
Uterine Forceps	22
Vasectomy Forceps	24





BLOCK END

Dressing Forceps are designed to hold gauze and other dressings. They are for general use including grasping dressings, suture material, tissue or foreign bodies in wounds.

BLUNT	
11cm	A2404
13cm	A2402
14cm	A2138
16cm	A2139
18cm	A2409
20cm	A2140
25cm	A2141
DELICATE	
13cm	A2403



TURNOVER END

Dressing Forceps are designed to hold gauze and other dressings. They are for general use including grasping dressings, suture material, tissue or foreign bodies in wounds.

BLUNT	
13cm	103
15cm	104



ADSON, SERRATED TIPS

Adson Dressing Forceps are used for holding materials such as cotton and gauze, changing dressings, or packing wounds. They have a wide thumb grasp for improved control.

STANDARD POINT	
12cm	A2401
15cm	A2407
MICRO POINT	
12cm	A2400

Dressing Forceps

MCINDOE, SERRATED TIPS

McIndoe Forceps are used for holding materials such as cotton and gauze, changing dressings, or packing wounds. These forceps have a stop peg to ensure that when used for holding tissue the grip is not crushing.

15cm	A2415
------	--------------

POTTS SMITH, SERRATED TIPS

Potts-Smith Dressing Forceps are used for applying and changing of dressings. They may also be used for dissection of tissue.

STRAIGHT	
18cm	A2608
21cm	A2136
CURVED	
18cm	

SEMKEN, SERRATED TIPS

Semken Dressing Forceps are most commonly used for applying and changing of dressings. They have narrow tips that may be beneficial for neurosurgery or other procedures performed in hard to reach places. They may also be used for dissection of fine or single-layer tissue. These forceps have a stop peg to ensure that when used for holding tissue the grip is not crushing.

12.5cm	A2610
15cm	A2611

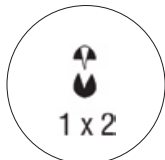

Tissue Forceps

STANDARD

Tissue Forceps are used for grasping, holding, and manipulating various types of tissue. Thumb tissue forceps are toothed to grip the tissue more firmly than the equivalent serrated tip forceps.

1X2 TEETH

11cm	A2606
13cm	A2615
14cm	A2616
16cm	A2617
18cm	A2624
20cm	A2614
25cm	A2618

2X3 TEETH

12.5cm	A2621
14cm	A2622
16cm	A2623



ALDERKREUTZ

Adlerkreutz tissue forceps are commonly used for neurosurgery and cardiovascular surgery due to the wider tips.

4X5 TEETH

15cm	3.238.15
------	----------

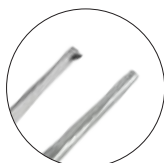
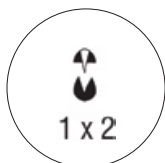

ADSON

Adson Tissue Forceps are used for holding and manipulating delicate tissue.

1X2 STANDARD

12cm	A2600
15cm	A2592

1X2 TYING PLATFORM

12cm	
------	--

1X2 MICRO

12cm	A2559
15cm	A2591

Tissue Forceps



ADSON-TUNGSTEN CARBIDE

Adson Tissue Forceps are used for holding and manipulating delicate tissue.

1X2 STANDARD

12cm

A2601

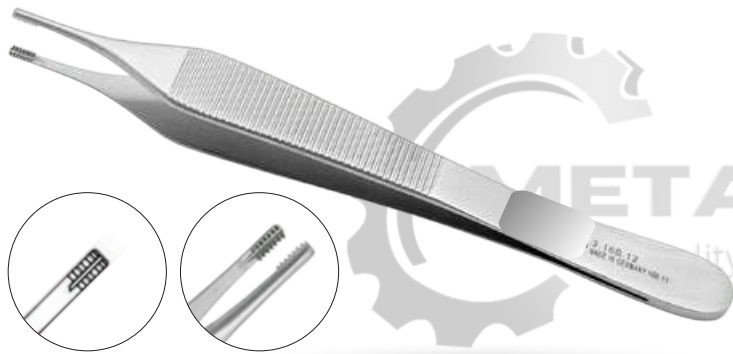

ADSON BROWN

Adson Brown Tissue Forceps are used for holding and manipulating delicate tissue. They have jaws with 9x9 serrated teeth running horizontally down the tips of the forcep.

12cm

A2554



TREVES

Treves tissue forceps are characterised by having a tip with interlocking teeth making them suitable for holding skin or dense tissue.

1X2 TEETH

13cm

A2630

15cm

Tissue Forceps

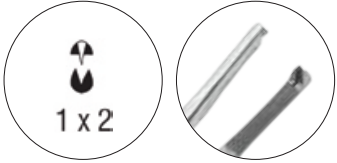
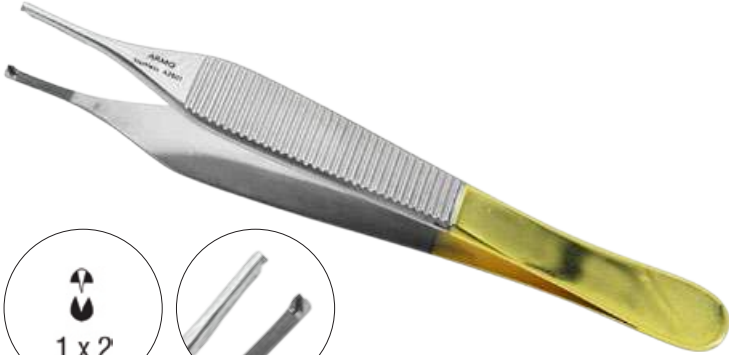

ADSON-TUNGSTEN CARBIDE

Adson Tissue Forceps are used for holding and manipulating delicate tissue.

1X2 STANDARD

12cm

A2601

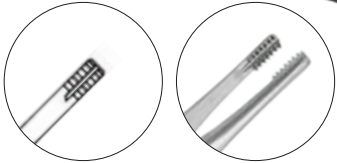

ADSON BROWN

Adson Brown Tissue Forceps are used for holding and manipulating delicate tissue. They have jaws with 9x9 serrated teeth running horizontally down the tips of the forceps.

12cm

A2554



TREVES

Treves tissue forceps are characterised by having a tip with interlocking teeth making them suitable for holding skin or dense tissue.

1X2 TEETH

13cm

A2630

15cm

Tissue Forceps



LANE

Lane Tissue Forceps are used for holding tough tissue. The handle is smooth and features a slight thumb/finger indentation for greater control.

1X2 TEETH	
14.5cm	A2607

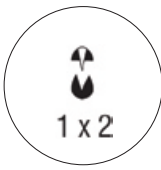

POTTS SMITH

Potts Smith tissue forceps are used for grasping fine or delicate tissue. They have a stop peg to prevent an overly harsh grasp that may crush the tissue.

1X2 TEETH	
18cm	A2609



SEMKEN

Semken Tissue Forceps are lightweight, narrow forceps used for gripping fine membranes or single layer tissues.

1X2 TEETH	
12.5cm	A2612
15cm	A2613



First Aid & Splinter Forceps

FEILCHENFELD

Feilchenfeldt splinter forceps are multi-purpose with sharp tips used for removing small foreign objects. Available in 9cm and 11.5cm lengths.

9cm	A2550
11.5cm	A2551

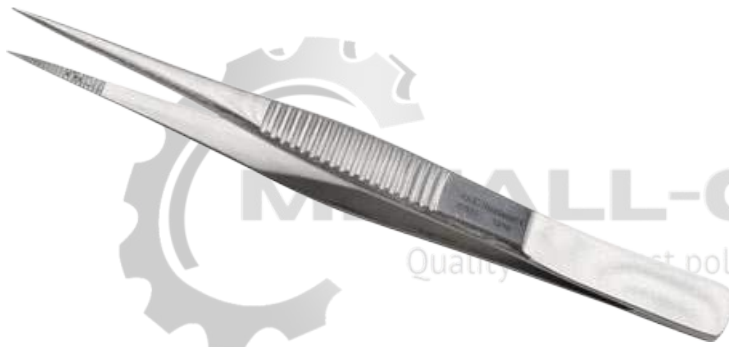

FIRST AID/SPLINTER

First Aid/Splinter forceps can be recognized by their serrated handles that taper to fine tips. These forceps are suitable for removing splinters or other minor medical uses. Available in 9cm length with pointed, flat or slanted tips and 12.5cm with pointed tips.

POINTED	
9cm	A2519
12.5cm	A2520

FLAT	
9cm	

SLANTED	
9cm	



FORCEPS WITH MAGNIFIER

These forceps with magnifier lens aids the precise location of the splinter. Available in 10cm length straight or curved.

FLAT	
10cm	206

CURVED	
10cm	208

First Aid & Splinter Forceps

HUNTER

Hunter Forceps are characterised by having an arrowhead pointed serrated tip and are used for the removal of splinters and other foreign bodies or to hold and manoeuvre dressings or soft tissue during procedures.



STRAIGHT NO PIN	
10cm	
STRAIGHT WITH PIN	A2552
10cm	
CURVED WITH PIN	A2555
10cm	

STIEGLITZ

Stieglitz Forceps are ratcheted forceps with an arrowhead pointed serrated tip and are usually used in dental procedures.



15cm	A2553
------	--------------

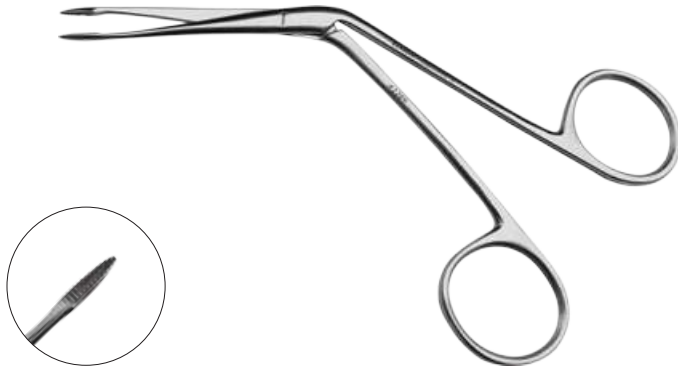

Aural Dressing Forceps

HARTMAN STANDARD

The Hartmann alligator forceps or Hartmann foreign body forceps are medical forceps for removing foreign bodies. It is used in addition to surgery mainly in ENT.

14cm	A2209
------	--------------



HARTMAN POLYPUS, SERRATED JAWS

Hartman Polypus Forceps are used for ENT applications where arteries or objects in the aural cavity need to be clamped, grasped or removed. They have serrated jaws.

8cm	A2200
11cm	A2201
14cm	A2202

1X2 TEETH	
8cm	A2205



MCGEE MICRO EAR, MICRO SERRATED JAWS

McGee Micro Ear Forceps are right-angled forceps with serrated jaws used in procedures to finely excise tissues in the narrow spaces of the aural cavity.

8cm	A2206
11cm	A2207



TILLEY AURAL DRESSING, SERRATED ENDS

Tilley Aural Dressing Forceps have serrated jaws and are designed for the removal or insertion of nasal dressings or packs.

14cm	A2204
------	--------------

Aural Dressing Forceps

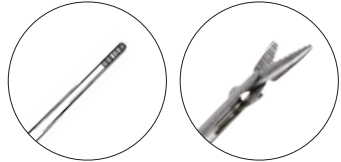

FLEXIBLE ALLIGATOR

The Flexible Alligator forcep has a flexible shaft that allows it to be fed through Veterinary Oscopes.

14cm A2215

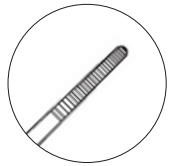

TROELTSCH AURAL DRESSING, SERRATED ENDS

Troeltsch Forceps are commonly used in ENT procedures. These distinctive serrated forceps are bent at an 80-degree angle and are particularly useful for packing and dressing in ENT procedures.

13cm A2198
18cm A2185

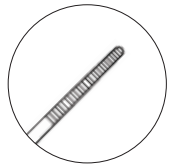

JANSEN AURAL DRESSING, SERRATED ENDS

Jansen dressing forceps are commonly used in nasal procedures. The bayonet style handle and long serrated jaws assist in an unobstructed view when working in the nasal cavity.

20cm A2203

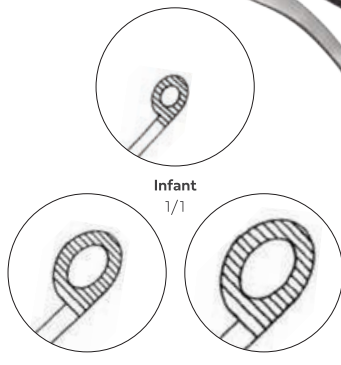
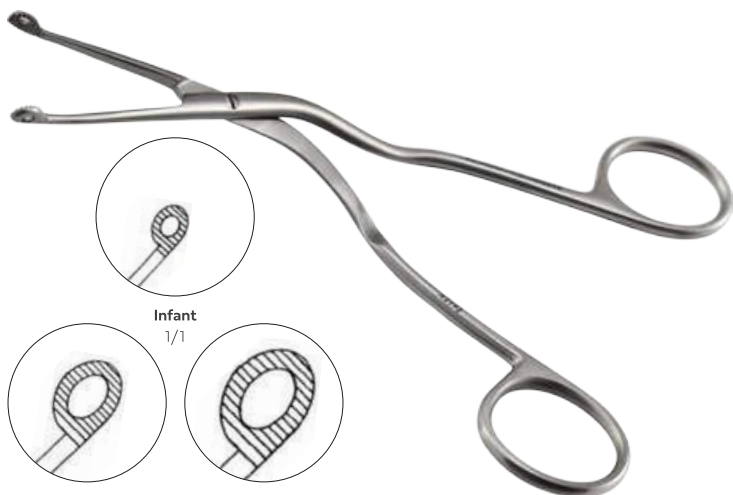

Catheter Forceps

MAGILL

Magill Catheter Forceps have fenestrated tips and are used for grasping endotracheal tubes during intubation and removing foreign bodies from the airway. They can also be used to grasp other types of catheters during insertion.

INFANT	
15cm	A2192
CHILD	
20cm	A2193
ADULT	
25cm	A2194



**PERRY DENTAL,
SERRATED TIPS**

Perry Dental Forceps are curved serrated forceps with a location peg used for cotton wad placement and removal.

CURVED

13cm

A2295



**LONDON COLLEGE,
SERRATED TIPS**

London College Forceps are used to grasp or transfer materials in and out of the oral cavity. They have serrated tips and a locking device.

**ANGLED
WITH LOCK**

15cm

A2296

Dissecting Forceps



DISSECTING, POINTED

Dissecting Forceps are used to handle tissue and other materials and to manipulate needles and other instruments whilst operating.

STRAIGHT	
12.5cm	A2370
CURVED	
13cm	

Entomological/Jewellers Forceps



JEWELLERS

Jewellers Forceps are used in microsurgical procedures. The micro-fine tips that can handle extremely fine tissues and materials that standard instruments may damage.

STRAIGHT NO.3 SUPER FINE	
12.5cm	A2524
STRAIGHT NO.5 SUPER FINE	
11cm	A2525
CURVED NO.7 SUPER FINE	
13cm	A2527



Eye Forceps

AYER CHALAZION

Ayer Chalazion Forceps are ophthalmic forceps used to invert the eyelid.

9cm A2189



LAMBERT CHALAZION

Lambert Chalazion Forceps are ophthalmic forceps used to invert the eyelid.

9cm A2190



DESMARRES CHALAZION

Desmarres Chalazion Forceps are ophthalmic forceps used to invert the eyelid.

NO.1
9cm A2516

NO.2
9cm A2517

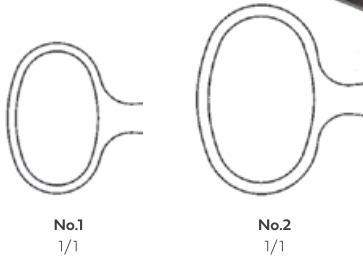

BEER CILIA

Beer Cilia Forceps are used for grasping and holding cilia/eyelashes. The tips are rounded with a raised centre.

9cm A2191

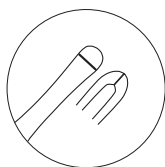

Eye Forceps



DOUGLAS CILIA

Cilia Forceps are used for removing cilia/eyelashes, foreign bodies and sutures around the eye and eyelid.

9cm

A2188



CILIA, SLANT EDGE

Cilia Forceps are used for removing cilia/eyelashes, foreign bodies and sutures around the eye and eyelid.

9cm

A2186



BARRAQUER CILIA

Barraquer Cilia Eye Forceps are an ophthalmologic instrument used for grasping or manipulating eyelashes.

9cm

A2187



Figure 1



Figure 2



Figure 3

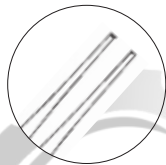

Figure 4

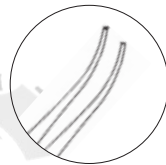
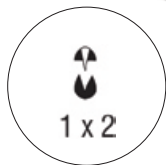
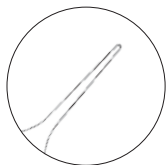
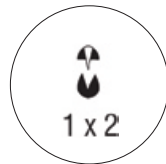

Figure 5



Eye Forceps

GRAEFE IRIS

Graefe Iris Forceps are used during ophthalmic procedures to grasp and hold tissue.

STRAIGHT - NO PIN (figure 1)	
7cm	A2508
STRAIGHT - WITH PIN (figure 1)	
10cm	A2511
STRAIGHT - WITH PIN, 1X2 TEETH (figure 4)	
10cm	A2507
HALF CURVED - NO PIN (figure 2)	
7cm	A2509
HALF CURVED - WITH PIN (figure 2)	
10cm	A2512
HALF CURVED - WITH PIN, 1X2 TEETH (figure 5)	
10cm	A2505
FULL CURVED - WITH PIN (figure 3)	
10cm	A2506

LESTER, 1X2 TEETH

Lester Forceps are used during ophthalmic procedures to grasp and hold tissue.

STRAIGHT - WITH PIN	
9cm	A2510
CURVED - NO PIN	
7cm	A2513

CASTROVIEJO, 1X2 TEETH

Castroviejo Forceps are used in ophthalmic and plastic surgery procedures near the eyes. The forceps are used to grasp tissue and sutures.

9cm	A2514
-----	--------------

Eye Forceps

CASTROVIEJO CORNEAL FORCEPS

Castroviejo Corneal forceps are extremely delicate tissue forceps with a tying platform and a micro jaw.

10.5cm

A2182

BISHOP HARMAN

The Bishop Harman Forceps are used during surgeries to grasp tissues in skin grafting or removing affected tissues from the body, they are designed to be used in various ophthalmologic procedures.

8cm

A2502

ROBERTS

The Roberts Forcep is used in conjunction with a needleholder to tie knots in fine materials.

10cm

A2184

COLIBRI

The Colibri forcep is designed to perform several functions. The tooth at the tip is ideal for holding the corneal or scleral edge when passing a suture and it can also be used for gasping iris tissue.

7.5cm

A2183



Intestinal Clamps/ Forceps

PENNINGTON

Pennington Forceps are used for holding tissue that needs to be sutured or for haemostasis.

15cm	A2535
------	--------------



TUBING CLAMP

Tubing Forceps are ratcheted forceps are used to control moderate to heavy flow of fluids or blood. They are a heavyweight instrument and can be used with heavy tubing or vessels.

15cm	A2530
------	--------------



DOYEN INTESTINAL CLAMP

The Doyen Intestinal clamps have longitudinal serrations and a non crushing clamp, are a lightweight instrument and are typically used to grasp large organs. This instrument is available in both straight and curved and the serrations on the jaw run diagonally across the jaws.

STRAIGHT	
16.5cm	K33.108.16
21cm	K33.114.20
23cm	K33.115.23

CURVED	
16.5cm	K33.109.16
21cm	K33.115.20
23cm	K33.115.23



MAYO-ROBSON/ DOYEN

The Mayo-Robson/Doyen Intestinal forcep are used to gently but firmly grip onto tissue. It is commonly used for anastomosis or holding the bowel during intestinal procedures. The serrations on the jaw of the forcep run parallel along the length of the jaws.

STRAIGHT	
17cm	A2720
21cm	A2722
24cm	A2724

CURVED	
17cm	A2721
21cm	A2723
24cm	A2725

Sponge Holding Forceps

FOERSTER

Foerster Sponge Forceps are used in surgical procedures to hold gauze squares that will absorb excess fluids and blood from the surgical site. The rounded, looped tips are serrated.

18cm	A2538
20cm	A2542
25cm	A2537

RAMPLEY

Rampley Sponge Forceps are used to hold sponges and swabs. The jaws are elongated and contain serrated tips to hold swabs or sponges.

18cm	A2539
24cm	A2540

LISTER SINUS

Lister Sinus Forceps are used for inserting or removing packing in the sinus cavity.

13cm	A2521
15cm	A2522

MAIER POLYPUS

The Maier Polypus Sponge Holding Forcep is used for the placement, holding and removal of dressings. It's serrated tips allow a secure grips on swabs, gauze and other dressing materials.

25cm	2.286.25
------	-----------------

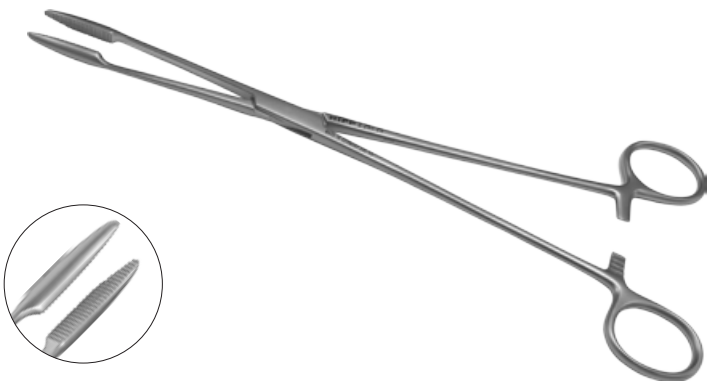
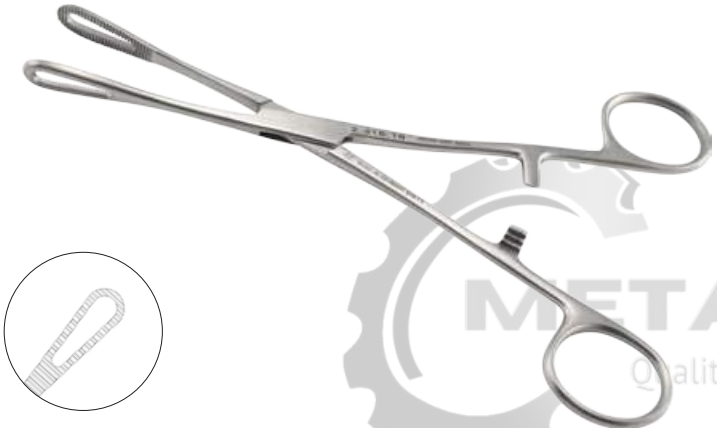



Steriliser Forceps

CHEATLE

Cheatle Sterilizer Forceps are used to remove sterilised instruments from the sterilisation container.

LIGHT
PATTERN
27cm

A2541

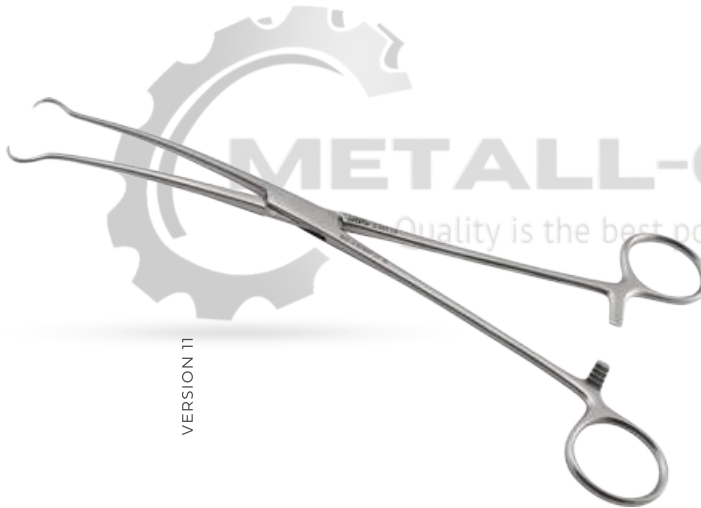

VERSION 11

Uterine Forceps

SKENE

Skene Forceps are ratcheted curved forceps and are used to grasp and steady the cervix and the uterus during gynaecological surgery. The tips have hooked single toothed jaws.

24cm

A2701



SCHROEDER, TENACULUM

Schroeder Tenaculum Forceps are ratcheted forceps with use in obstetric and gynaecological procedures.

2X2 TEETH
25cm

A2702

Uterine Forceps



SCHROEDER-BRAUN, TENACULUM

Schroeder Tenaculum Forceps are ratcheted forceps with use in obstetric and gynaecological procedures.

25cm

A2700

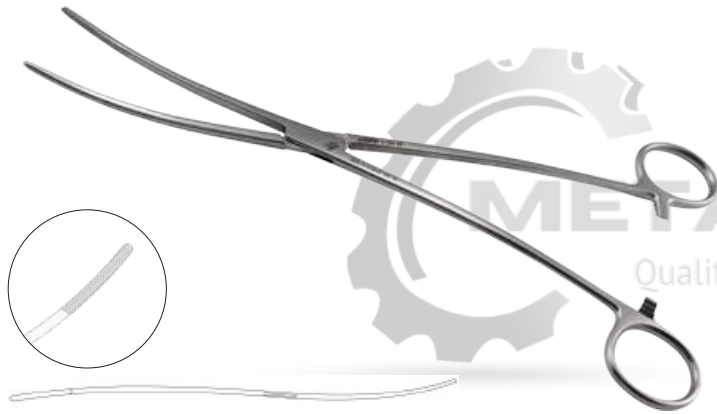

BOZEMAN, DRESSING

Bozeman Uterine Dressing Forceps are used in gynaecological procedures. The shanks are slightly curved to provide greater visibility when used in the uterine cavity.

SERRATED,
CURVED

26cm

A2628



TEALE, VULSELLUM

Teale Vulsellum Forceps are curved ratcheted forceps used in obstetric and gynaecological surgery.

CURVED

25cm

A2626



Vasectomy Forceps

VASECTOMY TOWEL CLAMPS

Vasectomy Towel Clamps are ratcheted forceps used in non-suture vasectomy procedures.

3MM TIP

14cm

A5171



VASECTOMY

Vasectomy Forceps are ratcheted forceps with sharp tips used to pierce the scrotal skin in vasectomy procedures.

CURVED

12cm

A5172

VERSION 11



Artery Forceps

Metall-Code by
SNA Manufacturing & Exports Co.

VERSION 11



Crile	4
Debaque Atraumatic	6
Diffenbach	3
Ferguson (Angiotribe)	5
Halstead-Mosquito	3
Hartman-Micro	3
Heiss	7
Kelly	4
Lahey	6
Micro-Mosquito	3
Mixter	4
Roberts	6
Rochester-Carmalt	5
Rochester-Ochsner	5
Rochester-Pean	5
Rumel	6
Sawtell-Schmidt	7
Spencer-Wells	4



DIFFENBACH

Diffenbach artery forceps are small cross action artery clamps and are used in soft tissue surgery.

CURVED	
3.8cm	A2090



HARTMAN-MICRO

Hartman- Micro artery Forceps are small ratcheted forceps and are used to compress small blood vessels or other tubular structures to obstruct the flow of blood or fluids.

STRAIGHT	
10cm	A2196
STRAIGHT - 1X2 TEETH	
10cm	A2199
CURVED	
10cm	A2197
CURVED - 1X2 TEETH	
10cm	



MICRO-MOSQUITO

Micro-Mosquito Artery Forceps are small ratcheted forceps and are used to compress small blood vessels or other tubular structures to obstruct the flow of blood or fluids.

STRAIGHT	
15cm	A2118
CURVED	
12cm	A2119

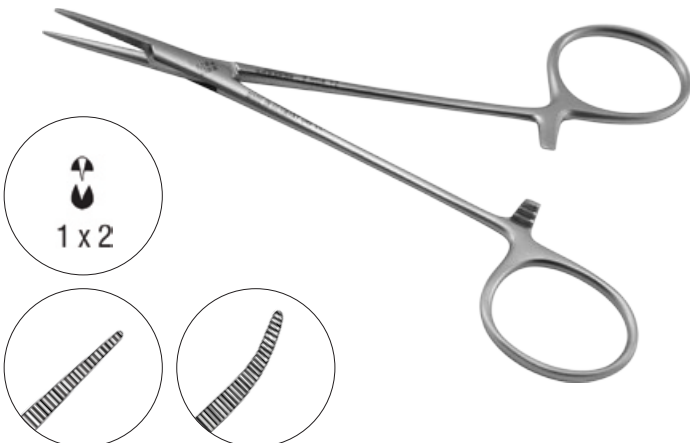

HALSTEAD-MOSQUITO

Halsted Micro Mosquito Forceps ratcheted forceps and are used as a haemostat for small blood vessels. Available in 12cm length with straight or curved serrated jaws, and 12.5cm and 14cm toothed jaws straight or curved.

STRAIGHT	
12cm	A2120
STRAIGHT - 1X2 TEETH	
12.5cm	A2122
14cm	
CURVED	
12cm	A2121
CURVED - 1X2 TEETH	
12.5cm	A2142
14cm	



CRILE

Crile Artery Forceps are ratcheted forceps used for clamping blood vessels or tissue before cauterization or ligation. The horizontal serrations extend the entire length of the jaw, and the particularly long jaws in relation to the shanks are a unique characteristic.

STRAIGHT	
14cm	A2110
16cm	A2112
18cm	A2114
CURVED	
14cm	A2111
16cm	A2113
18cm	A2115

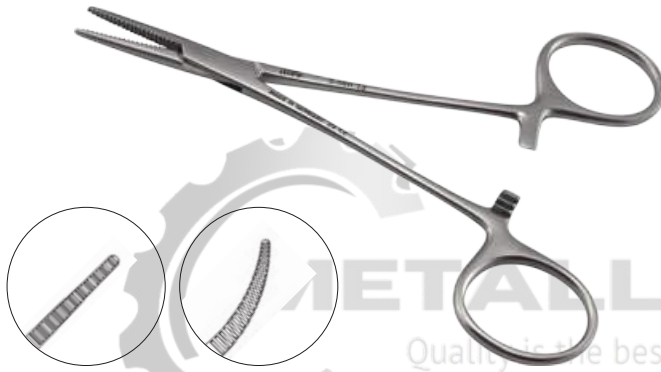

SPENCER-WELLS

Spencer Wells Forceps are ratcheted haemostatic forceps used to control blood flow in vessels. They have short, serrated jaws, which are designed to seal small blood vessels.

STRAIGHT	
13cm	A2150
15cm	A2152
18cm	A2154
CURVED	
13cm	A2151
15cm	A2153
18cm	A2155



KELLY

Kelly Artery Forceps are ratcheted forceps used for clamping large blood vessels or manipulating heavy tissue.

STRAIGHT	
14cm	A2123
16cm	A2125
18cm	A2127
CURVED	
14cm	A2124
16cm	A2126
18cm	A2128



MIXTER

Mixer Artery Forceps are ratcheted forceps used for working in obscured surgical positions. They have serrated jaws curved sharply into a right angle.

CURVED	
14cm	A2144
18cm	A2145

VERSION 11



ROCHESTER-CARMALT

Rochester-Carmalt Artery Forceps are ratcheted forceps. They are characterised by having longitudinally serrated jaws and cross-serrated tips which allows them to grip large blood vessels.

STRAIGHT	
16cm	A2100
CURVED	
16cm	A2105

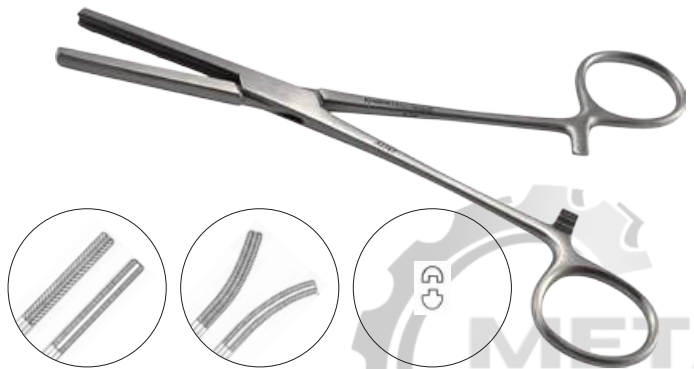

FERGUSON (ANGIOTRIBE)

Ferguson Angiotribe forceps are ratcheted heavy duty haemostats with interlocking serrated jaws, used to control bleeding from a blood vessel.

STRAIGHT	
17cm	A2163
20cm	A2164
CURVED	
17cm	A2165
20cm	A2166



ROCHESTER-OCHSNER

Rochester-Ochsner Forceps are heavy duty ratcheted haemostats with interlocking serrated jaws, used to control bleeding from large, dense blood vessels. They have horizontal serrations the entire length of the jaw as well as 1 X 2 teeth at the tip.

STRAIGHT - 1X2 TEETH	
16cm	A2133
18cm	A2135
CURVED - 1X2 TEETH	
16cm	A2134



ROCHESTER-PEAN

Rochester-Pean Artery Forceps are ratcheted forceps used for clamping larger tissue and vessels for haemostasis. The jaws have horizontal serration across the full length of the jaws.

STRAIGHT - 1X2 TEETH	
18cm	A2137
20cm	A2129
22cm	A2131
CURVED - 1X2 TEETH	
20cm	A2130
22cm	A2132
30cm	

Quality is the best policy



DEBAKEY ATRAUMATIC

DeBakey Atraumatic Artery Forceps are thumb forceps used in delicate surgical procedures. They are used for grasping fine tissue and blood vessels. The narrow tips have atraumatic teeth along the length of the jaws.

16cm	A4106
20cm	A4107



LAHEY

Lahey Artery Forceps are ratcheted forceps used as haemostats for clamping blood vessels or tissue before cauterization or ligation. They are characterised by having horizontal serrations the entire length of the jaw, and jaws that are approx. half the length of the shank.

CURVED	
18cm	A2143



VERSION 11

ROBERTS

Roberts Artery Forceps are ratcheted forceps used as haemostats for clamping blood vessels or tissue. They are larger than standard artery forceps and have serrated jaws.

STRAIGHT	
20cm	A2159
CURVED	
20cm	A2160



RUMEL

Rumel Artery Forceps are ratcheted forceps used as haemostats in cardiothoracic procedures. They are characterised by having a combination of serrated and smooth jaws.

CURVED	
23cm	A2146



HEISS

Heiss Artery Forceps are predominantly used for the restriction of blood flow blood vessels and contains a ratchet for secure clamping.

STRAIGHT	
20cm	A2156
CURVED	
20cm	A2157
20cm	A2158



SAWTELL-SCHMIDT

Sawtell Artery Forceps are stainless steel finger ringed instruments and are ergonomically designed for haemostasis and holding tissue.

STRAIGHT	
19cm	A2161
CURVED	
19cm	A2162





Ligators

Metall-Code by
SNA Manufacturing & Exports Co.
VERSION 11

Ligator Bands	3
Ligator, Haemorrhoidal	3
McGiveny Ligator Forcep	3



MCGIVENY LIGATOR FORCEP

McGiveny Ligator Forceps are used to grasp the ligator bands used in haemorrhoid removal.

19cm A3605

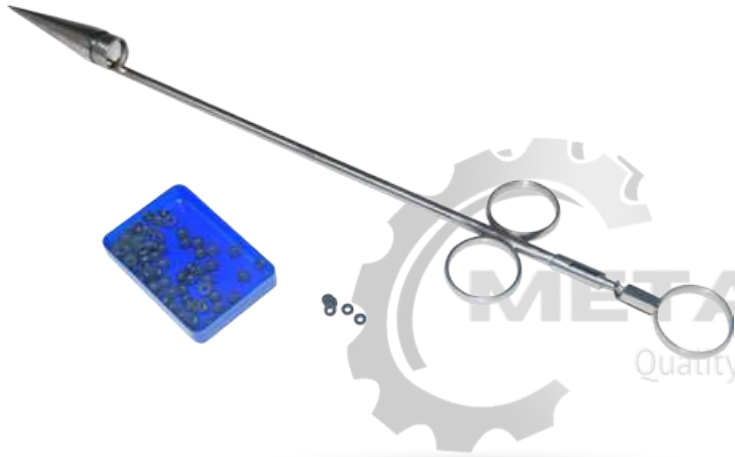

LIGATOR, HAEMORRHOIDAL

Rudd Haemorrhoid Ligator is an instrument used in one process for the removal of haemorrhoids. It uses a thumb plunger system to release the bands.

With cone K33.350.31



LIGATOR, HAEMORRHOIDAL

Rudd Haemorrhoid Ligator is an instrument used in one process for the removal of haemorrhoids. It uses a thumb plunger system to release the bands.

With cone A1990



LIGATOR BANDS

NON-STERILE
Vial of 100 A1991



Eye & Nasal Specula

Metall-Code by
SNA Manufacturing & Exports Co.

VERSION 11

Eye Specula

Alfense	4
Bangerter	5
Barracuer Wire	3
Barracuer Wire (Solid)	3
Castro vieja	6
Cock	5
Krapp-Clark	6
Kratz-Barracuer Heavy (Imm) Wire	4
Kratz-Barracuer Wire	3
Lester-Burch	5
Lieberman V-Wire	6
Mellinger	5
Murdoch	4
Sauer	4
Weiss	6
Wire Specula - Infant	3

Nasal Specula

Thudicum	7
----------	---



Eye Specula

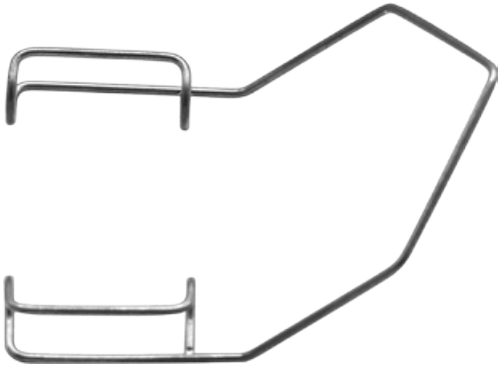

BARRAQUER WIRE

Barraquer Wire Eye Specula is an ophthalmic instrument used to retract and hold the eyelid open during surgery.

ADULT

15mm blades **100 4014**

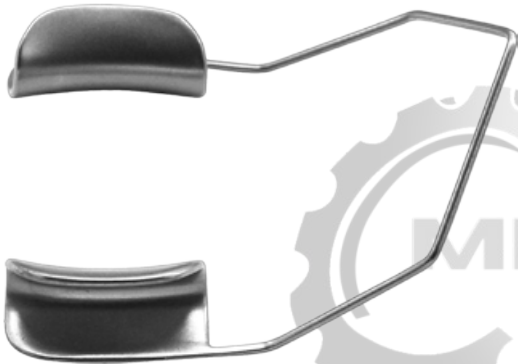

BARRAQUER WIRE (SOLID)

Barraquer Wire Solid Eye Specula is an ophthalmic instrument used to retract and hold the eyelid open during surgery.

ADULT

15mm blades **106 4015**

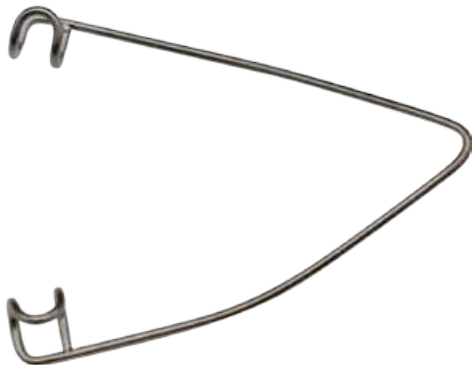

WIRE SPECULA - INFANT

Wire Eye Specula is an ophthalmic instrument used to retract and hold the eyelid open during surgery.

INFANT

5mm blades **108 3604**

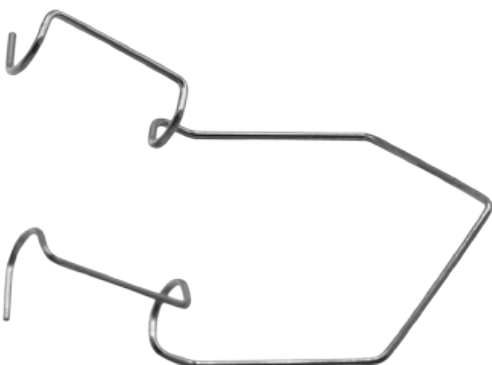

KRATZ-BARRAQUER WIRE

Kratz-Barraquer Wire Eye Specula is an ophthalmic instrument used to retract and hold the eyelid open usually during cataract removal surgery.

ADULT

15mm blades **109 4015**

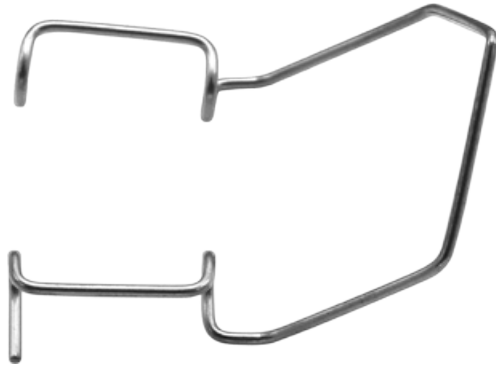

KRATZ-BARRAQUER HEAVY (1MM) WIRE

Kratz-Barraquer Wire Eye Specula is an ophthalmic instrument used to retract and hold the eyelid open usually during cataract removal surgery. Heavy duty wire provides greater force than standard wire.

ADULT

15mm blades **110 4015**

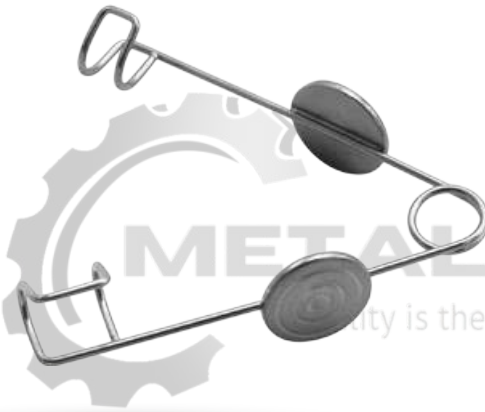

ALFONSO

Alfonso Eye Specula is an ophthalmic instrument used to retract and hold the eyelid open during paediatric surgery with the assistance of thumb rests on the frame.

8 x 5mm blades **128 4608**

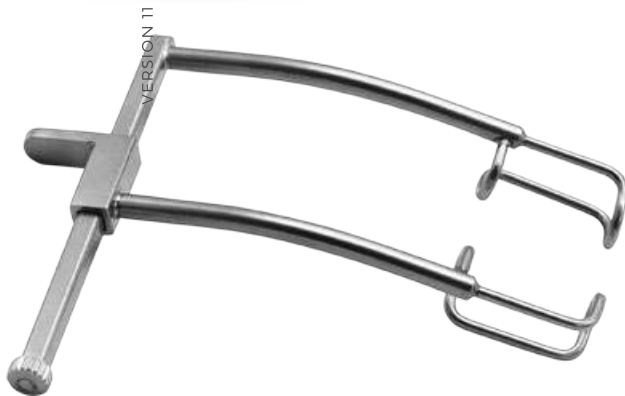

MURDOCH

Murdoch eye specula is an ophthalmic instrument used to retract and hold the eyelid open during surgery. It is characterised by having curved retractor blades which are mounted back to back on a bar along which one of them can be moved to part the eyelids.

ADULT, LEFT

15mm blades **138 5010**

ADULT, RIGHT

15mm blades **138 5001**

CHILD, LEFT

10mm blades **138 4410**

CHILD, RIGHT

10mm blades **138 4401**



SAUER

Sauer Eye Specula is an ophthalmic instrument used to retract and hold the eyelid open during paediatric surgery with the assistance of sprung hinged blades.

11mm blades **162 3010**



Eye Specula

BANGERTER

Bangerter Eye Specula is an ophthalmic instrument used to retract and hold the eyelid open during surgery. It is characterised by having curved retractor blades which are mounted back to back on a bar along which one of them can be moved to part the eyelids. A locking nut is fitted as well.

ADULT

15mm blades **140 5515**

COOK

Cook Eye Specula is an ophthalmic instrument used to retract and hold the eyelid open during surgery. It is characterised by having curved retractor blades which are mounted back to back on a bar along which one of them can be moved to part the eyelids. A locking nut is fitted as well.

CHILD

11mm blades **136 4011**

MELLINGER

Mellinger Eye Specula is an ophthalmic instrument used to retract and hold the eyelid open during surgery. It is characterised by having curved retractor blades which are mounted back to back on a spring-loaded bar along which one of them can be moved to part the eyelids.

CHILD

10mm **134 5011**

LESTER-BURCH

Lester-Burch Eye Specula is an ophthalmic instrument used to retract and hold the eyelid open during surgery. It is characterised by having curved retractor blades which are mounted on sprung pivoting arms with thumb grips and a locking nut is fitted as well.

ADULT

15mm blades **165 8522**



Specula

05

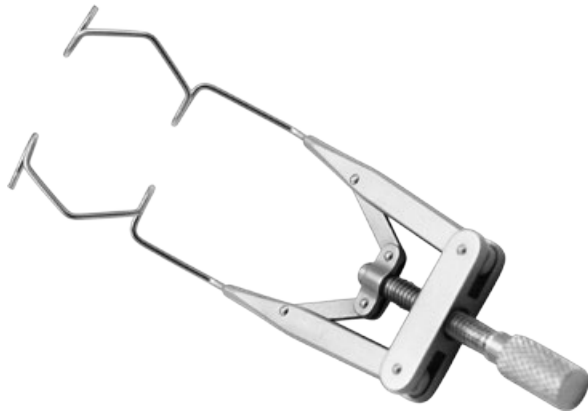

LIEBERMAN V-WIRE

Lieberman V-wire Eye Specula is an ophthalmic instrument used to retract and hold the eyelid open during surgery. It is characterised by having curved open wire blades which are mounted with stepless adjustable spreading arms.

ADULT	
15mm blades	164 6215V

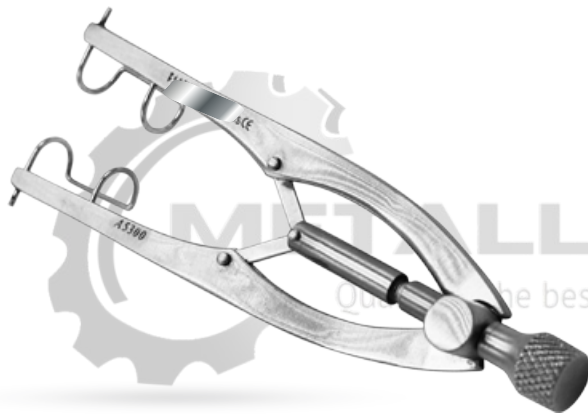

CASTROVIEJO

Castroviejo Eye Specula is an ophthalmic instrument used to retract and hold the eyelid open during surgery. It is characterised by having curved open wire blades which are mounted with stepless adjustable spreading arms.

15mm blades	A5300
-------------	--------------



WEISS

The Weiss eye speculum is an ophthalmic instrument used to keep the eyelids apart during surgical intervention such as glaucoma surgery, corneal transplant, laser eye surgery or a general ocular examination.

ADULT	
	142 7010
CHILD	
	142 9020

KNAPP-CLARK

The Knapp-Clark eye speculum is an ophthalmic instrument used to keep the eyelids apart during surgical intervention such as glaucoma surgery, corneal transplant, laser eye surgery or a general ocular examination.

	144 8001
--	-----------------



Nasal Specula

THUDICHUM

Thudichum Nasal Speculum are used to examine the nasal cavity. The blades are inserted into the nostrils to widen the nasal cavity to view the nasal structures.



NO.0	18 x 8mm	A5400
NO.1	20 x 10mm	A5401
NO.2	22 x 12mm	A5402
NO.3	24 x 13mm	A5403
NO.4	26 x 13mm	A5404





Vaginal Specula & Proctoscopes

Metall-Code by
SNA Manufacturing & Exports
Co.

VERSION 11

Vaginal Specula

Grave	3
Kogan Endocervival Speculum	3
Pederson	3
Sims	3

Proctoscopes

Kelly	4
-------	---

Uterine, Sounds

Sims Malleable	4
Sims Rigid	4



Vaginal Specula



GRAVE

A Grave Vaginal Specula is a gynaecological instrument used for performing vaginal pelvic examinations.

SMALL	
20x75mm	A5500
MEDIUM	
35x95mm	A5501
LARGE	
35x115mm	A5502
EXTRA LARGE	
38x128mm	



PEDERSON

Pederson Vaginal Specula is a gynaecological instrument used for performing vaginal pelvic examinations.

SMALL	
13x75mm	A5503
MEDIUM	
22x100mm	A5504
LARGE	
25x120mm	A5505

Double Ended



Single Ended

SIMS

Sims Vaginal Specula is a gynaecological instrument. The Sims vaginal speculum is used to dilate a vagina so that the cervix and the vagina can be examined.

DOUBLE ENDED	
Small	A5511
Medium	A5512
Large	A5513
SINGLE ENDED	
Small	A5515
Medium	A5516
Large	A5517

KOGAN ENDOCERVIVAL SPECULUM

Kogan Endocervical Speculum is a gynaecological instrument used for viewing the distal endocervical canal. This single spring, locking instrument features opposing, fenestrated blades at the end of long jaws.

WITH SET SCREW & GAUGE	
3mm wide tips 24cm	A5506
WITH RATCHET, NO GAUGE	
3mm wide tips 28cm	A5507
7mm wide tips 28cm	A5508





Proctoscopes

KELLY

Kelly Proctoscope is used to examine the anal cavity, rectum or colon.

STANDARD	
21 x 50mm	A2390
MEDIUM	
27 x 50mm	A2391
LONG	
22 x 100mm	A2392

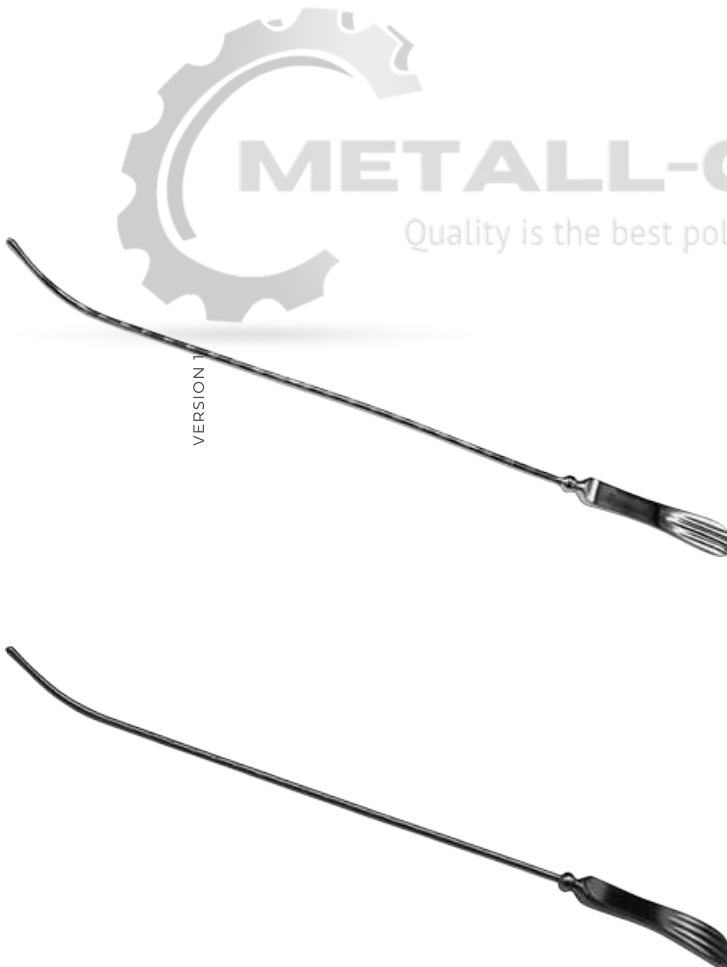

Uterine, Sounds

SIMS MALLEABLE

Sims Uterine Sound is an obstetric instrument used for probing and dilating the uterus as well as measuring the length of the cervical canal. The instrument has graduated centimetre markings.

Silver plated brass	A3819
---------------------	--------------

SIMS RIGID

Sims Uterine Sound is an obstetric instrument used for probing and dilating the uterus as well as measuring the length of the cervical canal. The instrument has graduated centimetre markings.

Solid stainless steel	A3820
-----------------------	--------------



Scalpels & Blades

Mettall-Code by
SNA Manufacturing & Exports Co.

VERSION 11



Blades	
Solid Forged Knife	3
Handles	
for blades 10-15	3
for blades 18-36	4
Scalpels	
Sterile Disposable Scalpels	4
Disposable Safety Scalpels	5
Sterile Stitch Cutter	5
Sterile Blades	
Sterile Surgical Blades	5
Blade Management System	
Blade Management System	6



Blades

SOLID FORGED KNIFE

STANDARD GRIP

No. 4

277

Handles

FOR BLADES 10-15

STANDARD GRIP

No. 3

A4950

Quality is the best policy

WITH SCALE IN mm

No. 3

A4956

ROUND GRIP

No. 3

A4952

HEXAGONAL GRIP

No. 3

A4958

No. 7

A4954

MEDISAFE BLADE

No. 3

MSSH3



Handles

FOR BLADES 18-36

STANDARD GRIP

No. 4 **A4951**

WITH SCALE IN mm

No. 4 **A4957**

HOLLOW HANDLE

No. 9 **A4953**

MEDISAFE

No. 4 **MSH54**

VERSION 11



No. 10



No. 11



No. 15

Scalpels

STERILE DISPOSABLE SCALPELS

Ultra sharp carbon steel blade.

- Ergonomically designed handles for better feel and precision.
- Graduated scale on handles for convenience.
- Blade shape printed on boxes for easy identification and selection.
- Individual scalpels are packed in easy peel foils.

PACK OF 10

No. 10 **ZBD10**

No. 11 **ZBD11**

No. 12 **ZBD12**

No. 15 **ZBD15**

No. 20 **ZBD20**

No. 21 **ZBD21**

No. 22 **ZBD22**

No. 23 **ZBD23**

No. 24 **ZBD24**

Note: other sizes available on request



STERILE DISPOSABLE SAFETY SCALPELS

Top Activated. Retractable. Single Use Safety Scalpels. Stainless Steel Blades.

PACK OF 10

No. 10	MSS10
No. 11	MSS11
No. 12	MSS12
No. 15	MSS15
No. 20	MSS20
No. 21	MSS21
No. 22	MSS22
No. 23	MSS23
No. 24	MSS24

Note: other sizes available on request



Retractable

Straight

STERILE STITCH CUTTER

Slightly rounded tip for added safety and minimal patient discomfort.

STRAIGHT (PACK OF 100)

11.5cm

RETRACTABLE, STAINLESS STEEL (PACK OF 10)

11.5cm

MSSST

Sterile Blades

STERILE SURGICAL BLADES

Individually packed in easy peel foil packs.

- Blade shape printed on boxes for easy identification and selection.
- Blades fit all makes of handles.
- Blades conform to European Medical Device Directive 93/42/EEC. All sizes are sold in boxes of 100.
- Carbon Steel Blades.



No. 10

No. 11

No. 12

No. 15

No. 20



No. 21

No. 22

No. 23

No. 24

No. 25

PACK OF 100

No.10	ZB10
No.11	ZB11
No.12	ZB12
No.15	ZB15
No.15C	ZB15C
No.20	ZB20
No.21	ZB21
No.22	ZB22
No.23	ZB23
No.24	ZB24

Note: other sizes available on request



VERSION 11



METALL-CODE

Quality is the best policy

Blade Management System

STERILE BLADE MANAGEMENT SYSTEM

Patented blade safety system. Eliminates blade injuries during the fitment and removal of surgical blades. Eliminates the need to use a needle holder to remove surgical blades. Securely fits to blades directly to scalpel handles.

CARTRIDGES, PACK OF 50

No.10	BMS10
No.11	BMS11
No.15	BMS15
No.20	BMS20
No.21	BMS21
No.22	BMS22
No.23	BMS23
No.24	BMS24

Note: other sizes available on request



Plaster Instruments

Mettall-Code by
SNA Manufacturing & Exports Co.

VERSION 11

Beeson Spreader	4
Brun's Plaster Scissors	3
Esmarch Plaster Scissors	3
Haglind-Stille Spreader	4
Herrig Spreader	4
Stille Cutting Shears	3
USA Model Spreader	4
Wolff Cast Breaker	3



WOLFF CAST BREAKER

Wolff Cast Breaker is used for breaking open plaster casts. It is a single spring, plier instrument. The jaws are curved and have horizontal serrations.

18cm	
24cm	A6000



BRUNS PLASTER SCISSORS

Bruns Plaster Shears are heavy duty scissors/shears designed for use with plaster and fiberglass castings.

SMOOTH JAW	
24cm	A6005
SERRATED JAW	
24cm	A6006



ESMARCH PLASTER SCISSORS

Esmarch Plaster Shears are heavy duty angled scissors/shears designed for use with plaster and fiberglass castings.

20cm	A6007
------	--------------



STILLE CUTTING SHEARS

Stille Plaster Shears are large 2 handled shears used to remove heavy or large plaster casts. They have round handles to facilitate ease in the cast removal.

23cm	A6003
37cm	A6004



BEESON SPREADER

Beeson Plaster Spreader is used to aid in the removal of plaster casts. The blades of the spreader are closed by opening the handle and are inserted into a section of the cast. When squeezing the handle, the blades spread open thereby forcing the cast open.

30cm A6002

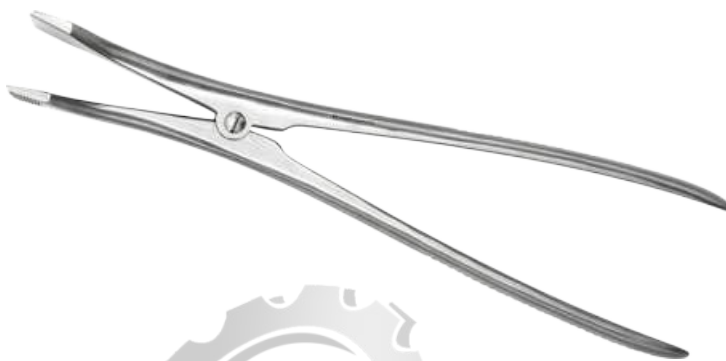

HENNIG SPREADER

Hennig Plaster Spreader is used to aid in the removal of plaster casts. The blades of the spreader are closed by opening the handle and are inserted into a section of the cast. When squeezing the handle, the blades spread open thereby forcing the cast open.

27cm A6001

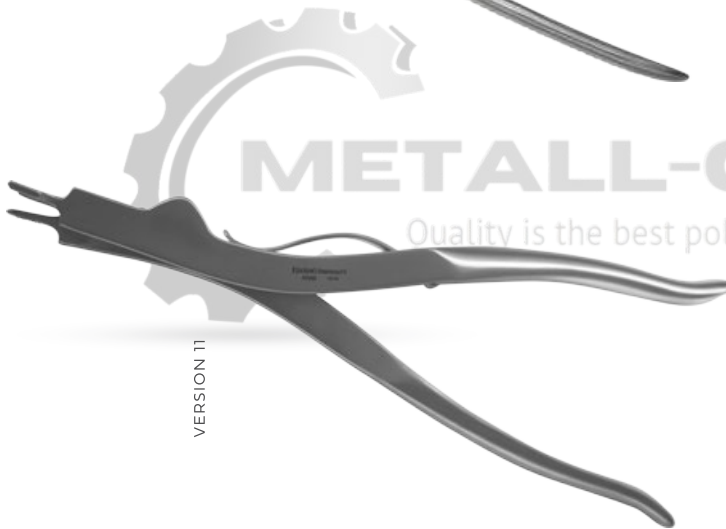

VERSION 11

USA MODEL SPREADER

USA Model Plaster Spreader is used to aid in the removal of plaster casts. The pointed blades of the spreader are closed by opening the handle and are inserted into a section of the cast. When squeezing the handle, the blades spread open thereby forcing the cast open.

23cm A5998



HAGLUND-STILLE SPREADER

Haglund-Stille Plaster Spreader is used to aid in the removal of plaster casts. The tips of the spreader are closed by opening the handle and are inserted into a section of the cast. When squeezing the handle, the right angles tips spread open thereby forcing the cast open.

28cm A5999



Hooks

Retractors & Elevators

Metal-Code by
SNA Manufacturing & Exports Co.

Hooks

Gillies	3
Hartman Cerumen	3
Joseph	3
Kilner	4
Spey (Snook Ovaryectomy)	3
Tracheal	4

Retractors

Delicate	6
Gelpi	5
Parsonnet Epicardial	5
Ragnell-Davis	6
Senn Miller	6
Weitlaner	5

Elevators

Septum	7
--------	---



Hooks

SPEY (SNOOK OVARECTOMY)

Spey hook is a long, thin, probe like instrument with a curved end and a buttoned tip, used in an ovariectomy procedure.

7cm shank	A3000
11cm shank	A3001



HARTMAN CERUMEN

Hartman Cerumen Hook allows for the easy extraction of hard wax and other obstacles from the ear canal.

16cm	A2999
------	-------



GILLIES

Gillies Skin Hook is used to retract the skin during surgical procedures.

SHARP - 4MM HOOK	
18cm	A3358
BLUNT - 4MM HOOK	
18cm	A3356

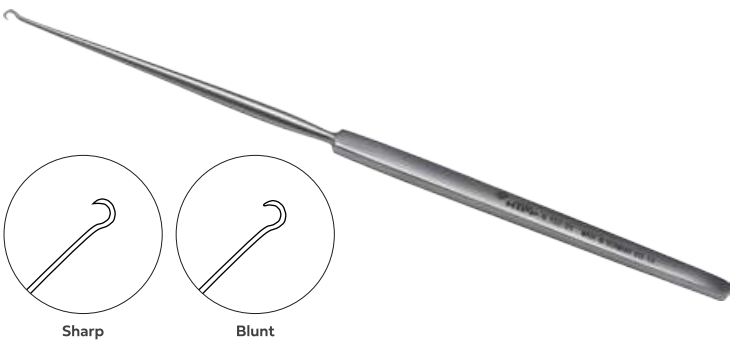

JOSEPH

Joseph Skin Hook is used to retract the skin during intranasal and pharyngeal surgical procedures. It has a round handle with dual sharp prongs on the end.

2MM	
16cm	A3351
5MM	
16cm	A3350

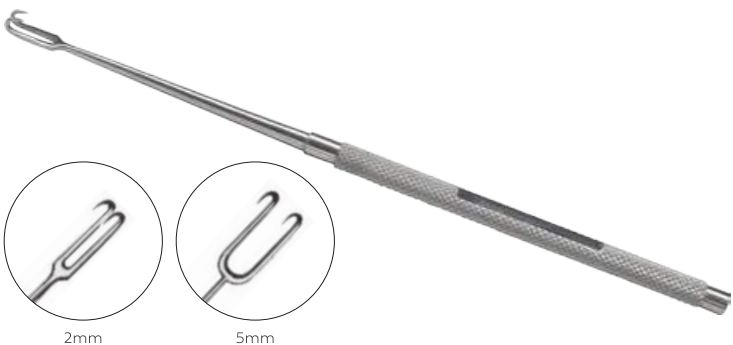



Hooks

KILNER

Kilner Skin Hook is primarily used during general surgeries when delicate tissue needs to be retracted.

SHARP - 2.5MM HOOK

16cm

A3357



TRACHEAL

Tracheal Hook is used in ENT surgery, usually to retract the trachea during a tracheotomy.

BLUNT - 1 PRONG

16cm

A3364



Retractors

WEITLANER

Weitlaner Retractor is used for holding back tissue and exposing a surgical site. It has curved shanks that can be held open with a sprung ratchet mechanism.

SHARP - 2 X 3 TEETH	
10.5cm	A4159
SHARP - 3 X 4 TEETH	
14cm	A4157
BLUNT - 2 X 3 TEETH	
10.5cm	A4158
BLUNT - 3 X 4 TEETH	
14cm	A4156

GELPI

Gelpi Retractor is a ratcheted retractor used to hold back tissue during a surgical procedure. It has a single sharp prong on each tip that is turned outwards.

SHARP - 1 X 1 TEETH	
11cm	A3353

PARSONNET EPICARDIAL

Parsonnet Epicardial Retractor is a small, sprung retractor used in coronary bypass surgery. It is available with 3X3 prongs and has thumb grips.

Mini	315 2506
Small	315 3206
Medium	315 3807
Large	315 5011



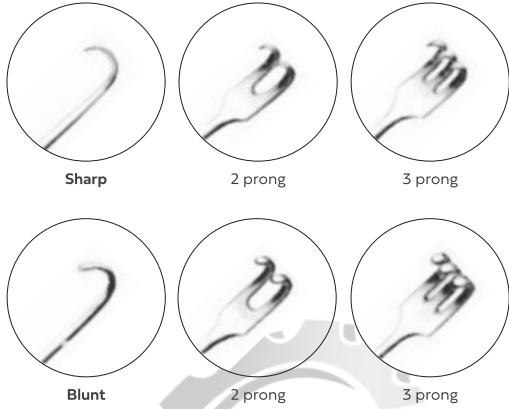

Retractors

DELICATE

Delicate Retractors are used to hold back tissue, skin and or muscle during surgery.

SHARP - 2 PRONG	
16cm	A3359
SHARP - 3 PRONG	
16cm	A3360
BLUNT - 2 PRONG	
16cm	A3361
BLUNT - 3 PRONG	
16cm	A3362

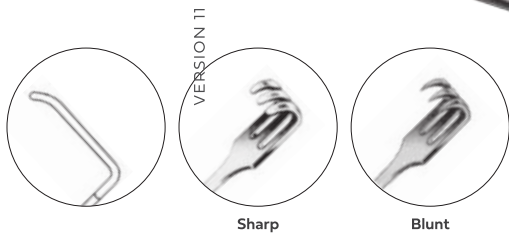

SENN MILLER

Senn Miller Retractor is a double-ended retractor used to retract surface tissue.

SHARP	
16cm	A3352
BLUNT	
16cm	A3355

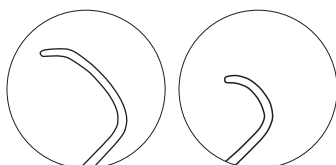
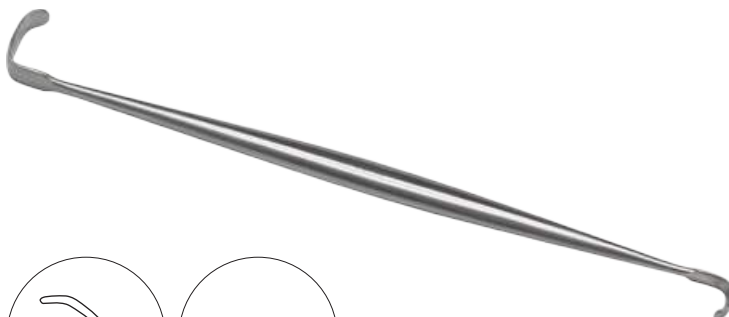

RAGNELL-DAVIS

Ragnell-Davis Retractor is a double-ended retractor used to retract delicate surface tissue.

15cm	A3354
------	--------------



Retractors

ROUX

Roux Retractor is a double-ended handheld retractor with curved ends on each side. Used to hold back tissue during surgery.

14cm	A3376
15cm	A3377
16cm	A3378

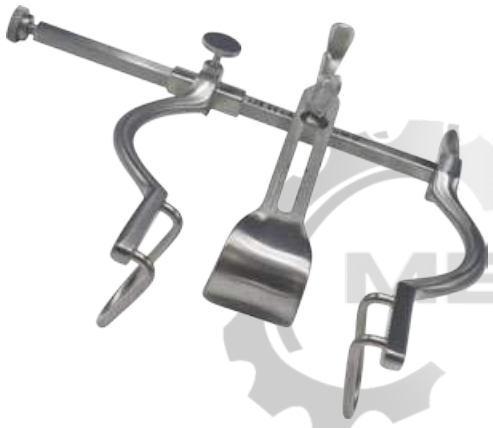

BALFOUR ABDOMINAL

The Balfour Retractor is used to hold open the abdominal walls during surgery. The Balfour is made up of the frame with an arm on each end and a blade in the middle that can slide from side to side and be locked into place. The surgical retractor can either be self retaining or locked into place.

SHARP - 1 X 1 TEETH	
18cm spread	K6.277.18



LANGENBECK

Langenbeck retractors are used to retract soft tissues and wound edges in order to visualize deeper structures during urological, plastic and general surgical procedures.

3x1.1cm	A3363
---------	--------------

Elevators



Freer, Double ended

SEPTUM

Freer Septum Elevators are used in nasal septum surgeries.

BLUNT/SHARP	
18cm	A3370

Podiatry Clippers

Metall-Code by
SNA Manufacturing & Exports Co.

VERSION 11



Files

Blacks Files, Angled	3
Blacks Files, Straight	3

Foot Dressers

Narrow Coarse	3
Standard Coarse	3

Nail Nippers

Compound Action with Lock	5
Double Leaf Spring	4
Double Leaf Spring with Lock	4
Double Leaf Spring with Lock	4
Single Leaf Spring	4
Turnbull, Spring Action with Lock	5

Cuticle Cutter

Cuticle Cutter	5
Nail Splitter	5



Files

BLACKS FILES, STRAIGHT

Blacks Files are narrow files used to treat ingrown nails by filing and clearing nail debris along the edge of the nail.

NARROW HEAD

Fine cut	A2800
Medium cut	A2801

BLACKS FILES, ANGLED

Blacks Files are narrow files used to treat ingrown nails by filing and clearing nail debris along the edge of the nail.

NARROW HEAD

Fine cut	A2802
Medium cut	A2803



Foot Dressers

STANDARD COARSE

The Foot Dresser is used to help reduce and smoothen hard dry skin on the heels and ball of foot.

20mm WIDE

15cm	A2830
20cm	A2835
22cm	A2804

NARROW COARSE

The Foot Dresser is used to help reduce and smoothen hard dry skin on the heels and ball of foot.

8mm WIDE

15cm	A2832
21cm	A2805

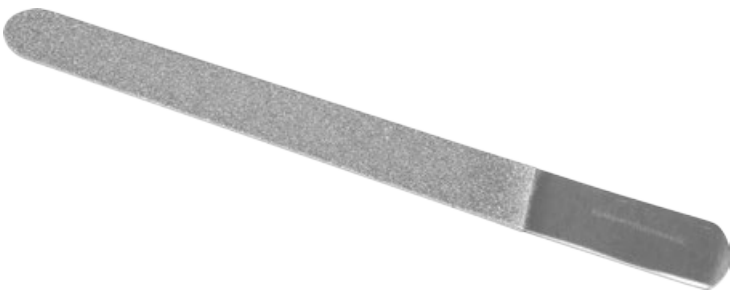



Nail Nippers

SINGLE LEAF SPRING

Manicure fingernail nipper used to cut and trim finger nails. Sharp Tips assist in cutting ingrown nails.

10.5cm	482
--------	-----

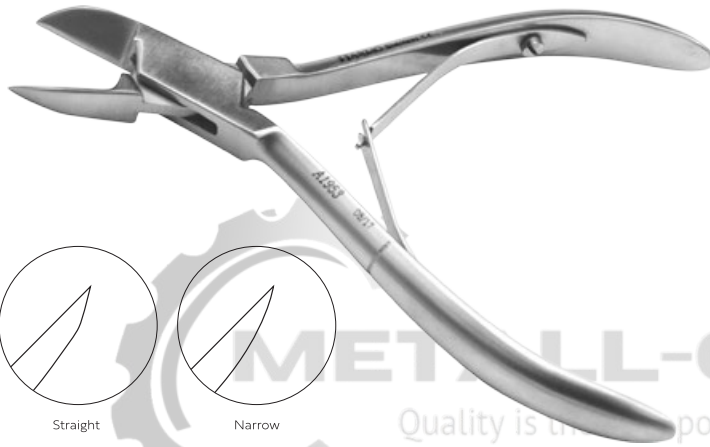

DOUBLE LEAF SPRING

Pedicure toenail nipper used to cut and trim toenails.

STRAIGHT	
13cm	A1953

NARROW	
16cm	A1954

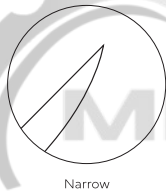
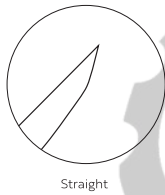

DOUBLE LEAF SPRING WITH LOCK

Pedicure toenail nipper used to cut and trim toenails. Locking mechanism assists with safe storage of instrument.

CURVED	
14cm	A1955

16cm	A1956
------	-------

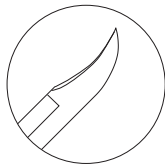

DOUBLE LEAF SPRING WITH LOCK

Pedicure toenail nipper used to cut and trim toenails. Locking mechanism assists with safe storage of instrument.

14cm	A1957
------	-------

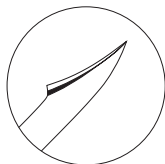



**TURNBULL,
SPRING ACTION WITH LOCK**

Compound spring action Pedicure toenail nipper used to cut and trim toenails. Locking mechanism assists with safe storage of instrument. Locking mechanism assists with safe storage of instrument.

13cm	A1958
Spare spring	A1951

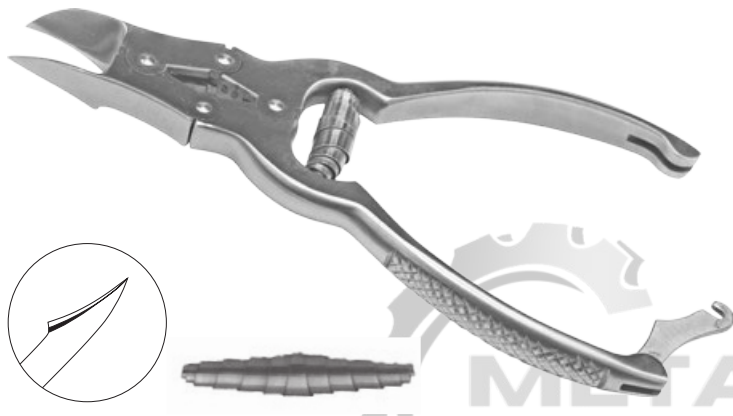

COMPOUND ACTION WITH LOCK

Compound spring action Pedicure toenail nipper used to cut and trim toenails. Locking mechanism assists with safe storage of instrument.

16cm	A1950
Spare spring	A1951

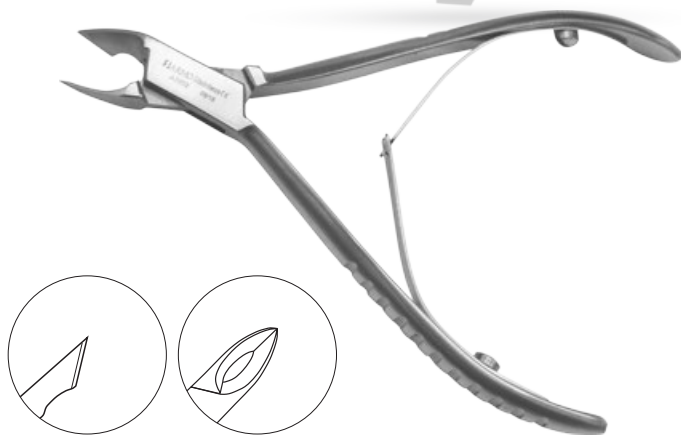

Cuticle Cutter

CUTICLE CUTTER

Cuticle Cutter is used to push back and trim the cuticles and dead skin around the nails.

10.5cm	A1952
--------	--------------



NAIL SPLITTER

Ingrown Nail Splitting Scissors are used in procedures for the treatment of ingrown nails. These scissors have one pointed, sharp tip and one rounded, blunt tip.

15cm	1.422.15
------	-----------------



Suction & Irrigation

Metal-Code by
SNA Manufacturing & Exports
Co.

VERSION 11



Catheter

Metal Catheter 3

Dental Syringes

Intra Ligamental Stainless Steel 5

Self Aspirating Black Handle 5

Standard Folding 5

Ear Syringes

Spare parts 4

Syringe, two nozzles & shield 100ml 4

Syringe, two nozzles & shield 150ml 4

Suction Tips

Frazier 3

Poole 3

Yankauer 3

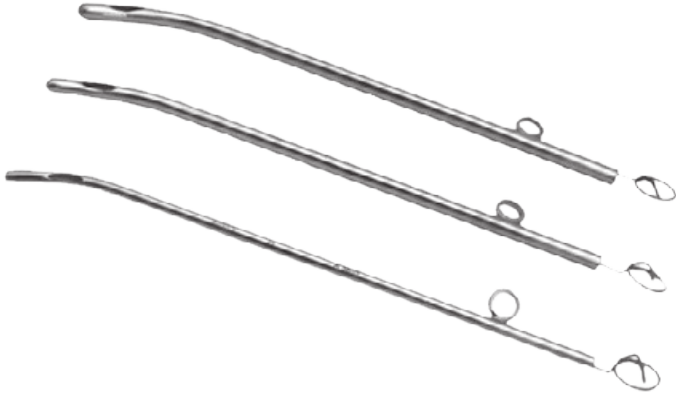

Catheter

METAL CATHETER

Metal Catheters are used to drain urine from the bladder.

14 French Gauge	A3857
12 French Gauge	A3856
10 French Gauge	A3855

Suction Tips



POOLE

Poole Suction Tips are used to remove large quantities of fluid from surgical sites during a procedure. The suction tube has multiple holes to prevent blockages caused by fat or tissue suctioned during a procedure.

ø 10mm	A4999
--------	-------



YANKAUER

Yankauer Suction Tips are used to remove large quantities of fluid from surgical sites during a procedure. The suction tube has a single hole at the end of the tube.

Paediatric	A4990
Adult	A4991



FRAZIER

Frazier Suction Tubes are used for removing fluid and debris from confined surgical sites. Suction is controlled by a small hole on the handle.

size 6	A5003
size 8	A5000
size 10	A5001
size 12	A5002



Ear Syringes

SYRINGE, TWO NOZZLES & SHIELD

Ear Syringes are used to irrigate the ear to assist in the process of ear wax removal. They are supplied with two nozzles and a shield.

100ml A2010



SYRINGE, TWO NOZZLES & SHIELD

Ear Syringes are used to irrigate the ear to assist in the process of ear wax removal. They are supplied with two nozzles and a shield.

150ml A2011

VERSION 11



Nozzle Set



Shield



O ring for nozzle

SPARE PARTS

Nozzle Set	A2013
Shield	A2014
O ring for nozzle	A2015
O ring for plunger	A2012



Dental Syringes



STANDARD FOLDING

A dental syringe is used for the injection of an anaesthetic, specifically in dentistry. It is a breech loaded syringe that accommodates a sealed cartridge containing the anaesthetic.

1.8ml	A2021
2.2ml	A2022



SELF ASPIRATING BLACK HANDLE

A dental syringe is used for the injection of an anaesthetic, specifically in dentistry. It is a breech loaded syringe that accommodates a sealed cartridge containing the anaesthetic.

1.8ml	A2023
2.2ml	A2024



INTRA LIGAMENTAL STAINLESS STEEL

A dental syringe is used for the injection of an anaesthetic, specifically in dentistry. It is a breech loaded syringe that accommodates a sealed cartridge containing the anaesthetic.

1.8ml	A2025
2.2ml	A2026



Biopsy Instruments

Mettall-Code by
SNA Manufacturing & Exports Co.

VERSION 11

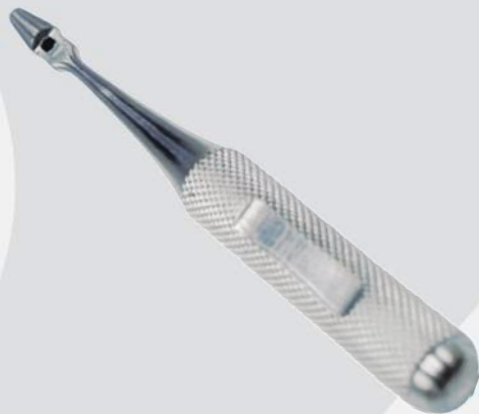

Biopsy Forceps

Tischler 3
Yoemann 3

Biopsy Punches

Keyes 3

Biopsy Punches, Single Use

Accuderm Punches 4

Biopsy Forceps



TISCHLER

Tischler Biopsy Forceps are obstetric/gynaecological instruments most commonly used to obtain tissue samples.

STANDARD (7 X 3mm JAW)	
25cm shaft	A6030
BABY (4.2 X 2.3mm JAW)	
21cm shaft	A6031

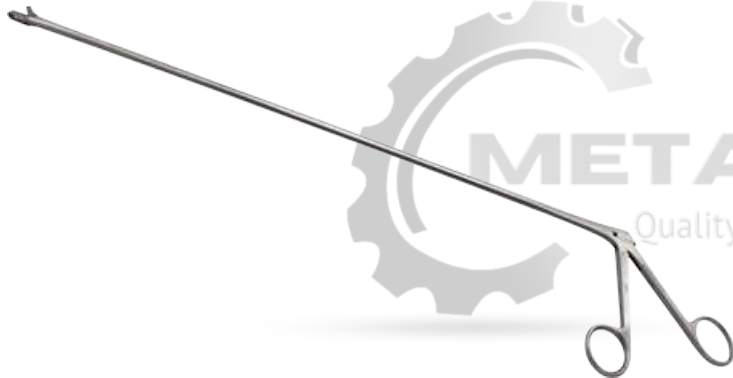

YOEMANN

Yoemann Biopsy Forceps are pistol grip forceps used for obtaining rectal biopsies.

35cm	A6032
42cm	A6033

Biopsy Punches



KEYES

Keyes Biopsy Punch is a dermal diagnostic instrument used to remove skin samples for biopsy.

2mm Ø	
10.5cm	A6034

○
2mm
Diametre

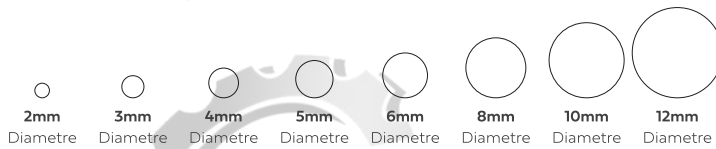

Biopsy Punches, Single Use

STERILE ACCUDERM PUNCHES

Acu-Punch® is made in the U.S.A. — and the ONLY punch available in a complete range of sizes, from 2mm to 12mm. Acu-Punch® is always razor sharp and ready to use. The handle is ribbed for maximum control, even when wearing gloves. Each punch comes individually wrapped in an easy peel pouch. 50 punches per box.

50 PUNCHES PER BOX

2mm	P250
3mm	P350
4mm	P450
5mm	P550
6mm	P650
8mm	P850
10mm	P1050
12mm	P1250





Ring Cutters

Metall-Code by
SNA Manufacturing & Exports
Co.

VERSION 11



Standard
Walton

3
3



Standard



Spare blade

RING CUTTER

Ring Cutters are plier gripped instruments used for cutting rings which have become difficult to remove. The blade is made from a hardened alloy and is completely enclosed and can quickly and safely remove rings from fingers. For use on soft metals only.

16cm	A5550
30mm Spare blade	A5560



Walton



Spare blade

WALTON RING CUTTER

Walton Ring Cutters are single gripped instruments used for cutting rings which have become difficult to remove. The blade is made from a hardened alloy and is completely enclosed and can quickly and safely remove rings from fingers. The safety lever slides protective a plate between finger and ring. For use on soft metals only.

16cm	A5555
20mm Spare blade	A5556

Dilators

Metal-Code by
SNA Manufacturing & Exports Co.

VERSION 11



Trousseau	
Trousseau	3
Hegar	
Double Ended	3
Single Ended	3
Hawkin-Ambler	
Single Ended	4



Trousseau



TROUSSEAU

Trousseau Dilator is a single spring instrument used to widen a tracheal incision to assist in tube insertion and placement.

14cm	A1023
------	--------------

Hegar



SINGLE ENDED

Hegar dilators are used to induce cervical dilation to gain entry to the uterus.

3mm	A1883
4mm	A1884
5mm	A1885
6mm	A1886
7mm	A1887
8mm	A1888
9mm	A1889
10mm	A1890
11mm	A1891
12mm	A1892
13mm	A1893
14mm	A1894
Set of 12	A1882

DOUBLE ENDED

Hegar dilators are used to induce cervical dilation to gain entry to the uterus.

1-2mm	A1901
3-4mm	A1903
5-6mm	A1905
7-8mm	A1907
9-10mm	A1909
11-12mm	A1911
13-14mm	A1913
15-16mm	A1915
17-18mm	A1917
19-20mm	A1919
21-22mm	A1921
23-24mm	A1923
25-26mm	A1925

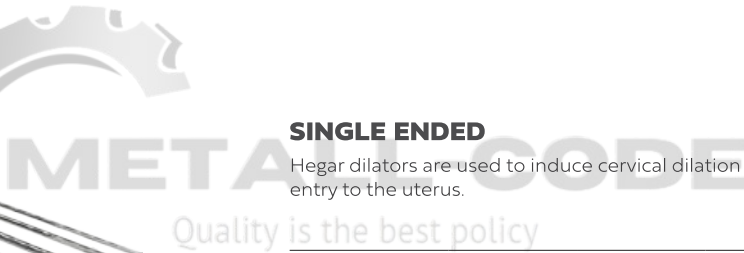



Hawkin-Ambler

SINGLE ENDED

Hawkin-Ambler Dilators are single-ended uterine dilators with a rounded end and are used to facilitate entry into the uterus and to prevent uterine wall puncture.

3-6mm	A1005
4-7mm	A1006
5-8mm	A1007
6-9mm	A1008
7-10mm	A1009
8-11mm	A1010
9-12mm	A1011
10-13mm	A1012
11-14mm	A1013
12-15mm	A1014
13-16mm	A1015
14-17mm	A1016
15-18mm	A1017
16-19mm	A1018
17-20mm	A1019
18-21mm	A1020



Towel Clips

Mettall-Code by
SNA Manufacturing & Exports
Co.

VERSION 11



Backhaus	3
Cross Action	3
Lorna	3



BACKHAUS

The Backhaus Towel Clip is a ratcheted instrument used to secure draping and towels which are used while a medical procedure is being conducted. It has curved tips which are designed to perforate the item they grip.

9cm	A5150
11cm	A5154
14cm	A5152



CROSS ACTION

The Cross-Action Towel Clip is a sprung instrument used to secure draping and towels which are used while a medical procedure is being conducted. It has curved tips which are designed to perforate the item they grip.

8cm	5161
-----	------



LORNA

The Lorna Towel Clip is a ratcheted instrument used to secure draping and towels which are used while a medical procedure is being conducted. It has curved tips which are blunt.

14cm	A5170
------	-------



Probes

Metall-Code by
SNA Manufacturing & Exports Co.

Applicators

Cotton (Standard)	6
Farrell Cotton	6
Jobson-Horne	6
Uckerman	6

Eye Probes

Eye Magnet & Foreign Body Loop	5
Eye Probes	4
Foreign Body Needle & Gouge	5
Foreign Body Needle & Spud	4
Foreign Body Spud & Gouge	5

Extractors

Schamberg	3
Unna with Teardrop ends	3
Unna with round ends	3

Lachrymal Probe

Lachrymal Probe	5
-----------------	---

Probes, Seekers & Directors

Alloy Handle	4
Stainless Steel	3

Splinter Probes

Disposable, Double Ended	4
--------------------------	---



Extractors



SCHAMBERG

Schamberg extractor is a dermal instrument used to extract blackheads.

10cm A6027



UNNA WITH TEARDROP ENDS

Unna Extractor is a dermal instrument used to extract blackheads.

14cm A6024



UNNA WITH ROUND ENDS

Unna Extractor is a dermal instrument used to extract blackheads.

14cm A6025

Probes, Seekers & Directors

STAINLESS STEEL

Probes, seekers and Directors are long, slender instruments for exploring wounds or body cavities or passages.

BLUNT - 1mm Ø

20cm

BLUNT - 2mm Ø

14cm

A2366

20cm

SHARP - 2mm Ø

14cm

A2361

DISSECTING - WITH EYE

14cm

SHARP

14cm

BLUNT

14cm

BLUNT - ANGLED

14cm

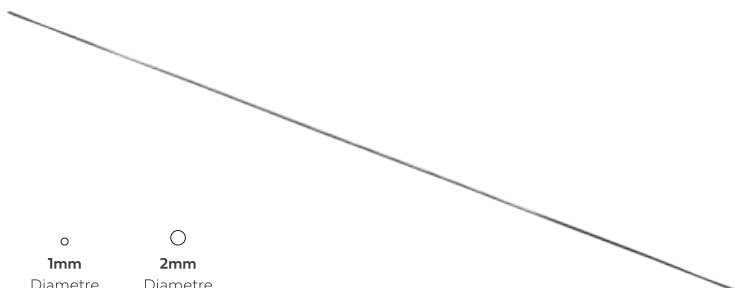

○ 1mm Diametre
○ 2mm Diametre



Probes, Seekers & Directors

ALLOY HANDLE

Probes, seekers and Directors are long, slender instruments for exploring wounds or body cavities or passages.

BLUNT	
14cm	237
BLUNT - ANGLED	
14cm	236
SHARP	
12cm	226



Splinter Probes

DISPOSABLE, DOUBLE ENDED

Splinter probes are used to push a splinter to the surface of the skin.

WITH CAPS	
11cm	519



Eye Probes

EYE PROBES

Eye probes are used to remove foreign bodies from the eye.

WITH CAPS	
11cm	520



FOREIGN BODY NEEDLE & SPUD

Foreign body needle and Spud are ophthalmic instruments commonly used to assist in the removal of foreign bodies in the eye.

	A6020
--	--------------



Eye Probes

FOREIGN BODY NEEDLE & GOUGE

Foreign body needle and Spud are ophthalmic instruments commonly used to assist in the removal of foreign bodies in the eye.

WITH CAPS

15cm

A6021

FOREIGN BODY SPUD & GOUGE

Foreign body needle and Spud are ophthalmic instruments commonly used to assist in the removal of foreign bodies in the eye.

WITH CAPS

13.5cm

A6022

EYE MAGNET & FOREIGN BODY LOOP

Eye Magnet & Foreign Body Loop is used for removing objects from the eye. The magnet is designed to remove fragments of metal lodged near the surface of the eye. At the opposite end of the instrument is a foreign body loop used to encircle the object for extraction.

REVERSIBLE SCREW HANDLE

11.5cm

A6023

Lachrymal Probe

LACHRYMAL PROBE

The Lachrymal Probe Bowman is a very thin malleable rod with a rounded end used for clearing a nasolacrimal duct, or in procedures within the nasolacrimal duct, or in procedures within the lacrimal system.

00/0

A1780

0/1

A1781

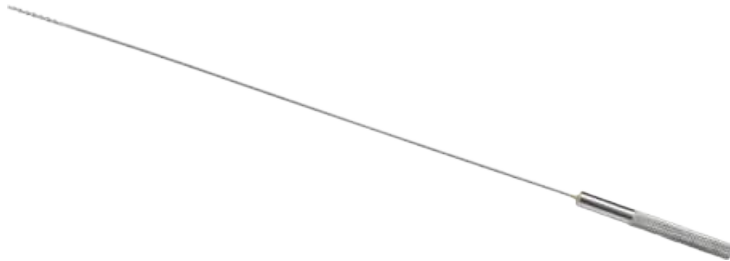

COTTON (STANDARD)

Cotton Standard Applicators have many uses in the medical environment. They can be used to clean the wound, as well skin surrounding it. They are also useful for gently swabbing a wound to obtain a sample for further testing that might be required to determine the presence of an infection. Cotton tipped applicators are useful in applying medicines or ointment to wounds as well.

20cm **A1024**



FARRELL COTTON

Farrell Cotton Applicator is commonly used in aural procedures.

14cm **A2380**



VERSION TI

METALL-CODE

Quality is the best policy

JOBSON-HORNE

Jobson-Horne Cotton Applicator is characterised by having a curette loop at one end and a flattened serrated tip at the other end. Commonly used in aural procedures.

12cm **A2381**

18cm **A2382**



UCKERMAN

Uckermann Cotton Applicator is characterised by having a curette loop at one end and a very fine spiral tip(<1mm) at the other end. Commonly used in aural procedures.

15cm **A2378**



Ronguers & Rasps

Metall-Code by
SNA Manufacturing & Exports Co.

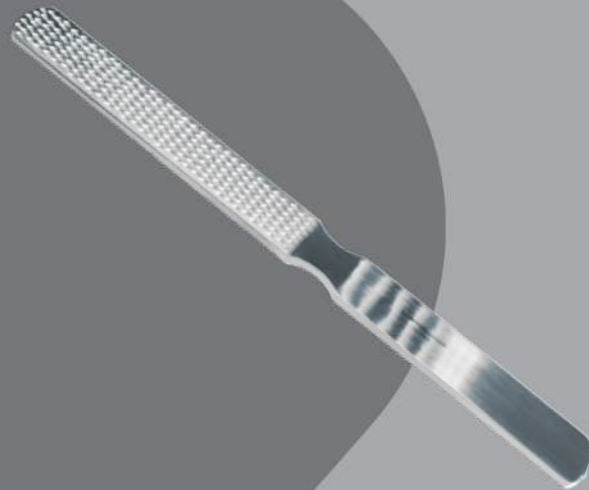

Liston Bone Cutting Forceps

- Compound Action 3
- Single Action 3

Rasps

- Four Sided Rasp, Double End 3
- Two Rasp, Single Ended 3

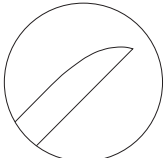
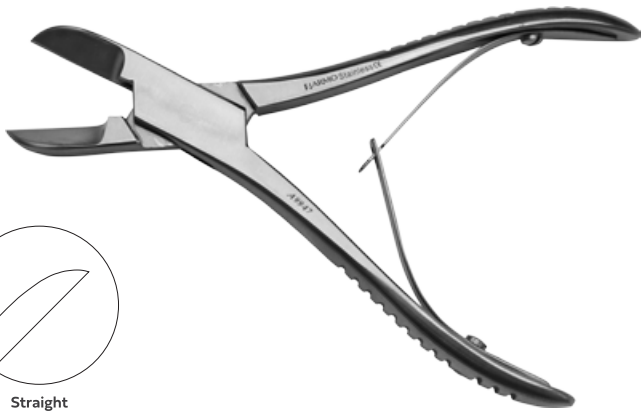

Straight

Liston Bone Cutting Forceps

SINGLE ACTION

Liston Bone Cutting Forceps are used for cutting bones. The jaws of the forceps have sharp blades and are rounded on the outer edge.

14cm	A9947
17cm	A9950



Angled

COMPOUND ACTION

Liston Bone Cutting Forceps are used for cutting bones. The jaws of the forceps have sharp blades and are rounded on the outer edge.

27cm	A9966
------	-------



RASPS

TWO RASP, SINGLE ENDED

Bone rasps are available in a variety of styles with fine or coarse working ends in upward or downward cutting patterns to help smooth and shape bone during orthopaedic procedures.

20mm WIDE	
22cm	A2804



FOUR SIDED RASP, DOUBLE END

Bone rasps are available in a variety of styles with fine or coarse working ends in upward or downward cutting patterns to help smooth and shape bone during orthopaedic procedures.

8mm WIDE	
21cm	A2805



Hollowware Stainless Steel

Metal-Code by
SNA Manufacturing & Exports Co.

Bowls

Bowls 4

Jars

Dressing Jar with Lid 4

Forceps Jar 4

Kidney Dishes

Kidney Dish 3

Measuring Jugs

Measuring Jugs 3

Trays

Catheter Tray with Lid 3

Instrument Tray with Lid 3



Kidney Dishes



KIDNEY DISH

15cm	A7408
20cm	A7409
25cm	A7410
30cm	A7411

Measuring Jugs



MEASURING JUGS

GRADUATED	
500ml	A7031
1000ml	A7032
2000ml	A7033

Trays



INSTRUMENT TRAY WITH LID

200 x 150 x 40mm	A7021
300 x 200 x 50mm	A7023



CATHETER TRAY WITH LID

300 x 80 x 40mm	A7022
400 x 100 x 40mm	A7024



Jars

DRESSING JAR WITH LID

100mm Ø	
100mm depth	A7003
150mm Ø	
150mm depth	A7004



FORCEPS JAR

50mm Ø	
125mm depth	A7001
200mm depth	A7002

VERSION 11

Bowls

BOWLS



60mm Ø	
30mm depth	A7011
80mm Ø	
40mm depth	A7012
100mm Ø	
50mm depth	A7013
120mm Ø	
60mm depth	A7014
140mm Ø	
60mm depth	A7015
180mm Ø	
85mm depth	A7016
320mm Ø	
85mm depth	A7017



Hollowware Polypropylene

Metall-Code by
SNA Manufacturing & Exports
Co.

Medicine Measures	
Graduated Measure	3
Lid	3
Kidney Dishes	
Heavy Duty	3
Standard	3
Instrument Trays	
Heavy Duty	4
Bowls	
Heavy Duty	4
Standard	4



Medicine Measures

GRADUATED MEASURE

These washable graduated measures are clear in colour and come in 2 sizes with capacities of 30ml and 60ml.

	Code
CLEAR, PACK OF 100	
2.5ml - 30ml	PMM30
CLEAR, PACK OF 25	
5ml - 60ml	PMM60

LID

The Lids are available to fit both the 30ml and 60ml measure and sold in a pack of 100.

	Code
CLEAR, PACK OF 100	
To suit 2.5ml-30ml & 5ml-60ml	PMM30L

Quality is the best policy

Kidney Dishes



HEAVY DUTY

Available in 700 & 1000ml.

	Code
GREEN	
700ml	DK700GU
1000ml	DK1000GU

STANDARD

Available in 700ml dishes and packs of 25.

	Code
GREEN	
700ml	DK700GS



Instrument Trays

HEAVY DUTY

These instrument trays are heavy duty for repeated use. They are made in Australia and are available in both solid and perforated.

		CODE
GREEN SOLID		
220 x 140 x 20mm		CBF2214-2
245 x 195 x 40mm		CBF2419-4
GREEN PERFORATED		
180 x 150 x 30mm		CBF1815-3
270 x 150 x 30mm		CBF2715-3



METALL-CODE

Quality is the best policy

Bowls



HEAVY DUTY

These autoclavable bowls are designed for repeated use, have permanent graduated markings and are Australian made. They range in size from 150ml to 1500ml.

		CODE
GREEN		
150ml	(100 x 50mm)	PB100GU
500ml	(140 x 70mm)	PB140GU
1000ml	(185 x 90mm)	PB185GU
2500ml	(240 x 110mm)	PB240GU



STANDARD

These washable bowls are for single patient use, they have permanent graduated measurement markings and are Australian made. They range in size from 250ml to 2000ml. There is also a denture cup available in this range and they are all available in packs of 25.

		CODE
GREEN, PACK OF 25		
250ml	(95 x 50mm)	PB250G
500ml	(115 x 60mm)	PB500G
1000ml	(145 x 80mm)	PB1000G
2000ml	(195 x 90mm)	PB2000G

Tuning Forks, Reflex Hammers, Penlights, Tapes and Miscellaneous

Metall-Code by
SNA Manufacturing & Exports Co.



Diagnostic Penlights	
Deluxe Penlight	3
Economy Penlight	3
Measuring Tapes	3
Pin Wheel	
Wartenburg Pin Wheel	4
Reflex Hammers	
Buck (with needle & brush)	4
National/London Hospital	4
Taylor	4
Tuning Forks	
Armo Alloy	5
Armo Alloy Boxed SET	5
Hartmann Stainless	5
Lucae	6
Rydel-Seiffer	5



Diagnostic Penlights



DELUXE PENLIGHT

- High intensity light beam
- Modern look chrome finish
- Pocket clip on/off press switch
- Pupil gauge and slide rule
- Includes 2 x AAA batteries

Chrome finish

SGPL-900-212



ECONOMY PENLIGHT

- High intensity light beam
- Stylish white finish with pupil gauge
- Pocket clip on/off press switch
- Includes 2 x AAA batteries

Plastic

SGPL-900-213

Quality is the best policy

Measuring Tapes



MEASURING TAPE

- Stylish white compact housing
- Push button tape rewind
- Measurement in inches and centimetres (60"/150cm)

Plastic

SGTM-900-300



Tuning Forks, Reflex Hammers,
Penlights, Tapes and Miscellaneous

03

Metal-Code by SNA
Manufacturing & Exports Co.



Pin Wheel

WARTENBURG PIN WHEEL

The Wartenburg Pin Wheel is a neurological testing instrument used for testing nerve response when pressure is applied to the skin.

18cm

A2009



Reflex Hammers

NATIONAL/LONDON HOSPITAL

38cm

232



BUCK (WITH NEEDLE & BRUSH)

18cm

244



TAYLOR

20cm

243



Tuning Forks



ARMO ALLOY

STANDARD WITH WEIGHTS

Standard 128Hz	A1538
Standard 256Hz	A1539

STANDARD

Standard 128Hz	A1538
Standard 256Hz	A1539
Standard 2048Hz	A1542



METALL-CODE

Quality is the best policy

ARMO ALLOY BOXED SET

Set of 5	A1537
----------	-------



HARTMANN STAINLESS

STANDARD

Standard 128Hz	A1530
Standard 128Hz (A)	A1531

STANDARD

Standard 512Hz	A1532
Standard 1024Hz	A1533



RYDEL-SEIFFER

64 - 128Hz	A1543
------------	-------



Tuning Forks

LUCAE

STANDARD WITH FOOT

Standard 128Hz	A1550
Standard 256Hz	A1551
Standard 512Hz	A1552
Standard 1024Hz	A1553
Standard 2048Hz	A1554





Personal Care Instruments

Metal-Code by
SNA Manufacturing & Exports
Co.

Cuticle Clipper	3
Cuticle Cutter / Trimmer	4
Cuticle Pusher	4
Foot Dresser / Pedi Paddle	4
Manicure Pack	5
Nail Nippers	3
Pedicure Pack	5
Tweezers	3

SINGLE USE INSTRUMENTS



STERILE R



Single Items



TWEEZER BLACK FINISH

Matt Black slanted tweezer with perfectly aligned, hand-filed tips, that close evenly and firmly to remove hair from the root.

		Pack
10cm	BSU1002	10



NAIL NIPPER WITH NAIL FILE AND CLEANER

Stainless steel nail nipper 6cm used to trim nail length.

		Pack
6cm	BSU1004	10



NAIL NIPPER

Stainless steel nail nipper 8cm used to trim nail length.

		Pack
8cm	BSU1003	10



CUTICLE CLIPPERS

Stainless steel cuticle clippers feature a 6mm wide jaw to trim overgrown cuticles and hangnails.

		Pack
10.5cm	BSU1007	10



SINGLE USE INSTRUMENTS



STERILE R

Single Items

CUTICLE CUTTER / TRIMMER

Cuticle Trimmer removes dead cuticle or skin attached to the nail.

		Pack
11cm	BSU1001	10



VERSION 11

CUTICLE PUSHER

The stainless steel cuticle pusher pushes back cuticles & cleans under nails.

		Pack
13cm	BSU1005	10



FOOT DRESSER PEDI PADDLE

Pedi Paddle Foot smoother removes rough, hard skin and leaves the feet soft and smooth.

		Pack
23.5cm	BSU1006	10

SINGLE USE INSTRUMENTS



STERILE R



Packs



PEDICURE PACK

These items are supplied sterile and are intended for single patient use. The pedicure pack consists of:

- 1 x Cuticle Pusher 13cm
- 1 x Cuticle Clipper 10.5cm
- 1 x Foot dresser Pedi Paddle 23.5cm
- 1 x Nail Nipper 8cm

Each item is separately packed and can be opened without compromising the other items in the pack.

		Pack
Pedicure Pack	BSU2001	10



MANICURE PACK

These items are supplied sterile and are intended for single patient use. The Manicure pack consists of:

- 1 x Cuticle Pusher 13cm
- 1 x Cuticle Clipper 10.5cm
- 1 x Nail Nipper 6cm

Each item is separately packed and can be opened without compromising the other items in the pack.

		Pack
Manicure Pack	BSU2002	10



Vet Surgical Kits

Metal-Code by
SNA Manufacturing & Exports Co.



Canine Spey Kits	3
Feline Spey Kits	4
Ophthalmic kits	7
Soft Tissue Kits	6
Suturing Kits	5



Canine Spey Kits



CANINE SPEY KITS

Instrument Inclusions

Rochester Carmalt Artery Forcep Straight	16cm
Crile Artery Forceps Straight	14cm
Crile Artery Forceps Curved	14cm
Halstead-Mosquito Artery Forceps Curved	12.5cm
Adson Dressing Forcep Standard	12cm
Adson Brown Tissue Forcep	12cm
Allis Tissue Forceps 4x5 teeth	15cm
Spey Hook (Snook Ovaryectomy) shank	11cm
Mayo Scissors Straight	14.5cm
Metzenbaum Scissors Curved blunt/blunt	15.5cm
Scalpel Handle (standard grip)	no.4
Backhaus Towel Clips	9cm

Feline Spey Kits



FELINE SPEY KITS

Instrument Inclusions

Rochester Carmalt Artery Forcep Straight	16cm
Crile Artery Forceps Straight	14cm
Crile Artery Forceps Curved	14cm
Halstead-Mosquito Artery Forceps Curved	12.5cm
Adson Dressing Forcep Standard	12cm
Adson Brown Tissue Forcep	12cm
Allis Tissue Forceps 4x5 teeth	15cm
Spey Hook (Snook Ovaryectomy) shank	7cm
Mayo Scissors Straight	14.5cm
Metzenbaum Scissors Curved blunt/blunt	15.5cm
Scalpel Handle standard grip	no.4
Backhaus Towel Clips	9cm



Suturing Kits



Vet Surgical Kits

05



CANINE SPEY KITS

Instrument Inclusions

Crile Artery Forceps Curved	14cm
Adson Dressing Forcep Standard	12cm
Tissue Forcep 1x2 Teeth	14cm
Mayo Scissors Straight	14.5cm
Scalpel Handle standard grip	no. 4
Backhaus Towel Clips	9cm

Soft Tissue Kits

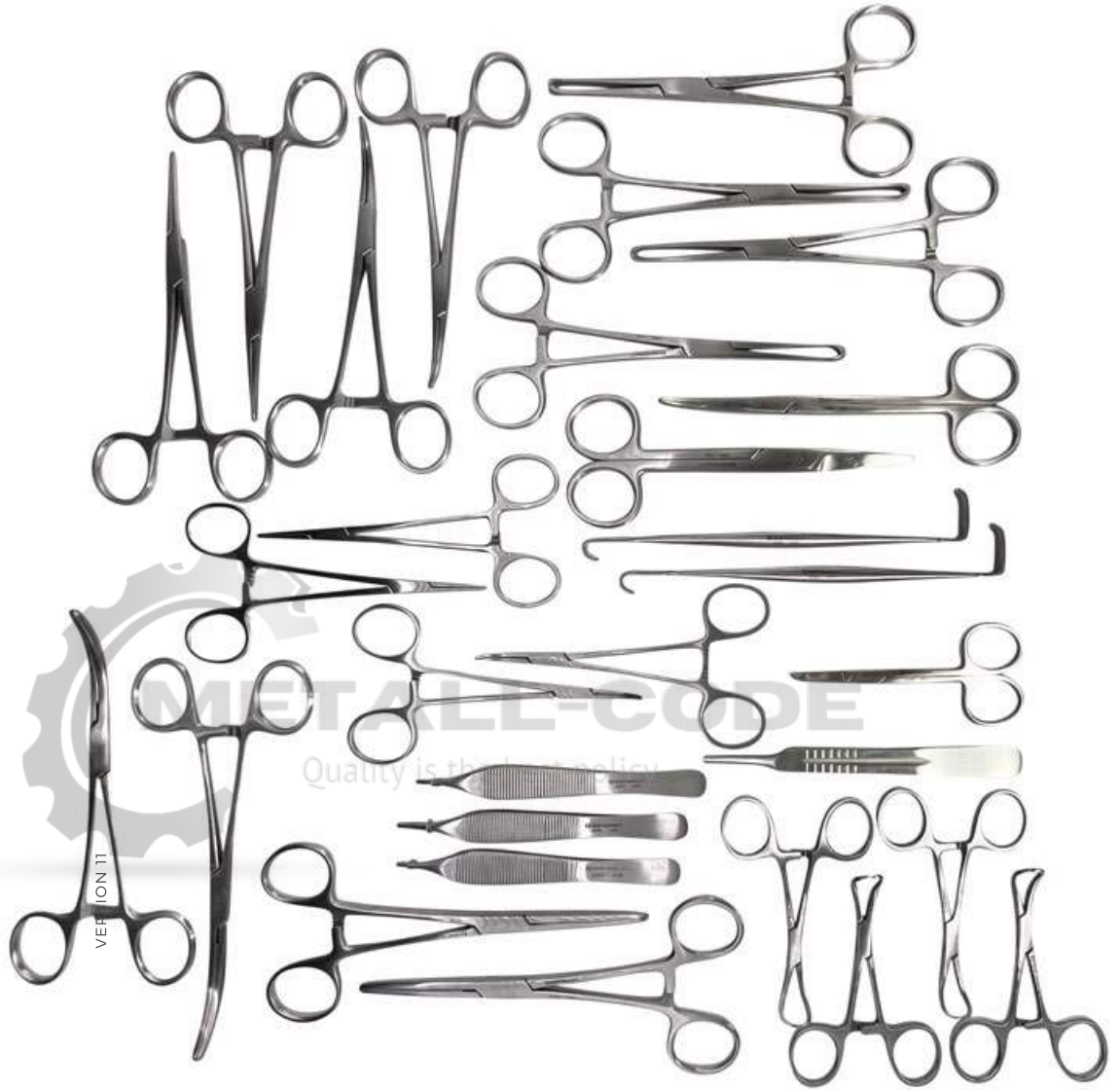

Instrument Inclusions

Rochester Carmalt Artery Forcep Straight	16cm
Rochester Carmalt Artery Forcep Curved	16cm
Crile Artery Forceps Straight	14cm
Crile Artery Forceps Curved	14cm
Halstead-Mosquito Artery Forceps Straight	12.5cm
Halstead-Mosquito Artery Forceps Curved	12.5cm
Adson Dressing Forcep Standard	12cm
Adson Brown Tissue Forcep	12cm
Adson Tissue Forcep 1x2 teeth Standard	12cm
Allis Tissue Forceps 4x5 teeth	15cm
Mayo Scissors Straight	14.5cm
Metzenbaum Scissors Curved blunt/blunt	15.5cm
Senn Miller Retractor 22x7mm blades Blunt	16cm
Spencer Scissors	9cm
Scalpel Handle standard grip	no. 4
Backhaus Towel Clips	9cm



Ophthalmic kits

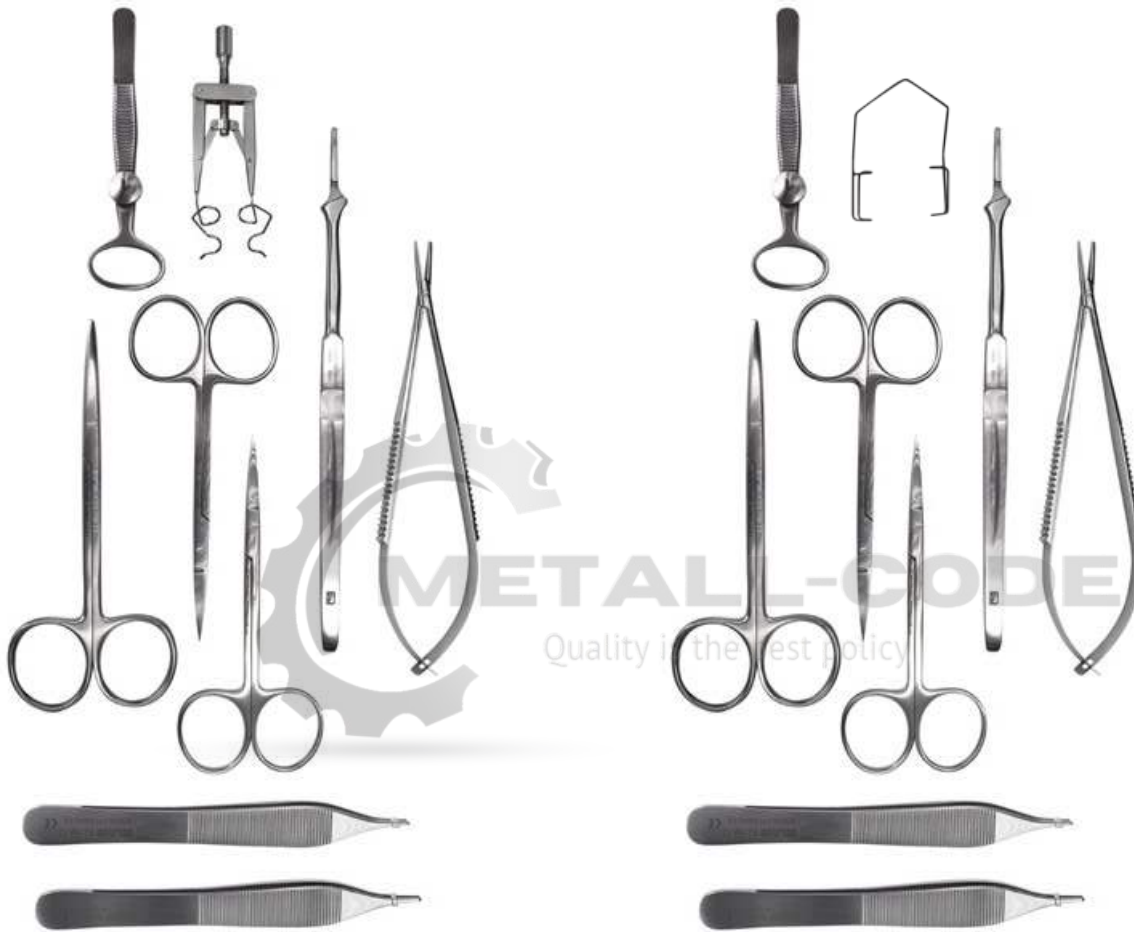

A9021-G1 V A9021-G2 V A9021-G3 V wire

A9021-G3

OPHTHALMIC KITS

Instrument Inclusions

Adson Dressing Forcep Standard	12cm
Adson Tissue Forceps 1x 2 teeth Micro	12cm
Desmarres Chalazion (No.2)	9cm
Iris Scissor Straight	11cm
Strabismus Scissor Straight	11cm
Castroviejo Ophthalmic Needle Holder (No Lock) Smooth Jaw	13cm
Scalpel Handle No.7 for Blades 10-15	No. 7
Barraquer Wire Adult Eye Specula	
Lieberman V Wire Eye Specula	

Contact US

Sialkot, Pakistan

- Office building number 29, Peoples colony, Sialkot, Pakistan
- Postal code [51310](#)
- +923228024444, +923000473565
- sales@metall-code.com

Saudia Arabia

- 3592 Flat, Um Al Hammam, Abdul Aziz Road, Riyadh
- +966534373563
- sales@metall-code.com

