

# THE UNBEATABLE

## UNIVERSAL LEGGUARD WORKS

Basti Sheikh Road, Jalandhar - 144002, Punjab (India)

Tel: +91-181-4608218, 4608208-09

Email: [domestic@universalsportsinds.com](mailto:domestic@universalsportsinds.com) Web: [www.universalsportsinds.com](http://www.universalsportsinds.com)

Like us on :   

Safety Warning: All Products must be used under expert supervision. Do not use in case of any injuries.

\*The specifications of our products are subject to change without prior notice because of our continuous efforts to improve the quality.

\*\* Some specific items in this catalogue may not be available in a country due to our prior business commitments.



MRP 999/-

usi  
UNIVERSAL

LOOK BOOK 2023-24

THE  UNBEATABLE

# LOOK BOOK 2023-24



## BOXING - FITNESS - MARTIAL ARTS



## EQUIPMENT - PERFORMANCE - LIFESTYLE

# Approvals - Partnerships - Esteemed Customers



# Our Global Network

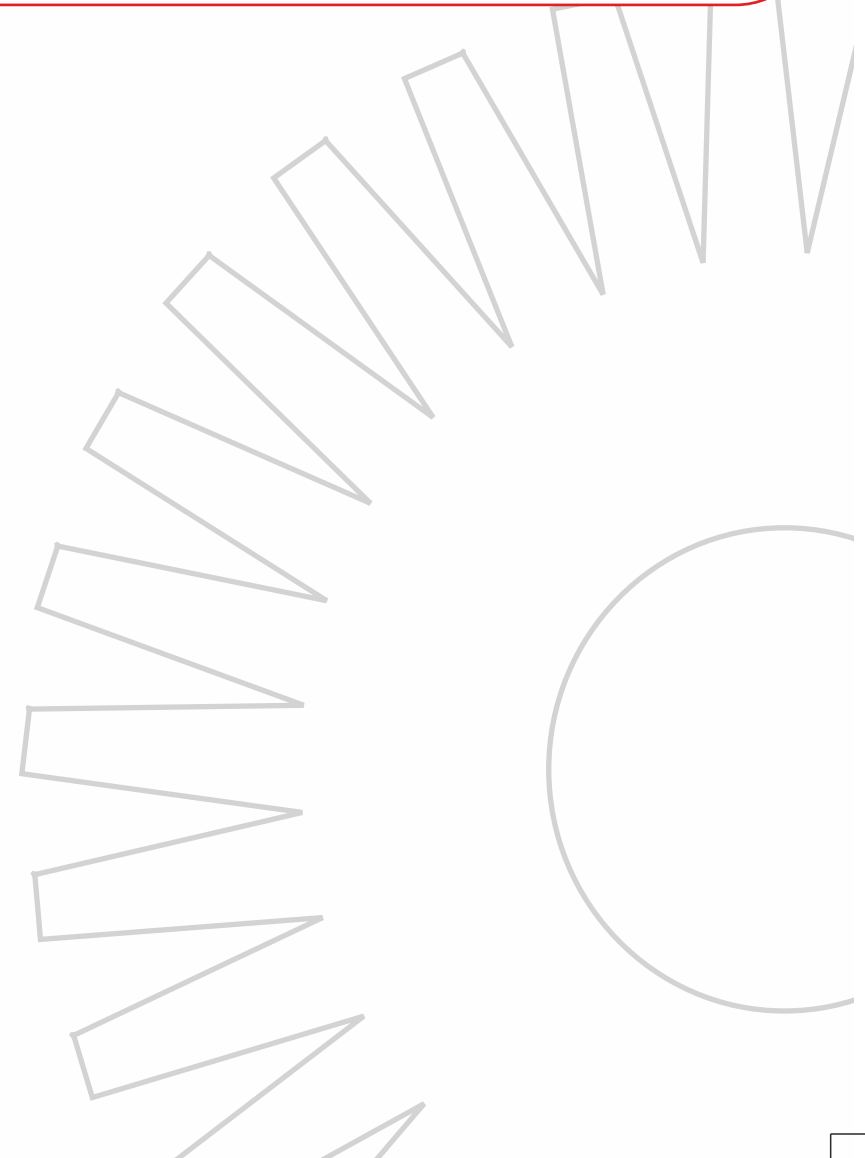

**Unit-1**

30,000 Sq. Ft.



**Showroom**

6,400 Sq. Ft.



**Unit-2**

70,000 Sq. Ft.



**Unit-3**

more than 120,000 Sq. Ft.





## MISSION

To provide sustainable solutions for better performance, matching your grit while keeping you safe. An endless pursuit of innovation.

## VISION

To equip you with more confidence. Holistic development of all. An SA 8000 audited company.

## BRAND

Fourth generation family run business supported by a great team of Craftsmen, Distributors & our valued Customers.

## PREAMBLE

OBSTACLES. LIMITS. FAILURES.

They make us uncertain of our abilities.

They underestimate our true potential.

They want a fatal defeat for us.

Only such resistance would compel the fire of desire to rise again in our soul like forgotten wings stimulated.

So WE TRAIN, WE SWEAT ,WE BLEED.

We never fear of getting shattered, we do fail sometimes.

Then we manage to drag our rug from under the tons of mass

and so we finally transcend to be

THE  UNBEATABLE®



**usi**  
UNIVERSAL

# PACKAGING

Innovative product packaging of USI Universal is specially designed by our talented and creative design team. Our packaging design techniques focus on the aim to educate the customer about the latest features and product technologies.



**usi**  
UNIVERSAL

**BOXING GLOVES**

AMATEUR CONTEST GLOVES

**BOUNCER**

6128V BOUNCER BOXING GLOVES

**FEELair**

Model's cheek absorbent from padding

**FEELair**

Hook & loop wrap around closure

**Technology Features**

**Selection Chart for Right Glove size**

**Other Recommended products**

**Product Category**

**Description**

**Level Meter**

**Product Showcase**

**Technology Features**

**Selection Chart for Right Glove size**

### Shell Materials:



**Ultimate shell material:**  
Leather is the strongest, most durable shell material.



**Economy shell:**  
The looks of leather & durable next to leather.



**Hybrid shell:**  
Scientific placement of materials after studying the stress zones. Enables us to give a superior product yet value for money.

**uFEELgrip**  
**uFEELgrip+**  
(Extra Grip)

**Superior hold:**  
A combination of textured surface & engineered materials secures the hold & strengthens the grip.

**uFEELflex**  
**uFEELflex+**  
(More flexible)

**Flexibility:**  
Mostly used for protective equipment. Thick technical textile fabrics infused with rubber yarn or rubber foam, promotes snug fit with flexibility. Also gives a degree of protection.

### Padding / Foams



**Moulded foam:**  
The most modern padding system. Anatomic shapes have been developed and continually improved. The best and most durable protection.

**uFEELgel**

**Scientific protection:**  
Gel has proven to be the best absorber of shock on impact. An ultimate protection and cushioning source for key parts of our body.



**Next generation protection:**  
Everything a fighter could dream of for protection. Fabric shell covered thermofoam. An ideal layer of lightweight yet strong durable protection.



**Optimal wrist protection:**  
Stable wrist improves comfort and reduces the risk of injury, even in those long strenuous training sessions.



**Extra layered impact protection technology:**  
It consists of different layers of foam combined to create a shock absorbing composite. Each layer has a specific purpose complimenting the other to provide maximum shock absorption.

**SALT**

**Super aircell layer technology:**  
This is a lightweight padding constructed with a combination of foams.



A soft compound which has some properties of rubber yet lightweight and resilient, textured surface for grip.



**A select padding structure:**  
This is our best engineered padding structure for the Elite Professionals. Handcrafted in detail combining different foams.



**XPE foam:**  
High density expandable foam. Highly durable and resilient even after rigorous use.



**Air foam:**  
Open cell foam, soft grade yet dense, gives a dampening effect on high drops

### Linings/Inserts:

**uFEELdri**

**Superior moisture management:**  
Wick dry fabric helps in a sweat free workout. Letting you focus on your performance.

**uFEELair**

**Ventilation system:**  
Our air mesh fabrics and perforations help in cool body temperature. Breathability is the key.

### Technical Features

**uFEELsafe**  
**uFEELsafe+**  
(Extra safe)

**Mental/physical safety:**  
Customer safety is paramount, this is achieved through a combination of superior design, engineered materials & latest production methods.

**uFEELstable**  
**uFEELstable+**  
(Extra support)

Products with this feature are anatomical shaped to give support while you perform various exercises & lifts.

**uFEELcontrol**  
**uFEELcontrol+**  
(Enhanced control)

**Safety + stability = control:**  
The combination of safety & stability features puts you in full control of your movements.

**uFEELwarm**  
**uFEELwarm+**  
(Sustained warmth)

**Optimal temperature:**  
The warmth is generated due to thickness or the brushing on the inner layer. Helps maintain ideal body temperature for optimal performance.

**uFEELtherapy**  
**uFEELtherapy+**  
(Superior result)

**Rehabilitation:**  
Products help with recovery from injury & post operation rehabilitation.

**uFEELsoft**  
**uFEELsoft+**  
(Extra soft)

**Super finish:**  
Softness leads to comfort. Specific density foams, speciality yarns & washes ensure softness in end product.

### Technical Apparel:



**Engineered textiles:**  
Special count yarns of polyester blended cotton have been developed to add strength to the fabric. It maintains fabric structure, finish & reduces shrinkage.



**Your second skin:**  
A technical layer which becomes a part of your body. Adds strength to your muscles while keeping you dry. The snug fit wrap promotes blood flow which decreases lactic acid. Enables reduction of muscle fatigue.



**A performance fabric:**  
It has the properties of a mesh without being see through at all. Soft wick dry finish.

**uFEELstretch**

**Elasticity:**  
Elastane yarn is used in the fabrics, predominant for performance/training apparel. Adds comfort & improves fit.

### Hardware



**Anti rust coating: Heat treated paint**  
Powder coated metal products baked at a set temperature for a long life & smooth finish. This paint is tough to stand against rusting for a long time.



**Ceramic coating:**  
A thin ceramic layer is formed on the metal surface which improves the life of the product. Ceramic coating also improves corrosion resistance & improves hardness.



**J Fit:**  
A 3 way hold system which secures the accessory in its place without any nuts & bolts. This design enables quick change & height adjustment.



**Engineered Product**

**Engineered product:**  
Complex hardware products made with specialized alloys using high precision manufacturing & finishing process. Built to perform at the highest level of your sport.

USI Universal's DNA embodies all aspect of our brand's mission, vision & preamble. Our Customers know that anything produced by USI Universal has embedded quality and functionality that they can trust to perform, complimenting their DNA in order to achieve the most difficult goals. We always remain open to new ideas & concepts to design products accordingly.

## PERFORMANCE D.N.A.

### Installation Features

#### UFEElease

**User friendly :**  
Products have been designed for easy installation & removal.



**Professional installation :**  
For products which require certain technical knowledge, experience, skills for installation. Installation charges might be inclusive in MRP or extra, depending on product & location of installation.



**Do it yourself - Installation :**  
USI Universal believes in making things simple for our customers. Many of our products which require assembly come with easy to understand installation manuals & videos.

### Quality Measures:



**X-Ray :**  
USI Universal has set standards in the combative sports products industry by introducing X-Ray scanning for our Punch bag lines. This is a stringent quality control measure for prevention of sharp objects.



**Eco friendly :**  
An environment friendly endeavour where we have used recycled materials as a strategic part of our products .

### Foam Hardness

USI Universal's hardness rating system is based upon a foam's resistance to pressure. Customers can choose depending on the intensity or comfort required. Different levels available for beginners to experts.



**Soft hardness :**  
The best possible value for your money.



**Medium soft hardness :**  
The best possible value for your money.



**Firm hardness :**  
The best possible value for your money.



**Hard hardness :**  
The best possible value for your money.

### Our Brands



(Registered trademarks of Universal Legguard Works)

**Safety Warning:** All Products must be used under expert supervision. Do not use in case of any injuries.

\*The specifications of our products are subject to change without prior notice because of our continuous efforts to improve the quality.

\*\* Some specific items in this catalogue may not be available in a country due to our prior business commitments.

### Proven Features



**Jig Saw fit :**  
Interlocking system which is very easy to install. It holds its place very well. No need of pasting to the floor.



**Grid stitching :**  
Sewing lines form a grid structure enabling the users to gauge the correct distance for placing feet and hands in correct posture.



**Limited edition :**  
This range would consist of products introduced on popular demand. Limited edition products will have special attributes like design concept, colours etc.



**Custom made :**  
If time is on your side, we will customise select products at an extra cost. From Martial Arts Belts, Pro Boxing Shorts, Gowns, Flooring, Cross train metal structure, Outdoor gyms, Boxing rings to MMA cages, wall structures , etc .



**Reversible :**  
USI Universal being a value for money brand, we have developed many products where customer gets the value of two products by spending for one.



**While stocks last :**  
End of line products where we have introduced better products in comparison.



**Super value :**  
The best possible value for your money.

### Customer Friendly Level Meters

Help you to understand & choose products depending on your requirement.



**Top grade :**  
Best for high level performance for Elite athletes & those who want an edge above others.



**Hybrid :**  
Innovative products with regards to materials & design.



**Superior :**  
Suitable for Root/Pivot Training.



**Standard :**  
Useful for Entry Level/Beginners.



Moisture Wicking



Breathable



Washable



Anti Chaffing



Flat Lock Stitching



Kids friendly



UNISEX



## BOXING (Gloves, headgear, focus pads etc.)

- 1 PROFESSIONAL BOXING
- 2 AMATEUR BOXING
- 3 VINTAGE SERIES
- 5 CONTRA SERIES
- 6 IMMORTAL SERIES
- 8 BOXUBER SERIES
- 9 RELIANCE/CRUSHER SERIES
- 10 BOUNCER SERIES

## TRAINING

- 11 HAND WRAPS/ACCESSORIES
- 12 COACHING/TRAINING
- 15 SPEED BALLS/ACCESSORIES
- 16 BOXING BAGS
- 21 HARDWARE
- 22 HANGING STANDS
- 23 FREE STANDING BAGS
- 26 BOXING RINGS
- 27 RING ACCESSORIES
- 29 BOXING APPAREL



## MMA / MUAY THAI

- 30 MMA GEAR
- 31 MMA CAGES
- 32 MMA STRUCTURES & ACCESSORIES
- 33 TRAINING DUMMIES
- 36 MUAY THAI GEAR
- 38 MUAY THAI APPAREL
- 46 BRAZILIAN JIU-JITSU

- 47 WRESTLING
- 49 WEIGHTLIFTING SINGLET

## MARTIAL ARTS

- 49 JUDO
- 50 KARATE
- 53 TAEKWONDO
- 56 WUSHU
- 57 WUSHU SANDA PLATFORM
- 58 MARTIAL ARTS PROTECTION
- 60 TRAINING
- 61 BELTS





## FITNESS

### SAFETY & SUPPORTS

- 62** FITNESS GLOVES
- 67** LIFTING GRIPS
- 68** LIFTING BELTS/ AIDS
- 72** KNEE/ELBOW SLEEVES
- 74** STRAPS/WRAPS

### STRENGTH

#### BODY WEIGHT

- 76** HAND GRIPS
- 77** PUSH UP SYSTEMS
- 78** PULL UP SYSTEMS
- 79** DOOR GYMS
- 79** WEIGHT JACKETS
- 80** HEAD HARNESS
- 80** WRIST & ANKLE WEIGHTS

#### FREE WEIGHTS

- 81** KETTLEBELLS
- 83** DUMBBELLS
- 86** FIXED WEIGHT BARS
- 87** OLYMPIC PLATES
- 88** FRACTION PLATES
- 89** BUMPER PLATES
- 91** BARBELLS

#### ACCESSORIES

- 101** BARBELL LOCKS
- 102** BARBELL PADS
- 103** WEIGHT LIFTING CHAINS
- 104** LAND MINE TRAINERS
- 105** ARM BLASTERS
- 106** CABLE ATTACHMENTS

#### EQUIPMENT

- 114** DEAD LIFT PLATFORM
- 115** GLUTE HAM DEVELOPER
- 115** ARM WRESTLING TABLE

#### STRUCTURES

- 116** SQUAT STANDS
- 118** POWER RACKS
- 120** RIGS
- 127** RIG ACCESSORIES

#### STORAGE

- 131** RACKS/STANDS

## FUNCTIONAL

- 138** GRAVITY TRAINER
- 139** GYMNASTIC RINGS
- 140** BAR RESISTANCE TRAINER
- 140** PEG BOARD
- 141** MEDICINE / SLAM / WALL BALLS
- 144** STRENGTH BAGS
- 145** BANANA BAGS
- 146** TYRES
- 147** HAMMERS



## ATHLETIC CONDITIONING

- 148** PLYO BOXES
- 152** SLEDS
- 154** BATTING ROPES
- 155** CLIMBING ROPES
- 156** SKIP/JUMP ROPES

## ENDURANCE

- 159** AIR BIKE
- 160** AIR ROWER

## STUDIO

- 161** STEPPERS
- 163** CARDIO PUMP REP SET
- 164** BODY TRAINING BARS
- 165** RUBBER WEIGHT LOGS

## YOGA

- 166** MATS & ACCESSORIES

## CORE & STABILITY

- 167** AB STRAPS
- 167** AB WHEELS
- 168** EXERCISE SLIDERS
- 168** DOOR SIT UP SUPPORT
- 169** AB PAD
- 169** BALANCE PRODUCTS
- 170** GYM BALLS
- 171** BALANCE STEP BALL



## MOBILITY & RECOVERY

- 172** RESISTANCE TUBES/EXPANDERS
- 173** CHEST EXPANDERS
- 174** LATEX LOOPS / BANDS
- 176** MASSAGE STICKS
- 177** MASSAGE ROLLERS/ BALLS

## FLOORINGS

- 178** MULTIPURPOSE
- 180** WEIGHT ROOM
- 182** COMBAT / GYM MAT
- 183** CRASH MATS
- 183** FOLDABLE MATS

## MISCELLANEOUS

- 184** TRAVEL BAGS
- 186** SAUNA SUITS
- 187** APPAREL
- 190** MENS PHYSIQUE BOARD SHORTS
- 193** KIDS
- 197** SOUVENIRS
- 198** SOFT BALLS / BASE BALLS
- 199** CRICKET ACCESSORIES

## SIZE CHARTS

- 203** ALL PRODUCTS

# PROFESSIONAL BOXING

Made the Mexican way, adorned by some of the best professional boxers in the world. Efforts have been put in great detail with regards to the padding, shape and overall fit. Keeping in mind the protection of a boxer's hand.



## 609A PRO CONTEST GLOVES

**TECH-SPEC.**  

- Top grain hide leather
- High density hand crafted foam padding
- Soft satin lining to give a plush feel
- Traditional lace up style

Code	Size	Fit	Color	MRP
609A	8 oz 10 oz	Regular Large	Red, Black	3599/-

\* per pair



# AMATEUR BOXING

Used by most Olympic aspiring amateurs, made precisely as per AIBA guidelines, latest technology has been used in these products with regards to protective foams, shell materials, closure & fastening systems.



### 609M AMATEUR CONTEST GLOVES

These gloves offer maximum protection to the aggressive amateur boxers who can fight fearlessly. Ergonomically shaped to lock your hands in a fist position.

- TECH-SPEC.**
- Top grain hide leather
  - Moulded shock absorbent foam padding
  - Sweat wicking lining
  - Hook & loop wrap around closure system
  - Approved by Indian Boxing Federation

Code	Size	Color	MRP
609M	10 oz	Red,Blue	3099/-
	12 oz		3299/-

\* per pair



### 609MPU LITE CONTEST GLOVES

A budget model made of durable synthetic material, only suggested for beginners and light use .

- TECH-SPEC.**
- Durable PU material
  - Moulded foam padding
  - Sweat wicking lining
  - Elasticated hook & loop wrap around closure system
  - Ventilated upper palm

Code	Size	Color	MRP
609MPU	10,12 oz	Red,Blue	1799/-

\* per pair



### 615CG AMATEUR CONTEST HEADGUARD

This is a lightweight headguard protecting all the vulnerable portions of a boxer's head ,it does not constrict your vision. It becomes a part of your body making you feel that you are not wearing anything on your head.

- TECH-SPEC.**
- Durable hide leather
  - Multiple layers of padding for greater shock absorbing
  - Adjustable web closure at top
  - Adjustable strap at back for firm grip
  - Cushioned back
  - Approved by Indian Boxing Federation

Code	Size	Color	MRP
615CG	S,M,L	Red,Blue	2849/-

\* per pc



### 615DP LITE CONTEST HEAD GUARD

A budget model made of durable synthetic material, only suggested for beginners and light use

- TECH-SPEC.**
- Durable PU construction
  - Lightweight handcrafted padding
  - Synthetic suede lining
  - Laced top closure

Code	Size	Color	MRP
615DP	S,M,L	Red,Blue	1599/-

\* per pc



# VINTAGE SERIES



Crafted with full grain leather using vintage colors yet complete with our latest technical innovations. Each product of this exclusive collection offers superb durability and unmatched functionality. An unrivaled fusion of old world charm and new age scientific product development with regards to fit and protection.



### 617SP HEAVY BAG GLOVES

**TECH-SPEC.**

- Top grain hide leather
- Hand crafted high density padding
- Wrap around wrist closure
- Soft wick dry lining
- Perforated palm for ventilation
- Embossed & embroidered logos

Code	Size	MRP
617SP	S/M, L/XL	2949/-

\* per pair

### 609VM SPARRING GLOVES

**TECH-SPEC.**

- Top grain hide leather
- Moulded single piece foam padding
- Wrap around wrist closure
- Soft wick dry lining
- Perforated palm for ventilation
- Embossed & embroidered logos

Code	Size	MRP
609VM	12,16 oz	3849/-

\* per pair



### 562V HOLDALL BAGS

A bag with a plenty of character. Make your style statement with this bag. Cushioned handles & metal zip on top add to the old world charm. Ideal for travel/gym/club use.

**TECH-SPEC.**

- Top grain hide leather
- Polyester laminated
- Ideal size for personal use
- Bottom pocket for storage
- Embossed & embroidered logos

Code	Dimensions apx	MRP
562V	43x27x30cm (17"x11"x12")	6299/-

\* per pc



### 627V FOCUS PADS

Ultimate protection for the trainer. The thick front pad, foam lined finger cover & the padded wrist strap make it very safe for the boxer & the trainer. The ball bulge on palm & the pad under wrist gives the hand and wrist a natural shape. This makes it very comfortable.

**TECH-SPEC.**

- Top grain hide leather
- Lightweight foam combination padding
- Padded wrist & ball bulge
- Embossed & embroidered logos

Code	MRP
627V	3399/-

\* per pair

VINTAGE SERIES



626V LEATHER BOXING BAG

**TECH-SPEC.**

- Top grain hide leather
  - Canvass laminated
  - Compressed flock filled
  - Laced top
  - 25mm foam lined
  - Embossed & embroidered logos
- Diameter: 37cm/14.5" apx  
\*Chain 626C4 Included



Code	Dimensions apx	Weight	MRP
626V	Size: 120 cm (4') Dia: 37cm/14.5"	40 Kg	17249/-

\* per pc



736V MEDICINE BALL

**TECH-SPEC.**

- Top grain hide leather
- Canvass laminated
- 12 panel hand stitched
- Embossed & embroidered logos

Code	Size	Diameter apx	MRP
736V3	3 Kg	23cm/9"	3099/-
736V5	5 Kg	25.5cm/10"	3299/-
736V7	7 Kg	28cm/11"	3499/-

\* per pc



622JB SPEED BALL

**TECH-SPEC.**

- Top grain hide leather
- Laminated to retain shape
- Reinforced loop
- 6 panels pear shape
- Embossed & embroidered logos

Code	Height	Dia	MRP
622JB	25cm (10")	16cm (6.25")	1699/-
SBL5	Spare Bladder		199/-

\* per pc



621JB DOUBLE END BALL

**TECH-SPEC.**

- Top grain hide leather
- Laminated to retain shape
- Reinforced loops
- 6 panels perfect shape
- Heavy bungee cord straps
- Embossed & embroidered logos

Code	Height	Dia	MRP
621JB	42cm (16.5")	19cm (7.5")	2999/-
621JS	Spare Strap		699/-
SBL5	Spare Bladder		199/-

\* per pc



621JB

621JS

# CONTRA SERIES



USI Universal has tried to take training to a new level by introducing this high tech range. We have studied all the missing features in conventional boxing gear and tried to meet the demand of our customers. We have introduced pre shaped padded zones to deliver maximum protection, these pads are ultra strong yet lightweight. Supersoft lining material also wicks away moisture. Contoured closure system falls inline with your wrist. Contra range is an ultimate combination of comfort and fit.



### 609CBG CONTRA TRAINING GLOVES

- TECH-SPEC.** **uFEELair**  
**uFEELdRi**
- Synthetic Leather construction
  - Ultrastrong & lightweight preshaped wrist zone
  - Handcrafted inner padding
  - Moisture wicking super soft lining keeps you cool
  - Contoured wrist closure for secure fit
  - Air mesh on palm for ventilation

Code	Size	MRP
609CBG	10 oz ,12 oz	2099/-

\* per pair



### 627CFP CONTRA FOCUS PADS

- TECH-SPEC.** **uFEELair**  
**uFEELdRi**
- Synthetic Leather construction
  - Ultrastrong & lightweight preshaped padded zone
  - Concave Handcrafted inner padding
  - Ball bulge for palm grip
  - Padded wrist support
  - Moisture wicking super soft lining keeps you cool
  - Air mesh on palm for ventilation

Code	MRP
627CFP	2149/-

\* per pair



### 617CBG CONTRA BAG GLOVES

- TECH-SPEC.** **uFEELair**  
**uFEELdRi**
- Synthetic Leather construction
  - Ultra strong & lightweight preshaped padded zone
  - Handcrafted inner padding
  - Moisture wicking super soft lining keeps you cool
  - Contoured wrist closure for secure fit
  - Air mesh on palm for ventilation

Code	Size	MRP
617CBG	S/M, L/XL	2299/-

\* per pair



### 615CNT CONTRA HEAD GUARD

- TECH-SPEC.** **uFEELdRi**
- Ultrastrong & lightweight preshaped shell
  - Moisture wicking super soft lining keeps you cool
  - Maximum vision with optimum protection
  - Padded top with adjustment

Code	Size	MRP
615CNT	S/M, L/XL	2099/-

\* per pc



# IMMORTAL SERIES

Ever since the inception of USI Universal in 1965, our prime focus on combat sports has enabled us to design, develop and deliver equipment which helps our customers advance their skills and enhance their performance. All efforts have been put to support the requirements of modern day pugilists. USI Universal is constantly upgrading the technology in our equipment with regard to our padding systems, new materials & specialised machinery, topping it up with our craftsmanship.



# IMMORTAL



### 609M1 IMMORTAL SAFE SPAR GLOVES

This Product defines a perfect sparring glove. It provides ultimate hand protection without punishing your opponent. This glove will keep you cool in those long sparring sessions.

**TECH-SPEC.** **uFEELair**

- Top grain hide leather
- Injection moulded foam padding with maximum finger protection
- Elastic hook & loop wrap around strap

Code	Size	Color	MRP
609M1	12 & 16 oz.	Red,Blue	3199/-

\* per pair

### 627L SPEED COACH SPAR GLOVES

Coaches world over are looking for innovative tools to train boxers in attack & defense combinations. This is an ideal tool for developing timing & speed. Perfect for warm up before a contest.

**TECH-SPEC.** **uFEELair**

- Top grain hide leather
- Injection moulded shock absorbent padding
- Padded palm
- Hook & loop tab wrist closure.

Code	Color	MRP
627L	Red/Black	3299/-

\* per pair



### 618W WEIGHTED BAG GLOVES

**TECH-SPEC.**

- Top grain hide leather
- Thick padding of different combinations of layers
- Wrap around straps for firm support
- Pockets for changeable weights at wrist
- 8 pieces weight included

Code	MRP
618W	3299/-

\* per pair



### 617EL RELIANCE BAG GLOVES

**TECH-SPEC.**

- Top grain hide leather
- Hand crafted padding
- Elastic strap closure

Code	Size	MRP
617EL	S/M, L/XL	2149/-

\* per pair



### 617SPU FURY BAG GLOVES

**TECH-SPEC.**

- Leather & PU outer cover
- Light padding
- Easy elastic hook & loop strap closure

Code	Size	MRP
617SPU	S/M, L/XL	1499/-

\* per pair

# IMMORTAL SERIES

# IMMORTAL



### 615R FACE SAVER HEADGUARD

TECH-SPEC. uFEELdRi

- Top grain hide leather
- Padded crossbar to protect from direct hits to the face
- Adjustable lace top & rear
- Soft moisture wicking lining

Code	Size	MRP
615R	S/M, L/XL	2999/-

\* per pc



### 615A FULL FACE HEADGUARD

TECH-SPEC. uFEELdRi

- Top grain hide leather
- Soft moisture wicking lining
- Cushioned back, hook & loop strap closure
- Adjustable lace top

Code	Size	MRP
615A	S/M, L/XL	2299/-

\* per pc



### 627CB IMMORTAL CUBAN FOCUS PADS

TECH-SPEC. uFEELdRi

- Top grain hide leather
- Compact size for fast movement
- Light weight impact absorbing padding
- Soft wick dry lining on finger cover
- Ball bulge in palm are for comfortable hand position

Code	MRP
627CB	2449/-

\* per pair



### 627M IMMORTAL MOULDED FOCUS PADS

TECH-SPEC. Mould Padding

- Durable hide leather construction
- High density injection moulded shock absorbing padding
- Hook & loop strap at wrist for firm grip
- Ball bulge in palm are for comfortable hand position

Code	MRP
627M	2999/-

\* per pair



### 627CR IMMORTAL FOCUS PADS

TECH-SPEC. uFEELdRi

- Top grain hide leather construction
- Light weight impact absorbing padding made of different combinations
- Hook & loop wrist strap for firm grip
- Ball bulge at palm & extra padding at wrist for comfortable grip

Code	MRP
627CR	2699/-

\* per pair



# BOXUBER SERIES



This is a hybrid range combining leather and PU. As the name suggests, this product range is for the uber class of boxing. Shock dispersing technology with ultimate wrist lock system gives this range a contemporary feel. Soft wick dry lining makes you more comfortable.



### 609M1PU SPARRING GLOVES

- TECH-SPEC.** **uFEELdRi**
- Top grain hide leather & PU construction
  - Moulded shock absorbent foam padding heavy bulge
  - Soft wick dry lining
  - 3 bar wrist support cuff
  - Wrap around wrist closure

Code	Size	MRP
609M1PU	10,12,16 oz	2699/-

\* per pair



### 617MPU HEAVY BAG GLOVES

- TECH-SPEC.** **uFEELdRi**
- Top grain hide leather & PU construction
  - Moulded shock absorbent foam padding
  - Soft wick dry lining
  - 3 bar wrist support cuff
  - Wrap around wrist closure

Code	Size	MRP
617MPU	S/M, L/XL	2299/-

\* per pair



### 627PM FOCUS PADS

- TECH-SPEC.** **uFEELdRi** **uFEELair**
- Top grain hide leather & PU construction
  - Mesh construction
  - Compact size/light weight
  - 3 bar wrist support

Code	MRP
627PM	2849/-

\* per pair

### 622PN PEANUT BALL

- TECH-SPEC.** **PU**
- Strong PU construction
  - 6 Panel perfect peanut shape
  - Strong reinforced loop
  - Height: 23cm (9") apx.

#### PRODUCT RANGE

Code	Dia apx	MRP.
622PN	16cm (6.25")	849/-
SBL4	Spare Bladder	199/-

\* per pc



### 629CFP FOUL PROTECTOR

- TECH-SPEC.** **uFEELdRi**
- Top grain hide leather & PU construction
  - Soft wick dry lining
  - Anatomic shape for best fitting with big cup

Code	Size apx	MRP
629CFP	S,M,L	2999/-

\* per pc



## RELIANCE/CRUSHER SERIES

### 612 RELIANCE BOXING GLOVES

TECH-SPEC.  PU uFEELair SALT

- Dense handcrafted foam padding for increased shock absorption and cushioning
- Durable PU material
- Moisture wicking soft lining
- Air mesh on front palm for ventilation
- Elasticated hook & loop wrist closure

Code	Color	Size	MRP
612	Red, Blue	8 oz	1499/-
		10 oz	1549/-
		12 oz	1599/-
		16 oz	1649/-

\* per pair



### 609CPU CRUSHER TRAINING GLOVES

TECH-SPEC.  PU uFEELair SALT

- Synthetic leather shell
- Dense handcrafted padding
- Air mesh palm for vent
- Elasticated hook & loop closure

Code	Color	Size	MRP
609CPU	Orange/Black	10,12 oz	1249/-
	Blue/Orange	10,12 oz	1249/-
	Pink/Purple	8,10 oz	1249/-

\* per pair



### 617LHB CRUSHER BAG GLOVES

TECH-SPEC.  PU uFEELair SALT

- Synthetic leather shell
- Light weight padding
- Cut thumb design
- Air mesh palm for vent
- Elasticated hook & loop closure

Code	Color	Size	MRP
617LHB	Orange/Black	S/M, L / XL	899/-
	Blue/Orange	S/M, L / XL	899/-
	Pink/Purple	S/M	899/-

\* per pair



### 617EPU CRUSHER BAG GLOVES

TECH-SPEC.  PU

- Thick PU Material
- Hand crafted light padding
- Elastic/hook & loop strap

Code	Color	Size	MRP
617EPU	Red/Black	S/M, L/XL	999/-

\* per pair



## BOUNCER SERIES



### 612BV BOUNCER BOXING GLOVES

TECH-SPEC.  uFEELair

- Vinyl & mesh construction
- Flock padding with foam lining
- Wrap around strap closure

Code	Size	MRP
612BVJR	Junior (6/8oz)	599/-
612BVS/M	S/M (10/12oz)	649/-
612BVL/XL	L/XL (14/16oz)	699/-

\* per pair



### 612NV NOVICE BOXING GLOVES

TECH-SPEC.  uFEELair

- Vinyl construction
- Lightweight padding
- Ventilated upper palm and thumb
- Elasticated hook & loop tab closure

Code	Size	MRP
612NVJR	Junior	649/-
612NVS/M	S/M	699/-
612NVL/XL	L/XL	749/-

\* per pair



### 617LT BOUNCER PUNCHING GLOVES

TECH-SPEC.  uFEELair

- Vinyl & mesh construction
- Lightweight padding
- Elasticated hook & loop strap closure

Code	Size	MRP
617LT	S/M, L/XL	599/-

\* per pair



### 627C FOCUS PADS

TECH-SPEC.  

- Vinyl & suede leather construction
- Lightweight padding
- Conventional shape
- Elasticated hook & loop tab closure

Code	MRP
627C	1099/-

\* per pair

### 7038 GROUP EXERCISE KIT

TECH-SPEC. 

- Vinyl construction
- Ideal for team workout
- 1 large kit bag apx 97x38x38cm (38"x15"x15")
- Boxing gloves sizes L/XL
- Light speed rope

Code	MRP
7038	16499/-

\* per kit



# HANDWRAPS/ACCESSORIES



### 618G uFEELgel WRAPS

TECH-SPEC. uFEELgel uFEELflex

- Neoprene construction
- Gel padded knuckles

Code	Size	MRP
618G	S/M, L/XL	849/-

\* per pair



### 628 INNER GLOVES

TECH-SPEC. uFEELflex

- Rib Construction
- Padded knuckles
- Wrap length 2.5m/98.5"

Code	Size	MRP
628	S/M, L/XL	349/-

\* per pair



### 628A COTTON HAND WRAPS

TECH-SPEC.

- Herringbone weave
- Soft feel, hook & loop closure
- \* colors as per availability

Code	Length apx	MRP
628A	2.75m (108")	170/-
	4.55m (180")	220/-

\*per pair



### 628C CREPE HAND WRAPS

TECH-SPEC. uFEELflex

- Nylon elastane construction
- Stretchable for firm wrapping
- Hook & loop for closure
- \* colors as per availability

Code	Length apx	MRP
628C	2.5m (98.5")	199/-

\*per pair



### MG MOUTH GUARDS

TECH-SPEC.

- Thermo plastic
- Boil & bite fitting with sanitization case

Code	Size	MRP
MGS	Senior	70/-
MGD		80/-

\*per pc



### 628CM CAMO SHORTWRAPS

TECH-SPEC. uFEELflex

- Nylon elastane with camo print
- Hook & loop closure
- Washable

Code	Length apx.	MRP
628CM	2m (80")	449/-

\* per pair

### 628FC uFEELflex+ HANDWRAPS

TECH-SPEC. uFEELflex+

- Nylon elastane mesh
- Super stretch elastic

Code	Length apx	MRP
628FC	2.5m (98.5")	499/-

\* per pair

### CWT COTTON WRAP TAPES

TECH-SPEC.

- 100% cotton
- Non stick adhesive construction
- Serrated edges for easy ripping
- Ideal for direct use on hands, wraps or equipment
- Multi sport for boxing, MMA, cross training, weightlifting, BJJ, etc.
- Width : 38mm (1.5") apx
- Slit at 6.5m/2.54mm (1")

Code	Length	Color	Size	MRP
CWT25	13m	White	2.5cm(1")	199/-
CWT35			3.8cm(1.5")	249/-

\* per pc

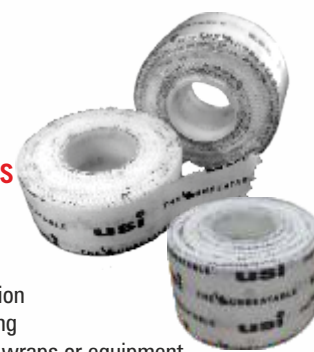

### EY EYE IRON

TECH-SPEC.

- Metal construction
- Bright zinc finish

Code	MRP
EY	549/-

\* per pc



# COACHING/TRAINING



### 627CRPU FOCUS PADS

TECH-SPEC. Advance PU

- Thick PU construction
- Hand crafted curved padding
- Padded wrist
- Gel lined ball bulge
- Ventilated back of palm
- Soft wick dry foam lining

Code	MRP
627CRPU	1699/-

\* per pair

uFEELgel  
uFEELair  
uFEELdri



### 630SC SUITCASE SHIELD

TECH-SPEC. Advance PU

- PU Construction
- Dense hand crafted padding
- Soft wick dry foam lined handles

Code	Dimensions (apx)	Weight Apx	MRP
630SC	45x45x10cm 17"X17"X4"	3.5kg/7.75 Lbs	2799/-

\* per pc



### 629PU MENS GROIN GUARD

TECH-SPEC. Core PU

- Thick PU construction
- Curved plastic cup
- Mesh lined
- Elasticated hook and loop
- Waist closure

Code	Size	MRP
629PU	S/M, L/XL	799/-

\* per pc



### 629LPU LADIES GROIN GUARD

TECH-SPEC. Core PU

- Thick PU construction
- Hand crafted padding
- Elasticated hook and loop

Code	Size	MRP
629LPU	S/M, L/XL	749/-

\* per pc

## COACHING/TRAINING

### 627FPU THAI ARM PAD

TECH-SPEC.  

- Strong Vinyl coated fabric
- Dense hand crafted padding
- Rounded edges to prevent injury
- Hook and loop closure straps
- Thick handle bar for grip

Code	Dimensions (apx)	Weight	MRP
627FPU	43 x 23 x 9 cm 17"x9"x3.5"	850g apx	1599/-

\* per pc



### 770BB BELLY BELT

TECH-SPEC.   

- Leather outer layer
- Foam lined moisture wicking lining
- Adjustable nylon strap with plastic buckle closure
- Hand crafted padding countered around abdomen

Code	Weight (apx)	MRP
770BB	1.100 kg	3299/-

\* per pc



### 770BX COACH VEST

TECH-SPEC.   

- Leather & PU construction
- Dense handcrafted padding
- Target areas for precession hits
- Soft wick dry foam lining
- Contoured shape to fit around abdomen

Code	Weight (apx)	MRP
770BX	1.500 kg	4399/-

\* per pc



# COACHING/TRAINING

## 630C CURVED HIT SHIELD

TECH-SPEC.



- Strong vinyl coated fabric
- Dense bonded foam padding
- Handle bar & arm loop

Code	Dimensions (apx)	Weight (apx)	MRP
630C	53 x 38 x 13cm (21"x15"x5")	2.5kg	1999/-

\* per pc



## 630F FLAT HIT SHIELD

TECH-SPEC.



- Punch kick shield straight
- Strong vinyl coated fabric
- Dense bonded foam padding
- Handle bar & arm loop

Code	Dimensions (apx)	Weight (apx)	MRP
630F	53 x 38 x 13cm (21"x15"x5")	3 kg	1999/-

\* per pc



## 627MW ROUND HIT SHIELD (MAKIWARA)

TECH-SPEC.



- Leather & PU combination
- Dense airform padding with air pocket
- Handle bars with soft lining
- Round shaped

Code	Dimensions (apx)	Weight (apx)	MRP
627MW	40x12.5cm (16" x 5")	1 kg	3249/-

\* per pc



## 632L UPPERCUT SHIELD WALL MOUNTED REAL LEATHER

TECH-SPEC.



- Grained leather construction
- Fitted on a metal frame
- Target spots for practicing uppercut, hook & side blow
- Mounting screws included

Code	Weight (apx)	MRP
632L	13 Kg	11999/-

\* per pc

## 632 UPPERCUT SHIELD WALL MOUNTED

TECH-SPEC.



- Strong PU construction & fitted on a metal frame
- Target spots for practicing uppercut, hook & side blow
- Mounting screws included

Code	Weight (apx)	MRP
632	13 Kg	7599/-

\* per pc



Length 63 cm (25")

# SPEED BALLS/ACCESSORIES



36cm/14.15"



### 622PN PEANUT BALL

TECH-SPEC. Advance PU

- Strong PU construction
- 6 panels perfect peanut shape
- Strong reinforced loop
- Height: 25cm (10") apx

Code	Dia apx	MRP
622PN	16cm (6.25")	899/-
SBL4	Spare Bladder	199/-

\* per pc

### 622S ECONOMY SPEEDBALL

TECH-SPEC. Core Leather \$

- Hand sewn leather construction
- 6 panels hand stitched
- Height: 30cm/11.80"

Code	Dia apx	MRP
622S	18.5cm (7.30")	1299/-
SBL5	Spare Bladder	199/-

\* per pc

### 6218/P FURY CLUB DOUBLE END BALL

TECH-SPEC. Core Leather \$

- Hand sewn leather construction
- 8 panels hand stitched
- Height: 26cm/10.25"

Code	Dia apx	MRP
6218/P	23cm/9"	2499/-
621SS	Spare Strap	599/-
SBLR5	Spare Bladder	199/-

\* per pc



### 624PSP PRO SPEEDBALL PLATFORM

TECH-SPEC. Performance

- Heavy duty MDF board precision cut for accurate re-bound
- Fixed height
- Complete hardware items with Swivel 623 U type
- Flat packed

Code	Size apx	MRP
624PSP	60cm (24")	3399/-

\* per set



### 624SP SPEED BALL PLATFORM SET

TECH-SPEC. Core

- Complete hardware items with Swivel 623 bell
- Adjustable height: 16.5cm (6.5") apx
- Flat packed

Code	Size apx	MRP
624SP	60cm (24")	2999/-

\* per set

### 623 SPEEDBALL BELL

TECH-SPEC. Core

- Zinc plated steel construction
- Basic bell type design

Code	MRP
623	249/-

\* per pc



### 623U U TYPE SWIVEL

TECH-SPEC. Advance

- Chrome plated steel
- Ball bearing
- Push pin system for easy attaching & removal of speed ball

Code	MRP
623U	599/-

\* per pc





# BOXING BAGS

USI Universal is pleased to introduce the Water bag, a perfect alternative to a heavy punch bag. Constructed with a UV resistant marine grade vinyl. Measurements (in diameter) are as following:



### WB WATER PUNCHING BAG

The USI Universal water punching bags come with a D-Ring & very strong rope for easy hanging the bag, together with a hose fitting nozzles to assist the filling of water in the bag. It can also be used both indoors and outdoors .

**TECH-SPEC.**



- Constructed with a UV resistant marine grade vinyl
- Perfect alternative to a heavy punch bag

Code	Diameter	MRP
WB55	55cm (21.6")	17999/-
WB46	46cm (18")	14999/-
WB38	38cm (15")	12499/-

\* per pc

**Available Sizes:  
55, 46 & 38cm**

**⚠ Accessories Included:**



1. D Shackle



2. Strong Rope for Hanging



3. Hose Filling Nozzle

# BOXING BAGS



USI Punch Bags are now stitched & filled in our new factory. Here we have a dedicated production facility equipped with heavy duty stitching machines, Pneumatic filling machines & an X-Ray machine for quality production.



### 626ABL IMMORTAL LEATHER ANGLE BAG

TECH-SPEC.



- Thick leather canvas laminated
- Compressed flock filled

**SUPER VALUE**

Code	Weight	Height apx	MRP
626ABL	35 Kg	105cm (42")	13749/-

\*Chain 626CH6 included

\* per pc



### 626ABN CRUSHER NYLON ANGLE BAG

TECH-SPEC.



- Tough quality nylon material
- Long hanging straps
- Compressed flock filled

**SUPER VALUE**

Code	Weight	Height apx	MRP
626ABN	30 Kg	105cm (42")	6199/-

\*Chain 626CH6 included

\* per pc

# BOXING BAGS



90 cm



105 cm



120 cm



150 cm



180 cm

## 626L IMMORTAL SUPER LEATHER BOXING BAGS

**TECH-SPEC.** **SUPER VALUE**

- Thick leather canvas laminated
- D-Ring at bottom for floor attachment
- Foam lined for body feel
- 25mm foam lining for body feel
- Compressed flock filled
- Diameter: 37cm/14.5" apx

Code	Height apx	Weight	MRP
626L90	90 cm/3'	25 Kg	11149/-
626L105	105 cm/3.5'	30 Kg	12149/-
626L120	120 cm/4'	40 Kg	13849/-
626L150	150 cm/5'	45 Kg	15849/-
626L180	180 cm/6'	55 Kg	17999/-

\*Chain 626C4 included with 90,105 & 120cm  
 \*Chain 626CH4 included with 150 & 180cm

\* per pc



90 cm



105 cm



120 cm



150 cm



180 cm

## 626PU FURY PU BOXING BAGS

**TECH-SPEC.** **PU** **SUPER VALUE**

- Thick PU coated material
- Compressed flock filled
- D-Ring at bottom for floor attachment
- Diameter: 39cm/15.5" apx

Code	Height apx	Weight	MRP
626PU90	90 cm/3'	28 Kg	5399/-
626PU105	105 cm/3.5'	30 Kg	5999/-
626PU120	120 cm/4'	40 Kg	6699/-
626PU150	150 cm/5'	50 Kg	7699/-
626PU180	180 cm/6'	60 Kg	8949/-

\*Chain 626C4 included with 90,105 & 120cm  
 \*Chain 626CH4 included with 150 & 180cm

\* per pc

# BOXING BAGS



## 626N CRUSHER NYLON BOXING BAGS

TECH-SPEC.



- Tough quality nylon material
- Long hanging straps
- Compressed flock filled
- Loop at bottom for floor attachment
- Diameter: 33cm/13" apx

Code	Height apx	Weight	MRP
626N60F	60 cm/2'	15 Kg	2999/-
626N90F	90 cm/3'	20 Kg	3649/-
626N105F	105 cm/3.5'	25 Kg	3849/-
626N120F	120 cm/4'	30 Kg	4549/-
626N150F	150 cm/5'	35 Kg	5049/-
626N180F	180 cm/6'	40 Kg	5499/-

\*Chain 626SW4 included with all sizes \* per pc

MRP for Unfilled

Code	Height apx	MRP
626N60UF	60 cm/2'	1299/-
626N90UF	90 cm/3'	1549/-
626N105UF	105 cm/3.5'	1649/-
626N120UF	120 cm/4'	1799/-
626N150UF	150 cm/5'	2099/-
626N180UF	180 cm/6'	2399/-

\*Chain not included



Unfilled Bag



## 626C CLASSIC CANVAS BOXING BAGS

TECH-SPEC.



- Heavy 20 oz canvas construction
- Reinforced hitting area
- Compressed flock filled

Code	Height apx	Weight	Dia. apx	MRP
626C60F	60 cm/2'	12 Kg	21.5 cm/8.5"	2149/-
626C90F	90 cm/3'	16 Kg	29 cm/11.5"	3049/-
626C105F	105 cm/3.5'	20 Kg	34 cm/13.5"	3649/-
626C120F	120 cm/4'	25 Kg	34 cm/13.5"	3999/-

\*Chain included 626SW4 with all sizes \* per pc

MRP for Unfilled

Code	Height apx	MRP
626C60UF	60 cm/2'	749/-
626C90UF	90 cm/3'	949/-
626C105UF	105 cm/3.5'	1299/-
626C120UF	120 cm/4'	1449/-

\*Chain not included

# BOXING BAGS

The 'Big DADDY' of all Punch bags. A massive leather punch bag with a big diameter. Ideal for thorough professionals who want to experience a competitive opponent.



### 626T 3 IN 1 LEATHER BOXING BAG

TECH-SPEC.

- Thick grain leather
- Reinforced handles & bottom
- Filled with plastic granules

Code	Height apx	Weight apx	MRP
626T	75cm/2.5'	17 Kg	10249/-

\*Chain 626C4 included \* per pc



### 622N MAIZE SACK 30

TECH-SPEC.

- Thick grain leather
- Reinforced handles & bottom
- Filled with plastic granules

Code	Height apx	Weight apx	MRP
622N	76cm/2.5'	25 Kg	10599/-

\*Chain 626C4 included \* per pc



### 622N1 MAIZE SACK 18

TECH-SPEC.

- Thick grain leather
- Reinforced handles & bottom
- Filled with plastic granules

Code	Height apx	Weight apx	MRP
622N1	46cm/1.5'	6 Kg	5499/-

\*Chain 626C4 included \* per pc



### 626DB DADDY BOXING BAG

TECH-SPEC.

- Top grain hide leather
- Thick canvas laminated for strength
- 6 hanging straps for distribution equal of weight
- 50mm foam lined jacket for body feel
- Compressed flock filled

Code	Weight apx	Height apx	MRP
626DB	60 Kg	120cm (4') apx. Dia 50cm (20") apx.	23849/-

\*Chain 626CH6 included \* per pc

### ANCH BAG ANCHOR

TECH-SPEC.

- Nylon construction
- Ideal for restricting bag movement
- Comes with strap for attaching with bag
- Can be filled with apx 25 Kg of sand
- \* comes empty (without filling)

Code	Weight Capacity	Height apx	MRP
ANCH	25 Kg	60 x 10 cm 24" x 4"	1799/-

\* per pc



# HARDWARE

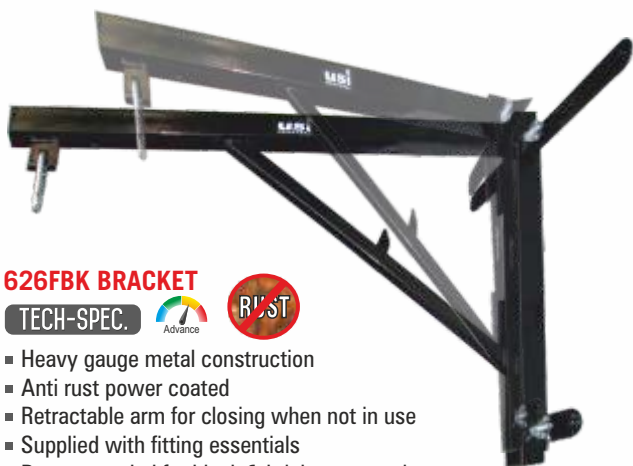

### 626FBK BRACKET

TECH-SPEC.



- Heavy gauge metal construction
- Anti rust power coated
- Retractable arm for closing when not in use
- Supplied with fitting essentials
- Recommended for block & brick construction
- Weight capacity upto 60 kg

Code	Dimensions apx	MRP
626FBK	91 x 48 x 66cm (36" x 19" x 26")	3799/-

\* per set



### 626B LIGHT DUTY WALL BRACKET

TECH-SPEC.



- Light duty metal pipe construction
- Snap hook for hanging the bag
- Anti rust power coated
- Supplied with fitting essentials
- Weight capacity upto 30 kg

Code	Dimensions apx	MRP
626B	74 x 20 x 61cm (29" x 8" x 24")	1800/-

\* per set



### 626FB FOLDING WALL BRACKET

TECH-SPEC.



- Heavy duty metal construction
- Anti rust power coated
- Snap hook for hanging the bag
- Drops flat to the wall
- Supplied with fitting essentials
- Weight capacity upto 60 kg

Code	Dimensions apx	MRP
626FB	91 x 48 x 66cm (36" x 19" x 26")	3599/-

\* per set

Folded View →

### 626W WALL BRACKET

TECH-SPEC.



- Metal construction
- Anti rust power coated
- Supplied with fitting essentials
- Weight capacity upto 20 kg

Code	Dimensions apx	MRP
626W	74 x 20 x 61cm (29" x 8" x 24")	1399/-

\* per set

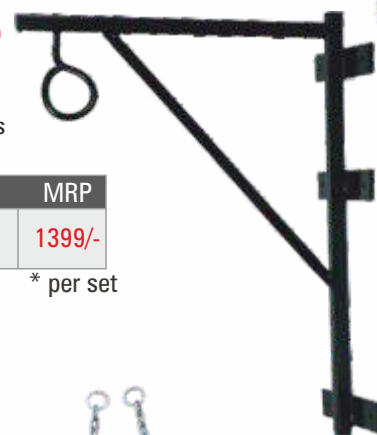

### 626E EXTENSION CHAIN

TECH-SPEC.

- Zinc plated
- For high ceiling bag hanging
- Length: 1m(3.25') apx
- Weight capacity upto 75 kg

Code	MRP
626E	299/-

\* per pc



### 626CH6 6 LEG CHAIN

TECH-SPEC.



- Metal construction
- Forged steel swivel
- Snap hooks secure bag from falling
- Zinc plated
- Ideal for bags with 6 hang handles
- Weight capacity: upto 75kg

Code	Weight	MRP
626CH6	1.750Kg	949/-

\* per pc



### 626CH4 4 LEG CHAIN HEAVY

TECH-SPEC.



- Metal construction
- Forged steel swivel
- Snap hooks secure bag from falling
- Zinc plated
- Ideal for bags with 4 hang handles
- Weight capacity: upto 65kg

Code	Weight	MRP
626CH4	1.300Kg	849/-

\* per pc



### 626C4 4 LEG CHAIN

TECH-SPEC.



- Metal construction
- Forged steel swivel
- Snap hooks secure bag from falling
- Zinc plated
- Ideal for bags with 4 hang handles
- Weight capacity: upto 50kg

Code	Weight	MRP
626C4	1.250Kg	649/-

\* per pc



### 626SW4 4 LEG CHAIN

TECH-SPEC.



- S hooks secure bag from falling
- Zinc plated
- Ideal for bags with 4 hang handles
- Weight capacity: upto 45kg

Code	Weight	MRP
626SW4	0.750Kg	390/-

\* per pc

# HANGING STANDS

## 6262S DOUBLE STATION



- Portable heavy duty metal tube structure with adjustable height speedball platform
- Ideal for hanging bag up to 20-25kg/3' long punch bag, hanging chain, base tie cord and speed ball sold separately
- Need to put weight plates on vertical rods to make the stand stable

Code	Size: (in meters)	MRP
6262S	L: 1.15 , W: 1.5, H: 2.35 (45" x 60" x 92.5")	20499/-

\* per set

Assembly Video



## 6261S SINGLE STATION



- Portable heavy duty metal tube structure
- Ideal for hanging bag up to 20-25kg/3' long
- Need to put weight plates on vertical rods to make the stand stable

Code	Size: (in meters)	MRP
6261S	L: 1.1, W: 1.2, H: 2.3 (43"x48"x90")	12999/-

\* per set

## PBH PUNCH BAG HANGER



Code	MRP
PBH	2499/-

\* per pc

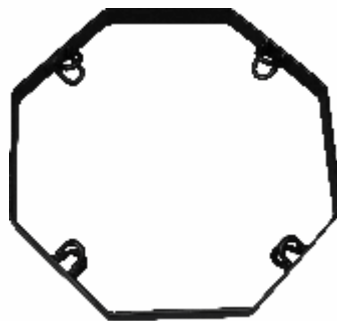

## 626SPH SPRING



- Metal spring for hanging punch bag
- Weight capacity: 75 kg

Code	MRP
626SPH	399/-

\* per pc



## 626R SWIVEL



- Heavy swivel
- Weight capacity: 75 kg

Code	MRP
626R	499/-

\* per pc



## 626CHSW HOOK



- Swivel action
- Weight capacity: 40 kg  
\*with screws

Code	MRP
626CHSW	449/-

\* per pc

## FREE STANDING BAGS

USI Universal's range of free standing bags are ideal for places where you cannot hang Punch bags from the ceiling or on the walls. Very good product for studios/gyms with false ceilings. Portable for short outdoor use.

### 706FOB FREESTANDING OPPONENT BAG MAN SHAPE

TECH-SPEC. 

- Height of main body: 98cm (39")
- High strength urethane foam construction
- Elastomeric spring action
- Plastic base with cavity
- Can be filled with 80-90 Kg of sand

Code	Adjustable Height	MRP
706FOB	160-200 cm (5'3"- 6'7")	50,999/-

\*per set



### 706FSD DUMMY SHAPED PUNCH/KICK BAG

TECH-SPEC. 

- Plastic/PU construction
- Elastomeric spring action
- Plastic base with cavity
- Can be filled with 100-110 Kg of sand

Code	Adjustable Height	MRP
706FSD	162/178/195 cm (5'4"/5'10"/6'5")	32,999/-

\*per set



### 706FS FREE STANDING PUNCH/KICK BAG

TECH-SPEC. 

- Plastic/PU construction
- Elastomeric spring action
- Plastic base with cavity for filling sand
- Can be filled with 100-110 Kg of sand

Code	Adjustable Height	MRP
706FS	162/178/195 cm (5'4"/5'10"/6'5")	28,499/-

\*per set



\* Due to the nature of use, free standing bags are not warranted for any breakage/damage.



# FREE STANDING BAGS

## 706FSL FREE STANDING PUNCH/KICK BAG

TECH-SPEC. 

- Plastic/Vinyl/Foam construction
- Plastic base with cavity for filling sand/water
- Full scale bag
- Wider bag diameter
- Can be filled with 80-90 Kg of sand

Code	Body Height (Apx.)	MRP
706FSL	162 cm (5' 10")	38,999/-

\*per set

 Assembly Video



## 706PPS PRO PUNCH STAND

TECH-SPEC. 

- Plastic/PU/metal construction
- PU foam ball
- Spring action
- Plastic base with cavity for filling sand
- Can be filled with 25-30 Kg of sand

Code	Adjustable height	MRP
706PPS	Apx. 100 to 152 cm (3'4" to 5')	7399/-

\*per set

## 706FSK PUNCH KICK TRAINER

TECH-SPEC. 

- Metal/plastic construction
- Adjustable target pads
- Plastic base for filling sand
- Target pad : upto apx. 190 cm (6' 3")
- Can be filled with 50-60 Kg of sand

Code	Pole Height apx	MRP
706FSK	152 cm (5')	17999/-

\*per set

 Assembly Video



\* Due to the nature of use, free standing bags are not warranted for any breakage/damage.

# FREE STANDING BAG

## 706PKM PUNCH BOX MASTER



- Metal, foam & PU construction
- Springs replicate hitting on a punch pad
- Pads have been positioned to throw a variety of punches
- Different punch & kick combinations possible
- Must bolt to floor
- Bottom base made of foam for kicks

Code	Height apx	Adjustable Heights	MRP
706PKM	2m (6.5')	1.65m - 2m (5' 5" - 6' 6")	129999/-

\*per set



\* Due to the nature of use, free standing bags are not warranted for any breakage/damage.

# BOXING RINGS

USI Universal has now entered the arena of heavy duty engineered products with the introduction of our AIBA specification boxing rings. We have tried to deliver a product which is very easy to install, has a long lasting life & very robust in nature. The frame is built with heavy gauge box steel with very less bolts. Most of the platform is installed with our drop fit technology. Ideal for big championships & world class training facilities.



## 626CBR COMPETITION BOXING RING

TECH-SPEC.



- Heavy gauge box steel construction
- Anti rust powder coated
- 25mm commercial grade plywood floor
- Expandable foam lining
- Polypropylene ropes covered with vinyl covers & rope spacers
- Corner pads & safety covers for turnbuckles
- Seam sealed vinyl coated ring cover
- Complete with turnbuckles & other metal accessories
- Swing arm ring chairs
- 3 sets of ring stairs
- 2 sets of funnel, pipe & sanitary buckets
- Platform sides covered with ring skirt



### Dimensions Fight Area



### Frame Size

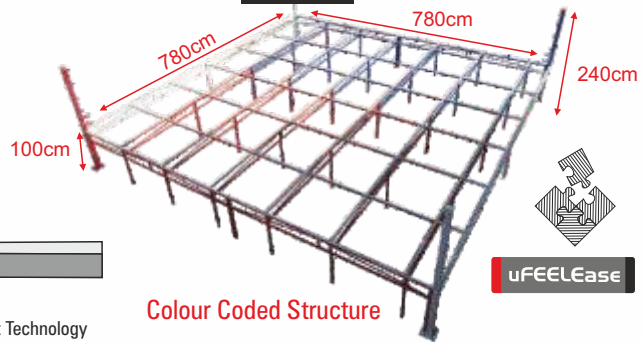

Drop fit Technology

Colour Coded Structure

uFEELCase



Protective Padding



Access Stair



Anti Rust Coating



Wooden Floor



Engineered Product



**CUSTOM MADE**

We make custom sizes as per requirement. At times gyms do not have the space or budget, also for special training.

Total Area	Inside Area	626CBR Competition	626HBR High Platform	626LBR Low Platform	626FBR Floor
25.6'x25.6'/780cm	20'x20'/610cm	7,90,000	X	X	X
20'x20'/610cm	18'x18'/550cm	X	6,60,000	4,50,000	X
18'x18'/550cm	16'x16'/488cm	X	6,10,000	4,00,000	X
16'x16'/488cm	14'x14'/427cm	X	5,60,000	3,55,000	2,00,000
14'x14'/427cm	12'x12'/366cm	X	X	2,90,000	1,88,000
12'x12'/366cm	10'x10'/305cm	X	X	2,42,000	1,61,000

## 626HBR HIGH PLATFORM CLUB BOXING RING

Ideal for clubs, gyms who have space constraint or want to use smaller area for specific training. Complete with 02 swing arm chairs. 03 stair cases, 02 sets spittoons & buckets.



## 626LBR LOW PLATFORM GYM BOXING RING

Ideal for fitness clubs, gyms who are looking to add an aesthetic touch to their space. Ideal for places with low ceiling. Budget friendly. 02 ring stools included. Ring platform is at a height of 38cm/15" apx.



# BOXING RING & ACCESSORIES

Ideal for Gyms/Clubs who have less space. A very portable ring which can also be used for floor exercises. Many coaches use this style of ring for close combat training as well.

## 626FBR FLOOR BOXING RING

- TECH-SPEC.**    
- Metal, foam construction
  - Anti rust powder coated
  - Durable paint
  - Fully collapsible
  - Interlocking mat floor 25mm
  - 02 ring stools included



Code	Total Area	Inside Area	MRP
626FBR16	16'x16'/488cm	14'x14'/427cm	2,00,000
626FBR14	14'x14'/427cm	12'x12'/366cm	1,88,000
626FBR12	12'x12'/366cm	10'x10'/305cm	1,61,000

# RING ACCESSORIES



## CB CHAMPIONSHIP BELT

- TECH-SPEC.**
- Brass plate construction
  - Hide leather belt with fur lining
  - Metal buckle closure
  - Custom designs possible

**CUSTOM MADE**

Code	MRP
CB	ON REQUEST



## RG RING GONG

- TECH-SPEC.**
- Metal & wood construction
  - Brass hammer

Code	MRP
RG	3999/-

\* per set



## GT GYM TIMER

- TECH-SPEC.**
- High visibility 55mm digits
  - Preset 2 or 3 minutes with 30 or 60 seconds rest
  - Loud sounder for noisy gym environment
  - Ideal for boxing or circuit training

Code	MRP
GT	8400/-

\* per pc



## FB FIGHT BOTTLE 1 LTR.

- TECH-SPEC.** 
- Food grade plastic construction.
  - Extended pipe with lid for inserting in mouth
  - Leak proof

Code	Color	Capacity apx	MRP
FB	White	32 fl oz/0.95 ltr	349/-

\* per pc



## SPNG SPONGE

- TECH-SPEC.**
- Soft foam

Code	Dimensions (apx.)	MRP
SPNG	19 cm x 14cm x 5cm (7.5" x 5.5" x 2")	249/-

\* per pc

# BOXING RING ACCESSORIES

## RTBC TURN BUCKLE COVER

TECH-SPEC. 

- Nylon construction
- Foam padded
- Hook & loop closure
- Turnbuckle
- Set include : 4 Red , 4 Blue , 8 White pcs.



Code	Length	MRP
RTBC	1m apx	6320/- 395/- x 16pcs



## RDS ROPE SPACER

TECH-SPEC.

- Nylon material
- Hook & loop closure

Code	Set	MRP
RDS	8 pcs	1999/-

\* per set



## RCC RING COVER CANVAS

TECH-SPEC.

- Ring mat canvas
- Eyelets for tying ropes

Code	Size	MRP
RCC	8 m (26.5'x26.5')	23999/-

\* per pc



## RST RING STAIR

TECH-SPEC.

- Metal & wood construction

Code	Dimensions	Color	MRP
RST	86x61x81cm 34x24x32"	Red, Blue, White	7899/-

\* per pc



## RCN RING COVER NYLON

TECH-SPEC.

- Ring mat nylon material
- Seamless construction
- Eyelets for tying ropes

Code	Size	MRP
RCN	8 m (26.5'x26.5')	35499/-

\* per pc



## CP CORNER PADS

TECH-SPEC.

- Tough nylon material
- Foam padding
- Set of 4 (1 Red + 1 Blue + 2 White)

Code	Set	MRP
CP	4 pcs	8999/-

\* per set



## RP RING PADDING

TECH-SPEC.

- 25mm thick expandable foam
- 1.2 x 2m x 28 sheets

Code	Sheets	MRP
RP	28 pcs	28390/-

## RR RING ROPE

TECH-SPEC.

- Polypropylene (PP) twisted rope
- 25mm thick plastic

Code	Length apx	MRP
RR	137m (450') apx.	26499/-

\* per pc



## WRR METAL RING ROPE

TECH-SPEC.

- 8mm metal wire construction
- Covered with nitrile foam tube
- Pre assembled for competition boxing ringx 4 ropes

Code	MRP
WRR	35999/-

\* per set



## RTB TURN BUCKLES

TECH-SPEC.

- Forged metal construction

Code	Closed Len.	Open Length	MRP
RTB	100cm/39.5"	135cm/53"	2599/-
RTB1	30cm/12"	45cm/18"	599/-

\* per pc



## RC ROPE COVER

TECH-SPEC.

- Nylon material
- Hook & loop closure
- Ideal for competition boxing ring
- Set includes: 8 Red/White , 8 Blue/White
- \*cover only, rope not included

Code	Size length	MRP
RC	610cm/20' each cover	22000/-

\* per set

# BOXING APPAREL

USI Universal is setting new bench marks in the fightwear business. Introducing performance fabrics which keep you cool & comfortable. USI Universal is producing high quality garments as per international standards. USI Universal has vowed to keep you up to date with the latest fashion. We shall empower you to live your fitness lifestyle dream.



### 419BG BOXING GOWN

**TECH-SPEC.**

- Polyester satin weave 200 GSM apx
- Colors: Red & Blue

Code	Size	Color	MRP
419BG	S/M, L/XL	Red, Blue	2099/-

\* per pc

## TUF-WEAR®

TUF-WEAR boxing boots are ultra light for fast footwork in the ring with good mid height support that still allows the boots to be flexible for comfort & speed. Mesh & Nubuck PU upper keeps your feet cool & dry while shuffling your way through training or a fight.



### 701S SHUFFLE BOXING BOOTS

**TECH-SPEC.**

- Mesh & Nubuck PU upper
- Strong rubber grip sole
- Anatomic cut

Code	Size	MRP
701S	5-11	2599/-

\* per pair



### 409 BOXING SHORTS & VEST

**TECH-SPEC.**

- Polyester performance mesh 150 GSM apx
- 100mm/4" waist band for shorts
- As per AIBA guidelines



Breathable

Moisture Wicking

Code	Size	Colors	MRP
409SV	MENS	Red, Blue	949/-
409LSV	LADIES		949/-
409LSV	LADIES		1099/-

\* per set

WHILST STOCK LAST



### 701 BOXING BOOTS

USI Universal boxing boots are lightweight for quick movement & agility. The mid cut boots prevent ankle twisting. The high traction sole promotes a good grip.

**TECH-SPEC.**

- Fabric /suede combination upper
- 3 pivot point moulded rubber sole

Code	Size	MRP
701	4-12	2349/-

\* per pair

# MMA GEAR

An evolution of all fight sports combined. Incorporating all thrill bits of various Martial arts in the world has been essential for the success of this sport. Paying respect to the dynamism of this sport, USI Universal has come out with a range of competition and training gear which compliments every need of a hardworking Mixed Martial Artist. From International Standard MMA Cage to training gloves and apparel, USI Universal has tried to live upto the expectations of our customers.



## 618E1 AMATEUR MMA GLOVES

TECH-SPEC. uFEELdRi

- Durable hide leather construction
- Hand crafted padding made of different combinations
- Padded thumb
- Leather/Hook & loop wrap around strap

Code	Size	Color	MRP
618E1	S/M, L/XL (7 oz.)	Red, Blue	1999/-

\* per pair



## 618GR1 STRIKE TRAINING GLOVES

TECH-SPEC. uFEELdRi

- Durable hide leather construction
- Hand crafted speciality foam padding
- Anatomically shaped padding
- Padded thumb
- Leather/Hook & loop strap closure

Code	Size	MRP
618GR1	S/M, L/XL (7 oz.)	1899/-

\* per pair



## 618GTC1 PRO GLOVES

TECH-SPEC. uFEELdRi

- Durable hide leather
- Hand crafted padding
- Leather/Hook & loop strap closure

Code	Size	MRP
618GTC1	S/M, L/XL (4 oz.)	1999/-

\* per pair



## 610B TRAINING GLOVES

TECH-SPEC. PU uFEELdRi

- Thick PU construction
- Hand crafted shock absorber padding
- Wrap around hook & loop closure

Code	Size	MRP
610B	S/M, L/XL	1199/-

\* per pair



## 618F STRIKE TRAINING GLOVES

TECH-SPEC. PU uFEELdRi

- Thick PU construction
- Hand crafted shock absorber padding
- Wrap around hook & loop closure

Code	Size	MRP
618F	S/M, L/XL	1099/-

\* per pair



## 2013 KNEE / ELBOW GUARDS

TECH-SPEC.

- Top grain hide leather
- Moulded padding
- Neoprene sleeve

Code	Size	MRP
2013	S/M, L/XL	2449/-

\* per pair



## 609MTP MUAY THAI GLOVES

TECH-SPEC. PU uFEELair

- Thick PU construction
- Hand crafted shock absorber padding
- Wrap around hook & loop closure
- Ventilated air mesh palm

Code	Size	MRP
609MTP	10oz, 12oz	1299/-

\* per pair

# MMA CAGES

The Arena where it all happens. A colosseum in itself. In line with USI Universal's engineered product range. The MMA Cage is made with heavy duty industrial grade materials. We have pioneered a very sturdy structure which can be assembled quickly. This is achieved by our drop fit panels. The protective padding across the structure makes the fighters fight safely & fearlessly.

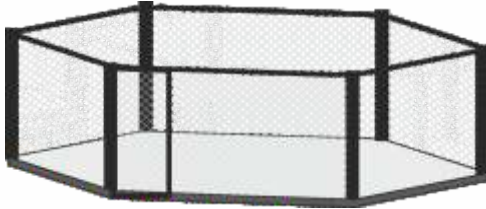

**MMACF FLOOR MMA CAGE (HEXAGONAL)** 

Ideal for gyms/clubs who have less space. A very portable cage which can be used for floor exercises as well. Comes complete with padded flooring, non tear seamless cover, 01 access door, 2 cage stools, horizontal & vertical pads.

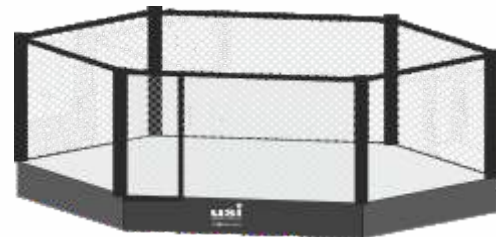

**MMACL LOW PLATFORM TRAINING MMA CAGE (HEXAGONAL)** 

For clubs & gyms who are looking to add an aesthetic touch to their space. Ideal for places with low ceiling. Budget friendly. Comes complete with padded flooring, non tear seamless cover, 01 access door, 2 cage stools, horizontal & vertical pads. Complete with wood floor, floor padding, non tear. Cage platform is at a height of 38cm/15" apx.



**COMPETITION MMA CAGE (HEXAGONAL)** 

## CUSTOM MADE

We make custom sizes as per requirement. At times gyms do not have the space or budget, also for special training.



### MMACG MMA CAGE

#### TECH-SPEC.

- Heavy duty steel construction
- Solid steel mesh vinyl coated
- Seam sealed vinyl coated floor cover
- Anti rust powder coated metal structure
- Protective padding on posts & cage walls
- 25 mm thick plywood floor
- 50 mm thick padded floor
- 2 Access door with lock hinges
- 2 Access stairs with 2 stools
- Complete with cage skirt



Size Apx. Panel to Panel		Size Apx. Corner to Corner		MRP MMACG Competition	MRP MMACL Low Platform	MRP MMACF Floor Cage
20.5'	6.3m	23.5'	7.22m	8,07,000/-	7,26,000/-	3,86,000/-
16.5'	5m	19'	5.77m	7,07,000/-	6,41,000/-	3,36,000/-
13'	4m	15'	4.61m	6,37,000/-	5,81,000/-	2,86,000/-



Hexagonal Style



Solid Steel Mesh

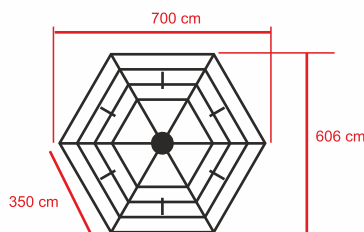

Protective Padding



Access Stair



Anti Rust Coating



Wooden Floor



uFEELCase



Drop fit Technology



# MMA STRUCTURES & ACCESSORIES

As the name suggests, you can get this structure made as per the space available, made with the same materials as the competition MMA cage.

## ■ CUSTOM CAGE STRUCTURE

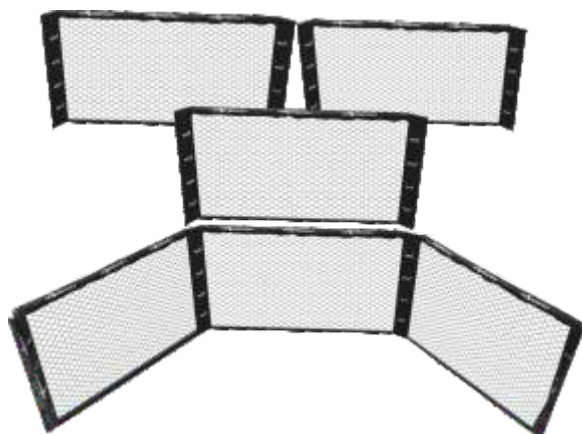

Code	Description	Units	MRP
<b>MMACW</b>	MMA cage custom wall with horizontal padding Height:1.83m/6'	Running meter Running feet	2500/- 770/-
<b>MMACD</b>	MMA cage door with horizontal padding	Piece	13000/-
<b>MMACP</b>	MMA cage pillar height 1.83m/6' (with M12 anchor bolts x 6 pcs )	Piece	10499/-
<b>MMACHP</b>	MMA cage horizontal padding vinyl cover, wrap around	Running meter Running feet	770/- 235/-
<b>MMACFC</b>	MMA cage custom floor cover Seamless, non tear, 550 GSM apx	Square meter : Square feet:	753/- 70/-
<b>MMACFP</b>	MMA cage floor padding 50mm thick expandable foam	Square meter : Square feet:	799/- 75/-

**CUSTOM  
MADE**

\*Kindly send the location pictures & dimensions in centimetres.  
Production time: 3-4 weeks after confirmation of order & along with receipt of advance deposit.

An ideal product for gyms which don't have enough space for a cage. can be instated between pillars, to create a division protective padding.

### MMACW CAGE WALL

**TECH-SPEC.**

- Heavy gauge box steel construction
- Vinyl coated mesh
- Protective horizontal & vertical pads
- Size :- As per order.

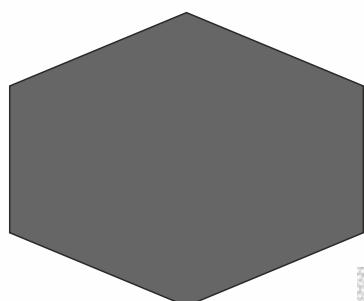

### MMAFC FLOOR COVER

**TECH-SPEC.**

- Nylon material
- Seamless construction
- Eyelets for tying ropes



Code	Size	MRP
MMAFC	7m X 7m	35499/-

\* per pc

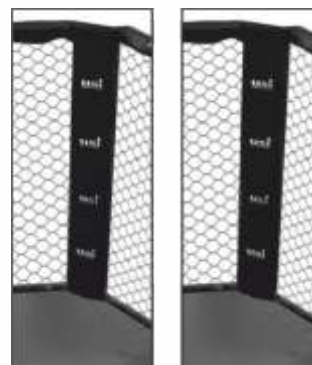

### MMAVP VERTICAL PADS

**TECH-SPEC.**

- Strong vinyl coated fabric
- Dense shock absorbent padding
- Hook & loop strap closure

Code	MRP
MMAVP 2000 X 12 pcs	24,000/-

\* per set

### MMAHP HORIZONTAL PADS

**TECH-SPEC.**

- Strong vinyl coated fabric
  - Soft padding hook & loop
  - Strap closure
- \*Sold per piece.



Code	MRP
MMAHP 2650/- X 12 pcs	31800/-

\* per set

# TRAINING DUMMIES



### TCDL GRAPPLING DUMMY WITH LEGS

Life size training partner without the risk of injury. Great to develop skills in wrestling, MMA & Jiu-Jitsu. Perfect your throws, takedowns, strikes & submissions.



- Heavy duty micro fibre PU
- Compressed flock filled
- Dimensions and sizing recommendations

Code	Size	Height	Weight	MRP
TCDL16	XS	132cm/4'4"	16 Kg	11199/-
TCDL25	S	147cm/4'10"	25 Kg	11999/-
TCDL30	M	158cm/5'2"	30 Kg	12849/-
TCDL40	L	158cm/5'2"	40 Kg	14149/-
TCDL55	XL	173cm/5'8"	55 Kg	15099/-
TCDL60	XXL	183cm/6'	60 Kg	15449/-
TCDL70	XXXL	188cm/6'2"	70 Kg	16699/-

\* per pc

### TCD THAI CLINCH GRAPPLING DUMMY

Ideal for training MMA, Muay Thai, Kick boxing & Jiu-Jitsu. Great for ground & pound. Also helpful in stand up strike training.



- Heavy duty micro fibre PU
- Compressed flock filled

Code	Weight	Size	MRP
TCD40	40 Kg	172cm (5'8")	13899/-
TCD55	55 Kg		

\* per pc



# TRAINING DUMMIES

## 2012 MMA DUMMY

Get the feel of training with a real person. Designed for Brazilian Jiu Jitsu & MMA training. The sit down feature helps to perform many BJJ Drills. Practice your triangle, arm bar, chokes, locks, guards, attack with this great tool.

**TECH-SPEC.**  Performance

- Heavy duty micro fibre PU
- Compressed flock filled
- Can be used in multiple grappling positions

Code	Weight apx	MRP
2012	35 Kg	20400/-

\* per pc



## TDU THROW DUMMY

Torso shaped training tool ideal for improving throws, takedowns, strikes & knees.

**TECH-SPEC.**  Core  **SUPER VALUE** 

- Thick PU construction
- Compressed flock filling
- Weight 27 Kg apx

Code	MRP
TDU	5099/-

\* per pc

# MUAY THAI

Inspired by the roots of fight sport, this range is dedicated to the Thai style of fight gear. Thick, supple leather, dense heavy duty padding. Very solid construction made for use at highest levels of Muay Thai & MMA training.



# MUAY THAI GEAR

## 609MT1 MUAY THAI GLOVES

Traditional style compact gloves. The plain palm allows clinching. Enable holds during kicks, also helps in catching the kicks. The side padding on the palm helps in blocking with the palm. The thumb is more open to promote grip on the opponent. Thick round cuff with a lot of protection.

**TECH-SPEC.**  

- Thai style grain leather
- Hand crafted high density padding
- Wrap around strap closure

Code	Size	Colors	MRP
609MT1	10, 12, 14 oz	Red, Blue, Black	3399/-

\* per pair



## 8002 MUAY THAI HEAD GUARD

Traditional style with extra padding to protect against kicks.

**TECH-SPEC.**  

- Top grain hide leather
- Hand crafted shock absorbent padding
- Lace closure

Code	Size	Colors	MRP
8002	S,M,L	Red, Blue, Black	3499/-

\* per pc



## 770MT MUAY THAI CHEST GUARD

For amateur Muay Thai competition & training. Thick padding for ultimate protection.

**TECH-SPEC.**  **uFEELdRi PU**

- Durable PU construction
- Traditional Thai design
- Dense shock absorbent padding

Code	Size	Colors	MRP
770MT	S,M,L	Red, Blue	2049/-

\* per pc

## 850MT MUAY THAI SHIN PADS

For amateur Muay Thai competition & training. Light padding for swift movement.

**TECH-SPEC.**  **uFEELair**

- Air mesh & rib construction
- Light weight padding
- Elasticated fit

Code	Size	Colors	MRP
850MT	S,M,L	Red, Blue	1099/-

\* per pair

## MUAY THAI GEAR

Traditional construction with bottom half covered with thick leather. Ideal for sustaining kicks. The handles help in clinch & hold training.

### 8005 THAI STYLE PUNCH BAG

- TECH-SPEC.**  
- Thick leather & matty construction
  - Heavy duty lifting strap

Code	Weight apx	Dimensions apx	MRP
8005	40 kg	107x40cm (42"x16")	9649/-

\*Chain 626SW4 included

\* per pc



### 627ET THAI FOCUS PADS

Small Target Pads for micro focus & fast movement.



- TECH-SPEC.**   
- Hide leather construction.
  - Light weight impact absorbing padding made of different combinations
  - Elasticated wrist with extra support strap
  - Compact size

Code	MRP
627ET	2349/-

\* per pair

### 627FSL THAI ARM PADS

Big pads designed for safety & light enough for quick movement. They can catch all types of strikes like punches, elbows, knees & kicks. Shock absorbing padding to reduce impact on forearms.

- TECH-SPEC.**   
- Thick leather & hide
  - leather construction
  - Handcrafted contoured padding

Code	Dimensions apx	Weight apx	MRP
627FSL	38X20X7cm 15"x8"x3"	1kg/2 Lbs each	3299/-

\* per pc



## MMA SHIN PADS

Ideal for training , to protect your shin , feet & ankles. Comfortable, light weight & durable.

### 850E2 SHIN PADS

- TECH-SPEC.**   
- Durable hide leather
  - Light weight foam padding
  - Leather/hook & loop strap closure

Code	Size	MRP
850E2	S/M, L/XL	2749/-

\* per pair



### 850MA SHIN PADS

- TECH-SPEC.**    
- PU construction
  - Light weight padding
  - Neoprene strap closure

Code	Size	MRP
850MA	S/M, L/XL	1799/-

\* per pair

# MUAY THAI APPAREL



## 410MT MUAY THAI SHORTS

### TECH-SPEC.

- Polyester satin weave fabric 200 GSM apx.
- Traditional cut & waist band

Code	Size	Colors	MRP
410MTBBK	S-XL	Blue/Black	899/-
410MTRB		Red/Blue	
410MTRBK		Red/Black	

\* per pc



## 410N MUAY THAI SHORTS

### TECH-SPEC.

- Polyester satin weave fabric 200 GSM apx.
- Short length
- Contoured side slit
- Laser cut patches with embroidery

Code	Color	Size	MRP
410N	Black/Orange	S-XL	1299/-
410NG	Black/Green		

\* per pc



## 411VT THE ORIGINAL VALE TUDO SHORTS

Minimal design & cut increases mobility & flexibility. An old school product with a high regard in this modern age.

### TECH-SPEC.

- Polyester elastane 210 GSM apx.
- Draw cord in waist

Code	Size	Colors	MRP
411VTBW	S-XL	Black/White	699/-
411VTBR		Black/Red	

\* per pc



## CONTRA MUAY THAI SHORTS

### TECH-SPEC.

Code	Size	Colors	MRP
410BC	S-XL	Brown	599/-
410GC		Green	
410CNG		Green	

# MMA APPAREL

**RASH GUARDS:** USI Universal's rash guards are primarily developed keeping mixed martial artists, BJJ practitioners & grapplers in mind. Ideal for training to protect against rashes, chafing & scrapes.

**MMA/TRAINING SHORTS:**

USI Universal has mastered this product over the years. A wide range of competition & training shorts have been developed for specific needs of the customer. Various performance materials, cuts have been incorporated for durability & comfort.



**411SL SLEEVES**

Unisex sleeves for protection during MMA, BJJ, wrestling & grappling training. Ideal UV protection from sun burn, covering of sore spots & tattoos.

**TECH-SPEC.** **IMPREX+**

- Nylon elastane fabric 210 GSM apx.
- Grip tape at top hem
- Flat seamed

\*Colours as per availability

Code	Size	MRP
411SL	S/M, L/XL	499/-

\* per pair



**411SM RASH GUARD**

**TECH-SPEC.** **IMPREX**

- Polyester elastane fabric 200 GSM apx.
- Flat seamed

Code	Size	MRP
411SM	S - XL	999/-

\* per pc



**411AEB MMA SHORTS**

**TECH-SPEC.**

- Microfiber polyester
- Soft peach finish
- Inseam & side elastane panels

Code	Size	MRP
411AEB	S-XL	1199/-

\* per pc



# MMA APPAREL



## 411R RAZOR RASH GUARD

TECH-SPEC. MPREX

- Polyester elastane construction 200 GSM apx.
- Sublimation printing
- Flat lock stitching

Code	Color	Size	MRP
411RR	Black/Red/White	S-XL	1349/-
411RRB	Black/Blue/White		

\* per pc



## G40R RAZOR COMPRESSION FIGHT SHORTS

TECH-SPEC. MPREX

- Polyester elastane construction 200 GSM apx.
- Logo elastic on waist
- Sublimation printing
- Flat lock stitching

Code	Color	Size	MRP
G40RR	Red	S-XL	1299/-
G40RB	Blue		

\* per pc



## 411V RAZOR SHORTS TUF STRETCH

TECH-SPEC. uFEELstretch

- Micro fibre polyester mechanical stretch fabric 200 GSM apx.
- Fixed waist with draw string
- Elasticated inseam panel
- Hook & loop fix & double secured waist closure
- Reinforced side slit
- Sublimation printing with embroidered waist logo
- Locker key pocket inside waist

Code	Color	Size	MRP
411VR	Red	S-XL	1899/-
411VB	Blue		

\* per pc

# MMA APPAREL



## 411UB UNBEATABLE RASH GUARD

TECH-SPEC. MPREX

- Polyester elastane construction 200 GSM apx.
- Sublimation printing
- Flat lock stitching

Code	Color	Size	MRP
411UBR	Black/Red/White	S-XL	1349/-
411UBB	Black/Blue/White		
411UBG	Black/Grey/White		

\* per pc



## 411HB UNBEATABLE SHORTS TUF STRETCH

TECH-SPEC. uFEELstretch uFEELgrip

- Micro fibre polyester mechanical stretch fabric 200 GSM apx.
- Elasticated waist with griptape
- Elasticated inseam panel
- Hook & loop fly & double secured waist closure
- Long reinforced side slit with reinforced bottom hem
- Sublimation printing with embroidered waist logo

Code	Color	Size	MRP
411HBR	Black/Red	S-XL	1999/-
411HB	Black/Grey		
411HBL	Black/Blue		

\* per pc



## G40G UNBEATABLE COMPRESSION FIGHT SHORTS

TECH-SPEC. MPREX

- Polyester elastane construction 200 GSM apx.
- Logo elastic on waist
- Sublimation printing
- Flat lock stitching

Code	Color	Size	MRP
G40G	Black/Grey	S-XL	1299/-

\* per pc

# MMA APPAREL



**411RK KOI FISH RASH GUARD**

TECH-SPEC. MPREX

- Polyester elastane construction 200 GSM apx.
- Sublimation printing
- Flat lock stitching

Code	Color	Size	MRP
411RK	Black/Red/White	S-XL	1299/-

\* per pc



**411K KOI FISH MMA SHORTS**

TECH-SPEC.

- Heavy Polyester 200 GSM apx. sublimation printed
- Fixed waist with drawcord
- Hook & loop fly & waist closure
- Short length for more range in movement
- Elasticated inseam panel
- Contoured side slits
- Reinforced at all stress points

Code	Color	Size	MRP
411K	Black/Red/White	S-XL	1799/-

\* per pc



**CXK KOI FISH COMPRESSION SHORTS**

TECH-SPEC. MPREX

- Polyester elastane construction 200 GSM apx.
- Logo elastic on waist
- Sublimation printing
- Flat lock stitching

Code	Color	Size	MRP
CXK	Black/Red/White	S-XL	1299/-

\* per pc

## MMA APPAREL



### 411RW WEREWOLF RASH GUARD

TECH-SPEC. MPREX

- Polyester elastane construction 200 GSM apx.
- Sublimation printing
- Flat lock stitching

Code	Color	Size	MRP
411RW	Black/Grey/Brown	S-XL	1349/-

\* per pc



### CXW WEREWOLF COMPRESSION SHORTS

TECH-SPEC. MPREX

- Polyester elastane construction 200 GSM apx.
- Logo elastic on waist
- Sublimation printing
- Flat lock stitching

Code	Color	Size	MRP
CXW	Black/Grey/Brown	S-XL	1299/-

\* per pc



### 411W WEREWOLF MMA SHORTS

TECH-SPEC.

- Micro fabric polyester peach finish 145 GSM apx.
- Sublimation printed
- Elasticated waist with drawcord
- Hook & loop fly & waist closure
- Elastane inseam panel
- Long side slits
- Reinforced stress points

Code	Color	Size	MRP
411W	Black/Grey/Brown	S-XL	1699/-

\* per pc

# MMA APPAREL



## 411RS SNAKE RASH GUARD

TECH-SPEC. MPREX

- Polyester elastane construction 200 GSM apx.
- Sublimation printing
- Flat lock stitching

Code	Color	Size	MRP
411RS	Black/Green/Yellow	S-XL	1299/-

\* per pc



## 411S SNAKE MMA SHORTS

TECH-SPEC.

- Micro fabric polyester peach finish 145 GSM apx.
- Sublimation printed
- Elasticated waist with drawcord
- Hook & loop fly & waist closure
- Elastane inseam panel
- Long side slits
- Reinforced stress points

Code	Color	Size	MRP
411S	Black/Green/Yellow	S-XL	1699/-

\* per pc



## CXSN SNAKE COMPRESSION SHORTS

TECH-SPEC. MPREX

- Polyester elastane construction 200 GSM apx.
- Logo elastic on waist
- Sublimation printing
- Flat lock stitching

Code	Color	Size	MRP
CXSN	Black/Green/Yellow	S-XL	1299/-

\* per pc

# MMA APPAREL



## G40CG CONTRA COMPRESSION FIGHT SHORTS

TECH-SPEC. **IMPREX**

- Polyester elastane construction 200 GSM apx
- Sublimation printing
- Flat lock stitching

Code	Color	Size	MRP
G40CG	Black/Green	S-XL	1299/-

\* per pc



## 411CN CONTRA TRAINING SHORTS

TECH-SPEC. **uFEELstretch**

- Polyester mechanical stretch fabric 200 GSM apx
- Logo elasticated waist
- Sublimated panels
- Zip pocket on front right side
- Small side slits
- Hook & loop fly closure
- Cross draw cord on waist

Code	Color	Size	MRP
411CNG	Black/Green	S-XL	1849/-
411CNR	Black/Red		
411CN	Black/Brown		

\* per pc



## 411VM DIGIT SHORTS TUFLITE

TECH-SPEC.

- Micro fibre polyester 145 GSM apx with peached finish
- Fixed waist with draw string
- Elasticated inseam panel
- Hook & loop fly & waist closure
- Sublimation printing
- Long side slits reinforced
- Triple stitch reinforced stitching

Code	Color	Size	MRP
411VMR	Red	S-XL	1699/-
411VMO	Orange		
411VMB	Blue		

\* per pc



## 411VN TRIBAL SHORTS TUFTEX

TECH-SPEC.

- Thick micro fibre polyester woven fabric 200 GSM apx
- Fixed waist anatomic curve with draw string
- Elasticated inseam panel
- Hook & loop fly & waist closure
- Contoured side slit with overlapping front & back panels
- Sublimation & embroidered cosmetics
- Triple stitch reinforced stitching

Code	Color	Size	MRP
411VNR	Black/Red	S-XL	1799/-
411VNB	Black/Blue		

\* per pc

# BRAZILIAN JIU-JITSU

USI Universal's BJJ Gis are made of 100% cotton ripstop fabric. It comes with a thick foam padded lapel. Reinforced stress points enable rough use. The pants come with a traditional drawcord tie system. Elastane inseam panel allows free leg movement.



Brazilian Jiu-Jitsu Gis are a big part of an MMA practitioner's arsenal. Be it BJJ or MMA having a strong gi adds to your grappling skills.



Fabric Texture

## 417JJ JIU JITSU GI (DRESS)

### TECH-SPEC.

- Cotton rip stop weave 450 GSM apx.
- Anatomic cut strong thread stitching
- Reinforced with tape
- Padded knee area & lapel

Code	Color	Size	MRP
417JJW	White	A0, A1, A2,	5499/-
417JJBK	Black	A3, A4	
417JJB	Blue		

\*Belt not included

\* per set

# WRESTLING SINGLET

Made of lightweight elastane fabrics with compression properties. Anatomic cuts, separate models for men & women. Flat lock stitching enables stretch & endures rough use. Reinforced neck & arm holes. Grip elastic on bottom hole prevents role up of fabric.

## 419WS UNBEATABLE WRESTLING SINGLET

TECH-SPEC. **uFEELdri** **MPREX+** **uFEELgrip**

- Nylon elastane fabric 210 GSM apx.
- Irritation free flat lock seam
- Grip elastic on bottom hole



Code	Sex	Size	Color	MRP
419WSM	Men	XS-XXL	Red,Blue	1399/-
419WSW	Women	XS-XL		

FOR XL + Rs. 100 / SIZE EXTRA \* per set



Back view

## 419W CONFERTO WRESTLING SINGLET

TECH-SPEC. **MPREX** **uFEELgrip**

- Polyester elastane construction 200 GSM apx.
- Anatomic fit
- As per UWW standards
- Grip elastic on bottom hole

Code	Sex	Size	Color	MRP
419WM	Men	XS-XXL	Red,Blue	999/-
419WW	Women	XS-XL		

\*\*FOR XL + Rs. 100 / SIZE EXTRA \* per pc



701WRB



701WBG

## 701W CONFERTO WRESTLING SHOES

USI Universal's wrestling shoes are light weighted, flexible & grip very well on the mat. A budget friendly model for beginners & novices.

TECH-SPEC. **uFEELgrip** **PJ** **Core**

- PU suede, mesh & rubber construction
- Ufeel grip rubber sole
- 5 pivot points in sole to promote mat control
- Mid cut design for flexible movement
- Embossed logos

Code	Size	Color	MRP
701WRB	5-11	Black/Red	1499/-
701WBG	5-11	Black/Grey	

\* per pair

## 615G EAR GUARD

USI Universal's ear guard helps prevent cauliflower ears. It protects the wearer from long term injury.

TECH-SPEC.

- Nylon elastane, EVA construction
- Moulded plastic ear pieces
- Adjustable at front & back



Code	Size	MRP
615G	OSFA	1099/-

\* per pc



# WRESTLING ARENAS

WRESTLING MATS COVER: Confirming to UWW & WFI standards. USI Universal's wrestling mats are made of non abrasive & non tearing vinyl coated fabric. Available in heavy (780 GSM apx.) & light (580 GSM apx) fabric. Seam sealed with heat for plain finish. Hook & loop system on edges to prevent creases.



### WRESTLING MAT COVER ONLY

#### WMC WRESTLING MAT COVER

##### TECH-SPEC.

- Strong vinyl coated fabric
- Seam sealed
- Hook & loop on edges



\*Octagon Shape available in 12x12m size only

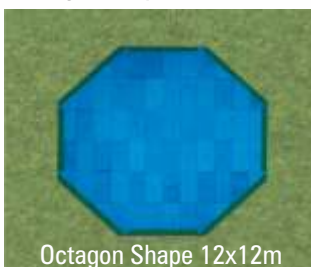

Octagon Shape 12x12m



APPROVED

Code	Area Size	GSM apx	MRP			
			12x12m	10x10m	8x8m	6x6m
WMCHT	Heavy Tricolour (Square/Octagon)	780	1,80,000/-	x	x	x
WMCLT	Light Tricolour (Square/Octagon)	580	1,50,000/-	x	x	x
WMCHS	Heavy Single Colour (Painted)	780	1,30,000/-	x	x	x
WMCLS	Light Single Colour (Painted)	580	105,000/-	78,000/-	54,000/-	x
WMCLP	Light Single Plain Colour (without Paint)	580	100,000/-	73,000/-	50,000/-	32,000/-*

\*Round circle print only

#### WM - WRESTLING MAT ONLY

Code	Arena Size		WM50	WM60	WM70
			MRP 50mm	60mm	70mm
WM	12m x 12m	72 mats	6,84,000/-	8,28,000/-	9,57,600/-
	12m x 12m (octagon)	68 mats	6,46,000/-	7,82,000/-	9,04,400/-
	10m x 10m	50 mats	4,75,000/-	5,75,000/-	6,65,000/-
	8m x 8m	32 mats	3,04,000/-	3,68,000/-	4,25,600/-
	6m x 6m	18 mats	1,71,000/-	2,07,000/-	2,39,400/-
	Single Mat (2m x 1m)			9,500/-	11,500/-

#### WM WRESTLING MATS

WRESTLING MAT FOAM: USI Universal's protective foam is made of high density EVA foam measuring 50kg/cubic meter apx. It is complimented by a hardness of 8-10 ShA. This helps the wrestlers to perform freely with less risk of injury. Available in 50mm, 60mm & 70mm thickness.

##### TECH-SPEC.



- Light weight EVA compound foam
- Edge mats pasted with loop material for fixing with cover
- Hardness: medium soft
- Size: 2m X 1m apx.

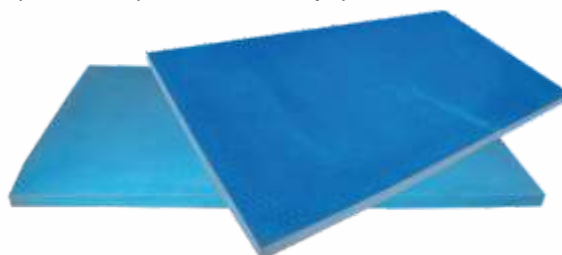

# WEIGHTLIFTING SINGLET

This garment will become your performance partner. Made of compression fabric which is lightweight, breathable & durable. Anatomic cut adds to the flexibility & comfort. Grip elastic on bottom hole prevents roll up of fabric.

## 419WT UNBEATABLE WEIGHTLIFTING SINGLET

TECH-SPEC. **MPREX+** uFEELdRi uFEELgrip

- Nylon elastane, compression fabric 210 GSM apx.
- Irritation free flat lock seam
- Anti grip thigh panel
- Grip elastic on bottom hole

Code	Sex	Size	Colors	MRP
419WTM	Men	XS-XL	Red,Blue	1399/-
419WTW	Women	XS-XL		1399/-

\*For XL+ size 100/- extra \* per pc

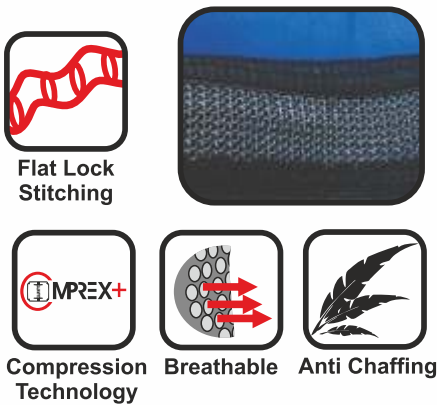

Flat lock seams reduce skin irritation

Compression Fabric 4 way stretch

Anti-grip thigh panel

Grip elastic stops suit from moving



# JUDO DRESS



## 417JB JUDO BOUNCER DRESS

USI Universal has ventured into manufacturing of Judo gis with a basic model. Ideal product for beginners & novices. Light weight fabric & traditional pattern enables you to concentrate on skill improvement.

TECH-SPEC. **MPREX+**

- Poly cotton fabric 300 GSM apx.
- Canvas weave
- Traditional Japanese pattern
- Drawcord closure in pants
- Thick lapel for holding
- Woven labels

Code	Size	MRP
417JB	24/100, 26/110, 28/120 cms	1399/-
	30/130,32/140 cms	1499/-
	34/150,36/160 cms	1549/-
	38/170, 40/180 cms	1649/-
	42/190, 44/200 cms	1699/-

\*Including White Belt

\* per set

# KARATE

USI Universal's Karate equipment confirms to the latest WKF/KIO guidelines. Products have been developed for kids/beginners as well as masters. A wide variety of fabrics & patterns have been developed for various types of karate dresses (KATA/KUMITE). Our protective equipment is designed ergonomically. It offers safety & keeps you agile.

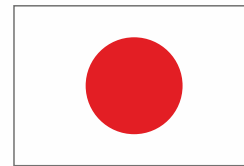

空手

APPROVED BY:



## 417KC COMFERTO KARATE GI

TECH-SPEC. **uFEELair**



- Polyester cotton blend 210 GSM apx.
- Mesh vent panels for less perspiration
- Elasticated waist band with drawstring
- Embroidered logos/woven labels

Code	Size	MRP
417KC	24/100, 26/110, 28/120 cms	1449/-
	30/130, 32/140, 34/150 cms	1599/-
	36/160, 38/170, 40/180 cms	1799/-
	42/190, 44/200 cms	1899/-

\*Belt not included

\* per set

\*Size: 100,110,120 & 130 are

WHILST STOCK LAST



## 417KCD FIGHTER KARATE DRESS

TECH-SPEC. **uFEELdRi uFEELair**

- Micro fibre polyester jacquard fabric
- Light weight 120 GSM apx.
- Ventilation areas between legs & back
- Embroidered logos/woven labels

Code	Size	MRP
417KCD	34/150 cms	1999/-
	36/160, 38/170, 40/180 cms	2299/-
	42/190, 44/200 cms	2399/-

\*Belt not included

\* per set

# KARATE



### 417KM MASTER KARATE GI

TECH-SPEC. **uFEELsoft**

- 100% cotton canvas 380 GSM apx.
- Traditional draw cord waist band
- Brushed inside for plush feel
- Embroidered logos

Code	Size	MRP
417KM	30/130, 32/140, 34/150 cms	2399/-
	36/160, 38/170, 40/180 cms	2549/-
	42/190, 44/200 cms	2749/-

\*Belt not included

\* per set

Size: 130 is



### 417NV NOVICE KARATE DRESS

TECH-SPEC.



- Twill weave polyester cotton blend 210 GSM apx.
- Basic cut
- Elasticated waist band with drawstring
- Embroidered logos/woven labels

Code	Size	MRP
417NV	24/100, 26/110, 28/120 cms	1249/-
	30/130, 32/140, 34/150 cms	1349/-
	36/160, 38/170, 40/180 cms	1499/-
	42/190, 44/200 cms	1649/-

\*Belt not included

\* per set

### 417KB BOUNCER KARATE DRESS

TECH-SPEC.



- Light weight poly cotton
- Twill weave
- Basic cut, elastic waist
- 180 GSM apx.
- Woven labels

Code	Size	MRP
417KB	24/100, 26/110, 28/120 cms	670/-
	30/130, 32/140 cms	720/-
	34/150, 36/160 cms	810/-
	38/170, 40/180 cms	890/-

\*Including White Belt

\* per set



FOR BEGINNERS

# KARATE

## 770KM MARTIAL ARTS GLOVES

TECH-SPEC. **M** PU **Performance**  
Mould Padding

- Korean PU construction
- Moulded shock absorbent padding
- Bulky mould, complete coverage of fingers
- Elastic/hook & loop closure

Code	Color	MRP
770KM	Red (AKA), Blue (AO)	799/-

\* per pair



## KM1 MARTIAL ARTS GLOVES

TECH-SPEC. **M** PU **Core**  
Mould Padding

- Korean PU construction
- Moulded shock absorbent padding
- Compact & thin mould
- Elastic/hook & loop closure

Code	Color	MRP
KM1	Red (AKA), Blue (AO)	699/-

\* per pair



## 770WKC COMPETITION CHEST GUARD

TECH-SPEC. **PU SALT** **Performance**

- Thick PU construction
- Lightweight padding
- Elasticated back closure

Code	Size	MRP
770WKC	XS,S,M,L	1599/-

\* per pc



## 770F FEMALE CHEST GUARD

TECH-SPEC. **uFEELstretch** **uFEELdri** **Performance**

- Polyester elastane construction 200 GSM apx.
- Plastic shell insert
- Elasticated hem

Code	Size	MRP
770F	S,M,L	1299/-

\* per pc



# TAEKWONDO

USI Universal's Taekwondo equipment confirms to the latest WT & TFI standards. In line with Korean traditions, all fabrics & materials have been used to keep the originality of this martial art. As the protective equipment is being modernized, we have also upgraded our products for better safety & performance.



APPROVED BY:



TAEKWONDO  
FEDERATION  
OF INDIA



### 417TC KYORUGI (FIGHT)

TECH-SPEC. **uFEELair**  

- Polyester cotton blend 210 GSM apx.
- Traditional rib weave
- Mesh vents for less perspiration
- Elasticated waist band with drawstring
- Embroidered logos & woven labels

Code	Size	MRP
417TC	24/100, 26/110, 28/120 cms	1399/-
	30/130, 32/140, 34/150 cms	1499/-
	36/160, 38/170, 40/180 cms	1649/-
	42/190, 44/200 cms	1800/-

\*Belt not included \* per set

\*Size: 100,110,120 & 130 are 



### 417TCD TAEKWONDO FIGHTER DRESS

TECH-SPEC. **uFEELdRi** **uFEELair**  

- Micro fibre polyester jacquard fabric
- Light weight 120 GSM apx.
- Ventilation areas between legs & back
- Embroidered logos & woven labels

Code	Size	MRP
417TCD	34/150 cms	1999/-
	36/160, 38/170, 40/180 cms	2199/-
	42/190, 44/200 cms	2399/-

\*Belt not included \* per set

# TAEKWONDO



## 417TNV NOVICE TAEKWONDO DRESS

TECH-SPEC.



- Lightweight polyester cotton blend 190 GSM apx.
- Traditional rib weave
- Elasticated waist band with drawstring
- Embroidered & printed logos/woven labels

Code	Size	MRP
417TNV	24/100, 26/110, 28/120 cms	1199/-
	30/130, 32/140, 34/150 cms	1299/-
	36/160, 38/170, 40/180 cms	1449/-
	42/190, 44/200 cms	1649/-

\*Belt not included

\* per set



## 417PM POOMSAE (DEMO)

TECH-SPEC.



- Lightweight polyester cotton blend 190 GSM apx.
- Traditional rib weave
- Pants made of micro fibre polyester peach finish 145 GSM apx.
- Elasticated waist band with drawstring
- Embroidered logos

Code	Size	MRP
417PM	32/140, 34/150 cms	1390/-
	36/160, 38/170, 40/180 cms	1600/-
	42/190, 44/200 cms	1800/-

\*Belt not included

\* per set

## 417TB BOUNCER TAEKWONDO DRESS

TECH-SPEC.



- Light weight poly cotton
- Twill weave
- Basic cut, elastic waist
- 180 GSM apx.
- Woven labels & printed logos

Code	Size	MRP
417TB	24/100, 26/110, 28/120 cms	720/-
	30/130, 32/140 cms	790/-
	34/150, 36/160 cms	870/-
	38/170, 40/180 cms	940/-

\*Including White Belt

\* per set



# TAEKWONDO



### 770K KOREAN CHEST GUARD

TECH-SPEC. **PU**

- PU/PVC construction
- Korean style
- High density foam padding
- Padded shoulder
- Reversible

Code	Size	MRP
770K	XS,S,M,L	1649/-

\* per pc

### 770C CHEST GUARD

TECH-SPEC. **PU**

- PU/PVC construction
- High density foam padding
- Padded shoulders
- Reversible

Code	Size	MRP
770C	XS,S,M,L	1749/-

\* per pc

### 770TG TAEKWONDO GLOVES

TECH-SPEC. **uFEELflex uFEELdRi**

- PU/Elastic fabric construction
- Soft padded
- Grip bar for making fist
- Sweat wicking thumb fabric
- Elastic tab closure



Code	Size	MRP
770TG	S/M, L/XL	949/-

\* per pair

### 770FP FOOT PROTECTOR

TECH-SPEC. **uFEELdRi uFEELflex**

- PU/Elastic fabric construction
- Soft padded
- Wrap around neoprene closure



Code	Size	MRP
770FP	S/M, L/XL	1099/-

\* per pair





# WUSHU

USI Universal's products confirm to IWUF standards & approved by Wushu Association of India. We offer a complete range of SANSHOU competition & training equipment/apparel.



APPROVED



## 609WU SANDA GLOVES (SANSHOU)



- Top grain hide leather
- Moulded shock absorbent foam padding
- Wrap around hook & loop strap

Code	Size	Colors	MRP
609WU	8,10 oz	Red,Blue	3099/-

\* per pair

## 615CG SANDA HEADGUARD (SANSHOU)

This is a lightweight headguard protecting all the vulnerable portions of a boxer's head, it does not constrict your vision. It becomes a part of your body making you feel that you are not wearing anything on your head.



- Durable hide leather
- Multiple layers of padding for greater shock absorbing
- Adjustable web closure at top
- Adjustable strap at back for firm grip
- Cushioned back

Code	Size	Colors	MRP
615CG	S,M,L	Red,Blue	2849/-

\* per pc



## 770WU WUSHU CHEST GUARD



- Durable PU construction
- Dense padding
- Elasticated strap
- Reversible

Code	Size	Colors	MRP
770WU	S,M,L	Red/Blue	1999/-

\* per pc



## 409WU WUSHU DRESS



- Polyester bright mesh fabric 150 GSM apx.
- 75mm/3" waist band
- Tapered shorts for easy leg movement
- Unisex

Code	Size	Colors	MRP
409WU	36-44	Red,Blue	900/-

\* per set



Breathable



Moisture Wicking

# WUSHU SANDA PLATFORM

USI Universal sanda platform complies with IWUF guidelines. Our raised structure is padded with high density foam & covered on all sides with foam crash mats for protection of the fighters. The platform surface is covered with a non tear, seamless cover which helps fighters to grip their feet during the bouts.

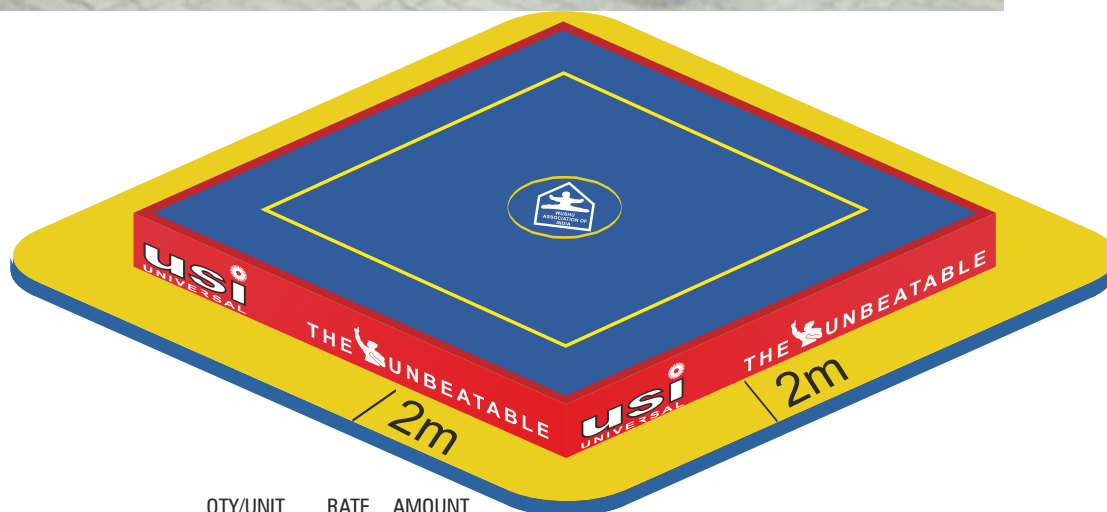

CODE	DESCRIPTION	QTY/UNIT	RATE	AMOUNT
RSK	RING SKIRT	1 PCS	13,299	13,299
WM50	RING PADDING 50MM (32MATS)	1 SET	3,04,000	3,04,000
RCN	BOXING TARPULIN COVER NYLON 26.1/2X26.1/2	1 PCS	48,000	48,000
RMS	RING METAL STRUCTURE PART	1 SET	3,89,801	3,89,801
RPS	RING PLATFORM STRUCTURE	1 SET	1,34,000	1,34,000
RFS	FORM STRIPS	1 SET	9,400	9,400
SBA	SPITTOON & BUCKET ASSEMBLY	1 SET	3,000	3,000
RS	RING STOOL	2 PCS	2,000	4,000
RWA	WIRE ASSEMBLY	2 SET	4,000	8,000
WSFC	FOAM CUSHION FOR SIDES (2MTR X 30CM X 10MTR)	4 PCS	66,125	2,64,500
	<b>TOTAL</b>			<b>11,78,000</b>

### Wushu Platform Structure

Heavy gauge box steel construction powder coated & colour coded

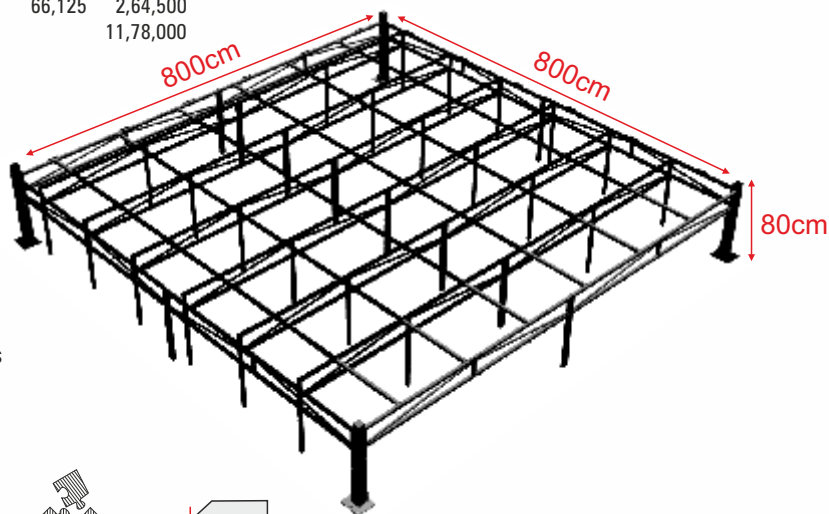

**MRP 11,78,000/-**  
**WUSHU SANDA PLATFORM**



- Metal, wood, foam & PVC construction
- Mig welded & powder coated
- Drop fit system for quick assembly
- Light weight EVA compound foam mats with medium soft hardness
- Non tear, seamless cover
- Platform covered on sides by vinyl skirts
- Foam crash mats on all sides
- Complete with stools x 2
- Spittoon & buckets x 2
- Platform dimensions: 8m x 8m x 0.8m (26' x 26' x 2.5') apx
- Foam crashmats: 2m x 10m x 0.30m x 4 sides (6.5' x 33' x 1') apx

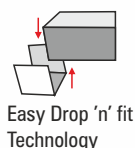

# MARTIAL ARTS PROTECTION



## 616D MARTIAL ART HEAD GUARD

TECH-SPEC. Performance

- Dip foam construction
- Full skull protection

Code	Size	Color	MRP
616D	S,M,L	Red, Blue, White	2999/-

\* per pc



## 616APUT MARTIAL ART HEAD GUARD

TECH-SPEC. Base **SALT**

- PU/PVC construction
- Hand made shock absorbent padding
- Padding on top

Code	Size	Color	MRP
616APUT	S,M,L	Red, Blue, White	899/-

\* per pc



## 851A ARM GUARD

TECH-SPEC. Advance **PU**

- Durable PU construction
- Soft handcrafted padding

Code	Size	MRP
851A	S/M,L/XL	899/-

\* per pair



## 770DS MARTIAL ARTS GLOVES

TECH-SPEC. Advance

- Dip foam construction
- Elastic / hook & loop closure

Code	Size	Color	MRP
770DS	S,M,L	Red, Blue	2799/-

\* per pair



## 770DL MARTIAL ARTS GLOVES

TECH-SPEC. Advance

- Dip foam construction
- Wrist support
- Elastic/hook & loop closure

Code	Size	Color	MRP
770DL	S,M,L	Red, Blue	2899/-

\* per pair



## 851AE ARM GUARD WITH ELBOW

TECH-SPEC. Performance **PU**

- Durable PU construction
- Soft handcrafted padding
- Elbow protection

Code	Size	MRP
851AE	S/M,L/XL	1049/-

\* per pair



## 629 GROIN GUARD

TECH-SPEC. Core **PU**

- Thick PU construction
- Broad elastic with hook & loop adjustment at back

Code	Size	MRP
629PU	Men S/M, L/XL	799/-
629LPU	Women S/M, L/XL	749/-

\* per pc



# MARTIAL ARTS PROTECTION



### 851D SHIN PADS

TECH-SPEC. 

- Dip foam construction
- Elastic/hook & loop closure

Code	Size	Color	MRP
851D	S,M,L	Red, Blue	2799/-

\* per pair



### 850D SHIN PADS WITH INSTEP

TECH-SPEC. 

- Dip foam construction
- Elastic/hook & loop closure

Code	Size	Color	MRP
850D	S,M,L	Red, Blue	2999/-

\* per pair

### 851PU MOULDED SHIN PADS WITH INSTEP

TECH-SPEC.  

- Durable PU construction
- Moulded foam padding
- Dense handcrafted padding

Code	Size	Color	MRP
851PU	S/M,L/XL	Red, Blue	2099/-

\* per pair

### 850 SHIN PADS WITH INSTEP

TECH-SPEC.  

- Korean PU construction
- EVA foam padding
- Elastic/hook & loop closure

Code	Size	Color	MRP
850	S,M,L	Red, Blue, White	1049/-

\* per pair



### 851 SHIN PADS

TECH-SPEC.  

- PU construction
- EVA foam padding
- Elastic hook & loop closure

Code	Size	Color	MRP
851	S,M,L	Red, Blue, White	949/-

\* per pair

### 770BD MARTIAL ARTS BOOTS

TECH-SPEC. 

- Dip foam construction
- Elastic/hook & loop closure

Code	Size	Color	MRP
770BD	S,M,L	Red, Blue	2999/-

\* per pair



### 701M MARTIAL ART SHOES

USI Universal's Martial Art shoes come with an ideal form & fit. Lightweight & flexible. Our shoes give you a bare foot experience as far as comfort is concerned. The flat rubber sole allows swift movement on various surfaces.

TECH-SPEC.   

- PU foam & rubber construction
- Ufeel grip rubber sole
- 4 pivot point for maximum control
- Side lace system for clear kick surface
- Cushioned upper & ankle area
- Embossed logos

Code	Color	Size	MRP
701MA	White/Black	5-11	1299/-
701MB	Black/White		

\* per pair



# TRAINING



### 627IR IRANI PAD

As the Iranian's have perfected this Korean sport, their innovation has become an important training tool in kick training.

**TECH-SPEC.**

- Full grain leather construction
- Dense shock absorbent padding
- Contoured edges
- Curved shape
- 3 handles

Code	Size apx	MRP
627IR	40x23x10cm (16"x9"x4")	3199/-

\* per pc



### 862NC FOAM CHAKU

**TECH-SPEC.**

- Foam construction
- Ball bearing swivel chain and cap system
- Colours : Red/Black, Yellow/Black

Code	Size	MRP
862NC8	20 cm (8")	899/-
862NC10	30 cm (12")	999/-

\* per pc



### KN RUBBER KNIFE

**TECH-SPEC.**

- Soft rubber material
- Ideal for training against real knife attacks

Code	Size	MRP
KN	25 cm (10")	249/-

\* per pc



### 627JS IMMORTAL JAB STICKS

**TECH-SPEC.**

- Leather construction
- Moulded foam tube
- Excellent coaching tool for boxing & MMA

Code	Color	MRP
627JS	Black	1649/-

\* per pair



### 627PD IMMORTAL TARGET PADDLES

**TECH-SPEC.**

- Leather construction
- Hand crafted dense padding
- Excellent coaching tool for boxing & MMA

Code	Color	MRP
627PD	Red/Black	1999/-

\* per pair



### 627HPUD DOUBLE FAN PAD

**TECH-SPEC.**

- PU/PVC construction
- Rigid EVA padding for clap sound
- Grooved handle

Code	MRP
627HPUD	1049/-

\* per pc

### 627HPU SINGLE FAN PAD

**TECH-SPEC.**

- PU construction
- Rigid EVA padding
- Grooved handle

Code	MRP
627HPU	899/-

\* per pc



# BELTS

USI Universal belts have been designed to honor your achievements to make you feel special for the hardwork you have done to gain the success.



### 417BC COLOURED BELTS

- TECH-SPEC.**  Performance
- Poly cotton fabric 210 GSM apx
  - Strong web tape insert
  - 7 precise stitchings
  - Colours : White, Yellow, Orange, Green, Red, Purple, Blue, Brown

Code	Size	MRP
417BC	240, 280cm	299/-

\* per pc

# CUSTOM MADE

**CUSTOM LOGOS ALSO POSSIBLE AT EXTRA COST.**

Please allow 2 weeks for custom embroideries after finalisation of design and receipt of advance deposit .

### 417B BLACK BELTS

- TECH-SPEC.**  Core
- Silk look poly satin construction 200 GSM spx
  - Strong web tape insert
  - 10+ stitchings
  - Colors: black

Code	Size	MRP
417B	280,300cm	449/-

\* per pc

Taekwondo



### 417BTK BLACK BELT

Code	MRP
417BTK	499/-

\* per pc

Karate



### 417BK BLACK BELT

Code	MRP
417BK	499/-

\* per pc

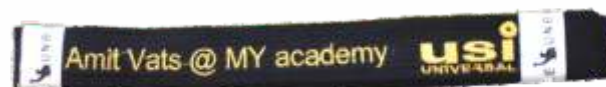
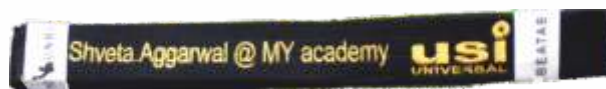

## FITNESS GLOVES

USI Universal's fitness gloves are known to be technically sound. These are an essential part of your kit as they help you workout better. Our team of craftsmen constantly update materials & fitting to meet the needs of our customers. We also make sure that our products keep you in fashion.

### 733RX PRO PERFECT

TECH-SPEC. 

- Soft & supple grain leather
- Stretch fabric lining
- Pull tabs for easy removal
- Reinforced critical portions of palm
- Wrap around leather strap for wrist support

Code	Size	MRP
733RX	S/M, L/XL	1499/-

\* per pair



### 733GR SUPERFLEX

TECH-SPEC.  uFEELair

- Soft & supple grain leather
- Stretch fabric back of palm for snug fit
- Pull tabs for easy removal
- Padded palm zones on impact areas
- Perforated palm
- Wrap around leather strap for wrist support

Code	Size	MRP
733GR	S/M, L/ XL	799/-

\* per pair



### 733CNT FITNESS GLOVES

TECH-SPEC. 

- Top grain hide leather
- Double stitched palm
- Reinforced leather thumb
- 2" wide towel elastic double
- Wrist wrap around

Code	Size	MRP
733CNT	S,M,L,XL	749/-

\* per pair



### 733GG FITNESS GLOVES

TECH-SPEC. 

- Leather/stretch fabric construction
- Neoprene rubber padding
- Elastic/hook & loop wrist

Code	Size	MRP
733GG	S, M, L, XL	649/-

\* per pair



# FITNESS GLOVES

## 733AP FITNESS GLOVES

TECH -SPEC.



- Leather/stretch fabric construction
- Foam padding
- Double wrap around wrist
- Double stitched palm

Code	Size	MRP
733AP	S, M, L, XL	599/-

\* per pair



## 733L ALL LEATHER TRAINERS

TECH -SPEC.



- Light leather construction
- Elasticated hook & loop tab closure
- Reinforced leather palm

Code	Size	MRP
733L	S, M, L, XL	580/-

\* per pair



## 732E EVERSAFE GLOVES

TECH -SPEC.



- Leather/nylon mesh construction
- Nylon mesh back for air ventilation
- Broad elasticated wrist
- Hook & loop tab closure

Code	Size	MRP
732E	S, M, L, XL	499/-

\* per pair



## 734 CONFERTO GLOVES

TECH -SPEC.



- Leather / fabric construction
- Double reinforced palm

Code	Size	MRP
734	S, M, L, XL	420/-

\* per pair





## FITNESS GLOVES

### 733BR BOUNCER FITNESS GLOVES

#### TECH-SPEC.

- Polyester, elastane & foam construction
- Padded palm
- Light duty gloves
- Digital printed back palm
- Washable

Code	Colors	Size	MRP
733BRR	Red	S-XL	299/-
733BRB	Blue		
733BRG	Green		

\* per pair



### 733NV NOVICE FITNESS GLOVES

#### TECH-SPEC.

- PVC, polyester, elastane & foam construction
- Padded palm
- Light duty gloves

Code	Colors	Size	MRP
733NVR	Red/Black	S-XL	349/-
733NVB	Blue/Black		

\* per pair



### 7330 ORIGIN FITNESS GLOVES

#### TECH-SPEC.

- Microfiber, Polyester, Elastane & foam construction
- Padded palm
- Silicon tab closure
- Sweat wicking towel on thumb
- Easy remove pull tabs
- Washable

Code	Colors	Size	MRP
7330B	Black	S-XL	399/-
7330N	Navy		
7330G	Grey		
7330R	Red		

\* per pair



### 733AS ASSAULT FITNESS GLOVES

#### TECH-SPEC.

- Microfiber, Polyester, Elastane & foam construction
- Padded palm
- Silicon tab closure
- Sweat wicking towel on thumb
- Easy remove pull tabs
- Mesh back of palm for ventilation
- Washable

Code	Colors	Size	MRP
733ASG	Grey	S-XL	449/-
733ASB	Black		

\* per pair



## FITNESS GLOVES

### 733I ICON FITNESS GLOVES

**TECH-SPEC.**

- Microfiber, Polyester, Elastane & foam construction
- Padded palm
- Silicon tab closure
- Sweat wicking towel on thumb
- Easy remove pull tabs
- Washable

Code	Colors	Size	MRP
733IBL	Blue	S-XL	499/-
733IM	Mehroon		
733IG	Grey		

\* per pair



### 733A AMBUSH FITNESS GLOVES

**TECH-SPEC.**

- Leather, polyester, elastane, neoprene & foam construction
- Suede leather palm
- Foam cushioned palm
- Silicon tab closure

Code	Colors	Size	MRP
733ABK	Black	S-XL	549/-
733AN	Navy		
733AG	Grey		

\* per pair



### 733ST STEALTH FITNESS GLOVES

**TECH-SPEC.**

- Leather, polyester, elastane, neoprene & foam construction
- Textured leather palm (double layered)
- Elasticated towel wrap around wrist
- Easy remove pull tabs
- Embossed back of fingers for anatomic fit

Code	Colors	Size	MRP
733STB	Black	S-XL	599/-
733STG	Grey		

\* per pair



### 733CB CONTRA FITNESS GLOVES

**TECH-SPEC.**

- Microfiber, Polyester, Elastane & foam construction
- Padded palm
- Elasticated wrap around wrist
- Sweat wicking towel on thumb
- Easy remove pull tabs
- Digital printed back palm
- Washable

Code	Colors	Size	MRP
733CBL	Blue	S-XL	649/-
733CBR	Brown		

\* per pair



## FITNESS GLOVES

### 733F FIGHTER FITNESS GLOVES

#### TECH-SPEC.

- Leather, polyester, elastane & foam construction
- Jacquard camo fabric back
- High density foam padding
- Easy remove pull tabs
- Sweat wicking towel on thumb
- Wrap around wrist strap

Code	Colors	Size	MRP
733FN	Navy	S-XL	749/-
733FGY	Grey	S-XL	

\* per pair



### 733UB UNBEATABLE FITNESS GLOVES

#### TECH-SPEC.

- Leather, polyester, elastane, neoprene & foam construction
- Textured leather palm (double layered)
- Elasticated towel wrap around wrist
- Easy remove pull tabs
- Embossed back of fingers for anatomic fit

Code	Colors	Size	MRP
733UBY	Black/Yellow	S-XL	799/-
733UBG	Black/Grey		

\* per pair



### 733M MONARCH FITNESS GLOVES LADIES

#### TECH-SPEC.

- Microfiber, Polyester, Elastane, Neoprene & foam construction
- Padded palm
- Easy remove pull tabs
- Honeycomb fabric on back palm

Code	Colors	Size	MRP
733MPK	Black/Pink	S/M-L/XL	499/-
733MPR	Black/Purple		

\* per pair



### 733Q QUEEN FITNESS GLOVES LADIES

#### TECH-SPEC.

- Microfiber, Polyester, Elastane & foam construction
- Padded palm
- Contoured wrist strap
- Sweat wicking towel on thumb
- Easy remove pull tabs
- Washable

Code	Colors	Size	MRP
733QB	Grey/Ice Blue	S/M-L/XL	549/-
733QPK	Grey/Pink		

\* per pair



## LIFTING GRIPS

USI Universal's grip pads are a minimal design product. Super comfortable & functional at the same time. We have concentrated on grip & cushioning. There is a lot of room to breathe in comparison to traditional gloves. There will be less hand fatigue & you will be able to workout better. An ideal replacement for sweaty gloves.



### 733GPK COMFORTO GRIP PADS MOULDED

TECH-SPEC. uFEELgrip

- Silicon rubber & fabric construction.
- Easy four finger insert design.
- Anti slip surface.
- Cushioned for comfort.

Code	Size	MRP
733GPK	OSFA	499/-

\* per pair



### 733GP GRIP PADS

TECH-SPEC. uFEELgrip+

- Shark skin texture SBR rubber
- Firm grip for bars
- Padded wrap around wrist closure

Code	Size	MRP
733GP	OSFA	599/-

\* per pair

### 733GPL LEATHER GRIP PADS

TECH-SPEC.

- Suede Leather palm material with finger holes
- Tough nylon coated material
- Hook & loop strap

Code	Size	MRP
733GPL	OSFA	800/-

\* per pair



### 733VG NEW GRIP LARGE BLACK

TECH-SPEC.

Code	Size	MRP
733VG	S,M,L	399/-

\* per pair



### 735 LIFTING GRIPS

TECH-SPEC.

- Thermo plastic rubber
- Etched surface
- Soft grip reduces blisters

Code	MRP
735	199/-

\* per pair



### 733GC GYM CHALK

USI Universal's gym chalk is made of a superior magnesium carbonate formula which promotes a firm & reliable grip. It will keep your hands dry without caking on contact.

TECH-SPEC.

- High performance magnesium carbonate formula
- For extreme gripping & hold
- Keeps hands sweat free
- Contains 8 pcs (2 oz. each) per pack

Code	Pcs	MRP
733GC	8 pcs	1449/-

\* per pack



### 733G BIG GRIPS

USI Universal's big grips help with grip strength & forearm development. This in turn increases the activation of the biceps & triceps. Our big grips will help you keep a proper balance. This will help reduce injuries.

TECH-SPEC.

- Soft polymer construction
- Thick texture on surface
- Ideal for forearm development

Code	MRP
733G	699/-

\* per pair

# LIFTING BELTS/AIDS

USI Universal's belts offer stability & support during lifts. Our belts will help relieve the stress on lower back during heavy lifts. USI Universal's belts also help maintain the correct posture during lifts.



## 790PLH POWER LIFTING BELT - HEAVY

**TECH -SPEC.** 

- Suede leather & metal construction.
- Layered leather construction.
- Dual stitched heavy duty nylon thread.
- Double pronged zinc plated steel buckle, rivetted
- Thickness apx: 10mm
- Width apx : 10 cm/4"

Code	Size	MRP
790PLH	S, M, L, XL	2599/-

\* per pc



## CONTRA POWER LIFTING BELT

**TECH -SPEC.**

Code	Size	MRP
790CPL	LIGHT	1999/-
790CPH	HEAVY	2799/-

\* per pc



## 790PL POWER LIFTING BELT - LIGHT

**TECH -SPEC.** 

- Suede leather & metal construction.
- Layered leather construction.
- Dual stitched heavy duty nylon thread.
- Double pronged zinc plated steel buckle, rivetted
- Thickness apx: 6mm
- Width apx : 10 cm/4"

Code	Size	MRP
790PL	S, M, L, XL	1799/-

\* per pc



## CONTRA WEIGHT LIFTING BELT

**TECH -SPEC.**

Code	Size	MRP
790CSL4	S, M, L, XL	1399/-
790CSL6		1599/-

\* per pc

COMPARISON CHART	
790PL	790PLH
LIGHTER MODEL	HEAVIER MODEL
MORE COMFORTABLE	MORE FIRM
SOFTER & THINNER	RIGID
MORE ACCUSTOMED	THICKER
THICKNESS: 6mm apx	THICKNESS: 10mm apx
MRP 1799/-	MRP 2599/-

# POWER LIFTING BELTS

## 790LEV LEVER POWER BELT

A cut above the regular, superior lock system enables to get in and out quickly and comfortably. Easy adjustment of size by removing 2 screws on the lever lock. Soft non slip suede leather provides maximum support.

**TECH-SPEC.**  

- Suede leather & metal construction
- Layered leather construction
- Stitched with heavy duty nylon thread
- Adjustable lever lock made of stainless steel, bolted
- Thickness apx: 11mm
- Width apx : 10cm/4"

Code	Size	MRP
790LEV	S,M,L,XL	3999/-

\* per pc



## SPARE LEVER LOCK

Code	MRP
SPLEV	1999/-

\* per pc



# TIRANGA POWER BELT



Size: **Small** (Fits waist size: 75cm - 98cm)

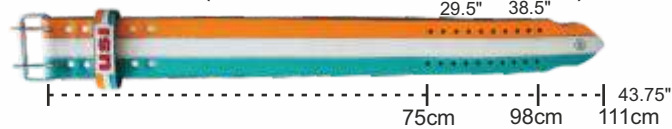

Size: **Medium** (Fits waist size: 84cm - 108cm)

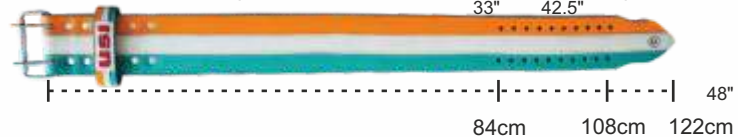

Size: **Large** (Fits waist size: 94cm - 118cm)

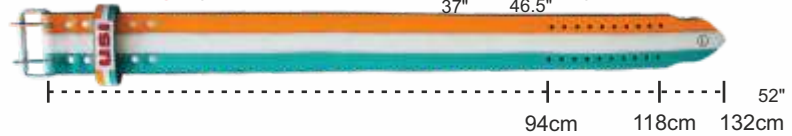

Size: **XL** (Fits waist size: 104cm - 128cm)

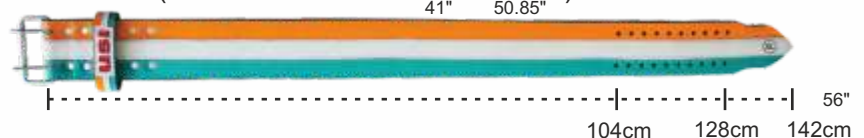

## 790PLHT TIRANGA POWER BELT

**TECH-SPEC.**    

- Layered leather construction
- Non slip suede leather inner side
- Dual stitched heavy duty nylon thread
- Durable shape which does not fold
- Double pronged zinc plated steel buckle
- Thickness: 10 mm apx.
- Width: 100 mm/4" apx.

Code	Size	Color	MRP
790PLHT	S, M, L, XL	Orange + White + Green	3499/-

\* per pc

# WEIGHT LIFTING BELTS



## 790SL6 WEIGHT LIFTING BELT

**TECH -SPEC.**



- Leather & metal construction
- Suede leather lining for comfort & grip
- Padded back for cushion
- Heavy duty nylon thread stitching
- Double pronged zinc plated buckle, rivetted
- Contoured shape to fit on waist
- Width at back : 15 cm/6" apx.

Code	Size	Width	MRP
790SL6	S, M, L, XL	15 cm(6")	1399/-

\* per pc



## 790P UNPADDED WEIGHT LIFTING BELT

**TECH -SPEC.**



- Grain leather & metal construction
- Suede leather lining for comfort & grip
- Heavy duty nylon thread stitching
- Double pronged zinc plated buckle, rivetted
- Width at back : 10cm/4" apx.

Code	Size	Width	MRP
790P	S, M, L, XL	10cm(4")	1499/-

\* per pc

## 790TT TUMMY TRIMMER BELT

USI Universal's tummy trimmer belt is a unisex product ideal for fitness enthusiasts & those with post operative medical need. It is made of a soft & flexible neoprene material which is washable. It helps reduce & shape the waistline. Body builders can use this product to flatten the abdomen & control the gut size. Our tummy trimmer can help define the curves. The thermogenic effect due to sweat helps to accelerate the metabolism. This belt helps to improve your posture & supports the lower back. USI Universal's tummy trimmer helps in compressing the abdominal muscles in post operative cases like pregnancy & hernia.



**TECH -SPEC.**



uFEELflex uFEELwarm uFEELtherapy

- Neoprene construction with zig zag stitching.
- Triple secure hook & loop closure.
- Improves thermogenic activity due to sweat during workout.
- Reduces waistline & improves posture.
- Supports abdominal muscles in post operative/delivery cases.
- Size: fits waist (around navel) apx 70cm-122cm, 28"-48"

Code	Size	MRP
790TT	S/M	649/-
	L/XL	749/-

\* per pc



## 790SL4 WEIGHT LIFTING BELT

**TECH -SPEC.**



- Leather & metal construction
- Suede leather lining for comfort & grip
- Padded back for cushion
- Heavy duty nylon thread stitching.
- Double pronged zinc plated buckle, rivetted
- Contoured shape to fit on waist
- Width at back : 10 cm/4" apx.

Code	Size	Width	MRP
790SL4	S, M, L, XL	10cm(4")	1199/-

\* per pc

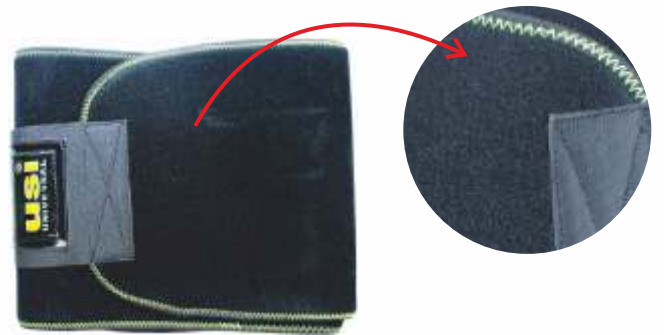

## 790TTN SUPER SWEAT TUMMY TRIMMER BELT

USI Universal's Super Sweat belt will become your best training aid if you are looking to improve your waistline . The magic is in the neoprene material used for this product , makes it much superior to our regular tummy trimmer . The neoprene is thicker and softer which forbids it from folding. USI Universal's super sweat belt has a massive size adjustment because of the plush outer surface , it is used for sticking on to the hook tab closure, The textured inner surface which touches the skin gives a very firm grip. It helps produce more sweat during workout . USI Universal's belt helps maintain a good hygiene by enabling you to wash your belt with a mild detergent(hand wash with cold water ).

**TECH -SPEC.**



uFEELflex uFEELgrip uFEELwarm+



- Thick Neoprene construction with zig zag stitching
- Large tab hook closure which sticks with the plush surface of the belt
- Textured ufeelgrip inner surface for firm grip around the tummy
- Available in different lengths and widths as per user requirement
- Superior thermogenic activity due to excessive sweat during workout
- Reduces waistline & improves posture

Code	Size	Dimensions	FitsWaist	MRP
790TTN	S/M	100cm x 20cm 40" x 8"	70cm x 122cm 28" x 48"	1299/-
	L/XL	112cm x 25cm 44" x 10"	70cm x 137cm 28" x 54"	1899/-

\* per pc

## WEIGHT LIFTING BELTS



### 790NK FITNESS LUMBER BELT

TECH -SPEC.



- Poly mesh EVA foam & plastic construction
- Back pad for added support
- Soft wick dry fabric lining
- Lumber support injection moulded
- Webbing hook & loop strap closure

Code	Size	MRP
790NK	S, M, L, XL	999/-

\* per pc



### 790WT WAIST TAPER BELT

TECH-SPEC.

Code	MRP
790WT	999/-

\* per



### 790NV NYLON WEIGHT LIFTING BELT

TECH -SPEC.



- 14cm (5.5") fabric laminated EVA construction
- Nylon tape/hook & loop strap closure

Code	Size	MRP
790NV	S, M, L, XL	899/-

\* per pc

## DIP BELTS / ATTACHMENT

USI Universal's dip belts help you build your upper body strength. The dip movement performed with the correct posture can help build your chest, shoulders & triceps. As a result your arms also get developed using this product. Our belts can be used for belt squat & sled pull also.

### DPN NYLON DIP BELT

TECH-SPEC.



- Heavy duty nylon construction
- Contoured shape to fit around waist
- Washable
- Nylon thread stitching.
- Chain with snap hook to add weight.
- Weight capacity (Dips): 60Kg/135Lbs
- Weight capacity (Sled Pulls): 250Kg/550Lbs apx

Code	Size	MRP.
DPN	OSFA	1699/-

\* per pc



### LDS LEATHER DIPPING STRAP

TECH-SPEC.



- Leather construction
- Ideal attachment for weight lifting
- Weight capacity: 30Kg/70Lbs apx

Code	Color	MRP
LDS	Tan,Black	549/-

\* per pc



### 790DP UNPADDED LEATHER BELT

TECH -SPEC.



- Leather & metal construction
- Suede leather lining for comfort & grip
- Nylon thread stitching
- Chain with snap hook to add weight
- Weight capacity (dips): 40Kg/90Lbs
- Weight capacity (sled pulls): 200Kg/440Lbs apx

Code	Size	Padding	MRP
790DP	OSFA	15.25cm (6")	1549/-

\* per pc





# KNEE SLEEVES

## SUPPORT FOR FITNESS, CROSS TRAINING & KNEE INJURY

This unisex knee sleeve will become a part of your body. It provides full range of motion, mental / physical safety, better performance, fast recovery & stability. The extra thick material helps to maintain ideal temperature. The warmth makes the muscles ready to perform. Strong compression with extra support and super stability, anatomic shape. It is very useful for beginners, intermediates & professionals. From experts of design & manufacturing to make the right choice, so that you can stay the unbeatable...

KS7 ▶



KS5 ▶



### TECH-SPEC.

- Neoprene, SBR & polyester construction
- Anatomic construction cut to fit around
- Edge free sewing for user comfort
- Ideal for injury prevention/rehab

Code	Thickness	Color	Size	MRP
KS7	7 mm	Red/Black	XS-XL	1399/-
KS5	5 mm	Camo	XS-XL	1199/-

\* per pc



<b>DNA</b>	<b>KS7</b>
uFEELsafe+ uFEELcontrol+ uFEELstable+ uFEELwarm+ uFEELsoft	Performance  Unisex 
<b>DNA</b>	<b>KS5</b>
uFEELsafe uFEELcontrol uFEELstable uFEELwarm uFEELsoft+	Advance  Unisex 



\* Attractive Packaging (1 pc each)

Anatomic construction →



# ELBOW SLEEVES

**SUPPORT FOR WEIGHTLIFTING, POWER LIFTING, CROSS TRAINING, TENDINITIS & ELBOW PAIN**

This unisex elbow sleeve will become a part of your body. It provides full range of motion, mental / physical safety, better performance, fast recovery & stability. The extra thick material helps to maintain ideal temperature. The warmth makes the muscles ready to perform. Strong compression with extra support and super stability, anatomic shape. It is very useful for beginners, intermediates & professionals.

ES5 ▶



ES3 ▶



**TECH-SPEC.**

- Neoprene, SBR & polyester construction
- Anatomic construction cut to fit around
- Edge free sewing for user comfort
- Ideal for injury prevention/rehab

Code	Thickness	Color	Size	MRP
ES5	5 mm	Red/Black	XS-XL	999/-
ES3	3 mm	Camo	XS-XL	899/-

\* per pc



<b>DNA</b>	<b>ES5</b>
uFEELsafe+ uFEELcontrol+ uFEELstable+ uFEELwarm+ uFEELsoft	Performance  Unisex 
<b>DNA</b>	<b>ES3</b>
uFEELsafe uFEELcontrol uFEELstable uFEELwarm uFEELsoft+	Advance  Unisex 



\* Attractive Packaging (1 pc each)

Anatomic construction



# STRAPS/WRAPPS

USI Universal offers a wide variety lifting straps. Ideal for use with shrugs, dead lifts, pull & high pull exercises. They help you with high repetition & heavy weights. Straps take away the stress from your hands.



### 733LS LIFTING STRAPS

TECH -SPEC. 

- Webbing & rubber construction
- Padded back of hand patch
- Appropriate length to wrap around bar
- Excellent gripping with bar

Code	Size apx	MRP
733LS	53cm(21")	349/-

\*per pair



### 733LSC COTTON LIFTING WRAPS

TECH -SPEC. 

- Strong cotton construction
- Padded back of hand patch

Code	Size	Color	MRP
733LSC	53cm (21")	Black	299/-

\*per pair



### 733LSL LEATHER LIFTING STRAPS

TECH -SPEC. 

- Hide leather construction

Code	Size	Color	MRP
733LSL	53cm (21")	Tan	549/-

\*per pair



### 7033 HEAVY DUTY LIFTING STRAP

TECH -SPEC. 

- Heavy duty webbing
- Reinforced stitching

Code	Size	Color	MRP
7033	53x5cm (21"x2")	Blue,Green	320/-

\*per pair



### 7032 '8' LIFTING STRAP

TECH -SPEC. 

- Heavy duty webbing neoprene lined
- Reinforced stitching
- '8' shape

Code	Color	MRP
7032	Black	400/-

\*per pair



### KS3L 3 LINE KNEE SLEEVE

TECH -SPEC.

Code	Size	MRP
KS3L	S-XXL	1999/-

\* per pair



### 733WLS LIFTING WRAPS WITH WRIST SUPPORT

TECH -SPEC. 

- Nylon webbing, rubber construction
- Ultimate gripping for bars
- Neoprene padded wrist wrap closure

Code	Color	MRP
733WLS	Black	599/-

\*per pair

### 733WLSL LEATHER LIFTING WRAPS WITH WRIST SUPPORT

TECH -SPEC. 

- Leather construction
- Neoprene padded wrist wrap closure

Code	MRP
733WLSL	799/-

\*per pair

### ES3L LINE ELBOW SLEEVES

TECH -SPEC.

Code	Size	MRP
ES3L	S-XXL	1399/-

\* per pair

# JOINT WRAPS/STRAPS

USI Universal's wraps deliver a perfect combination of support & comfort. Various closure systems ensure a secure fit. Various materials with different strength levels & design cater to particular needs of different customers.



### 733WW 2 LINE WRIST WRAPS

TECH -SPEC.



- 2 line strong elastic construction
- Hook & loop closure
- Comfortable because of plush finish

Code	Size	Color	MRP
733WW	28cm (11")	Black	399/-

\*per pair



### 733WW3 3 LINE WRIST WRAPS

TECH -SPEC.



- 3 line strong elastic construction
- Hook & loop closure
- Comfortable because of plush finish

Code	Size	MRP
733WW3	38cm (20")	699/-

\*per pair



### 733CS COTTON STRENGTH WRAPS

A smart alternate to those bulky wraps hook & loop closure has been replaced with a simple twist & tight lace system

TECH -SPEC.



- Soft cotton fabric construction
- Lace closure

Code	Length apx.	MRP
733CS	88x7.5 cm (35"x 3")	449/-

\*per pair



(A vintage solution for extra support in snatch, clean & jerk. As the leather breaks in, it will mould itself around your wrist.)

### 733LWW LEATHER WRIST WRAPS

TECH -SPEC.



- Top grain hide leather
- Soft leather lining
- Strong metal buckles closure (adjustable)

Code	MRP
733LWW	1199/-

\*per pair



### 733EW 2 LINE ELBOW WRAPS

TECH -SPEC.



- 2 line strong elastic construction
- Hook & loop closure
- Comfortable because of plush finish

Code	Size	Color	MRP
733EW	76cm (30")	Black	799/-

\*per pair



### 733EW3 3 LINE ELBOW WRAPS

TECH -SPEC.



- 3 line strong elastic construction
- Hook & loop closure
- Comfortable because of plush finish

Code	Size	Color	MRP
733EW3	76cm (30")	Black	999/-

\*per pair



### 733KW 2 LINE KNEE WRAPS

TECH -SPEC.



- 2 line strong elastic construction
- Hook & loop closure
- Comfortable because of plush finish

Code	Size	Color	MRP
733KW	152cm(60")	Black	1449/-

\*per pair



### 733KW3 3 LINE KNEE WRAPS

TECH -SPEC.



- 3 line strong elastic construction
- Comfortable because of plush finish

Code	Size	Color	MRP
733KW3	203cm(80")	Black	2149/-

\*per pair



### 733BS BENCHSTRAP

Now its all about the extra edge, the bench strap is a scientific innovation which accentuates your natural muscle movement by adjusting them to give extra support in bench press

TECH -SPEC.



- 6 line strong elastic construction
- Loops for placing arms

Code	Size apx	MRP
733BS	60cm (24") 15cm(6") width	1049/-

\* per pc

# HAND GRIPS

Our hands being the most potent weapons need to have a lot of strength. Various hand grips have been developed with regards to materials & strength requirements. You can get grip tension range from 5 Kg to 150 Kg. We have models with adjustable tension as well. Our hand grips help with flexibility & core stability also. Great product to develop hand & forearm strength.



### HG STEEL HAND GRIP

#### TECH -SPEC.



- Metal construction
- Calibrated spring
- Knurled handle
- Premium material

Code	Capacity	MRP
HG100	100 Kg	849/-
HG150	150 Kg	949/-

\* per pc



### 800HGC ADJUSTABLE HAND GRIP WITH COUNTER (HEAVY)

#### TECH -SPEC.



- Plastic, metal construction
- Adjustable tension (10-30 kg)
- 2 Digit reset counter 0-99

Code	MRP
800HGC	849/-

\* per pc



### 800HG ADJUSTABLE HAND GRIP

#### TECH -SPEC.



- Plastic and silicon rubber construction
- Adjustable tension from 5-20 Kg

Code	MRP
800HG	730/-

\* per pc



### 800HG1 HAND GRIP

#### TECH -SPEC.



- Plastic and metal construction
- Compact size

Code	MRP
800HG1	110/-

\* per pc



### 800PW POWER WRIST

Wrist strength & flexibility are important to prevent injury. USI Universal's power wrist will also help build the forearm. Better forearms will in turn compliment grip strength.

#### TECH -SPEC.



- Plastic, foam, metal construction
- Ideal for wrist & forearm strength
- Adjustable tension knob

Code	MRP
800PW	2699/-

\* per pc



## PUSH UP SYSTEMS

### 850PB PUSH UP BARS

USI Universal's Push ups bars are a simple yet perfect tool for building a strong core and upper body. Great for toning the arms, shoulders & pectorals. Ideal for doing dips. The ergonomic design with cushioning takes pressure of the wrists and hands. This will optimise your performance. The bars also help in getting the right positions for working on different muscle groups. The sturdiness of USI Universal's push up bars allows greater concentration on your mind and muscle connection.

**TECH-SPEC.**  **uFEELsoft**

- Moulded plastic construction
- Cushioned uFEELsoft handles
- No skid rubber pads for sturdy base
- Lightweight & portable
- Ideal for upper body & core workout



Code	MRP
850PB	649/-

\* per pair



### EQ EQUALIZER

USI Universal's equalizer is a portable dip station. Ideal for many upper body exercises. This is a cost effective tool for commercial gyms & home use.

**TECH-SPEC.**   

- Metal construction
- Anti rust powder coated
- 3.8cm/1.5" thick handles
- Anti slip hand grip
- Ideal for full body workout
- Plastic end caps can be adjusted as per floor level
- Comes flat packed

Code	Color	Size (apx)	MRP
EQ	Yellow	Apx. 72x63cm (28.5" x 25")	5899/-

\* per pair



 Assembly Video



### 7026 PARALLETES

USI Universal's paralletes help you with upper body, core & balance. An inexpensive tool that simulates the parallel bars of gymnastics, can be used for push ups & dips as well. Lightweight & portable.

**TECH-SPEC.**   

- Heavy duty metal construction
- Anti rust powder coated.
- Sold in pairs
- New bolt-together construction
- 3.8cm/1.5" thick handles
- All hardware included
- Comes flat packed

Code	Size (apx)	MRP
7026	Apx. 58x35x30cm (23"X14"X12")	4499/-

\* per pair



 Assembly Video



# PULL UP SYSTEMS

USI Universal's pull up systems help you develop your upper body. You can work on all the muscle groups of your upper body with every single pull up.

## 7023 WALL PULL UP SYSTEM

**TECH-SPEC.**  

- Heavy duty metal construction
- Anti rust powder coated
- 27mm thick pull up bar
- For wall only
- 2 Bar positions options
- 6 sets of mounting hardware included (screw, washer, wall plug)
- Comes flat packed
- Maximum user weight capacity: 100kg/220 Lbs

Code	MRP
7023	3999/-

\* per set



## 7025 ROOF & WALL PULL UP SYSTEM

**TECH-SPEC.**  

- Heavy duty metal construction
- Anti rust powder coated
- 27mm thick pull up bar
- Can be used on wall & ceiling
- 2 Bar positions options
- 8 sets of mounting hardware included (screw, washer, wall plug)
- Comes flat packed
- Maximum user weight capacity: 100kg/220 Lbs

Code	MRP
7025	4499/-

\* per set

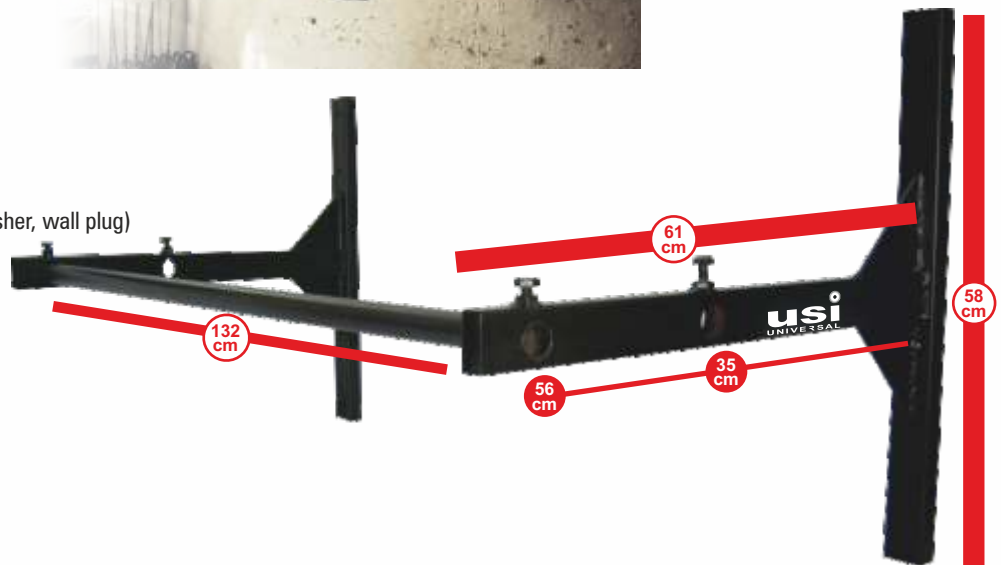

## 800DGB DOOR GYM BAR

**TECH-SPEC.** 

- Metal & foam construction
- Easy attachment to the door
- No permanent fixing required
- Ideal for upper body workout
- Ideal for pull ups & chinups
- Ideal for concrete doorway with width 50cm(20")-86cm(34")
- Can also be used for sit ups, dips & push ups
- Portable
- Maximum user weight capacity: 80 Kg/175 Lbs

Code	MRP
800DGB	2999/-

\* per pc



## DOOR GYMS

USI Universal's door gyms let you do a variety of full body workouts at the comfort of your home. Very easy to install & space efficient.

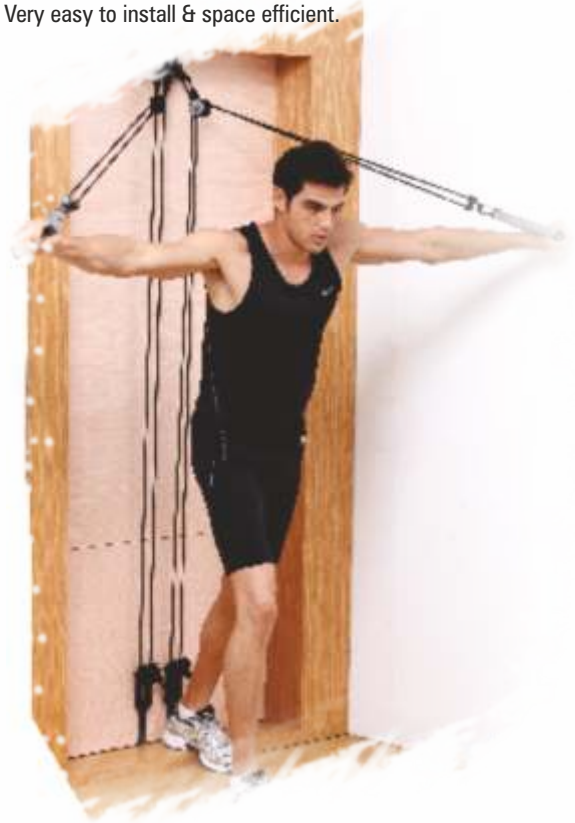

### 800DGF DOOR GYM HEAVY

TECH-SPEC.  Advance

- Plastic and silicon rubber construction
- Easy to install and fits most door sizes
- Suitable for using at home or office, portable and easy to store
- With pulley design, exercise more smoothly

Code	MRP
800DGF	3999/-

WHILST STOCK LAST

\* per set

### 800DGT DOOR GYM LIGHT

TECH-SPEC.  Core

- Plastic and silicon rubber construction
- Easy to install and fits most door sizes
- Suitable for using at home or office, portable and easy to store
- With pulley design, exercise more smoothly

Code	MRP
800DGT	1899/-

WHILST STOCK LAST

\* per set



## WEIGHT JACKETS

An ultimate Weight Jacket designed for the most gruesome of WODs. It safely hugs you through running, push ups, squats, burpees or any of your tough circuits.

### 415WJ WEIGHT JACKET

TECH-SPEC.  Performance

- Strong PU/Neoprene construction
- Foam padded shoulders & chest
- Nylon tape straps for securing

Code	Size	Weight apx	MRP
415WJS/M	S/M	5 Kg	2399/-
415WJL/XL	L/XL	10 Kg	3399/-

\* per pc





# WEIGHTED PRODUCTS

## 736HH HEAD HARNESS

USI Universal's head harness is a neck strengthening product. It also helps in rehab of neck injuries. The adjustable nylon straps can fit most head sizes. Weight plates can be added to the chain as per suitability.

TECH-SPEC. 

- Hook & loop closure at back & chin
- Snap hook closure for chains to add weight
- Maximum weight capacity 45 Kg/100Lbs

Code	MRP
736HH	999/-

\* per pc



# WRIST & ANKLE WEIGHTS

USI Universal's wrist & ankle weights help you create a toned body. The added weights help to build strength & burn fat. You can choose from a variety materials & weights as per your comfort & capacity.

## 736TL THUMB LOCK WEIGHTS

TECH-SPEC.  uFEELflex

- Soft Neoprene Construction
- Hook & Loop closure

Code	Size	MRP
736TL250	250 g Each	999/-
736TL500	500 g Each	1199/-
736TL1	1 Kg Each	1349/-

\* per pair



## 736SN NEOPRENE ANKLE WEIGHT

TECH-SPEC.  Core uFEELflex

- Soft neoprene, air mesh construction
- Hook & loop closure

Code	Size	MRP
736SN250	250 g Each	699/-
736SN500	500 g Each	799/-
736SN1	1 Kg Each	1049/-
736SN1.5	1.5 Kg Each	1199/-
736SN2	2 Kg Each	1399/-

\* per pair

## 736AW ANKLE WEIGHT

TECH-SPEC.  Base

- Nylon material
- Hook & loop closure

Code	Size	MRP
736AW250	250 g Each	449/-
736AW500	500 g Each	549/-
736AW1	1 Kg Each	749/-
736AW1.25	1.25 Kg Each	849/-
736AW1.5	1.5 Kg Each	899/-
736AW2	2 Kg Each	1249/-

\* per pair

## SILICONE BRACELET

TECH-SPEC.

Code	Weight	MRP
ASS1	1 Kg	3499/-
AW5H	0.5 Kg	2499/-

\* per pair



# COMPETITION KETTLEBELLS

USI Universal's competition kettlebells are of same size with same handle measurement though they come in different weights. The steel makes them more durable than cast iron kettlebells. The handle gives a firm grip. The wide base makes them more steady.



## CKB COMPETITION KETTLEBELL

**TECH-SPEC.**  Performance

- Steel construction
- Hollow

Code	Color	Weight	MRP
CKB4	Grey	4 Kg	4499/-
CKB6	Black	6 Kg	4599/-
CKB8	Pink	8 Kg	4699/-
CKB12	Blue	12 Kg	4800/-
CKB16	Yellow	16 Kg	6400/-
CKB20	Purple	20 Kg	8000/-
CKB24	Green	24 Kg	9600/-
CKB28	Orange	28 Kg	11200/-
CKB32	Red	32 Kg	12800/-
CKB36	Grey	36 Kg	14400/-
CKB40	White	40 Kg	16000/-

\*12 Kg to 40 Kg 400/- per Kg \* per pc



## 7013 ROUND BELL

USI Universal's round bell is a multi faceted weight product which packs the features of a dumbbell, kettlebell, slam ball, medicine ball, etc. You can fill them with sand & use anywhere. The shifting sand adds to the challenge. Also helps in building grip strength.

**TECH-SPEC.**  Advance

- Neoprene construction
  - Soft feel
  - Self sand filling
- \*sold empty (without fill)

Code	Weight	MRP
7013	2 Kg	849/-
7013	4 Kg	999/-
7013	6 Kg	1449/-

\* per pc



# KETTLEBELLS



## DKB DIPPED KETTLEBELLS

USI Universal's dipped kettlebells are made of cast iron & vinyl coated for protection of the user/floor. Each kettlebell is colour coded as per weight. Each weight has a different dimension & handle size. Ideal product for intermediate customers who want to use kettlebells in pairs.

**TECH-SPEC.**



- Solid metal construction
- Vinyl coated

Code	Weight	Color	MRP
DKB4	4 Kg	Yellow	1240/-
DKB8	8 Kg	Green	2480/-
DKB12	12 Kg	Blue	3720/-
DKB16	16 Kg	Red	4960/-
DKB20	20 Kg	Orange	6200/-

\*4 Kg to 20 Kg 310/- per Kg \* per pc



## DSK DISPLAY STAND FOR KETTLEBELL

**TECH-SPEC.**



- Solid metal construction
- Powder coated
- Collapsible construction for easy transport
- Can hold upto 15-20 kettlebells depending on size and weight
- Product weight: 20.8 Kg
- Weight Capacity: 350 Kg/770Lbs

Code	Dimensions apx.	MRP
DSK	(L)125 x (B)48 x (H)109 49"x19"x40"	10,999/-

\* Kettlebells not included \* per set

Assembly Manual:  
Included in the box

Assembly  
Video



## 787KB KETTLEBELLS

USI Universal's plastic kettlebells are a light duty product for home use or ladies /kids gyms. Ideal product for beginners or those looking to develop their skill. The handles are anatomically designed to promote grip. The texture on the surface also helps in holding.

**TECH-SPEC.**



- Injection moulded plastic
- Concrete filling

Code	Color	Weight	MRP
787KB3	Black/White	3 Kg	800/-
787KB5		5 Kg	1150/-
787KB8		8 Kg	1840/-
787KB12		12 Kg	2760/-

\*5 Kg to 12 Kg 230/- per Kg \* per pc



## OCTAGON RUBBER DUMBBELLS

USI Universal's Octagon rubber dumbbells have a thick layer of rubber which reduces noise & limits the damage it may cause to the floor / dumbbells. Ergonomically designed, chrome plated fine knurl grip gives a very firm & comfortable feel. The inner metal structure is made of solid steel. The shaft & the side weights have been friction welded. It makes a very strong bond which has a very long life. Ideal for commercial & home use.

### ODB OCTAGON RUBBER DUMBBELL



- Rubber & alloy steel construction
- Extra fine knurled grip
- Weight tolerance 1-2%

Code	Color	Weight	MRP
ODB2.5	Black/ Chrome Handle	2.5 Kg	1300/-
ODB5		5 Kg	2600/-
ODB7.5		7.5 Kg	3900/-
ODB10		10 Kg	5200/-
ODB12.5		12.5 Kg	6500/-
ODB15		15 Kg	7800/-
ODB17.5		17.5 Kg	9100/-
ODB20		20 Kg	10400/-
ODB22.5		22.5 Kg	11700/-
ODB25		25 Kg	13000/-
ODB30		30 Kg	15600/-
ODB35		35 Kg	18200/-
ODB40		40 Kg	20800/-
ODB50		50 Kg	26000/-

From 2.5 Kg to 50 Kg MRP 260/- Per Kg  
\* per pair



## HEXAGON RUBBER DUMBBELLS

USI Universal's hex rubber dumbbells are made with a durable layer of rubber. The inner metal structure is made of solid steel. The shaft & the side weights are mig welded together which does not break easily. Aggressive knurl grip for a strong hold. Ideal for commercial & home use.

### HDB HEXAGON RUBBER DUMBBELL



- Rubber & alloy steel construction
- Aggressive knurl grip for strong hold
- Weight tolerance 1-2%

Code	Color	Weight	MRP
HDB2.5	Black/ Chrome Handle	2.5 Kg	1100/-
HDB5		5 Kg	2200/-
HDB7.5		7.5 Kg	3300/-
HDB10		10 Kg	4400/-
HDB12.5		12.5 Kg	5500/-
HDB15		15 Kg	6600/-
HDB17.5		17.5 Kg	7700/-
HDB20		20 Kg	8800/-
HDB25		25 Kg	11000/-

From 2.5 Kg to 20 Kg MRP 220/- Per Kg  
\* per pair



# LOADABLE OLYMPIC DUMBBELLS

USI Universal offers a very space efficient solution against storing a complete set of regular dumbbells. You can add the weight of your choice. Ideally works with fraction plates or other olympic plates. Preferably up to 5 Kg plates.

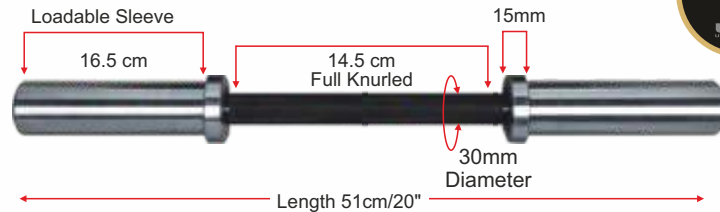
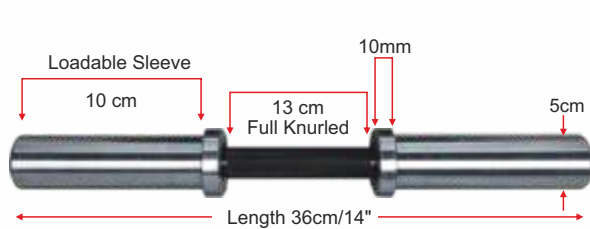

## DB LOADABLE OLYMPIC DUMBBELL



- Alloy steel construction
- Black oxide shaft
- Bearings & bush for smooth rotation

Code	Length apx	Weight	MRP
DB14	36cm/14"	4 Kg	5499/-
DB20	51cm/20"	6 Kg	5999/-

\*MRP per pc.



# FORCE TPU DUMBBELLS

USI Universal's force TPU dumbbells are the most innovative product on the market. Our poly urethane dumbbells are a mark above the rubber dumbbells because of their excellent tear resistance, hardness, no odor & bright colours. USI Universal's polyurethane dumbbells have a much longer life than rubber dumbbells as they stand better against sunlight & outdoor environment.



## PUDB FORCE TPU DUMBBELL



- PU & alloy steel construction
- Extra fine knurled grip
- Weight tolerance 1-2%

Code	Color	Weight	MRP
PUDB2.5	Black/ Chrome Handle	2.5 Kg	2050/-
PUDB5		5 Kg	4100/-
PUDB7.5		7.5 Kg	6150/-
PUDB10		10 Kg	8200/-
PUDB12.5		12.5 Kg	10250/-
PUDB15		15 Kg	12300/-
PUDB17.5		17.5 Kg	14350/-
PUDB20		20 Kg	16400/-
PUDB22.5		22.5 Kg	18450/-
PUDB25		25 Kg	20500/-
PUDB30		30 Kg	24600/-
PUDB35		35 Kg	28700/-
PUDB40		40 Kg	32800/-
PUDB50		50 Kg	41000/-

From 2.5 Kg to 50 Kg MRP 410/- Per Kg

\* per pair



## TOUGH RUBBER DUMBBELLS

USI Universal's tough rubber dumbbells come with a thick rubber coating over a solid steel inner structure. The shaft is welded with the side weights using friction welding. It is the strongest form of welding. The chrome plated knurl grip gives a very firm hold.



### RDB TOUGH RUBBER DUMBBELL

**TECH-SPEC.** 

- Rubber & alloy steel construction
- Extra fine knurled grip
- Weight tolerance 1-2%

Code	Color	Weight	MRP
RDB2.5	Black/ Chrome Handle	2.5 Kg	1640/-
RDB5		5 Kg	3280/-
RDB7.5		7.5 Kg	4920/-
RDB10		10 Kg	6560/-
RDB12.5		12.5 Kg	8200/-
RDB15		15 Kg	9840/-
RDB17.5		17.5 Kg	11480/-
RDB20		20 Kg	13120/-
RDB22.5		22.5 Kg	14760/-
RDB25		25 Kg	16400/-
RDB30		30 Kg	19680/-
RDB35		35 Kg	22960/-
RDB40		40 Kg	26240/-
RDB50		50 Kg	32800/-

From 2.5 Kg to 50 Kg MRP 328/- Per Kg  
\* per pair



## HANDWEIGHT VINYL DUMBBELLS

USI Universal's vinyl dumbbells come in attractive colours which add to the beauty of your commercial or home gym. The vinyl coating acts as a protective layer & grip for firm holding. Compact size is ideal for light use.

### VDB HANDWEIGHT VINYL DUMBBELLS

**TECH-SPEC.** 

- Cast iron & vinyl construction
- Triangular shape
- Thick coating gives protection & grip
- Weight tolerance 1-2%

Code	Color	Weight	MRP
VDB1	Yellow	1 Kg	592/-
VDB2	Purple	2 Kg	1184/-
VDB3	Green	3 Kg	1776/-
VDB4	Blue	4 Kg	2368/-
VDB5	Orange	5 Kg	2960/-

From 1 Kg to 5 Kg MRP 296/- Per Kg  
\* per pair



## FIXED WEIGHT BARS

USI Universal's fixed weight bars are more stable & easy to use compared to free weights. You save a lot of time from loading & unloading the plates. As you don't have to change plates, so there is a reduced risk of injury.



### RDBC CURL BAR WITH FIXED WEIGHT

TECH-SPEC. 

- Alloy steel & rubber construction
- Bright zinc coating
- Fine knurl for grip
- Curled for natural grip gives better results
- Fixed bars are more secure for use
- Save time for loading & unloading weights
- Ideal for bicep & tricep exercises

Code	Weight	MRP
RDBC10	10 Kg	4200/-
RDBC15	15 Kg	6300/-
RDBC20	20 Kg	8400/-
RDBC25	25 Kg	10500/-
RDBC30	30 Kg	12600/-
RDBC35	35 Kg	14700/-
RDBC40	40 Kg	16800/-
RDBC45	45 Kg.	18900/-
RDBC50	50 Kg.	21000/-

From 10 Kg to 50 Kg MRP 420/- Per Kg

\* per pc

## STRAIGHT BARS WITH FIXED WEIGHT



### RDBS STRAIGHT BAR WITH FIXED WEIGHT

TECH-SPEC. 

- Alloy steel & rubber construction
- Bright zinc coating
- Fine knurl for grip
- Fixed bars are more secure for use
- Save time for loading & unloading weights
- Ideal for bicep & tricep exercises



Code	Weight	MRP
RDBS10	10 Kg	4150/-
RDBS15	15 Kg	6225/-
RDBS20	20 Kg	8300/-
RDBS25	25 Kg	10375/-
RDBS30	30 Kg	12450/-
RDBS35	35 Kg	14525/-
RDBS40	40 Kg	16600/-
RDBS45	45 Kg	18675/-
RDBS50	50 Kg	20750/-

From 10 Kg to 50 Kg MRP 415/- Per Kg

\* per pc

## RUBBER OLYMPIC WEIGHT PLATES

USI Universal currently offers 2 styles in rubber weight plates. Both our plates come with a thick rubber coating which absorbs impact while protecting the floor & equipment. The stainless steel bush hole is able to withstand the heavy drops. It protects the plates & barbell from damage. The design of the plates make them very easy to handle & enable quick change in between sets. Ideal product for commercial & home use.

### RWP1 CROSS GRIP OLYMPIC WEIGHT PLATE RUBBER

Rubber coated olympic plates with steel insert, very attractive honey comb design. Grip hold design for easy handle & quick change between sets. Color coded for easy identification.



- Steel & rubber construction
- Steel bush olympic hole (51mm/2")
- Weight Tolerance 1-2%

Code	Color	Weight	MRP
RWP11.25	Black	1.25 Kg	875/-
RWP12.5	Black	2.5 Kg	1750/-
RWP15	Black	5 Kg	3500/-
RWP110	Black	10 Kg	7000/-
RWP115	Black	15 Kg	10500/-
RWP120	Black	20 Kg.	14000/-
RWP125	Black	25 Kg.	17500/-

From 1.25 Kg to 25 Kg MRP 350/- Per Kg

\* per pair



Hole size: 51mm/2"

## CROSS GRIP OLYMPIC WEIGHT PLATES (RUBBER)

Basic plates with cast iron insert. An economy model which is easy on the pocket.

### RWP TOUGH RUBBER WEIGHT PLATE



- Cast iron & rubber construction
- Steel bush olympic hole (51mm/2")
- Weight Tolerance 1-2%

Code	Color	Weight	MRP
RWP1.25	Black	1.25 Kg	815/-
RWP2.5	Black	2.5 Kg	1630/-
RWP5	Black	5 Kg	3260/-
RWP10	Black	10 Kg	6520/-
RWP15	Black	15 Kg	9780/-
RWP20	Black	20 Kg	13040/-
RWP25	Black	25 Kg	16300/-

From 1.25 Kg to 25 Kg MRP 326/- Per Kg

\* per pair



Hole size: 51mm/2"



# TPU OLYMPIC WEIGHT PLATES

USI Universal's TPU plates come with a thick coating of PU over a steel insert. Our TPU plates are impact resistant to the floor & non abrasive to the surrounding equipment. USI Universal's heavy duty PU coating does not crack peel or rust. Neither does it turn white like rubber upon reaction with the environment. Our TPU plates are the most noise & vibration free product on the market. The quad grip designs makes them very easy to use & enables quick change in between sets. The stainless steel bush hole in the middle adds to the life of this product. Our colour coded plates are easy to identify. Ideal product for commercial & home use.

## TWP Quad Grip Olympic Weight Plate TPU

Rubber coated olympic plates with steel insert, very attractive honey comb design. Grip hold design for easy handle & quick change between sets. Color coded for easy identification.

**TECH-SPEC.** 

- Steel & TPU construction
- Steel bush olympic hole (51mm/2")
- Weight Tolerance 1-2%

Code	Color	Weight	MRP
TWP1.25	Black/Purple	1.25 Kg	1250/-
TWP2.5	Black/Sky blue	2.5 Kg	2500/-
TWP5	Black/Orange	5 Kg	5000/-
TWP10	Black/Yellow	10 Kg	10000/-
TWP15	Black/Purple	15 Kg	15000/-
TWP20	Black/Blue	20 Kg	20000/-
TWP25	Black/Red	25 Kg	25000/-

From 1.25 Kg to 25 Kg MRP 500/- Per Kg

\* per pair



# FRACTION PLATES

USI Universal's fraction plates allow you to increase or decrease the weight gradually in smaller increments. They help you with progressive overload training. Available in different weights & colours.

## FP FRACTION PLATES

**TECH-SPEC.** 

- Steel & PVC constructions
- Olympic hole (51mm/2") **Set Rate: 16044/-**

Code	Color	Weight	MRP
FP0.25	Black	0.25 Kg	1049/-
FP0.5	White	0.5 Kg	1799/-
FP1	Green	1 Kg	2599/-
FP1.25	Green	1.25 Kg	2999/-
FP1.5	Yellow	1.5 Kg	3299/-
FP2.5	Red	2.5 Kg	4299/-

\* per pair



## BUMPER PLATES (WITHOUT HUB)

USI Universal's bumper plates are a solid piece of equipment. Smooth finish and attractive colours of these bumpers will add to the beauty of your gym, box, garage gym or home gym. The tapered edge design helps avoid chipping with constant use. It also helps in holding the bumpers for exercises other than loading on to the barbells. The stainless steel collar insert is much more durable than the regular aluminium inserts. Moreover, it is bonded with the rubber plate. This increases the life of the plate tremendously. Our bumper plates have a medium bounce. The low impact rubber coating also makes them less noisy compared to other olympic plates. Our bumper plates are colour coded as per weight for easy identification.

### BP BUMPER PLATES (WITHOUT HUB)

TECH-SPEC.



- Virgin rubber construction
- Stainless steel collar insert (51mm/2")
- Thick plates with medium bounce
- As per IWF specification
- Ideal for cross training, racks, plate loaded machines
- Coloured plates for easy identification
- Durometer rating : 85-93SHA
- Drop test: 2m x 5000 repetitions
- Diameter: 450mm
- Weight tolerance: 1-2 %

Set Rate: 60139/-

Code	Color	Weight	MRP
BP5	Grey	5 Kg	6099/-
BP10	Green	10 Kg	7720/-
BP15	Yellow	15 Kg	11580/-
BP20	Blue	20 Kg	15440/-
BP25	Red	25 Kg	19300/-

From 10 Kg to 25 Kg MRP 386/- Per Kg

\* per pair



## BUMPER PLATES (BLACK)

USI Universal's latest version of the black bumper plates now come colour coded as per weight. This adds aesthetic value & makes it easy to identify the various weights.



### BPB BLACK BUMPER PLATES

TECH-SPEC.



- Virgin rubber construction
- Stainless steel collar insert (51mm/2")
- Thick plates with medium bounce
- As per IWF specification
- Ideal for cross training, racks, plate loaded machines
- Durometer rating : 85-93SHA
- Drop test: 2m x 5000 repetitions
- Coloured printing for easy identification
- Diameter: 450mm
- Weight tolerance: 1-2 %

Set Rate: 60039/-

Code	Color	Weight	MRP
BPB5	Black/Grey	5 Kg	5999/-
BPB10	Black/Green	10 Kg	7720/-
BPB15	Black/Yellow	15 Kg	11580/-
BPB20	Black/Blue	20 Kg	15440/-
BPB25	Black/Red	25 Kg	19300/-

From 10 Kg to 25 Kg MRP 386/- Per Kg

\* per pair



# COMPETITION BUMPER PLATES (WITH HUB)

USI Universal's competition bumper plates with hub are designed as per IWF specification. Because of the metal hub the plates are thinner, so you can fit more plates on to the barbell. Our bumper plates are colour coded as per weight which makes them easy to identify.



## BPHC BUMPER PLATES (WITH HUB)

**TECH-SPEC.** 

- Rubber & alloy steel construction
- As per IWF specifications.
- Two piece steel hub zinc plated olympic hole (51mm/2")
- Durometer rating : 85-93SHA
- Drop test: 2 mtr x 5000 repetitions
- Diameter: 450mm
- Weight tolerance: 1-2 %

Set Rate: 1,03,599/-

Code	Color	Weight	MRP
BPHC5	Grey	5 Kg	6999/-
BPHC10	Green	10 Kg	13800/-
BPHC15	Yellow	15 Kg	20700/-
BPHC20	Blue	20 Kg	27600/-
BPHC25	Red	25 Kg	34500/-

From 5 Kg to 25 Kg MRP 690/- Per Kg  
\* per pair



## BPST BUMPER PLATE STACKER

**TECH-SPEC.**   

- 11 gauge (3m apx) metal construction
- Anti rust powder coated
- Lockable heavy duty wheels
- Comes flat packed
- Can fit 10-15 bumper plates (50mm/2" hole) of mix weights
- Foot print 60x60cm (24"x24"), Length : 60cm (24") apx.

Code	Color	MRP
BPST	Black	8499/-

\* plates not included \* per set



## WPTR OLYMPIC WEIGHT PLATE TREE

**TECH-SPEC.**   

- 11 gauge (3m apx) metal construction
- Anti rust powder coated
- Lockable heavy duty wheels
- Comes flat packed
- Length : 66cm (26") apx.
- Width : 60cm (24") apx.
- Height : 127cm (50") apx.
- Post : 30cm (12") apx. Post spacing : 46.5cm (18.3") apx.
- Store upto : 24-30 plates mix of sizes
- Can accommodate 50mm/2" apx. hole plates

Code	Color	MRP
WPTR	Black	13999/-

\* plates not included \* per set

# OLYMPIC BARBELLS

The ultimate barbell for Olympic weightlifting, Power lifting & Cross training/ Functional training. Made with best possible materials. Machined with highest standards available till date. Tested with most rigorous foolproof methods. Excellent whip properties.

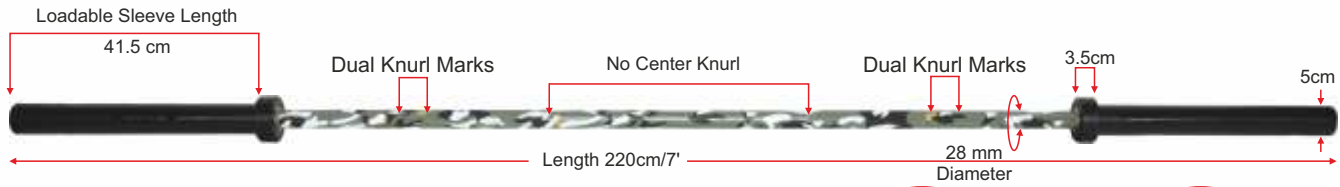

## COB750 CAMO 'CERAKOTE' BARBELL

TECH-SPEC.

- 42CrMo alloy steel construction
- 6 needle bearings
- Brass bushing
- Hard chromed handle bars and sleeves
- Loading weight 680Kg/1500Lbs apx.
- Tested for 2000 drops
- Fine knurling
- 28 mm diameter
- Camo print
- Ceramic coated for enhanced durability & corrosion resistance
- Accommodates 50mm/2" olympic hole plates

20 Kg  
 Bushing 28.5 mm  
 CERAMIC COATED  
 Good Whip  
 Fine Knurl  
 Engineered Product

Code	Length	Weight	Capacity	MRP
COB750	220cm/7'	20 Kg apx	680 Kg (1500 Lbs)	29,999/-

\* per pc

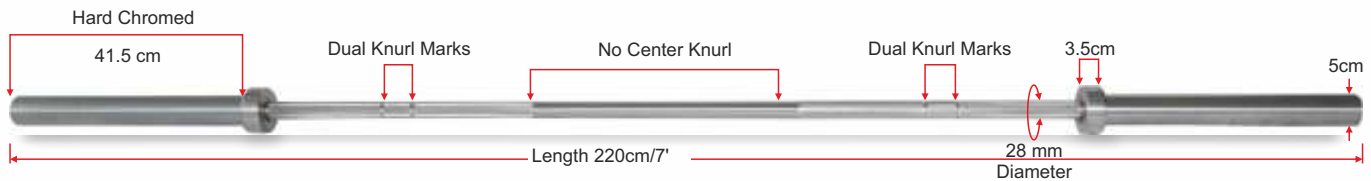

## OB750 CRATUS OLYMPIC BARBELL

TECH-SPEC.

- 42CrMo alloy steel construction
- 6 needle bearings
- Brass bushing
- Hard chromed handle bars and sleeves
- Loading weight 680 Kg apx
- Tested for 2000 drops
- Fine knurling
- 28 mm diameter
- Accommodates 50mm/2" olympic hole plates

20 Kg  
 Bearing 28.5 mm  
 Bushing  
 Good Whip  
 Fine Knurl  
 Engineered Product

Code	Length	Weight	Capacity	MRP
OB750	220cm/7'	20 Kg apx	680 Kg (1500 Lbs)	26,500/-

\* per pc



## WOMEN'S WOB750 VENUS OLYMPIC BARBELL (WOMEN)

TECH-SPEC.

- 42CrMo alloy steel construction
- 6 needle bearings
- Brass bushing
- Hard chromed handle bars and sleeves
- Loading weight 680 Kg/1500 Lbs apx.
- Tested for 2000 drops
- Fine knurling
- 25 mm diameter
- Accommodates 50mm/2" olympic hole plates

15 Kg  
 Bushing 25 mm  
 Good Whip  
 Fine Knurl  
 Engineered Product

Code	Length	Weight	Capacity	MRP
WOB750	200cm 6.56'	15 Kg apx	680 Kg (1500 Lbs)	21499/-

\* per pc

# OLYMPIC BARBELLS

The ARES model of Olympic barbell is an economy model below CRATUS. It has been tested at slightly lower standards. It is very suitable for any type of barbell training. Excellent whip properties.

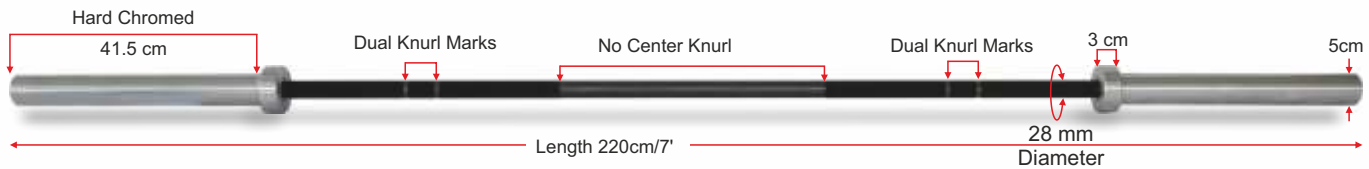

## OB500 ARES OLYMPIC BARBELL



- 40Cr Alloy steel construction
- 4 needle bearings
- Brass bushing
- Black oxide handle bar
- Hard chromed sleeves
- Loading weight 450 Kg apx
- Tested for 1000 drops
- Standard knurling
- 28.5mm diameter
- Accommodates 50mm/2" olympic hole plates



Medium Whip Standard Knurl Engineered Product

Code	Length	Weight	Capacity	MRP
OB500	220cm/7'	20 Kg apx	450 Kg (992 Lbs)	22,199/-

\* per pc

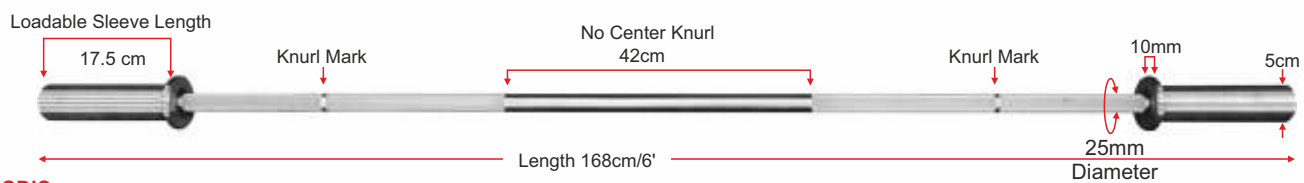

## JUNIOR'S JOB500 OLYMPIC BARBELL

Ideal product for beginners, young & old. Its low weight helps the beginners to master the basic skills before they graduate on to a full size olympic barbell.



- 40Cr Alloy steel construction
- 4 needle bearings
- Brass bushing
- Hard chromed sleeves
- Loading weight 450 Kg apx
- Tested for 1000 drops
- Standard knurling
- 25 mm diameter
- Accommodates 50mm/2" olympic hole plates

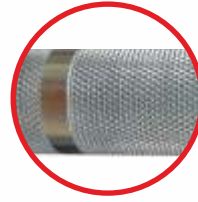

Medium Whip Standard Knurl Engineered Product

Code	Length	Weight	Capacity	MRP
JOB500	168cm/6'	10 Kg apx	450 Kg (992 Lbs)	17,599/-

\* per pc

# OLYMPIC TRAINING BARBELLS

The most basic olympic barbell ideal for weight rooms, light squats, bench press & deadlift.

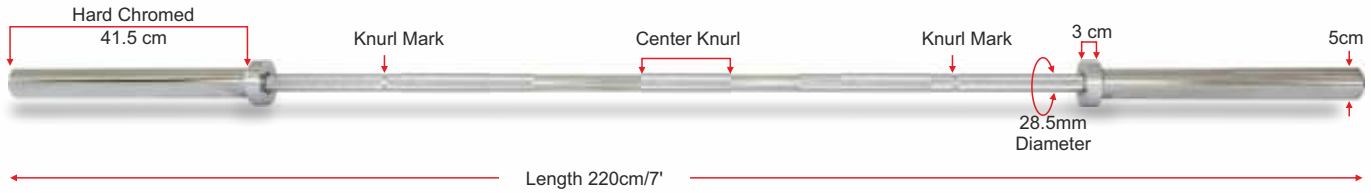

## OB350 OLYMPIC BARBELL 'ATLAS'

TECH-SPEC. 

- Alloy steel construction
- Normal chrome finish
- Brass bushing, screw lock system
- 300 Kg Loading weight
- Sharp knurling
- 28.5 mm diameter
- Accommodates 50mm/2" olympic hole plates

Code	Length	Weight	Capacity	MRP
OB350	220cm/7'	20 Kg apx	300 Kg (661 Lbs)	13,999/-

\* per pc

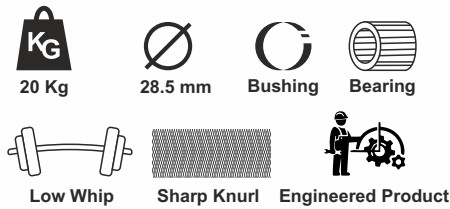

## OB350 OLYMPIC SLIDING GRIP BARBELL

TECH-SPEC. 

Code	MRP
OB350	26,999/-

\* per pc



## OBAL ALUMINUM TECHNIQUE BARBELL

USI Universal developed this product for young athletes who want to develop their weightlifting & power lifting skills. Very lightweight product allows you to focus on technique.

TECH-SPEC. 

- Lightweight aluminum construction
- Bushing for smooth rotation
- 18 Kg (40 Lbs) loading weight
- Ideal for kids/beginners
- Fine knurling
- Black oxide shaft & anodized sleeves
- Accommodates 50mm/2" olympic hole plates

Code	Length	Weight	Capacity	MRP
OBAL	122cm/4'	2.3Kg apx	18 Kg (40 Lbs)	12499/-

\* per pc

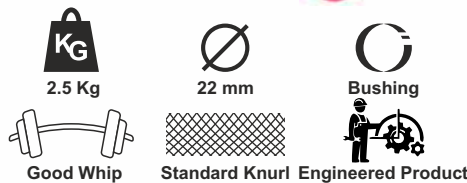

# OLYMPIC TRAINING BARBELLS

USI Universal offers olympic training barbells in three different sizes. These non standard sizes are often used in weight rooms for specific exercises. These are generally used with much lesser weight than an olympic barbell.

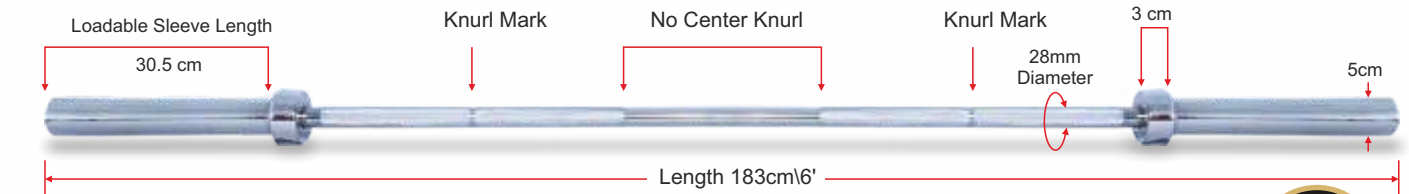

## OTB6 OLYMPIC TRAINING BAR



- Alloy steel construction
- Chrome finish
- Diamond-knurled hand grips
- Sharp knurling
- Ideal for weight rooms, bench use
- Accommodates 50mm/2" olympic hole plates
- Weight capacity: 250 Kg (500 Lbs)

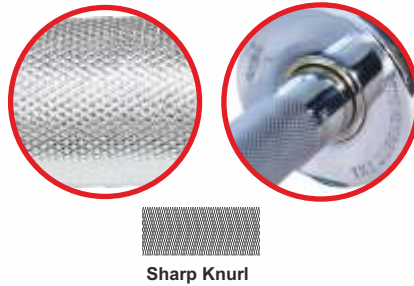

Code	Length	Weight	Capacity	MRP
OTB6	183cm (6')	15 Kg apx	250 Kg apx (500 Lbs)	9999/-

\* per pc

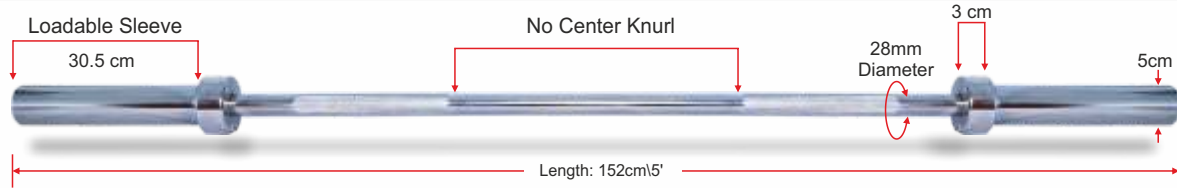

## OTB5 OLYMPIC TRAINING BAR



- Alloy steel construction
- Chrome finish
- Diamond-knurled hand grips and rotating sleeves
- Sharp knurling
- Accommodates 50mm/2" olympic hole plates
- Weight capacity: 250 Kg (500 Lbs)

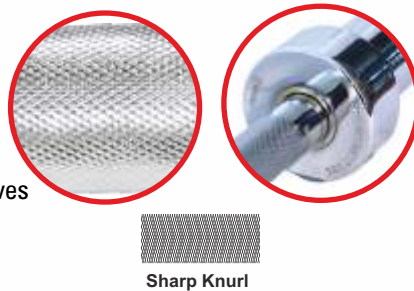

Code	Length	Weight	Capacity	MRP
OTB5	152cm (5')	12.8 Kg apx	250 Kg (500 Lbs)	8499/-

\* per pc

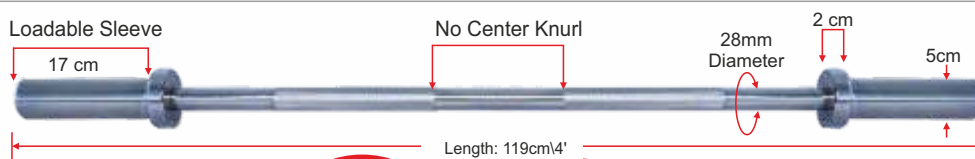

## OTB4 OLYMPIC TRAINING BAR



- Alloy steel construction
- Chrome finish
- Sharp knurling
- Accommodates 50mm/2" olympic hole plates
- Weight capacity: 150 Kg (330 Lbs)

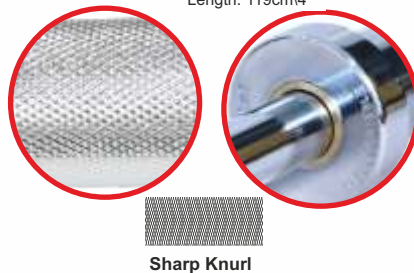

Code	Length	Weight	Capacity	MRP
OTB4	119cm (4')	9.5 Kg apx	150 Kg (330 Lbs)	7499/-

\* per pc



## OTB3 OLYMPIC TRAINING BAR



- Alloy steel construction
- Chrome finish
- Sharp knurling
- Accommodates 50mm/2" olympic hole plates
- Weight capacity: 150 Kg (330 Lbs)

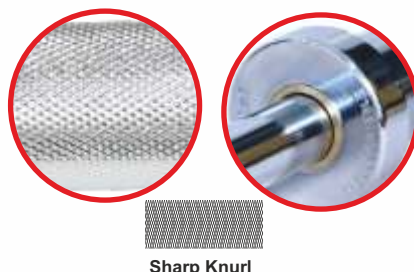

Code	Length	Weight	Capacity	MRP
OTB3	91cm (3')	7 Kg apx	150 Kg (330 Lbs)	6499/-

\* per pc

# CURL BARS

USI Universal's curl bars have been developed to work on smaller muscles groups like the biceps & triceps. As the name suggests, the curls on the bar gives you a more natural hand position. The curl bars can be used with an overhand & underhand grip without any pain in the wrists.



### OCB ARES CURL BAR

- TECH-SPEC.**  Performance
- 40CR alloy steel construction
  - 4 needle bearings
  - Brass bushing
  - Standard knurl
  - Black oxide handle bar
  - Accommodates 50mm/2" olympic hole plates

Code	Length	Weight Capacity	MRP
OCB	120cm/4'	200 Kg / 440 Lbs	11,499/-



\* per pc

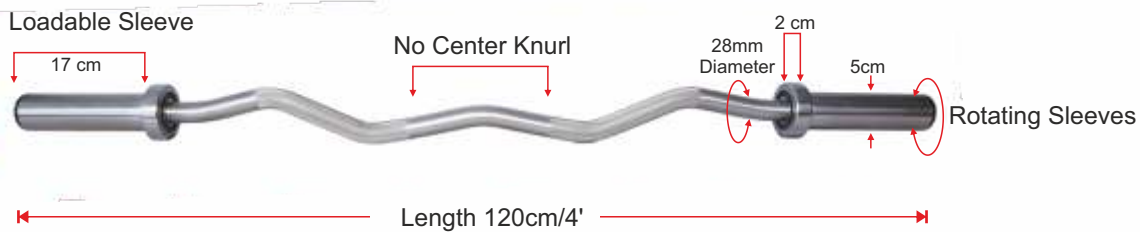

### OCTB OLYMPIC CURL/TRICEP BAR

- TECH-SPEC.**  Advance
- Stainless steel construction
  - 100% rust proof & scratch proof
  - Fine knurling natural grip
  - Ball bearing rotation sleeves
  - TPR moulded ends caps
  - Accommodates 50mm/2" olympic hole plates
  - Weight capacity: 170Kg/370 Lbs

Code	Length	Weight	Capacity	MRP
OCTB	120cm/4'	8.650 Kg apx	170 Kg (370 Lbs)	8499/-

\* per pc





# SUPER CURL BAR

USI Universal's super curl bar has that extra angle which is more comfortable. It gives you a parallel/neutral grip. Ideal for performing hammer curls, etc.

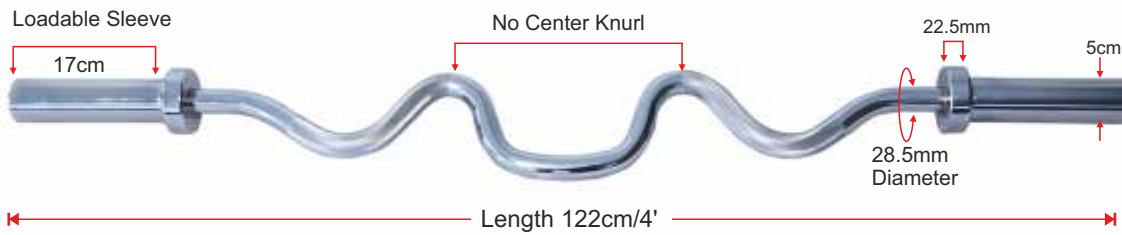

## SCB SUPER CURL/TRICEP BAR

TECH-SPEC. 

- Alloy steel construction
- Brass bushing
- Fine knurling
- Bright zinc coating
- Accommodates 50mm/2" olympic hole plates
- Weight capacity: 150kg/330 Lbs



Code	Length	Weight	Capacity	MRP
SCB	122cm/4'	10.5 Kg	150 Kg (330 Lbs)	8999/-

\* per pc

USI Universal's multi grip bar is a rugged piece of equipment. The vertical neutral grips allow users to switch between close to wide grip depending on the muscles being worked on. The bar can be used both ways to reverse the angled grips. USI Universal's bar is very well balanced. It reduces the stress on wrist & shoulders during bench press. A thick powder coat finish makes it corrosion resistant & easy to clean. You can use it for arm curls & seated rows.

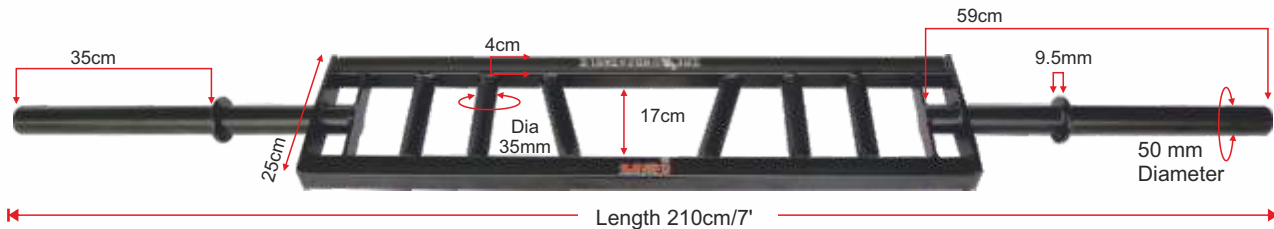

## MGBR KNURLED MULTIGRIP BARBELL / SWISSBAR

TECH-SPEC.  

- Alloy steel
- Sharp knurling
- Anti rust powder coated
- Accommodates 50mm/2" olympic hole plates
- Weight capacity: 250kg/550Lbs

Code	Length	Weight	Capacity	MRP
MGBR	210cm/7'	18.5 Kg	250 Kg (550 Lbs)	8999/-

\* per pc

## BXB BOX TRICEP BAR

USI Universal's box tricep bar targets the tricep & upper body muscles. The neutral grip allows a comfortable & lighter grip. This position allows you to lift more weight with better control.

TECH-SPEC. 

- Alloy steel frame welded
- Chrome finish
- Rotational olympic sleeves
- Standard knurling
- Accommodates 50mm/2" olympic hole plates
- Weight capacity: 120kg/260 Lbs

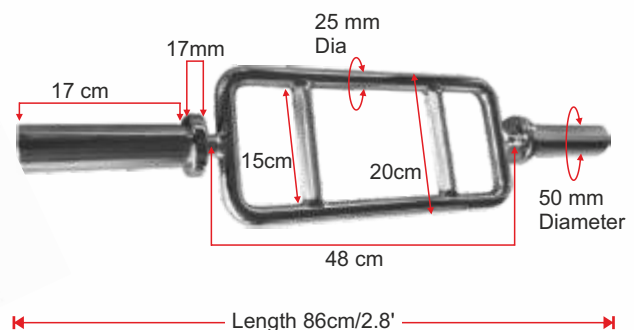

Code	Length	Weight	Capacity	MRP
BXB	86cm/2.8'	10.5 Kg	120 Kg (260 Lbs)	7499/-

\* per pc

# TRICEP BAR SWIVEL HANDLES

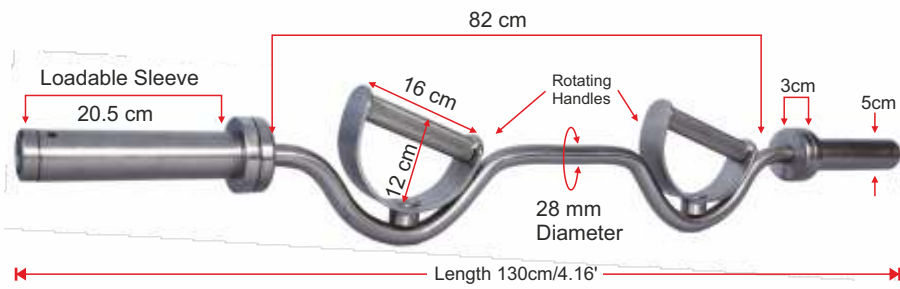

## TBR1 TRICEP BAR SWIVEL HANDLES

TECH-SPEC. 

- Stainless steel construction
- Accommodates 50mm/2" olympic hole plates
- Bearings in sleeves & bushes in handles
- Swivel handles to target different muscle groups

Code	Length	Weight	Capacity	MRP
TBR1	130cm (4.16')	14.6 Kg	80Kg/175 Lbs	24,999/-

\* per pc



# TRICEP BAR ROTATING HANDLES



## TBR2 TRICEP BAR ROTATING HANDLES

TECH-SPEC. 

- Alloy steel construction
- Accommodates 50mm/2" olympic hole plates
- Smooth bushing rotation
- Allows dynamic wrist movement
- Great for targeting different optimal arms workout
- Weight capacity: 80kg/175Lbs

Code	Length	Weight	Capacity	MRP
TBR2	123cm (4')	12.6 Kg	80Kg(175 Lbs)	19,999/-

\* per pc



# DEAD LIFT BARBELLS

USI Universal's deadlift bars are a great solution for developing your lower body with lesser risk of injury. Much easier to work on than a regular barbell. Ideal product for people with back issues. It is a great tool to learn proper deadlifts as it does not require great technique to use.

## DLB DEAD LIFT TRAP BAR

TECH-SPEC. 

- Alloy steel construction
- Welded ends
- Neutral handles with knurling
- Plastic / Rubber collars on sleeve ends
- Foldable handles
- Accommodates 50mm/2" olympic hole plates
- Weight capacity: 270 Kg /600Lbs



Code	Length	Weight	Capacity	MRP
DLB	166cm/5.5'	18 Kg	270 Kg (600 Lbs)	18,999/-

\* per pc

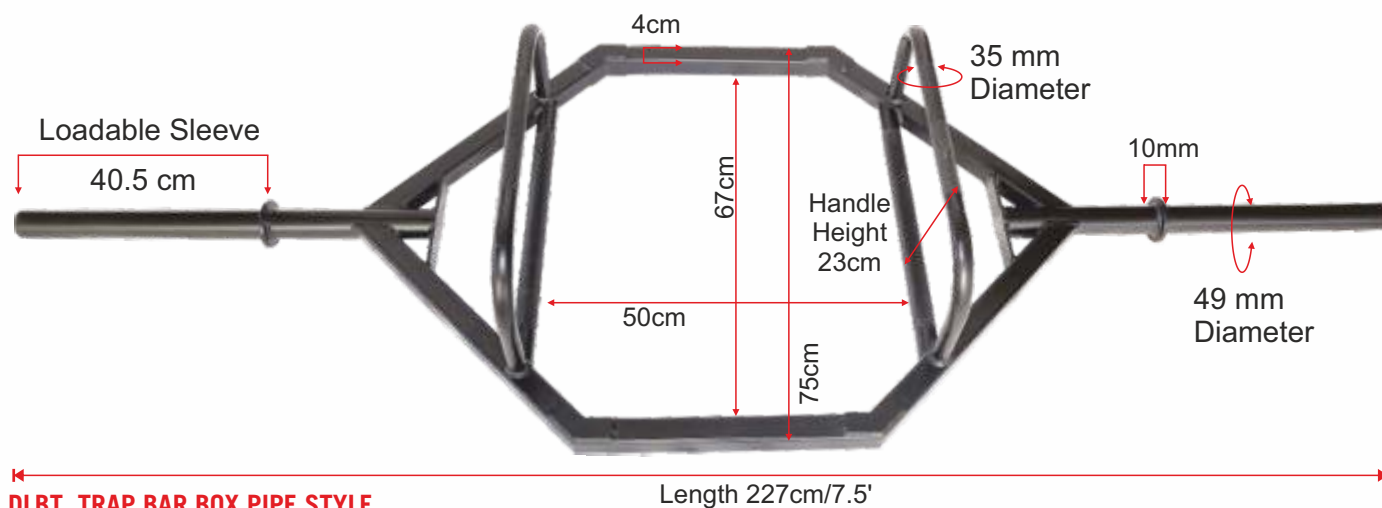
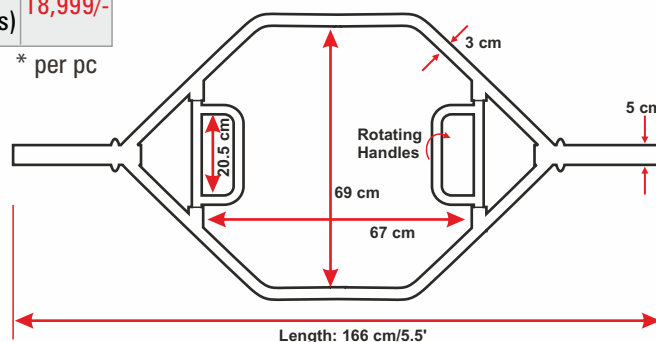

## DLBT TRAP BAR BOX PIPE STYLE

TECH-SPEC.  

- Mild steel box pipe construction
- Mig welded
- Olympic sleeves
- Anti rust powder coated
- Neutral grip
- Fixed raised handles
- Fine knurling on raised and flat grip/ handles
- Can be inverted for use
- Accommodates 50mm/2" olympic hole plates
- Weight capacity: 350kg/770Lbs

Code	Length	Weight	Capacity	MRP
DLBT	227cm/7.5'	23 Kg	350 Kg (770 Lbs)	10,999/-

\* per pc

This technical barbell helps in even distribution of weight. This bar will help you safely do intense squats with maximum weights. It helps you to increase your maximum weight loading in comparison to traditional squats.

**SSB SAFETY SQUAT BAR**



- Alloy steel construction
- Rotating bush sleeves
- Brass bushing
- Safety pads for shoulders & back of neck
- Accommodates 50mm/2" olympic hole plates
- Anti rust powder coated
- Bar spring locks included
- Weight capacity: 350kg/770Lbs

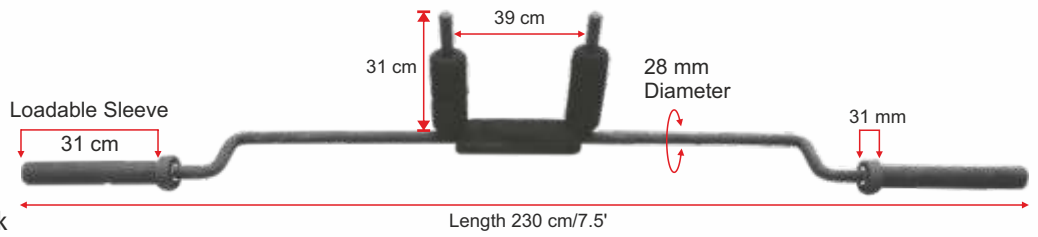

Bar spring locks

Code	Length	Weight	Capacity	MRP
SSB	230cm/7.5'	22.7 Kg	350 Kg (770 Lbs)	19499/-

\* per pc

An essential part of your kit for Strongman training. The neutral grip design helps reduce stress on shoulders while developing maximum strength. The handles are ideally positioned enabling the lifter to maintain proper balance.

**LBR LOG BARBELL**



- Thick gauge steel construction
- Fully welded ends & internal parts
- Anti rust powder coated
- Neutral grip handles with knurling
- Accommodates 50mm/2" olympic hole plates
- Weight capacity: 400kg/900Lbs

\* Powder coated finish is prone to wear with metal contact

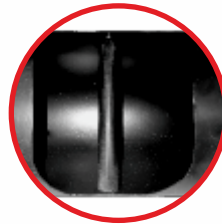

Code	Length	Weight	Capacity	MRP
LBR	170cm/6'	32 Kg	400 Kg (900 Lbs)	19,499/-

\* per pc

**FARMER WALK BARBELL**

USI Universal's farmer walk barbell helps you with a full body workout. It will help you build strength & improve your cardio health. The high intensity workout leads to metabolic conditioning.

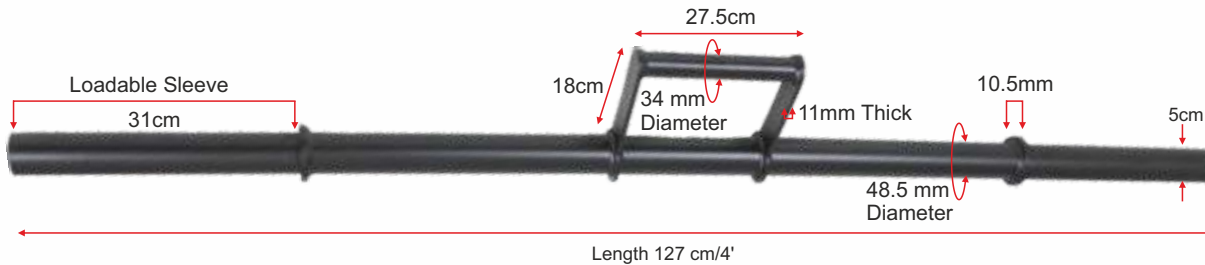

**FBR FARMER WALK BARBELL**



- Mild steel construction
- Mig welded
- Anti rust powder coated
- Ideal for grip & forearm training
- Accommodates 50mm/2" olympic hole plates
- Weight capacity: 160kg/350Lbs/barbell

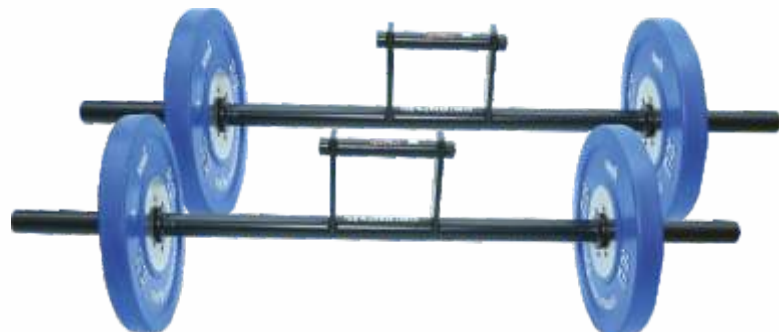

Code	Length	Weight	Capacity	MRP
FBR	127cm/4'	9.35Kg x 2	160 Kg (350 Lbs)	7899/-

\*each bar

\* per pair

# OLYMPIC TRAINING BARS

USI Universal's foam training bar is a great skill development tool which also works to improve the flexibility & range of motion in shoulders as well as overhead movements. It helps in recovery & injury rehabilitation.

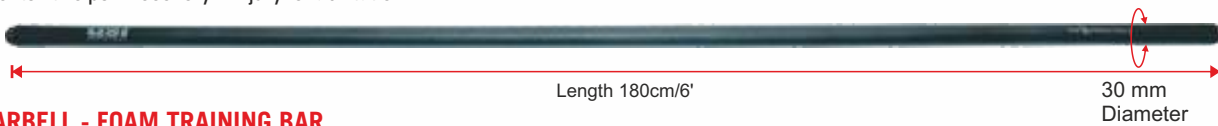

## FTB BARBELL - FOAM TRAINING BAR

TECH-SPEC. 

- PU Foam sleeve & metal construction
- Ideal for beginners, warm up, stretching & skin development

Code	Length	Weight	MRP
FTB	180cm (6')	1.7 Kg	1749/-

\* per pc

# FAT BARS

USI Universal has developed these bars for strongman athletes & the like who are looking to develop their forearms, wrist & grip strength. Either a bench press, deadlift or rowing pulls, the altered grip puts more strain on hands which cannot be achieved by standard barbells.



## AXB AXLE BAR

TECH-SPEC.  

- Mild steel construction
- Mig welded
- Black powder coated
- Ideal for wrist & grip strength
- Great for forearm development
- Adds challenge to pulls & dead lifts
- Accommodates 50mm/2" olympic hole plates
- Weight capacity: 215kg/470Lbs

Code	Length	Weight	Capacity	MRP
AXB	216cm (7')	9.25 Kg	215 Kg (470 Lbs)	4999/-

\* per pc



## BRBR BRANCH ROUND FAT BAR

TECH-SPEC.  

- Mild steel construction
- Mig welded
- Black powder coated
- Ideal for wrist & grip strength
- Great for forearm development
- Adds challenge to pulls & dead lifts
- Accommodates 50mm/2" olympic hole plates
- Weight capacity: 225kg/500Lbs

Code	Length	Weight	Capacity	MRP
BRBR	216cm (7')	15 Kg	225 Kg (500 Lbs)	6499/-

\* per pc



## BMBR BEAM SQUARE FAT BAR

TECH-SPEC.  

- Mild steel construction
- Mig welded
- Black powder coated
- Ideal for wrist & grip strength
- Great for forearm development
- Adds challenge to pulls & dead lifts
- Accommodates 50mm/2" olympic hole plates
- Weight capacity: 225kg/500Lbs

Code	Length	Weight	Capacity	MRP
BMBR	216cm (7')	16.6 Kg	225 Kg (500 Lbs)	6999/-

\* per pc

# BARBELL LOCKS

## CL COMPETITION LOCK

The ultimate locking system for weightlifting competitions as per IWF/WPPO guidelines. This is an engineered product, precision casted & calibrated. It's sleek design enables you to add more plates on the barbell. The lever lock double secures the plates. This design also enables a quick weight change.

**TECH-SPEC.** Performance  Engineered Product 

- High carbon cast iron construction
- Calibrated & precision milled on CNC machines
- Rotation & lever lock system
- As per IWF/WPPO guidelines
- Easy & quick to use
- Weight :- 2.5 Kg 1 collar +/- 10gms.
- Total 5 Kg

Code	Finish	MRP
CL	Chrome	16999/-

\*per pair



## 733LJ EASY LOCK FOR OLYMPIC BARBELL

A revolutionary cam clamp system for securing weight plates. No more messing around with spring collars. Durable Nylon construction & high pressure grip pads enable this product to go through some serious sessions. Now workout with confidence.

**TECH-SPEC.** Advance 

- Engineered Nylon plastic construction
- Cam clamp system to secure on barbell
- Easy on and off
- Ideal for olympic barbell

Code	Color	MRP
733LJ	Black	899/-

\*per pair



## LJ1 EASY LOCK FOR REGULAR BARBELL

**TECH-SPEC.** Advance 

- Engineered plastic construction
- Lock mechanism
- Easy & quick change possible
- Accommodates barbells with 23mm sleeves

Code	Color	MRP
LJ1	Black	499/-

\*per pair



## BRS BARBELL ROD SPRING

**TECH-SPEC.** Base 

- Metal wire construction
- Accommodates barbells with 25mm/1" sleeves

Code	Finish	MRP
BRS	Chrome	99/-

\*per pair



## OSC OLYMPIC SPRING COLLAR

**TECH-SPEC.**

- Spring steel construction
- Accommodates barbells with 50mm/2" sleeves

Code	Finish	MRP
OSC	Chrome	399/-

\*per pair



**LJAL ALUMINIUM OLYMPIC BAR LOCK**  
TECH-SPEC.

Code	MRP
LJAL	1999/-

\* per pair



**LJALM MAGNETIC OLYMPIC BAR LOCK**  
TECH-SPEC.

Code	MRP
LJALM	2499/-

\* per pair



**LJH HYBRID OLYMPIC BAR LOCK**  
TECH-SPEC.

Code	MRP
LJH	1099/-

\* per pair

## BARBELL PADS

Movements like squats, hip thrusters, glute bridges and lunges demand proper posture. USI Universal's Barbell Pad gives comfort, this is important to concentrate on the right movement. Our product ensures proper placement while doing those heavy lists. It covers up for the muscular imbalance on your upper back. You can also avoid bruising from hard knurl marks on the bar. Great tool to avoid injuries.

### BRPB BARBELL PAD BACK BRP BARBELL PAD FRONT

TECH-SPEC.



- Soft dry wicking fabric cover
- Dense foam for comfort and shock absorption
- Improves posture
- Avoid bruising
- Easy to put on and remove from the bar
- Ideal for squats, hip thrusters
- Thick shaft
- Accommodates barbells with 30mm/1.18" sleeves

Code	Color	Dimensions apx	MRP
BRPB	Black	(L) 41cm/16" Dia: 6cm/2.35"	649/-
BRP	Black	(L) 58cm/23" Dia: 6cm/2.35"	899/-

\* per pc



### SQP SQUAT PAD



The squat pad is an anatomically shaped object which sits perfectly between the bar and your shoulders. It allows perfect distribution of weight while you squat.

TECH-SPEC.

- Thermo plastic soft construction
- Anatomic shape to match human shoulders

Code	Color	Width	MRP
SQP	Red	32cm/12.5"	1199/-

\* per pc



## WEIGHT LIFTING CHAINS

USI Universal's weight lifting chains help with variable resistance training. The resistance decreases as you go lower & the chain rests on the floor. It increases as you ascend & the chain lifts. They help with intense workout as the time under tension is increased. From the floor mainly used for dips by placing around the neck. The chains can also be used on barbells for benchpress, squats & deadlifts.



### WL WEIGHTLIFTING CHAINS

TECH-SPEC.  Performance

- Mild steel construction
- Bright zinc coating

Code	Length	Weight (apx)	Finish	MRP
WLH6	180cm/6'	9 Kg X 2	HEAVY	Chrome 7999/-
WLH4	120cm/4'	6 Kg X 2	HEAVY	Chrome 5399/-
WLM6	180cm/6'	4.4 Kg X 2	MEDIUM	Chrome 2999/-
WLM4	120cm/4'	3 Kg X 2	MEDIUM	Chrome 1999/-

\*per pair



## CONNECTION CHAIN



### CC CONNECTION CHAINS

TECH-SPEC.  Advance

- Mild steel construction
- Bright zinc coating
- Snap hook closure

Code	Length	Weight (apx)	Finish	MRP
CC4	120cm/4'	0.5 Kg X 2	CHROME	449/-
CC2	60cm/2'	0.275 Kg X 2	CHROME	349/-

\*per pair



### CLC CHAIN LINK COLLAR

TECH-SPEC.  Performance

- Mild steel construction
- Mig welded
- Bright zinc coated
- Nut bolt closure

Code	Finish	MRP
CLC	CHROME	2749/-

\*per pair





## LANDMINE TRAINERS

USI Universal's landmine trainers help you do many difficult lifting movements comfortably. Ideal for athletes undergoing injury rehabilitation or those who are unable to perform with good form. Great product for doing rotational drills. Ideal for commercial & home use.

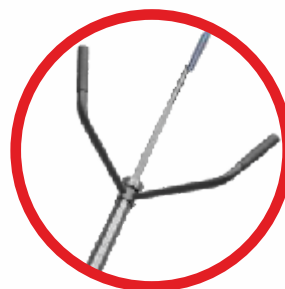

### CT LANDMINE WITH T-BAR

TECH-SPEC.



- Ideal for use with olympic plates & barbell
- Metal construction
- Fully welded ends
- Anti rust powder coated

Code	Color	MRP
CT	Black	10499/-

\* per pc

## LANDMINE TUBE TRAINER

### CTRC LANDMINE TUBE TRAINER

TECH-SPEC.



- Metal construction
- Fully welded ends
- Ideal for use with olympic barbell
- Anti rust powder coated
- Rubberised handles

Code	Color	MRP
CTRC	Black	2799/-

\* per pc



### BJK DEADLIFT BAR JACK

TECH-SPEC.

Code	MRP
BJK	7799/-

\* per pc

### BJM DEADLIFT BAR JACK MINI

TECH-SPEC.

Code	MRP
BJM	2999/-

\* per pc

### BJL ICE PICK DEADLIFT BAR JACK

TECH-SPEC.

Code	MRP
BJL	3999/-

\* per pc

## ARM BLASTERS

USI Universal's arm blaster is a simple yet genius product to help you keep a proper form while doing bicep exercises. It does so by keeping your arms in a fixed position. Ideal for those who want to achieve the next level of muscle definitions & strength.



### ABL ARM BLASTER (FOR BICEPS)

- TECH-SPEC.**  
- 5mm light weight metal construction
  - Anti rust powder coated
  - Adjustable nylon neck hanging strap
  - Cushioned arm rest position
  - Ideal support system for biceps muscle

Code	Color	Width	MRP
ABL	Black	53cm/21"	1499/-

\* per pc



### ARMB ARM BLASTER BEAST

This is for bigger users who find it difficult to adjust in our regular arm blaster (ABL). The design allows you to isolate your arms and shoulders which enables to build lean and big muscles.

- TECH-SPEC.**  
- 5mm heavy metal construction
  - Anti rust powder coated
  - Adjustable neck strap
  - Cushioned neck and arm rest position

Code	Width	Weight	Color	MRP
ARMB	66cm(26")	920g	Red	1799/-

\* per pc



### ARM BLASTER

- TECH-SPEC.**  
- Light weight metal construction
  - Anti rust powder coated
  - Attractive prints
  - Adjustable nylon neck hanging strap
  - Cushioned arm rest position
  - Ideal support system for biceps muscle

Code	Color	Width	MRP
ABL(C)	Contra	53cm/21"	2299/-
ABL(F)	Inferno		
ABL(CR)	Carbonium		

\* per pc



# CABLE ATTACHMENTS

## TRICEP STRAPS/WRAPPS

USI Universal's tricep straps can be used with any pulley or leverage system. Ideal for cable curls, face pulls, cable crunches, etc. Customers can choose from different lengths, materials, hand cushioned as per their comfort & exercise to be done.

### LTRS LEATHER TRICEP STRAP

- TECH -SPEC.**  
- Leather construction
  - Soft neoprene padded hand portion

Code	Size	Color	MRP
LTRS	32cm/12.5"	Tan/Black	1049/-

\* per pc



### 7035 AB STRAP LONG

- TECH -SPEC.** 
- Heavy duty webbing
  - Reinforced stitching

Code	Size	Color	MRP
7035	76x5cm (30"x2")	Blue	399/-

\* per pc



### 7010 AB PULLEY

- TECH -SPEC.** 
- Heavy duty webbing
  - Soft neoprene padded hand section

Code	Size apx	MRP
7010	46cm/18"	750/-

\* per pc



### 7034 SHORT AB STRAP SHORT

- TECH -SPEC.** 
- Heavy duty webbing
  - Reinforced stitching

Code	Size	Color	MRP
7034	41x5cm(16"x2")	Blue	300/-

\* per pc



### SOFT GRIP ATTACHMENT (STIRRUP)

An ultimate accessory for your Cable Machine. The Soft Grip Attachment is ideal for biceps and triceps workouts enabling you to perform all your lifting and pull exercises. The soft foam cushion keeps your sweat free and comfortable. The Nylon strap makes it strong enough to hold maximum weight.

### SGA GREY WITH BLACK GRIP

- TECH -SPEC.**    
- Light duty
  - Foam , plastic and webbing construction.
  - Ideal for cable machine attachments.

Code	Strap Color	MRP
SGA	Grey	299/-

\* per pc



### SGAH STRAP ALL BLACK

- TECH -SPEC.**   
- Heavy duty
  - Foam , plastic and webbing construction.
  - Ideal for cable machine attachments.

Code	Strap Color	MRP
SGAH	Black	399/-

\* per pc



# ANKLE/WRIST CUFFS

USI Universal's cuffs work with any cable pulley system, weight lifting equipments, resistance bands, glutes workout machines etc. Ideal for lower & upper body workout. Our cuff's are most effective for leg & glutes workouts.

### 7007 LEATHER ANKLE CUFF

- TECH -SPEC.**  
- Top grain hide leather construction
  - Soft Neoprene lining
  - Strong metal 'D' rings
  - Hook & loop closure

Code	Color	MRP
7007	Tan/Black	749/-

\* per pc



### 7006 NYLON ANKLE CUFF

- TECH -SPEC.** 
- Nylon webbing
  - Soft Neoprene lining
  - Hook & loop closure

Code	Color	MRP
7006	Black	299/-

\* per pc



## MULTI GRIP LAT BAR

This product is compatible with most lat pulldown/low row machines. Customers can quickly switch from a narrow to a wide grip as per goal or comfort. Ideal for high intensity pull down & rowing.



### MGLB MULTI GRIP LAT BAR



- Alloy steel construction
- Four different handle positions with knurling
- Ideal for heavy pull downs & rowing
- Anti rust powder coated

Code	Length	Capacity	MRP
MGLB	123cm/4'	110 Kg/242 Lbs	14,999/-

\* per pc

## CABLE ATTACHMENTS

USI Universal's cable attachments allow for a natural hand grip & superior arm position which is in sync to activate various muscle groups on your back. The customer does not have to worry about grip failure. You would be able to have a better mind-muscle connection using this product.



- Mild steel construction
- Promotes optimal back workout
- Superior hand grip control
- Allows neutral, supinate & pronate variations
- Anti rust powder coated

Code	TYPE	Wt. Capacity	MRP
CAL	Large	60 Kg/130Lbs	5999/-
CAM	Medium	60 Kg/130Lbs	5599/-
CAS	Small	60 Kg/130Lbs	5499/-
CAN	Close Grip Narrow	80 Kg/175Lbs	5299/-
CAW	Close Grip Wide	80 Kg/175Lbs	5199/-

\* per pc

CAL: 71cm  
Wt. 3.2 kg

CAM: 57cm  
Wt. 3 kg

CAS: 49cm  
Wt. 2.95 kg

CAN: 32cm  
Wt. 2.7 kg

CAW: 30cm  
Wt. 2.95 kg



# CABLE ATTACHMENTS

This product is compatible with most lat pulldown/low row machines. Customers can quickly switch from a narrow to a wide grip as per goal or comfort. Ideal for high intensity pull down & rowing.

## CARK CABLE ATTACHMENT STORAGE RACK ONLY

TECH-SPEC.

Code	MRP
CARK	10999/-

\* per pc



## CAH CABLE ATTACHMENT HANDLE

TECH-SPEC.

Code	MRP
CAH	1199/-

\* per pc



## CAUH CABLE ATTACHMENT U HANDLE

TECH-SPEC.

Code	MRP
CAUH	2999/-

\* per pc



## CALB LAT BAR BIG

TECH-SPEC.

Code	MRP
CALB	3999/-

\* per pc



## CATR TRICEP ROPE

TECH-SPEC.

Code	MRP
CATR	1149/-

\* per pc



## CATVS TRICEP V SHAPE HANDLE

TECH-SPEC.

Code	MRP
CATVS	1699/-

\* per pc



## CALBS PRO LAT BAR SMALL

TECH-SPEC.

Code	MRP
CALBS	3299/-

\* per pc

# CABLE ATTACHMENTS



**CAMEB MULTI EXERCISE BAR**  
TECH-SPEC.

Code	MRP
CAMEB	2499/-

\* per pc



**CAPLBL PRO LAT BAR LARGE**  
TECH-SPEC.

Code	MRP
CAPLBL	5299/-

\* per pc



**CAPLBM PRO LAT BAR MEDIUM**  
TECH-SPEC.

Code	MRP
CAPLBM	4799/-

\* per pc



**CAPLBS PRO LAT BAR SMALL**  
TECH-SPEC.

Code	MRP
CAPLBS	4499/-

\* per pc



**CAVH CABLE ATTACHMENT V HANDLE**  
TECH-SPEC.

Code	MRP
CAVH	2249/-

\* per pc



**CASB SHORT BAR**  
TECH-SPEC.

Code	MRP
CASB	1899/-

\* per pc



**CASTR SINGLE TRICEP ROPE**  
TECH-SPEC.

Code	MRP
CASTR	849/-

\* per pc



**CATPB TRICEP PRESS DOWN BAR**  
TECH-SPEC.

Code	MRP
CATPB	2899/-

\* per pc



**CATPH TRICEP PRESS DOWN HANDLE**  
TECH-SPEC.

Code	MRP
CATPH	3299/-

\* per pc

**IMMORTAL** CABLE ATTACHMENTS



**ICSK IMMORTAL CABLE ATTACHMENT STORAGE RACK ONLY**

**TECH-SPEC.**

Code	MRP
ICSK	1,44,999/-

\*MRP per set



**ICLB IMMORTAL CABLE ATTACHMENT LAT BAR DOUBLE POSITION**

**TECH-SPEC.**

Code	MRP
ICLB	29999/-

\*MRP per pc.



**ICSR IMMORTAL CABLE ATTACHMENT SEATED ROW DOUBLE POSITION**

**TECH-SPEC.**

Code	MRP
ICSR	20999/-

\*MRP per pc.



**ICTB IMMORTAL CABLE ATTACHMENT TRICEP BAR DOUBLE POSITION**

**TECH-SPEC.**

Code	MRP
ICTB	16999/-

\*MRP per pc.







**ICPD IMMORTAL CABLE ATTACHMENT PULL DOWN BAR**

**TECH-SPEC.**

Code	MRP
ICPD	6499/-

\*MRP per pc.

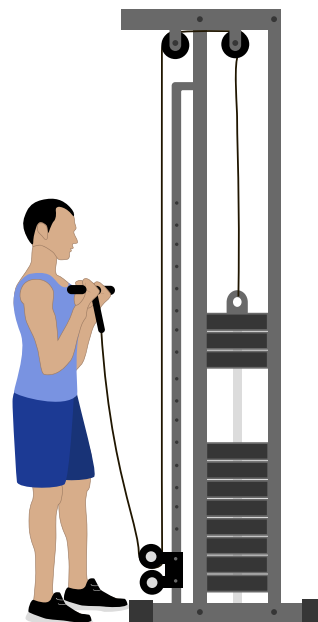

**IC2 IMMORTAL CABLE ATTACHMENT LEVEL-2**

**TECH-SPEC.**

Code	MRP
IC2	6499/-

\*MRP per pc.



**IC1 IMMORTAL CABLE ATTACHMENT LEVEL-1**

**TECH-SPEC.**

Code	MRP
IC1	10999/-

\*MRP per pc.





**ICSRs IMMORTAL CABLE ATTACHMENT SEATED ROW**

TECH-SPEC.

Code	MRP
ICSRs	5499/-

\*MRP per pc.

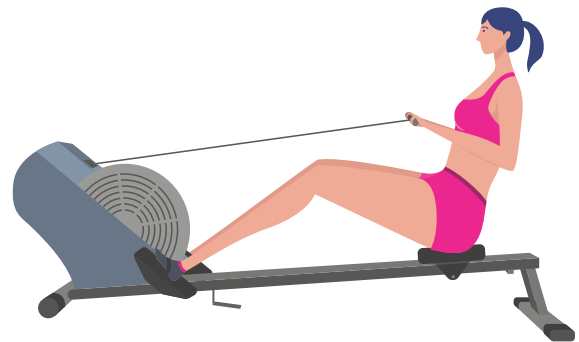

**ICCHL IMMORTAL CABLE HANDLES LIGHT DUTY**

TECH-SPEC.

Code	MRP
ICCHL	999/-

\*MRP per pair

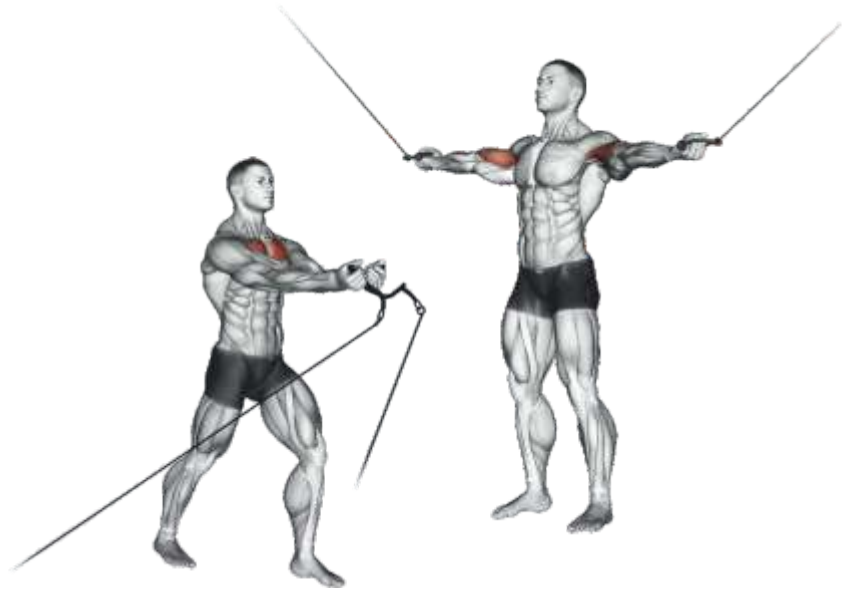

**ICTR IMMORTAL TRICEP ROPE**

TECH-SPEC.

Code	MRP
ICTR	3499/-

\*MRP per pc.

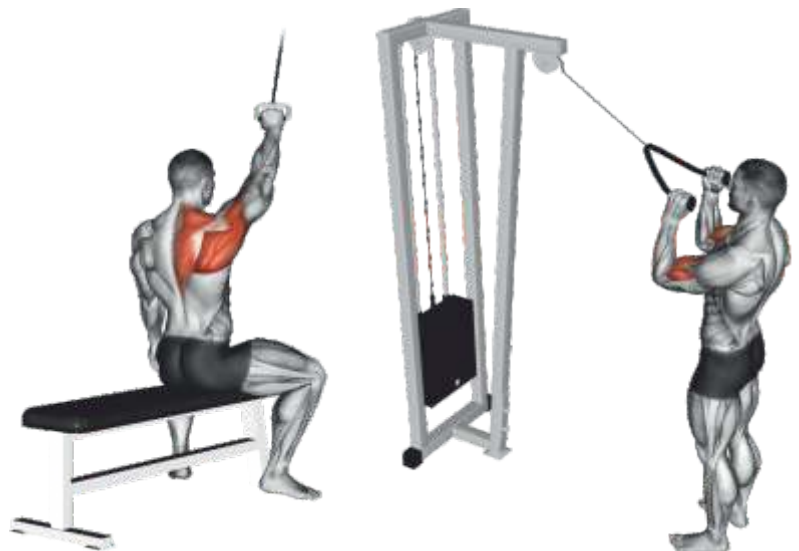

## DEAD LIFT PLATFORM

USI Universal's dead lift platform has been developed to make your lifting environment safer. Our lifting platform will absorb the force when you drop or lower the weight. Hence, preventing the damage to the floor, the barbells & the plates. Wood surface under the feet gives a firm & levelled standing area. The rubber on the sides absorbs the weight drops. The metal frame keeps all elements intact. Ideal for commercial & home use.



### DEAD LIFT PLATFORM



- Metal, rubber and wood construction
- 40mm thickness
- Pegs for tying latex loop bands
- 'S' holders for bolting to ground
- Anti rust powder coated
- Dimensions: 122cm x 244cm (4'x8') apx.

### DEADLIFT PLATFORM SET INCLUDES:

Code	Weight	MRP
DLP	Deadlift platform metal frame	12499/-
DLPR	Wood plank for Deadlift platform	16999/-
WT20	Rubber tiles for sides 13 pcs@860	11180/-

MRP 40678/-



\* per set



# GLUTE HAM DEVELOPER

This is a multipurpose bench which enables the user to perform hamstring and back exercise. Padded for comfort. Vertical and horizontal adjustment accommodating users of various sizes.

## GHD GLUTE HAM DEVELOPER

- TECH-SPEC.**   
- Heavy gauge metal & foam construction
  - Anti rust power coated
  - Adjustable & portable
  - Ships flat packed

Code	MRP
GHD	44,499/-

\* per set

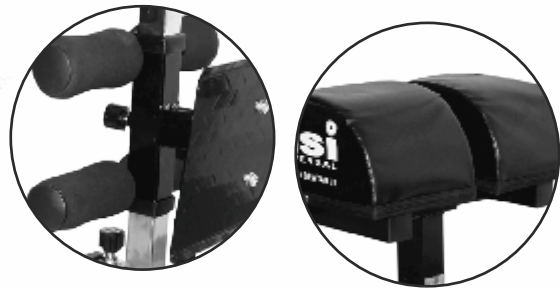

# ARM WRESTLING TABLE

A perfect piece of equipment for competitions in gyms, bars, malls & expos. A full package of health & entertainment. Ideal for competition as per international guidelines.

## AWT ARM WRESTLING TABLE

- TECH-SPEC.**  
- Metal, wood and foam construction
  - Anti rust powder coated
  - Sturdy design
  - As per international guidelines
  - Adjustable for standing and sitting
  - Comes flat packed
  - \*Can be bolted to ground/floor

Code	Dimensions apx	MRP
AWT	91.5cm(L) x 66cm(B) x 103cm(H) 36"x26"x41"	15499/-

\* per set



# SQUAT / YOKE STAND

## SQR SQUAT STAND

Ideal for home and commercial use. A sturdy structure for your flat, incline shoulder bench press, squats, curls, rows, etc.



- 3mm (11 gauge construction)
- Precision holes for stand and bench adjustment
- 72 x 72 mm (3") uprights
- Dimensions 120x125x180cm (48x49x72")
- Comes flat packed
- 10 sets 14mm precision nuts, bolts and washers
- 25mm spacing for bench and 50mm for standard squats
- Weight capacity: 450 Kg/1000 Lbs

Code	MRP
SQR	20499/-

Optional equipments (not included in MRP):

RSA Safety Spotter arms

JCP J cups

Choice of barbell :

OB750, OB500, OB350

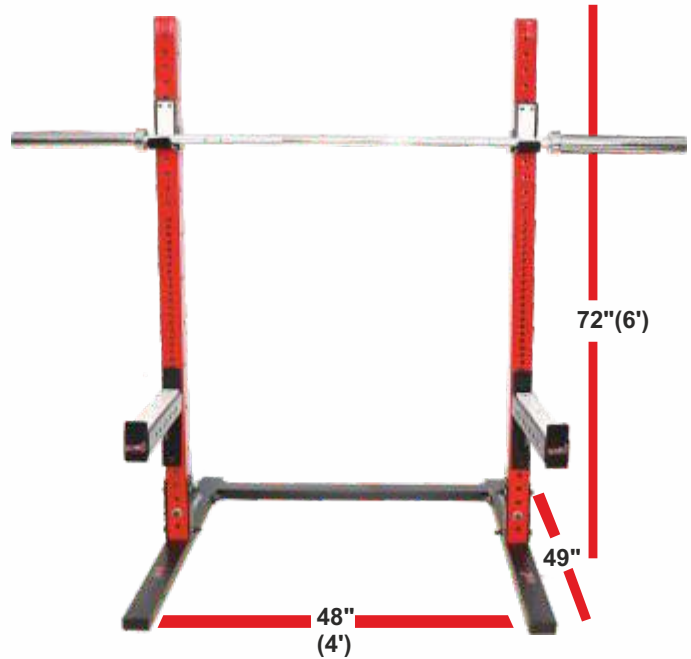

## YK YOKE STAND

Ideal for yoke carry can be converted for squats , incline shoulder, bench press & dead lift.



- Heavy gauge metal construction
- Adjustable crossbar as per required height
- Precision holes for squat & bench adjustment
- 14 sets 14mm precision nuts, bolts and washers
- 72 x 72 mm (3") uprights
- Dimensions: 122x127x182cm (48"x50"x72")
- Comes flat packed
- Anti rust powder coated
- Weight capacity as yoke carry: 225 kg/500lbs
- Weight capacity as squat stand: 450 kg/1000lbs



Code	MRP
YK	25999/-

Optional equipments (not included in MRP):

JCP J cup x 1 , RBP Bumper plate Pin x 2

Ideal for home and commercial use.

Additional weight capacity: 100 Kg/220Kg

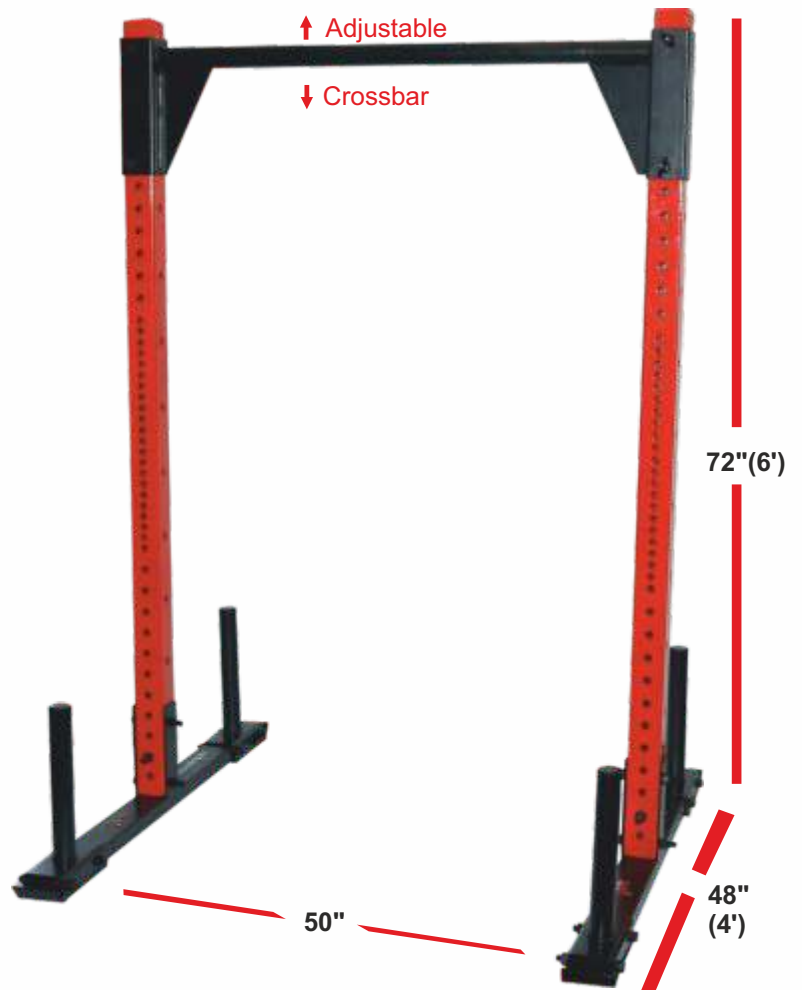

# SQUAT STAND

## ISQ SQUAT STAD

The individual squat pillars are easy to move around & set up. They take much less space in storage. Ideal for commercial & home use.



- 3mm (11 gauge) construction
- 72 x 72 mm (3") uprights
- 14 sets precision nuts, bolts & washers
- Comes flat packed
- 25mm spacing for bench & 50mm for standard squats
- Anti rust powder coated
- Weight Capacity: 320Kg/700Lbs

Code	MRP
ISQ	22999/-

Optional equipments (not included in MRP):

JCP J cups , Bumper Plates

Choice of barbell :

OB750, OB500, OB350

Ideal for home and commercial use. A sturdy structure for your flat, incline shoulder bench press, squats, curls, rows etc.



## SQB SQUAT STAND

(With Monkey Bar, SNB)

Ideal for pull ups, squats, bench , floor press etc.

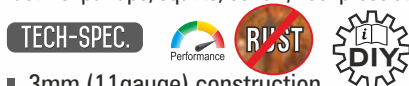

- 3mm (11 gauge) construction
- 72 x 72 mm (3") uprights
- 14 sets precision nuts, bolts & washers
- Comes flat packed
- 25mm spacing for bench & 50mm for standard squats
- Anti rust powder coated
- Weight Capacity: 320Kg/700Lbs
- Monkey bar weight capacity: 135Kg/300Lbs
- Squat Stand weight capacity: 450Kg/1000Lbs

Code	MRP
SQB	25999/-

Optional equipments (not included in MRP):

JCP, BUMPER PLATES

Choice of barbell :

OB750, OB500, OB350

Ideal for home and commercial use.



# POWER RACK



### PRH POWER RACK HALF

TECH-SPEC.



- 3mm (11 gauge) construction
  - 72 x 72 mm (3") uprights
  - 14 mm precision nuts, bolts & washers
  - 25mm spacing for bench & 50mm for standard squats
  - Anti rust powder coated
  - Weight capacity: 400 kg/880 lbs
- \*Rack must bolt to the floor

Code	MRP
PRH	67886/-

RUR7.5 Upright	4 pcs	11,499	45,996
RCMN Cross beam Mini	4 pcs	2,299	9,196
RCBS Cross beam Small	1 pc	4,799	4,799
RBPG Band Pegs	1 set	2,399	2,399
RMBS Monkey bar small	1 pc	1,699	1,699
JCP J Cups	1 pair	2,199	2,199
SNB Spare nuts & bolts	2 set	799	1,598
<b>Total</b>			<b>67,886</b>

### PRN POWER RACK NORMAL

TECH-SPEC.



- 3mm (11 gauge) construction
- 72 x 72 mm (3") uprights
- 14 mm precision nuts, bolts & washers
- 25mm spacing for bench & 50mm for standard squats
- Anti rust powder coated
- Weight capacity: 450 kg/1000 Lbs

Code	MRP
PRN	86885/-

RUR7.5 Upright	4 pcs	11,499	45,996
RCBS Cross beam Small	5 pcs	4,799	23,995
RSP Safety Spotter Pin	1 pair	8,999	8,999
RMBS Monkey bar small	1 pc	1,699	1,699
SNB Spare nuts & bolts	2 set	799	1,598
JCP J Cups	1 pair	2,199	2,199
RBPG Band Pegs	1 set	2,399	2,399
<b>Total</b>			<b>86,885</b>



# POWER RACK

## PRM POWER RACK MULTI

TECH-SPEC.



- 3mm (11 gauge) construction
- 72 x 72 mm (3") uprights
- 14 mm precision nuts, bolts & washers
- 25mm spacing for bench & 50mm for standard squats
- Anti rust powder coated
- Weight capacity: 450 Kg/1000Lbs

Code	MRP
PRM	1,30,773/-

RUR7.5 Upright	6 pcs	11,499	68,994
RCBS Cross beam Small	5 pc	4,799	23,995
RCMN Cross beam Mini	4 pcs	2,299	9,196
RMBS Monkey bar small	2 pc	1,699	3,398
SNB Spare nuts & bolts	3 set	799	2,397
RSP Safety Spotter Pin	1 pair	8,999	8,999
JCP J Cups	1 pair	2,199	2,199
RBP Bumper Plate Pins	4 pcs	2,299	9,196
RBPG Band Pegs	1 set	2,399	2,399
<b>Total</b>			<b>1,30,773</b>

\*Bumper Plates not included in MRP



## BPRN POWER RACK WITH STORAGE

TECH-SPEC.



- 3mm (11 gauge) construction
- 72 x 72 mm (3") uprights
- 14 mm precision nuts, bolts & washers
- 25mm spacing for bench & 50mm for standard squats
- Anti rust powder coated
- Weight capacity: 450 Kg/1000Lbs

Code	MRP
BPRN	1,25,377/-

RUR7.5 Upright	4 pcs	11,499	45,996
RCBS Cross beam Small	4 pc	4,799	19,196
BPLT Branding Plate	1 pc	20,899	20,899
RMBS Monkey bar small	1 pc	1,699	1,699
SNB Spare nuts & bolts	6 set	799	4,794
RBPG Band Pegs	1 set	2,399	2,399
JCP J Cups	1 pair	2,199	2,199
RSMT Rig Storage Mount	2 pair	6,999	13,998
CMBS Cross Member small	2 pcs	5,199	10,398
STS Storage Trey for kettlebells	1 pc	3,799	3,799
<b>Total</b>			<b>1,25,377</b>





# FREESTANDING RIGS

**THE EXPANDABLE TRAINING RIGS**



## CUSTOMISE YOUR RIG.

USI Universal's free standing rigs are independent units & infinitely expandable to create a perfect workout station which suits your regular needs. The limit is only your available space. All made of 72mm x 72mm (3" x 3"), 3mm (11 gauge) mild steel with precision drilled holes & mig welding.

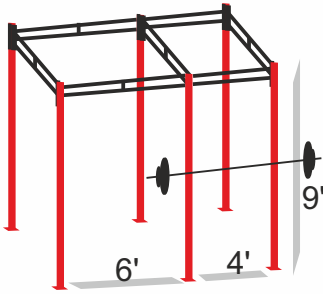

**MRP: 132886/-**  
**RG10** 10'(L) x 6'(W) x 9'(H) (3m apx.)  
 ■ 6 Upright Bars, 1 pair J Cups  
 ■ 5 cross members big, 2 cross members small  
 \*Barbell & Bumper plates will be extra

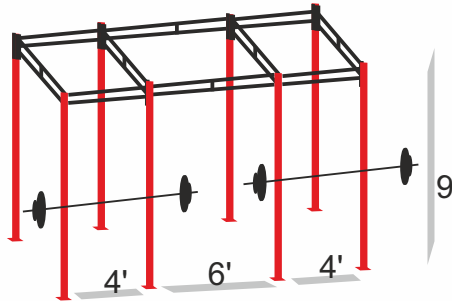

**MRP: 180580/-**  
**RG14** 14'(L) x 6'(W) x 9'(H) (4.25m apx.)  
 ■ 8 Upright Bars, 2 pair J Cups  
 ■ 6 cross members big, 4 cross members small

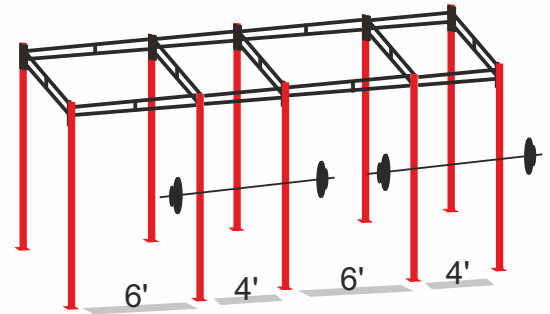

**MRP: 230675/-**  
**RG20** 20'(L) x 6'(W) x 9'(H) (6m apx.)  
 ■ 10 Upright Bars, 2 pair J Cups  
 ■ 9 cross members big, 4 cross members small

**MRP: 278369/-**  
**RG24** 24'(L) x 6'(W) x 9'(H) (7.3m apx.)  
 ■ 12 Upright Bars, 3 pair J Cups  
 ■ 10 cross members big, 6 cross members small



\*Please refer to **Rig Accessories Pages** for alternative options which may not be included in standard model.  
 \*Images shown here may be different from the original.  
 \*Rig accessory/Barbell/Bumper Plates extra.

\*Rs. 1000/- for Extra color

\*Upright Bar's Color Options:



**Important Note:** USI Universal rigs should be fitted under expert supervision on a solid floor using appropriate fixing.

# WALLMOUNTED RIGS

THE EXPANDABLE TRAINING RIGS

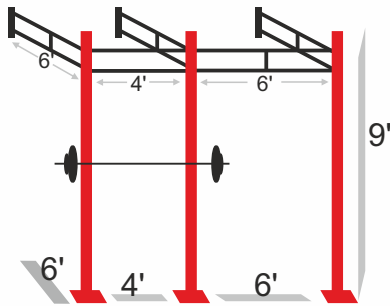

**MRP: 78791/-**  
**WRG10** 10'(L) x 6'(W) x 9'(H) (3m apx.)  
 ■ 3 Upright Bars, 1 pair J Cups  
 ■ 4 cross members big, 1 cross members small



## CUSTOMISE YOUR RIG.

USI Universal's wallmount rigs are infinitely expandable to create a perfect workout station which suits your regular needs. The limit is only your available space.

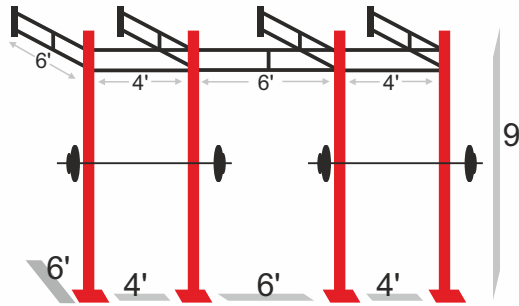

**MRP: 107487/-**  
**WRG14** 14'(L) x 6'(W) x 9'(H) (4.25m apx.)  
 ■ 4 Upright Bars, 2 pair J Cups  
 ■ 5 cross members big, 2 cross members small

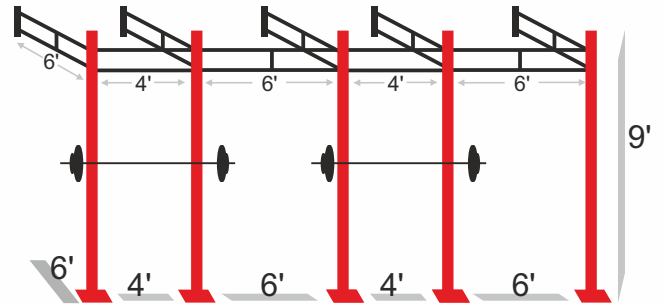

**MRP: 136284/-**  
**WRG20** 20'(L) x 6'(W) x 9'(H) (6m apx.)  
 ■ 5 Upright Bars, 2 pair J Cups  
 ■ 7 cross members big, 2 cross members small

**MRP: 164980/-**  
**WRG24** 24'(L) x 6'(W) x 9'(H) (7.3m apx.)  
 ■ 6 Upright Bars, 3 pair J Cups  
 ■ 8 cross members big, 3 cross members small  
 \*Barbell & Bumper plates will be extra

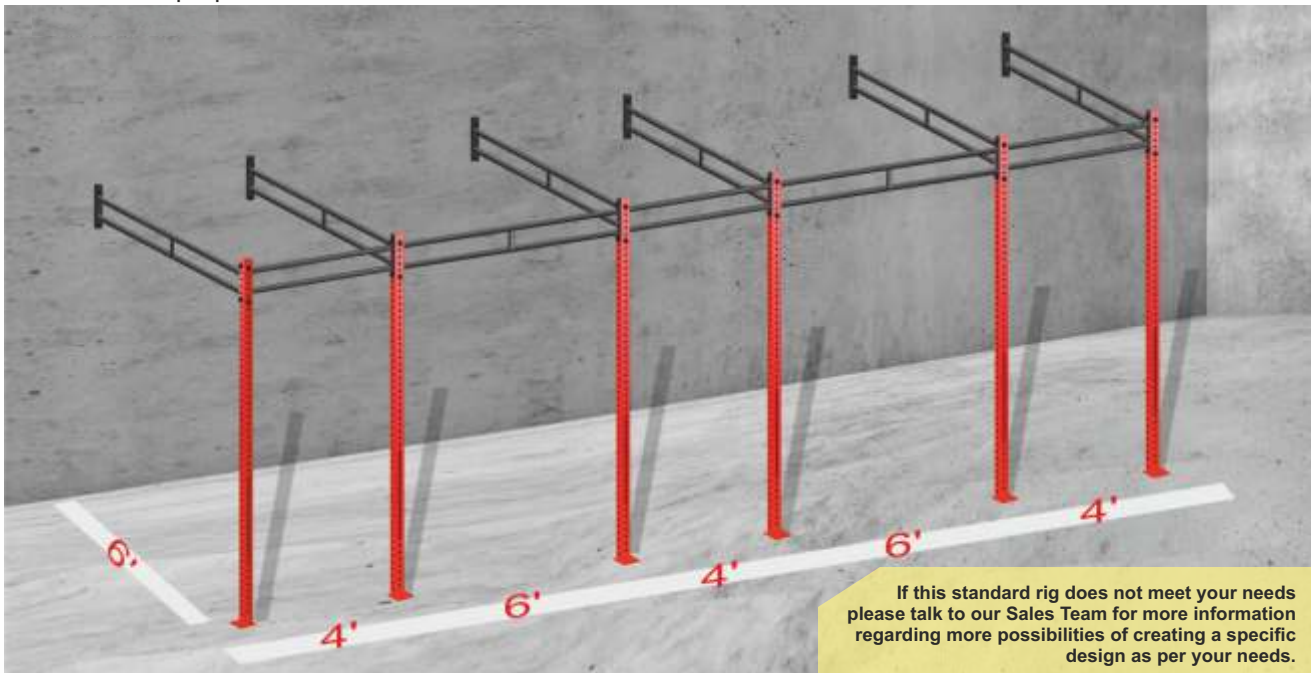

If this standard rig does not meet your needs please talk to our Sales Team for more information regarding more possibilities of creating a specific design as per your needs.



\*Please refer to [Rig Accessories Pages](#) for alternative options which may not be included in standard model.  
 \*Images shown here may be different from the original.  
 \*Rig accessory/Barbell/Bumper Plates extra.

\*Rs. 1000/- for Extra color  
 \*Upright Bar's Color Options:



**Important Note:** USI Universal wall mount rigs should be fitted under expert supervision on a solid wall and floor using appropriate fixing.

# MONKEY RIGS



## MRIG24 Monkey Rig 24' (7.3m)

- 24' (L) x 6' (W) x 9' to 12' (H)
- 6 Squat/Bench stations
- Monkey walk incline/decline



RUR9 Upright	12 pcs	13,799	1,65,588
EUR upright extension	4 pcs	5099	20,396
ACB6 angled cross beam big	4 pcs	6899	27,596
RCBS Cross beam Small	6 pcs	4,799	28,794
RMBB Monkey bar big	24 pcs	2499	59,976
SNB Spare nuts & bolts	24 set	799	19,176
	<b>Total</b>		<b>3,21,526</b>

Monkey Rigs are advance level Rigs. Incline & decline feature increase the challenge for advanced level athletes

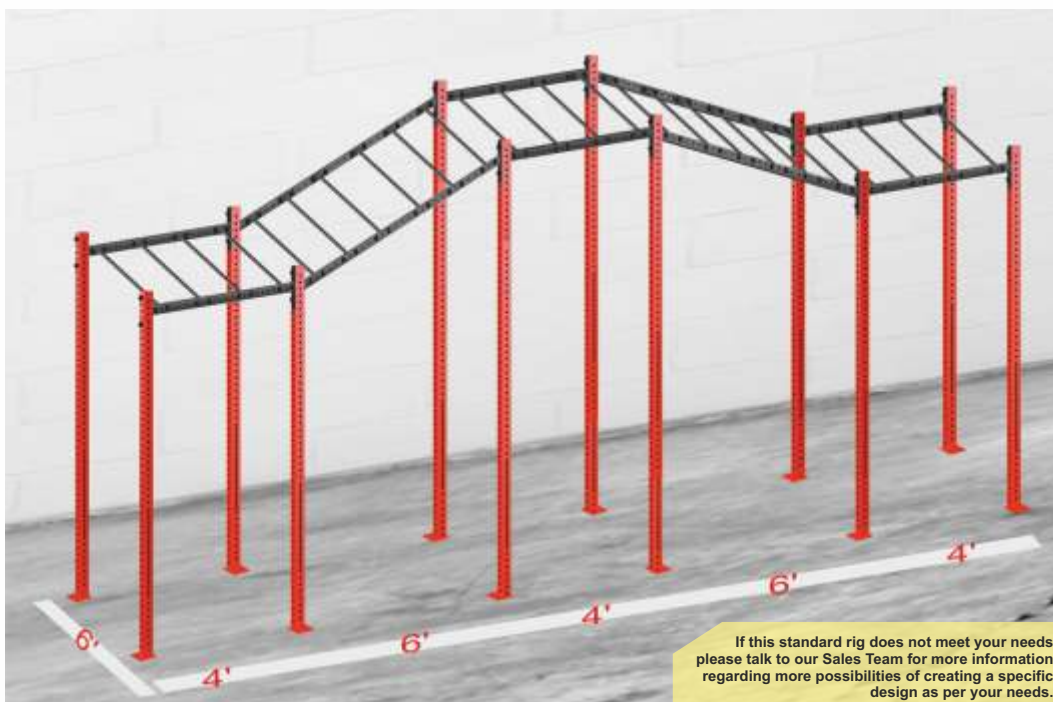

If this standard rig does not meet your needs please talk to our Sales Team for more information regarding more possibilities of creating a specific design as per your needs.

## MRIG20 Monkey Rig 20' (6.10m)

- 20' (L) x 6' (W) x 9' to 12' (H)
- 4 Squat/Bench Stations
- Monkey walk incline/decline



RUR9 Upright	10 pcs	13,799	1,37,990
EUR upright extension	4 pcs	5099	20,396
ACB6 angled cross beam big	4 pcs	6899	27,596
RCBS Cross beam Small	4 pcs	4,799	19,196
RMBB Monkey bar big	20 pcs	2499	49,980
SNB Spare nuts & bolts	20 set	799	15,980
	<b>Total</b>		<b>2,71,138</b>



If this standard rig does not meet your needs please talk to our Sales Team for more information regarding more possibilities of creating a specific design as per your needs.

# MONKEY RIGS

## MRIG16 Monkey Rig 16' (4.9m)

- 16' (L) x 6' (W) x 9' to 12' (H)
- 2 Squat/Bench stations
- Monkey walk incline/decline



RUR9 Upright	8 pcs	13,799	1,10,392
EUR upright extension	4 pcs	5099	20,396
ACB6 angled cross beam big	4 pcs	6899	27,596
RCBS Cross beam Small	2 pcs	4,799	9,598
RMBB Monkey bar big	16 pcs	2499	39,984
SNB Spare nuts & bolts	16 set	799	12,784
<b>Total</b>			<b>2,20,750</b>

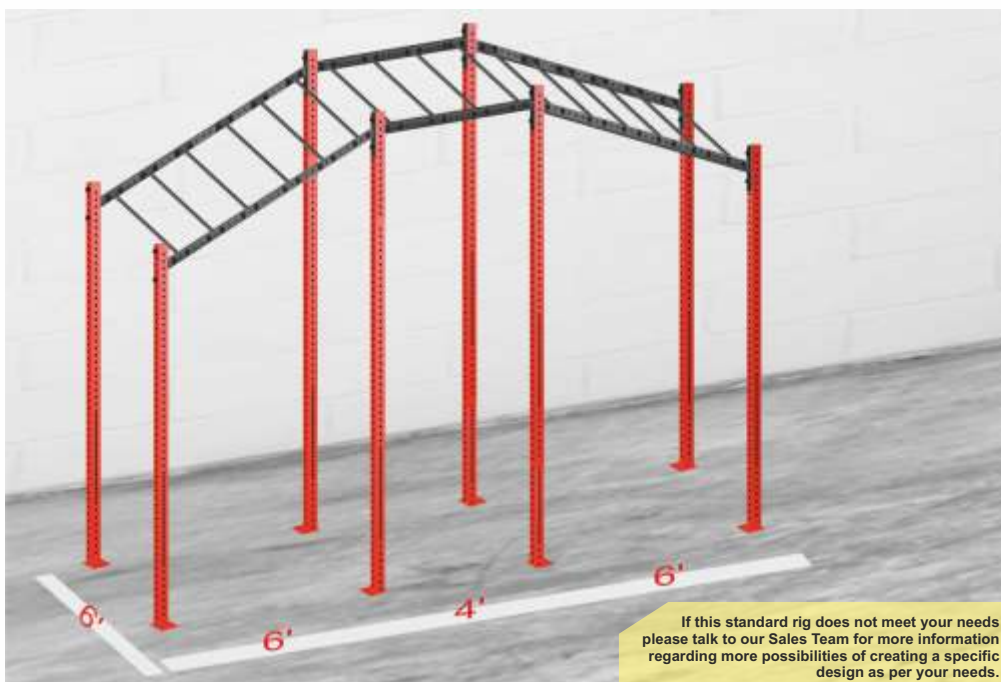

## MRIG10 Monkey Rig 10' (3m)

- 10' (L) x 6' (W) x 9' to 12' (H)
- 2 Squat/Bench Stations
- Monkey walk incline/decline



RUR9 Upright	6 pcs	13,799	82,794
EUR upright extension	4 pcs	5099	20,396
ACB6 angled cross beam big	2 pcs	6899	13,798
RCBS Cross beam Small	2 pcs	4,799	9,598
RMBB Monkey bar big	10 pcs	2499	24,990
SNB Spare nuts & bolts	10 set	799	7,990
<b>Total</b>			<b>1,59,566</b>

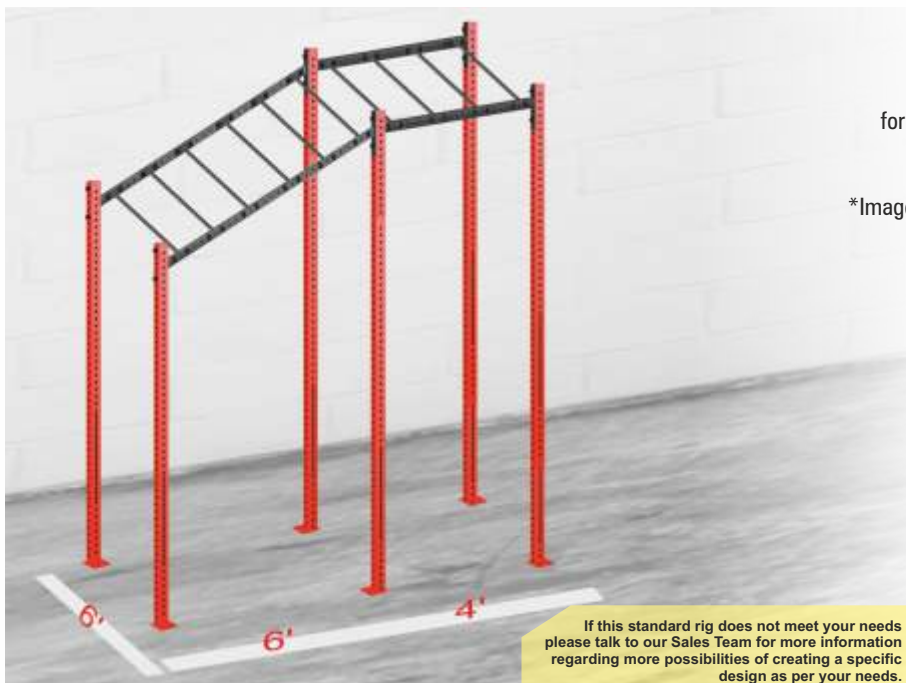

\*Please refer to [Rig Accessories Pages](#) for alternative options which may not be included in standard model.

\*Images shown here may be different from the original.  
\*Rig accessory/Barbell/Bumper Plates extra.

# ROOF MOUNTED RIG

## Roof Mounted Rig

- **RDD2** Roof Drop Down 2' **MRP: 3699/-**
- **RDD3** Roof Drop Down 3' **MRP: 4599/-**
- **RDD4** Roof Drop Down 4' **MRP: 5749/-**

- 3mm (11 gauge) square pipe construction (72x72mm)
- Precision holes on all sides for modular fitting
- 4 sets 14mm precision nuts, bolts & washers

\*4 pcs M12 anchor bolts included with each drop down



## Roof Drop Downs

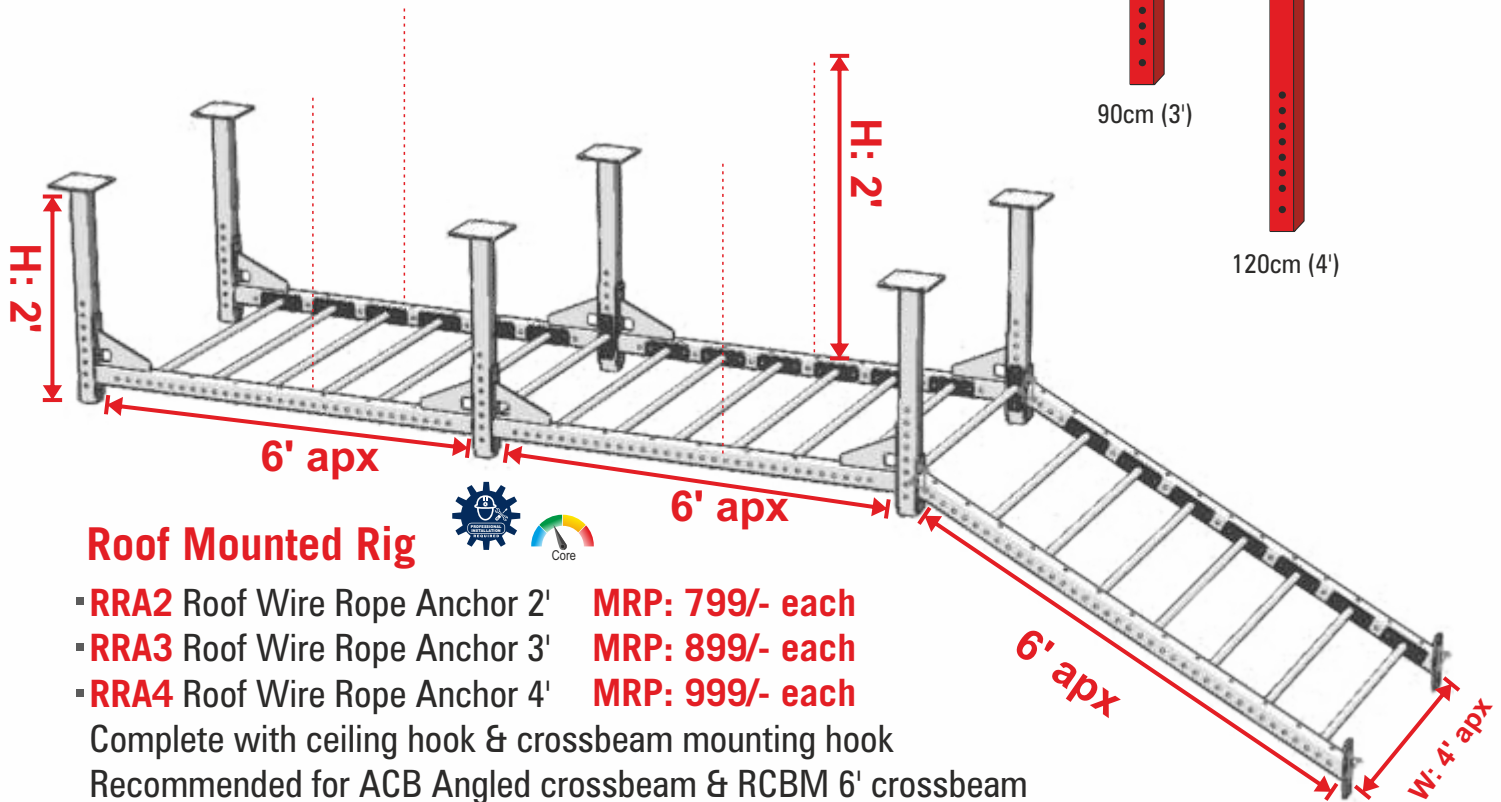
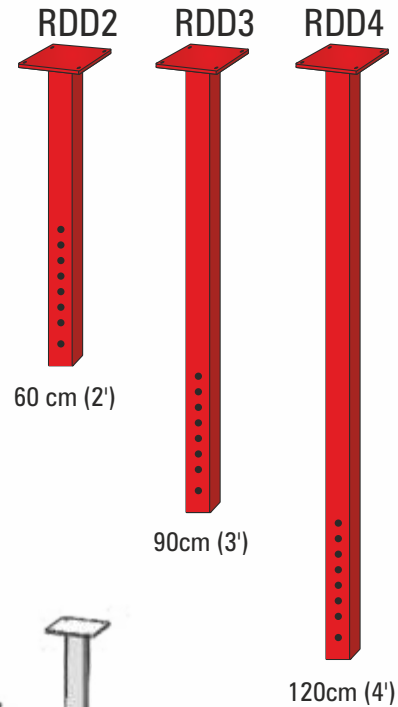

## Roof Mounted Rig

- **RRA2** Roof Wire Rope Anchor 2' **MRP: 799/- each**
- **RRA3** Roof Wire Rope Anchor 3' **MRP: 899/- each**
- **RRA4** Roof Wire Rope Anchor 4' **MRP: 999/- each**

Complete with ceiling hook & crossbeam mounting hook  
Recommended for ACB Angled crossbeam & RCBM 6' crossbeam

RDD2 Roof Drop Down	6	3699	22,194
RRA2 Roof Wire Rope	4	799	3,196
ACB6 Angled Crossbeam	2	6899	13,798
RCBM Crossbeam (B) 6'	4	6899	27,596
RMBS Monkey Bar (S) 4'	21	1699	35,679
6+6+7 + (2 on drop bars)			
SNB Spare Nuts & Bolts	21	799	16,779
<b>TOTAL</b>			<b>1,19,242</b>

### CUSTOMIZATION COLOR OPTIONS (FOR UPRIGHT BARS)

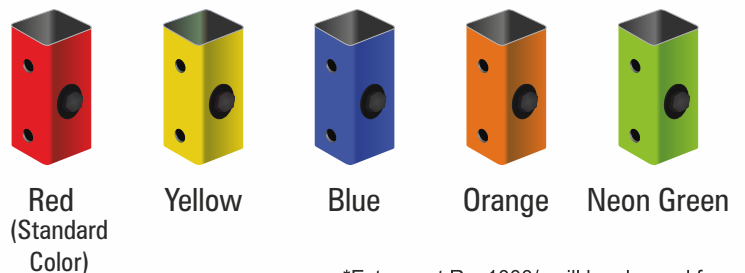

\*Extra cost Rs. 1000/- will be charged for colors other than Standard Color

# HEXA RIG

## THE EXPANDABLE TRAINING RIGS



### CUSTOMISE YOUR RIG.

USI Universal's hexa rigs are infinitely expandable to create a perfect workout station which suits your regular needs. The limit is only your available space.



**HXRG1**

**BASIC STRUCTURE COST**

Item Name	Qty	Rate	Amount
RMBS MONKEY BAR SMALL	6	1699	10,194
SNB SPARE NUT AND BOLTS	6	799	4,794
HCBS4 HEX ANG/CROSSBEAM	4	6099	24,396
RCBS CROSSBEAM SMALL	2	4799	9,598
RUR9 UPRIGHT 2.75m	6	13799	82,794
<b>TOTAL</b>			<b>1,31,776</b>



**HXRG2**

**BASIC STRUCTURE COST**

Item Name	Qty	Rate	Amount
RMBS MONKEY BAR SMALL	11	1699	18,689
SNB SPARE NUT AND BOLTS	11	799	8,789
HCBS4 HEX ANG/CROSSBEAM	8	6099	48,792
RCBS CROSSBEAM SMALL	3	4799	14,397
RUR9 UPRIGHT 2.75m	10	13799	1,37,990
<b>TOTAL</b>			<b>2,28,657</b>



**HXRG3**

**BASIC STRUCTURE COST**

Item Name	Qty	Rate	Amount
RMBS MONKEY BAR SMALL	16	1699	27,184
SNB SPARE NUT AND BOLTS	16	799	12,784
HCBS4 HEX ANG/CROSSBEAM	10	6099	60,990
RCBS CROSSBEAM SMALL	6	4799	28,794
RUR9 UPRIGHT 2.75m	14	13799	1,93,186
<b>TOTAL</b>			<b>3,22,938</b>

**HXRG1**

**BASIC STRUCTURE COST WITH ACCESSORY**

Item Name	Qty	Rate	Amount
JCP J CUPS	1	2199	2,199
RSA SAFETY SPOTTER ARMS	1	9499	9,499
RDH DIPPING HORNS	1	6899	6,899
RWT WALL BALL TARGET	1	3799	3,799
RMBS MONKEY BAR SMALL	6	1699	10,194
SNB SPARE NUT AND BOLTS	6	799	4,794
HCBS4 HEX ANG/CROSSBEAM	4	6099	24,396
RCBS CROSSBEAM SMALL	2	4799	9,598
RUR9 UPRIGHT 2.75m	6	13799	82,794
RFP FLYING PULLUP	1	13199	13,199
RBP BUMPER PLATE PIN	2	2299	4,598
RPBX RIG PLYOBOX	1	7599	7,599
<b>TOTAL</b>			<b>1,79,568</b>

\*Bumper plates not included, it will cost extra

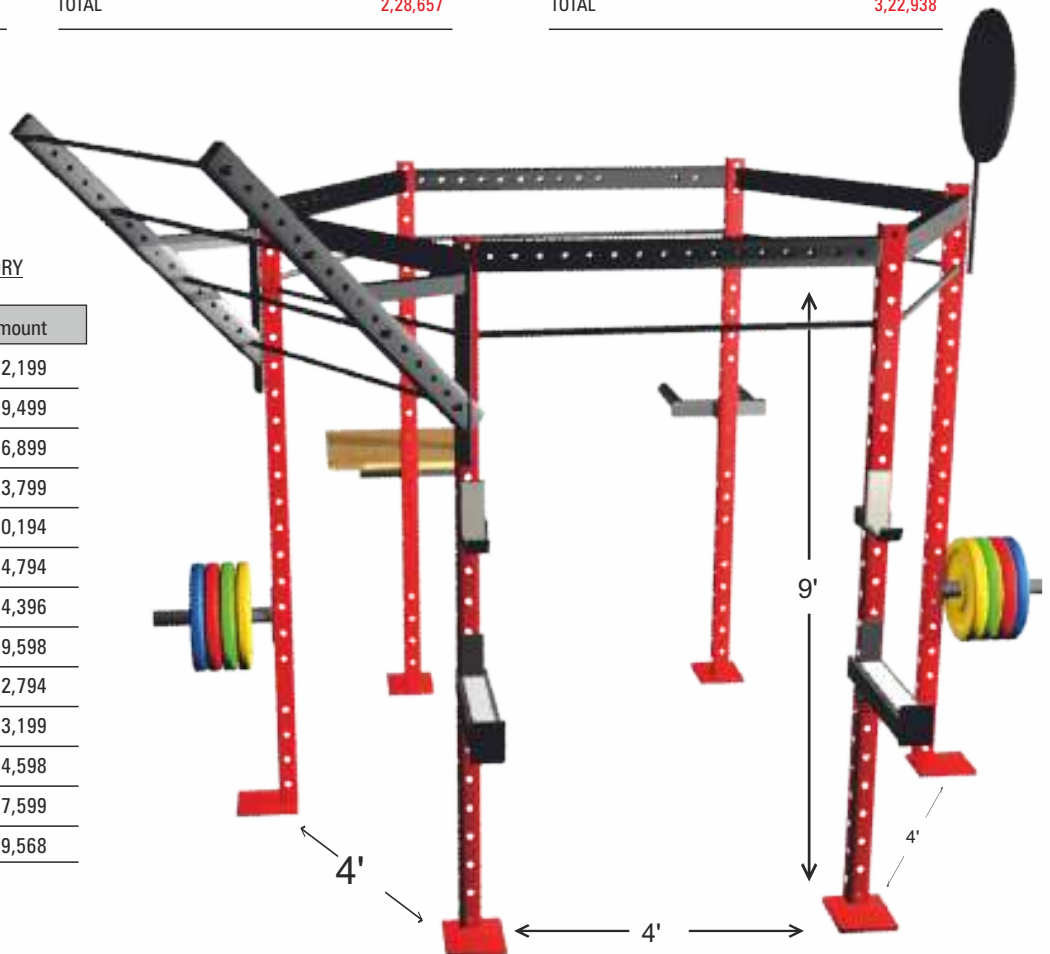

# WALL MOUNTED GYMNASTIC RIG

USI Universal offers a space efficient solution for small boxes & garage gyms. You will have the functionality of a rig without any footprint. Ideal for pull ups, muscle ups, kipping etc.

### CUSTOMISE YOUR RIG.

USI Universal's gymnastic rigs are infinitely expandable to create a perfect workout station which suits your regular needs. The limit is only your available space.

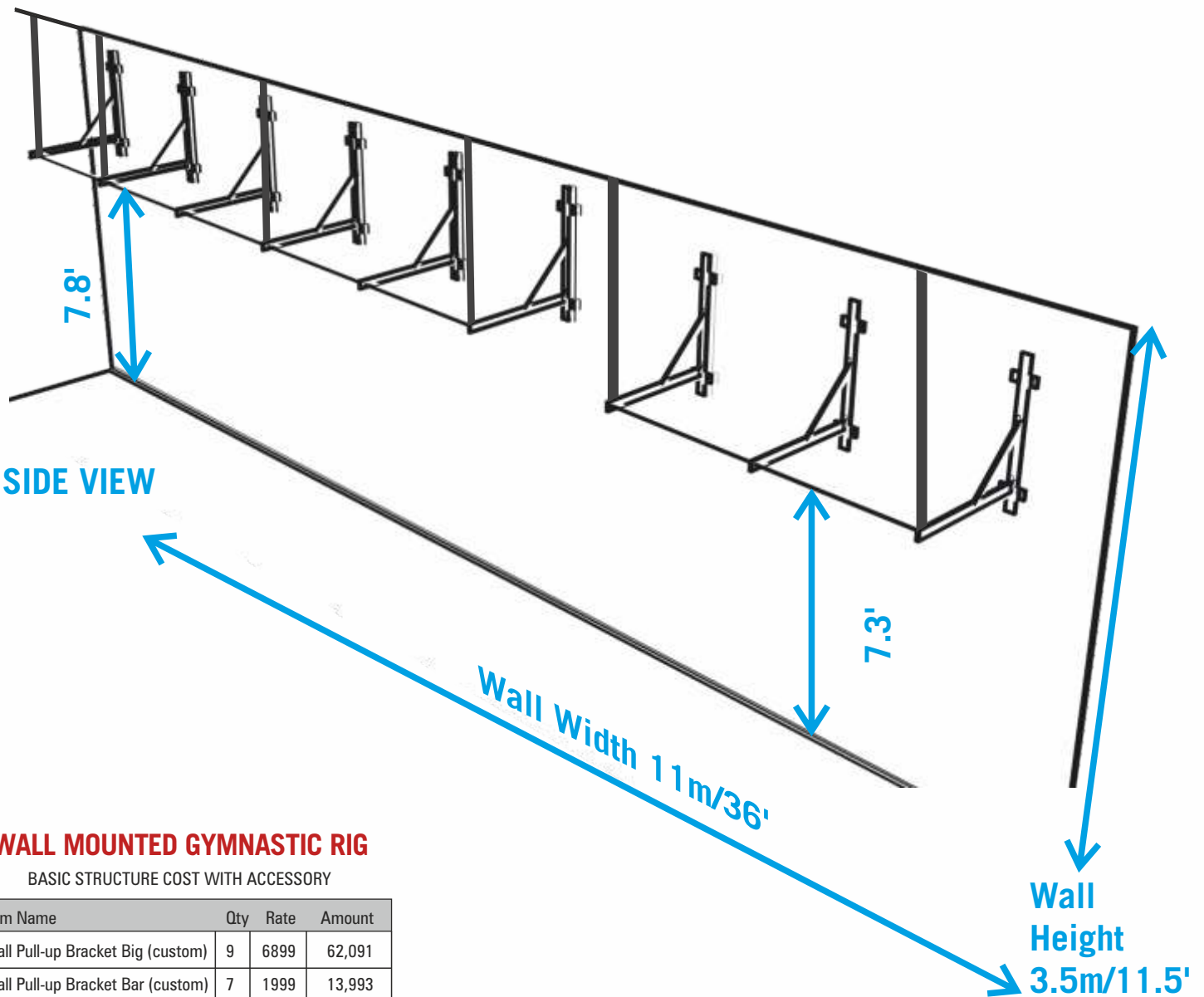

### WALL MOUNTED GYMNASTIC RIG

BASIC STRUCTURE COST WITH ACCESSORY

Item Name	Qty	Rate	Amount
Wall Pull-up Bracket Big (custom)	9	6899	62,091
Wall Pull-up Bracket Bar (custom)	7	1999	13,993
Ceiling Drop Support (big)	6	3100	18,600
Anchor Bolt M12 With Washer	80	70	5,600
Spare Nuts/bolts/washers	8	799	6,392
Total Rs.			1,06,676

# RIG ACCESSORIES

USI Universal's rig accessories are compatible with our rigs, power racks & squat stands. Our accessories will be mostly compatible with structures made of 72 x 72 mm pillars, drilled with 18mm holes at a centre distance of 150mm.



### JCP JCUPS

TECH-SPEC.



- Heavy gauge metal construction
- Precision bent
- Nylon plastic liner to protect bar knurling
- 16 mm bull nose pin
- Anti rust powder coated
- Weight capacity: 450 Kg/1000Lbs

Code	Dimensions	MRP.
JCP	10 x 7.5 x 15cm 4" x 3" x 6"	2199/-

\* per pair



### RBP BUMPER PLATE PIN

TECH-SPEC.



- Heavy gauge metal construction
- Length 43 cm (17") apx.
- 2 Sets 14mm precision nuts, bolts & washers
- Can hold upto 100 Kg/220 Lbs of bumper plates
- Anti rust powder coated

Code	Size apx	MRP.
RBP	43cm (17")	2299/-

\* per pc



### RBPG BAND PEGS

TECH-SPEC.

- Heavy metal construction
- Ideal to develop maximal tension through out the full range of motion
- Can be used as storage pin to hand bands, ropes, chains & other accessories
- Chrome plated

Code	Length	Thickness	MRP.
RBPG	25cm/10"	16mm	2399/-

\* set of 4



### REA EXTENSION ARM FOR PUNCHBAG

TECH-SPEC.



- Heavy gauge metal construction
- Helps to increase the functionality of a rig without increasing the foot print
- 112cm (44") long apx.
- 2 Sets 14mm precision
- Nuts, bolts & washers
- Can be used for gymnastic rings, punch bags, etc.
- Anti rust powder coated
- Weight capacity: 150kg/330Lbs
- \*Rig must be bolted to the floor

Code	Size apx	MRP.
REA	90cm (3')	5749/-

\* per pc



### PBC RIG SHACKLE

TECH-SPEC.



- Heavy gauge metal construction
- 1 set 14mm precision nut, bolt & washers
- Ideal for punch bags, rings, climbing ropes, grip tools, etc.
- Anti rust powder coated
- Weight capacity: 150kg/330Lbs

Code	MRP.
PBC	799/-

\* per pc



### RNG NEUTRAL GRIPS

TECH-SPEC.



- Heavy gauge metal construction
- Drop fit system on crossmember
- Length: 18 cm (7") apx.
- Diameter: 3.4 cm (1.25") apx.
- Anti rust powder coated
- Weight capacity: 110kg/240Lbs per pair

Code	Dia apx.	MRP.
RNG	3.4 cm (1.25")	1699/-

\* per pair

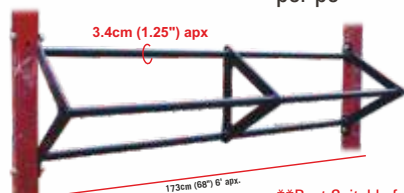

### RT TRIBAR

TECH-SPEC.



- Heavy gauge metal construction
- Replacement for big crossmember/crossbeam
- Length: 173 cm (68") apx.
- Diameter: 3.4 cm (1.25") apx.
- 4 pcs. 14mm precision nuts, bolts & washers
- Ideal for customers with different heights
- Anti rust powder coated
- Weight capacity: 180kg/400Lbs
- \*Rig must be bolted to the floor

Code	Length apx	MRP.
RT	173cm (68"/ 6')	11,999/-

\* per set

### RFP FLYING PULLUP

TECH-SPEC.



- 3mm (11 gauge) construction
- Replacement for small crossmember/crossbeam
- 4 even spaced rungs
- Acts as a pull up ladder
- Length: apx. 116 cm (46") apx.
- Rung diameter: apx. 2.8 cm apx.
- Extension from rig: apx. 86cm (34") 45° angle
- 6 sets 14mm precision nuts, bolts & washers
- Anti rust powder coated
- Weight capacity: 180kg/400Lbs
- \*Rig must be bolted to the floor

Code	Length apx	MRP.
RFP	116cm (46")	13,199/-

\* per set





# RIG ACCESSORIES



### RSA SAFETY SPOTTER ARMS

TECH-SPEC. Performance RUST

- 3mm (11 gauge) construction
- 7.2x7.2cm ( 3"x3" apx)
- J fit with pin insert
- Nylon lined for protecting barbell knurling
- Ideal to protect the lifter & the barbell
- Anti rust powder coated
- Weight capacity: 350kg/770Lbs

Code	Size	MRP.
RSA	50cm (20") long	9499/-

\* per pair

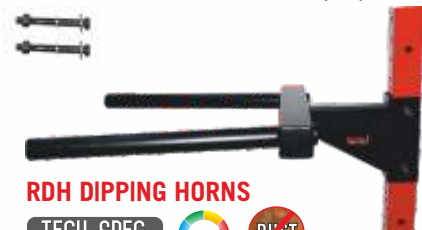

### RDH DIPPING HORNS

TECH-SPEC. Performance RUST

- 3mm (11 gauge) construction
- 7.2cm x 7.2cm ( 3"x3" ) apx.
- 2 sets 14mm precision nuts, bolts & washers
- Handles distance 42cm (16.5") 60 cm (23.5")
- Many grip width options
- Product Weight: 12.25 Kg apx.
- Anti rust powder coated
- Handle thickness 4cm (1.5") apx.
- Weight capacity: 180 Kg/400 lbs

Code	MRP.
RDH	6899/-

\* per set



### RWT WALL BALL TARGET

TECH-SPEC. Performance RUST

- Heavy gauge metal construction
- Thickness: 5 mm (6 gauge)
- 2 sets 14mm precision nuts, bolts & washers
- Anti rust powder coated

Code	Dia apx.	MRP.
RWT	40 cm (16")	3799/-

\* per set

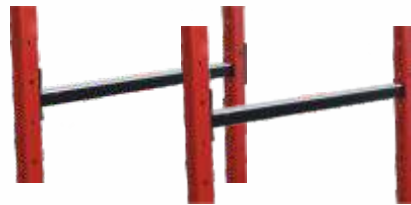

### RSP SAFETY SPOTTER PIN

TECH-SPEC. Performance RUST

- J fit with pin insert.
- Nylon lined for protecting barbell knurling.
- Ideal for pillars with gap of 120cm (4') apx.
- Protects the lifter & the barbell.
- Anti rust powder coated
- Weight capacity: 450kg/990Lbs

Code	MRP.
RSP	8999/-

\* per pair



### RPBX RIG PLYOBOX

TECH-SPEC. Performance RUST

- Heavy gauge metal construction
- Rubber wood top with laser logo
- Quick height adjustment possible
- Anti rust powder coated
- Weight capacity: 130 Kg/240 lbs

Code	Dimensions	MRP.
RPBX	48cm X 48cm 19" X 19"	7599/-

\* per set



### RRP RIG ROPE PULLEY

TECH-SPEC. Performance RUST

- Heavy gauge metal construction
- Can be mounted at different heights
- 2 sets 14mm precision nuts, bolts & washers
- Ideal for use with Jute, PP rope
- Anti rust powder coated

Code	Dimensions apx	MRP.
RRP	Dia: 30cm/12" Gap: 32cm/12.6"	8399/-

\* per set



### RSL RIG SAFETY SLING

TECH-SPEC. Performance RUST

- Reinforced black nylon straps
- J fit with pin insert
- Ideal for pillars with gap of 120cm(4') apx
- Ends can be mounted at different heights
- Prevents barbell to roll away
- Ideal for safety of lifter & barbell
- Width apx. 75mm (3")
- Anti rust powder coated
- Weight capacity: 400kg/880Lbs

Code	MRP.
RSL	8599/-

\* per pair



### BRM BARBELL T-BAR MOUNT

TECH-SPEC. Core RUST

- Heavy gauge metal construction
- Ideal for olympic barbells
- Anti rust powder coated

Code	MRP.
BRM	1949/-

\* per pc



### RBA RIG BATTLE ROPE ANCHOR

TECH-SPEC. Core RUST

- Heavy gauge metal construction
- 2 sets 14mm precision nuts, bolts & washers
- Anti rust powder coated

Code	MRP.
RBA	1399/-

\* per pc

## RIG ACCESSORIES

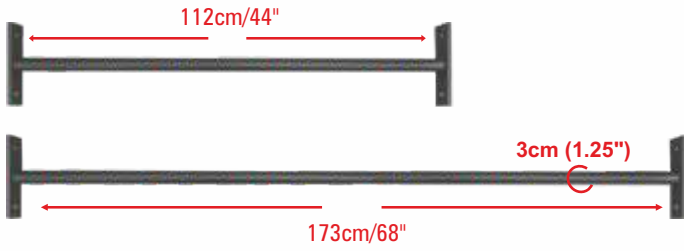

### RMB MONKEY BARS



- 3mm (11 gauge) round pipe construction
- 3cm diameter (1.25") apx.
- Anti rust powder coated

Code	Size	MRP.
RMBS	112cm/44"	1699/-
RMBB	173cm/68"	2499/-

\* per pc

### SNB SPARE NUTS/BOLTS/WASHERS



- Usually needed in case of monkey bars

Code	Set	MRP.
SNB	4 pcs set	799/-

\* per set

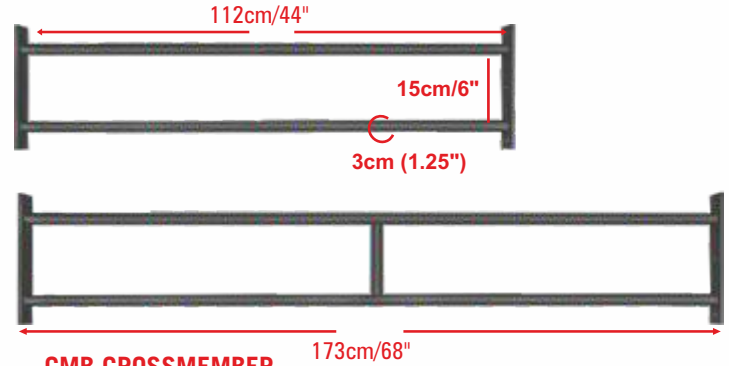

### CMB CROSSMEMBER



- 3mm (11 gauge) round pipe construction
- 3cm diameter (1.25") apx.
- Anti rust powder coated

Code	Size	MRP.
CMBS	112cm/44"	5199/-
CMBB	173cm/68"	7499/-

\* per pc



### RCB CROSSBEAM



- 3mm (11 gauge) construction
- Mild steel construction (7.2 x 7.2cm/2.8")
- Gap between holes 5 cm (2") apx.
- Anti rust powder coated

Code	Size apx.	MRP.
RCBJ	295cm /116"	15,999/-
RCBM	173cm /68"	6899/-
RCBS	112cm /44"	4799/-

\* per pc



### ANGLED CROSSBEAM



- 3mm (11 gauge) construction 7.2cm x7.2cm (3"x3") apx
- Angular edge cutting for inclines to 3.65m (12') upright
- Gap between holes 5cm (2") apx.
- Anti rust powder coated

Code	Size	MRP.
ACBS6	7.5' to 9'	6899/-
HCBS4	...	6099/-
ACB6	9' to 12'	6899/-

\* per pc

### RCMN CROSS BEAM MINI



- 3mm (11 gauge) construction
- Mild steel construction
- Gap between holes 5cm (2") apx.
- Ideal for use in half racks

Code	Size apx	MRP.
RCMN	66cm (26")	2299/-

\* per pc



### CMB STALLBAR



- 3mm (11 gauge) construction
- Mild steel construction
- Anti rust powder coated
- 4 sets 14mm precision nuts, bolts & washers

Code	Size	MRP.
CMBST	112cm/44"	4599/-
CMBBT	173cm/68"	6899/-

\* per pc



# RIG ACCESSORIES

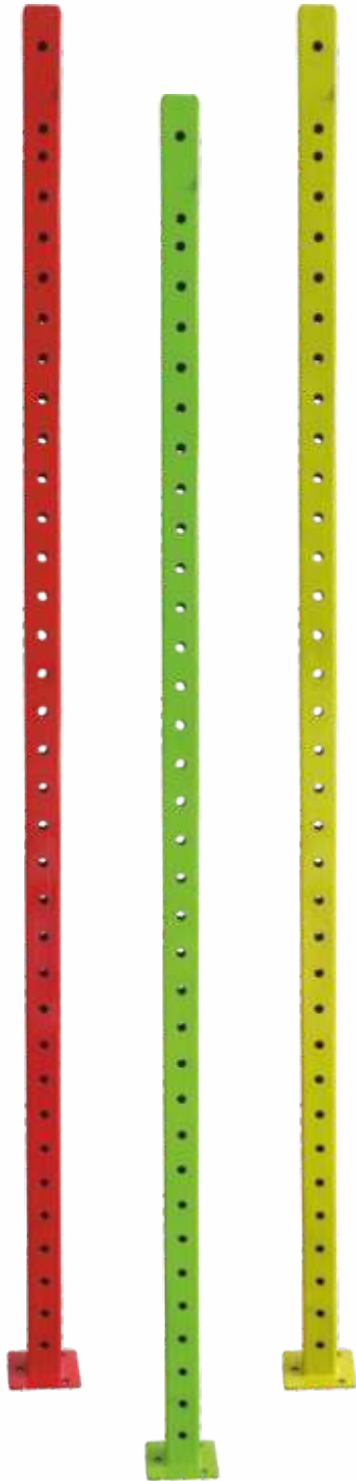

### EUR UPRIGHT EXTENSION 90 (3')



- 3mm (11 gauge) square pipe construction (72x72mm)
- Precision holes on all sides for modular fitting.
- Add on to RUR9 to make it 3.65m (12 ft) apx long
- 4 Sets 14mm precision nuts, bolts & washers
- Anti rust powder coated

Code	Size apx	MRP.
EUR	90cm/3'	5099/-
EUR1.5	45cm/1.5'	3830/-

\*per pc

\*\*Best Suitable for 9' to 12' incline/decline Rigs

### CUSTOMIZATION COLOR OPTIONS (FOR UPRIGHT BARS)

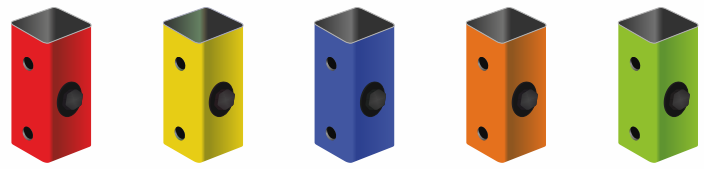

- Red (Standard Color)
- Yellow
- Blue
- Orange
- Neon Green

\*Extra cost will be charged for colors other than standard color (Red)  
 RUR: Rs. 1000/- per bar  
 EUR: Rs. 500/- per bar

### RUR UPRIGHT BAR



- 3mm (11 gauge) construction 7.2 cm x7.2cm (3"x3" Apx)
- Precision holes on all sides for modular fitting.
- Base plate with hole for bolting to floor (Bolts not included)
- Anti rust powder coated
- 4 Sets 14mm precision nuts, bolts & washers included with every bar

Code	Size apx	MRP.
RUR7.5	2.28m (7.5' )	11499/-
RUR9	2.75m (9')	13799/-

\* per bar

### AB12 ANCHOR BOLT M12



- Metal construction zinc plated.
- Ideal for use in concrete.

Code	Size apx	MRP.
AB12	12mm	70/-

\* per pc



# MODULER STORAGE

In this age of expensive real estate & high rentals, it is very important to keep all our gym accessories organized. USI Universal provides a space efficient solution for mass storage. Different types of crossmembers, trays & shelves have been developed for storage of different fitness accessories. Seamless design allows you to customize as per your space. You can also add storage in phases as you restructure your gym, box or home studio.

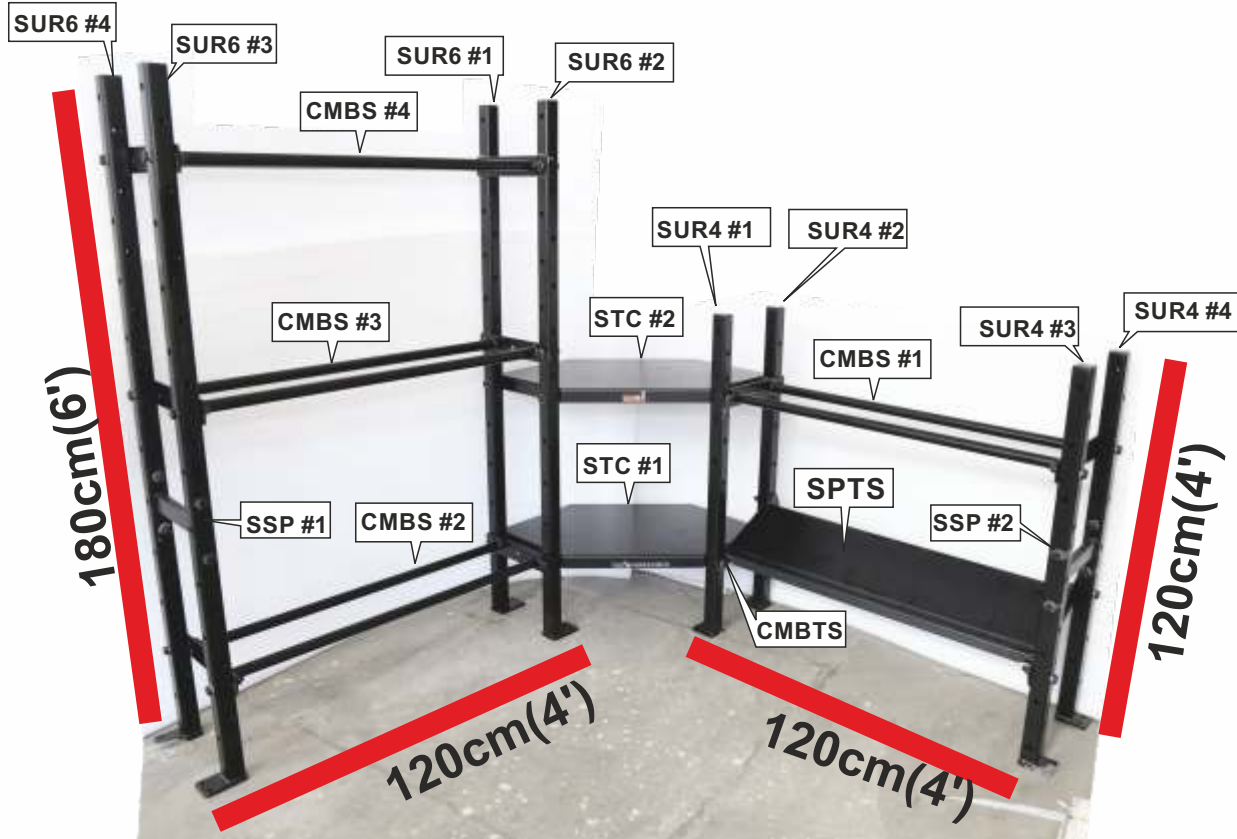

TECH-SPEC.

Code	Product Name	Qty	Rate	Amount
SUR6	STORAGE UPRIGHT 1.8m	4	5499	21996
SUR4	STORAGE UPRIGHT 1.2m	4	3999	15996
STC	CORNER STORAGE TRAY	2	7499	14998
SSP	STORAGE UPRIGHT SPACER	1	1549	1549
SPTS	STORAGE PLATE TAPERED	1	3999	3999
CMBTS	TAPERED CROSSMEMBER - S	1	5199	5199
CMBS	CROSS MEMBER (S)	4	5199	20796
<b>TOTAL</b>				<b>84533</b>

\* Additional STS-Storage Tray For Kettlebells 1.2m@3799 available  
 \* Kettlebells/Balls/plates etc are not included



## DSK DISPLAY STAND FOR KETTLEBELL

TECH-SPEC.

- Solid metal construction
- Anti rust powder coated
- Collapsible construction for easy transport
- Can hold upto 15-20 kettlebells depending on size and weight
- Product weight: 20.8 Kg apx.  
Weight Capacity: 350 Kg/770Lbs apx.

Code	Dimensions apx.	MRP
DSK	(L)125 x (B)48 x (H)109 49"x19"x40"	10,999/-

\* Kettlebells not included \* per set



## BARBELL GUN RACK

### GRK BARBELL GUN RACK



- Mild steel & plastic construction
- Mig welded
- Anti rust powder coated
- Seamless design enables linear installation of more than one rack
- Complete with nuts & bolts for installation

Code	Color	MRP.
GRK	Chrome	3599/-

\*per pair



## BARS HOLDER

### DSB 9 BAR HOLDER FOR OLYMPICS BARS



- 6MM (4 Gauge) metal construction
- CNC precision cut holes
- Smooth tubes to protect barbell
- Anti rust powder coated
- Ideal for storage of upto 9 olympic barbells (50mm/2" sleeve)

Code	Dimensions	Weight	MRP.
DSB	46x46x22 cm (18"x18"x8.5")	34.5Kg	11499/-

\* per pc



### DSB5 5 BAR HOLDER FOR OLYMPIC BARS



Code	MRP
DSB5	7999/-

\* per pc



### HBH 3 BAR VERTICAL HANGER



Code	MRP
HBH	3499/-

# DISPLAY STANDS

## DSD DISPLAY STAND DOUBLE SIDE



- Solid metal construction
- Anti rust powder coated
- Collapsible construction for easy transport
- Ideal for medicine balls, strength bags & banana bags
- Product weight: 12 Kg
- Weight capacity: 150 Kg/330 lbs

Code	Dimensions apx	MRP
DSD	(L)52 X (B) 50 X (H) 173 cm 20.5" x 19.5" x 68"	6399/-

\* balls not included \* per set



## DSSU DISPLAY STAND SINGLE SIDE 'U' TYPE



- Solid metal construction
- Anti rust powder coated
- Collapsible construction for easy transport
- Ideal for medicine balls, strength bags & banana bags
- Product weight: 10.25 Kg
- Weight capacity: 60 Kg/130 Lbs

Code	Dimensions apx	MRP
DSSU	(L)59 X (B) 39.5 X (H) 164 cm 23" x 15.5" x 64.5"	5299/-

\* balls not included \* per set



## DSSS DISPLAY STAND SINGLE SIDE



- Solid metal construction
- Anti rust powder coated
- Collapsible construction for easy transport
- \* For Strength/Banana Bags
- Product weight: 10.25 Kg
- Weight capacity: 100 Kg/220 Lbs

Code	Dimensions apx	MRP
DSSS	(L)52 X (B) 50 X (H) 173cm 20.5" x 19.5" x 68"	5499/-

\*Bags not included \* per set



## BUMPER PLATE STACKER

Vertical plate storage with a small foot print. Comes with lockable heavy duty wheels for easy movement.



### BPST BUMPER PLATE STACKER

TECH-SPEC.



- 11 gauge (3mm apx) metal construction
- Anti rust powder coated
- Lockable heavy duty wheels
- Comes flat packed
- Can fit 10-15 bumper plates (50mm/2" hole) of mix weights
- Foot print 60x60cm (24"x24"), Length : 60cm (24") apx.

Code	Color	MRP
BPST	Black	8499/-

\* plates not included

\* per set



### CPSR RACK FOR CARDIO PUMP / REP SET

TECH-SPEC.



- Metal construction
- Ideal for holding 10 sets
- Anti rust powder coated (DIY. Assembly Required)
- Comes flat packed
- Ideal for 31mm hole plates only

Code	Color	MRP
CPSR	Black	16499/-

\* plates not included

\* per set

## OLYMPIC WEIGHT PLATE TREE



### WPTR OLYMPIC WEIGHT PLATE TREE

TECH-SPEC.



- 11 gauge (3mm apx) metal construction
- Anti rust powder coated
- Lockable heavy duty wheels
- Comes flat packed
- Length : 66cm (26") apx.
- Width : 60cm (24") apx.
- Height : 127cm (50") apx.
- Post : 30cm (12") apx. Post spacing : 46.5cm (18.3") apx.
- Store upto : 24-30 plates mix of sizes
- Can accommodate 50mm/2" apx. hole plates

Code	Color	MRP
WPTR	Black	13999/-

\* plates not included

\* per set

# RACK/ HANGER

## MRR MESSAGE ROLLER RACK

As rollers become an integral part of training, they deserve to be stored properly. This dispenser style rack keeps them tucked in place. The width between the two rails should be kept depending on the width of the rollers you have. Rollers are loaded from the top & dispense conveniently as and when required.

**TECH-SPEC.**  

- Metal plate construction
- Precision bent
- Powder coated finish
- Needs wall mounting
- Fitting accessories included
- Fits upto 10 rollers with 10-12.5cm(4"-5")
- Diameter 10-12.7cm (4"-5" )

Code	Length	Color	MRP
MRR	133cm (52")	Black	8799/-

\* Massage Rollers not included \* per pc

WHILST STOCK LAST



## BRBH BELT ROPE BAND HANGER

A matter of convenience and for the sake of organizing your gym accessories. This product is a must have for any serious training facility. It can hold up to 60 jump ropes or 30-60 latex loops (depending on the width) or 30 fitness belts. Mix them all up and you would still have a proper storage on a rack.

**TECH-SPEC.**  

- 8mm (4 gauge) mild steel construction
- 15 CNC precision cut and bent slots
- 4 pcs 10 mm anchor bolts for mounting

Code	Dimensions apx	MRP
BRBH	60cm x 20 cm (23.5"x 8")	3999/-

\* Ropes/Belts not included \* per pc





# SWISS BRACKET FOR BALL STORAGE



## SBK SWISS BRACKET FOR BALL STORAGE

TECH-SPEC.

- Metal plate construction
- Powder coated finish
- Ideal for storage of medicine balls, slam balls & wall balls
- Can store upto 4 wall balls/4-6 medicine balls or slam balls
- Weight capacity: 50 Kg/110 Lbs



Code	MRP
SBK	5999/-

\* per set

## BTBR RACK FOR BODY TRAINING BAR

TECH-SPEC.

- Dimensions: 35.5x31x122cm(14"x12"x48") apx.
- Anti rust powder coated
- Ideal for storing 12-16 bars

Code	Weight apx	Color	MRP
BTBR	16 Kg	Black	11999/-

\* Training bars not included \* per set



## BSBRK BALANCE STEP BALL RACK ONLY

TECH-SPEC.

Code	Height	MRP
BSBRK	167cm/66"	20999/-

\* per set



## GBRKA GYM BALL RACK ATTACHMENT

TECH-SPEC.

Code	MRP
GBRKA	799/-

\* per set



## GBRK GYM BALL RACK

TECH-SPEC.

Code	MRP
GBRK	13999/-

\* per set

# CHALK STAND



## CST CHALK STAND

TECH-SPEC.  Base

- 3mm (11 gauge) metal construction
- Moveable with lockable wheels
- 4 prongs for hanging fitness accessories
- Comes flat packed
- Powder coated & chrome plated

Code	Dimensions	Color	MRP
CST	L:63.5 x B:63.5 x H:96.50cm 25" x 25" x 38"	Chrome/ Black	11899/-

\* per pc

## 733GC GYM CHALK

USI Universal's gym chalk is made of a superior magnesium carbonate formula which promotes a firm & reliable grip. It will keep your hands dry without caking on contact.

TECH-SPEC.  Advance

- High performance magnesium carbonate formula.
- For extreme gripping & hold
- Keeps hands sweat free
- Contains 8 pcs (2 oz. each) per pack

Code	Pcs	MRP
733GC	8 pcs	1449/-

\* per pack



# GRAVITY TRAINER



## 800GT GRAVITY TRAINER

**TECH-SPEC.** 

- Webbing, foam & metal construction
- Comes with door attachment
- Ideal for complete body workout, leveraging your own body weight
- Enhances strength, flexibility & brings core stability
- Complete with carry case
- Easy cam buckle length adjustment
- Solid snap hook for loop formation
- User body weight capacity upto 115 Kg/250 Lbs

Code	Size	MRP
800GT	OSFA	6800/-

\* per set



## FGT FRAME FOR GRAVITY TRAINING

USI Universal's frame is great for group classes & personal use. 4-5 customers can do gravity training at once, the horizontal frame can be used for hanging a punch bag (x2). The anchor points on pillars can be used for battle ropes, loops, bands, bar resistance trainers.

**TECH-SPEC.**   

- 3mm (11 gauge) construction
- 7.2 cm x7.2cm (3"x3" apx.)
- Length: 3.05m/10' apx.



Code	MRP
FGT	74999/-

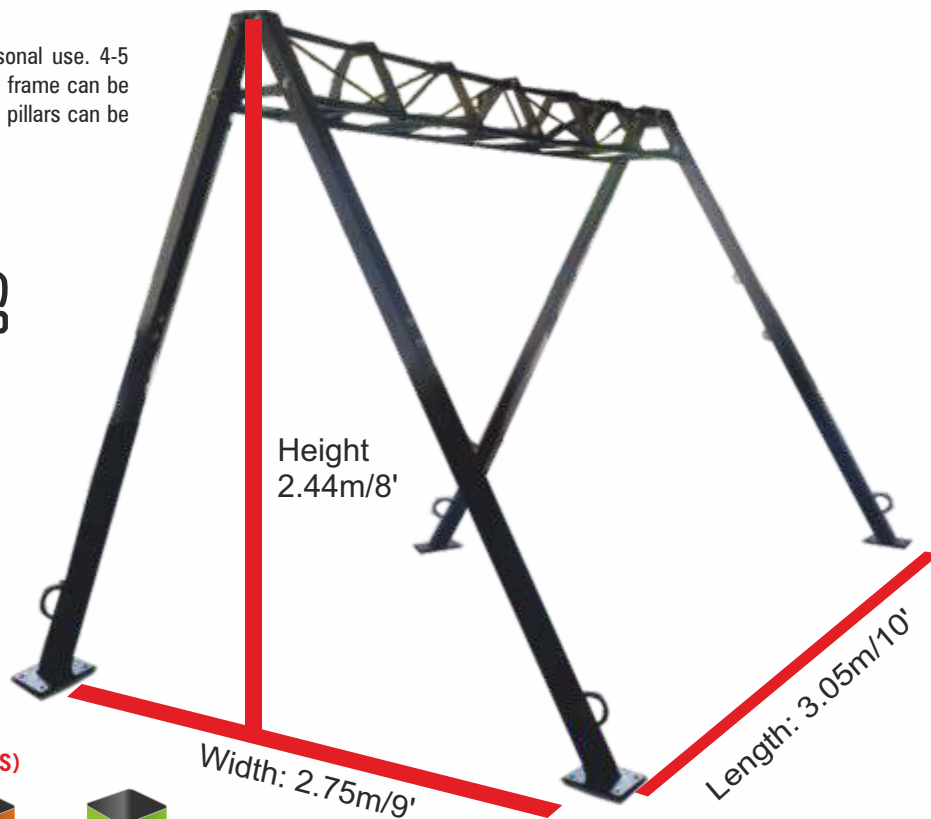

## CUSTOMIZATION COLOR OPTIONS (FOR UPRIGHT BARS)

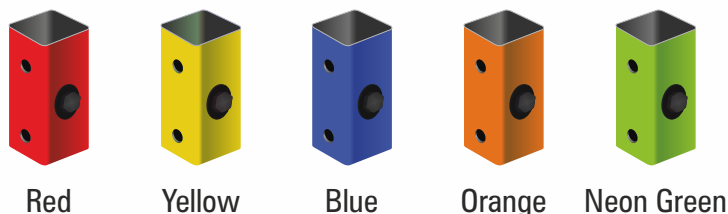

Red      Yellow      Blue      Orange      Neon Green

\*Extra cost Rs. 5000/- will be charged for colors other than standard color

## GYMNASTIC RINGS

USI Universal's gymnastic rings help you with body weight training. Ideal for building upper body strength & core. It will help you improve stability & mobility. Choose between wood & plastic. Straps can be adjusted as per ceiling/height. Cam buckles secure the length of the straps.



### WAR WOODEN GYM RING (PREMIUM QUALITY)

**TECH-SPEC.** 

- Birch wood construction
- 4.57m/15' adjustable strap
- Jacquard strap with length indication at a gap of 30cm/1" apx.
- Solid cam buckle adjustment to secure the required length
- Strap width: 3.2cm/1.5"
- Ring outer diameter: 23.5cm/9.5"
- Ring inside diameter: 17cm/6.7"
- Ring Thickness: 3.5cm/1.38"
- User body weight upto 110Kg/240 Lbs

Code	MRP
WAR	4499/-

\* per pair

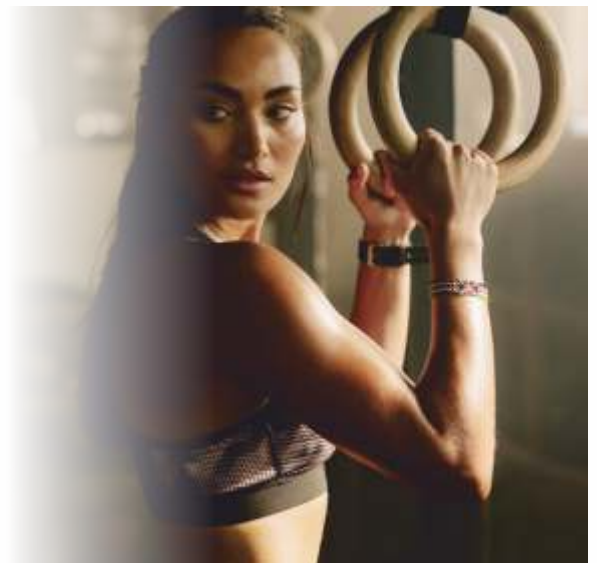

### AR ROMAN RINGS 28mm

**TECH-SPEC.** 

- ABS & Nylon construction
- 4.5m/14.75 Nylon web strap with cam buckle adjustment
- Strap width: 2.5cm/1"
- Ring outer diameter: 23.5cm/9.5" apx.
- Ring inside diameter: 18cm/7"
- Ring diameter: 3cm/1.2"
- Textured ring surface for grip
- User body weight capacity upto 100 Kg/220 Lbs

Code	MRP
AR	2599/-

\* per pair



## BAR RESISTANCE TRAINER



### 800EB BAR RESISTANCE TRAINER

USI Universal's bar resistance trainer helps you train rotational movements. The variable movements & resistance help you reduce the risk of injury while doing every day tasks. The bar resistance training helps build explosive power, improves cardio, mobility & balance.



- Metal, foam & elastic construction
- Bungee elastic covered with protective sleeve
- Door attachment included
- Can loop around any metal pole/post
- Weighted bar anti rust powder coated
- Foam grip for firm holding
- Complete with carry case

Code	MRP
800EB	6399/-

\* per set



### PB PEG BOARD & REPLACEMENT DOWELS

Best upper body training and conditioning tool. It can be hung vertically, one on the other in case your gym has a high roof. You can also mount them horizontally to make a climbing course. Can be mounted on rigs with customized hardware.



- 35-40mm canadian wood plank
- 23 CNC cut climbing holes
- Matt finish smooth polish
- Supplied with climbing dowels and mounting hardware
- Rounded edges for safety

Code		Dimensions apx	MRP
PB	Peg Board	28cm x 120cm (11" x 48")	9399/- per pc
PBS	Peg Board Small	28cm x 60cm (11" x 24")	4699/- per pc
PBD	Replacement Dowels		549/- per pair



# RUBBER MEDICINE BALLS

Made of excellent quality textured rubber, USI Universal's rubber medicine ball allows you to get a solid grip on the ball while throwing and catching. In addition to get a good grip, the balls also provide high bounce. Exercising with the medicine ball can overall improve your strength. You can do lunges, squats, slams, single-leg V-ups, kneel to push-ups and other strength training with this ball. Improve your balance by using USI Universal's medicine ball while doing burpees. Doing cardio with a medicine ball can accelerate the blood circulation.



## 787PVH RUBBER MEDICINE BALL HIGH BOUNCE



- Textured finish
- Strong core
- Better balance
- Blood circulation
- Made rubber with textured surface
- High bounce
- Weighted with rubber & air

Code	Weight		Color	MRP
787PVH1	1 Kg	19.5cm/7.7"	Black/Purple	999/-
787PVH2	2 Kg	19.5cm/7.7"	Black/Green	1199/-
787PVH3	3 Kg	23cm/9"	Black/Red	1499/-
787PVH4	4 Kg	23cm/9"	Black/Orange	1799/-
787PVH5	5 Kg	23cm/9"	Black/Light Blue	2099/-
787PVH6	6 Kg	27.5cm/10.8"	Black/Dark Green	2299/-
787PVH7	7 Kg	27.5cm/10.8"	Black/Pnk	2599/-
787PVH8	8 Kg	27.5cm/10.8"	Black/Blue	2899/-
787PVH9	9 Kg	27.5cm/10.8"	Black/Brown	3199/-
787PVH10	10 Kg	27.5cm/10.8"	Black/Yellow	3299/-

\* per pc

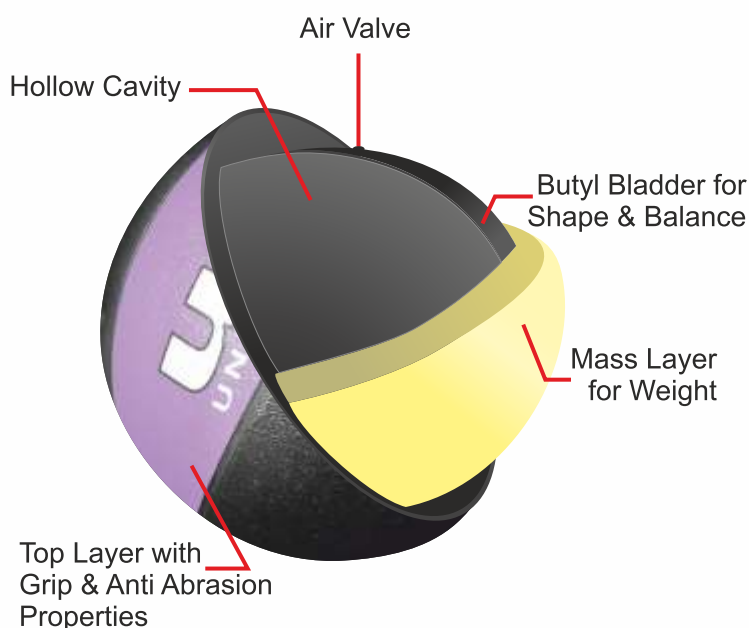

## DSD DISPLAY STAND DOUBLE SIDE



- Solid metal construction
- Powder coated
- Collapsible construction for easy transport
- Ideal for medicine balls, strength bags & banana bags
- Product weight: 12 Kg
- Weight capacity: 150 Kg/330 Lbs

Code	Dimensions apx	MRP
DSD	(L)52 X (B) 50 X (H) 173 cm 20.5" x 19.5" x 68"	6399/-

\* balls not included

\* per set

Assembly Manual:  
Included in the box

Assembly Video



## REB MEDICINE BALL REBOUNDER

TECH-SPEC.

Code	MRP
REB	26499/-

\* per pc

# LEATHER MEDICINE BALLS

USI Universal's leather medicine balls are a classic product. Most economical in our range . Ideal for passing exercises & hold workouts. Have low bounce. The leather surface gives sufficient grip.

## 736SL8 LEATHER MEDICINE BALL

### TECH-SPEC.



- Leather laminated
- Flock filled (fibre made from fabric cutting)
- Oval shaped



Code	Color	Weight	Diameter	MRP
736SL81	Black/Red	1 Kg	18cm/7"	549/-
736SL82		2 Kg	19cm/7.5"	649/-
736SL83		3 Kg	23cm/9"	899/-
736SL84		4 Kg	26.5cm/10.5"	999/-
736SL85		5 Kg	26.5cm/10.5"	1199/-
736SL86		6 Kg	28cm/11"	1399/-
736SL87		7 Kg	30cm/12"	1799/-
736SL88		8 Kg	32cm/12.5"	1999/-
736SL89		9 Kg	32.5cm/12.75"	2049/-
736SL810		10 Kg	33cm/13"	2199/-

\* per pc



# SLAM BALL



## SB SLAM BALL

As the name suggests, these are made for slamming on the floor/ground. Ideal for ballistic workout. Made of tough moulded vinyl with easy to grip textured surface. Unstable filling makes the workout more challenging. Washable product with dead bounce.

### TECH-SPEC.



- Moulded vinyl construction.
- Ideal for slamming exercises (dead bounce)
- Fitted with air valve & micro granule filling



Code	Color	Weight	Dimensions	MRP
SB6	Black/Red/Blue * Colors may vary	6 Kg	22cm/8.65"	1299/-
SB8		8 Kg	22.35cm/8.80"	1599/-
SB10		10 Kg	22.5cm/9"	1949/-
SB12		12 Kg	26.5cm/10.5"	2299/-
SB15		15 Kg	27cm/10.65"	3099/-
SB20		20 Kg	28cm/11"	4300/-

\* per pc

# MEDICINE BALLS

The built in handles enable the user to add more variety to workout. They provide stability, help to develop core & endurance. Can be used as a kettlebell.

## 787DH DOUBLE GRIP MEDICINE BALL



- Heavy duty rubber shell construction
- Solid weighted core
- Balance on it, lift it, shake it side-to-side
- Built-in anti skid handles at the 3 & 9 o'clock positions
- Firm, easy and comfortable grip during intensive training
- Ideal for use at the gym, yoga, martial arts
- Can be used as a kettlebell
- Each medicine ball is color coded with weight

Code	Weight	Diameter	MRP
787DH6	6 Kg	29.25cm/10.7"	5349/-
787DH7	7 Kg	27.40cm/10.8"	5999/-
787DH8	8 Kg	27.55cm/10.85"	6499/-
787DH9	9 Kg	27.7cm/10.90"	6999/-
787DH10	10 Kg	27.95cm/11"	7499/-

\* per pc



# WALL BALLS

USI Universal's wall balls are a perfect crosstraining tool. Ideal for a full body workout. Oversized to maintain the correct posture. Made of strong vinyl material which is easy to wipe & clean. Filled with a mixture of poly fibre & rubber chips which gives it a soft feel & slight bounce.



34.25cm X 34.25cm  
(13.5" X 13.5")

## 736WB WALL BALL



- Durable vinyl construction
- Flock & rubber filled

Code	Weight	Color	MRP
736WB6	6 Kg	Black/Purple	1499/-
736WB8	8 Kg	Black/Orange	1999/-
736WB10	10 Kg	Black/Green	2499/-
736WB12	12 Kg	Black/Red	2999/-

\* per pc





# STRENGTH BAGS

USI Universal's strength bags are ideal for full body workout through functional movements. They will help to build strength, power & core stability. You can use different weights as per your capability & specific exercise. Colour coded as per weight for easy recognition. Made of tough nylon material wibe which is easy to clean. Different handle positions for various exercises.



## 626PB EXTREME CORE BAG

TECH-SPEC.



- Touch quality nylon
- 2 handle positions available.
- Zip & hook/loop tab closure
- Ideal for: cross fitness & boot camp training  
Versatile handles for different lifts front  
Sides + back shoulder



Code	Weight	Length	Diameter	MRP
626PB5	5 Kg	51cm/20"	19cm/7.5"	1449/-
626PB10	10 Kg	56cm/22"	24cm/9.5"	1949/-
626PB15	15 Kg	56cm/22"	24cm/9.5"	2199/-
626PB20	20 Kg	61cm/24"	26.5cm/10.5"	2399/-
626PB25	25 Kg	61cm/24"	26.5cm/10.5"	2699/-

\* per pc



## 626SPB SUPER STRENGTH BAG

TECH-SPEC.



- Heavy duty never tear nylon
- 3 handle positions available
- Lace closure
- Ideal for: cross fitness & boot camp training  
Versatile handles for different lifts front  
Sides + back shoulder



Code	Weight	Length	Diameter	MRP
626SPB5	5 Kg	51cm/20"	19cm/7.5"	1599/-
626SPB10	10 Kg	56cm/22"	24cm/9.5"	2099/-
626SPB15	15 Kg	56cm/22"	24cm/9.5"	2349/-
626SPB20	20 Kg	61cm/24"	26.5cm/10.5"	2649/-
626SPB25	25 Kg	61cm/24"	26.5cm/10.5"	2899/-

\* per pc

## DSSS DISPLAY STAND SINGLE SIDE

TECH-SPEC.



- Solid metal construction
- Powder coated
- Collapsible construction for easy transport  
\* For Strength/Banana Bags
- Product weight: 10.25Kgs apx.
- Weight Capacity: 100Kgs/220 Lbs



Code	Dimensions apx	MRP
DSSS	(L)52 X (B) 50 X (H) 173 cm 20.5" x 19.5" x 68"	5499/-

\* bags not included

\* per set

## BANANA BAGS

USI Universal's banana bags are ideal for strength & cardio training. Great for building grip strength, arms, shoulders, back, legs & core. Made of tough nylon material which is easy to clean. Various handles & straps to perform different workouts. Choose weight as per your capability, colour coded for easy identification.



**CUSTOMIZATION  
ALSO AVAILABLE**

### BNB BANANA BAG

**TECH-SPEC.**  Performance

- Tough quality nylon material
- Nylon straps
- Filled with flock & plastic granules
- Ideal for cross fitness+ boot camp
- Training back shoulder mainly.

Code	Weight	MRP
BNB5	5 Kg	2849/-
BNB10	10 Kg	3799/-
BNB15	15 Kg	4899/-
BNB20	20 Kg	5999/-

\* per pc



# STUDIO TYRES

Tyres have become very popular for use in workouts these days. USI Universal's studio tyre are Hi-Tech play on the tyre shape which is much more versatile than a basic tyre. Yet, it is super tough like a real tyre. Available in 4 weights/sizes distinguished by vibrant colours. It helps in full body workout other than lifting, carrying, & flipping. You can use this product for push ups, Plyo jumps, push slides, drags, battle rope pulls, carry in group workout, passing to partner.



## STY STUDIO TYRES

TECH-SPEC. 

- Vinyl coated fabric, foam & metal
- Tyre replica with aesthetic looks
- Handles at various positions for different lifts

Code	Weight	Diameter Outside	Diameter Inside	Height	Color	MRP
STY40	40 Kg	87cm/34.25"	40cm/15.75"	26.5cm/10.5"	Purple/Black	27999/-
STY60	60 Kg	103cm/40.5"	50cm/19.75"	31.5cm/12.5"	Green/Black	32999/-
STY80	80 Kg	120cm/47.25"	60cm/23.60"	37cm/14.50"	Blue/Black	39999/-
STY100	100 Kg	120cm/47.25"	60cm/23.60"	37cm/14.50"	Red/Black	41999/-

\* per pc



 Assembly Video



# TYRE FLIP

USI Universal's tyre flip is a space efficient solution which helps in a full body workout. It enables you to build muscle & burn fat at the same time. Ideal for small gyms who want to give their customers a feel of an outdoor activity or a boot camp. Enjoy a partner workout or go solo on this mammoth. Add weights if you want to train heavier .



## TF FLIP TYRE

TECH-SPEC. 

WHILST STOCK LAST

- Rubber & metal construction
- Possible to add olympic weight plates for extra weight
- Shock pads on metal base absorb noise & prevent damage to floor

Code	Dimensions	MRP
TF	165x122x51cm 65"x48"x20"	156000/-

\* per set

 Assembly Video



## TYRES

USI Universal offers refurbished/worn out tyres in different sizes/weights for beginners/ladies & performance athletes. Each tyre is carefully selected, washed & painted for use. It helps in full body workout, muscle building & endurance training. Ideal for those who looking to develop explosive power.



### TY OLD TYRES

TECH-SPEC. 

- Tyre for exercise
- Refurbished for gym use only
- \* Old/used tyre in worn out condition

Code	Weight	Weight Range	MRP.
TY100	100 Kg	90-110 Kg	8899/-
TY70	70 Kg	65-75 Kg	6499/-
TY50	50 Kg	50-60 Kg	4699/-

\* per pc



## HAMMERS

USI Universal's hammers assist you in a full body workout when used with a tyre. Different weights available for ladies/beginners to pro athletes. Helps you build strength, improve your range of motion, increase your speed & agility. The rubber grip on the long handle gives a firm hold.

### HR HAMMERS

TECH-SPEC.  uFEELgrip+

- Fibreglass handle with rubber coating
- Drop forged high carbon steel
- Induction hardened

Code	Weight	MRP
HR3	3 Kg	2499/-
HR6	6 Kg	3499/-
HR10	10 Kg	4999/-

\* per pc



## PLYO BOXES

USI Universal's plyo box range is a perfect companion for jump training. Ideally used to develop lower body. Plyo box training will help you build power & explosiveness. Great workout for burning fat. USI Universal offers plyo boxes in different materials & paddings depending on your level of training.

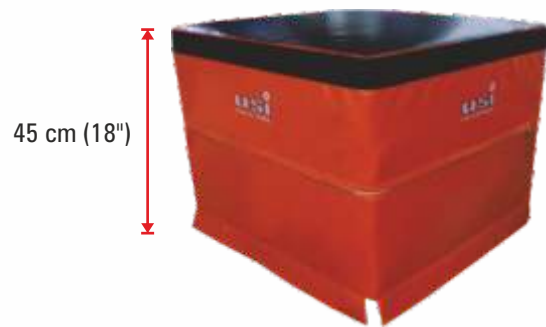

### SPB SOFT PLYO BOX

Ideal product for beginners. Soft padding avoids injury during falls & missteps. You need to place it against the wall for sturdiness.

**TECH-SPEC.**  **uFEELgrip** **SALT** 

- Touch nylon coated material 550 GSM apx
- Anti skid grip surface & bottom
- Attachable by hook & loop tape for stacking & increasing height
- Light weight padding **Set Rate: 17996/-**

Code	Dimensions apx	MRP
SPB6	61x61x15 cm (24"x24"x6")	2599/-
SPB12	61x61x30 cm (24"x24"x12")	3999/-
SPB18	61x61x45 cm (24"x24"x18")	4999/-
SPB24	61x61x60 cm (24"x24"x24")	6399/-

\* per pc

# PLYO BOXES

## PB METAL PLYO BOXES

USI Universal's metal plyo box are the most versatile with regard to price & space saving. The pyramid design makes sure that the box does not tip over. Textured rubber landing surface ensures a safe landing. Metal plyo boxes can be used outdoors as well. Anti rust powder coating enhances the life of metal part.

- TECH-SPEC.**   
- Metal construction
  - Non slip table top
  - Can be nested to save space **Set Rate: 19844/-**

Code	Dimensions (apx)	MRP
PB	15 cm (6")	1749/-
	30 cm (12")	2199/-
	45 cm (18")	2899/-
	60 cm (24")	3499/-
	75 cm (30")	4299/-
	90 cm (36")	5199/-

\* per pc

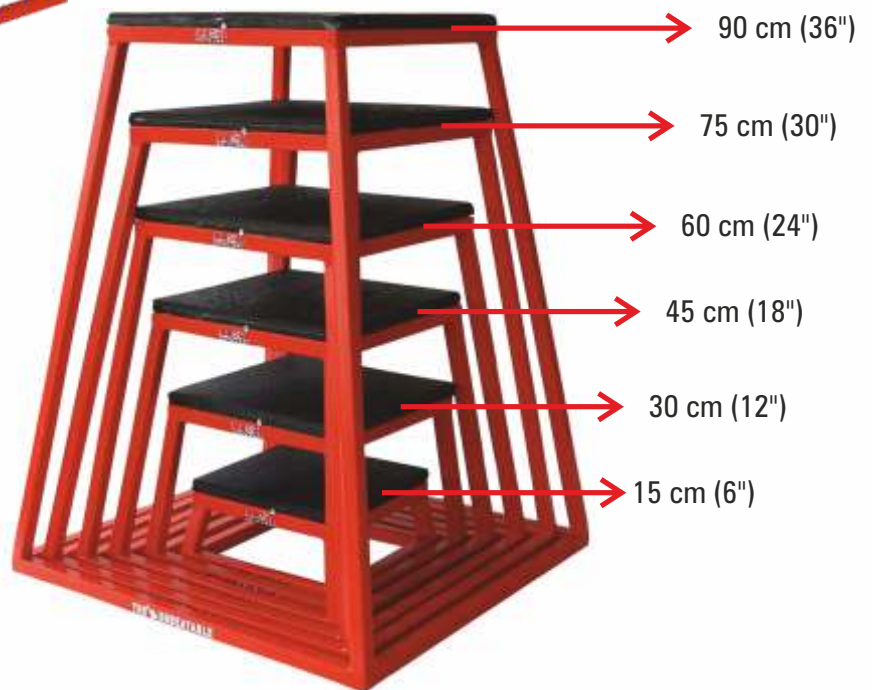

# PLYO BOXES

## MPB MULTI PLYO BOX (SOFT)

USI Universal designed this product for customers with space crunch. They can use the product from all sides for different heights.

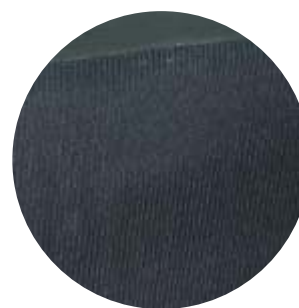

Anti-slip surface: You can have stability with every single set of jumps  
 No injuries: Durable foam material so you don't have to worry about getting injured

**TECH-SPEC.**



uFEELgrip



- Anti skid grip material vinyl coated
- Can be used from all sides
- Heavy dense padding for sturdiness
- Weight apx. 25 kg

Code	Dimensions apx	MRP
MPB	51cm x 60cm x 76cm (20"x 24" x 30")	14999/-

\* per pc

## WOOD JERK BLOCKS

**TECH-SPEC.**

Code	Size	MRP
WJBT	Top 5.70 cm	6999/-
WJB6	90x50x15cm	11999/-
WJB12	90x50x30cm	17999/-
WJB15	90x50x38cm	21999/-

\* per pair

\* Barbell/plates not included



## AMPB ADJUSTABLE METAL PULLING BLOCKS ADJ. 18CM-46CM

**TECH-SPEC.**

Code	MRP
AMPB	29999/-

\* per pair



## AMJB ADJUSTABLE METAL JERK BLOCKS ADJ. 86-112CM

**TECH-SPEC.**

Code	MRP
AMJB	59999/-

\* per pair

## WOODEN PLYO BOX

USI Universal's wooden plyobox is one complete thing for a wholesome cross training workout. The pre-drilled and countersunk holes with CNC router cuts make the assembling task easier. Laser marked logos render a fine finish and has a classy look with double coat on it.

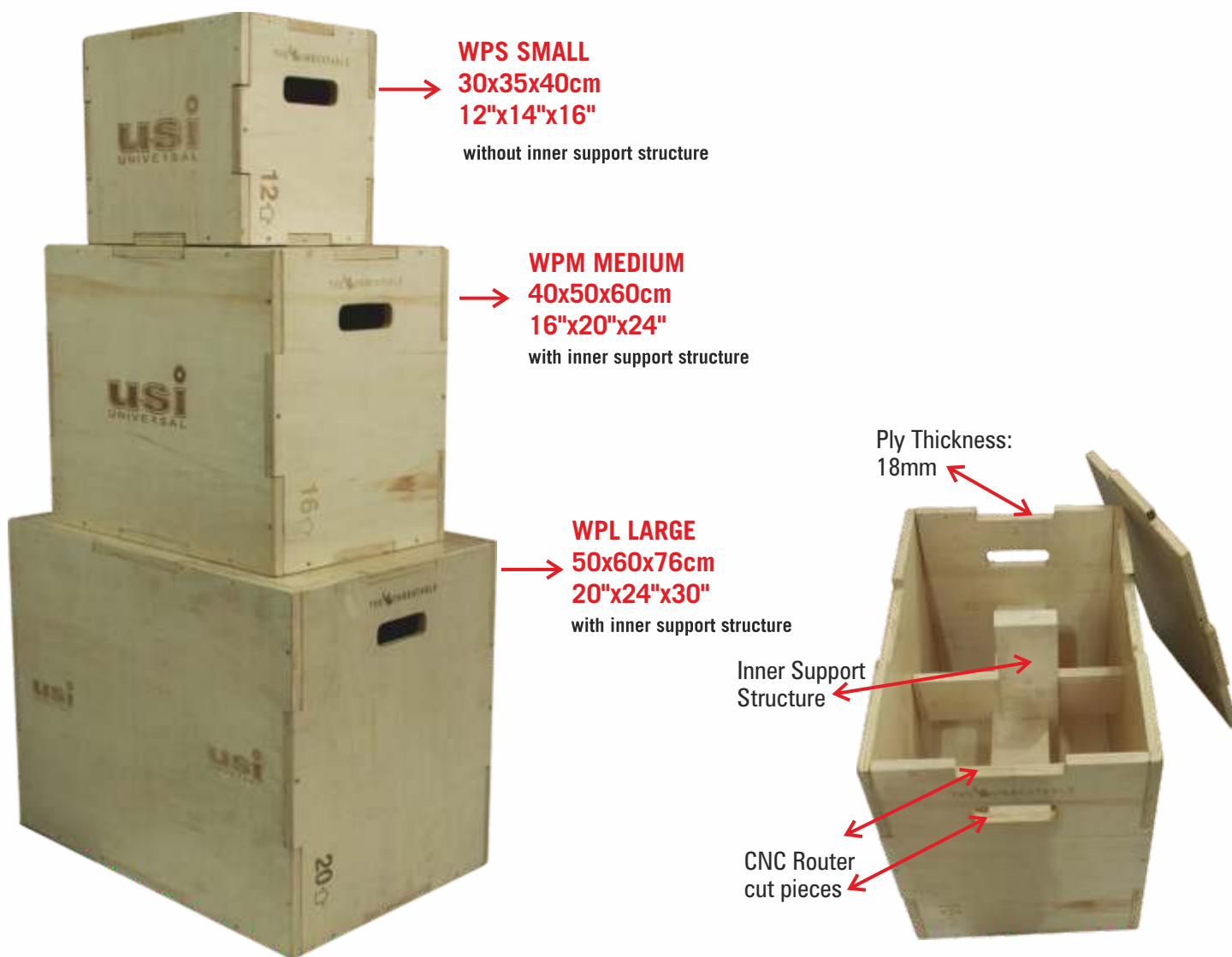

**WPS SMALL**  
**30x35x40cm**  
**12"x14"x16"**  
 without inner support structure

**WPM MEDIUM**  
**40x50x60cm**  
**16"x20"x24"**  
 with inner support structure

**WPL LARGE**  
**50x60x76cm**  
**20"x24"x30"**  
 with inner support structure

Ply Thickness:  
 18mm

Inner Support Structure

CNC Router cut pieces

### WP WOODEN PLYO BOX

TECH-SPEC.



- Layered wood construction
- Pre-drilled and countersunk holes
- Shuttering grade and is waterproof
- Ease to assemble
- Adjustable height with side change
- Adjustable achievable heights
- Assembly time: 15-20 minutes with rubber and wood mallet using power screw driver
- 30-35 minutes using star screw driver
- Ply thickness: 18mm

Code	Dimensions (apx)	Inner Structure	MRP
WPS	30X35X40cm (12"X14"X16")	Not Required	5999/-
WPM	40X50X60cm (16"X20"X24")	Included	9999/-
WPL	50X60X76cm (20"X24"X30")	Included	13999/-

\* per pc





# WHEEL SLED

When you think of wheel sled you think of a muscular man sweating it out in the gym. But wait, here's some good news! Anyone and everyone can use USI Univesal's wheel Sled, be it a beginner or pro, and reap its benefits. Pushing and pulling sled develops glutes, calves, hamstrings, quads and the core. Sleds are versatile, but they are a great training tool, especially for runners, sprinters, or any athlete looking to improve their leg power.



**WS WHEEL SLED**

TECH-SPEC.



- Heavy gauge metal construction
- Solid rubber tyres
- Black powder coated
- Adjustable resistance
- Weight capacity: 120 Kg/260Lbs

TANK dimensions apx: L: 125cm (49") x W: 81cm (32") x H: 95cm (37.3") Weight 75 Kg/165 Lbs

Basket dimensions apx: L: 109cm (43") x W: 55.5cm (22") x H: 30.5cm (12") Weight 12.5 Kg/27 Lbs

**Braking system:** Frictionless and adjustable magnetic braking system increases resistance with speed giving you a good workout.

**Bi-Directional Power:** With two weight posts for plates, the USI Universal's wheel sled uses resistance to enhance functional training.

**Workout zones:** There are three workout zones and each power curve position is just the starting point. The level of intensity of workout goes up with the speed with which the sled is either pushed or pulled.

**a.** The lowest zone is for speed power through length of your stride and endurance.

**b.** The middle zone helps build acceleration power by increasing launching power and frequency of the stride.

**c.** In the top zone, the lower body is challenged to its maximum and it builds explosive power and quickness in the body of the athlete.

**Indoors and outdoors:** The durable solid rubber wheels of the sled can move easily on hardwood floors or carpeted area and as easily on the rugged outdoor surfaces like grass, turf, concrete or other hard pavement.



Adjustable resistance

Code	Color	MRP
WS	Black	1,29,999/-

\* per set

# SLEDS

If you are looking to do a full body functional exercise, it can help you develop your core strength & improve your conditioning. Ideal product to burn that stubborn fat.



### 7031 MAMMOTH SLED

**TECH-SPEC.**

- Heavy duty metal construction
- Removable handles
- Completely collapsible for flat packaging
- Multiple bars for different pushing position
- Accommodates 50mm/2" olympic hole plates
- Anti rust powder coated
- Weight capacity: 180kg/400 Lbs

Code	Dimensions (apx)	MRP
7031	107cm x 120cm (42.25" x 47.25")	7999/-

\* per set

Assembly Video



### 7030 MULTI USE SLED

**TECH-SPEC.**

- Heavy duty metal construction
- Completely collapsible for flat packaging
- Can use the middle part separately
- Accommodates 50mm/2" olympic hole plates
- Anti rust powder coated
- Weight capacity: 200kg/450 Lbs

Code	Dimensions (apx)	MRP
7030	10cm x 60cm (4"X23.5")	12499/-

\* per set

Assembly Video



### 7028 WIDE SLEDS

**TECH-SPEC.**

- Heavy duty metal construction
- Apx. 16' (4.9m) long removable straps
- Accommodates 50mm/2" olympic hole plates
- Anti rust powder coated
- Weight capacity: 180kg/400 Lbs

Code	Dimensions - Wide apx	Color	MRP
7028	40x53cm (16"X21.5")	Black	6499/-

\* per set



# BATTLING ROPES

USI Universal's battling ropes help you with a full body workout. A great product to mix HIIT, strength & conditioning. We offer 2 types of ropes with different wave properties & thickness. Available 3 lengths as per space availability. The handle sleeves offer sturdy grip. Our battle ropes come complete with wall mount & carry case.



## BR BATTLING ROPE



- Made up of high quality polypropylene
- Thick shrink sleeve handles
- Three strand twisted construction
- Water resistant
- Comes with wall anchor & carry bag
- Spare handle sleeves included
- Thickness: 45mm apx.



## BBR BRAIDED BATTLING ROPE



- Made of high quality polyester
- Thick shrink sleeve handles
- Braided construction
- Comes with wall anchor & carry bag
- Spare handle sleeves included
- Thickness: 38mm apx.

Code	Color	Size apx	MRP
BR9	Black/Red	9m/30'	5999/-
BR12		12m/40'	7499/-
BR15		15m/50'	8999/-

\* per pc

Code	Color	Size apx	MRP
BBR9	Black/Red	9m/30'	9399/-
BBR12		12m/40'	11999/-
BBR15		15m/50'	14349/-

\* per pc

COMPARISON CHART						
Product Features	BR Battling Rope			BBR Braided Battle Rope		
Material	♻️ Polypropylene			Polyester Braided		
Construction/Interlacing	3 Strand Twisted			Braided		
Unisex	✓			✓		
Wave Effect / Flexibility	Stiff			Smooth		
<b>Wear Resistance</b>						
• Anti-fungal	✓			✓		
• Water resistant	✓			✓		
• Fray Resistant	70%			90%		
• Dirt Resistant	70%			90%		
Coated handles	✓			✓		
Hand Grip	Oversized thick			Perfect / firm		
<b>Dimensions</b>						
• Thickness/Diameter Ø	.....			.....		
• Handle length	.....			.....		
• Length	9m	12m	15m	9m	12m	15m
Price	5599/-	7100/-	8399/-	6199/-	7930/-	9499/-
Useage	Indoor/Outdoor			Indoor/Outdoor		
Woven	Normal			Thick		
Flexibility	70%			85%		
Weight	70%			85%		



## CLIMBING ROPES

USI Universal's climbing rope will help you develop your upper body strength & core. It also helps develop a strong grip.



### CR CLIMBING ROPE

TECH-SPEC. 

- Made up for organic high quality jute
- Metal hook with bolts
- Thickness: 40mm apx.

Code	Size (Apx.)	MRP
CR12	3.65m/12'	2499/-
CR15	4.55m/15'	2799/-

\* per pc



## JUTE PULL UP ROPES

USI Universal's pull up ropes help you build your back & biceps. Promotes strong grip. Available in 2 different materials & lengths as per customer liking.

### JPR JUTE PULL UP ROPE

TECH-SPEC. 

- Made up for organic high quality jute
- Eco-friendly
- Spare handle sleeves included
- Thickness: 40mm apx.

Code	Size (Apx.)	MRP
JPR2	60 cm/2'	349/-
JPR3	90 cm/3'	399/-
JPR4	120 cm/4'	449/-
JPR5	150 cm/5'	499/-
JPR6	180 cm/6'	599/-

\* per pc



### PPR POLY PULL UP ROPE

TECH-SPEC. 

- Made up of high quality polypropylene
- Shrink resistant sleeve handles
- Three strand twisted construction
- Water resistant
- Spare handle sleeves included
- Thickness : 45mm apx.

Code	Size (Apx.)	MRP
PPR2	60 cm/2'	599/-
PPR3	90 cm/3'	799/-
PPR4	120 cm/4'	899/-
PPR5	150 cm/5'	999/-
PPR6	180 cm/6'	1099/-

\* per pc



# SKIP / JUMP ROPES

USI Universal's skip ropes cover a horizon of customer needs. Offering speed to a boxer, thick ropes for a Muay Thai fighter, super speed ropes for cross training athletes or someone trying to lose weight through cardio fitness. A complete range from budget friendly models to engineered products.



## 629CJ JUMP ROPE

TECH-SPEC.



- Lightweight cable rope length 2.7m/9' apx with screws to fit the height
- Anti-slip handles for firm grip
- 3mm PVC rope with metal cable insert

Code	MRP
629CJ	1199/-

\* per pc



## 629BR BEARING SPEED ROPE METAL

TECH-SPEC.



- Aluminum & plastic construction
- High speed bearings
- Adjustable length 3m/10' apx
- Tapered & knurled grip
- Coated speed cable

Code	MRP
629BR	949/-

\* per pc



## 629RX RX SPEED ROPE

TECH-SPEC.



- Plastic, foam & metal construction
- Adjustable length 3m/10' apx
- High speed bearing for rotation
- Thick customized handles
- Coated speed cable

Code	MRP
629RX	899/-

\* per pc



## 629WT WEIGHTED

TECH-SPEC.



- Plastic handles
- 6mm adjustable PVC rope 2.7m/9' apx.
- Weight bar in handles 225 gms each apx.

Code	MRP
629WT	999/-

\* per pc



## 629M (AL) ALUMINUM

TECH-SPEC.



- Casted aluminum handles
- 8 mm leather rope length 2.7m/9' apx
- Ball bearing action

Code	MRP
629M	849/-

\* per pc



## 629LH LONG HANDLE ABS SPEED ROPE

TECH-SPEC.



- Abs plastic & metal construction
- Low friction bush for rotation
- Coated speed cable
- Adjustable length 3m/10' apx

Code	MRP
629LH	649/-

\* per pc



## 629TC CABLE

TECH-SPEC.



- Durable plastic & TPR handles
- Ergonomic shape
- High speed ball bearing
- 5mm PVC rope with steel cable insert 2.7m/9' apx.

Code	MRP
629TC	599/-

\* per pc



## 629N LEATHER

TECH-SPEC.



- Wooden handles
- 6mm leather rope
- Side rotation
- Length : 2.7m/9' apx.

Code	MRP
629N	490/-

\* per pc



## 629ST STALKY

TECH-SPEC.



- Durable plastic & TPR handles
- 6mm adjustable PVC rope with rope lock
- Length: 2.7m/9' apx.
- High speed ball bearing

Code	MRP
629ST	499/-

\* per pc

# SKIP / JUMP ROPES



### 629GPL LEATHER

**TECH -SPEC.** 

- Plastic & foam handles
- 6mm leather rope length 2.7m/9' apx.
- Ball bearing action

Code	MRP
629GPL	449/-

\* per pc



### 629TS THAI STYLE

**TECH -SPEC.** 

- Thick plastic handles
- Ball bearing action
- Thick 9mm rope length 2.7m/9' apx

Code	MRP
629TS	399/-

\* per pc



### 629GR GRIPPA

**TECH -SPEC.**  

- Durable plastic & silicon rubber handles
- Soft grip feel
- PVC rope length 2.7m/9' apx

Code	MRP
629GR	360/-

\* per pc



### 629SM SLIM

**TECH -SPEC.** 

- Long & light weight plastic handles
- 5mm adjustable PVC rope with rope lock
- Rope length 2.7m/9' apx

Code	MRP
629SM	349/-

\* per pc



### 629TR TRANSY

**TECH -SPEC.** 

- Light weight plastic handles
- 5mm adjustable PVC rope with rope lock
- Rope length 2.7m/9' apx.

Code	MRP
629TR	399/-

\* per pc



### 629GHP HOPPER

**TECH -SPEC.**  

- Light plastic handles
- PVC rope adjustable with rope lock

Code	MRP
629GHP	270/-

\* per pc



### 629SS SLEEK

**TECH -SPEC.** 

- Durable plastic & TPR handles
- 6mm PVC rope 2.7m/9' apx.
- Ball bearing action

Code	MRP
629SS	249/-

\* per pc



### 629GPS STEEL WIRE/PVC

**TECH -SPEC.** 

- Plastic & foam handles
- 4.5mm PVC rope with steel cable insert 2.7m/9' apx

Code	MRP
629GPS	299/-

\* per pc



### 629X SPEED ROPE

**TECH -SPEC.** 

- Plastic & metal construction
- Adjustable length 3m/10' apx
- Thin handles
- Coated speed cable
- Long metal insert for smooth rotation

Code	Color	MRP
629XO	Olive	280/-
629XR	Red	280/-

\* per pc

# SKIP / JUMP ROPES



### 629GP PVC

TECH -SPEC.



- Plastic & foam construction
- 5.5mm PVC rope length 2.7m/9' apx
- Ball bearing action

Code	MRP
629GP	220/-

\* per pc



### 629SP SPEED SKIP ROPE

TECH -SPEC.



WHILST STOCK LAST

- Plastic & metal construction
- Plastic rotation insert
- Adjustable length
- 3.5mm coated speed cable length 2.7m/9' apx.

Code	Colors	MRP
629SPO	Green	249/-
629SPR	Orange	

\* per pc



### 629DLX DELUXE

TECH -SPEC.



- Wooden handles
- 6mm PVC rope with adjuster

Code	MRP
629DLX	170/-

\* per pc



### 629SA SUPER ADJUSTABLE

TECH -SPEC.



- Wooden handles
- 5mm PVC rope with adjuster length 2.7m/9' apx.

Code	MRP
629SA	160/-

\* per pc



### 629C ECONOMY

TECH -SPEC.



- Wooden handles
- 10mm cotton rope length 2.7m/9' apx.

Code	MRP
629C	180/-

\* per pc



### 629AS PVC

TECH -SPEC.



- Plastic handles
- 5mm PVC rope 2.7m/9' apx.

Code	MRP
629AS	99/-

\* per pc

## AIR BIKE

The best air bike for cross training, fitness enthusiasts, club members, trainers and physical therapists. Sturdy high-tensile steel frame sealed with a layer of industrial powder coating. Sealed cartridge bearings are used on all moving parts with lower maintenance requirements.



### ARB PRO AIR BIKE



- 60cm (24") steel fan delivers unlimited resistance
- 4-way adjustable seat post accommodates users of all sizes
- Function of computer includes time/speed/distance/calories/watts/interval setting (20/10) /rpm/heart control/target heart
- Pedal, push and pull for a workout that engages the entire body
- Chain & belt drive system promise quieter and less maintenance
- With transport wheels for easy movement
- Foot pegs for rest intervals
- Thick tube handles with cushion
- Chain and belt driven
- Maximum user weight: 159 Kg/350Lbs apx.
- 68cm apx. (27") steel fan
- Delivers unlimited resistance
- 53cm apx. (21") high base
- 140cm apx. (55") monorail
- Anti rust powder coated
- Made in Taiwan

Code	Color	MRP
ARB	Black / Silver	1,34,999/-

\* per set





# AIR ROWER



USI Universal rower's new console folds and rolls away on 4 wheels. Smoother, more durable, heavier than any competitor. Resistance with 10 damper settings.



ONE TOUCH PEDAL ADJUSTMENT

## RW AIR ROWER

TECH-SPEC.



- Base/Frame:
  - 43 Kg+ (95LB) Heavy duty frame
  - 225 Kg+ (500LB) Max user weight
  - 53cm apx (21") High base
  - 140cm apx (55") Monorail
- Console/Programs:
  - Tracking at all times: Time Rowed, Meters, Strokes per Minute, Calories, Watts, 500m pace per stroke, total strokes, heart rate (when connected to a heart rate monitor)
  - 9 Displays in large middle window: Total Time, 500m Pace average of workout, Average Meter per stroke, Max Heart Rate, Calories per Hour, Force Curve, Max Watt, Watt Chart per stroke, Average Watt
  - Pre-Built Programs: Quick Start, Competition Racing, Interval/Tabata, Target Time, Target Distance, Target Calories, Target Strokes, Target Heart Rate, and more!
- Comfort/Adjustments:
  - 1 touch adjustment on footing
  - Fold-Up design for easy storage and transport
  - Seat is 51cm apx. (20") from ground for easy entry/exit
  - Extra padding on seat
  - Extra padding on handle
- Specs:
  - Net Weight: 43 Kg+ (95 Lbs)
  - Assembled dimensions: 221cm (7'3") front stabilizer to rear stabilizer
  - 254cm (8'4") from fan to rail. 51cm (20") wide.
  - Shipping weight: 50 Kg/110 Lbs
- Shipping dimensions: 147cm x 66cm x 38cm (58" x 26" x 15") apx.

Code	Color	MRP
RW	Black / Silver	1,54,999/-

\* per set



# STEPPERS

A great product to improve your cardiovascular health. USI Universal offers a wide variety of steppers from high end commercial use to home use product.

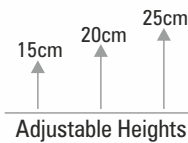

## STRK STEPPER PRO

One of the most versatile commercial grade steppers on the market. Adjustable height, non slip surface and a big deck make it a durable choice for use in gyms, studios or high end personal training.

**TECH-SPEC.** uFEELgrip+

- Durable plastic construction
- Adjustable height in 3 steps: 15cm (6"), 20cm (8"), 25cm (10") apx.
- Non slip top surface
- Rubberised surface for grip
- Weight: 8 Kg apx,

Code	Dimensions apx.	MRP
STRK	100x38x15cm (39"x15"x6")	7999/-

\* per pc

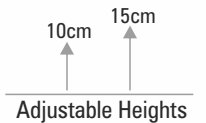

## ST27 AEROBIC STEP BOARD

**TECH-SPEC.** uFEELgrip

- PP material construction
- Textured surface for grip
- Adjustable height in 2 steps: 10cm (4"), 15cm (6") apx.



Code	Dimensions apx.	MRP
ST27	67x27x10cm (26"x11"x4")	1700/-

\* per pc

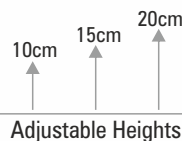

## ST29 AEROBIC STEP BOARD

**TECH-SPEC.** uFEELgrip

- ABS material construction
- Textured surface for grip
- Adjustable height in 3 steps: 10cm (4"), 15cm(6"), 20cm (8")

Code	Dimensions apx.	MRP
ST29	78X29X10cm (31"x11"x4")	2650/-

\* per pc



## ST28 AEROBIC STEP BOARD

**TECH-SPEC.** uFEELgrip

- PP material construction
- Textured surface for grip
- Adjustable height in 3 steps: 12cm (5"), 17cm(7"), 22cm (9")

Code	Dimensions apx.	MRP
ST28	70x28x12cm (28"x11"x5")	2299/-

\* per pc



### SDK STEPPER DECK

Great product for personal training studios & home use. Can be used as a stepper, flat bench, incline bench & plyo box.

**TECH-SPEC.**  **uFEELgrip**

- Plastic construction
- Use as a stepper or bench
- Bench adjustable at 30degree , 45degree & 70 degree angles
- Storage for small fitness accessories
- Height adjustable for stepper
- Textured surface for grip

Code	MRP
SDK	17999/-

\* per pc



### SWR STEPPER WITH RISER

A high end commercial use stepper with an anti slip surface. Risers can be used to form an incline bench for various workouts.

**TECH-SPEC.**  **uFEELgrip+**

- Polypropylene plastic construction
- Anti slip rubber surface
- 4 risers can be used to create incline
- Riser lock system ensures stability

Code	MRP
SWR	10999/-

\* per pc

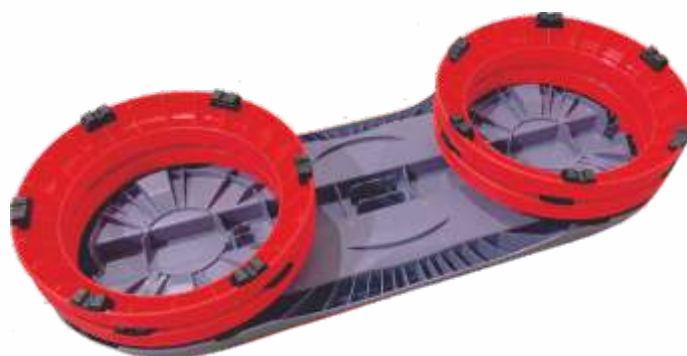

# CARDIO PUMP REP SET

USI Universal's cardio pump sets helps you do a full body barbell workout in a group or by yourself. It helps you build strength while burning fat. When accompanied with high energy music & instructor, it can be a great product for those bored by a regular gym routine.



## CPS CARDIO PUMP/REP SET 20 Kg

**TECH-SPEC.**  Performance

- Set includes:  
1 foam padded bar, 3 pair of plates & 1 pair of locks

Code	MRP
CPS	10499/-

\*per set

## CPSR RACK FOR CARDIO PUMP / REP SET

**TECH-SPEC.**  Base  RUST  DIY

- Metal construction
- Ideal for holding 10 sets
- Comes flat packed
- Ideal for 31mm hole plates only
- Anti rust powder coated

Code	Color	MRP
CPSR	Black	16499/-

\* bars/plates not included \* per set



# BODY TRAINING BARS & RACK

USI Universal's body training bars are a very simple strength training & muscle training tool. Ideal for beginners at a commercial gym group class or a home gym. Adds challenge to your traditional exercises like curls, rows & squats. Also, it helps to develop your core. Available in different weights to choose as per your level of training.



## BTB BODY TRAINING BAR W/FLOWER ENDS



- Foam, metal & plastic construction
- Anti rust powder coated
- Length 122cm/4' apx.

Code	Weight	Color	MRP
BTB3	3 Kg	Green	1999/-
BTB4	4 Kg	Red	2299/-
BTB5	5 Kg	Blue	2499/-
BTB6	6 Kg	Purple	2799/-
BTB7	7 Kg	Orange	2999/-

\* per pc

## BTBR RACK FOR BODY TRAINING BAR



- Dimensions: 35.5x31x122cm(14"x12"x48") apx.
- Anti rust powder coated
- Ideal for storing 12-16 bars

Code	Weight apx	Color	MRP
BTBR	16 Kg	Black	11999/-

\* Training bars not included \* per set



## RUBBER WEIGHT LOGS

Loaded momentum training hit the gyms in 2010 and its popularity is going up with each passing day. This kind of training combines full-body movement with load, in turn enhancing the vitality, performance and reconditioning. It is an extremely effective tool that integrates a dumbbell, barbell, kettlebell, balance ball and other fitness equipments. It is incredibly durable and functional. USI Universal's rubber weight log can be used to do various types of movements.



### VP RUBBER WEIGHT LOG



- Made of natural rubber, the weight log comes with comfortable handles to work out your whole body.
- Natural rubber makes this exercising accessory a very durable product with a long life.
- There are thousands of exercises that you can perform using this training tool.
- The weight log is dumbbell, barbell, kettle bells and balance ball, all rolled into one, and thus can be used to do many different kinds of movements.
- Easy storage: Like an ordinary water pipe, the rubber weight log can be easily stored anywhere or carried from one place to another.

Code	Weight	Length	Diameter	Color	MRP.
VP6	6 Kg	108cm/42.5"	13cm/5"	Red	7499/-
VP8	8 Kg	108cm/42.5"	14cm/5.5"	Blue	9349/-
VP10	10 Kg	108cm/42.5"	14cm/5.5"	Green	12499/-
VP12	12 Kg	119cm/47"	20cm/8"	Black	14999/-

\* per pc



## YOGA



### YB YOGA BLOCK CORK

USI Universal's cork yoga block is an eco friendly product which helps to improve your alignment & posture. It helps you improve your range of motion. Cork yoga blocks are comfortable to sit on & help in deep relaxation. Cork yoga blocks are more solid & harder than foam blocks. This makes them more sturdy & ideal for better balance.

**TECH-SPEC.**



- Made of natural cork
- Firm feel in comparison to normal blocks
- Gives generous support

Code	Dimensions apx	MRP
YB	23x15x8cm (9"x6"x3")	999/-

\* per pc



### YS YOGA STRAP

**TECH-SPEC.**



- Soft cotton webbing
- Metal 'D' ring x 2 end closure

Code	Size	MRP
YS	168cm x 3.75cm (66" x 1.5")	299/-

\* per pc



### 790YM YOGA MAT

**TECH-SPEC.**



- Fabric & Tetron construction
- Rectangular stitching/quilted
- Foldable
- The grid stitching acts as a guide to maintain proper gap between limbs.



Code	Dimensions apx	MRP
790YM	180cm x 90cm x 18mm (6'x3'x0.75")	3299/-

\* per pc



### YOGA MAT

**TECH-SPEC.**



- Dense foam construction
- Non-slip, durable and light weight
- Compactly for carrying & storage
- Ideal for stretching exercises
- Complete with basic yoga strap
- Size: 60cm x 183cm (2' x 6') apx.

Code	Thickness	MRP
YM4	4mm	599/-
YM6	6mm	849/-

\* per pc

## AB STRAPS

### 733AB AB STRAPS

USI Universal's ab straps are your best training partner for abs and core. A simple yet sturdy strap that you hang to a bar. The comfortable, wide pads are lined with soft neoprene to minimise stress in the arms. It has been tested to hold a person upto 110 Kg of weight. Great for beginners and professionals. Easy to use at home or a commercial gym. The steel carabiner comes with a lock mechanism which easily hooks on to any gym equipment.

**TECH-SPEC.**  **uFEELsoft** 

- Heavy duty Nylon exterior
- Soft neoprene lining
- Steel carabiner with lock
- Wide pad design
- Maximum user weight capacity: 100 Kg/220 Lbs

Code	MRP
733AB	2349/-

\* per pair



## AB WHEELS

Working out on USI Universal's ab wheels produces much better results than crunches & other flexion exercises. A great workout tool for upper body which also does wonders for your hips & thigh muscles. Light weight & easy to carry.



### AW1 AB WHEEL ROLLER

**TECH-SPEC.** 

- Plastic & metal construction
- Soft & sturdy handgrip
- Non slip tpu coating on wheel
- Portable & lightweight
- Comes flat packed

Code	Wheel Dia apx	Thickness	MRP
AW1	18cm/7"	5cm/2"	899/-

\* per set



### AWP AB WHEEL PRO

**TECH-SPEC.** 

- Rubber & plastic construction.
- Soft handle
- Double and bigger wheel for better balance
- Can be used with feet also

Code	Wheel Dia	Thickness	MRP
AWP	29cm/11.5"	4.5cm x 2 1.8" x 2	2499/-

\* per set



# EXERCISE SLIDERS

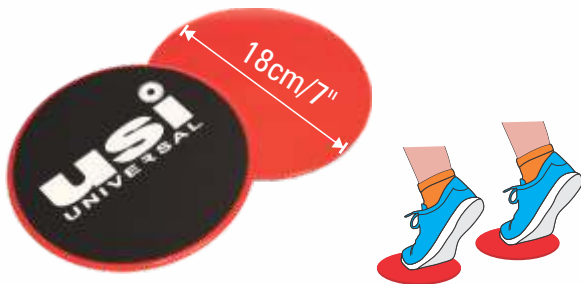

## ESR EXERCISE SLIDER

USI Universal's exercise sliders are a very simple yet effective and exciting tool for core exercises. Tone your legs & arms. You can add variety to your lunges, planks or simply innovate your own moves. The sliders are compact and lightweight. Carry them to the gym or use at home at your own convenience.

TECH-SPEC. 

- ABS plastic shell
- Soft EVA foam pads with polyester lining
- Lightweight & portable
- Dual side for use on all surfaces
- Ideal for core exercises

Code	Diameter apx	MRP
ESR	18cm(7")	449/-

\* per pair



## ESO EXERCISE SLIDER OVAL

USI Universal's oval exercise sliders are advanced in shape and function. The ergonomic shape assists in smooth sliding movements. It helps you to fit your hands, knees & toes perfectly. Tone your legs & arms. You can add variety to your lunges, planks or simply innovate your own moves. The sliders are compact & lightweight. Carry them to the gym or use at home at your own convenience.

TECH-SPEC. 

- Polypropylene plastic shell
- Thick EVA foam pad with polyester lining
- Ergonomic shape
- Ideal for grass/foam/carpeted surfaces
- Lightweight & portable
- Ideal for core exercises

Code	Diameter apx	MRP
ESO	23x13cm (9"x5")	599/-

\* per pair



## 800DS DOOR SIT UP SUPPORT

TECH-SPEC. 

- Plastic & foam construction
- Adjustable length
- Supports leg raises also

Code	MRP
800DS	999/-

\* per pc

WHILST STOCK LAST



## AB PAD

The AB PAD is a core training support device for your lumbar spine (where the spine curves inward towards the abdomen). It helps in full range of motion of the abdominal muscles (elongation and contraction). This extension maintains correctness of motion while accelerating the development of the entire abdomen. AB PAD training is a pre cursor to graduate to more complicated exercises on glutes & hamstrings developer. It also helps in conditioning the body for barbell movements. A must for super abs and a strong core.

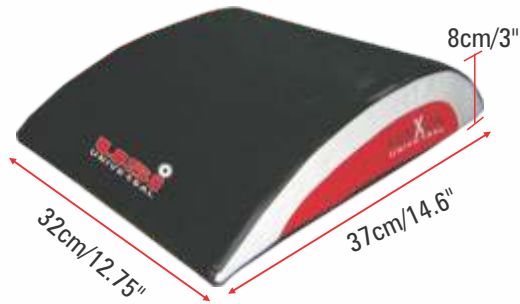

### 7018 AB PAD



- Durable PU construction
- Hand crafting padding

Code	Dimensions apx	MRP
7018	L:37cm X W:32cm X H:8cm (14.6"x12.75"x3")	999/-

\* per pc



## BC BALANCE CUSHION

While using USI Universal's Balance Cushion, you will put extra effort to maintain balance. This will strengthen your core and limb muscles. The little adjustments you do will improve your posture. USI Universal's balance cushion has a textured surface which improves blood circulation. It's compact size makes it very easy to travel with. This Balance cushion can be used in rehabilitation for sprained ankle, knee surgery, joint replacement, arthritis, etc. It can help your kids in case they have an issue with sitting still, poor balance and weak core strength.

### TECH-SPEC.



- Thermoplastic construction
- With acupressure points
- Builds core strength
- Helpful in multiple postures like standing, sitting, squatting, lying down etc.
- Ideal for rehabilitation
- Helps kids with poor balance & weak core
- Inflating pump & needle included

Code	Dia apx	MRP
BC	35 cm/13.75"	1049/-

\* per pc



## BB BALANCE BOARD

USI Universal's balance board will help you to improve your balance & coordination. It will help you to improve your motor skills, posture & strengthen your lower leg muscles. Great tool for injury rehabilitation.

### TECH-SPEC.

uFEELgrip



- Wood & plastic construction
- Anti slip surface

Code	Dia apx	MRP
BB	40cm/15.75"	1299/-

\* per pc



# GYM BALLS

USI Universal's gym balls are multi purpose fitness accessory which can be used for the entire body. They can also be used for various balance exercises, injury rehabilitation & physical therapy.

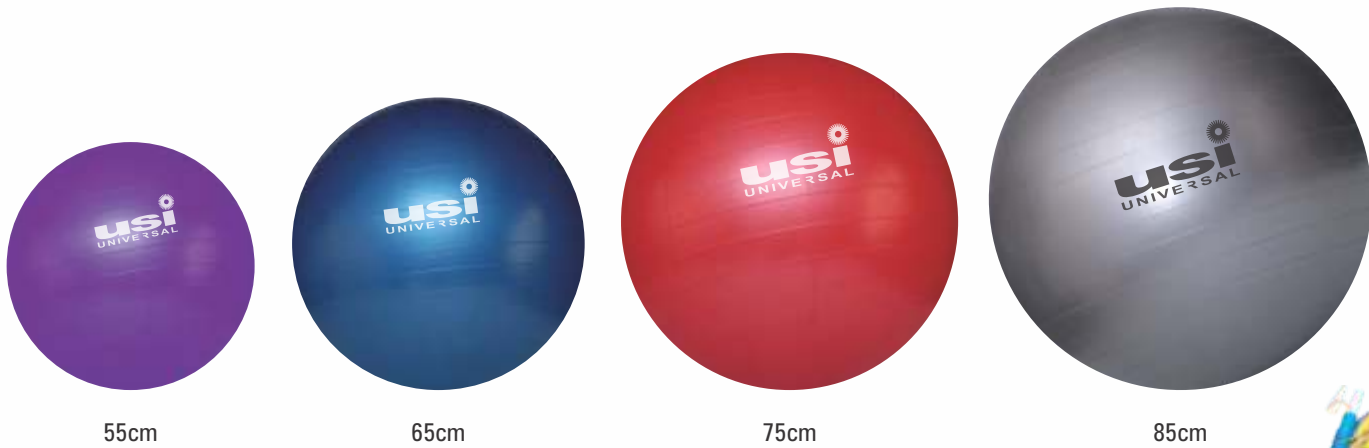

55cm

65cm

75cm

85cm



Foot Pump

### GB GYM BALL

TECH-SPEC. 

- PVC material construction
- Ideal for back exercises, sit ups & general fitness
- Anti burst ability for upto 2000 Lbs
- With high quality foot pump

Code	Size	MRP
GB55	55 cm/21.7"	999/-
GB65	65 cm/25.6"	1099/-
GB75	75 cm/29.5"	1299/-
GB85	85 cm/33.5"	1449/-

\* per pc

### GBRK GYM BALL RACK

TECH-SPEC.

Code	Height	MRP
GBRK	193cm(76")	13999/-

\* per set



### GBS GYM BALL STACKER

TECH-SPEC. 

- Thick plastic construction
- Ideal for holding 3 gym balls
- Comes flat packed

Code	Set	MRP
GBS	Set of 3	899/-

WHILST STOCK LAST

COMPARISON CHART					
Product Features	Balance Step Ball (BSB)	Gym Ball (GB)			
Unisex	✓	✓			
Stability	90%	50%			
Range of motion	90%	60%			
User type (As per individual balance)	Beginner	Intermediate			
Versatility of Usage	90%	60%			
Space Utilized	Less	More			
Weight (Apx.)	5.6 kg	55cm 0.800g	65cm 1kg	75cm 1.2kg	85cm 1.4kg
Utility	Multiple	Limited			
Colour	Silver	Blue, Red, Silver			
Variants	Single (58cm apx)	55cm	65cm	75cm	85cm
Price	10499/-	999/-	1099/-	1299/-	1449/-

# BALANCE STEP BALL

USI Universal's balance step ball is one of the best bets to invest in if you don't wish to go outdoors. It can be used to exercise every muscle of your body; be it in the gym or even if you wish to get it home. Balance step ball will make you a pro in training yourself with all factors of fitness like cardiovascular, toning, balance training, flexibility & stabilization. USI Universal's balance step ball comes with elastic resistance bands & handles which are detachable, upper body workout can be managed effortlessly with them. Free hand pump is packaged with the product so you can inflate it as per the required resistance level of your fitness. One can always test one's balance and work on better body positioning and cueing for cardio, core, agility, strength and mobility exercise and drills. When it comes to the variations in exercise and workouts, the options are endless. It renders you with complete freedom to use it any which way you wish it, irrespective of your fitness levels. It can be used on both sides for your training; the flat side can be used for push-ups, sit-ups and more. The rubberised bottom surface gives excellent grip. USI Universal's balance step ball is value for your money as you can do a variety of exercises with it like mountain climbers, side lunges, chest press, squats and lunges to name a few.



### Pump & Valve Plug Included

It is lightweight and portable. Users can let out the air and pump it again before use.



(With air pump, resistance handles/bands)

### BSB BALANCE STEP BALL

**TECH-SPEC.**   **uFEELgrip+**

- Elastic resistance bands with handles
- Can be used both sides
- Air pump & valve plug included for easy inflation
- Ideal for side lunges, chest press, squats etc.
- TPR rubberised surface for extra grip
- Weight 5.6 Kg apx.
- Colour: Silver

### Material

It is made up of durable quality vinyl and is quite sturdy, ABS plastic which will last long and is anti-slip. It has a large weight capacity for work-outs. ABS base provides that extra safety standards and heavy-duty structure. The flat side is made up of TPR – Thermoplastic rubbers which lends it a long life.

Code	Color	MRP
BSB	SILVER	10499/-

\* per pc

### Measurement:

Weight (Apx.) : 5.6 kg  
 Colour : Silver  
 Variants : Single 58cm(22.8") apx



### BSBRK BALANCE STEP BALL RACK ONLY

**TECH-SPEC.**

Code	Height	MRP
BSBRK	167cm/66"	20999/-

\* per set

## RESISTANCE TUBES/EXPANDERS

USI Universal offers a wide variety of resistance bands & loops. Very lightweight & easy to carry around. Ideal for many compound exercises. They are available in different resistance levels. Customers can buy as per the range of motion & control. The bands help you build strength & improve mobility. Ideal for recovery & rehabilitation of injuries.

### RP RESISTANCE TUBE/EXPANDER FIXED

Ideal for stretching & exercising the upper & lower body. You can do a variety of exercises for arms, shoulders, chest & legs. Very easy to use at home & carry while traveling. Different resistance levels available.

TECH-SPEC.  uFEELsoft

- TPR & plastic construction
- Resistance band 1x127cm(50")
- Fixed length
- Dual injection soft handles

Code	Color	Size	MRP
RPH1	■	HEAVY	949/-
RPM1	■	MEDIUM	899/-
RPL	■	LIGHT	849/-

\* per pc



### 800RP ADJUSTABLE RESISTANCE TUBE/EXPANDER

TECH-SPEC.  EVA

- Latex construction & moulded handles
- Resistance band 1 x 150cm (59")
- TPR resistance tube
- Soft moulded handles

Code	Size	MRP
800RPM	MEDIUM	949/-
800RPH	HEAVY	999/-

\* per pc



### 800RP3 3 IN 1

TECH-SPEC.  uFEELsoft

- Latex & plastic construction
- 3 resistance bands of different levels
- Measuring 130 cm (51") each
- Complete with carry case
- TPR resistance tube
- Soft moulded handles

Code	MRP
800RP3	1849/-

\* per pc



## RESISTANCE TUBES/EXPANDERS

### DRT DOUBLE RESISTANCE TUBE

TECH-SPEC. 

- TPR & moulded plastic construction
- Light duty product

Code	Cord length	MRP
DRT	108cm/42.5"	449/-

\* per pc



### IRT RESISTANCE TUBE

TECH-SPEC. 

- TPR & foam handle
- Light duty product

Code	Cord length	MRP
IRTM	Medium	349/-
IRTL	Light	299/-

\* per pc



## CHEST EXPANDERS

USI Universal offers a wide variety in chest expanders with regards to resistance levels & economy. Ideally used for developing chest muscles. It can also be used for back & legs. Our chest expanders can help you increase your range of motion.



### 800SE SOFT EXPANDER

TECH-SPEC. 

- Latex cord & moulded foam construction
- TPR & moulded foam construction
- Light weight, portable for home & official use

Code	Size apx	MRP
800SE	12x48cm (4.7"x19")	630/-

\* per pc



## ADJUSTABLE EXPANDERS



### 800AE1 - 4 CORDS

### 800AE - 2 CORDS

TECH-SPEC.  

- TPR cord & moulded plastic handles.
- Removable TPR cords
- Great for resistance workouts
- Enhances strength, flexibility & brings core stability

Code	Cords	Length	MRP
800AE1	4 Cords	48cm/19"	1199/-
800AE	2 Cords	50cm/19.7"	999/-

\* per pc

### PLR PILATE RING

TECH-SPEC.

Code	MRP
PLR	999/-

\* per pc



# LATEX LOOPS/BANDS

USI Universal loops help in physical therapy, recovery, flexibility as well as mobility. Great for assisted chin ups / dips. Add tension to bench press, squats & deadlift.



## LATEX LOOPS



- Latex construction
- Ideal for conditioning, stretching & rehabilitation
- Increases resistance
- Enhances speed and agility
- Circumference: 208cm(82") apx

Code	Dimensions apx.	MRP
L1	208cm X 2mm X 15mm	1099/-
L2	208cm X 3mm X 15mm	1999/-
L3	208cm X 4.8mm X 25mm	2599/-
L4	208cm X 4.8mm X 45mm	3799/-

\* per pc



## MINI LATEX LOOPS THICK



- Latex construction
- Ideal for conditioning, stretching & rehabilitation
- Increases resistance
- Enhances speed and agility
- Circumference: 60cm(24") apx.
- Thickness: 4.5mm apx.

Code	Dimensions apx.	MRP
ML1	60cm X 4.5mm X 12.7mm	249/-
ML2	60cm X 4.5mm X 21mm	399/-
ML3	60cm X 4.5mm X 28.6mm	499/-
ML4	60cm X 4.5mm X 31mm	549/-

\* per pc



Minimalist Training equipment. Easy to travel with. Train anywhere, anytime. Ideal for body weight workout. Add it to your stretching, toning, strength & rehab workouts.



## MLX MINI LATEX LOOPS THIN



- Latex construction
- Odor free
- Lightweight & durable
- 4 resistance levels
- Circumference: 60cm(23.5") apx
- Thickness: 5cm apx
- Set of 4 pcs

Code	Color		Dimensions apx.	Weight	MRP
MLX	Red	Extra Heavy	60cm x 5cm x 1.5mm	94 Lbs	599/-
	Blue	Heavy	60cm x 5cm x 1mm	68 Lbs	
	Green	Medium	60cm x 5cm x 0.7mm	37 Lbs	
	Yellow	Light	60cm x 5cm x 0.5mm	33 Lbs	

\* per set



# LATEX LOOPS/BANDS

## LATEX AEROBIC BANDS

Ideal product for muscle toning, conditioning, stretching & rehabilitation. Very easy & convenient to use. Different resistance levels as per customer needs.



- Latex construction
- Ideal for strength training, stretching, mobility, rehabilitation
- Different resistance levels
- Easy to use & carry
- Washable

Code	Color	Dimensions apx.	MRP
TB1	Yellow	120cm x 15cm x 0.35mm	449/-
TB2	Purple	120cm x 15cm x 0.5mm	599/-
TB3	Blue	120cm x 15cm x 0.65mm	699/-

\* per pc

# PERFORMANCE THERAPY

USI Universal's performance therapy products aim to improve your mobility, faster recovery & reduce the chances of injury. Our products come in different sizes & shapes for specific use.

## MASSAGE STICKS

**MB MASSAGE BALL**

- High density plastic construction
- Adjustable angle
- Ideal for light & deep tissue massage

Code	MRP
MB	480/-

\* per pc

**MBS MASSAGE BACK STICK**

- High density plastic construction
- Ideal for back massage

Code	MRP
MBS	499/-

\* per pc



# MASSAGE ROLLER

Rollers help in maintaining healthy fibrous connective tissues in our body. These products help in circulating oxygenated blood which leads to better range of motion, flexibility, reducing pain & accelerating recovery.



## PMR PRO MASSAGE ROLLER

Ideal product for commercial gyms, cross training boxes, personal training studios & performance therapy centers.



- Moulded foam & plastic construction
- Specially designed triple grid 3D massage zones mimics the palm, finger & and thumb like a therapist's hands
- Hardness : medium soft

Code	Size	MRP
PMR	66x14cm (26"x5.5")	2899/-

\* per pc

## MR MASSAGE ROLLER

Ideal for personal use , travel friendly. Finger tip design.



- Moulded foam & plastic construction
- Finger tip design for deep massage
- Comes with a carry bag
- Hardness: firm

Code	Size	MRP
MR	43x14cm(17"x5.5")	1399/-

\* per pc



## EMR EMERGE MASSAGE ROLLER

Ideal for personal use, compact size, travel friendly & lightweight. Soft hand massage effect.



- Moulded foam & plastic construction
- Specially designed triple grid 3d massage zones mimics the palm, finger & and thumb like a therapist's hands
- Roll through the tight muscles
- Lightweight & travel friendly
- Comes with a carry bag
- Hardness : soft

Code	Color	Diameters	MRP
EMR	Blue/Orange	32.25cm x 13.25cm (12.75" x 5.25")	1249/-

\* per pc



# MASSAGE ROLLERS



### MRM MINI MASSAGE ROLLER

**TECH-SPEC.**

- Moulded foam & plastic construction
- Mini size for travel

Code	Size	MRP
MRM	9x14cm (3.5"x5.5")	599/-

\* per pc



### MRB MASSAGE ROLLER

Super lightweight & hard finish , travel friendly.

**TECH-SPEC.**

- High density EPP foam
- Black/orange dots
- Textured surface
- Hollow from centre

Code	Dimensions	MRP
MRB	33cm X 14cm (13"x5.5")	949/-

\* per pc

# MASSAGE BALLS

Ideal product for use on specific body parts. Small size , easy to carry.

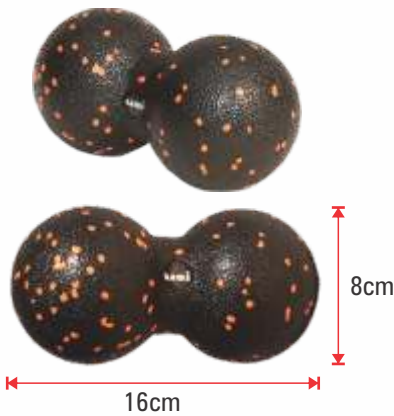

### MDB MASSAGE DUAL BALL

**TECH-SPEC.**

- High density EPP foam
- Black/orange dots
- Textured surface

Code	Dimensions	MRP
MDB	16cm X 8cm (6.3"x3")	449/-

\* per pc



### MB1 MASSAGE BALL

**TECH-SPEC.**

- High density EPP foam
- Black/orange dots
- Textured surface

Code	Diameter apx	MRP
MB1	8.25cm/3.25"	349/-

\* per pc



## FLOORINGS (MULTIPURPOSE)

**The Evolution:** As we test the limits of our body by constantly evolving in our sport, we expose ourselves to the inherent risks in going to the threshold. Our constant efforts to improve the safety standards in combat sports & fitness led to the development of our commercial and home flooring range. Flooring takes the most constant beating every day, protecting the equipment and the users who feel secure in using our tried and tested products.

From yoga mats to interlocking mats for taekwondo, karate, judo, brazilian jiu-jitsu, kravmaga, police training, kids activity areas, rubber floor solutions for the weight rooms, functional training zones & cross training boxes. Our mats range is used for multiple purposes where safety cushion is required in order to prevent injuries.

Our floorings also add aesthetically to the whole ambience, giving greater value for money.

### EM12C EVA FLOOR MAT

Light weight floor padding, which is easy to move around. Keep it around your bench areas & cardio zone. For those short outdoor training sessions on the terrace or home gym.



- 12mm light weight EVA foam construction
- Embossed & textured surface for grip
- Seamless interlocking
- Ideal for home use or light commercial use
- Waterproof
- Assembled 4 pieces

Code	Thickness	Color	Dimensions apx	MRP
EM12C	12mm	Black	1.2m x 1.2m 4' x 4' (16 sq/ft)	1249/-

\* per set

Set of  
4 Pieces



60cm x 60cm

USI Universal's Interlock EVA weight room mat is great for a workout spot, be it at the gym or home gym. It is perfect for lightweight and body weight exercises with plenty of cushion for your joints.

### EM15 INTERLOCK EVA WEIGHT ROOM MAT



- 15mm high density EVA foam construction
- Non-skid textured surface
- Waterproof
- Easy assemble/disassemble
- Great insulator and works well in winters
- Assembled 4 pcs

Code	Thickness	Color	Dimensions apx	MRP
EM15	15mm	Black	1m x 1m 3.28' x 3.28' (10.76 sq/ft)	1699/-

\* per set

Set of  
4 Pieces

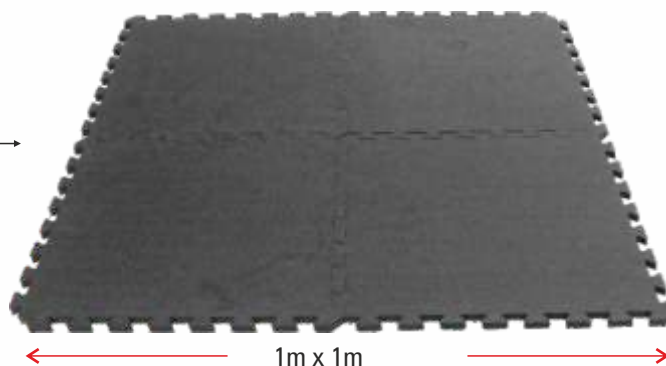

1m x 1m

## FLOORING WOOD GRAIN

A perfect combination of performance & looks. Give your room/hall a high end look with a soft feel. Ideal for kids play, yoga, meditation room, etc.

### W20 WOOD GRAIN INTERLOCK EVA FOAM MAT



- 20mm high density EVA foam construction
- Non-skid textured surface
- Waterproof
- Easy assemble/disassemble
- Great insulator and works well in winters

Code	Thickness	Color	Dimensions apx	MRP
W20	20mm	Wood	1m x 1m 3.28' x 3.28' (10.76 sq/ft)	2099/-

\* per pc



Thickness  
20mm

1m x 1m

Tile consumption also depends on obstructions like pillars, cuts & curves. Always order 3%-5% more than your requirement.

**How many you need ?**  
Example:  
Mat size = 10.76 sq. ft apx.  
If area = 1000 sq. ft. apx.  
Mats required = 95 to 100 apx.

## FLOORINGS (MULTIPURPOSE)

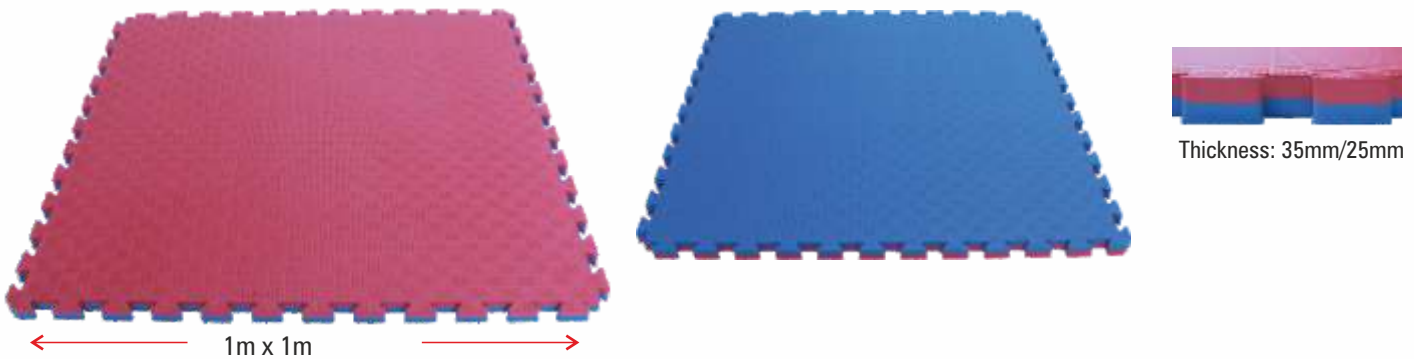

### INTERLOCK EVA FOAM / KABADDI MAT

Ideal for various martial arts like Taekwondo, Karate, Judo, MMA, Brazilian Ji Jitsu etc. Suitable for kids play zones. Also used for krav maga and police training. Interlocking EVA foam mat by USI Universal is a perfect flooring option for fitness enthusiasts. Waterproof and insulating, the interlocking foam tiles will make any area comfortable for a good workout.

**How many you need ?**  
 Example:  
 Mat size = 10.76 sq. ft. apx.  
 If area = 1000 sq. ft. apx.  
 Mats required = 95 to 100 apx.

**TECH-SPEC.**

- High-density thick EVA foam construction
- Non-skid textured surface is water-resistant
- Ideal for yoga and aerobics
- Excellent support and cushion while work out hard at the gym
- Dense & durable tiles protect floors from the wear and tear with the use of heavy gym equipment
- Lightweight, pieces quickly connect and easy to assemble/disassemble
- Reversible Red/Blue
- Hardness: 30-35 shore A

Tile consumption also depends on obstructions like pillars, cuts & curves. Always order 3%-5% more than your requirement.

Code	Thickness	Color	Dimensions apx	MRP
EM25T	25mm	Red/Blue	1m x 1m	1999/-
EM35T	35mm		3.28' x 3.28' (10.76 sq/ft)	2799/-

\* per pc

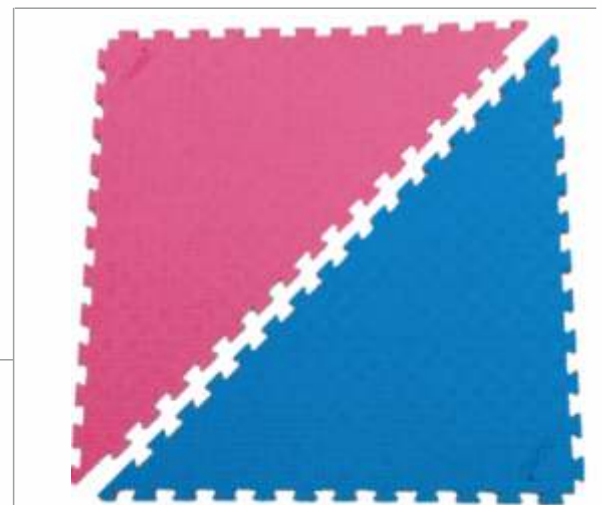

### T25 TRIANGLE INTERLOCK EVA FOAM MAT

**TECH-SPEC.**

- Ideal for Taekwondo arena (octagon)

Code	Thickness	Color	Dimensions	MRP
T25	25mm	Red/Blue	1m x 1m	1799/-

\* per pc

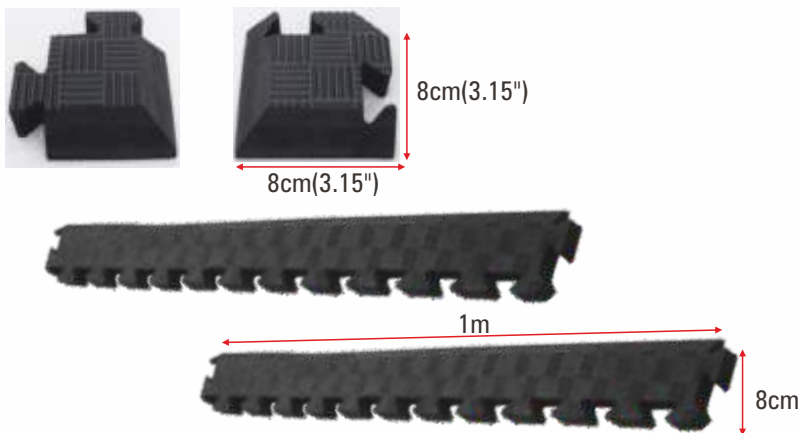

### CORNER / SLANT EDGE FOR INTERLOCK EVA FOAM MAT

A 25mm or 35mm floor can cause an abrupt change to floor level. It can lead to stumbling. USI Universal's slant & corner edge protects you from falling by making a taper on the edge. It also makes the floored area very presentable.

**TECH-SPEC.**

Code	Thickness	Item	MRP
C25	25mm	Corner	249/-
C35	35mm	Corner	299/-
SE25	25mm	Slant Edge	999/-
SE35	35mm	Slant Edge	1199/-

\* per pc



## FLOORINGS (WEIGHT ROOM)

### WR15 WOOD RUBBER TILE 15MM

For those who want to add a chic look to their gym/studio. Wood chips mixed with rubber add to the beauty of your workout zone.



- Crum rubber and wood chips PU bonded
- Protects user, equipment & floor
- Dampens impact & reduces noise
- Anti fatigue cushion

Code	Thickness	Color	Dimensions apx	MRP
WR15	15mm	Black/Wood	50.8 x 50.8cm 20"x20" (2.77sq/ft)	665/- 242/-sq ft

\* per pc



### LWT15Y 15MM LAMINATED SUPER TUFF RUBBER TILE

USI Universal's laminated tiles offer a smooth top surface. This surface is very easy to clean & looks new even after a long time. The coloured chips on top surface enhance the ambience of your workout space.



- EPDM & crum rubber construction
- EPDM top layer for smoothness
- Protects user, equipment & floor
- Dampens impact & reduces noise
- Anti fatigue cushion

Code	Thickness	Color	Dimensions apx	MRP
LWT15Y	15mm	Black/Yellow	50.8X50.8cm 20"x20" (2.77sq/ft)	999/- 360/-sq ft

\* per pc

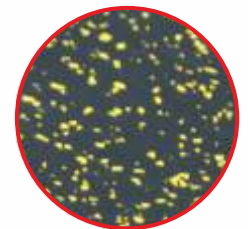
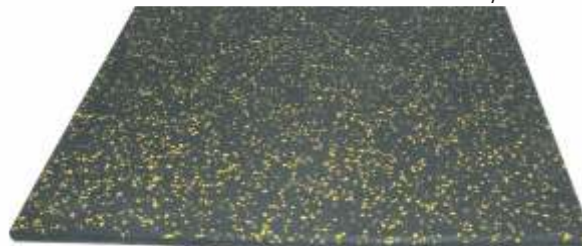

**How many you need ?**  
Example:  
Tile Size = 2.77 sq. ft. apx.  
If area = 1000 sq. ft. apx.  
Tiles required = 360-370 apx.

Tile consumption also depends on obstructions like pillars, cuts & curves. Always order 3%-5% more than your requirement.

## GYM RUBBER ROLL FLOORING

USI Universal's has introduced this flooring in roll form to give a seamless solution to it's customers. Different elastomers have been combined to provide enhanced flexibility, wear resistance & impact absorption. A very smooth top surface is easy to clean & maintain. Coloured chips on the top surface add to the beauty of your workout space.

### RR4W 4MM GYM RUBBER ROLL FLOORING

#### Black/White EPDM

Ideal for cardio zone, kids play area, light activity zones, etc.



- EPDM rubber construction
- Small chips inserts
- Seamless flooring

Code	Thickness	Color	Dimensions apx	MRP
RR4W	4mm	Black/White	1m X 10m 3.28'x32.8' (107.6sq/ft)	21528/- 2153/-sq.m 200/-sq.ft

2153/- Sqr. Meter \* per roll

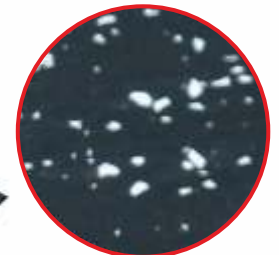

**How many you need ?**  
Example:  
Area per running meter = 10.76 sq. ft. apx.  
If area = 1000 sq. ft. apx.  
01 Roll = 107.6 sq. ft. apx.  
Rolls required = 9.5-10 rolls

### RR8Y 8MM GYM RUBBER ROLL FLOORING

#### Black/Yellow EPDM

Ideal for weight rooms, kids play area, activity zones, etc.



- EPDM rubber construction
- Small chips inserts
- Seamless flooring

Code	Thickness	Color	Dimensions apx	MRP
RR8Y	8mm	Black/Yellow	1m X 10m 3.28'x32.8' (107.6sq/ft)	38750/- 3875/-sq.m 360/-sq.ft

3875/- Sqr. Meter \* per roll

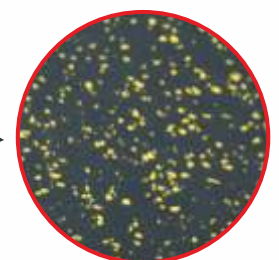

Roll consumption also depends on obstructions like pillars, cuts & curves. Always order 3%-5% more than your requirement.

## FLOORINGS (WEIGHT ROOM)

USI Universal's always pays special attention to the convenience of our customers. Interlock rubber tiles have been introduced to avoid the hassle of professional fixing of tiles, this can be expensive & time consuming. Instead you can lay down the interlock tiles yourself. It is easy to shift/replace anytime. Also, it does not damage the sub floor.

### IRF FLEXOTUF INTERLOCKING RUBBER TILE

- TECH-SPEC.**   
- Crum rubber PU bonded
  - Protects user, equipment & floor
  - Dampens impact & reduces noise
  - Anti fatigue cushion
  - Interlock design for easy installation



Code	Thickness	Color	Dimensions apx	MRP
IRF	10mm	Black	50.8 x 50.8cm 20"x20" (2.77sq/ft)	580/- 210/-sq. ft.





\* per pc

 **How many you need ?**  
 Example:  
 Tile Size = 2.77 sq. ft. apx.  
 If area = 1000 sq. ft. apx.  
 Tiles required = 360-370 apx.

Tile consumption also depends on obstructions like pillars, cuts & curves. Always order 3%-5% more than your requirement.

### WT10,WT20 SUPERTUF RUBBER TILE

Ideal for free weight areas, heavy lifting zones & cross training boxes/ gyms.

- TECH-SPEC.**    
- Crum rubber PU bonded
  - Protects user, equipment & floor
  - Dampens impact & reduces noise
  - Anti fatigue cushion
  - Dimensions: 50.8 cm x 50.8 cm (20" x 20") apx.

Code	Thickness	Color	Dimensions apx	MRP
WT10	10mm	Black	50.8 x 50.8cm	420/- apx
		Blue	20"x20"	152/sq.ft
WT20	20mm	Terracotta	50.8 x 50.8cm	860/- apx
		Grey	(2.77sq/ft)	310/sq.ft

\* per pc



50.8x50.8cm (20"x20")

Apx. Wt.  
 10mm Tile = 2.5 kg apx.  
 20mm Tile = 5 kg. apx.

Available Thickness

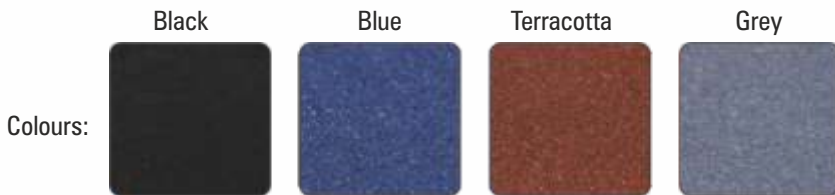
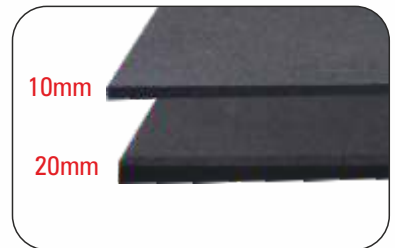

 **How many you need ?**  
 Example:  
 Tile Size = 2.77 sq. ft. apx.  
 If area = 1000 sq. ft. apx.  
 Tiles required = 360-370 apx.

Tile consumption also depends on obstructions like pillars, cuts & curves. Always order 3%-5% more than your requirement.

# FLOORINGS

## CMT COMBAT MAT (JUDO)

The ultimate mat for any type of contact sports training like Judo, Wrestling & MMA. Ideal for Dojos & studio environment.



Thickness 55mm

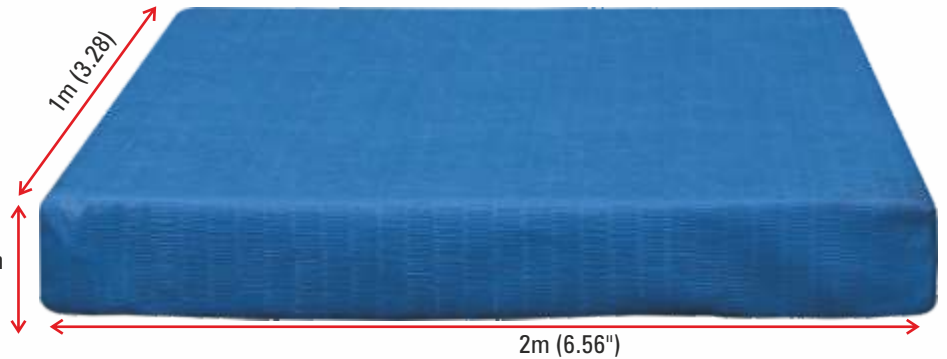

**TECH-SPEC.** 

- Strong vinyl coated fabric
- Slip resistant tatami texture
- Easy wipe cleaning possible
- Anti slip base layer
- Weight 17-18 Kg apx.
- Foam Density: 180 Kg/cbm

Code	Thickness	Color	Dimensions apx	MRP
CMT	55mm	Sky Blue Red Yellow	2m x 1m 6.56'x3.28' 21.5 sq.ft	11999/-

\* per pc

Available Colours:



**How many you need ?**  
 Example:  
 Mat size = 21.5 sq. ft apx.  
 If area = 1000 sq. ft. apx.  
 Mats required = 45 to 50 apx.

Tile consumption also depends on obstructions like pillars, cuts & curves. Always order 3%-5% more than your requirement.

## CUSTOM MADE

We can produce custom sizes to fit particular training areas. Kindly send location picture/drawing & measurements for a quote. Please allow us at least 3 weeks production time.

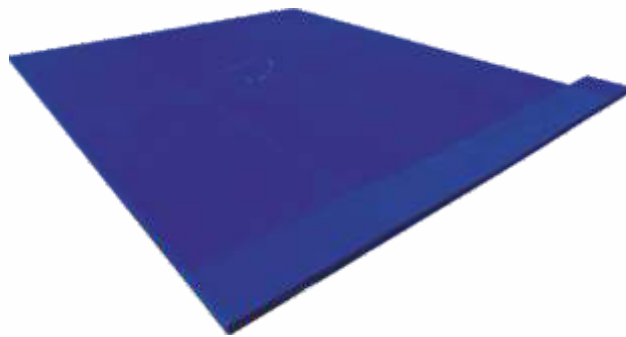

**MAT AREA: 14m X 14m**  
**MATS YELLOW : 32 pcs**  
**MATS RED : 66 pcs**  
**MATS TOTAL : 98 pcs**

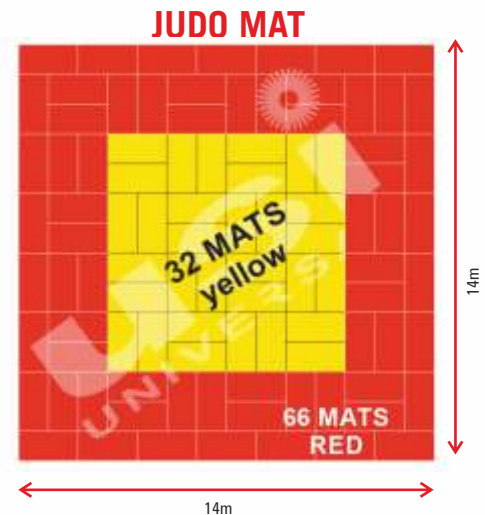

## 790GM GYM MAT

Most economical gym mats. These gym mats can be joined together to form an arena or an area for various sports activities.

**TECH-SPEC.**  **SALT uFEELgrip**

- Vinyl construction
- Dense light weight padding
- Hook & loop on sides for joining
- Lightweight padding 50mm
- Weight 3 Kg apx

Code	Thickness	Color	Dimensions apx	MRP
790GM	50mm	Blue	180x 90x5cm 6'x3'x2" 18 sq.ft	3999/-

\* per pc



**How many you need ?**  
 Example:  
 Mat size = 18 sq. ft apx.  
 If area = 1000 sq. ft. apx.  
 Mats required = 55 to 60 apx.

Tile consumption also depends on obstructions like pillars, cuts & curves. Always order 3%-5% more than your requirement.

## FLOORINGS

### CM CRASH MATS

Ideal for throw practice in Wrestling, Judo, MMA can be placed under climbing rope to provide limited protection.

**TECH-SPEC.** 

- Strong nylon coated material
- Mesh at bottom for air ventilation on impact
- Soft foam for impact absorption



Code	Dimensions apx	MRP
CM	1.83m x 1.22m x 0.46m (6'x4'x 18")	24999/-
CM10	3m x 2m x 10cm (10'x6.5'x 4")	18499/-
CM20	3m x 2m x 20cm (10'x6.5'x 8")	28999/-
CM30	3m x 2m x 30cm (10'x6.5'x 12")	37999/-



\* per pc



### 7019 TRI FOLD MAT

Serious space management & ease of travel. Firm padding for various activities like martial arts, kids zones etc. Ease of storage and handling.

**TECH-SPEC.**  **SALT uFEELgrip**

- Laminated vinyl construction
- Foldable with carry handles
- uFEELgrip lining (Water proof)
- Lightweight padding 50mm
- Weight: 3 Kg apx

Code	Color	Dimensions apx	MRP
7019	Blue	180cm x 90cm x 50mm (6' x 3' x 2")	4299/-

\* per pc



### EXM EXERCISE MAT

**TECH-SPEC.**  **SALT**

- Laminated vinyl construction
- Dual layer 25mm padding



Code	Color	Dimensions apx	MRP
EXM	Blue	180cm x 75cm x 28mm (6' x 2.5' x 1")	3249/-

\* per pc





# TRAVEL BAGS



### 562DK DUFFLE BAG

TECH-SPEC. 

- Thick matty construction
  - Reinforced stitching
  - 2 side pockets
  - Strong webbing straps with shoulder pad
- \*Colors as per availability

Code	Dim. apx	MRP.
562DK	46 x 23 x 23cm (18"x9"x9")	530/-

\* per pc



### 562T TRAVEL BAG

TECH-SPEC. 

- PU matty lightweight
- Reinforced stitching
- Nylon construction
- 2 end pockets
- 3 side pockets (1 big, 2 small)
- Inbuilt wet pocket/Shoe pocket
- Printed logos

\*Colors as per availability

Code	Dim. apx	MRP.
562T	60 x 28 x 25cm (24" x 11" x 10")	1699/-

\* per pc

### 562BP BACK PACK

TECH-SPEC. 

- Matty Construction
- Side mesh pockets
- Front Cover for wet/shoe storage
- Front zip pocket
- Soft back lining

Code	Dim. apx	MRP.
562BP	48 x 33 x 16.5 cm (19" x 13" x 6.5")	1149/-

\* per pc



### 562W WHEEL BAG

TECH-SPEC. 

- Strong matty construction
- Reinforced stitching
- Strong webbing straps
- Cushioned sides with zip pouch pocket
- 1 inner zip pockets
- 1 outer pocket
- Smooth wheels with handle & trolley

\*Colors as per availability

Code	Dim. apx	MRP.
562W	75 x 33 x 33cm (29.5"x13"x13")	3199/-

\* per pc



### 562SB SLING BACK PACK

TECH-SPEC. 

- PU matty lightweight
- Cross body strap with zip pouch
- Soft lining
- Front zip pocket & mesh pocket

Code	Dim. apx	MRP.
562SB	48 x 33 x 15 cm (19" x 13" x 6")	999/-

\* per pc

# TRAVEL BAGS



### 562UB UNBEATABLE BACKPACK

- TECH-SPEC.**  **TF** THERMOFOAM
- Water-resistant finish
  - Foam reinforced panels add protection
  - Soft lined laptop sleeve-holds up to 38cm/15" laptop
  - Water-repellent front valuables pockets
  - Adjustable thermoformed shoulder straps for extra comfort
  - Ergonomic foam padded back panel
  - Extra large main compartment with easy top loader access
  - 2 side-zip water bottle pockets
  - Fits a boxing glove/boxing boots/wet clothers
  - D-ring for additional attachment point
  - Cubic volume: 1370 apx.
  - Polyester

Code	Colors	Dim. apx	MRP.
562UB	Cyan/Blue	48x30x15cm	2149/-
562UBG	Green/Black	(19"x12"x6")	

\* per pc



### 562BK ELITE BACK PACK

- TECH-SPEC.** 
- PU Matty light weight
  - Air mesh back for comfort
  - Laptop & small valuables
  - Bottle pouch & mobile zip pocket
  - Adjustable straps for side support
  - Cushioned top handle & back straps
- \*Colors as per availability.

Code	Dimensions	MRP.
562BK	L:43x B:35 X H:15cm 17"x14"x6"	899/-

\* per pc



### 562SH SHOE BAG ONE SIZE

- TECH-SPEC.** 
- Matty & mesh construction
  - The mesh allows ventilation which helps to dry up sweaty shoes
  - Can hold 1 pair shoes+1 pair slippers

Code	Dimensions	MRP.
562SH	L:35x B:20 X H:15cm 14"x8"x6"	270/-

\* per pc



### 562AW PRO WHEEL BAG

- TECH-SPEC.** 
- Thick Matty construction
  - 04 compartments
  - Heavy duty wheels
  - 03 Handle styles
  - Compact size

Code	Dimensions	MRP.
562AW	L:60x B:28 X H:33cm 24"x11"x13"	1749/-

\* per pc

# SAUNA SUITS



### 415S SAUNA SUIT

TECH-SPEC. 

- Heavy polyester coated material
- Heavy material for heat trapping
- Elasticated openings
- Hook & loop fastening at cuff
- Zipped ankles

Code	Size	MRP.
415S	S-XL	2249/-

For XL+ :150/Size Extra \* per set



### 415SZ ZIP SAUNA SUIT

TECH-SPEC. 

- Polyester coated material
- Mesh lined
- Elasticated arms
- Zipped top

Code	Size	MRP.
415SZ	S-XL	3249/-

For XL+ :150/Size Extra \* per set

### 415FBT SAUNA SUIT

TECH-SPEC.

- Polyester coated material
- Mesh lined
- Elasticated arms
- Zipped top

Code	Size	MRP.
415FBT	S-XL	3499/-

For XL+ :150/Size Extra \* per set

# APPAREL



### 409PB PRO BOXING SHORTS

TECH-SPEC. **CUSTOM MADE**

- Heavy poly satin fabric
  - Classic loose cut
  - Colors as per availability
- \*Custom designs, colors & logos possible at extra cost

Code	Size	MRP.
409PB	S-XL	999/-

\* per pc



### STP SLEEVELESS TSHIRT POLY

TECH-SPEC. **uFEELair**

- Wick dry poly fabric
- Mesh panels for ventilation

Code	Size	MRP.
STP	S-XL	399/-

\* per pc



### STC SLEEVELESS TSHIRT

TECH-SPEC.

- Cotton shinker fabric

Code	Size	MRP.
STC	S-XL	580/-

\* per pc



### PT PERFORMANCE T-SHIRT

TECH-SPEC. **uFEELair**

- Wick dry poly fabric
- Mesh panel
- Flat lock stitching

Code	Size	MRP.
PT	S-XL	549/-

\* per pc



### PMT PERFORMANCE T-SHIRT

TECH-SPEC. **uFEELair**

- Poly performance fabric
- Available in many colors/designs

Code	Size	MRP.
PMT	S-XL	499/-

\* per pc



### 415SJ-SHOOTING JACKET (SKEET TRAP VEST)

TECH-SPEC. **uFEELair**

- Micro fibre polyester
- Padded leather panel
- Big pockets in front
- Rear empty cartridge zipped pocket

Code	Size	MRP.
415SJ	S-XXL	3500/-

\* per pc



### PV PERFORMANCE VEST

TECH-SPEC. **uFEELair**

- Wick dry poly fabric
- Mesh panels for ventilation

Code	Size	MRP.
PV	S-XL	350/-

\* per pc

APPAREL

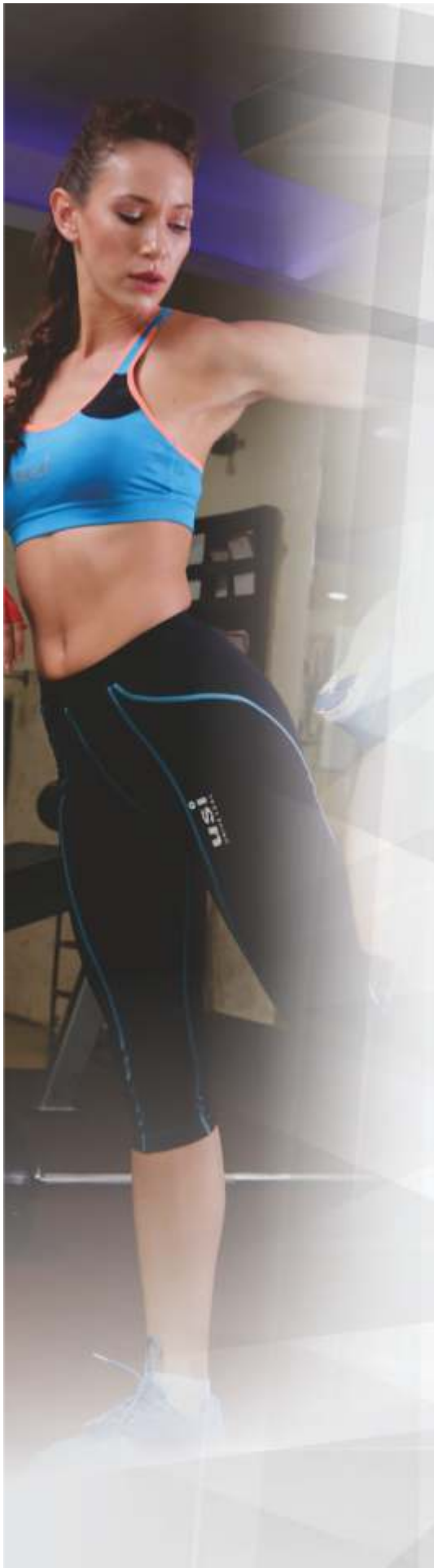

**CXC COMPRESSION CAPRI LADIES**

TECH-SPEC. MPREX

- Nylon elastane
- Anatomically shaped
- Flat seamed

Code	Size	MRP.
CXC	XS-XXL	1099/-

\* per pc



**CXP COMPRESSION PANT**

TECH-SPEC. MPREX

- Nylon elastane
- Anatomically shaped
- Flat seamed

Code	Size	MRP.
CXP	S-XL	1349/-

\* per pc



**CXS COMPRESSION LADIES SHORTS**

TECH-SPEC. MPREX

- Nylon elastane
- Flat seamed

Code	Size	MRP.
CXS	XS-L	799/-

\* per pc



**G1069 WORKOUT PANT**

TECH-SPEC.

- Nylon elastane
- Micro fibre polyester

Code	Color	Size	MRP.
G1069	Black/Grey	S-XL	1449/-

\* per pc



**WOS WORKOUT SHORTS**

TECH-SPEC.

- Micro fibre polyester mesh vent

Code	Color	Size	MRP.
WOS	Black,Blue, White,Brown	S-XL	649/-

\* per pc



**G1070 TRAINING SHORTS**

TECH-SPEC.

- Interlock fabric

Code	Color	Size	MRP.
G1070	Grey	S-XL	749/-

\* per pc

# APPAREL



### 409PTN BODY BUILDING POSING TRUNK

**TECH-SPEC.**

- Nylon elastane
- European cut
- Double lined front pocket
- Colour : Black, Red, Blue

Code	Color	Size	MRP.
409PTNBLK	Black	S/M, L/XL	349/-
409PTNR	Red		
409PTNB	Blue		

\* per pc

### BIB TEAM MESH BIBS

**TECH-SPEC.**

- Breathable mesh construction
- Ideal for team work in cross fitness + boot camp training

Code	Color	Size	MRP.
BIBG	Green	S/M, L/XL	249/-
BIBO	Orange		

\* per pc

### BOUNCER PADDED BIKE SHORTS

**TECH-SPEC. uFEELgrip**

- Polyester elastane construction 200 GSM apx.
- Cushioned saddle area for comfort
- Soft elastic waist
- Grip elastic on leg opening to prevent rolling of fabric

Code	Sex	Colors	Size	MRP.	XXL
GBSO	Men	Fluro Orange	S-XXL	699/-	749/-
GBSY	Men	Fluro Yellow	S-XXL	699/-	749/-
GBSW	Women	Black	S-XL	699/-	X

\* per pc



### 416DC DEEP CUT TANK

**TECH-SPEC.**

- Cotton shinker construction
- Very deep armhole & racer back design
- Embroidered & printed logos
- Rough edge styling

Code	Color	Size	MRP.
416DCG	Green	S-XL	599/-
416DCB	Blue		
416DCBLK	Black		
416DCR	Red		
416DCC	Camo		
416DCBC	Blue/Camo		

\* per pc



# APPAREL MENS PHYSIQUE BOARD SHORTS

This product is a result of USI Universal's efforts to offer professional clothing for fitness competitions. Unlike any baggy beach wear surf / board shorts, USI Universal's shorts have a tailored fit for aesthetic athletes who have a thin waistline and muscular thighs. We have used a lightweight stretch fabric which gives a snug & comfortable fit. USI Universal's selection of vibrant colours and cuts will always keep you in fashion. Overall, a great piece of apparel to further boost your confidence on stage.

## 411PS SUBLIMATED PHYSIQUE BOARD SHORTS

**TECH-SPEC.**  **uFEELstretch**

- Polyester elastane construction 125 GSM apx
- Tailored fit for thin waist and muscular thighs
- Hook & loop fly with drawstring closure
- Binding at bottom hole and sides
- Back pocket with lid

Code	Color	Size	MRP.
411PSB	Blue	S,M,L	999/-
411PSP	Pink		
411PSO	Orange		
411PSG	Green		
411PSBK	Black		

\* per pc



## 411PC CAMO PHYSIQUE BOARD SHORTS

**TECH-SPEC.**  **uFEELstretch**

- Polyester elastane construction 125 GSM apx
- Tailored fit for thin waist and muscular thighs
- Hook & loop fly with drawstring closure
- Binding at bottom hole and sides
- Sublimated side panels
- Embroidered & printed logos

Code	Color	Size	MRP.
411PCB	Black	S,M,L	899/-
411PCR	Red		

\* per pc



## 411PD DIAGONAL PHYSIQUE BOARD SHORTS

**TECH-SPEC.**  **uFEELstretch**

- Polyester elastane construction 125 GSM apx
- Tailored fit for thin waist and muscular thighs
- Hook & loop fly with drawstring closure
- Binding at bottom hole and sides
- Diagonal insert panels stitched

Code	Color	Size	MRP.
411PDB	Black	S,M,L	799/-
411PDR	Red		
411PDT	Teal		
411PDN	Navy		

\* per pc



## 411PS STANDARD PHYSIQUE BOARD SHORTS

**TECH-SPEC.**  **uFEELstretch**

- Polyester elastane construction 125 GSM apx
- Tailored fit for thin waist and muscular thighs
- Hook & loop fly with drawstring closure
- Binding at bottom hole and sides
- Sublimation printed

Code	Color	Size	MRP.
411PSBK	Black	S,M,L	699/-
411PSR	Red		
411PSM	Automint		

\* per pc



# APPAREL MENS PHYSIQUE BOARD SHORTS

## 411PFB FIRE PHYSIQUE BOARD SHORTS

TECH-SPEC.

- 
- 
- 
- 
- 

Code	Color	Size	MRP.
411PFB	Black	S,M,L	1099/-

\* per pc



## 411PM MARBLE PHYSIQUE BOARD SHORTS

TECH-SPEC.

- 
- 
- 
- 
- 

Code	Color	Size	MRP.
411PMG	Green	S,M,L	1049/-
411PMB	Blue		

\* per pc



## 411PA ALOHA PHYSIQUE BOARD SHORTS

TECH-SPEC.

- 
- 
- 
- 
- 

Code	Color	Size	MRP.
411PAW	White/Red/Blue	S,M,L	1099/-
411PAG	Gold/Black		
411PAN	Navy/Black/Pink		
411PAR	Red/Black		

\* per pc





# APPAREL MENS PHYSIQUE BOARD SHORTS

## 411PL LEGEND PHYSIQUE BOARD SHORTS

TECH-SPEC.

- 
- 
- 
- 
- 

Code	Color	Size	MRP.
411PLB	Black	S,M,L	999/-
411PLW	White		

\* per pc



## 411PT TRIANGLE PHYSIQUE BOARD SHORTS

TECH-SPEC.

- 
- 
- 
- 
- 

Code	Color	Size	MRP.
411PTM	Mint	S,M,L	1099/-
411PTR	Red		
411PTY	Yellow		
411PTB	Blue		

\* per pc



## 411CH CLASSIC HIPSTER

TECH-SPEC.

- 
- 
- 
- 
- 

Code	Color	Size	MRP.
411CH	Black	S/M, L/XL	999/-

\* per pc



## KIDS

Kids are always looking for fun physical activity to put their excessive energy in positive use. USI Universal's boxing sets & kids training products are great for kids between 3 & 13 years old. Our products are beautifully packed which make them presentable as birthday/return gifts.



### 9004 HIT SHIELD



TECH-SPEC.

- Laminated vinyl construction
- Soft padding
- Suitable for age 9+ yrs

Code	Size	MRP
9004	45x38x15cm 17.7"x15"x5.9"	1299/-

\* per pc



### 9005 MINI SHIELD



TECH-SPEC.

- Laminated vinyl construction
- Soft padding
- Suitable for age 9+ yrs

Code	Size apx	MRP
9005	27x23x8cm 10.6"x9"x3"	599/-

\* per pc



### 9007 ROUND FOCUS PADS



TECH-SPEC.

- Vinyl construction
- Soft padding
- Suitable for 3+ age

Code	Dimensions apx	MRP
9007	Diameter: 26cm/10.25" Thickness: 9cm/3.5"	1099/-

\* per pair



### 9012 TARGET BAG

TECH-SPEC.

- Laminated vinyl construction
- Human shaped
- Vinyl boxing gloves 6oz
- Suitable for 9+ age

Code	MRP
9012	1399/-

\* per set

## KIDS

### 705 BOX N' PUNCH STAND

**TECH-SPEC.**

- Metal, plastic & PVC Construction
- Adjustable height 75cm/30" - 127cm/50"
- Inflatable punch ball supplied with inflating pump
- Suitable for 6-8 years

Code	MRP
705	2499/-

\* per set



### 613 DISPLAY BOXING GLOVES

**TECH-SPEC.**

- Durable PVC construction
- Size equivalent to a kid 3 years old (Shown in comparison to normal 8 oz. glove)

Code	MRP
613	1370/-

\* per pair



### KBP BLOCKER

**TECH-SPEC.**

- Vinyl shell
  - Super soft form on plastic baton
  - Ideal for training blows & kicks
- \*Suitable for age 9+ yrs

Code	MRP
KBP	799/-

\* per pc



# KIDS

## 720 JUNIOR BOX N' PUNCH SET

**TECH-SPEC.**

- PVC construction
- 53cm/21" x 21cm/8.35" punch bag
- Punch bag, punching gloves
- Punching pads, speed ball
- Skipping rope, inflating pump
- Hanging attachment
- Suitable for 7-10 years

Code	MRP
720	2249/-

\* per set



## 710 YOUTH'S FITNESS KIT

**TECH-SPEC.**

- 56cm/22" X 25cm/10" punch bag tetron with long straps
- Boxing gloves PVC 6 oz
- Ceiling hook with screws
- Skip rope PVC
- Suitable for 8-12 years

Code	MRP
710	1899/-

\* per set



## 711BDL GIRLS FITNESS KIT

**TECH-SPEC.**

- PU/PVC/metal construction.
- Punch bag 75cm apx (30"), bag gloves, focus pads, hand wraps, skip rope, hooks for mounting, wall plugs, small wall bracket, towel & screws
- Suitable for 8+ age

Code	MRP
711BDL	3399/-

\* per set



## 711BDA BOXING KIT

**TECH-SPEC.**

- Leather/nylon/PU/PVC/metal construction.
- Punch bag 90cm apx (36"), bag gloves, focus pads, hand wraps, skip rope, hooks for mounting, wall plugs, wall bracket & screws.
- Suitable for 10+ age

Code	MRP
711BDA	4999/-

\* per set

## KIDS



### 1000B KID'S PUNCH BAG SET

**TECH-SPEC.**

- PVC construction
- 38cm/15" X 15cm/6" light punch bag
- Small boxing gloves & head guard
- Retail box pack
- Suitable for 5+ age

Code	MRP
1000B	1199/-

\* per set



### 1001 MINI PUNCH SET

**TECH-SPEC.**

- Vinyl construction
- 45.7cm apx (18") kit bag
- Small punching gloves
- Retail box pack
- Suitable for 5+ age

Code	MRP
1001	949/-

\* per set



### 710GP GLOVES & PAD SET

**TECH-SPEC.**

- Vinyl construction
- Sold in PVC/mesh retail bag
- Suitable for 5+ age

Code	MRP
710GP	1099/-

\* per set



# SOUVENIR/CORPORATE GIFTS

USI Universal offers its products as miniatures which are very popular as souvenirs. Ideal impulsive sale product for cash counters.



## KEY RINGS

### TECH-SPEC.

- Key ring attachment
- Assorted colors as per availability

Code	Key Ring	Construction	MRP
613MMA	Mma	Vinyl	
613PVCK	Boxing	Vinyl	50/-
613B	Belt	Leather	

\* per pc

## CUSTOM MADE

### CUSTOM MADE CORPORATE GIFTS

USI Universal's can produce souvenirs with your logo for a certain quantity/generous lead time. This product can help you increase your gym sales, build relationships, improve brand image, generate more leads & enhance customer loyalty.

Please ask your reseller for more details.



## 417 MINI DRESS KEY RINGS

### TECH-SPEC.

- Key ring attachment

Code	Key Ring	Color	MRP
417	Mini Dress	White	99/-

\* per pc



## 613PVC MINIATURE BOXING GLOVES

### TECH-SPEC.

- PVC construction
- For car hanging & souvenirs
- Assorted colors as per availability

Code	Key Ring	Construction	MRP
613PVC	Boxing Glove	Vinyl	80/-

\* per pc

# SOFTBALLS/BASEBALLS



### 780SF1 SOFTBALL LEATHER

**TECH-SPEC.**  Advance

- P.U. & graphite core
- Leather outer
- Smooth seams
- Circumference: 30.5cm (12") apx.
- Weight: 6.25-7 oz apx.(177-198gm)

Code	MRP
780SF1	999/-

\* per pc

### 780SFC SOFTBALL SYNTHETIC

**TECH-SPEC.**  Performance

- P.U. & graphite core
- Synthetic outer
- Smooth seams
- Circumference: 30.5cm (12") apx.
- Weight: 6.25-7 oz apx.(177-198gm)

Code	MRP
780SFC	849/-

\* per pc

### 780C BASEBALL SYNTHETIC

**TECH-SPEC.**  Performance

- Cork and rubber core
- Synthetic outer
- Circumference: 22.9-23.5cm (9-9.25") apx.
- Weight: 5-5.25 oz apx.(142-149gm)

Code	MRP
780C	349/-

\* per pc



### 785 PERFECT PROFESSIONAL

**TECH-SPEC.**

- Top grain hide leather soft finish
- Softball gloves

Code	Size	MRP
785	OSFA	1430/-

\* per pc

### 785U SOFTBALL GLOVES

**TECH-SPEC.**

- Top grain hide leather soft finish
- Softball gloves (\*American style)

Code	Size	MRP
785U	OSFA	2600/-

\* per pc



### 786 UNIVERSAL LEATHER GLOVES

**TECH-SPEC.**

- Split leather medium soft
- Baseball gloves

Code	MRP
786	1110/-

\* per pc

### 785A PERFECT PROFESSIONAL

**TECH-SPEC.**

- Mulberry wooden bleached

Code	MRP
785A	549/-

\* per pc

## CRICKET ACCESSORIES



### 554N COSMOS PADDED INNER GLOVES

TECH-SPEC.

- Superior cotton/mesh construction
- Padded palm
- Ribbed elastic wrist

Code	Size	MRP
554N	Mens	123/-

\* per pair



### 553 COMFERTO INNER GLOVES

TECH-SPEC.

- Superior cotton construction
- Elasticated wrist

Code	Size	MRP
553	Mens	115/-

\* per pair



### 554 CHAMPION INNER GLOVES

TECH-SPEC.

- Lightweight cotton construction
- Elasticated opening

Code	Size	MRP
554	Mens	78/-

\* per pair



### 515I COMFERTO BATTING INNER GLOVES

TECH-SPEC.

- Lightweight cotton construction
- Elasticated opening

Code	Size	MRP
515I	Mens	75/-

\* per pair



### 567F AUTOGRAPH BAT

TECH-SPEC.

- Mango wood construction
- Bleached finish

Code	Size	MRP
567F	30.5cm (12")	110/-
	38cm (15")	120/-
	43cm (17")	135/-

\* per pc



### 800C UMPIRE COUNTER

TECH-SPEC.

- Plastic construction
- 3 dial functions
- Overs, bowled, balls bowled

Code	MRP
800C	230/-

\* per pc



# CRICKET ACCESSORIES



### 558A UNIVERSAL WITH HOLES ABDOMINAL GUARD

TECH-SPEC.

- Plastic construction
- Soft beading with cotton filling
- Holes for ventilation
- Hand sewn

Code	Size	MRP
558A	Boy, Youth, Mens	80/-

\* per pc



### 558 UNIVERSAL ABDOMINAL GUARD

TECH-SPEC.

- Plastic construction
- Soft beading with cotton filling
- Hand sewn

Code	Size	MRP
558	Boy, Youth, Mens	65/-

\* per pc



### 557D DYNAMIC MOULDED ABDOMINAL GUARD

TECH-SPEC.

- Plastic construction
- Soft moulded beading
- Holes for ventilation

Code	MRP
557D	99/-

\* per pc



### 567H TRAINING BALL

TECH-SPEC.

- Leather ball
- 12' PE twisted rope

Code	MRP
567H	370/-

\* per pc

# CRICKET ACCESSORIES



**569B SPRING RETURN STUMPS**

**TECH-SPEC.**

- Mango wood construction
- Bleached finish
- Heavy metal spring & base
- Set of 3 wickets with 2 single bails

Code	MRP
569B	2099/-

\* per set



**569S STUMP STAND**

**TECH-SPEC.**

- Mango wood construction
- Duco painted

Code	MRP
569S	180/-

\* per pc



**567B MALLET**

**TECH-SPEC.**

- Mulberry wood construction
- Lacquered finish
- Ideal for stump fixing

Code	MRP
567B	299/-

\* per pc



**569T TARGET STUMP**

**TECH-SPEC.**

- Mango wood construction
- Bleached finish
- Heavy spring & spike

Code	MRP
569T	699/-

\* per pc



**569AS SINGLE BAILS**

**TECH-SPEC.**

- Mango wood construction
- Bleached finish

Code	MRP
569AS	60/-

\* per pair



**567SG STUMP GAUGE**

**TECH-SPEC.**

- Casted metal construction
- Spray painted

Code	MRP
567SG	299/-

\* per pc



**569 STUMPS**

**TECH-SPEC.**

- Mango wood construction
- Bleached wood construction
- Set of 6 wickets with 4 single bails

Code	MRP	
569	MCC	1399/-
	76cm(30")	1299/-
	66.5cm(27")	799/-
	61cm(24")	699/-

\* per set



**569AD DOUBLE BAIL**

**TECH-SPEC.**

- Mango wood construction
- Bleached finish

Code	MRP
569AD	35/-

\* per pc

## CRICKET ACCESSORIES



### 567T COMBI APPLICATOR

TECH-SPEC.

- Mulberry wood construction
- Lacquered finish
- 3 functions in one
- Bat knocking, stump fixing, grip application

Code	MRP
567T	599/-

\* per pc



### 567S ROUND FLAT MALLET

TECH-SPEC.

- Mulberry wood construction
- Lacquered finish
- Dual purpose for bat knocking & stump fixing

Code	MRP
567S	299/-

\* per pc



### 567J ROUND MALLET

TECH-SPEC.

- Mulberry wood construction
- Lacquered finish
- For rigorous bat knocking

Code	MRP
567J	299/-

\* per pc



### 567C BAT MALLET

TECH-SPEC.

- Leather ball mulberry wood handle
- Lacquered finish
- Ideal for rigorous knocking

Code	MRP
567C	349/-

\* per pc



### 567D GRIP APPLICATOR WITH RING

TECH-SPEC.

- Mulberry wood construction
- Lacquered finish
- Metal ring for long life

Code	MRP
567D	270/-

\* per pc



### 567E GRIP APPLICATOR 'EASY FIX'

TECH-SPEC.

- Mulberry wood construction
- Lacquered finish
- Comfortable to use

Code	MRP
567E	260/-

\* per pc

# SIZE CHARTS

### BOXING GLOVES

CIRCUMFERENCE	SIZE
11.00 - 12.50cm	4oz
12.50 - 14.00cm	6oz
14.00 - 16.50cm	8oz
16.50 - 19.00cm	10oz
19.00 - 21.50cm	12oz
21.50 - 24.00cm	14oz
24.00 - 26.50cm	16oz

Please measure the circumference of your hand below knuckles



- In Amateur competition, 10 oz, 12 oz gloves are used.
- In Professional competition, 08 z, 10 oz gloves are used.
- Heavier gloves are recommended for a better workout.
- Please try on the product for best fit.

### FITNESS GLOVES

CIRCUMFERENCE	UNISEX	WOMEN
15-16.50cm	-	S/M
16.50-18.00cm	-	L/XL
18.00-19.50cm	S	-
19.50-20.00cm	M	-
20.00-21.50cm	L	-
21.50-23.00cm	XL	-

Please measure the circumference of your hand below knuckles



- Gloves are snug fitting. Please buy one size larger for loose fit.
- Please try on the product for best fit

### PUNCH / BAG GLOVES

CIRCUMFERENCE	SIZE
Below 16.50cm	S
16.50-21.50cm	M
21.50cm-24.00cm	L
24.00cm-Above	XL

Please measure the circumference of your hand below knuckles



Please try on the product for best fit

### WEIGHT LIFTING BELT

CIRCUMFERENCE	SIZE
75cm - 97cm (29.5" - 38")	S
88cm - 110cm (35" - 43.5")	M
98cm - 120cm (38.5" - 47")	L
104cm - 125cm (41" - 49.5")	XL
110cm - 128cm (42" - 50.5")	XXL

Do not use your pant size to determine the size of your belt. Circle around the waist to Start/stop on belly button.



Please try on the product for best fit

### POWER LIFTING BELT

CIRCUMFERENCE	SIZE
75cm - 98cm (29.5" - 38.5")	S
84cm - 108cm (33" - 42.5")	M
94cm - 118cm (37" - 46.5")	L
104cm - 128cm (41" - 50.85")	XL
114cm - 138cm (45" - 54.3")	XXL

Do not use your pant size to determine the size of your belt. Circle around the waist to Start/stop on belly button.



- Please try on the product for best fit
- Tolerance of 0.5"/1cm in every measurement

### SHIN/ARM GUARD

LENGTH BELOW KNEE TO ANKLE/ ELBOW TO WRIST	CALF CIRCUMFERENCE	SIZE
25.5-28 cm	25 cm - 33 cm	S S/M
30 cm	33 cm - 38 cm	M
34.5 cm	38 cm - 40.50 cm	L L/XL
38 cm	40.50 cm - 46cm	XL

Please measure the circumference of your calf around the largest part

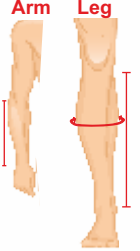

For length measurement: Please measure from below the knee

### ELBOW/KNEE SLEEVES

SIZE	ELBOW	KNEE
XS	21 - 23 cm	28 - 30 cm
S	23 - 25 cm	30 - 33 cm
M	25 - 28 cm	33 - 36 cm
L	28 - 31 cm	36 - 39 cm
XL	31 - 33 cm	39 - 42 cm



Please try on the product for best fit

### SAUNA SUITS

USER WAIST	LENGTH OF LOWER	USER CHEST	LENGTH OF TOP	SIZE
56-62 cm	100	122-128	73	38/S
62-68 cm	104	128-134	75	40/M
68-74 cms	108	134-140	77	42/L
74-80 cm	111	140-146	79	44/XL

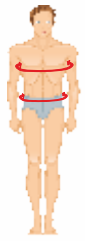

Please try on the product for best fit

### SHOOTING JACKET

USER CHEST	LENGTH	SIZE
100-104 cm	76 cm	S
104-108 cm	78 cm	M
108-112 cm	80 cm	L
112-116 cm	82 cm	XL
116-120 cm	84 cm	XXL



Please try on the product for best fit

### MMA GLOVES



CIRCUMFERENCE	SIZE
15-21.50cm	S/M
21.50-24.50cm	L/XL

Please measure the circumference of your hand below knuckles



Please try on the product for best fit

# SIZE CHARTS

HEAD MEASUREMENT		Please measure the circumference your head around your forehead as just above your eyebrows:  FRONT   BACK 
CIRCUMFERENCE	SIZE	
UPTO 55cm (22")	S	
55-60cm (23.5")	M	
60-65cm (25")	L	
65cm and above	XL	

Please try on the product for best fit

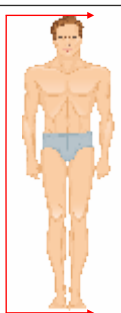
JIU JITSU GI			
HEIGHT (cm)	WEIGHT (Kg)	SIZE	
155-165	45-57 Kg	A0	
165-173	57-68 Kg	A1	
173-180	68-82 Kg	A2	
180-188	82-98 Kg	A3	
188- and above	98 Kg & above	A4	

- You can base your dress size on either of the 2 criteria or both if they match.
- Please try on the product for best fit

RASH GUARD/ COMPRESSION TOPS			
USER CHEST	LENGTH	SIZE	
92-94 cm	65 cm	38/S	
94-96 cm	66 cm	40/M	
96-98 cm	67 cm	42/L	
98-100 cm	68 cm	44/XL	

Please try on the product for best fit

WRESTLING SUIT MEN			
USER CHEST	LENGTH	SIZE	
58-62 cm	79 cm	36/XS	
62-66 cm	82 cm	38/S	
66-70 cm	85 cm	40/M	
70-74 cm	88 cm	42/L	
74-78 cm	91 cm	44/XL	

Please try on the product for best fit

WEIGHT LIFTER SUIT MEN			
USER CHEST	LENGTH	SIZE	
68-72 cm	84 cm	36/XS	
72-76 cm	87 cm	38/S	
76-80 cm	90 cm	40/M	
80-84 cm	93 cm	42/L	
84-88 cm	96 cm	44/XL	

Please try on the product for best fit

MARTIAL ARTS DRESSES				
	HEIGHT (cm)	WEIGHT (Kgs.)	SIZE	
a) Karate Gis	90-100	15-20	100	
	100-110	18-27	110	
	110-120	25-32	120	
	120-130	30-40	130	
	130-140	38-50	140	
b) Taekwondo DoBok	140-150	48-65	150	
	150-160	63-77	160	
	160-170	75-90	170	
c) Judo Gis	170-180	86-100	180	
	180-190	95-118	190	
	190-200	115-130	200	

- You can base your dress size on either of the 2 criteria or both if they match.
- Please try on the product for best fit

BOXING SHORTS & VEST					
USER WAIST (cm)	SHORTS LENGTH	VEST LENGTH	USER CHEST	SIZE	
53-61 cm	50 cm	68	87-91 cm	XS	
61-69 cm	52.5 cm	71	91-95 cm	S	
69-77 cm	55 cm	74	95-99 cm	M	
77-85 cm	57.5 cm	77	99-103 cm	L	
85-93 cm	60 cm	80	103-107 cm	XL	
93-101cm	62.5 cm	83	107-111 cm	XXL	

Please try on the product for best fit

BOXING GOWN			
USER CHEST	GOWN LENGTH	SIZE	
152-156 cm	96 cm	38/S	
156-160 cm	102 cm	40/M	
160-164 cm	108 cm	42/L	
164-168 cm	114 cm	44/XL	

Please try on the product for best fit

WRESTLING SUIT WOMEN			
USER CHEST	LENGTH	SIZE	
64-68 cm	77.5 cm	36/XS	
68-72 cm	80.5 cm	38/S	
72-76 cm	83.5 cm	40/M	
76-80 cm	86.5 cm	42/L	
80-84 cm	89.5 cm	44/XL	

Please try on the product for best fit

WEIGHT LIFTER SUIT WOMEN			
USER CHEST	LENGTH	SIZE	
62-66 cm	78 cm	36/XS	
66-70 cm	81 cm	38/S	
70-74 cm	84 cm	40/M	
74-78 cm	87 cm	42/L	
78-82 cm	90 cm	44/XL	

Please try on the product for best fit

# SIZE CHARTS

### POISING TRUNK

USER WAIST	LENGTH	SIZE
25 cm	21cm	38/S 40/M
27 cm	24cm	42/L 44/XL



Please try on the product for best fit

### MMA SHORTS

USER WAIST	SHORTS LENGTH	SIZE
78-82 cm	47.50 cm	S
82-86 cm	49.00 cm	M
86-90 cm	50.50 cm	L
90-94 cm	52.00 cm	XL



Please try on the product for best fit

### MUAY THAI SHORTS

USER WAIST (cm)	SHORTS LENGTH	SIZE
55-61 cm	41 cm	38/S
61-67 cm	42 cm	40/M
67-73 cm	43 cm	42/L
73-79 cm	44 cm	44/XL



Please try on the product for best fit

### VEST & SINGLETS

USER CHEST	LENGTH	SIZE
76-82 cm	62 cm	34/XXS
82-88 cm	65 cm	36/XS
88-94 cm	68 cm	38/S
94-100 cm	71 cm	40/M
100-106 cm	74 cm	42/L
106-112 cm	77 cm	44/XL



Please try on the product for best fit

### MENS COMPRESSION SHORTS

USER WAIST (cm)	LENGTH	SIZE
52-60cm	44cm	38/S
60-68cm	46cm	40/M
68-76cm	48cm	42/L
76-84cm	50cm	44/XL
84-92cm	52cm	46/XXL



Please try on the product for best fit

### HOODIES / ZIPPER JACKETS

USER CHEST	LENGTH	SIZE
59-61 cm	67 cm	38/S
61-63 cm	69 cm	40/M
63-65 cm	71 cm	42/L
65-67 cm	73 cm	44/XL



Please try on the product for best fit

### MENS COMPRESSION PANT

USER WAIST (cm)	LENGTH	SIZE
60-64cm	84cm	38/S
64-68cm	87cm	40/M
68-72cm	90cm	42/L
72-76cm	93cm	44/XL
76-80cm	96cm	46/XXL



Please try on the product for best fit

### PHYSIQUE BOARD SHORTS

USER WAIST	LENGTH	SIZE
40 cm	45 cm	S / 38
41 cm	47 cm	M / 40
42 cm	49 cm	L / 42



Please try on the product for best fit

### T.SHIRT

USER CHEST	LENGTH FROM SHOULDER TOP	SIZE
108-114 cm	71 cm	38/S
114-120 cm	74 cm	40/M
120-126 cm	77 cm	42/L
126-132 cm	80 cm	44/XL



Please try on the product for best fit

### PADDED BIKE SHORTS - MEN

USER WAIST (cm)	LENGTH	SIZE
62-64cm	48cm	38/S
64-66cm	50cm	40/M
66-68cm	52cm	42/L
68-70cm	54cm	44/XL
70-72cm	56cm	46/XXL



Please try on the product for best fit

### PADDED BIKE SHORTS - WOMEN

USER WAIST (cm)	LENGTH	SIZE
56-60cm	36cm	38/S
60-64cm	39cm	40/M
64-68cm	41cm	42/L
68-72cm	43cm	44/XL



Please try on the product for best fit