

TRACK & FIELD

•8 52

SPEED & AGILITY

•53 62

WEIGHT LIFTING

•63 75

GYM/STRENGTH

•76 105

GYMNASTICS

•106 112

MATS & ARENAS

•113 115

POLES, POSTS & NETS

•116 125

TABLE TENNIS

•126 127

CRICKET

•128 145

SPORT BAGS

•146 148

TM
Melo

DO ... DARE ... WIN !!

NeleoTM

DO DARE WIN !!

Now all genuine NeleoTM products come with 3D holographic labels



Nelco Track & Field Equipment/Implements have been used at the following major events:

- 1982 IX Asian Games at New Delhi, India.
- 1986 X Asian Games at Seoul, South Korea.
- 1991 III IAAF World Athletic Championships at Tokyo, Japan
- 1992 XXV Olympic Games at Barcelona, Spain.
- 1996 XXVI Olympic Games at Atlanta, United States of America.
- 1999 VII IAAF World Athletic Championships at Seville, Spain.
- 2000 XXVII Olympic Games at Sydney, Australia.
- 2001 VIII IAAF World Athletic Championships at Edmonton, Canada.
- 2002 XIV Asian Games at Busan, South Korea.
- 2002 X Junior Asian Athletic Championships at Bangkok, Thailand.
- 2003 XV Asian Athletic Championships at Manila, Philippines.
- 2003 IX IAAF World Athletic Championships at Paris, France.
- 2003 I Afro-Asian Games at Hyderabad, India.
- 2004 XXVIII Olympic Games at Athens, Greece.
- 2004 X Junior Asian Athletic Championships at Ipoh, Malaysia.
- 2005 X IAAF World Athletic Championships at Helsinki, Finland.
- 2006 XVII Commonwealth Games at Melbourne, Australia.
- 2006 XV Asian Games at Doha, Qatar.
- 2006 XI IAAF World Junior Athletic Championships at Beijing, China.
- 2006 X IAAF World Athletic Championships at Athens, Greece.
- 2006 XVI South East Asian Games, Nakhon Ratchasima, Thailand.
- 2007 IAAF World Athletic Championships at Osaka, Japan.
- 2007 IAAF World Junior Athletic Championships at Ostrava, Czech Republic.
- 2008 IAAF World Junior Athletic Championships at Bydgoszcz, Poland.
- 2008 XII IAAF World Indoor Athletic Championships at Valencia, Spain.
- 2008 XXIX Olympic Games at Beijing, China.
- 2009 XII IAAF World Athletic Championships at Athens, Greece.
- 2009 XI IAAF World Youth Athletic Championships at Sudtiro, Italy.
- 2009 I Youth Asian Games, Singapore.
- 2010 XIII IAAF World Indoor Athletic Championships at Doha, Qatar.
- 2010 XIII IAAF World Junior Athletic Championships at Moncton, Canada.
- 2010 XVIII Commonwealth Games at New Delhi, India.
- 2010 XVI Asian Games at Guangzhou, China.
- 2010 I Youth Olympic Games, Singapore.
- 2011 XII IAAF World Youth Athletic Championships at Lille, France.
- 2011 XII IAAF World Athletic Championships at Daegu, Korea.
- 2012 XIV IAAF World Junior Athletic Championship at Barcelona, Spain.
- 2012 XXX Olympic Games at London, United Kingdom.
- 2013 XX Asian Athletic Championships at Pune, India.
- 2013 XIII IAAF World youth Athletic Championships at Moscow, Russia.
- 2014 XIX Commonwealth Games at Glasgow, Scotland.
- 2014 XVI Asian Junior Athletics Championship at Taipei, Taiwan.
- 2014 XXII European Athletics Championship at Zurich, Switzerland.
- 2014 II Youth Olympic Games at Nanjing, China.
- 2014 II International Continental Cup at Marrakech, Morocco.
- 2014 XVII Asian Games at Incheon, South Korea.
- 2015 XV IAAF World Athletic Championships at Beijing, China.

- 2016 XVI IAAF World Indoor Athletic Championships at Portland, USA.
- 2016 XXXI Olympic Games at Rio de Janeiro, Brazil.
- 2016 XII South Asian Games at Guwahati & Shillong, India.
- 2016 XXIII European Athletics Championships at Amsterdam, Netherlands.
- 2017 XVI IAAF World Athletic Championships at London United Kingdom.
- 2017 XXIX South East Asian Games at Kuala Lumpur, Malaysia.

On Course to:

- 2018 III International Continental Cup at Ostrava, Czech Republic.
- 2018 XXI Commonwealth Games at Gold Coast, Australia.
- 2018 XVIII Asian Games at Jakarta Palembang, Indonesia.
- 2018 XXIV European Athletics Championships at Berlin, Germany.



An ISO 9001: 2015 Certified Organization



THE SPORTS GOODS EXPORT PROMOTION COUNCIL

IAAF CERTIFICATES



CREDENTIALS

DO ... DARE ... WIN !!

IAAF CERTIFICATES

CREDENTIALS

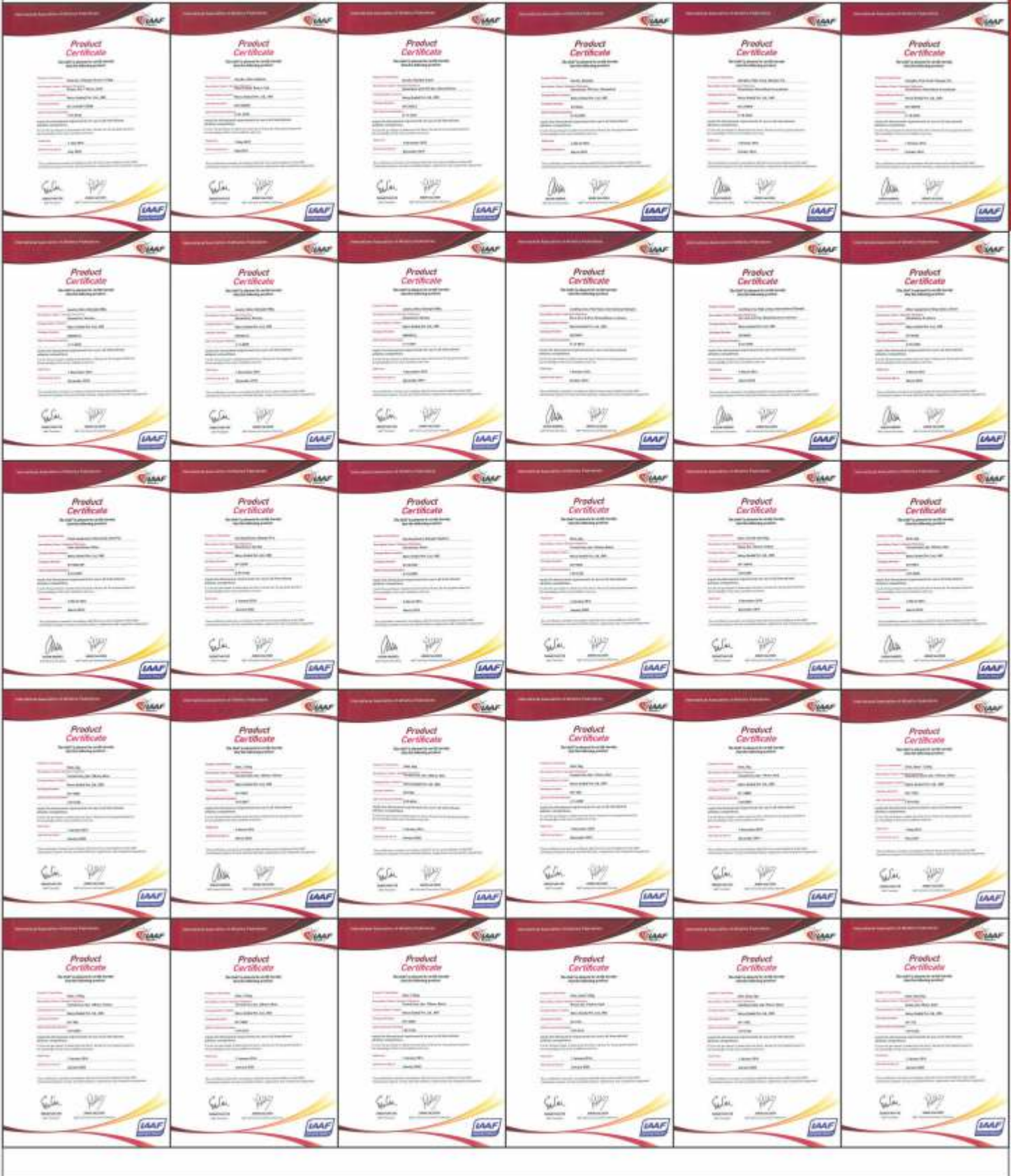

DO ... DARE ... WIN !!

TEAM NELCO SETS A BENCH MARK FOR TRACK & FIELD EQUIPMENT!!

Established in 1942 at Lahore in undivided India and reborn in 1950 at Meerut after the partition of India, Nelco has become the most recognized Track & Field equipment brand across the world. Be it at the Athletics Federation of India's domestic circuit, International Association of Athletics Federation's numerous meets or the Olympiads; you will find a Nelco implement everywhere.

QUALITY IS THE PHILOSOPHY

Track & Field as a unique sport makes the human body and mind reach for its ultimate boundaries of endurance and speed. We at Nelco understand that we can contribute to the athlete's performance by assuring the best quality equipment. Our quality control team constantly evaluates our finished products and raw material to consistently produce top quality equipment. New techniques and better raw material are regularly introduced to the production line to enhance quality of products.

INNOVATION IS THE WAY TO MOVE FORWARD

Athletes at the competitive level have the mental toughness, physical potential and the technique to reach the record books. But it is that extra edge which makes them clear the final bastion. It is here that Nelco steps in to provide that extra edge with The Right Implement*. Consistent and dedicated R&D has resulted in many innovations over the last few decades helping us produce the most suitable equipment for different levels of athletes.

SERVICE IS THE KEY TO SUCCESS

Nelco Track & Field Equipment is available across the nation through a network of 300+ dealers and resellers. Nelco products are available in 70+ countries through dedicated distributors. All queries addressed to our customer care email (cc@nelcoworld.com) are addressed within 24 hours by our team of experts.

THE RIGHT APPROACH

All the above factors have contributed to Nelco being known as the best engineered and most popular



THE RIGHT IMPLEMENT*

Team Nelco understands what it takes for a world class thrower to reach that extra distance. This is why the right implement* is required. Nelco has a perfect Discus, Shot or Hammer for every thrower!!

We help the throwers to select the best implement to reach his or her full potential. Superior aerodynamics, firmer grip and the right ingredients make it much easier for a thrower to handle the implement and have full control over it when it leaves the hand resulting in a better and farther throw. Constant innovations have resulted in our highly acclaimed PMD* and HRM* technologies for discus throw enabling us to produce the widest range of discus for various level of throwers.

The new Nelco KIN-O-MAX Shot Puts and Hammers are designed to achieve maximum Kinetic Energy when in motion to enable a perfectly Balanced Throw. This optimum performance is achieved with a right mix of material, diameter and weight.

The Right Discus*

A higher rim weight discus suits a thrower who has a more evolved technique. A thrower who can maintain a spin through two-thirds or more of the throw should move up to a higher rim discus. A lower rim discus may stay in the hand longer for more control and may suit a beginner or an intermediary thrower.

Wind is also a factor that effects selection of your discus. A high rim discus that may encounter a crosswind will tip prematurely reducing throw potential. One may move to a lower rim discus for better control in windy conditions. Thus, it is necessary to carry a mix of discus in your kit.

Nelco is the most thrown discus than any other brand over the past two decades.

Nelco is the only brand to offer Distance Rated Discus with its Trademark RimGlide Technology. RimGlide Technology is available on all Competition Discus. It makes it easier for a thrower to select best suited Discus.

Nelco offers PMD technology on all its top end discus to ensure that your expensive competition discus outlasts all others.

Nelco is the most copied discus in the world. Kindly ensure that your discus comes with a Nelco hologram to ensure genuine product.

The Right Shot Put*

From a bio-mechanical point of view, a larger shot will give a greater contact area and push zone resulting in a farther throw. But it is not necessary that the largest shot is the most suitable.

It is essential to select the most suitable diameter of shot based on your finger size. Finger length is critical. The shot must rest on the pad (callus) of the palm and the fingers must be up the side of the shot. Throwers with shorter fingers may find that the smaller diameter shot feels better at delivery and similarly, those with longer fingers may like the feel of the larger diameter shot.

Our new KIN-O-MAX technology addresses all these issues with a perfect Shot Put for all throwers!



TECHNOLOGY

DO DARE WIN !!

The RimGlide™ Range



TRACK & FIELD

DISCUS

- ULTRA SPIN
- ODYSSEY
- GOLD
- SUPER SPIN
- ULTIMO
- OLYMPIA
- LO SPIN



TECHNOLOGIES

RimGlide™



RANGE

- RimGlide™ 78m
- RimGlide™ 75m
- RimGlide™ 75m
- RimGlide™ 70m
- RimGlide™ 70m
- RimGlide™ 67m
- RimGlide™ 65m

SPIN RANGE



DO ... DARE ... WIN !!

DISCUS



NEW



RimGlide 78M

ULTRA SPIN GOLD

NEW ULTRA SPIN GOLD DISCUS features a Unique double Galvanized Black Rim. The Wider High Retention Rim Gives More Control even with the best of spinning techniques. Suited for the Champion thrower.

- N 1105 USA (DARK CUSTOM) 2.000 Kg. IAAF CERTIFIED
- N 1105 USAA (DARK CUSTOM) 1.750 Kg.
- N 1105 USB (DARK CUSTOM) 1.616 Kg.
- N 1105 USBB (DARK CUSTOM) 1.500 Kg.
- N 1105 USC (DARK CUSTOM) 1.000 Kg. IAAF CERTIFIED



RimGlide 75M



ODYSSEY

Nelco Odyssey features an alloy steel (rust proof) rim and reinforced strongest plates. Ultra super spin discus for the new century throwers.

- N 1105 ODA 2.000 kg. IAAF CERTIFIED
- N 1105 ODAA 1.750 kg. IAAF CERTIFIED
- N 1105 ODB 1.616 kg.
- N 1105 ODDB 1.500 kg.
- N 1105 ODC 1.000 kg. IAAF CERTIFIED



RimGlide 70M

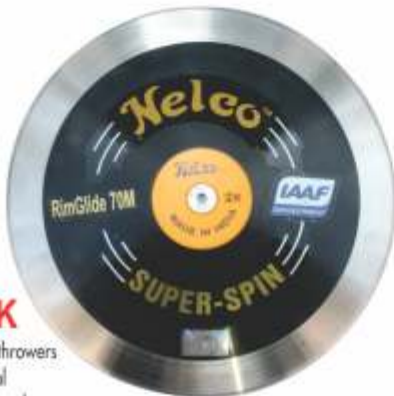

SUPER SPIN BLACK

One of the best selling Discus used by top throwers around the world. Special design with ideal Rim Weight gives super spin - super carry and super stability in flight.

- N 1105 A 2.000 kg. IAAF CERTIFIED
- N 1105 AB 1.750 kg. IAAF CERTIFIED
- N 1105 AA 1.616 kg.
- N 1105 BB 1.500 kg.
- N 1105B 1.000 kg. IAAF CERTIFIED



RimGlide 75M



ODYSSEY BLACK

Also available with the new double Galvanized Black rim.

- N 1105 ODA (DARK CUSTOM) 2.000 kg. IAAF CERTIFIED
- N 1105 ODAA (DARK CUSTOM) 1.750 kg. IAAF CERTIFIED
- N 1105 ODB (DARK CUSTOM) 1.616 kg.
- N 1105 ODDB (DARK CUSTOM) 1.500 kg.
- N 1105 ODC (DARK CUSTOM) 1.000 kg. IAAF CERTIFIED



RimGlide 65M



LO SPIN

Oldest & Strongest discus in the world. Lo spin red. Suitable for all throwers. Now with Superior Dark Custom Black Rim

- N 1104 A 2.000 kg. IAAF CERTIFIED
- N 1104 AA 1.750 kg. IAAF CERTIFIED
- N 1104 AB 1.616 kg.
- N 1104 B 1.500 kg. IAAF CERTIFIED
- N 1104 CC 1.250 kg.
- N 1104 C 1.000 kg. IAAF CERTIFIED
- N 1004 D 0.750 kg.
- N 1004 E 0.600 kg.



RimGlide 75M



GOLD

Featuring brass rim and white strong "ABS" plastic plates. A record setter and the most winning discus.

- N 1105 GA 2.000 kg. IAAF CERTIFIED
- N 1105 GB 1.750 kg. IAAF CERTIFIED
- N 1105 GC 1.616 kg.
- N 1105 GCC 1.500 kg.
- N 1105 GD 1.000 kg. IAAF CERTIFIED



TRACK & FIELD

DO ... DARE ... WIN !!

DISCUS



RimGlide 70M



ULTIMO

Discus with ideal Spin for best performance with reinforced plates.

N 1104 AU	2,000 kg.
N 1104 BU	1,750 kg.
N 1104 CU	1,616 kg.
N 1104 DU	1,500 kg.
N 1104 EU	1,000 kg.

CHALLENGER

Made for collegiate and club use. Steel rim. Blue plastic sides 73% Rim Weight

N 1104 AC	2,000 kg.
N 1104 AAC	1,750 kg.
N 1104 ABC	1,616 kg.
N 1104 BC	1,500 kg.
N 1104 CCC	1,250 kg.
N 1104 CC	1,000 kg.
N 1104 DC	0,750 kg.
N 1104 EC	0,600 kg.



RimGlide 67M



SUPER SPIN OLYMPIA

Steel rim light blue or yellow ABS plates. A high performance discus.

N 1104 AS	2,000 kg.	IAAF CERTIFIED
N 1104 AAS	1,750 kg.	
N 1104 ABS	1,616 kg.	
N 1104 BS	1,500 kg.	IAAF CERTIFIED
N 1104 CCS	1,250 kg.	
N 1104 CS	1,000 kg.	IAAF CERTIFIED



COMPETITION

A discus with a feel of top line discus at a low cost. 70% Rim Weight. Steel rim and Purple Plastic plates

N 1104 AP	2,000 kg.
N 1104 AAP	1,750 kg.
N 1104 ABP	1,616 kg.
N 1104 BP	1,500 kg.
N 1104 CEP	1,250 kg.
N 1104 CP	1,000 kg.
N 1104 DP	0,750 kg.
N 1104 EP	0,600 kg.



DISCUS TRAINER

N 1110 AT	1.50kg
N 1110 DT	2.00kg
N 1110 BT	2.50kg
N 1110 CT	3.63kg

TRACK & FIELD

DO ... DARE WIN !!

DISCUS

INDIANO

A new discus especially created for beginners. Steel rim and plastic plates.



- N 1104 AIO 2.000 kg.
- N 1104 BIO 1.750 kg.
- N 1104 EIO 1.616 kg.
- N 1104 CIO 1.500 kg.
- N 1104 FIO 1.250 kg.
- N 1104 DIO 1.000 kg.
- N 1104 HIO 0.750 kg.
- N 1104 GIO 0.600 kg.



ADJUSTABLE WEIGHT TRAINING

Comes with Different weights for adjusting. Strong plastic sides with steel rim.

- N 1108 A 1.75 kg to 2.20 kg.
- N 1108 B 1.25 kg to 1.60 kg.
- N 1108 C 1.40 kg to 1.80 kg.
- N 1108 D 800 gms to 1.20 kg.

LAMINATED POPULAR COMPETITION

Laminated wood high quality steel rim.



- N 1106 AL 2.000 kg.
- N 1106 ALL 1.750 kg.
- N 1106 ABL 1.616 kg.
- N 1106 BL 1.500 kg.
- N 1106 CCL 1.250 kg.
- N 1106 CL 1.000 kg.
- N 1106 DL 0.750 kg.
- N 1106 EL 0.600 kg.

RUBBER BLACK DISCUS COLOURED CENTRE

Different colour centre for easy recognition.



- N 1110 AO 2.000 kg.
- N 1110 AAO 1.750 kg.
- N 1110 ABO 1.616 kg.
- N 1110 ACO 1.500 kg.
- N 1110 ADO 1.250 kg.
- N 1110 AEO 1.000 kg.

TRAINING DISCUS

Plastic Plate steel rim.



- N 1110 PA 0.900 kg.
- N 1110 PB 1.100 kg.
- N 1110 PC 1.500 kg. (in 1.00kg IAAF DIMENSIONS)
- N 1110 PD 1.900 kg.
- N 1110 PE 2.100 kg.

RUBBER BLACK

Tough durable black colour rubber. Solid one piece construction.



- N 1110 A 2.000 kg.
- N 1110 AA 1.750 kg.
- N 1110 AB 1.616 kg.
- N 1110 B 1.500 kg.
- N 1110 CC 1.250 kg.
- N 1110 C 1.000 kg.
- N 1110 D 0.750 kg.
- N 1110 DE 0.600 kg.
- N 1110 E 0.500 kg.

Also Available with strap.

TRACK & FIELD

DO ... DARE WIN !!

DISCUS

DISCUS BAG

- N 1109 F 2.000 kg.
- N 1109 G 1.000 kg.
- N 1109 FD 2.000 kg.
- N 1109 GD 1.000 kg.

(FOR 2 DISCUS)
(FOR 2 DISCUS)

DISCUS THROWER KIT BAG

- N 1109 KB (FOR 3 DISCUS, SPIKES, KIT)



DISCUS RACK

- N 11101F
- Collapsible Rack.
- Powder Coated.



DISCUS CART

- N 11101FC Powder Coated Cart.



SHOT PUT //

Nelco Produces a wide range of Shot Put to cater to all level of throwers.
Our top range of shots are precision machine turned and finely balanced to IAAF rules.

Nelco KIN-O-MAX Shot Puts

- Designed to achieve maximum Kinetic Energy when in motion to enable a perfectly Balanced Throw.
- Plug Free Tough Ductile Ball.
- Precise Weight Distribution along the Edges to maintain Momentum all through the flight.
- Superior Grippier Surface with a Premium Anti-Slip Finish.

7.26K/129MM N2018 KMSA

4.00K/105MM N2018 KMSE

NEW



DO DARE WIN !!

TRACK & FIELD

SHOT PUT

STAINLESS STEEL ALLOY SHOTS

Rust proof strong stainless steel lead filled shell. Precision machine turned to different dia's to meet IAAF specifications.

Code	Weight	Dia	
N 1117 XD	7.26 Kg.	129 mm	IAAF CERTIFIED
N 1117 XE	7.26 Kg.	125 mm	
N 1117 XF	7.26 Kg.	120 mm	
N 1117 XB	7.26 Kg.	115 mm	
N 1117 XA	7.26 Kg.	110 mm	
N 1117 XAC	6.00 kg.	105 mm	
N 1117 XJ	5.45 Kg.	103 mm	
N 1117JC	5.00 kg.	100 mm	
N 1117 XG	4.00 Kg.	109 mm	
N 1117 XH	4.00 Kg.	104 mm	
N 1117 XI	4.00 Kg.	100 mm	
N 1117 XC	4.00 Kg.	95 mm	IAAF CERTIFIED

(Other sizes also available)



BRASS SHOTS

Lead filled Brass Shell Precision machine turned shots. Meet IAAF specifications.

Code	Weight	Dia	
N 1117 A	7.26 Kg.	110 mm	IAAF CERTIFIED
N 1117 B	6.25 Kg.	107 mm	
N 1117 BB	6.00 Kg.	106 mm	IAAF CERTIFIED
N 1117 C	5.45 Kg.	102 mm	
N 1117 D	5.00 Kg.	100 mm	
N 1117 E	4.00 Kg.	95 mm	IAAF CERTIFIED
N 1117 F	3.63 Kg.	89 mm	



SHOT PUT



STEEL SHOTS

Made out of solid steel or steel shell. Precision Machine turned to different dia's to meet IAAF specifications. Polyurethane paint coated for smooth and extra durable finish.

Code	Weight	Dia	
N 1118 AX	7.26 Kg.	129 mm	IAAF CERTIFIED
N 1118 BX	7.26 Kg.	125 mm	
N 1118 CX	7.26 Kg.	120 mm	
N 1118 DX	7.26 Kg.	115 mm	
N 1118 EX	7.26 Kg.	110 mm	
N 1118 EXA	6.00 Kg.	124 mm	IAAF CERTIFIED
N 1118 EXC	6.00 Kg.	105 mm	
N 1118 KX	5.45 Kg.	103 mm	
N 1118 FX	4.00 Kg.	109 mm	IAAF CERTIFIED
N 1118 GX	4.00 Kg.	104 mm	
N 1118 HX	4.00 Kg.	102 mm	
N 1118 IX	4.00 Kg.	100 mm	
N 1118 JX	4.00 Kg.	95 mm	

(Other sizes also available)



TURNED IRON SHOTS GAUGED

Made out of solid cast iron. Precision machine turned to different dia to meet IAAF specifications. Balanced for high performance. Polyurethane paint coated for extra durable finish.

Code	Weight	Dia	
N 1118 AA	7.26 Kg.	129 mm	
N 1118 A	7.26 Kg.	128 mm	IAAF CERTIFIED
N 1118 AB	7.26 Kg.	125 mm	IAAF CERTIFIED
N 1118 AC	7.26 Kg.	120 mm	IAAF CERTIFIED
N 1118 B	6.25 Kg.	121 mm	
N 1118 BB	6.00 Kg.	119 mm	IAAF CERTIFIED
N 1118 C	5.45 Kg.	115 mm	IAAF CERTIFIED
N 1118 CA	5.45 Kg.	108 mm	
N 1118 D	5.00 Kg.	114 mm	IAAF CERTIFIED
N 1118 EE	4.00 Kg.	109 mm	
N 1118 E	4.00 Kg.	108 mm	IAAF CERTIFIED
N 1118 EA	4.00 Kg.	104 mm	IAAF CERTIFIED
N 1118 EAA	4.00 Kg.	102 mm	
N 1118 EB	4.00 Kg.	100 mm	IAAF CERTIFIED
N 1118 F	3.63 Kg.	104 mm	
N 1118 G	3.25 Kg.	100 mm	
N 1118 H	3.00 Kg.	97 mm	IAAF CERTIFIED



INTERNATIONAL TURNED IRON SHOTS

Turned economy shots to meet IAAF specifications. Turned out of solid cast iron.

Code	Weight
N 1119 TB	20 LBS.
N 1119 TC	18 LBS.
N 1119 DT	7.26 KG
N 1119 TEE	6.25 KG
N 1119 TE	6.00 KG
N 1119 FTE	5.45 KG
N 1119 TG	5.00 KG
N 1119 TH	4.45 KG
N 1119 HTF	4.00 KG
N 1119 TJ	3.63 KG
N 1119 TI	3.25 KG
N 1119 GTE	3.00 KG
N 1119 TL	2.72 KG
N 1119 TN	2.00 KG

SHOT PUT



CLUB AS CAST SHOTS

As cast Shots

Code	Weight
N 1119 A	9.00 Kg.
N 1119 B	8.50 Kg.
N 1119 C	8.00 Kg.
N 1120 A	7.26 Kg.
N 1120 B	6.25 Kg.
N 1120 D	5.45 Kg.
N 1120 G	4.00 Kg.
N 1120 H	3.63 Kg.
N 1120 J	3.00 Kg.
N 1120 K	2.72 Kg.
N 1120 M	2.00 Kg.
N 1120 O	1.00 Kg.

(Other sizes also available)



INDOOR RUBBER SHOTS

Made out of strong hard rubber shells, holds shape but will not damage floor.

Code	Weight
N 1119 LR	7.26 Kg.
N 1119 MR	6.25 Kg.
N 1119 NR	6.00 Kg.
N 1119 OR	5.45 Kg.
N 1119 PR	5.00 Kg.
N 1119 QR	4.00 Kg.
N 1119 RR	3.00 Kg.
N 1119 SR	2.00 Kg.
N 1119 TR	1.00 Kg.



SHOT PUT CART

N 1110 KEC
Powder Coated Cart



SHOT PUT RACK

N 1110 KE
Collapsible Design, Powder coated

DO DARE WIN !!

TRACK & FIELD

HAMMER THROW //

Nelco produces a wide variety of Throwing Hammers to cater to different Level of Throwers. Competition Hammers are precision machine turned and finely balanced to IAAF Specifications. Speed ball-bearing on the hammer head ensures a smooth & free movement. All Competition Hammers come with Spring Steel Wire and the "Signature" Nelco IAAF approved Grip.

Nelco KIN-O-MAX Hammers

- Designed to achieve maximum Kinetic Energy when in motion to enable a perfectly Balanced Flight.
- Tough Ductile Ball to ensure a Dent Free Hammer.
- Stainless Steel Swivel.
- Unique one piece Billet Aluminium Handle (N1125C).
- Premium long lasting Finish.

7.26K/115MM N2018 KMHA

4.00K/98MM N2018 KMHE

NEW



HAMMER THROW

OLYMPIC ALLOY HAMMER

Shell made out of rust proof alloy (Stainless Steel) for high performing world champion. Precision machine turned to meet IAAF specification. Stainless Steel speed ball bearing. Spring steel wire and light & strong Aluminium IAAF Approved grip.

Code	Weight	Dia	
N 1122 XA	7.26 Kg.	110 mm	IAAF CERTIFIED
N 1122 XB	7.26 Kg.	115 mm	
N 1122 XBB	6.00 Kg.	105 mm	
N 1122 XD	5.45 Kg.	103 mm	
N 1122 XDD	5.00 Kg.	100 mm	
N 1122 XC	4.00 Kg.	95 mm	IAAF CERTIFIED



OLYMPIC BRASS HAMMER

Cast brass shell turned to precision dia's to meet IAAF rules.

Code	Weight	Dia	
N 1121 A	7.26 Kg.	110 mm	IAAF CERTIFIED
N 1121 B	6.25 Kg.	107 mm	
N 1121 BB	6.00 Kg.	105 mm	
N 1121 C	5.45 Kg.	102 mm	
N 1121 CC	5.00 Kg.	100 mm	
N 1121 D	4.00 Kg.	95 mm	IAAF CERTIFIED

(Fitted with IAAF Approved Aluminium handle)



OLYMPIC STEEL HAMMER

Made out of Steel. A strong hammer at an economical cost that meets all IAAF specification. Perfectly precision machined to minimum dia.

Code	Weight	Dia	
N 1122 AS	7.26 Kg.	110 mm	IAAF CERTIFIED
N 1122 BS	7.26 Kg.	115 mm	
N 1122 CS	6.25 Kg.	107 mm	
N 1122 CSA	6.00 Kg.	105 mm	IAAF CERTIFIED
N 1122 DS	5.45 Kg.	103 mm	
N 1122 DSA	5.00 Kg.	100 mm	IAAF CERTIFIED
N 1122 ES	4.00 Kg.	95 mm	IAAF CERTIFIED

(Fitted with IAAF Approved Aluminium handle)



HAMMER THROW

COMPETITION TURNED IRON HAMMER

Precision machine turned to exact diameters.

Code	Weight	Dia	
N 1122 AT	7.26 Kg.	119 mm	
N 1122 BT	6.00 Kg.	117 mm	IAAF CERTIFIED
N 1122 CT	5.45 Kg.	108 mm	
N 1122 DT	4.00 Kg.	100 mm	
N 1122 ET	3.63 Kg.	95 mm	
N 1122 HT	3.00 Kg.	92 mm	IAAF CERTIFIED

(Fitted with IAAF Approved Aluminium Handle)



INTERNATIONAL TURNED IRON HAMMER

Machine turned to IAAF rules. Fitted with aluminium handle

Code	Weight
N 1123 IA	20 LBS.
N 1123 IB	18 LBS.
N 1123 ATF	7.26 KG.
N 1123 FTF	6.25 KG.
N 1123 TBB	6.00 KG.
N 1123 CTF	5.45 KG.
N 1123 ETF	5.00 KG.
N 1123 DTH	4.50 KG.
N 1123 DTF	4.00 KG.
N 1123 TF	3.63 KG.
N 1123 TG	3.25 KG.
N 1123 TC	3.00 KG.
N 1123 TH	2.72 KG.
N 1123 TJ	2.00 KG.



CLUB AS CAST

Accurate weight untruned hammer with ball bearing & Steel Handle.

Code	Weight
N 1123 AA	20.00 lbs
N 1123 AB	18.00 lbs
N 1123 A	7.26 Kg.
N 1123 BA	14.00 lbs
N 1123 BB	6.00 Kg.
N 1123 C	5.45 Kg.
N 1123 CC	5.00 Kg.
N 1123 D	4.00 Kg.
N 1123 E	3.63 Kg.



HAMMER THROW



HAMMER GLOVES SUPER PRO

Specially designed from high quality leather to stand the rigours of toughest hammer throwers. Seam on outside finger eliminated for Perfect fit. With Wrap-around strap for best possible grip. The most used glove worldwide. Available in LH/RH, Small/Medium/Large/XL sizes.



IAAF APPROVED HANDLE

HAMMER ACCESSORIES

- N 1125 A Hammer Handle Alum. Curved
- N 1125 B Hammer Handle Alum. Straight (IAAF Approved)
- N 1125 C Hammer Handle Super Pro (Billet Aluminium)
- N 1125 E Hammer Handle Steel Practice.
- N 1125 F Hammer Wire Steel.



THROWING WEIGHT

Turned iron ball bearing swivel with triangular steel handle.

Code	Weight
N 1132 AT	56 lbs.
N 1132 BT	35 lbs.
N 1132 CT	25 lbs.
N 1132 DT	20 lbs.



HAMMER CART

N1110 LEC
Powder Coated Cart



HAMMER RACK

N 1110 LE
Collapsible Design. Powder Coated.

TRACK & FIELD

DO DARE WIN !!

STARTING BLOCKS

Widest range of Starting Blocks to cater to all requirements of the Modern Athlete.



OLYMPIC PRO BLOCK N 1132 PR

The Nelco Olympic Block has been used in several international meets all over the world. Super heavy duty block especially designed for top athletes. All Aluminium block with center rail 100 mm wide x 900 mm long and slotted angles to firmly grip Pedals. Adjustable at four different angles. All Pedals fitted with special thick rubber to take in spikes. Suitable block for synthetic track. Comes with steel plates. Flushed to centre rail. IAAF Certified

Easy Carry Handle Available as an option,
Available on Order

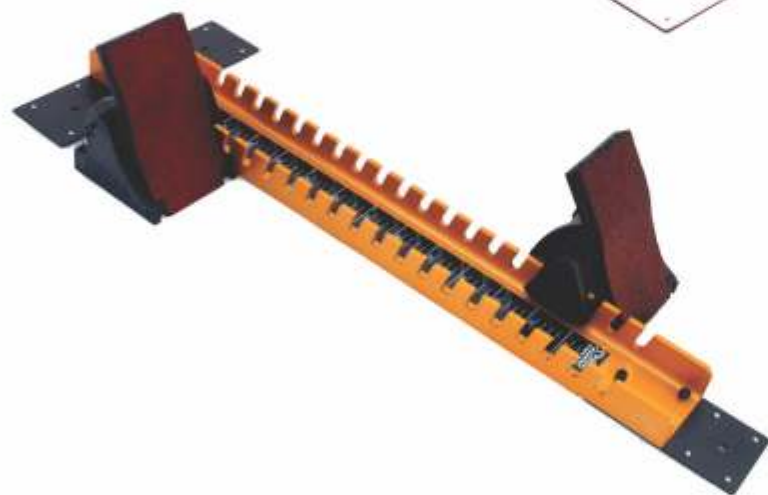

INTERNATIONAL BLOCK N1131 OIN

A New Block 80mm wide x 850mm long x 6 mm thick center recessed rail for stability. Meets All Requirements for a World Class Block. Detachable and adjustable Aluminium pedals.

Easy Carry Handle Available as an option,
Available on Order

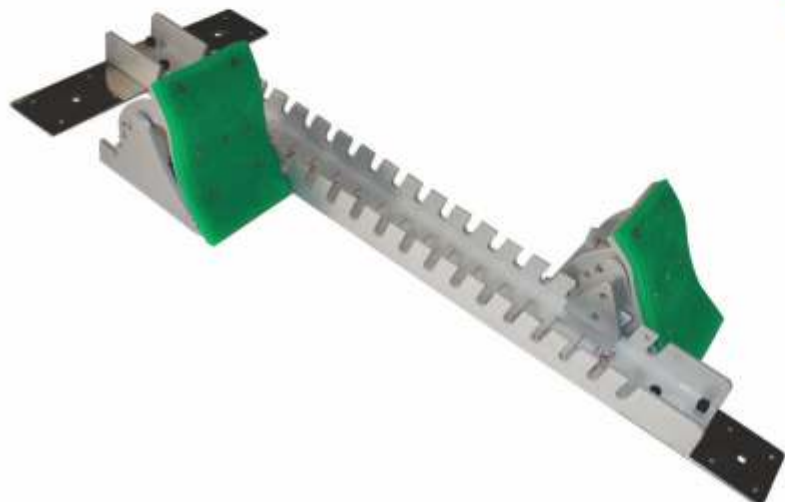

TRACK & FIELD

DO DARE WIN !!

STARTING BLOCKS



OLYMPIC BLOCK STADIUM N 1131 OSV

Another version of our Olympic block with light aluminium pedals and 75 mm aluminium central rail. Detachable and adjustable aluminium pedals. IAAF Certified

Easy Carry Handle Available as an option, Available on Order

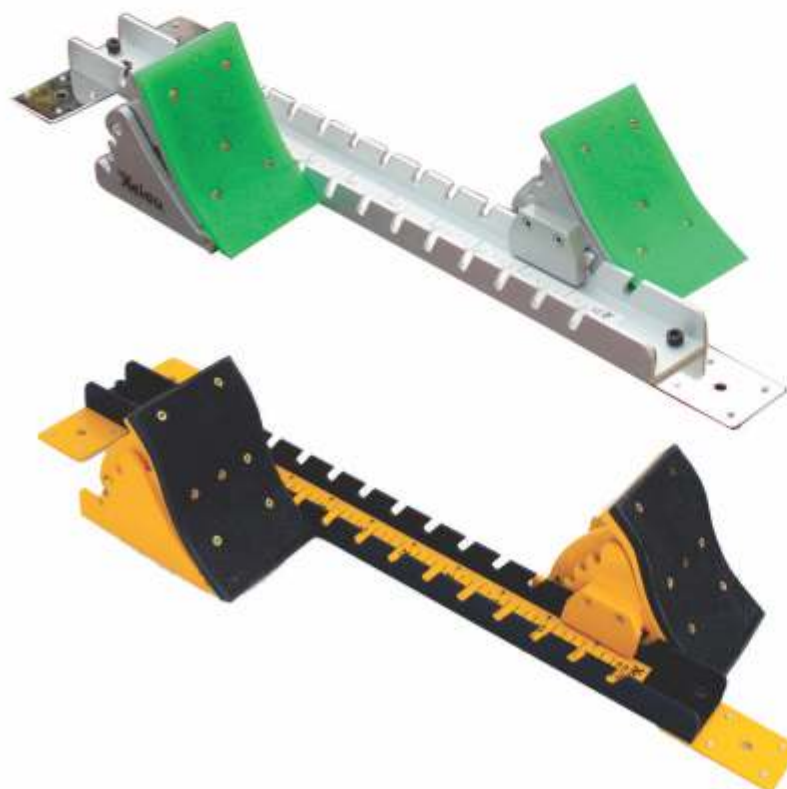
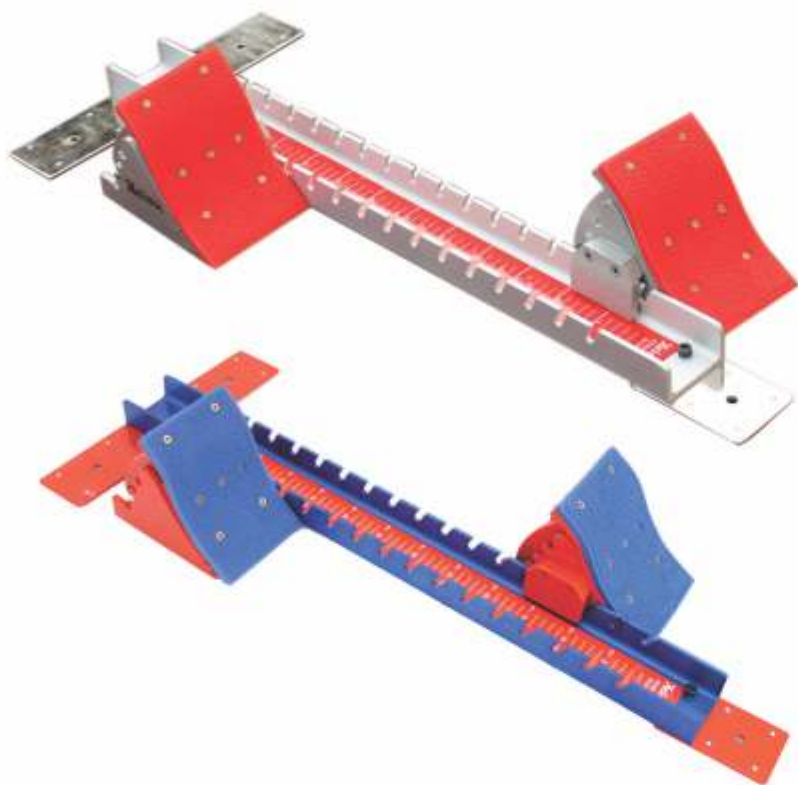

OLYMPIC ELITE ALUMINIUM BLOCK N 1131 OSC

An economy olympic block for school. 62mm aluminium central rail and aluminium pedals. Detachable and adjustable aluminium pedals.

DO DARE WIN !!

TRACK & FIELD

STARTING BLOCKS

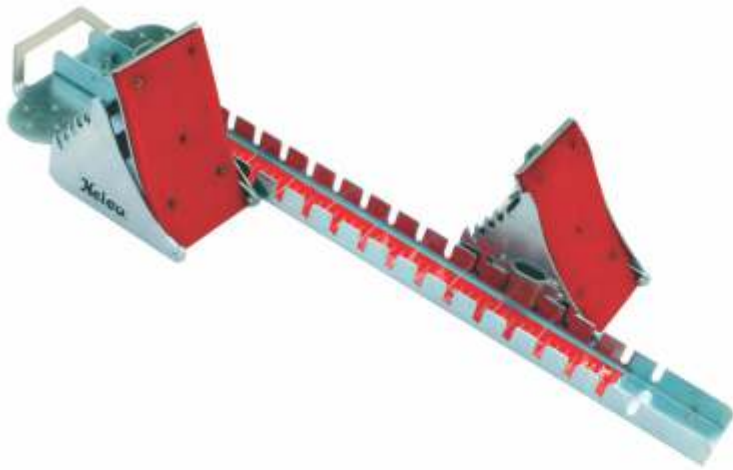

OLYMPIC ELITE STEEL BLOCK N 1131 SSC

Another version of our Olympic block with large Steel pedals and 68 mm steel central rail. Detachable and adjustable Steel pedals.



COMPETITION STEEL BLOCK N1131STL

Fixed angle pedals on an all steel chrome plated rail spring loaded plunger for pedal adjustment. Comes fitted with spikes.



T-STAR STARTING BLOCK N 1131 T

Designed for fast start. Spring loaded adjustment pins for quick movement of pedals to. Steel rail and Steel pedals. All weather spikes for synthetic tracks.

STARTING BLOCKS



COMPETITION SUPER BLOCK (ALL SURFACE) N 1131 CSB

An all steel scaled down version of olympic blocks with slotted channel. Fixed angle pedals.



SCHOOL SUPER BLOCK N1131 SSM

All steel economy block gives a feel of the larger blocks to elementary runners. Fixed angle pedals.



INDOOR STARTING BLOCK N 1131 ID

Rubber block specially designed for indoor use. No nail-holes. Provides a non slip start.



BLOCK CART

N 1110 SBC
Powder Coated Cart

TRACK & FIELD

DO DARE WIN !!

HURDLES

TRACK & FIELD



1. Extra Strong Ribbed PVC Hurdle Board



2. Unique Pinch-Free Height Adjust System



OLYMPIA SUPER ALUMINIUM HURDLE N1132 ALS- AUTOMATIC

An All aluminium Hurdle in Square Tube Profile. Comes with a unique telescopic pinch free height adjust system. IAAF Spec strong Ribbed PVC Hurdle board. Automatic Hurdle weight Adjust System. All Aluminium profile, Stainless Steel Nut/ Bolts and Powder Coated gliding weights ensure ultimate weather protection for years of hassle free usage. Bright coloured height and weight indicator stickers. Height Range 0.685m to 1.067m. IAAF

3. Superior Welds for years of Trouble-Free use.



4. Easy-Glide slotted weight adjust system (Weighted Hurdle-N 1132 ALS)



5. Automatic weight adjust system (Automatic Hurdle-N 1132 ALS-Automatic)



OLYMPIA SUPER ALUMINIUM HURDLE N1132 ALS

An All aluminium Hurdle in Square Tube Profile. Comes with a unique telescopic pinch free height adjust system. IAAF Spec strong Ribbed PVC Hurdle board. Easy-Glide Hurdle weight Adjust System. All Aluminium profile, Stainless Steel Nut/ Bolts and Powder Coated gliding weights ensure ultimate weather protection for years of hassle free usage. Bright coloured height and weight indicator stickers. Height Range 0.685m to 1.067m. IAAF Certified.

DO DARE WIN !!

HURDLES

OLYMPIC ALUMINIUM HURDLE N 1132 AL

An all Aluminium Hurdle with a Square profile base and round uprights. IAAF spec strong ribbed PVC hurdle board. Easy-Glide hurdle weight adjust system. Stainless steel NuT- Bolts and powder coated sliding weights ensure ultimate weather protection for years of hassle free usage. Bright coloured height and weight indicator Stickers. Height range 0.685m to 1.067m IAAF CERTIFIED



1. Extra Strong Ribbed PVC Hurdle Board. 2. Easy-Glide Slotted weight adjust system. 3. Superior Welds for years of trouble free use.



ELITE HURDLE UNITIZED N 1132 OHR

Made out of 50mm square tube base, Indented square base frame steel tube for Extra Structural rigidity and to protect indicator scale. Unitized welded to take on beating. Aluminium sliding uprights. Easy selector system to adjust weight to required height. Easy stacking. Adequate toppling force as per IAAF rules. Comes with PVC Bar. Phosphate treated & Powder Coated base. Height range 0.685m to 1.067 m IAAF CERTIFIED



1. Extra Strong Ribbed PVC Hurdle Board. 2. Unique Indented Base Tube Profile for Extra Structural Rigidity.



NATIONAL OLYMPIC HURDLE N 1132 OHS

Made out of 46mm square steel tubes. Unique indented base frame tube profile for superior structural rigidity. Powder Coated Base and Sliding Aluminium Uprights. Adjustable Weights. Available with PVC Bar. Height range 0.685m to 1.067 m



TRACK & FIELD

DO DARE WIN !!

HURDLES

ULTIMO PRO HURDLE N 1132 UPH

Made out of 46mm square steel tubes. Unique indented base frame tube profile for superior structural rigidity. Fixed Weight Hurdle Providing Adequate Toppling Force For Rocker Action Powder Coated Base and Sliding Steel Uprights. Adjustable Weights. Available with PVC Bar. Height range 0.685m to 1.067 m



ULTIMO SUPER HURDLE N 1132 USH

Made out of square steel tubes. Unique base frame tube profile for superior structural rigidity. Powder Coated Base and Sliding Steel Uprights. Available with PVC Bar. Height range 0.685m to 1.067 m



ULTIMO HURDLE N 1132 UHH

Made out of steel tubes. Unique base frame tube profile for superior structural rigidity. Powder Coated Base and Sliding Steel Uprights. Weighted base to Provide Rockmen Action Available with PVC Bar. Height range 0.685m to 1.067 m



TRACK & FIELD

DO DARE WIN !!

HURDLES

CHALLENGER HURDLE N 1132 EF

Economy hurdle with 46 mm square folding legs. Available with adjustable weights, PVC bar and steel sliding tubes. Height range 0.685 m to 1.067m.



TRAINING HURDLE PLYOMETRIC N 1132 PL

A simple scissor type hurdle for Plyometric and Hurdling exercises. Portable & collapsible on impact. Made out of strong steel tubes. Adjusts from 6" to 42" height. Available with PVC Bar.



TRAINING HURDLE N 1132 TG

A light-weight strong hurdle designed for training. Steel sliding tubes and steel frame with easy to operate concealed push buttons for height adjustment. Height range 0.762m to 1.067 m. Available with PVC Bar.



TRACK & FIELD

DO DARE WIN !!

HURDLES

ALUMINUM TRAINING HURDLE N 1132 TAL

All Aluminum superior fixed leg Hurdle. Adjustable height, plastic corners to insert tubes. Available with PVC Bar. Ideal for training.



CLUB ROCKER HURDLE N 1132 RCW

A unique hurdle ideal for High Schools. Made of strong steel frame push button locking device to quickly adjust to your hurdling height. Comes with PVC Bar. The L shaped base controls rocker action. Sealed weights control resistance. Dual tube base ensures structural strength and easy stacking. You just need to adjust height. Height range 0.685 m to 1.067 m.



LITTLE ATHLETICS COLLAPSIBLE HURDLE N1132LA

Collapsible Hurdle made from 1" strong Stainless Steel tubes. Hurdle fully collapses when hit.

Comes with PVC Bar.

Height Increments:

- 45cm
- 60cm
- 68cm
- 76cm



TRACK & FIELD

DO ... DARE ... WIN !!

HURDLES

HURDLE DOLLY

N1132 HCM 10

Accommodates 10 Hurdles. Comes with 2 wheels & powder coated finish.



HURDLE CARTS

N1132 HCM 20

Accommodates 20 Hurdles. Comes with 2 Fixed wheels and 2 universal rotating wheels, powder coated finish.

N1132 HCM 40

Accommodates 40 Hurdles. Comes with 2 Fixed wheels and 2 universal rotating wheels, powder coated finish.



WATER JUMP HURDLE N 1132 WJB

Heavy Duty Steel Profile with telescopic height adjustment system. Water - Resistant Polymer Top. Painted to IAAF Rules. 3.66m wide with height range of 0.762m to 0.914m. Weight within IAAF Rules.



● Steel Undergate Barrier optional extra. Available on order.

STEEPLE CHASE HURDLE N 1132 STH

Heavy Duty Steel Profile with telescopic height adjustment system. Water - Resistant Polymer Top. Painted to IAAF Rules. 3.94 m wide with height range of 0.762m to 0.914m. Weight within IAAF Rules.



TRACK & FIELD

DO ... DARE ... WIN !!

JUMP STANDARDS



(Photo-1)



(Photo-2)



(Photo-3)



HIGH JUMP STAND OLYMPIC PRO N 1129 OPR

Anodized uprights with built-in leveling system.

The principal section is fabricated out of a purpose designed Semi- Hollow extruded aluminium profile.

(140mm x 59mm x 5.5mm thickness)

- Telescopic tube is made out of 41.5mm square aluminium profile of 3mm thickness and capped with high quality plastic (Photo-1).
- Zinc-Plated steel Crossbar peg holders. (photo-2)
- Heavy duty powder coated steel base with wheels and levelers. Sleeve is welded on base to provide stability to uprights. (photo-3)

IAAF CERTIFIED

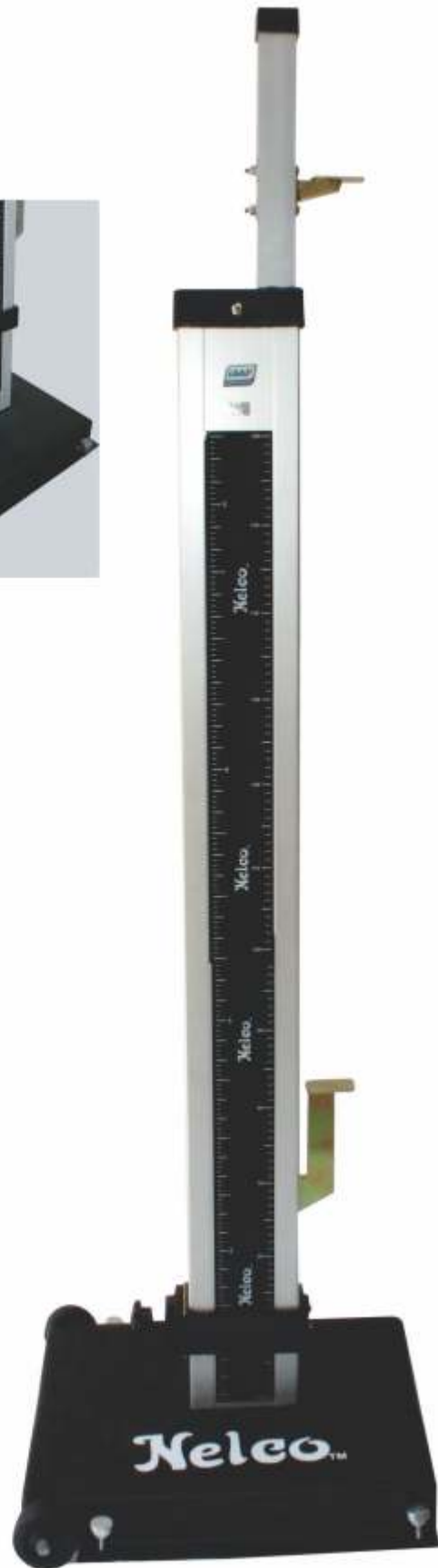

TRACK & FIELD

DO DARE WIN !!

JUMP STANDARDS



OLYMPIC ROLL AWAY HIGH JUMP ALUMINIUM STANDARD N 1129 DD

Uprights are made of strong, corrosion-resistant 40mm square aluminium tubes, mounted on square low steel base. Stand is ultimate in quality, durability & convenience. Uprights adjust from 60cm to 254cm. As per IAAF rules.

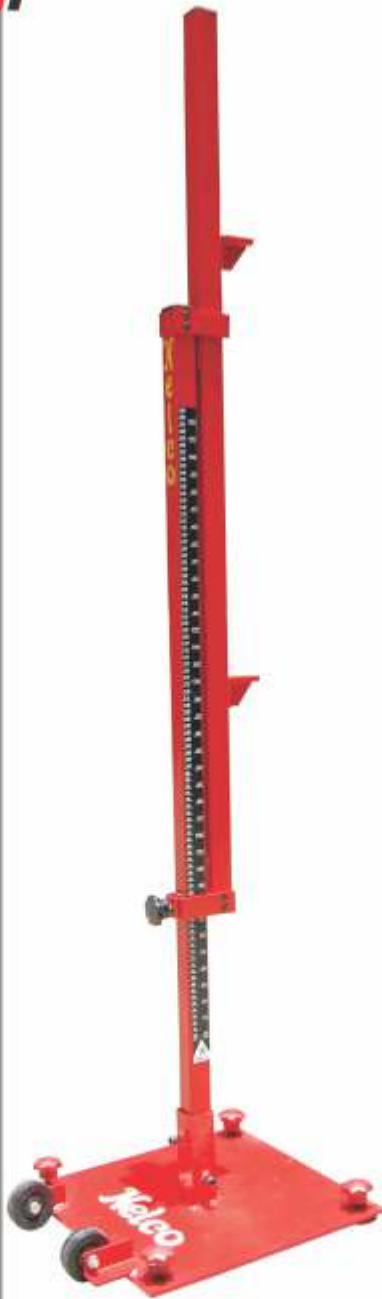

ELITE ROLL-AWAY STEEL HIGH JUMP STANDARD N 1129 ES

Made out of square strong steel tubes. 40mm square tubes mounted on square low steel bases. Convenient to handle. Ideal for high school. Uprights adjust from 60cm to 254 cm



COMPETITION N 1129D

Aluminium construction with weighted steel T-Base. PVC scale. Maximum height 2.54m

TRACK & FIELD

DO DARE WIN !!

JUMP STANDARDS



SCHOOL STEEL

Steel construction with weighted steel base.
PVC scale. Power coated.
N 1129 E Maximum Height 2.06m
N 1129 DA Maximum Height 2.54m



SCHOOL ROLL-AWAY N 1129DR

Steel construction with roll-away base.
Maximum height 2.54m

TRACK & FIELD

DO DARE WIN !!

JUMP STANDARDS



OLYMPIC PRO POLE VAULT STANDARD N 1130 OPR

Anodized aluminium uprights. Sturdy steel bases to eliminate wobble. Roller wheels move in steel channel base. PVC Scales As Per IAAF Rules, Height adjustable upto 6.40 m

Aluminium uprights with built-in leveling system. The principal section is fabricated out of a purpose designed semi-hollow extruded aluminium profile (140mm x 59mm x 5.5mm thickness). Maximum height upto 6.40m.

IAAF Certified.



- Telescopic tube is made out of 41.5 mm square aluminium profile of 3mm thickness.



- Heavy cast Aluminium sliding clamp with top quality plastic knob to adjust height.



- Super heavy-duty steel base equipped with wheels & synthetic rollers for stable movement of post within the steel side rails.

JUMP STANDARDS



COMPETITION POLE VAULT STANDARD N 1130 CPR

Powder coated steel uprights. Sturdy steel bases to eliminate wobble. Roller wheels move in steel channel base. PVC Scales as per IAAF Rules. Maximum height upto 5.80m.



SCHOLASTIC POLE VAULT STANDARD N 1130 VS

Powder coated steel uprights. Sturdy steel bases to eliminate wobble. Roller wheels move in steel channel base. PVC Scales as per IAAF Rules. Maximum height upto 4.80m.

TRACK & FIELD

DO DARE WIN !!

VERTICAL JUMPS

MAXIMA VAULTING POLES N 4000 PVA

Fiberglass Vaulting Pole. Made in USA with "FLEXITECH" technology.
Length 4.25m.
Weight Range 130 LBS To 150 LBS.
"Signature" Tip.



OLYMPIC PRO FIBERGLASS CROSS BAR

New Nelco Fiberglass Cross Bars with bright colours which are highly visible to athletes. Made in U.S.A.
New Rounded cross bars ends to IAAF rules.

IAAF CERTIFIED

N 1126 AF 4.00 m

N 1126 BF 4.52 m



SCHOLASTIC ALUMINIUM CROSS BARS

Circular with square plastic ends. 25mm dia.

N 1127 A 4.00 m

N 1127 B 4.52 m



TWO-PIECE ALUMINIUM FOLDING CROSS BARS

Circular with square plastic ends. 25mm dia.
Push-Button type joint system.

N 1127 E 4.00 m

N 1127 F 4.52 m



ELASTIC TRAINING CROSS BAR

N 1126 ET



POLE VAULT LANDING AREAS

POLE VAULT LANDING AREAS



NELCO ADVANTAGE

Skins made from both-side vinyl-coated non-tearing weather-proof fabric.
 Top pad is encased in non-tearing, spike-proof breather mesh.
 Purpose designed multi-density, beehive inspired foam lattice construction for safe and soft landing.
 Dual folded, multi-layered stitching, top quality velcro and zippers ensure years of trouble free usage.

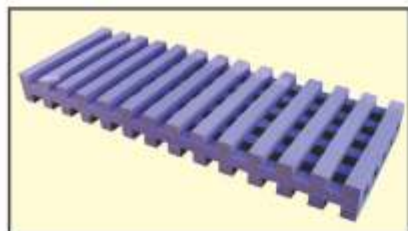

FOAM LATTICE BEEHIVE CONSTRUCTION



NON-TEARING, SPIKE-PROOF BREATHER MESH.



NON-TEARING, WEATHER-PROOF VINYL FABRIC.

TRACK & FIELD

DO ... DARE WIN !!

POLE VAULT LANDING AREAS

TRACK & FIELD

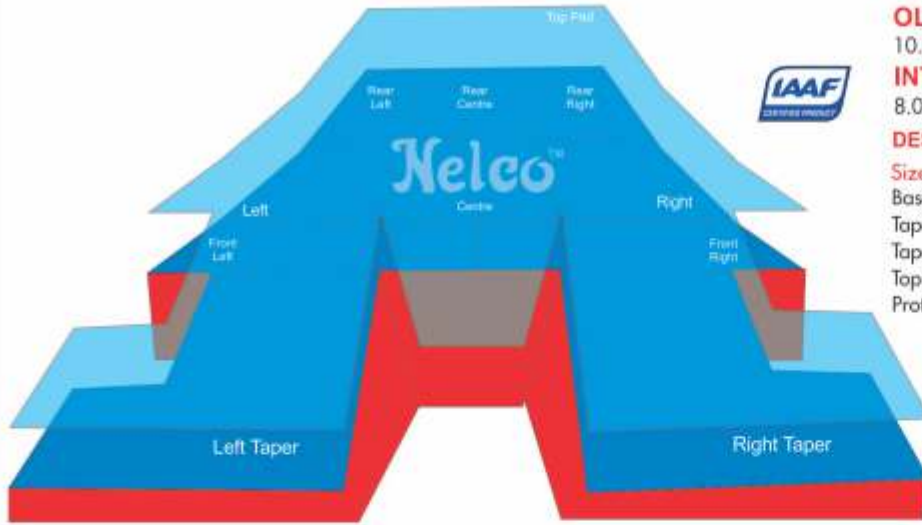

OLYMPIC PRO N 2100 OPV
10.00M X 6.60M X 85 CM

INTERNATIONAL OLYMPIC N 2100 PV
8.00M X 6.00M X 81CM
IAAF CERTIFIED

DESCRIPTION :

Size	Qty.
Base Unit	8
Tapered Unit Front Left	1
Tapered Unit Front Right	1
Top Pad (7cm)	1
Protection Pad	2

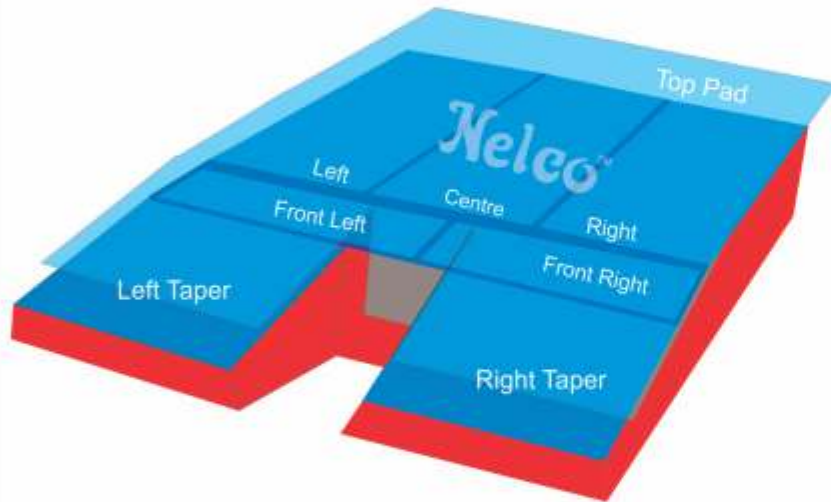

NATIONAL OLYMPIC N 2100 NV
7.30M X 5.50M X 81CM

STADIUM OLYMPIC N 2100 SV
7.00M X 5.00M X 81CM

ELITE OLYMPIC N 2100 EV
6.80M X 5.00M X 75 CM

COMPETITION COLLEGE N 2100 CCV
6.50M X 5.00M X 71CM

COMPETITION SCHOOL N 2100 CSV
6.30M X 5.00M X 65CM

DESCRIPTION :

Size	Qty.
Base Unit	5
Tapered Unit Front Left	1
Tapered Unit Front Right	1
Top Pad (7cm)	1

N2100 OSP

OPTIONAL VINYL ENCASED FOAM PROTECTION PADS FOR JUMP STANDARDS.

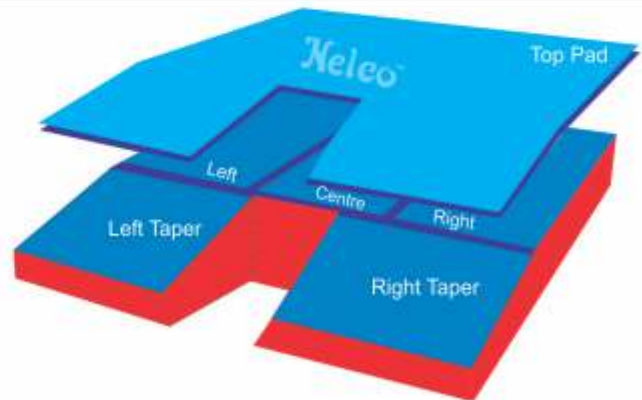
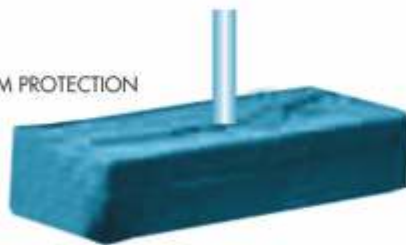

TRAINING N 2100 TAV
5.00M X 5.00M X 61CM

DESCRIPTION :

Size	Qty.
Base Unit	3
Tapered Unit Front Left	1
Tapered Unit Front Right	1
Top Pad (7cm)	1

POLEVAULT TROUGH OLYMPIC ALUMINIUM

N 1130 OI
Box
N 1130 OIL
Lid



DO ... DARE ... WIN !!

HIGH JUMP LANDING AREAS

HIGH JUMP LANDING AREAS



NELCO ADVANTAGE

Skins made from both-side vinyl-coated non-tearing weather-proof fabric.

Top pad is encased in non-tearing, spike-proof breather mesh.

Purpose designed multi-density, beehive inspired foam lattice construction for safe and soft landing.

Dual folded, multi-layered stitching, top quality velcro and zippers ensure years of trouble free usage.

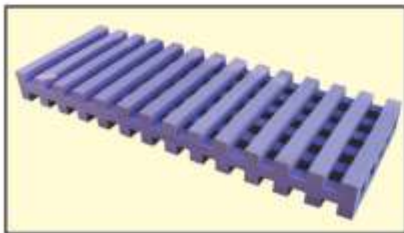

FOAM LATTICE BEEHIVE CONSTRUCTION



NON-TEARING, SPIKE-PROOF BREATHER MESH.

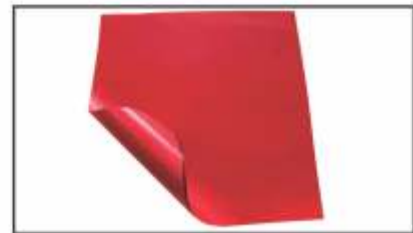

NON-TEARING, WEATHER-PROOF VINYL FABRIC.

TRACK & FIELD

DO DARE WIN !!

HIGH JUMP LANDING AREAS

TRACK & FIELD

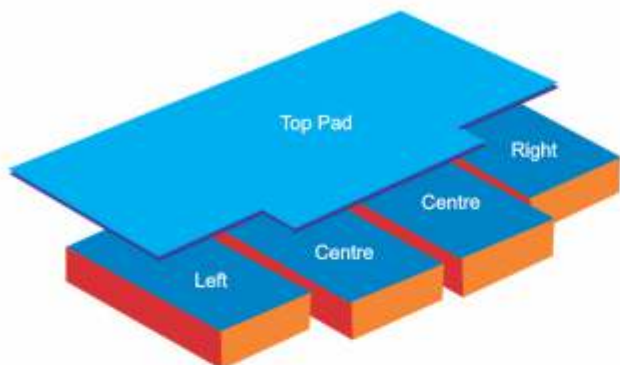

INTERNATIONAL OLYMPIC PRO N 2100 OHJ
7.20M X 4.00M X 71 CM

DESCRIPTION :

Size	Qty.
Base Unit Center	2
Base Unit Left	1
Base Unit Right	1
Top Pad (7cm)	1

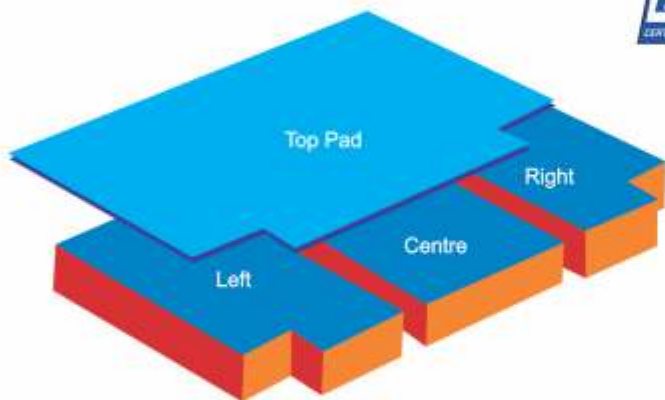

INTERNATIONAL OLYMPIC N 2100 HJ
6.00M X 4.00M X 71 CM
(IAAF Certified)

NATIONAL OLYMPIC N 2100 NHJ

5.50M X 3.00M X 66 CM

STADIUM OLYMPIC N 2100 SHJ

5.00M X 3.00M X 61 CM

ELITE OLYMPIC N 2100 EHJ

5.00M X 2.50M X 61 CM

DESCRIPTION :

Size	Qty.
Base Unit Center	1
Base Unit Left	1
Base Unit Right	1
Top Pad (7cm)	1



COLLEGE COMPETITION N 2100 CCHJ

4.50M X 2.20M X 55 CM

HIGH SCHOOL COMPETITION N 2100 HCHJ

4.00M X 2.00M X 50 CM

SCHOLASTIC N 2100 SCHJ

3.60M X 2.00M X 45 CM

DESCRIPTION :

Size	Qty.
Base Unit	1
Top Pad	1

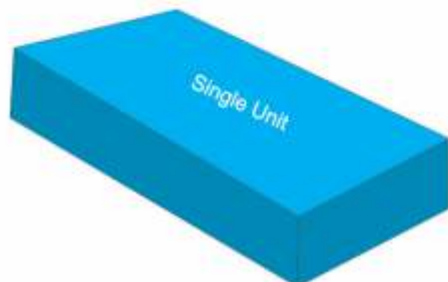

ELEMENTARY N 2100 EHJ

3.60M X 1.80M X 40 CM

DESCRIPTION :

Single Unit Construction

DO DARE WIN !!

HIGH JUMP LANDING AREAS



GARAGE SYSTEMS FOR LANDING AREAS

- Super Structure Made From Galvanized Steel Tubes
- Covered With Galvanized Sheets
- Combination Of Free Moving and Fixed Wheels For Easy Mobility

N 2100 GHJ FOR IAAF CERTIFIED HIGH JUMP PIT

N 2100 GPV FOR IAAF CERTIFIED POLE VAULT PIT

- Other Sizes Available on Order

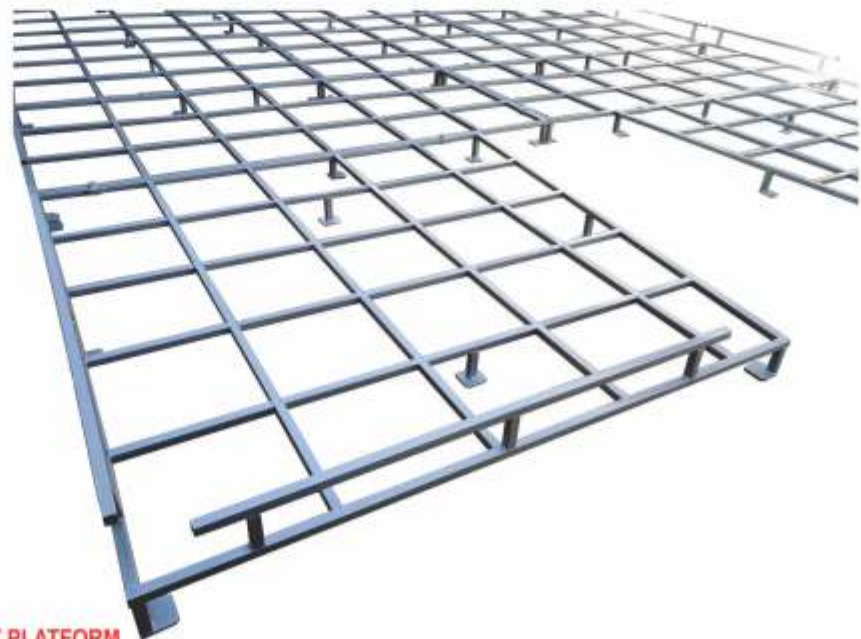

TUBULAR STEEL POLE VAULT/HIGH JUMP PIT PLATFORM

JAVELINS



OLYMPIA COMPETITION JAVELINS

Competition Grade Javelins made out of extra-strong purpose-built "DURALUMINIUM" for enhanced rigidity. Steel tip and cotton cord (polyester core) grip. A high performance Javelin for top throwers.

OLYMPIA ODYSSEY	90	800gms/90mts	N 8090 CJT
OLYMPIA JUPITER	80	800gms/80mts	N 8080 CJT
OLYMPIA ULTIMO	70	800gms/70mts	N 8070 CJT
OLYMPIA AEROFLOAT	60	800gms/60mts	N 8060 CJT
OLYMPIA ODYSSEY	75	600gms/75mts	N 6075 CJT
OLYMPIA JUPITER	65	600gms/65mts	N 6075 CJT
OLYMPIA ULTIMO	55	600gms/55mts	N 6055 CJT
OLYMPIA AEROFLOAT	50	600gms/50mts	N 6050 CJT
OLYMPIA ODYSSEY	80	700gms/80mts	N 7080 CJT
OLYMPIA AEROFLOAT	60	700gms/60mts	N 7060 CJT



CLUB TRAINING JAVELINS

Designed for training at school level.

N 1112 A	25 mm Dia	800 gms
N 1112 B	25 mm Dia	700 gms
N 1112 C	25 mm Dia	600 gms
N 1112 D	25 mm Dia	500 gms
N 1112 E	25 mm Dia	400 gms



CHALLENGER COMPETITION JAVELINS

Made out of high strength aluminium alloy to IAAF rules. Javelins are designed to give maximum advantage to thrower. A performance Javelin for top throwers.

N 8000 CCJ	800 gms
N 7000 CCJ	700 gms
N 6000 CCJ	600 gms
N 5000 CCJ	500 gms
N 4000 CCJ	400 gms

JAVELINS



JAVELIN PRACTICE BALLS

Practice Balls of 68 mm dia rubber shell filled with lead pellets.

Code	Weight
N 1119 SR	400 gms
N 1119 RR	600 gms
N 1119 OR	800 gms



NOCKEN BALLS

The ideal ball for javelin throwers.

N 2302 A	400 gm
N 2302 B	600 gm
N 2302 C	800 gm



JAVELIN ARC

N 1116 A Painted Steel ARC made to IAAF rules.



JAVELIN CART

N 1110 JEC Powder Coated Cart

JAVELIN RACK

N 1110 JE Collapsible Design. Powder Coated



ACCESSORIES

PVC FLAGS N 2301 HC

Available in assorted colours.



ARENA BOX (DISTANCE MARKER)

N1131 DMF FIBER GLASS
Unique 3 dimensional construction for
all round visibility.



ARENA BOX (DISTANCE MARKER)

N 1131 DM ALUMINIUM

Unique 3 dimensional construction for all round visibility.
(Powder Coated)



LANE - MARKER BOX

N 1131 LMF FIBER GLASS
Unique 3 dimensional construction
for all round visibility.



LANE - MARKER BOX

N 1131 LM ALUMINIUM
Unique 3 dimensional construction
for all round visibility.
(Powder Coated)

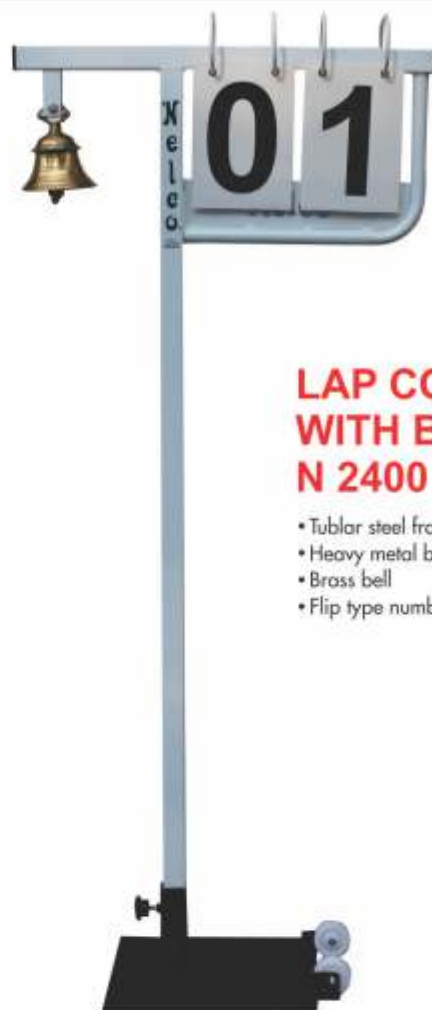

LAP COUNTER WITH BELL N 2400 LAR

- Tubular steel frame
- Heavy metal base with wheels
- Brass bell
- Flip type numbers



SCORE BOARDS N 2400 SB

- Made to Order.
Available for various applications.
- Weighted heavy base.
 - Flip type numbers.

TRACK & FIELD

DO ... DARE ... WIN !!

ACCESSORIES



RELAY BATONS PLASTIC SENIOR N 1132 AP/BP

N 1132 SET OF 8 COLOURS
N 1132 SET OF 6 COLOURS



RELAY BATONS ALUMINIUM

Anodised finish with silk screening
N 1132 A SET OF 6 COLOURS IAAF CERTIFIED
N 1132 B SET OF 8 COLOURS IAAF CERTIFIED
N 1132 AJ JUNIOR SET OF 6 COLOURS
N 1132 BJ JUNIOR SET OF 8 COLOURS



MEASURING TAPES N 1133

FIBERGLASS : Available in open reel & closes reel models (10 to 100 m)
STEEL : Available in 13 mm wide open reel mode (10 to 100 m)



MEASURING WHEEL

N 1133 ASS Plastic wheel
N 1133 BSS Steel Wheel
(Wheel calibration 1m)



STARTER ROSTRUM N 1120 SR

Made out of steel tubes, anti-slip steel platform and large wheels for easy movement.

• Not available for Sale in India

DO ... DARE WIN !!

TRACK & FIELD

ACCESSORIES

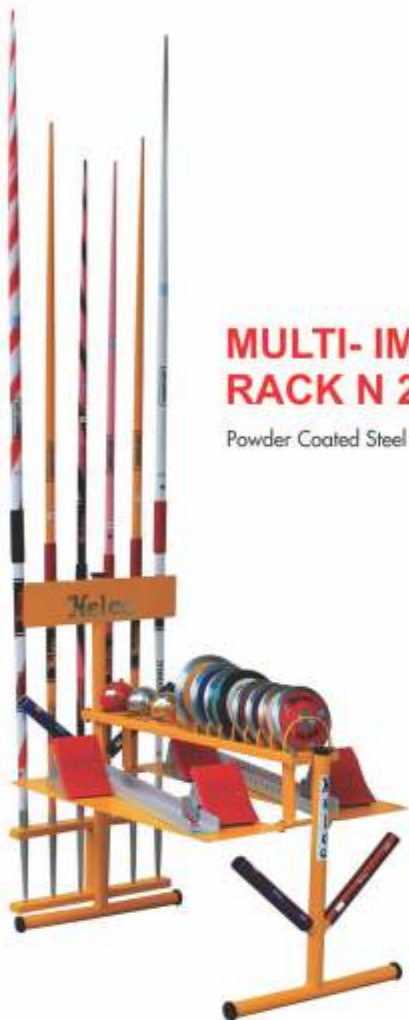

MULTI- IMPLEMENT RACK N 2006 MIC

Powder Coated Steel Construction

FOUL INDICATORS N 1132 FM

Made from light weight steel and powder coated for long life.

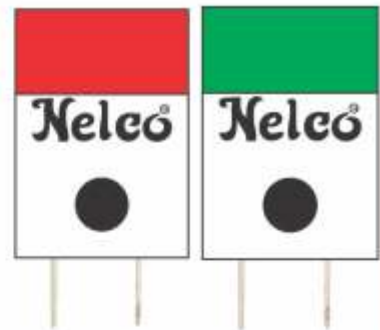

DISCUS / SHOT MARKERS N 1132 DM

Made from light weight steel and powder coated for long life.



RUNWAY MARKERS N 1132 RM

Made from light weight steel and powder coated for long life.

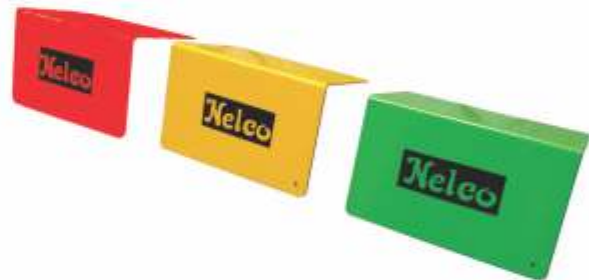

MEASURING FRAME FOR LONG JUMP/TRIPLE JUMP N 1132 LG

Fiber Glass Construction for Durability & Long Life

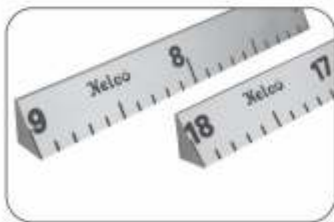

TRACK & FIELD

DO ... DARE ... WIN !!

ACCESSORIES

VICTORY STAND (INDIVIDUAL) N 2006 VSI

VICTORY STAND (TEAM) N 2006 VST

Sturdy Steel Construction With Rubber Top



POLE VAULT/CROSSBAR RACK N 2006 PCR



WIND SOCK N 2006 WS



TRACK & FIELD

DO DARE WIN !!

ACCESSORIES

ATHLETE BENCH



N 2006 AB10 10 SEATER

N 2006 AB12 12 SEATER

DRINKS/REFRESHMENT CART N 2006 DFC

- Customized Table Top Attachments for Bottles & Containers Available on Request



DO DARE WIN !!

TRACK & FIELD

ACCESSORIES



**Judges/Time Keeper's Stand
N 2006 JSC**

**HURDLE MEASURING BAR
N 2006 HMB**



**HIGH JUMP
MEASURING BAR
N 2006 HJMB**



**FINISHING POST STEEL
N 2006 FPS**



**CROSSBAR BAR PLACER
N1128C**

TRACK & FIELD

DO ... DARE WIN !!

FIELD EQUIPMENT

TRACK & FIELD

DISCUS & SHOT CIRCLE

Made out of steel to IAAF specifications with spider pattern construction for accurate adjustment for installation.

- N 1110 F Discus
- N 1120 F Shot
- N 1125 H Hammer

- Options:
- Hot Galvanizing.
 - Attachment for Toe Board.



ALUMINIUM TOE BOARDS

- N 1120 AL LEVEL PAD
- N 1120 ALDP DEPRESSED PAD



STEEL TOE BOARDS

Fabricated steel frame. Powder coated.

- N 1120 ST LEVEL PAD
- N 1120 STSP DEPRESSED PAD



WOODEN TOE BOARD

MADE FROM LAMINATED WOOD

- N 1120 G



FIBER GLASS TOE BOARD

MADE FROM TOUGHENED FIBER GLASS

- N 1120 FG



DO ... DARE WIN !!

FIELD EQUIPMENT

TRACK & FIELD



TAKE OFF TRAY SYSTEM

Made out of Galvanized steel to IAAF specifications.

- Consists of Tray, Take Off Board and Plasticine Board
- Unique adjustment for leveling

N 1120 TTS



LONG JUMP TAKE OFF BOARD N 1120 H

Made out of selected laminated wood and painted to resist weather.



SHOT PUT RETURNING CHANNEL

Made out of steel to IAAF specifications. (18m)

N 1120 SRC

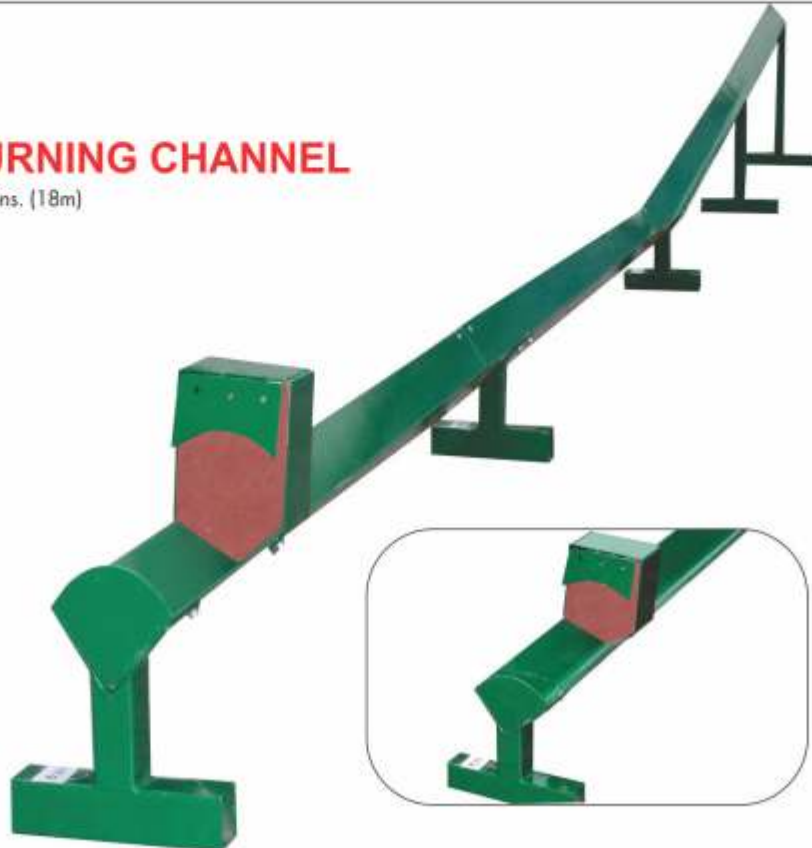

DO DARE WIN !!

FIELD EQUIPMENT

DISCUS CAGE OLYMPIC N 1110 JAA

- 4" Curved M.S. Poles attached to in-ground sleeves with hinges.
- Very easy to assemble and dismantle.
- Pole to Pole arm attachments for extra stability.
- Multiple pulleys on each Pole for unhindered movement of net on flexible steel wires.
- IAAF Spec netting, made from protected nylon.

N 1110 JAASS

Option available for complete Stainless Steel construction.



HAMMER CAGE OLYMPIC N 1125 GG

- 4" Curved M.S. Poles attached to in-ground sleeves with hinges, for easy assembly and dismantling.
- Pole to Pole Arm Attachments for Stability.
- Multiple pulleys on each Pole for unhindered movement of net on flexible steel wires.
- Extra large rubber encased wheels on gates for easy stress free movement.
- IAAF Spec netting made from UV protected nylon.

N 1125 GGSS

Option available for complete Stainless Steel construction.

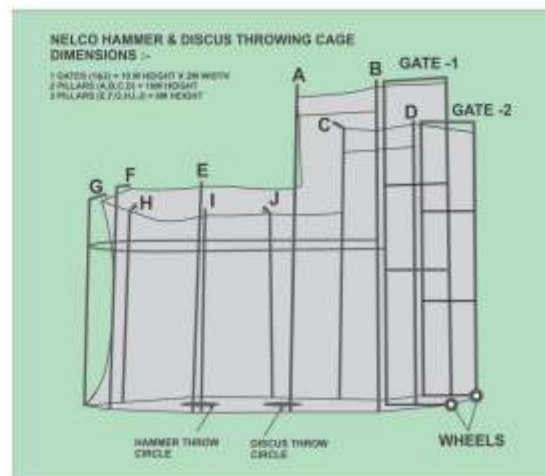

DO DARE WIN !!

TRACK & FIELD

CONES

MARKER CONES

NAC-001	4"
NAC-002	6"
NAC-003	9"
NAC-004	12"
NAC-005	15"
NAC-006	18"

- Made from strong PVC
- Light weight cones with square base for stability



SAUCER CONES

NAC-016

- Made from strong and flexible PVC.



SAUCER CONE SET

NAC-016S

- Set of 50 saucer cones in 5 colours consisting of 10 of each colour.
- Come with a storage stand.



DOMES MARKER SET

NAC-019

- Made of soft plastic
- Come in a set of 40 dome markers in 4 colours consisting of 10 of each colour.



RUBBER MEDICINE BALLS

1 kg	N2400 MA
2 kg	N2400 MB
3 kg	N2400 MC
4 kg	N2400 MD
5 kg	N2400 ME
6 kg	N2400 MF
7 kg	N2400 MG
8 kg	N2400 MH
9 kg	N2400 MI
10 kg	N2400 MJ

- One piece rubber molded medicine balls with incased valve for air adjustment.
- Available in assorted colours.



SINGLE HANDLE RUBBER MEDICINE BALLS

3 kg	N2400 MCS
4 kg	N2400 MDS
5 kg	N2400 MES

- Rubber molded medicine balls.
- Available in assorted colours.



DUAL HANDLE RUBBER MEDICINE BALLS

6 kg	N2400 MFD
7 kg	N2400 MGD
8 kg	N2400 MHD
9 kg	N2400 MID
10 kg	N2400 MJD

- Rubber molded medicine balls.
- Available in assorted colours.



**REFEREE FLAGS
LINESMAN FLAG FOR FOOTBALL**

- NAM 048 Red Colour
- NAM 049 Yellow Colour
- NAM 050 Checkered



**PVC FLAGS (SET OF 12PCS)
(AVAILABLE IN ASSORTED COLOURS)**

PVC FLAGS
N 2301 HC

Available in assorted colours.

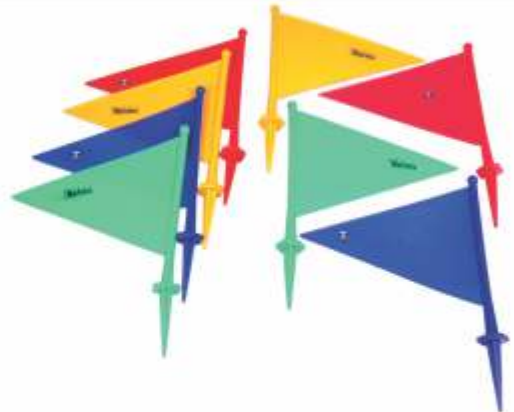

SPORTS MOUTH GUARDS

- SENIOR (25PCS PER BOX) N2001 AMG
- JUNIOR (25PCS PER BOX) N2001 BMG
- DOUBLE (26PCS PER BOX) N2001 CMG



WRIST EXERCISERS

POWER GRIP ELITE MODEL N1138 EL



WHISTLES WITH LANYARDS

- Senior Black Whistle (Box of 50 Pcs)
- FX - Pealess Whistle (Box of 25 Pcs)

- N2001 SR
- N2001 FX



SPEED & AGILITY TRAINING

DO DARE WIN !!

SKIPPING ROPES



NAJ 001
Weighted aluminium handles,
ball bearings & leather rope.



N1139 WL
Wooden Handles, swivels & leather rope



NAJ 005
Plastic weighted handles, foam grip,
ball bearings & PVC rope



NAJ 015
Wooden handles, ball bearings &
nylon rope



NAJ 020
Plastic handles & PVC rope - Speed Rope

N1139D
Keep Fit swivel action adjustable length rubber cord



N1139E
Family Fitness PVC cord



DO DARE WIN !!

SPEED & AGILITY TRAINING

SPEED CHUTE

NAR-001 40"
 NAR-002 48"
 NAR-003 54"

- Ultimate resistance tool helps in improving speed, stamina, strength and acceleration.
- Comes in a carry bag.



SHOULDER RESISTANCE HARNESS

NAR-005

- Helps build stamina, strength and power.
- Includes a 10' belt attached to a shoulder harness.
- Comes in a carry bag.



DUAL RESISTANCE HARNESS

NAR-006

- Includes a cord attached to a belt on both ends.
- Comes in a carry bag.



SPEED SLED

NAR-012

- Improves speed, Acceleration and leg strength
- Includes a powder coated steel sledge and belt attached to a shoulder harness
- User is required to put add-on weights to sledge.



DO DARE WIN !!

SPEED & AGILITY TRAINING

PRO ADJUSTABLE HEIGHT AGILITY HURDLES

- NAH 001 Height Adjustable From 12" to 15" or 18"
- NAH 002 Height Adjustable From 21" to 24", 27", 30", 33" or 36".
Made of Strong PVC with Detachable
Corners for ease of storage and mobility.
Calibration provided on uprights for
easy height adjustment.



MULTI HEIGHT AGILITY HURDLES

- NAH-004 Comes in one color.
- NAH-005 Comes in dual colors.
- Made of strong PVC
- Hurdle can be adjusted from 6" to 12" by twisting
the legs to reverse direction.



CLUB AGILITY HURDLES

- NAH - 006 6"
- NAH - 007 9"
- NAH - 008 12"
- NAH - 009 15"
- NAH - 010 18"
- Made of strong PVC



DO ... DARE WIN !!

PRO SPEED LADDER

NAL-003 4 m
NAL-004 8 m

- Made from 20" wide flat plastic rungs and nylon tape.
- Distance between strips can be adjusted.
- Comes in a carry Bag.



CLUB SPEED LADDER

NAL-005 4 m
NAL-006 8 m

- Made from 16" wide flat plastic rungs and nylon tape.
- Distance between strips can be adjusted.
- Comes in a carry bag.



SPEED RING LADDER

NAL-013

- Consists of 12 rings of 18" dia attached together with velcro tape.
- Rings can be adjusted to create endless formations.
- Comes in a carry bag.



SLALOM POLE ELEMENTARY

NAP-001

- 1.25" dia x 68" length PVC poles.
- Powder Coated metal spikes at the bottom.
- Available in assorted colours.



SLALOM POLE CENTER SPRING

NAP-004

- Two 1.25" dia x 30" length PVC poles connected with spring at the middle.
- Powder coated metal spikes at the bottom.
- Available in assorted colours.



OUTDOOR COACHING KIT

NAK-002

- 6 spiked PVC poles 1.25" dia. x 60" length
- 3 normal PVC poles 1.25" dia x 60" length
- 6 plastic clamps
- Comes in a carry bag.

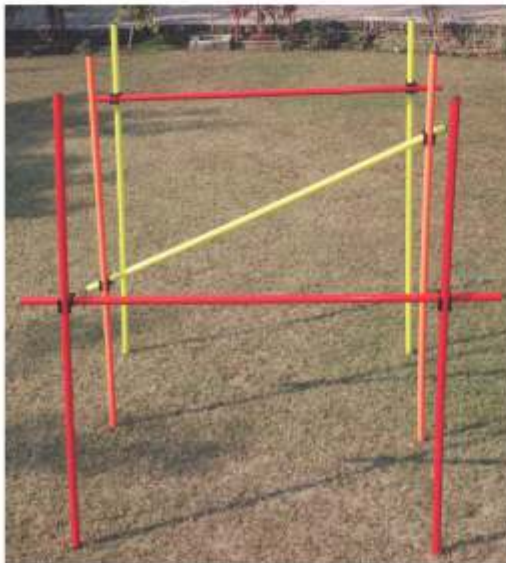

TCHOUKBALL FRAME

NS 1000 TF
POWDER COATED FRAME
SIZE : 1M x 1M



DO ... DARE ... WIN !!

SPEED & AGILITY TRAINING

HOOPS //

- NAM 051 18" Dia
- NAM 052 24" Dia
- NAM 053 36" Dia
- Hollow PVC tubes of 20 mm dia.

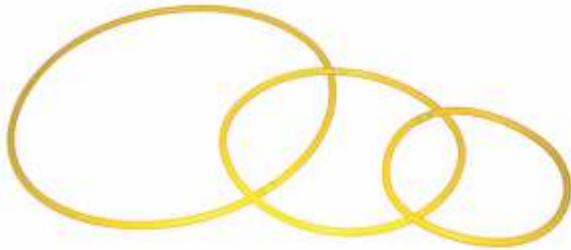

TENNIKOIT RINGS //

- NAE-008
- 7" dia sponge filled rings
- Available in assorted colours

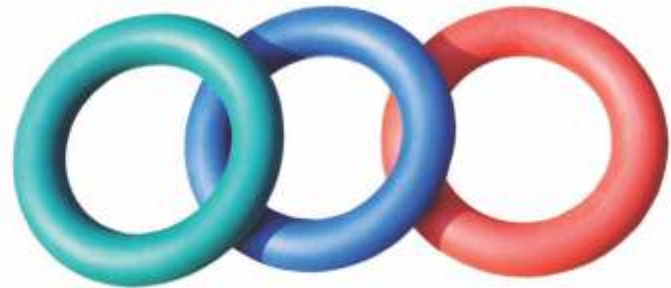

GYMNASTIC CLUBS //

- NAE-001
- Plastic clubs in assorted colours
- 44 cm official size
- 155 gms regulation weight



FRISBEE //

- NAE-006
- PLASTIC FLYING DISC



TRAINING PINNIES //

- NAM-003
- Synthetic vests with elastic at the sides
- Available in assorted colours
- Available in S,M,L& XL sizes.
- (Set of 12 Pcs)



REACTION BALL //

- NAM-004 Small Dia
- NAM-005 Large Dia
- Non-Marking 6 sided rubberised balls.
- Unpredictable bounce helps in quick judgement.



POP-UP GOAL

NAG-007 30" dia
 NAG-008 42" dia
 NAG-009 66" dia

- Fully collapsible pop-up goal
- Suitable for backyard ball games
- Comes in a carry bag



CORNER FLAG

CLUB

NAS-007

- Pvc flag pole 1" dia x 60" length.
- Powder coated spike base for inground insertion.
- Available with yellow or red coloured flags.



PASSING ARC

CLUB

NAS-004

- Size: 12" high x 20" wide.
- Traditional semi-circular passing arc.
- Heavy duty powder coated metal spike on base for inground insertion.



KICK MAN

NAS-009

- 6' high x 2' wide strong construction
- Weighted base with spikes for inground insertion
- Very easy to assemble.
- Comes in a carry bag.



CORNER FLAG

PRO

NAS-008

- Pvc flag pole 1" dia x 60" length.
- Power coated spring loaded spike base for inground insertion.
- Available with yellow or red coloured flags.



DO ... DARE ... WIN !!

SPEED & AGILITY TRAINING

COMPETITION WEIGHT LIFTING



EQUIPMENT PARTNER TO THE INDIAN WEIGHT LIFTING FEDERATION



WEIGHT LIFTING

DO DARE WIN !!

PRO SERIES COMPETITION BARBELL SETS

MEN'S OLYMPIC SETS

OLYMPIC PRO COMPETITION BARBELL SET COLOURED WITH COMPETITION BAR AND PRO IWF COLOUR BUMPER PLATES

190 KG. N 1134 PRCA

140 KG. N 1134 PRCC

WOMEN'S OLYMPIC SETS

OLYMPIC PRO COMPETITION BARBELL SET COLOURED WITH COMPETITION BAR AND PRO IWF COLOUR BUMPER PLATES

185 KG. N 1134 WNA

135 KG. N 1134 WNC

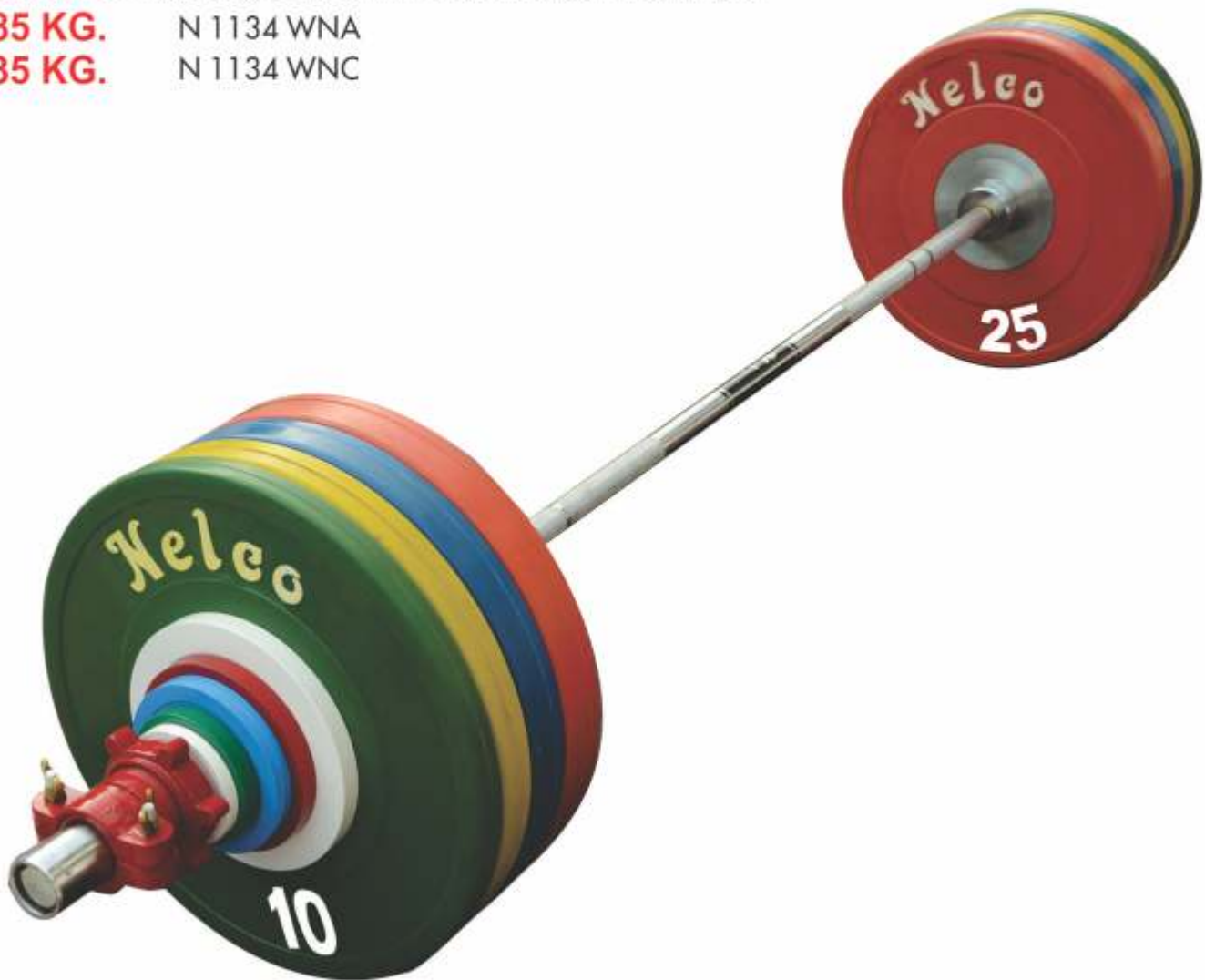

INTERNATIONAL OLYMPIC COMPETITION BARBELL SETS

MEN'S OLYMPIC SETS

INTERNATIONAL OLYMPIC COLOURED COMPETITION RUBBERISED BARBELL SET WITH COMPETITION BAR

190 KG. N 1134 OCC

140 KG. N 1134 OCS

WOMEN'S OLYMPIC SETS

INTERNATIONAL OLYMPIC COLOURED RUBBERISED BARBELL SET WITH COMPETITION BAR

185 KG. N 1134 CCW

135 KG. N 1134 CSW



SPARE PRO SERIES COMPETITION BUMPER PLATES

OLYMPIC PRO COMPETITION RUBBERISED BUMPER PLATES
IWF COLOURED WITH ZINC PLATED METAL HUBS

Code	Colour	Dia
10 KG.	GREEN	N 1134 NPA
15 KG.	YELLOW	N 1134 NPB
20 KG.	BLUE	N 1134 NPC
25 KG.	RED	N 1134 NPD



SPARE INTERNATIONAL BUMPER PLATES

INTERNATIONAL OLYMPIC RUBBERISED BUMPER PLATES
COLOURED WITH BRASS INSIDE BUSH

Code	Colour	Dia
10 KG.	GREEN	N 1134 KC
15 KG.	YELLOW	N 1134 LC
20 KG.	BLUE	N 1134 MC
25 KG.	RED	N 1134 NC



SPARE COMPETITION METAL PLATES //

METAL PLATES IN DIFFERENT COLOURS AS PER IWF RULES
FOR USE WITH ALL TYPES OF BARBELL SETS

Code	Colour	Dia
500 GMS.	WHITE	N 1134 FIR
1.00 KG.	GREEN	N 1134 OIR
1.50 KG.	YELLOW	N 1134 KIR
2.00 KG.	BLUE	N 1134 HIR
2.50 KG.	RED	N 1134 IIR
5.00 KG.	WHITE	N 1134 JIR



OLYMPIC COLLARS N1134OC

- IWF Specification Collars
- 2.5 Kg each.
- Easy to load onto bar.
- Designed to hold even on high impact drops.



SPARE 50MM SPRING COLLAR N1134OSC



DO DARE WIN !!

WEIGHT LIFTING

OLYMPIC COMPETITION BARS - MEN //



- 2.2 MTRS. MEN'S BAR FOR WEIGHT LIFTING - ELITE COMPETITION
- 2.2 MTRS. MEN'S BAR WEIGHT LIFTING - PRO CHAMPIONSHIP

N 1134 EC
N 1134 PC

OLYMPIC COMPETITION BARS - WOMEN //



- 2.01 MTRS. WOMEN'S BAR FOR WEIGHT LIFTING - ELITE COMPETITION
- 2.01 MTRS. WOMEN'S BAR WEIGHT LIFT - PRO CHAMPIONSHIP

N 1134 ECW
N 1134 PCW

OLYMPIC TRAINING BARS - 50 MM BORE



WT. LIFTING TRAINING ROD 92 CM. (50 MM SLEEVE)N1134PRA
WT. LIFTING TRAINING ROD 120 CM. (50 MM SLEEVE)N1134PRB
WT. LIFTING TRAINING ROD 152 CM. (50 MM SLEEVE)N1134PRC
WT. LIFTING TRAINING ROD 182 CM. (50 MM SLEEVE)N1134PRD



EZ KURL BAR 117.5 CM. (50 MM SLEEVE)N1134PRE
EZ KURL BAR 148.5 CM. (50 MM SLEEVE)N1134PRF



TECHNIQUE BAR - ALUMINIUM (50 MM SLEEVE)N1134TQB
(72" - 7 KG approx.)

TRICEP BAR (50 MM SLEEVE)N1134TCP



BOX BAR (50 MM SLEEVE)N1134BXB



WEIGHT LIFTING

DO ... DARE ... WIN !!

COMPETITION WEIGHT LIFTING PLATFORM

COMPETITION - 4 M X 4 M X 100 MM N2006WLPC

CONSTRUCTION :

- MADE OF SEASONED HARDWOOD
- 4 METAL INSERTS THROUGH HARDWOOD PLANKS FOR HOLDING PLATFORM TOGETHER
- ANGLE IRON CORNERS ON ALL CORNERS FOR TETHERING TO FLOOR
- ANTI - SLIP COATING ON TOP PLAYING AREA



TRAINING WEIGHT LIFTING PLATFORM

TRAINING - 4 M X 4 M X 25 MM N2006WLR
 3 M X 3 M X 25 MM N2006WLM1
 3 M X 2.5 M X 25 MM N2006WLM2

CONSTRUCTION : MADE OF HEAVY DUTY PIPE 95MM X 25MM WITH SOLID THICK RUBBER SHEETS OF 22MM FOR LONGER LIFE



TRAINING WEIGHT LIFTING PLATFORM

TRAINING - 4 M X 4 M X 25 MM N2006WLRW
 3 M X 3 M X 25 MM N2006WLMW1
 3 M X 2.5 M X 25 MM N2006WLMW2

CONSTRUCTION : MADE OF HEAVY DUTY PIPE 95MM X 25MM WITH SOLID THICK RUBBER SHEETS OF 22MM FOR LONGER LIFE AND WOODEN CENTRE



SQUAT STAND PRO //

N 1134 OSS

PROFESSIONAL LEVEL HEAVY DUTY EQUIPMENT



• PLATFORM AVAILABLE AS AN EXTRA OPTION (N2006WLPG)

WEIGHT LIFTING/POWER LIFTING BENCH PRO //

N 1134 OWB

PROFESSIONAL LEVEL HEAVY DUTY EQUIPMENT



• PLATFORM AVAILABLE AS AN EXTRA OPTION (N2006WLPG)

WEIGHT LIFTING

DO ... DARE ... WIN !!

WEIGHT LIFTING HALF CAGE PRO

N 1134 WLCH

PROFESSIONAL LEVEL HEAVY DUTY EQUIPMENT

- PLATFORM AVAILABLE AS AN EXTRA OPTION (N2006WLPG)
- DUMBBELL FLY BENCH AVAILABLE AS AN EXTRA OPTION (N1134 WLDF)



WEIGHT LIFTING FULL CAGE PRO

N 1134 WLCF

PROFESSIONAL LEVEL HEAVY DUTY EQUIPMENT

- PLATFORM AVAILABLE AS AN EXTRA OPTION (N2006WLPG)
- DUMBBELL FLY BENCH AVAILABLE AS AN EXTRA OPTION (N1134 WLDF)



WEIGHT LIFTING

DO ... DARE ... WIN !!

DUMBBELL FLY BENCH PRO

PROFESSIONAL LEVEL HEAVY DUTY EQUIPMENT
(ADJUSTABLE HEIGHT AND WEIGHTED BASE, WITH WHEELS)

N1134 WLDF



WEIGHT LIFTING

BARBELL RACK

PROFESSIONAL LEVEL HEAVY DUTY EQUIPMENT

N1134 WLBR



POWDER STAND

N 1134 WPS



WEIGHT LIFTING /GYM GLOVES

OPEN PALM GLOVES MADE OF
LYCRA WITH LEATHER PALM

N 1134WGA



WEIGHT LIFTING /GYM BELTS

WEIGHT LIFTING BELTS- LEATHER

N1134WMA



WEIGHT LIFTING BELTS- SYNTHETIC

N1134WMC



DO DARE WIN !!

TECHNIQUE BOX //

TECHNIQUE BOX SET

- HEAVY DUTY 3 STAGE LAMINATED WOOD CONSTRUCTION
- THICK LAMINATED WOOD TOP COVERED WITH RUBBER TILES
- ADJUSTABLE HEIGHT INCREMENT - 9" TO 36"

N 1134 WLTBX



WEIGHT LIFTING

DO DARE WIN !!

JERK BOX



JERK BOX SET

- HEAVY DUTY STEEL CONSTRUCTION
- THICK TOP COVERED WITH RUBBER TILES
- ADJUSTABLE HEIGHT INCREMENTS - 34", 36", 38", 40", 42", 44",

N 1134 WLJBX

PULLING BOX



PULLING BOX SET

- HEAVY DUTY STEEL CONSTRUCTION
- THICK TOP COVERED WITH RUBBER TILES
- ADJUSTABLE HEIGHT INCREMENTS - 12", 15", 18"

N 1134 WLPBX

DO ... DARE ... WIN !!

WEIGHT LIFTING

MAXXIMUSS WEIGHT TRAINING PLATES

MAXXIMUSS COLOURED EASY GRIP BARBELL PLATES - FOR 28 MM/50MM BORE BARS ALL PLATES COME WITH UNIQUE COLOUR CODING FOR EACH WEIGHT

Code	BORE - 28MM	BORE - 50MM
2.5 KILO	N1134MX1	N1134MX15
5 KILO	N1134MX2	N1134MX25
7.5 KILO	N1134MX3	N1134MX35
10 KILO	N1134MX4	N1134MX45
15 KILO	N1134MX5	N1134MX55
20 KILO	N1134MX6	N1134MX65
25 KILO	N1134MX7	N1134MX75

(PLEASE SPECIFY BORE WHILE ORDERING)



GYM/STRENGTH

DO DARE WIN !!

SUPER WEIGHT TRAINING PLATES

SUPER - M.S. PRECISION TURNED CHROME PLATES FOR 28 MM BORE BARS
 ALL PLATES COMES WITH UNIQUE COLOUR CODING LABEL FOR EACH WEIGHT

Code	Dia
1 KILO	N1134GCT
2 KILO	N1134QCT
2.5 KILO	N1134ICT
3 KILO	N1134RCT
4 KILO	N1134SCT
5 KILO	N1134JCT
7.5 KILO	N1134KCT
10 KILO	N1134LCT
12.5 KILO	N1134MCT
15 KILO	N1134NCT
20 KILO	N1134OCT
25 KILO	N1134PCT



GYM/STRENGTH

DO DARE WIN !!

WEIGHT TRAINING BARS

28mm Dia Knurled Chrome Plated Bars

- 92 CMS. (3') N1134NF
- 120 CMS. (4') N1134OF
- 152 CMS. (5') N1134PF
- 182 CMS. (6') N1134QF
- 220 CMS. (7') N1134RF

• All Bars come with Spring Collars



CURLING BARS

28mm Dia Knurled Chrome Plated Bars

- 17.5 CMS. (4') N1134WC
- 148.5 CMS. (5') N1134UC

• All Bars come with Spring Collars



DUMBBELL BARS

28mm Dia Knurled Chrome Plated Bars

- 30 CMS. (1') N1156A
- 38 CMS. (1.25') N1156B
- 45 CMS. (1.5') N1156C

• All Bars come with Spring Collars



KETTLE BELLS

Solid Cast Iron Kettle Bells, Powder Coated & Colour Coded for different Weights

- | | |
|--------------------|--------------------|
| 4K - NS 2018 KB4 | 28K - NS 2018 KB28 |
| 6K - NS 2018 Kb6 | 32K - NS 2018 KB32 |
| 8K - NS 2018 KB8 | 36K - NS 2018 KB36 |
| 12K - NS 2018 KB12 | 40K - NS 2018 KB40 |
| 16K - NS 2018 KB16 | 44K - NS 2018 KB44 |
| 20K - NS 2018 KB20 | 48K - NS 2018 KB48 |
| 24K - NS 2018 KB24 | |



DUMBELLS

OLYMPIC SOLID STEEL CHROME
PLATED DUMBBELL WITH RUBBER GRIP

Code	Dia
1 KILO	N1136XA
2 KILO	N1136XC
2.5 KILO	N1136XD
3 KILO	N1136XE
4 KILO	N1136XG
5 KILO	N1136XI
7.5 KILO	N1136XK
10 KILO	N1136XN
12.5 KILO	N1136XP
15 KILO	N1136XS
20 KILO	N1136XU
25 KILO	N1136XV
30 KILO	N1136XW
35 KILO	N1136XX
40 KILO	N1136XY
45 KILO	N1136XZ
50 KILO	N1136XZZ



DUMBBELL HEXAGONAL RUBBERIZED

Code	Dia
1 KILO	N1136ZA
2 KILO	N1136ZB
2.5 KILO	N1136ZC
3 KILO	N1136ZD
4 KILO	N1136ZE
5 KILO	N1136ZF
6 KILO	N1136ZG
7.5 KILO	N1136ZH
10 KILO	N1136ZI
15 KILO	N1136ZJ
20 KILO	N1136ZK
25 KILO	N1136ZL
30 KILO	N1136ZM
40 KILO	N1136ZN



DUMBBELL ROUND RUBBERIZED

Code	Dia
2.5 KILO	N1137AD
5 KILO	N1137BD
7.5 KILO	N1137CD
10 KILO	N1137ED
12.5 KILO	N1137FD
15 KILO	N1137GD
17.5 KILO	N1137HD
20 KILO	N1137ID
22.5 KILO	N1137JD
25 KILO	N1137KD
27.5 KILO	N1137LD
30 KILO	N1137MD
35 KILO	N1137ND
40 KILO	N1137OD
45 KILO	N1137PD
50 KILO	N1137QD



DUMBBELL VINYL COATED

Code	Dia
1 KILO	N1138VA
2 KILO	N1138VB
3 KILO	N1138VC
4 KILO	N1138VD
5 KILO	N1138VE



GYM/STRENGTH

DO ... DARE ... WIN !!

DUMBBELL TREE

DUMBBELL TREE
NS 6001 TDT



DUMBBELLS RACK

DUMBBELL RACK
NS 6001 TDR



PLATE/DISC TREE



OLYMPIC PLATE RACK -50mm
NS 6001 OPS



CLUB PLATE TREE-28mm
NS 6001 TPS



CLUB PLATE TREE - 50mm
NS 6001 OPDX

GYM/STRENGTH

DO ... DARE ... WIN !!

CLUB MACHINES



ROD STAND DELUXE
NS 6001 ORDX



ROD STAND
NS 6001 ORS



ROD STAND
NS 6001 TRS



T-BAR
NS 6001 TB



SQUAT STAND
NS 6001 SS



SEATED CALF
NS 6001 SC



ARM/PREACHER CURL
NS 6001 APB

DO ... DARE ... WIN !!

GYM/STRENGTH

CLUB MACHINES



BENCH PRESS-INCLINED
NS 6001 IB



BENCH PRESS-DECLINED
NS 6001 DB



BENCH PRESS-FLAT
NS 6001 FB



BENCH PRESS-MULTIPURPOSE
FLAT/INCLINED/DECLINED
NS 6001 BB

DO DARE WIN !!

GYM/STRENGTH

CLUB MACHINES



DUMBELL FLY BENCH
NS 6001 DFB



HAMGLUTE DEVELOPER
(ROMAN CHAIR)
NS 6001 FC



WORKOUT BENCH
NS 6001 WB



DUMBELL STOOL
NS 6001 DS

DO DARE WIN !!

GYM/STRENGTH

CLUB MACHINES



SIT UP BENCH
NS 6001 SUB



SINGLE TWISTER
NS 6001 ST



ABDOMINAL/SLANT BOARD
(WITH LADDER)
NS 6001 ABL



MULTI TWISTER
NS 6001 MT

GYM/STRENGTH

DO DARE WIN !!

CLUB MACHINES



ARM/PREACHER CURL MACHINE-75 Kg.
NS 6002 CAC

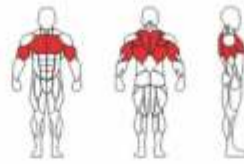

PECDECK (BUTTERFLY) MACHINE-75 Kg.
NS 6002 CBF

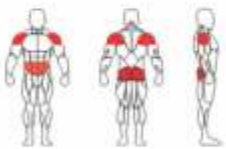

LAT ROWING MACHINE-75 Kg.
NS 6002 CLR

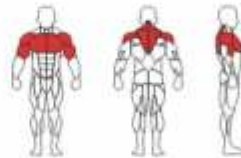

HI LAT MACHINE-75 Kg.
NS 6002 CHL

GYM/STRENGTH

DO DARE WIN !!

CLUB MACHINES



SEATED CHEST PRESS MACHINE-75 Kg.
NS 6002 CSC

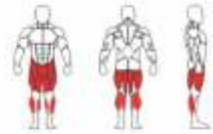

LEG CURL + LEG EXTENSION MACHINE-75 Kg.
NS 6002 CLC



CABLE CROSSOVER MACHINE-75 Kg.
NS 6002 CCC

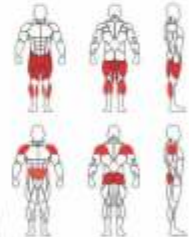

DO DARE WIN !!

GYM/STRENGTH

CLUB MACHINES



**LEG PRESS MACHINE-100Kg.
NS 6002 CLP**

Specification of New Club Single Station Machines:

- ❖ Base Frame: 91mm x 46mm Rectangular M.S. Tubes.
- ❖ Pillars: 75mm Diameter Round M.S. Tubes.
- ❖ Aesthetically designed Weight Stack Covers made of M.S. Sheet for covering the entire weight stack for user safety.
- ❖ Weight Stack: Precision Machined Mild Steel (M.S.) Plates with Nylon Bushes.
- ❖ Weight Stack Guide Bars – Rust Proof Stainless Steel for lifetime smooth movement of weight stacks.
- ❖ HD Plastic Pulleys with double ball bearings.
- ❖ PVC Coated wires for smooth movement and optimum life of pulleys.
- ❖ Seats made from a combination of HDPE & EVA Rubberised Foam and upholstered in Non-Tearing Waterproof Vinyl Fabric.
- ❖ Machines are Powder Coated for durability.
- ❖ Additional weight available on order.



**ASSISTED POWER RACK (SMITH MACHINE)
NS 6002 CSM**



**POWER HIP-SLED (HACK/REVERSE SQUAT/LEG PRESS)
NS 6002 CHS**

DO DARE WIN !!

GYM/STRENGTH

CLUB MACHINES



MULTISTATI GYM MACHINE-DELUXE CLUB PRO12 STATIONS - 510Kg.
NS 6002 PG12

MULTISTATION GYM MACHINE-DELUXE CLUB PRO

AVAILABLE SIZES :

4 STATIONS- 200Kg.	NS 6002 PG4
6 STATIONS- 275Kg.	NS 6002 PG6
8 STATIONS- 360Kg.	NS 6002 PG8
10 STATIONS- 460Kg.	NS 6002 PG10
12 STATIONS- 510Kg.	NS 6002 PG12
16 STATIONS- 610Kg.	NS 6002 PG16

Specification of Multistation Machines:

- ◆ Super Structure - 91mm x 46mm Capsule M.S. Tubes.
- ◆ Aesthetically designed Weight Stack Covers made of M.S. Sheet for covering the entire weight stack for user safety.
- ◆ Weight Stack: Precision Machined Mild Steel (M.S.) Plates with Nylon Bushes.
- ◆ Weight Stack Guide Bars - Rust Proof Stainless Steel for lifetime smooth movement of weight stacks.
- ◆ HD Plastic Pulleys with double ball bearings.
- ◆ PVC Coated wires for smooth movement and optimum life of pulleys.
- ◆ Seats made from a combination of HDPE & EVA Rubberised Foam and upholstered in Non-Tearing Waterproof Vinyl Fabric.
- ◆ Machines are Powder Coated for durability.
- ◆ Additional weight available on order.



MULTISTATION GYM MACHINE-DELUXE CLUB PRO 4 STATIONS-200Kg.
NS 6002 PG4

DO DARE WIN !!

GYM/STRENGTH

DUAL ADJUSTABLE PULLEY

MAX XIMUSS™ N 7000 DAP
By Neleo

- MULTI FUNCTION MACHINE.
- TWIN WEIGHT STACKS OF 80 KG EACH.

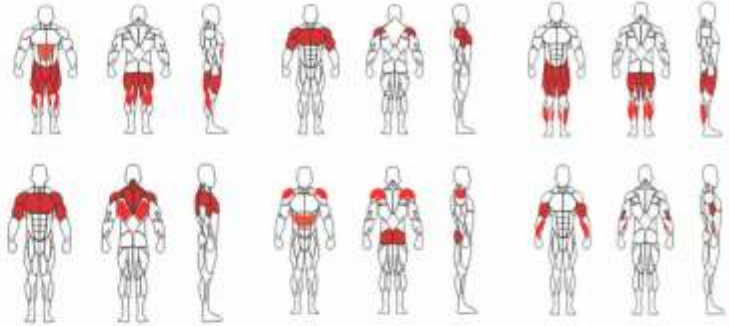

GYM/STRENGTH

DO DARE WIN !!

LAT PULL DOWN & SEATED ROW

MAX X IMUSS™
By Nelco

N 7000 LPSR

- DUAL MOTION MACHINE.
TWO FUNCTIONS IN ONE MACHINE.
- WEIGHT STACK OF 100 KG.



PEC DECK & REAR DELTOIDS

MAX X IMUSS™
By Nelco

N 7000 PDRD

- DUAL MOTION MACHINE.
TWO FUNCTIONS IN ONE MACHINE.
- WEIGHT STACK OF 80 KG.

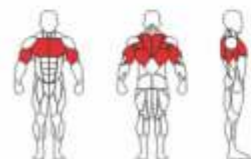

GYM/STRENGTH

DO ... DARE ... WIN !!

BICEPS & TRICEPS

MAX XIMUSS™
By Neleo

N 7000 BCTC

- DUAL MOTION MACHINE.
TWO FUNCTIONS IN ONE MACHINE.
- WEIGHT STACK OF 80 KG.



MULTI PRESS

MAX XIMUSS™
By Neleo

N 7000 MUPR

- DUAL MOTION MACHINE.
TWO FUNCTIONS IN ONE MACHINE.
- WEIGHT STACK OF 100 KG.

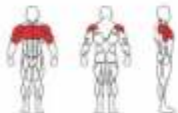

ABDOMEN & LOWER BACK

MAX XIMUSS™
By Nelco

N 7000 ABLB

- DUAL MOTION MACHINE.
TWO FUNCTIONS IN ONE MACHINE.
- WEIGHT STACK OF 80 KG.

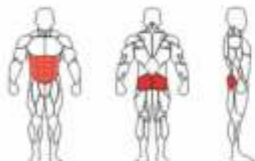

INNER & OUTER THIGH

MAX XIMUSS™
By Nelco

N 7000 INOT

- DUAL MOTION MACHINE.
TWO FUNCTIONS IN ONE MACHINE.
- WEIGHT STACK OF 80 KG.

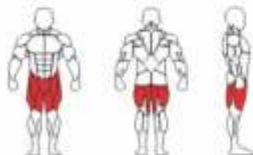

GYM/STRENGTH

DO DARE WIN !!

LEG EXTENSION & LEG CURL

MAX XIMUSS™
By Neleo

N 7000 LELC

- DUAL MOTION MACHINE.
TWO FUNCTIONS IN ONE MACHINE.
- WEIGHT STACK OF 80 KG.

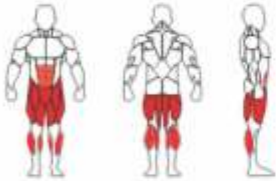

LEG PRESS & CALF RAISE

MAX XIMUSS™
By Neleo

N 7000 LPCR

- DUAL MOTION MACHINE.
TWO FUNCTIONS IN ONE MACHINE.
- WEIGHT STACK OF 100 KG.



SMITH MACHINE

MAX XIMUSS™
By Neleo

N 7000 SM



LEG PRESS & HACK SQUAT

MAX XIMUSS™
By Neleo

N 7000 LPHS



GYM/STRENGTH

DO ... DARE ... WIN !!

PECTORAL FLY

CRIXXUS™ N 8000 PF
By Neleo

Dimension (L*W*H):
124cm x 94cm x 211cm
Weight Stack: 80kg
N.W. 227kg

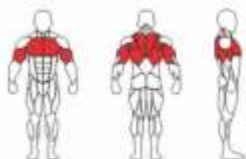

GYM/STRENGTH

HIGH LAT PULLDOWN

CRIXXUS™ N 8000 HL
By Neleo

Dimension (L*W*H):
185cm x 109cm x 234cm
Weight Stack: 100kg
N.W. 248kg

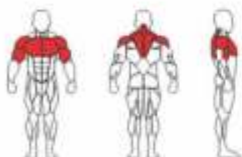

DO DARE WIN !!

CHEST PRESS

CRIXXUS™ N 8000 CP
By Neleo

Dimension (L*W*H):
132cm x 130cm x 135cm
Weight Stacks:80kg
N.W. 214kg



GYM/STRENGTH

SHOULDER PRESS

CRIXXUS™ N 8000 SP
By Neleo

Dimension (L*W*H):
185cm x 122cm x 132cm
Weight Stacks:80kg
N.W. 239kg

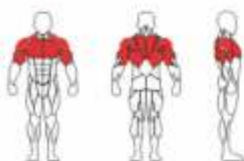

DO DARE WIN !!

GLUTE DEVELOPER

CRIXXUS™
By Nelco

N 8000 GD

Dimension (L*W*H):
119cm x 89cm x 135cm
Weight Stacks: 80kg
N.W. 168kg

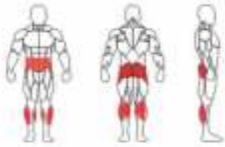

GYM/STRENGTH

VERTICAL ROW

CRIXXUS™
By Nelco

N 8000 VR

Dimension (L*W*H):
155cm x 132cm x 160cm
Weight Stacks: 80kg
N.W. 194kg



DO DARE WIN !!

DIP/CHIN ASSIST

CRIXXUS™
By Neleo

N 8000 DC

Dimension (L*W*H):
155cm x 137cm x 236cm
Weight Stacks: 100kg
N.W. 289kg

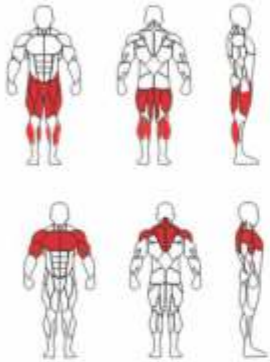

GYM/STRENGTH

LEG PRESS

CRIXXUS™
By Neleo

N 8000 LP

Dimension (L*W*H):
155cm x 237cm x 160cm
Weight Stacks: 100kg
N.W. 289kg

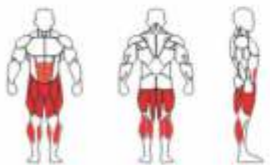

DO ... DARE WIN !!

LEG CURL/LEG EXTENSION

CRIXXUS™ N 8000 LL
By Neleo

Dimension (L*W*H):
119cm x 89cm x 135cm
Weight Stacks: 80kg
N.W. 168kg



GYM/STRENGTH

CABLE CROSSOVER

CRIXXUS™
By Neleo

N 8000 CC

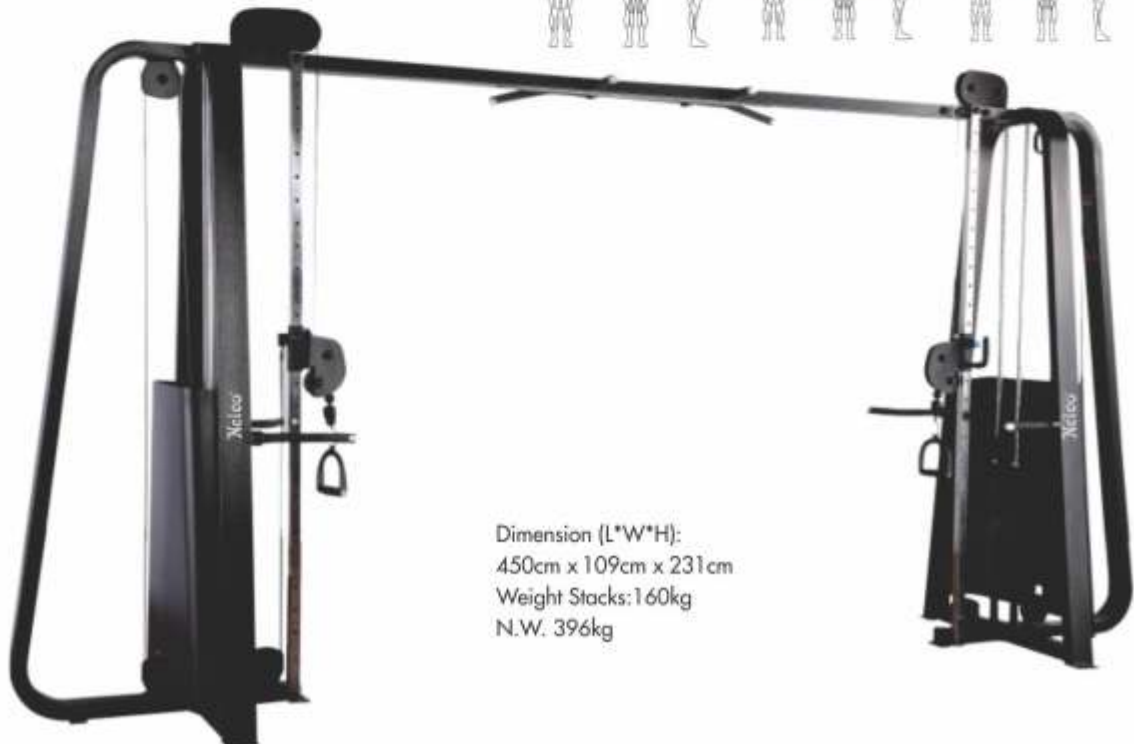

Dimension (L*W*H):
450cm x 109cm x 231cm
Weight Stacks: 160kg
N.W. 396kg

DO DARE WIN !!

HACK SQUAT / LEG PRESS

CRIXXUS™ N 8000 HS
By Neleo

Dimension (L*W*H):
223cm x 163cm x 127 cm
N.W. 172Kg



GYM/STRENGTH

SMITH MACHINE

CRIXXUS™ N 8000 SM
By Neleo

Dimension (L*W*H):
109cm x 218cm x 232cm
N.W. 167Kg



POWER CAGE

CRIXXUS™ N 8000 PC
By Neleo

Dimension (L*W*H):
157cm x 124cm x 234cm
N.W. 154Kg



DO ... DARE WIN !!

SEATED CALF RAISE

CRIXXUS™ N 8000 SC
By Neleo

Dimension (L*W*H):
150cm x 71cm x 99cm
N.W. 49Kg



SQUAT RACK

CRIXXUS™ N 8000 SR
By Neleo

Dimension (L*W*H):
185cm x 173cm x 180cm
N.W. 128Kg



T- BAR ROW

CRIXXUS™ N 8000 TB
By Neleo

Dimension (L*W*H):
185cm x 79cm x 119cm
N.W. 66Kg



ARM/PREACHER CURL BENCH

CRIXXUS™ N 8000 AP
By Neleo

Dimension (L*W*H):
132cm x 84cm x 97cm
N.W. 55kg



GYM/STRENGTH

DO DARE WIN !!

VERTICAL KNEE

CRIXXUS™ N 8000 VK
By Neleo

Dimension (L*W*H):
127cm x 71cm x 160cm
N.W. 86kg



VERTICAL PLATE TREE

CRIXXUS™ N 8000 VT
By Neleo

Dimension (L*W*H):
61cm x 58cm x 124cm
N.W. 39kg



FLAT BENCH

CRIXXUS™ N 8000 WB
By Neleo

Dimension (L*W*H):
135cm x 76cm x 43cm
N.W. 30kg



CRUNCH BENCH

CRIXXUS™ N 8000 CB
By Neleo

Dimension (L*W*H):
162cm x 76cm x 81cm
N.W. 61kg



GYM/STRENGTH

DO ... DARE ... WIN !!

DUMBBELL FLY BENCH

CRIXXUS™ N 8000 DF
By Neleo

Dimension (L*W*H):
162cm x 76cm x 81cm
N.W. 61kg



FLAT BENCH

CRIXXUS™ N 8000 FB
By Neleo

Dimension (L*W*H):
173cm x 178cm x 122cm
N.W. 82kg



DECLINE BENCH

CRIXXUS™ N 8000 DB
By Neleo

Dimension (L*W*H):
206cm x 178cm x 109cm
N.W. 98kg



INCLINE BENCH

CRIXXUS™ N 8000 IB
By Neleo

Dimension (L*W*H):
201cm x 178cm x 140cm
N.W. 127kg



GYM/STRENGTH

DO DARE WIN !!

HOME GYM

HOME GYM 7 IN 1

NS 6600 HG1

PERFECT HOME TOOL FOR ALL ROUND DEVELOPMENT OF BODY

- HI LAT
- PEC DEC
- CHEST PRESS
- ARM CURL
- LAT ROWING
- TRICEP
- LEG CURL

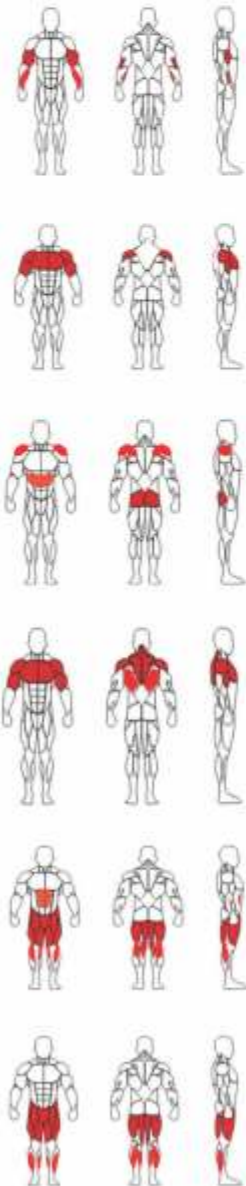

DO ... DARE WIN !!

GYM/STRENGTH

X-TRAINER

NS2018 XT3 3'W x 12'L x 8'6"H
NS2018 XT5 5'W x 12'L x 8'6"H

- A perfect fitness tool for your Gym, House, School or Playground.
- Options available for 3' and 5' wide Rungs.

Stations:

- Step Ladder
- Monkey Crawl
- Chin Up
- Push Up
- Hip Flex/Parallel Bars
- Sit Up/Leg Raise
- Punching/Kicking Bag



*Squat attachment also available upon request.

DO DARE WIN !!

GYM/STRENGTH

VAULTING TABLE PRO

Competition Vaulting Table meeting all FIG Rules. Vaulting Table is constructed from reinforced high quality laminated ply, layered and covered with rebounding foam and high quality cover material. Four non-marking rubber floor contacts to ensure skid free environment and thus avoiding any injury. Adjustable Height Base protection padding included.

NS2000GVT



VAULTING BOX PRO

Competition Vaulting Box meeting all FIG Rules. 5 Stage construction with reinforced high quality laminated ply. Top layered covered with rebounding foam and high quality cover material.

NS2000GVB



SPRING BOARD PRO

Fitted with 5 tapered high quality springs. Standard 120cm x 60cm board in curved design by using multi-ply timber with integral reinforcing. Covered with high quality carpeting. Carry handle is provided with wheels on one end for easy portability. Base frame stability ensured by use of anti-slip rubbers on all the 4 corners. Complies to FIG Rules
NS2000GSB



HORIZONTAL BAR SET PRO

High Quality Horizontal Bar to ensure jolt free rotation thus minimising any risk of injury and boosting confidence. 75mm heavy gauge steel tube used. Complies to FIG Rules
NS2000GHB



UNEVEN BARS SET PRO

High quality Uneven Bar with fibre bars to ensure maximum confidence to the Gymnast. Heavy Gauge 75mm dia steel tube used for uprights and rectangular tube used at the base for optimum stability. Wires with tensioners provided for easy installation. Low Bar /High Bar and distance between the two bars is Adjustable. Complies to FIG Rules
NS2000GUB



PARALLEL BARS SET PRO



High Quality Competition Parallel Bars with Fibre Bars.
 Base made of heavy duty MS Tubes to add to the stability of the whole equipment. Distance between the bars can also be adjusted. Tightening knobs are provided. Height adjustments at every 5cm interval. High Quality fibre bars used. Two height adjustment options available. Complies to FIG Rules
 120cm to 180cm NS2000GPF - 1
 160cm to 220cm NS2000GPF - 2
 Kindly mention height range while ordering.

VAULTING HORSE PRO



High Quality Vaulting Horse with standard legs and synthetic leatherite body. Adjustable height and 4 non-marking anti-slip shoes provided with anchoring system to improve stability. Complies to FIG Rules
 NS2000GVF

POMMEL HORSE PRO



High Quality Pommel Horse with standard legs and synthetic leatherite body. Adjustable height and 4 non-marking anti-slip shoes provided with anchoring system to improve stability. Pommels made of laminated plywood for better grip. Complies to FIG Rules
 NS2000GPF

GYMNASTICS

DO ... DARE WIN !!

BALANCING BEAM PRO



A high quality competition Balancing Beam. 5m in length drawn steel tube. Body covered with non-slip leatherite cover. Fast and simple to adjust height mechanism with easy jack system. Complies to FIG Rules NS2000GBB

BALANCING BEAM - LOW



A high quality Balancing Beam. 5m in length drawn steel tube. Body covered with non-slip leatherite cover. Complies to FIG Rules NS2000GBBL

GYMNASTICS

DO DARE WIN !!

ROMAN RING APPARATUS PRO

A high quality Competition Roman Ring System made from heavy gauge steel tubes.
Extra strong belt and Laminated plywood rings provided with complete system. Complies to FIG Rules
NS2000GRR



FOAM PIT

Bags for Foam Pit for Gymnastics
Foam Filled in Stretchable Synthetic Fabric Cover
Size : 80cm x 10cm x 10cm
NS2000GFP



DO DARE WIN !!

GYMNASTICS

WALL BARS

Made up of solid wood columns attached with Zinc plated strong steel tubes
NS2000GWB



GYMNASTIC BENCH

Made up of solid wood top fitted on M.S. tube frame. Includes hooks to latch onto Wall Bars and Wheels for easy mobility

NS2000GBW



TRAMPOLINE OLYMPIC //

Trampoline Olympic - MIN. SIZE - 6' x 4' UPTO MAX. SIZE - 16' x 8'

Frame made from heavy guage steel tube, jump area made from heavy duty vinyl double stiched for extra strength and supported by heavy springs all around. Comes with protection padding .

NS2000GSP



SLANTED TRAMPOLINE //

Frame made from heavy guage steel tube, jump area made from heavy duty vinyl double stiched for extra strength and supported by heavy springs all around. Comes with protection padding . Frame Size - 48L" x 42W"

Jumping Area 30L" x 24W"

Adjustable to 13" x 14" and 15"

NS2000GST



MINI TRAMPOLINE //

Frame made from heavy guage steel tube, jump area made from heavy duty vinyl double stiched for extra strength and supported by heavy springs all around. Comes with protection padding . Frame Size - 48L" x 48W"

Jumping Area 30L" x 30W"

NS2000GMT



GYMNASTICS

DO ... DARE ... WIN !!



MULTIPURPOSE SPORTS MATS - CANVAS

2M x 1M x 50MM EPE NS2050EPC
 2M x 1M x 60MM EPE NS2060EPC



MULTIPURPOSE SPORTS MATS - TETRON

2M x 1M x 50MM EPE NS2050EPT
 2M x 1M x 60MM EPE NS2060EPT



MULTIPURPOSE SPORTS MATS - NON TEARING VINYL (ANTI - SLIP BOTTOM)

2M x 1M x 50MM EPE NS2050EPN
 2M x 1M x 60MM EPE NS2060EPN



SPORTS MATS - PU FOAM (NON TEARING VINYL)

2M x 1M x 100MM CLUB NS10023GMN
 2M x 1M x 100MM PRO NS10032GMN
 2M x 1M x 200MM CLUB NS20023GMN
 2M x 1M x 200MM PRO NS20032GMN
 3M x 2M x 300MM CLUB NS30023GMN (CRASH MAT)
 3M x 2M x 300MM PRO NS30032GMN (CRASH MAT)

- MESH SIDE VENTS AVAILABLE ONLY ON 3M x 2M x 300MM CRASH MATS

WRESTLING



WRESTLING MAT-12M x 12M

(FOR COVERING SPORTS EPE MATS)

NS32000WMC



JUDO - TAEKWONDO - KHO KHO - KABADDI - ETC

MULTI-PURPOSE INTERLOCKING MATS-

1M x 1M x 25MM NS2500IM

1M x 1M x 30MM NS3000IM

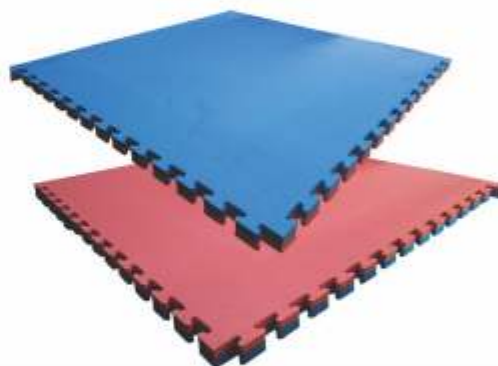

GYM FLOOR MATS



TPR GYM FLOOR MATS

18" x 18"

NS3500GM

MATS & ARENAS

DO DARE WIN !!

BOXING RING

COMPETITION BOXING RING AS PER AIBA SPECS
24' x 24' (6.10 M x 6.10 M INSIDE AREA)



MATS & ARENAS

DO DARE WIN !!

FOOTBALL GOAL POSTS- COMPETITION ALUMINIUM

4" DIA. FIXED COMPETITION GOAL POST SET NS5015FGA1 (AS PER FIFA RULES)
ALUMINIUM GOAL POST WITH M.S. REAR NET SUPPORT POLES, INGROUND SLEEVES INCLUDED FOR EASY INSTALLATION



NELCO ULTRA-HOLD Net Fixing System



STADIUM DUG OUT

STEEL GALVANIZED AND POWDER COATED DUG OUT WITH MOULDED PLASTIC SEATS

NS5014DG8 8 SEATER

NS5014DG12 12 SEATER



POLES, POSTS & NETS

DO DARE WIN !!

FOOTBALL GOAL POSTS- FIXED

4" DIA. FIXED DELUXE GOAL POST SET NS5014FGP
STEEL GOAL POSTS WITH UNIQUE FREE STANDING NET SUPPORTS



NELCO ULTRA-HOLD Net Fixing System



FOOTBALL GOAL POSTS- MOBILE

4" DIA. MOBILE GOAL POST SET (WITH GALVANISED SOLID WHEELS)
STEEL GOAL POST WITH WHEELS FOR EASY MOBILITY

NS5014FME



NELCO ULTRA-HOLD Net Fixing System

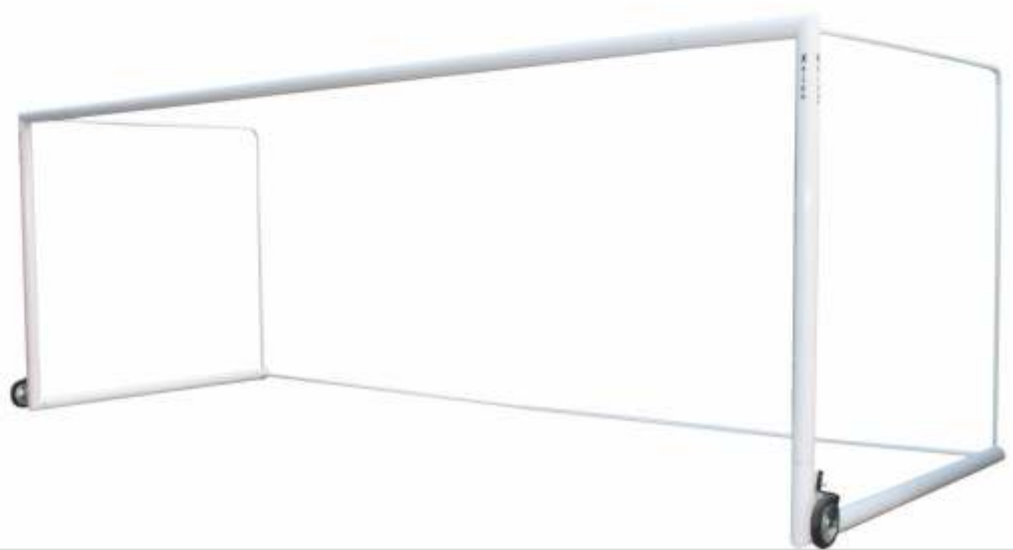

POLES, POSTS & NETS

DO DARE WIN !!

HOCKEY GOAL POSTS- FIXED

COMPETITION GOAL POST SET FIXED
(WITH WEATHER PROOF FIBER BACKBOARD)
●MILD STEEL CONSTRUCTION

NS5080HGF



NELCO ULTRA-HOLD Net Fixing System



HOCKEY GOAL POSTS- MOBILE

COMPETITION GOAL POST SET MOBILE
(WITH WEATHER PROOF FIBER BACKBOARD)
●MILD STEEL CONSTRUCTION

NS5080HGP



NELCO ULTRA-HOLD Net Fixing System

HAND BALL GOAL POSTS- FIXED

80MM SQUARE TUBE COMPETITION GOAL POST SET FIXED NS5060HGP

● MILD STEEL CONSTRUCTION



NELCO ULTRA-HOLD Net Fixing System



HAND BALL GOAL POSTS- MOBILE

80MM SQUARE TUBE COMPETITION GOAL POST SET MOBILE NS5060HGM

● MILD STEEL CONSTRUCTION



NELCO ULTRA-HOLD Net Fixing System

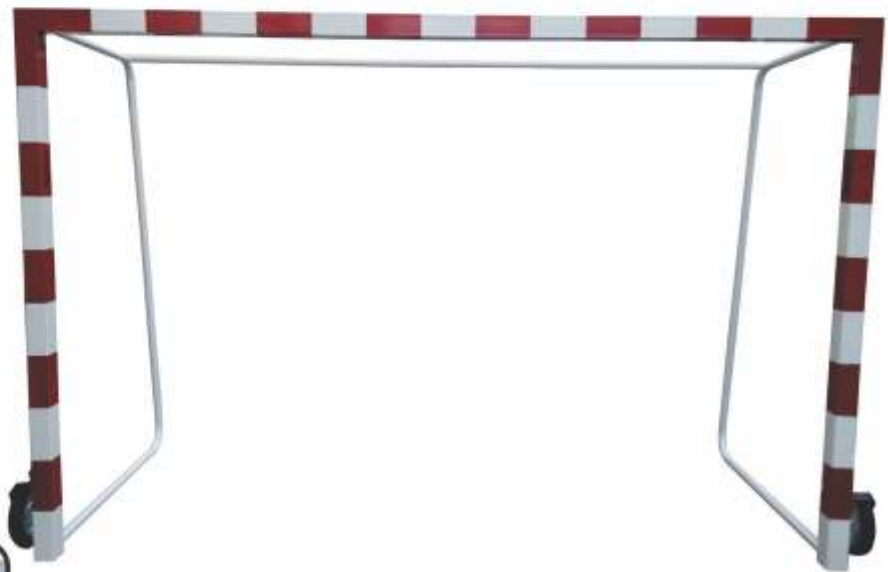

POLES, POSTS & NETS

DO DARE WIN !!

BADMINTON POSTS

SQUARE FIXED POST SET WITH PULLEY FOR NET ADJUSTMENT NS5040FBP

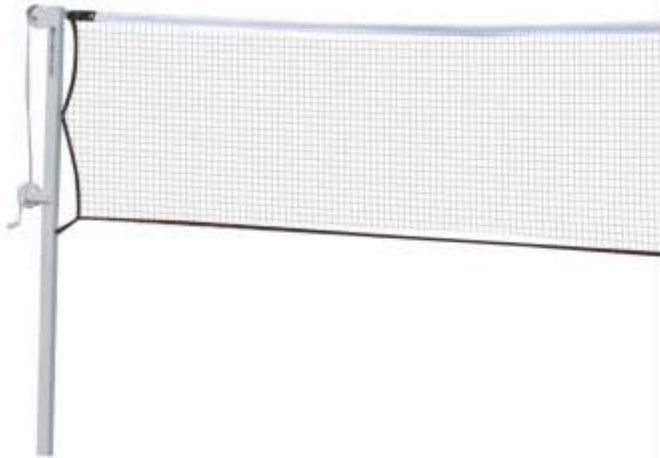

SQUARE SCHOLASTIC MOBILE POST SET NS5040SCM



Optional Protection Cover



SQUARE PIPE MOBILE POST SET WITH STEEL COUNTER - BALANCE WEIGHT FOR STABILITY (APPX. WT. 80 KG. PER SET) NS5040CMS



Optional Protection Cover



SQUARE PIPE COMPETITION PRO MOBILE BADMINTON POST SET WITH STEEL COUNTER - BALANCE WEIGHT FOR STABILITY (APPX. WT. 150 KG. PER SET) NS5040CBP



Optional Protection Cover



POLES, POSTS & NETS

DO ... DARE ... WIN !!

VOLLEYBALL POSTS

3" DIA. FIXED POST SET WITH ADJUSTABLE HEIGHT
NS5020FVP



4" DIA. FIXED POST SET WITH CRANK SYSTEM FOR HEIGHT ADJUSTMENT
NS5020CVP



4" DIA. MOBILE POST SET WITH CRANK SYSTEM FOR HEIGHT ADJUSTMENT
NS5020CVPM

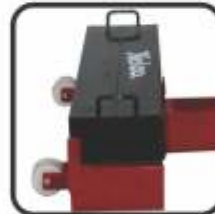

Optional Protection Cover



POLES, POSTS & NETS

DO DARE WIN !!

KHO KHO POST SET

KHO KHO POST SET WOODEN

NS5050WKP



KHO KHO POST SET MILA STEEL

NS5050SKP



LAWN TENNIS POSTS SET

4" DIA. FIXED POST SET WITH PULLEY FOR NET ADJUSTMENT

NS5030FTP



4" DIA. MOBILE POST SET WITH PULLEY FOR NET ADJUSTMENT & STEEL COUNTER - BALANCE WEIGHT FOR STABILITY (APPX. WT. 1.50 KG. PER SET)

NS5030MTP



Optional Protection Cover



POLES, POSTS & NETS

DO DARE WIN !!

BASKET BALL POLE SETS - MOBILE

PRO COMPETITION MOBILE BASKET BALL SET

NEW STATE OF THE ART BASKET BALL MOBILE POST WITH MAXI SOLID RUBBER WHEELS WHICH DO NOT MARK OR DAMAGE THE FLOOR. STATE OF THE ART EASY JACK SYSTEM TO INCREASE AND DECREASE HEIGHT. COMES DOWN FOR EASY INSTALLATION OF BOARD AND EASY MOVEMENT. ADEQUATE BALLAST WEIGHT PROVIDED FOR STABILITY BASE LEVELERS CAN BE ADJUSTED ON UNEVEN SURFACES.

3 SPRING COMPETITION DUNKING RING PROVIDED ON ALL MODELS

PRO COMPETITION MOBILE BASKET BALL SET WITH 18MM ACRYLIC BOARD
PRO COMPETITION MOBILE BASKET BALL SET WITH 20MM ACRYLIC BOARD

NS5096PC2
NS5096PC3



DO DARE WIN !!

POLES, POSTS & NETS

BASKET BALL POLE SETS - MOBILE

PRO INTERNATIONAL MOBILE BASKET BALL SET

NEW STATE OF THE ART BASKET BALL MOBILE POST WITH MAXI SOLID RUBBER WHEELS WHICH DO NOT MARK OR DAMAGE THE FLOOR. STATE OF THE ART EASY SPRING SYSTEM TO INCREASE AND DECREASE HEIGHT. COMES DOWN FOR EASY INSTALLATION OF BOARD AND EASY MOVEMENT. ADEQUATE BALLAST WEIGHT PROVIDED FOR STABILITY. BASE LEVELERS CAN BE ADJUSTED ON UNEVEN SURFACES.

3 SPRING COMPETITION DUNKING RING PROVIDED ON ALL MODELS

PRO COMPETITION MOBILE BASKET BALL SET WITH 18MM ACRYLIC BOARD
PRO COMPETITION MOBILE BASKET BALL SET WITH 20MM ACRYLIC BOARD

NS5096P12
NS5096P13



DO DARE WIN !!

POLES, POSTS & NETS

BASKET BALL POLE SETS - FIXED

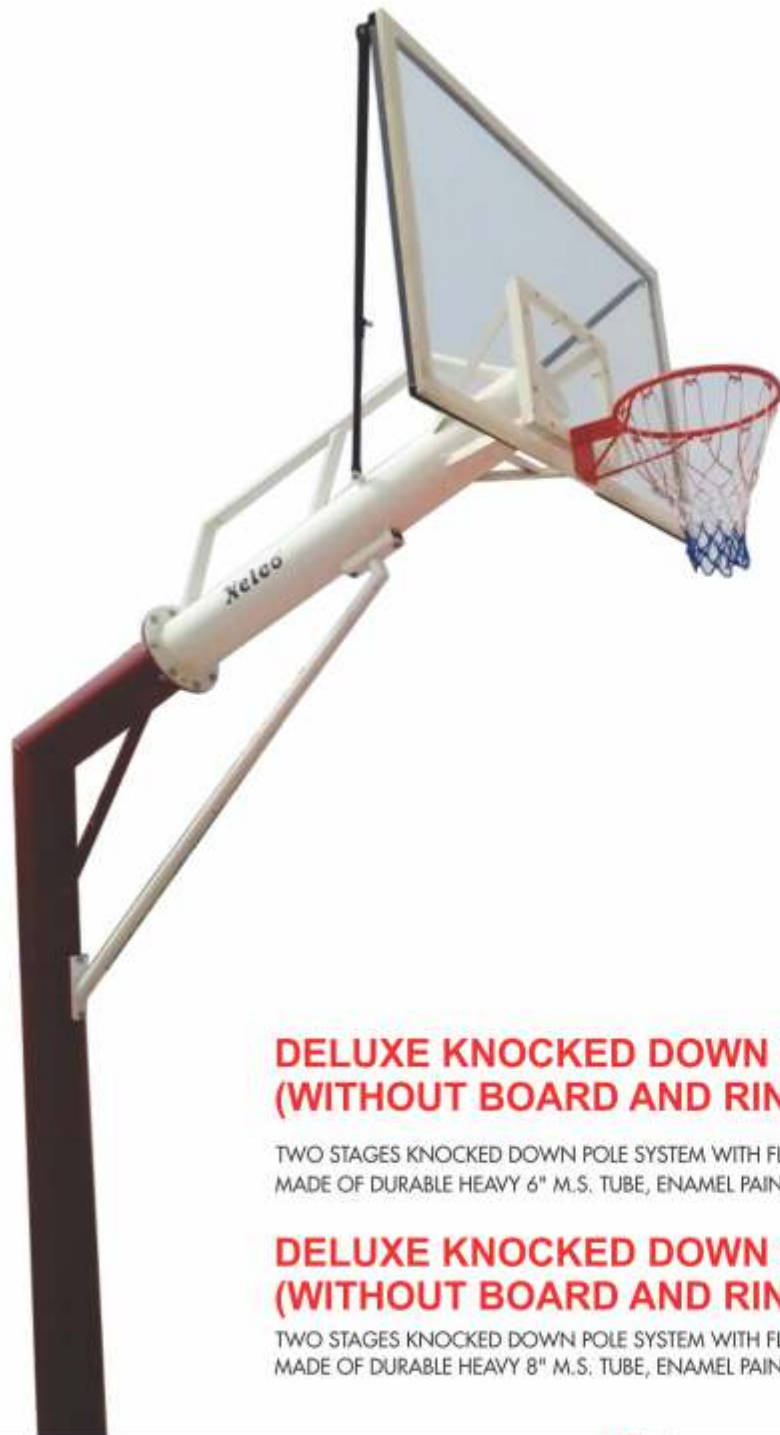

DELUXE KNOCKED DOWN 6" POLE SET (WITHOUT BOARD AND RING)

TWO STAGES KNOCKED DOWN POLE SYSTEM WITH FLECH.
MADE OF DURABLE HEAVY 6" M.S. TUBE, ENAMEL PAINTED. 3.2M EXTENSION

NS5091KD6

DELUXE KNOCKED DOWN 8" POLE SET (WITHOUT BOARD AND RING)

TWO STAGES KNOCKED DOWN POLE SYSTEM WITH FLECH.
MADE OF DURABLE HEAVY 8" M.S. TUBE, ENAMEL PAINTED. 3.2M EXTENSION

NS5091KD8

BASKET BALL HOOPS (RINGS)

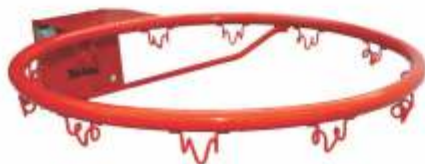

CLUB NS5098BRI

PRO COMPETITION - DUNKING
(3 SPRINGS) NS5098BRD



DO DARE WIN !!

POLES, POSTS & NETS

TABLE TENNIS



TABLE TENNIS

TABLE TENNIS TABLE COMPETITION PRO



TABLE TENNIS TABLE COMPETITION PRO NS2007TTP

- 25 MM THICK BOTH SIDE LAMINATED TOP
- FRAME : 50 MM x 25 MM POWDER COATED STEEL TUBE
- LEGS : 46 MM SQUARE POWDER COATED STEEL TUBE
- WHEELS : 100 MM DIA
- COLOUR : BLUE
- NET POST : COMPETITION
- ITTF REGULATION SIZE : 2740 MM x 1525 MM x 760 MM



NET POST - COMPETITION PRO NS 2007TPA

DO ... DARE WIN !!

TABLE TENNIS TABLE TOURNAMENT



TABLE TENNIS TABLE TOURNAMENT NS2007TTC1

- 18 MM THICK BOTH SIDE LAMINATED TOP
- FRAME : 38 MM x 25 MM POWDER COATED STEEL TUBE
- LEGS : 38 MM SQUARE POWDER COATED STEEL TUBE
- WHEELS : 75 MM DIA
- COLOUR : BLUE
- NET POST : COMPETITION
- ITTF REGULATION SIZE : 2740 MM x 1525 MM x 760 MM



NET POST - TOURNAMENT NS 2007TPB

TABLE TENNIS TABLE CLUB

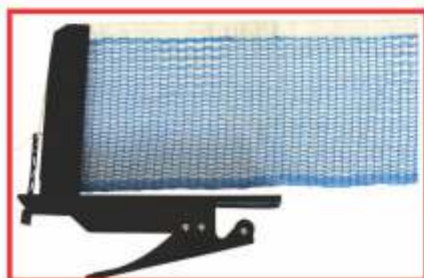

NET POST - TOURNAMENT NS 2007TPB

TABLE TENNIS TABLE CLUB NS2007TTC2

- 18 MM THICK BOTH SIDE LAMINATED TOP
- FRAME : 22 MM x 15 MM POWDER COATED STEEL TUBE
- LEGS : 25 MM SQUARE POWDER COATED STEEL TUBE
- WHEELS : 50 MM DIA
- COLOUR : BLUE
- NET POST : COMPETITION
- ITTF REGULATION SIZE : 2740 MM x 1525 MM x 760 MM

TABLE TENNIS

DO ... DARE ... WIN !!

ISIS - ENGLISH WILLOW

Top Grade hand selected state-of-the-art English Willow cricket bat. Individually custom handcrafted to achieve the perfect combination of balance and pickup. Unbleached and naturally air dried.

Massive profile in traditional shape with extra thick edges and curved blade to produce best performance.

Manau Cane handle for exceptional shock absorption capability and jerk free performance.

NS 2018 BIS



CARBON - ENGLISH WILLOW

Top Grade hand selected state-of-the-art English Willow cricket bat. Individually custom handcrafted to achieve the perfect combination of balance and pickup. Unbleached and naturally air dried.

Massive profile in traditional shape with extra thick edges and curved blade to produce best performance.

Manau Cane handle for exceptional shock absorption capability and jerk free performance.

NS 2018 BCA



SPITFIRE - ENGLISH WILLOW

Top Grade English Willow cricket bat. Individually handcrafted to achieve an ideal combination of balance and light feel pickup to provide a stress free cricketing experience. Unbleached and naturally air dried.

Massive profile in traditional shape with extra thick edges and curved blade to produce best performance. Manau Cane handle for exceptional shock absorption capability and jerk free performance.

NS 2018 BSP



CRICKET

DO ... DARE ... WIN !!

RAGE - ENGLISH WILLOW

Select Grade hand selected state-of-the-art English Willow cricket bat. Individually handcrafted to achieve an ideal combination of balance and light feel pickup to provide a stress free cricketing experience. Unbleached and naturally air dried.

Massive profile in traditional shape with extra thick edges and curved blade to produce best performance. Manau Cane handle for exceptional shock absorption capability and jerk free performance.

NS 2018 BRA



BRUTE - ENGLISH WILLOW

Select Grade hand selected state-of-the-art English Willow cricket bat. Individually handcrafted with maximum wood in the middle to achieve an ideal combination of balance and light feel pickup for modern day cricket.

Unbleached and naturally air dried. Massive profile in traditional shape with extra thick edges and curved blade to produce best performance. Manau Cane handle for exceptional shock absorption capability and jerk free performance.

NS 2018 BBR



BRUTE FORCE - ENGLISH WILLOW

Select Grade hand selected state-of-the-art English Willow cricket bat. Individually handcrafted with maximum wood in the middle to achieve an ideal combination of balance and light feel pickup for modern day cricket.

Unbleached and naturally air dried. Massive profile in traditional shape with extra thick edges and curved blade to produce best performance. Manau Cane handle for exceptional shock absorption capability and jerk free performance.

NS 2018 BBF



CRICKET

DO ... DARE ... WIN !!

GLADIATOR - ENGLISH WILLOW

Medium Grade hand selected professional level English Willow cricket bat. Individually handcrafted to achieve an ideal combination of balance and light feel pickup for modern day cricket. Unbleached and naturally air dried. Optimum profile in traditional shape with extra thick edges and curved blade to produce best performance. Manau Cane handle for exceptional shock absorption capability and jerk free performance.

NS 2018 BGL



MAXXIMUSS- ENGLISH WILLOW

Medium Grade hand selected professional level English Willow cricket bat. Individually handcrafted to achieve an ideal combination of balance and light feel pickup for modern day cricket. Unbleached and naturally air dried. Optimum profile in traditional shape with extra thick edges and curved blade to produce best performance. Manau Cane handle for exceptional shock absorption capability and jerk free performance.

NS 2018 BMX



MAXIMA - ENGLISH WILLOW

Medium Grade hand selected intermediate level English Willow cricket bat. Handcrafted to achieve an ideal combination of balance and light feel pickup. Unbleached and naturally air dried. Optimum profile in traditional shape with extra thick edges and curved blade to produce best performance. Manau Cane handle for exceptional shock absorption capability and jerk free performance.

NS 2018 BMA



CRICKET

DO ... DARE ... WIN !!

VIPER - ENGLISH WILLOW

Medium Grade hand selected intermediate level English Willow cricket bat.
 Handcrafted to achieve an ideal combination of balance and light feel pickup.
 Unbleached and naturally air dried.
 Optimum profile in traditional shape with extra thick edges and curved blade to produce best performance.
 Manau Cane handle for exceptional shock absorption capability and jerk free performance.

NS 2018 BVI



INVADER - ENGLISH WILLOW

Medium Grade hand selected intermediate level English Willow cricket bat.
 Handcrafted to achieve an ideal combination of balance and light feel pickup.
 Unbleached and naturally air dried.
 Traditional shape with extra thick edges and curved blade to produce best performance.
 Manau Cane handle for exceptional shock absorption capability and jerk free performance.

NS 2018 BIN



CRUSADER - ENGLISH WILLOW

Medium Grade hand selected intermediate level English Willow cricket bat.
 Handcrafted to achieve an ideal combination of balance and light feel pickup.
 Unbleached and naturally air dried.
 Traditional shape with extra thick edges and curved blade to produce best performance.
 Manau Cane handle for exceptional shock absorption capability and jerk free performance.

NS 2018 BCR



CRICKET

DO ... DARE ... WIN !!

WARRIOR - ENGLISH WILLOW

Medium Grade hand selected intermediate level English Willow cricket bat.
 Handcrafted to achieve an ideal combination of balance and light feel pickup.
 Unbleached and naturally air dried.
 Traditional shape with extra thick edges and curved blade to produce best performance.
 Manau Cane handle for exceptional shock absorption capability and jerk free performance.

NS 2018 BWR



STRICKER - ENGLISH WILLOW

Elementary level English Willow cricket bat.
 Handcrafted to achieve an ideal combination of balance and light feel pickup.
 Painted Back with Pro-Scuff Front Protection Sheet.
 Traditional shape with thick edges and curved blade to produce best performance.
 Manau Cane handle for exceptional shock absorption capability and jerk free performance.

NS 2018 BST



RAIDER - ENGLISH WILLOW

Elementary level English Willow cricket bat.
 Handcrafted to achieve an ideal combination of balance and light feel pickup.
 Painted Back with Pro-Scuff Front Protection Sheet.
 Traditional shape with thick edges and curved blade to produce best performance.
 Manau Cane handle for exceptional shock absorption capability and jerk free performance.

NS 2018 BRR



CRICKET

DO ... DARE ... WIN !!

VIPER PLUS - KASHMIR WILLOW

Top Grade Kashmir Willow cricket bat.
Individually handcrafted to achieve an ideal combination of balance and light feel pickup.
Unbleached and naturally air dried.
Massive profile in traditional shape with extra thick edges and curved blade to produce best performance.
Manau Cane handle for exceptional shock absorption capability and jerk free performance.

NS 2018 BKVP



WARRIOR - KASHMIR WILLOW

Top Grade Kashmir Willow cricket bat.
Individually handcrafted to achieve an ideal combination of balance and light feel pickup.
Unbleached and naturally air dried.
Massive profile in traditional shape with extra thick edges and curved blade to produce best performance.
Manau Cane handle for exceptional shock absorption capability and jerk free performance.

NS 2018 BKWA



WARRIOR T -20 - KASHMIR WILLOW

Top Grade Kashmir Willow cricket bat.
Individually handcrafted to achieve an ideal combination of balance and light feel pickup.
Unbleached and naturally air dried.
Massive profile in traditional shape with extra thick edges and curved blade to produce best performance.
Manau Cane handle for exceptional shock absorption capability and jerk free performance.

NS 2018 BKWT



BLIZZARD - KASHMIR WILLOW

Select Grade Kashmir Willow cricket bat.
Handcrafted to achieve an ideal combination of balance and light feel pickup.
Unbleached and naturally air dried.
Huge profile in traditional shape with extra thick edges and curved blade to produce best performance.
Flexible Cane handle for shock absorption and jerk free performance.

NS 2018 BKBL



BLIZZARD POWER - KASHMIR WILLOW

Select Grade Kashmir Willow cricket bat.
Handcrafted to achieve an ideal combination of balance and light feel pickup.
Unbleached and naturally air dried.
Huge profile in traditional shape with extra thick edges and curved blade to produce best performance.
Flexible Cane handle for shock absorption and jerk free performance.

NS 2018 BKBP



MAXIMA PLUS - KASHMIR WILLOW

Select Grade Kashmir Willow cricket bat.
Handcrafted to achieve an ideal combination of balance and light feel pickup.
Unbleached and naturally air dried.
Huge profile in traditional shape with extra thick edges and curved blade to produce best performance.
Flexible Cane handle for shock absorption and jerk free performance.

NS 2018 BKMP



PRODIGY - KASHMIR WILLOW

Medium Grade Kashmir Willow cricket bat.
Handcrafted to an ideal balance and pickup.
Unbleached and naturally air dried.
Traditional shape with thick edges and curved blade to produce best performance.
Flexible Cane handle for shock absorption and jerk free performance.
NS 2018 BKPR



QUANTUM SUPER - KASHMIR WILLOW

Elementary Level Kashmir Willow cricket bat.
Handcrafted to an ideal balance and pickup.
Unbleached and naturally air dried.
Thick edges and curved blade to produce best performance.
Flexible Cane handle for shock absorption and jerk free performance.
NS 2018 BKQS



QUANTUM - KASHMIR WILLOW

Elementary Level Kashmir Willow cricket bat.
Handcrafted to an ideal balance and pickup.
Unbleached and naturally air dried.
Thick edges and curved blade to produce best performance.
Flexible Cane handle for shock absorption and jerk free performance.
NS 2018 BKQU



CRICKET

DO DARE WIN !!

STREET CRICKET - TENNIS BALL BATS

Top Quality Tennis Ball Play Bats
Handcrafted for superb balance and pickup.
Painted for a premium finish.
Flexible Cane handle for shock absorption
and jerk free performance.

NS 2018 BKSC



CRICKET

STREET CRICKET - BATTING GLOVES

Ultra Light weight batting gloves for Tennis Ball Cricket.
Made from good quality calf leather and PU.
Foam padded fingers for shock absorption on contact with the ball.
Nylon air flow gusset for extra comfort and ventilation during play.
Extra wide cotton wrist band for sweat absorption.

NS 2018 BKSG



STREET CRICKET - KEEPING GLOVES

Ultra Light weight keeping gloves for Tennis Ball Cricket.
Made from strong durable PU.
Rubberized anti-skid palms for super grip.
Cotton lining on inside of cuff.

NS 2018 BKSK



DO DARE WIN !!

BEACH CRICKET SETS - SOFT BALL PLAY

Top Quality Plastic Soft Ball Play Beach Cricket Sets

Consists of :-

- 1x Cricket Bat
- 3x Stumps
- 2x Bails
- 1x Base
- 1x Carry Bag

Available In Kids & Men Sizes
(Size 3 & Size 6)

NS 2018 BCS



CATCH BAT - ENGLISH WILLOW

English Willow Catch Practice cricket bat.
Handcrafted to achieve an ideal combination of balance and light feel pickup.
Traditional shape with thick edges and curved blade to produce best performance.
Manau Cane handle for exceptional shock absorption capability and jerk free performance.
EVA Face for exceptional bounce capability
Painted all around for great aesthetics

NS 2018 BCB



CRICKET

DO DARE WIN !!

ISIS - BATTING GLOVES

Light weight batting gloves with perfect combination of protection and comfort for Level 1 play. Made from Grade 1 calf leather and top quality PU. Superbly foam padded for added comfort to palm and fingers. Fiber inserts on all fingers on both hands for exceptional protection and excellent shock absorption on contact with the ball. Nylon air flow gusset for extra comfort and ventilation during play. Extra wide dual sided cotton wrist band for sweat absorption.

NS 2018 BGI



CARBON - BATTING GLOVES

Light weight batting gloves with perfect combination of protection and comfort. Made from Grade 1 calf leather and top quality PU. Molded finger inserts on index and large fingers of both hands and Fiber inserts on remaining fingers for excellent shock absorption on contact with the ball. Extra protection added to front fingers and sides. Nylon air flow gusset for extra comfort and ventilation during play. Extra wide dual sided cotton wrist band for sweat absorption.

NS 2018 BGC



VIPER - BATTING GLOVES

Traditional sausage style batting gloves with perfect combination of protection and comfort. Made from top grade calf leather and top quality PU. Molded finger inserts on both hands for excellent shock absorption on contact with the ball. Nylon air flow gusset for extra comfort and ventilation during play. Extra wide dual sided cotton wrist band for sweat absorption.

NS 2018 BGV



BRUTE - BATTING GLOVES

Traditional sausage style batting gloves with perfect combination of protection and comfort.
 Made from top grade calf leather and top quality PU.
 Molded finger inserts on both hands for excellent shock absorption on contact with the ball.
 Nylon air flow gusset for extra comfort and ventilation during play.
 Extra wide dual sided cotton wrist band for sweat absorption.

NS 2018 BGB



GLADIATOR - BATTING GLOVES

Light weight batting gloves with perfect combination of protection and comfort.
 Made from high quality calf leather and top quality PU.
 Extra protection added to front fingers and sides.
 Molded finger inserts on both hands for excellent shock absorption on contact with the ball.
 Nylon air flow gusset for extra comfort and ventilation during play.
 Extra wide dual sided cotton wrist band for sweat absorption.

NS 2018 BGG



MAXXIMUSS - BATTING GLOVES

Light weight batting gloves with a great combination of protection and comfort.
 Made from good quality calf leather and PU.
 Extra protection added to front fingers and sides.
 Fiber inserts on fingers for excellent shock absorption on contact with the ball.
 Nylon air flow gusset for extra comfort and ventilation during play.
 Extra wide dual sided cotton wrist band for sweat absorption.

NS 2018 BGMX



WARRIOR - BATTING GLOVES

Light weight batting gloves for intermediate level.
 Made from good quality calf leather and PU.
 Fiber inserts on fingers for excellent shock absorption on contact with the ball.
 Nylon air flow gusset for extra comfort and ventilation during play.
 Extra wide dual sided cotton wrist band for sweat absorption.

NS 2018 BGW



PRODIGY - BATTING GLOVES

Traditional sausage style batting gloves for intermediate level.
 Made from good quality calf leather and top quality PU.
 Cotton Filled Fingers on both hands for shock absorption on contact with the ball.
 Nylon air flow gusset for extra comfort and ventilation during play.
 Cotton wrist band for sweat absorption.

NS 2018 BGP



GEN X - BATTING GLOVES

Traditional sausage style batting gloves for elementary level.
 Made from good quality calf leather and top quality PU.
 Cotton filled fingers on both hands for shock absorption on contact with the ball.
 Nylon air flow gusset for extra comfort and ventilation during play.
 Cotton wrist band for sweat absorption

NS 2018 BGGX



CHALLENGER CRICKET - BATTING GLOVES

Light weight batting gloves for elementary level.
 Made of good quality PU and half calf leather palm.
 Fiber inserts on fingers for shock absorption on contact with the ball.
 Nylon air flow gusset for comfort and ventilation during play.
 Wide cotton wrist band for sweat absorption.

NS 2018 BGCH



RAGE BATTING PADS

Professional light weight leg guard with Level 1 protection. High density foam padding with extra wide foam side flaps for highest level of protection and unparalleled comfort.

Strong and durable wipe clean PU facing for great aesthetics.

Tri section PVC bolster filled with HD foam.

Cross stitched extra wide Velcro straps for added comfort and to avoid muscle strain.

Contoured knee cap for enhanced knee protection.

Wear resistant PVC instep with leather flap at the bottom with hard wearing piping for extra protection at the toe.

NS 2018 BPR



BRUTE BATTING PADS

Professional quality traditionally styled leg guard. Strong and durable wipe clean PU facing for great aesthetics.

Cotton stuffed with cane reinforced construction. Extra 'C' shaped padding provided for excellent protection and comfort.

Tri section PVC bolster filled with HD foam.

Wear resistant PVC instep with hard wearing piping for extra durability.

NS 2018 BPB



MAXXIMUSS BATTING PADS

Stylish light weight high density foam leg guard for modern day game.

Strong and durable wipe clean PU facing for great aesthetics.

Cotton stuffed with cane reinforced construction.

Especially designed EVA Foam padding for great comfort and protection.

Extra wide Velcro straps for added comfort and to avoid muscle strain.

Wear resistant PVC instep with hard wearing piping for extra durability.

NS 2018 BPMX



WARRIOR BATTING PADS

Light weight high density foam leg guard especially designed for intermediate level.
 Strong and durable wipe clean PU facing for great aesthetics.
 Especially designed EPE foam padding for great comfort and protection.
 Tri section PVC bolster filled with HD foam.
 Extra wide Velcro straps for added comfort .
 and to avoid muscle strain.
 Wear resistant PVC instep with hard wearing piping for extra durability.

NS 2018 BPW



PRODIGY BATTING PADS

Intermediate level traditionally styled leg guard.
 Strong and durable wipe clean PU facing.
 Velcro straps for added comfort
 Wear resistant PVC instep with hard wearing piping for extra durability.

NS 2018 BPP



GEN-X BATTING PADS

Elementary level traditionally styled leg guard.
 Super light Weight Pads made from EPE Foam.
 Velcro straps for added comfort.

NS 2018 BPGX



VIPER - WICKET KEEPING GLOVES

Professional level top of the range keeping gloves.
 Made from finest quality leather. Leather palm, cuff and back.
 Rubberized anti-skid palms with octopus style ribs for better grip.
 Towel lining on inside of cuff.

NS 2018 WKGV



BLIZZARD - WICKET KEEPING GLOVES

Intermediate level keeping gloves.
 Made from strong durable PU.
 Rubberized anti-skid palms for super grip.
 Cotton lining on inside of cuff.

NS 2018 WKGB



VIPER - WICKET KEEPING PADS

Professional light keeping pads.
 Combination construction with high density foam and cotton reinforced with cane.
 Strong wipe clean PU facing for great aesthetics.
 Tri-section PVC bolster filled with HD foam.
 Extra wide Velcro straps for added comfort and reduced muscle strain.
 Wear resistant PVC instep with hard wearing piping for extra durability.

NS 2018 WKPV



BLIZZARD - WICKET KEEPING PADS

Intermediate level traditionally styled keeping pads.
 Strong and durable wipe clean PU facing.
 Velcro straps for added comfort
 Wear resistant PVC instep with hard wearing piping for extra durability.

NS 2018 WKPB



CRICKET

DO ... DARE ... WIN !!

BRUTE - THIGH GUARD

NS 2018 TPB

- EVA Sheet Construction with Full Fiber Insert
- Toweled Back
- 50mm Double Sided Elastic Band



BRUTE - INNER THIGH GUARD

NS 2018 ITB

- EVA Sheet Construction with Full Fiber Insert
- Toweled Back
- 38mm Double Sided Elastic Band



SUPER - THIGH GUARD

NS 2018 TPS

- EPE Sheet Construction with Half Fiber Insert
- 32mm Elastic Band



GEN - X - THIGH GUARD

NS 2018 TPGX

- EPE & EVA Sheet Combination with Full Fiber Insert
- 32mm Elastic Band



BRUTE - ELBOW GUARD

NS 2018 ELB

- EVA Sheet Construction with Full Fiber Insert
- Toweled Back
- 38mm Double Sided Elastic Band



SUPER - ELBOW GUARD

NS 2018 ELS

- EPE Sheet Construction with Half Fiber Insert
- 32mm Elastic Band



GEN - X - ELBOW GUARD

NS 2018 ELGX

- EPE & EVA Sheet Combination with Full Fiber Insert
- 32mm Elastic Band



VIPER - ABDOMINAL GUARD

NS 2018 AGV

- Moulded Plastic Protection
- with Soft Foam Stitched Seam



CRICKET

DO ... DARE ... WIN !!

MAXXISTAR - HELMET

Professional Fabric Coated C.P. helmet with exceptional impact resistance and dissipation capability. Moulded inner protective head guard on the inside of the shell.

Removable padded sweat absorbent fabric on the inside to keep forehead dry.

Fully adjustable face visor made from tempered steel with moulded ear guards.

NS 2018 HMS

**MAXXIARMOUR - HELMET**

Professional Fabric Coated C.P. helmet with exceptional impact resistance and dissipation capability.

Adjustable back strap for snug fit.

Removable padded sweat absorbent fabric on the inside to keep forehead dry.

Fully adjustable face visor made from tempered steel with moulded ear guards.

NS 2018 HMA

**MAXXIGUARD - HELMET**

Intermediate Level Fabric Coated C.P. helmet with superb impact resistance capability.

Padded sweat absorbent fabric on the inside to keep forehead dry.

Fully adjustable face visor made from tempered steel with moulded ear guards.

NS 2018 HMG

**MAXXICOVER - HELMET**

Intermediate Level Bare C.P. helmet with superb impact resistance capability.

Netted vents for excellent air flow helps in keeping the players head cool even in hot weather conditions.

Padded sweat absorbent fabric on the inside to keep forehead dry.

Fully adjustable face visor made from tempered steel with moulded ear guards.

NS 2018 HMC



CARBON - STROLLEY

N 2016 BCS

SIZE : 40"L x 16"W x 14"H

- Sport Kit Bag with Strong Trolley
- 3 Wheels for smooth movement
- 3 Front Pockets & 1 Shoe Pocket
- 600 Denier Polyester Fabric

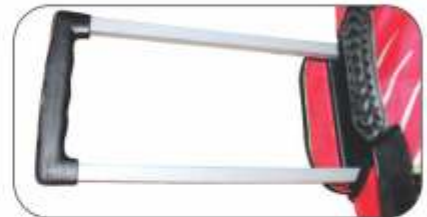

CARBON - WHEELIE

N 2016 BCW

SIZE : 36"L x 14"W x 13"H

- Sport Kit Bag with Wheels
- 2 Wheels for smooth movement
- 2 Front Pockets & 1 Shoe Pocket
- 600 Denier Polyester Fabric



MAXXIMUSS - WHEELIE

N 2016 BMX

SIZE : 36"L x 14"W x 13"H

- Sport Kit Bag with Wheels
- 1 Wheels for smooth movement
- 1 Front Pocket & 1 Shoe Pocket
- 600 Denier Polyester Fabric



CLUB - WHEELIE

N 2016 BC1

SIZE : 36" L x 10" W x 13" H

- Sport Kit Bag with Wheels
- 2 Wheels for smooth movement
- 600 Denier Polyester Fabric



CLUB - WHEELIE

N 2016 BC2

SIZE : 27" L x 10" W x 13" H

- Sport Kit Bag with Zip opening for Bat
- 600 Denier Polyester Fabric



INVADER - DUFFLE

N 2016 BID

SIZE : 8" D x 14" W x 31" H

- Sport Duffle Bag with String closure
- Cross Sling Shoulder Strap
- 600 Denier Polyester Fabric



PRODIGY

N 2016 BPG

SIZE : 28" L x 11" W x 9" H

- Sport Kit Bag with Zip opening for Bat
- 600 Denier Polyester Fabric



MAXIMA - BACK PACK

N 2016 MBP

SIZE : 9" D x 14" W x 28" H

- Sport Bag with Shoulder Straps
- 1 Bat & 2 Front Pockets, 1 Bottle Holder
- 600 Denier Polyester Fabric
- Also Available with Wheels - N2016 MBPW



SPORT BAGS

DO DARE WIN !!

PRO - BACK PACK

N 2016 BP1

SIZE : 10"D x 13"W x 23"H

- Athlete Back Pack with Shoulder Straps
- Separate Compartments for Wet/Dry Clothes
- 1 Shoe Pocket & 2 Bottle Holders
- 600 Denier Polyester Fabric



CLUB - BACK PACK

N 2016 BP2

SIZE : 6"D x 14"W x 20"H

- Athlete Back Pack with Shoulder Straps
- 2 Compartments with Laptop Sleeve
- 1 Front Pocket & 2 Bottle Holders
- 600 Denier Polyester Fabric



PRO - GYM DUFFLE

N 2016 BG1

SIZE : 20"L x 10"W x 13"H

- Gym Duffle Bag
- 2 Side Pockets & 1 Shoe Pocket
- 600 Denier Polyester Fabric



CLUB - GYM BAG

N 2016 BG2

SIZE : 20"L x 10"W x 10"H

- Gym Bag with 2 Side Pockets
- 600 Denier Polyester Fabric



SPORT BAGS

DO DARE WIN !!

REMARKS ..

A series of horizontal dotted lines for writing remarks.

Melco™
DO ... DARE ... WIN !!