

Etsilon



Temperature Controller

TC602

Features

- ▶ 4+4 digits, 7 segment LED dual display
- ▶ Auto tune / Self tune PID
- ▶ PID / ON-OFF control
- ▶ TC / RTD input
- ▶ Dwell timer
- ▶ Two set points
- ▶ 72 x 72mm size
- ▶ Field selectable control output (Relay or SSR)
- ▶ Auxiliary output: Relay

INDEX

CONTENTS

Page No.

A) SAFETY PRECAUTIONS

SAFETY SUMMARY.....	03
INSTALLATION GUIDELINES.....	03
LOAD CONNECTION.....	03
ELECTRICAL PRECAUTIONS.....	03

B) OVERVIEW

SPECIFICATIONS.....	04
LED INDICATIONS AND DISPLAY.....	05
KEY DESCRIPTION.....	05
MECHANICAL INSTALLATION.....	06

C) WIRING GUIDELINES

WARNING.....	06
TERMINAL CONNECTION.....	07

D) PROGRAMMING.....07

E) USER GUIDE.....09

F) CALIBRATION CERTIFICATE.....11

A) SAFETY PRECAUTIONS

⚠ SAFETY SUMMARY

All safety related modifications, symbols and instructions that appear in this operating manual or on the equipment must be strictly followed to ensure the safety of the operating personnel as well as the instrument.

If the equipment is not handled in a manner specified by the manufacturer it might impair the protection provided by the equipment.

- Read complete instructions prior to installation and operation of the unit.

⚠ **WARNING:** Risk of electric shock.

INSTALLATION GUIDELINES

⚠ INSTALLATION GUIDELINES:

1. This equipment, being built-in-type, normally becomes a part of main control panel and in such case the terminals do not remain accessible to the end user after installation and internal wiring.
2. Do not allow pieces of metal, wire clippings, or fine metallic fillings from installation the product or else it may lead to a safety hazard that may in turn endanger life or cause electrical shock to the operator.
3. Circuit breaker or mains switch must be installed between power source and supply terminals to facilitate power 'ON' or 'OFF' function. However this switch or breaker must be installed in a convenient position normally accessible to the operator.
4. Use and store the temperature controller within the specified ambient temperature and humidity ranges as mentioned in this manual.

⚠ CAUTION:

1. When powering up for the first time, disconnect the output connections.
2. Fuse protection: The unit is normally supplied without a power switch and fuses. Make wiring so that the fuse is placed between the mains power supply switch and the controller. (2 pole breaker fuse-rating: 275V AC, 1A for electrical circuitry is highly recommended)
3. Since this is a built-in-type equipment (finds place in main control panel), its output terminals get connected to host equipment. Such equipment shall also comply with basic EMI/EMC and other safety requirements like BSEN61326-1 and BSEN61010 respectively.
4. Thermal dissipation of equipment is met through ventilation holes provided on chassis of equipment. Such ventilation holes shall not be obstructed else it can lead to a safety hazard.
5. The output terminals shall be strictly loaded to the manufacturer specified values/range.

LOAD CONNECTION

1. The service life of the output relays depends on the switching capacity and switching conditions. Consider the actual application conditions and use the product within the rated load and electrical service life.
2. Although the relay output is rated at 10 amps it is always necessary to use an interposing relay or contactor that will switch the load. This avoids damage to the controller in the event of a fault short developing on the power output circuit.
3. Always use a separate fused supply for the "power load circuit" and do not take this from the live and neutral terminals supplying power to the contactor.

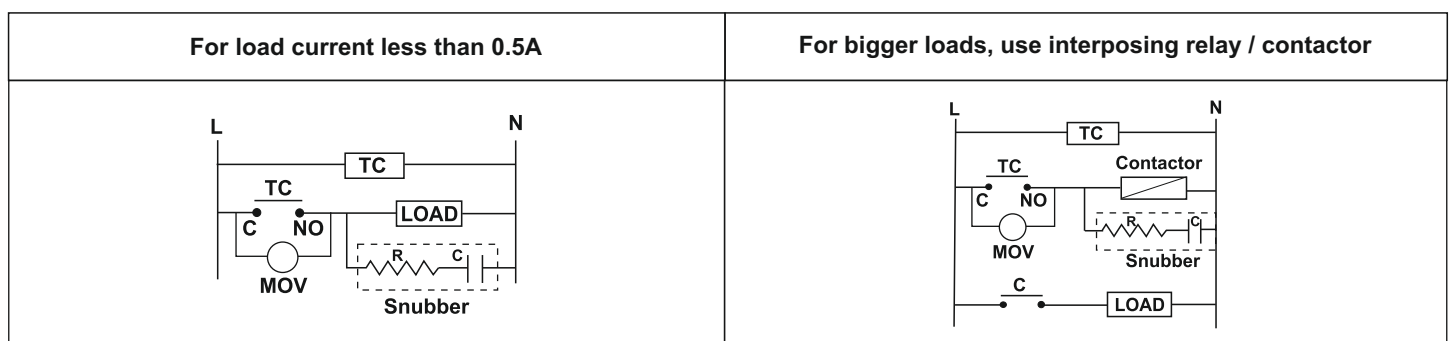

ELECTRICAL PRECAUTIONS DURING USE

Electrical noise generated by switching of inductive loads can create momentary disruption, erratic display, latch up, data loss or permanent damage to the instrument.

To reduce noise:

- a) Use of snubber circuits across loads as shown above, is recommended.
- b) Use separate shielded wires for inputs.

B) OVERVIEW

SPECIFICATIONS

1. DISPLAY

Display	4 + 4 digits (white + green) 7 segment digital display Display height: White display: 16.7mm, Green display: 9mm
LED indications	OUT1: Output 1 ON OUT2: Output 2 ON AT: Auto tune SOAK: Dwell timer*
Keys	3 keys for digital setting

2. INPUT

Input signal	Thermocouple (J, K, T, R, S) RTD (PT100)
Sampling time	250 ms
Input filter (FTC)	0.2 to 10.0 sec
Resolution	0.1/1° for TC/RTD inputs (fixed 1° for R & S input)
Temperature unit	°C/°F selectable
Indication accuracy	For TC inputs: 0.25% of FS ±1° For R & S inputs: 0.5% of FS ±1° (30 min of warm up time) For RTD inputs: 0.1% of FS ±1°

3. FUNCTIONAL SPECIFICATIONS

Control method	1) PID control with auto tuning & self tuning 2) ON-OFF control 3) Heat-Cool (with auto-tuning)
Proportional band (P)	1.0 to 400.0°
Integral time (I)	0 to 9999 sec
Derivative time (D)	0 to 9999 sec
Cycle time	0.1 to 99.9 sec
Hysteresis width	0.1 to 99.9°
Dwell timer	0 to 9999 min
Hysteresis width	0.1 to 99.9°
Manual reset value	-19.9 to 19.9°

4. HEAT COOL PID

Control method	PID
Proportional band-cool	0.0 to 400.0 °C
Cycle time-cool	0.1 to 99.9 sec
Dead band	SPLL to SPHL (programmable)

5. OUTPUT

Control output	Relay contact (SPDT) 5A @250V AC / 24V DC, Resistive
	SSR drive output (voltage pulse) 12V DC, 50mA
Auxiliary output	Relay contact (SPDT) 5A @250V AC / 24V DC, Resistive

6. POWER SUPPLY

Supply voltage	90 to 270V AC/DC, 50/60 Hz, 5VA max
Temperature	Operating: 0 to 50 °C, Storage: -20 to 75 °C
Humidity	95% RH (non-condensing)
Weight	164 gm

LED INDICATIONS AND DISPLAY

1 Process-value (PV) / Parameter name display	1) Displays a process value (PV) 2) Displays the parameter symbols at configuration mode/online menu 3) Displays PV error conditions
2 Parameter setting display	Displays the parameter settings at configuration mode / online menu
3 Control output 1 indication	The OUT1 is light when the control output 1 is ON
4 Control output 2 indication	The OUT2 is light when the control output 2 is ON
5 Tune	Auto tune (AT): Blinking
6 Dwell timer	SOAK Blinking: Dwell timer is in progress SOAK Continuous ON: Time over

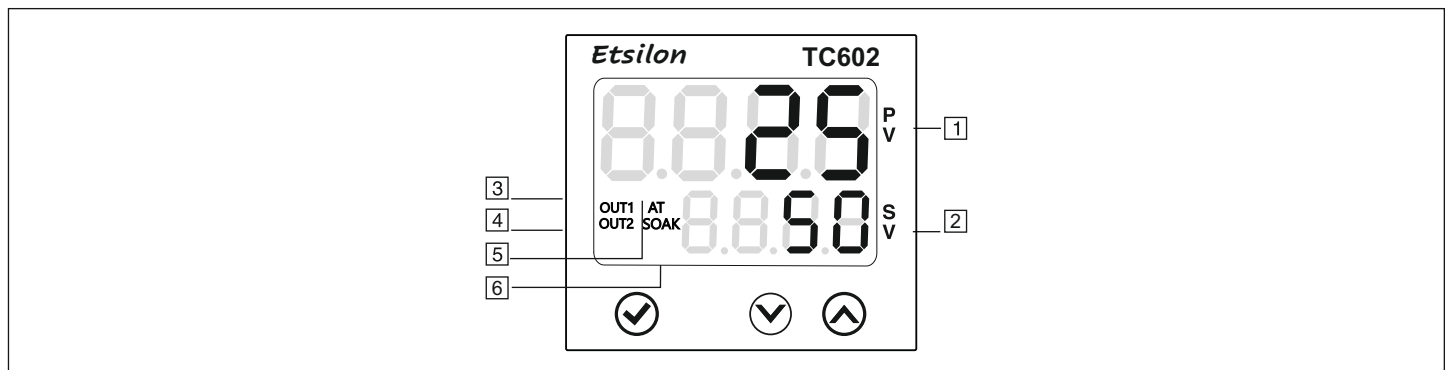

KEY DESCRIPTION

Functions	Key press
Online	
To view level 1	Press key for 3 sec
To view level 2	Press key for 3 sec
To view protection level	Press + keys for 3 sec
To change parameter value	Press + / key to change the parameter
To view online parameter	Lower display selectable between SET1/SET2/TIME using key
NOTE: Elapsed time / Remaining time dependent on the selection of ONL parameter in level1	
To change online parameter values	Press + / key to change parameter value

MECHANICAL INSTALLATION

1. Prepare the panel cutout with proper dimensions as shown below.
2. Remove the clamp from the controller and push the controller into the panel cutout. Insert the clamp from the rear side until the main unit is securely fit into the panel.
3. The equipment in its installed state must not come in close proximity to any heating sources, caustic vapors, oils, steam, or other unwanted process by-products.
4. Use the specified size of crimp terminals (M3.5 screws) to wire the terminal block. Tighten the screws on the terminal block using the tightening torque within the range of 1.2 N.m.
5. Do not connect anything to unused terminals.

PANEL THICKNESS

0.5mm (minimum) and 2.5mm (maximum)

EMC Guidelines:

1. Use proper input power cables with shortest connections and twisted type.
2. Layout of connecting cables shall be away from any internal EMI source.

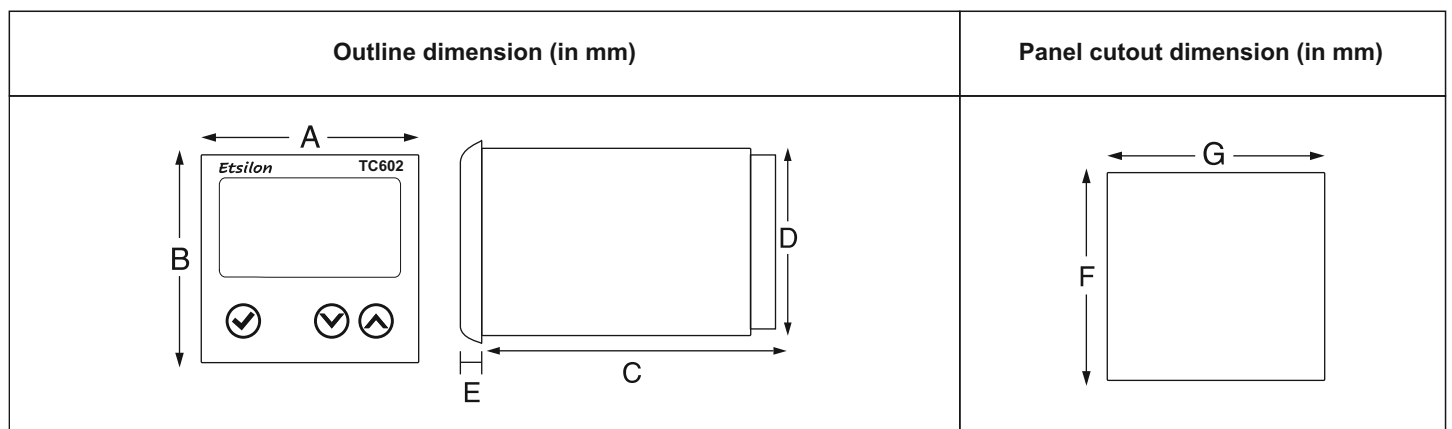

MODELS	DIM	A	B	C	D	E	F	G
TC602		76	76	44	67	4.5	69	69

C) WIRING GUIDELINES

⚠ WARNING

1. To prevent the risk of electric shock power supply to the equipment must be kept OFF while doing the wiring arrangement. Do not touch the terminals while power is being supplied.
2. To eliminate electromagnetic interference use short wire with adequate ratings; twists of the same in equal size shall be made. For the input and output signal lines, be sure to use shielded wires and keep them away from each other.
3. Cable used for connection to power source, must have a cross section of 1mm² or greater. These wires shall have insulation capacity made of at least 1.5kV.
4. When extending the thermocouple lead wires, always use thermocouple compensation wires for wiring. For the RTD type, use a wiring material with a small lead resistance (50 max per line) and no resistance differentials among three wires.
5. A better anti-noise effect can be expected by using standard power supply cable for the instruments.

MAINTENANCE

1. The equipment should be cleaned regularly to avoid blockage of ventilating parts.
2. Clean the equipment with a clean soft cloth. Do not use Isopropyl alcohol or any other cleaning agent.

TERMINAL CONNECTIONS

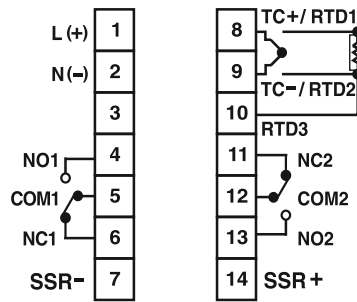

Use only the correct thermocouple wire or compensating cable from the probe to instrument terminals avoiding joints in the cable if possible. Failure to use the correct wire type will lead to inaccurate readings. Ensure that the input sensor connected at the terminals and the input type set in the temperature controller configuration are the same.

D) PROGRAMMING

LEVEL 1-PRESS KEY FOR 3 SECONDS

DISPLAY	DESCRIPTION	DEFAULT VALUE	RANGE	DISPLAY CONDITION
INPT	Input type (refer table 1)	J	J, K, T, R, S & RTD	—
COMP	Compensation cable connected	YES	YES / NO	—
RESL	Display resolution	1	1/0.1	Not prompted for R & S type
UNIT	Temperature unit	°C	°C/°F	—
SPLL	Set point low limit	-199	Min range of sensor selected to SPHL	—
SPHL	Set point high limit	750	SPLL to Max range of sensor selected	—
FIL	Filter time constant	1.0	0.2 to 10.0 sec	—
ACT1	Control action for relay 1	RE	RE/FD	Not prompted for HC=YES
CNTL	Control logic	PID	PID / ONF	—
OUT	Control output selection	RLY	RELAY / SSR	—
DWEL	Dwell mode enable	NO	NO / YES	—
HC	Heat-cool mode selection	NO	NO / YES	—
ACT2	Control action for relay 2	RE	RE / FD / TIME*	When HC=NO. TIME prompted when DWEL=YES
REL2	Relay 2 type	DEV	DEV/ABS	When ACT2=RE/FD
ONL	Online menu for timer	REAN	REM/ELPS	When DWEL=YES
AWUP	Anti-reset windup %	25.0	1.0 to 100.0%	When CNTL=PID
RSR	Factory default (reset all)	NO	NO / YES	—



LEVEL 1-PRESS KEY FOR 3 SECONDS





DISPLAY	DESCRIPTION	DEFAULT VALUE	RANGE	DISPLAY CONDITION
፲፱ብ፻	Tune	5፻	ST / AT / OFF	For CNTL=PID
P	Proportional band	10	1.0 to 400.0°	For CNTL=PID
I	Integral time	120	0 to 9999 sec	For CNTL=PID
D	Derivative time	30	0 to 9999 sec	For CNTL=PID
ርሃርሱ	Cycle time mode	፱፻፲፬	AUTO/USR.F	For CNTL=PID
ርሃር፻	Cycle time	15.0	0.1 to 99.9 sec	For CNTL=PID
ዘሃና1	Hysteresis 1	1.0	0.1 to 99.9°	For CNTL=ONF
ሱቢ፲፱	Manual reset	0.0	-19.9 to +19.9°	For CNTL=PID & I=0
P፬፻	Proportional band-cool	10	1.0 to 400.0°	For CNTL=PID & HC=YES
ርሃ፻፻	Cycle time-cool	15.0	0.1 to 99.9 sec	For CNTL=PID & HC=YES
ዘሃና2	Hysteresis 2	1.0	0.1 to 99.9 deg	For HC=NO or HC=YES* & CNTL=ONF
፻፲ሱ፻	Dwell time	0FF	OFF, 1 to 9999 min	When DWEL= YES
፲፱፻፲፬	Display bias	0.0	-19.9 to 19.9°	—

PROTECTION LEVEL-PRESS + KEYS FOR 3 SECONDS

DISPLAY	DESCRIPTION	DEFAULT VALUE	RANGE	DISPLAY CONDITION
SP1	Lock setpoint 1	ህቢ፻	UNLK / READ	—
SP2	Lock setpoint 2	ህቢ፻	UNLK / READ / LOCK	—
፲፱፻1	Lock level 1	ህቢ፻	UNLK / READ / LOCK	—
፲፱፻2	Lock level 2	ህቢ፻	UNLK / READ / LOCK	—
፲፱፻፲፬	Lock dwell time	ህቢ፻	UNLK / READ / LOCK	Prompted when DWEL=YES

NOTE:

1. Locking parameters (LV1 or LV2 or SP) will not permit change in the value of respective level parameters.
Time value (online) can be altered only when DWEL is not locked in protection level.
2. Continuous operation of  +  /  keys for SP or other parameters makes update speed faster in 3 stages after 3 seconds.
3. Compensation parameter applicable only for thermocouple type sensor.

Programming Setpoint (online):	Default: 50
To view setpoint: Press the  key. To increase/decrease setpoint: Press  +  /  keys	Range: SP.L to SP.H

INPUT RANGES (Table 1) FOR RTD

Input	Ranges		
Input Type	Unit	Resolution: 1	Resolution: 0.1
PT100	°C	-150 to 850	-150 to 850
	°F	-238 to 1562	-199 to 999

FOR THERMOCOUPLE

Input	Ranges		
Input Type	Unit	Resolution: 1	Resolution: 0.1
J	°C	-199 to 750	-199 to 750
	°F	-328 to 1382	-199 to 999
K	°C	-199 to 1350	-199 to 999
	°F	-328 to 2462	-199 to 999
T	°C	-199 to 400	-199 to 400
	°F	-328 to 750	-199 to 750
R & S	°C	0 to 1750	N/A
	°F	32 to 3182	N/A

ERROR DISPLAY (table 2)

When an error has occurred, the display indicates error codes as given below.

Error	Meaning	Control Output Status
S.b P	Sensor break / Over range condition	OFF
S.P E	Sensor reverse / Under range condition	OFF

E) USER GUIDE

1. Display bias:

This function is used to adjust the PV value in cases where it is necessary for PV value to agree with another recorder or indicator, or when the sensor cannot be mounted in correct location.

2. Filter time constant:

The input filter is used to filter out quick changes that occur to the process variable in a dynamic or quick responding application which causes erratic control. The digital filter also aids in controlling processes where the electrical noise affects the input signal. Larger the value of FTC entered, greater the filter added and the slower the controller reacts to the process and vice versa.

3. Auto tuning:

The Auto-tuning function automatically computes and sets the proportional band (P), integral time (I), Derivative time (D), ARW% and cycle time (CY.T) as per process characteristics.

- Decimal point of LSD flashes at faster speed while auto-tuning is being performed.
- At the completion of Auto-tuning, the decimal point stops blinking.

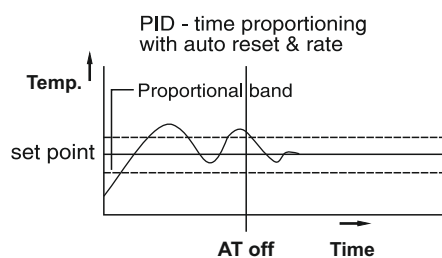

- If the power goes OFF before auto-tuning is completed, auto-tuning will be restarted next at power ON.
- If auto-tuning is not completed after 3-4 cycles, the auto-tuning is suspected to fail. In this case, check the wiring & parameters such as the control action, input type, etc.
- Carry out the auto-tuning again, if there is a change in set point or process parameters.

4. ON / OFF control action (for reverse mode):

The relay is 'ON' up to the set temperature and cuts 'OFF' above the set temperature. As the temperature of the system drops, the relay is switched 'ON' at a temperature slightly lower than the set point. temperature slightly lower than the set point.

HYSTERESIS:

The difference between the temperature at which relay switches 'ON' and at which the relay switches 'OFF' is the hysteresis or dead band.

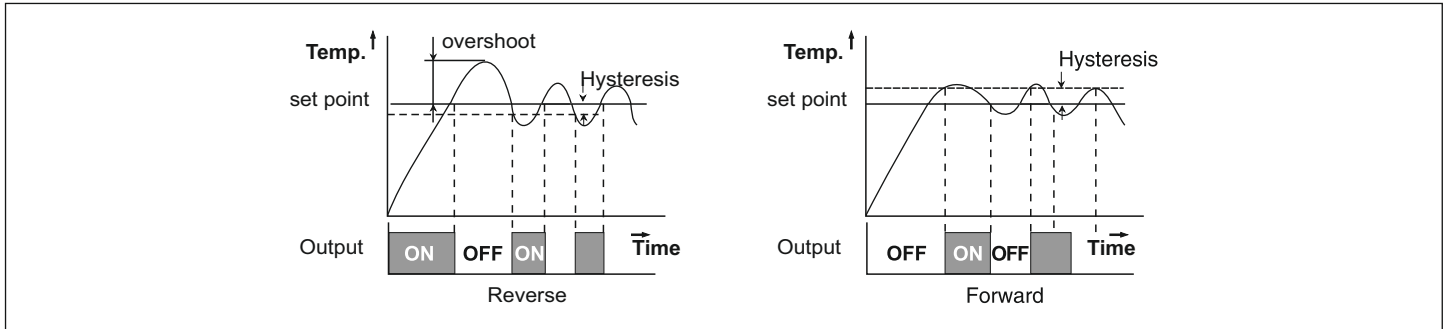

5. Manual reset (for PID control & I=0):

After some time the process temperature settles at some point and there is a difference between the set temperature & the controlled temperature. This difference can be removed by setting the manual reset value equal & opposite to the offset.

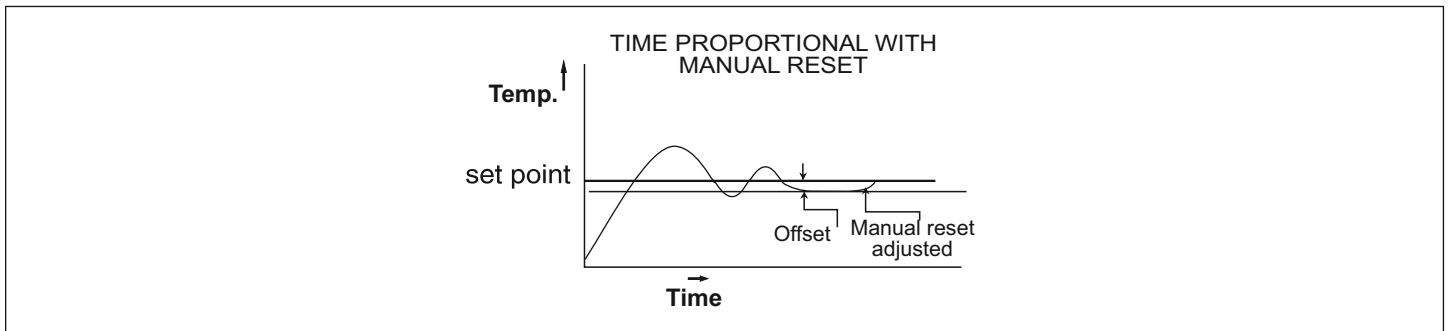

6. Self Tune (ST):

It is used where modification of PID parameters is required repeatedly due to frequent change in process condition eg. Set point.

- Tune LED blinks at slower rate when Self-Tuning is in progress.
- At the completion of self-tuning, Tune LED stop blinking.
- Self-tuning is initiated under the following conditions:
 - 1) When set point is altered.
 - 2) When tune mode is altered. (TUNE=ST)
- ST will start only if PV < 50% of set point.
- ST will work only when ACT=RE.

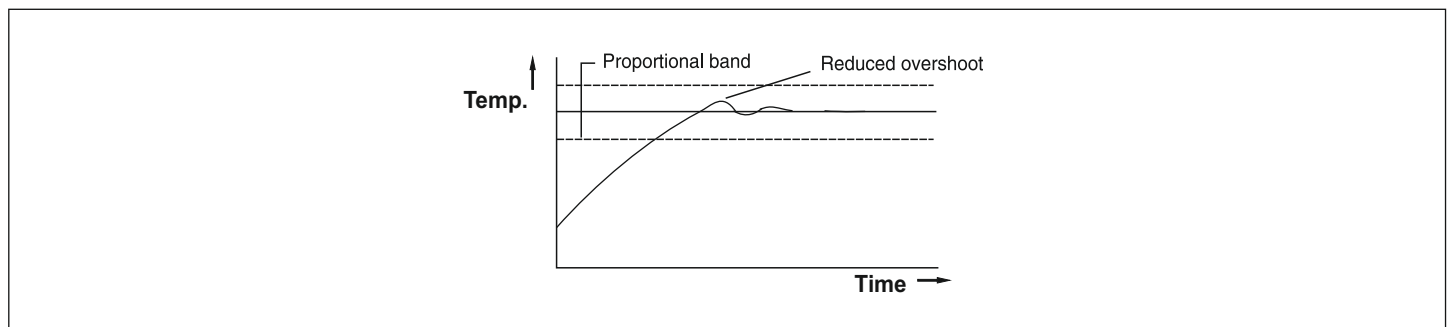

7. Thermocouple compensation:

COMP=YES

Configure Yes if compensating cable is connected as thermocouple extension. Yes should also be configured in the case if the sensor is directly connected to the terminal without extension.

COMP=NO

Configure No if non-compensating cable is connected as thermocouple extension.

F) CALIBRATION CERTIFICATE

Model No: TC602

Claimed accuracy: For TC inputs 0.25% of FS ± 1 °C
 For R & S inputs: 0.5% of F.S ± 2 °C (30 min of warm up time for TC input)
 For RTD inputs: 0.1% of FS ± 1 °C

Standard used for calibration of product is traceable to NABL

The calibration of this unit has been verified at the following values:

SENSOR SELECTION	VERIFICATION VALUE (°C)
K	25.0
	475.0
	975.0
RTD	0.0
	323.5
	800.0

Note: The verification values are approximate values with + 5 °C range.

The thermocouple / RTD curves are linearised in this microprocessor based product, and hence the values interpolated between the readings shown above are also equally accurate, at every point in the curve.

Unit is accepted as accuracy is within the specified limit of claimed accuracy and certificate is valid upto one year from the date of issue.

Etsilon

Factory Address : EL-27/1, Electronic Zone, TTC Industrial Area, MIDC, Mahape, Navi Mumbai - 400710, India.

Website : www.etsilon.com | **Customer Care No.** 7304413724 | **Email :** support@etsilon.com

For Service : Tel. No. : 9136977317 | **Email :** service@etsilon.com