

Etsilon



Temperature Controller

TC612

Features

- ▶ 3 digits, 7 segment LED single display
- ▶ TC / RTD inputs
- ▶ ON-OFF / PID control
- ▶ Auto tuning / Self tuning
- ▶ Single set point
- ▶ 72 x 72mm size
- ▶ Field selectable control output (Relay or SSR)

INDEX

CONTENTS

Page No.

A) SAFETY PRECAUTIONS

SAFETY SUMMARY.....	03
INSTALLATION GUIDELINES.....	03
LOAD CONNECTION.....	03
ELECTRICAL PRECAUTIONS.....	03

B) OVERVIEW

SPECIFICATIONS.....	04
LED INDICATIONS AND DISPLAY.....	05
KEY DESCRIPTION.....	05
MECHANICAL INSTALLATION.....	05

C) WIRING GUIDELINES

WARNING.....	06
TERMINAL CONNECTION.....	06

D) PROGRAMMING.....07

E) USER GUIDE.....08

F) CALIBRATION CERTIFICATE.....10

A) SAFETY PRECAUTIONS

⚠ SAFETY SUMMARY

All safety related modifications, symbols and instructions that appear in this operating manual or on the equipment must be strictly followed to ensure the safety of the operating personnel as well as the instrument.

If the equipment is not handled in a manner specified by the manufacturer it might impair the protection provided by the equipment.

- Read complete instructions prior to installation and operation of the unit.

⚠ **WARNING:** Risk of electric shock.

INSTALLATION GUIDELINES

⚠ INSTALLATION GUIDELINES:

1. This equipment, being built-in-type, normally becomes a part of main control panel and in such case the terminals do not remain accessible to the end user after installation and internal wiring.
2. Do not allow pieces of metal, wire clippings, or fine metallic fillings from installation the product or else it may lead to a safety hazard that may in turn endanger life or cause electrical shock to the operator.
3. Circuit breaker or mains switch must be installed between power source and supply terminals to facilitate power 'ON' or 'OFF' function. However this switch or breaker must be installed in a convenient position normally accessible to the operator.
4. Use and store the temperature controller within the specified ambient temperature and humidity ranges as mentioned in this manual.

⚠ CAUTION:

1. When powering up for the first time, disconnect the output connections.
2. Fuse protection: The unit is normally supplied without a power switch and fuses. Make wiring so that the fuse is placed between the mains power supply switch and the controller. (2 pole breaker fuse-rating: 275V AC, 1A for electrical circuitry is highly recommended)
3. Since this is a built-in-type equipment (finds place in main control panel), its output terminals get connected to host equipment. Such equipment shall also comply with basic EMI/EMC and other safety requirements like BSEN61326-1 and BSEN61010 respectively.
4. Thermal dissipation of equipment is met through ventilation holes provided on chassis of equipment. Such ventilation holes shall not be obstructed else it can lead to a safety hazard.
5. The output terminals shall be strictly loaded to the manufacturer specified values/range.

LOAD CONNECTION

1. The service life of the output relays depends on the switching capacity and switching conditions. Consider the actual application conditions and use the product within the rated load and electrical service life.
2. Although the relay output is rated at 10 amps it is always necessary to use an interposing relay or contactor that will switch the load. This avoids damage to the controller in the event of a fault short developing on the power output circuit.
3. Always use a separate fused supply for the "power load circuit" and do not take this from the live and neutral terminals supplying power to the contactor.

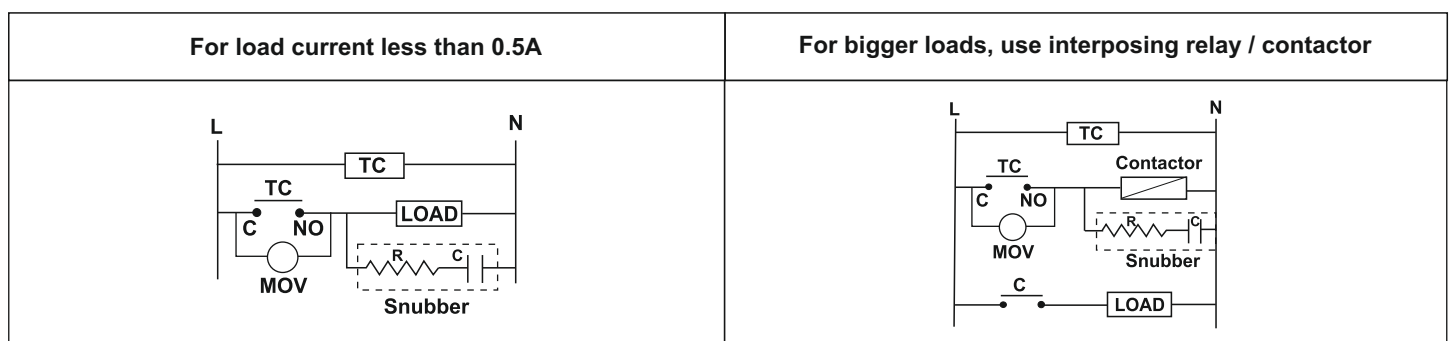

ELECTRICAL PRECAUTIONS DURING USE

Electrical noise generated by switching of inductive loads can create momentary disruption, erratic display, latch up, data loss or permanent damage to the instrument.

To reduce noise:

- a) Use of snubber circuits across loads as shown above, is recommended.
- b) Use separate shielded wires for inputs.

B) OVERVIEW

SPECIFICATIONS

1. DISPLAY

Display	3 digits (white), 7 segment digital display Display height: 21mm
LED Indications	OUT: Control output ON
Keys	3 Keys for digital setting

2. INPUT

Input	Thermocouple (J, K, T, R, S) RTD (PT100)
Sampling time	250 ms
Input filter (FTC)	0.2 to 10.0 sec
Resolution	Fixed 1° resolution
Temperature unit	°C/°F selectable
Indication accuracy	For TC inputs: 0.25% of FS ±1° For R & S inputs: 0.5% of FS ±1° (30 min of warm up time) For RTD inputs: 0.1% of FS ±1°

3. FUNCTIONAL SPECIFICATION

Control method	1) PID control with auto or self tuning 2) ON-OFF control
Proportional band (P)	1 to 400 °C, 1 to 752 °F
Integral time (I)	0.0 to 99.9 min
Derivative time (D)	0 to 999 sec
Cycle time	0.1 to 99.9 sec
Hysteresis width	0.1 to 99.9°
Manual reset value	-19.9 to 19.9°
Hysteresis width	0.1 to 99.9°
Manual reset value	-19.9 to 19.9 °C/°F

4. OUTPUT

Control output Relay or SSR	Relay contact (SPDT) 10A @250V AC / 24V DC, Resistive
	SSR drive output (Voltage pulse) * 12V DC, 50mA

5. POWER SUPPLY







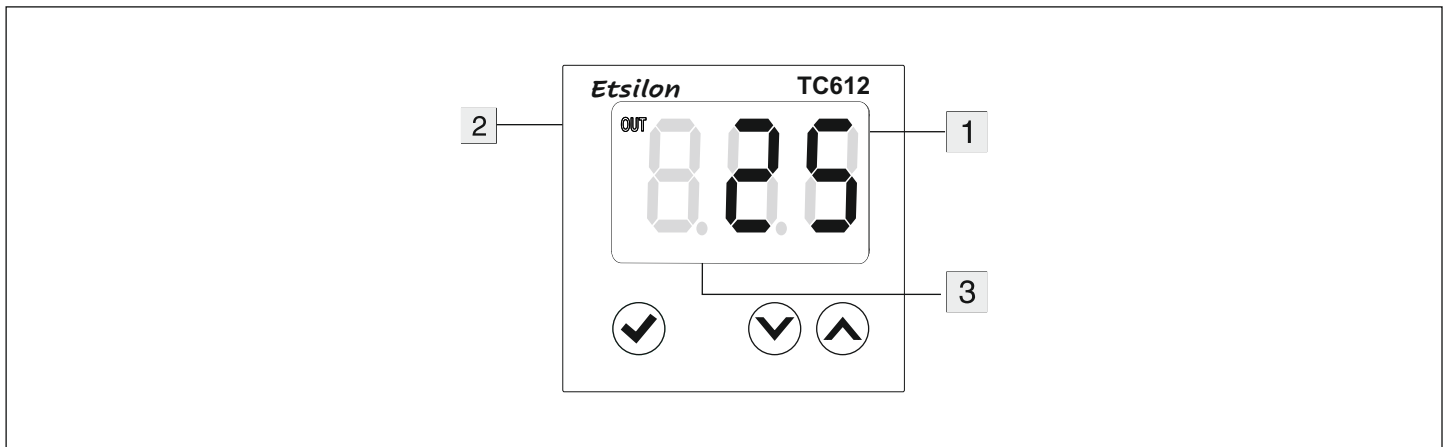









Supply voltage	90 to 270V AC/DC, 50/60 Hz, 5VA max
Temperature	Operating: 0 to 50 °C, Storage: -20 to 75 °C
Humidity	95% RH (non-condensing)
Weight	148gm





LED INDICATIONS AND DISPLAY

1 Process-value (PV)/ Parameter name display	1) Displays a process value (PV). 2) Displays the parameter symbols at parameter setting mode for 1 sec and then parameter values. 3) Displays PV error conditions. (refer table 2)
Set-value (SV)	4) Displays a set value (SV) when  key pressed.
2 Control output indication	The OUT is light when the control output is ON
3 Tune	1) Auto tune: Blinking at faster speed. 2) Self tune: Blinking at slower speed.



KEYS DESCRIPTION

Functions	Key press
Online	
To view level 1	Press  key for 3 sec
To view level 2	Press  key for 3 sec
To view protection level	Press  +  keys for 3 sec
To change the associated parameter	Press  +  /  key to change the parameter
To view and change set point value	Press  to view the set point Press  +  /  key to change the set point
Programming mode	
To view parameters on the same level.	 or  key once to view the next or previous function in operational menu
To increase or decrease the value of a particular parameter.	 +  to increase and  +  to decrease the function value Note: Parameter value will not alter when respective level is locked

NOTE: The unit will auto exit programming mode after 30 seconds of inactivity. **OR** By pressing the  or  or  +  keys for 3 sec.

MECHANICAL INSTALLATION

1. Prepare the panel cutout with proper dimensions as shown below.
2. Remove the clamp from the controller and push the controller into the panel cutout. Insert the clamp from the rear side until the main unit is securely fit into the panel.
3. The equipment in its installed state must not come in close proximity to any heating sources, caustic vapors, oils, steam, or other unwanted process by-products.
4. Use the specified size of crimp terminals (M3.5 screws) to wire the terminal block. Tighten the screws on the terminal block using the tightening torque within the range of 1.2 N.m.
5. Do not connect anything to unused terminals.

PANEL THICKNESS

0.5mm (minimum) and 2.5mm (maximum)

EMC Guidelines:

1. Use proper input power cables with shortest connections and twisted type.
2. Layout of connecting cables shall be away from any internal EMI source.

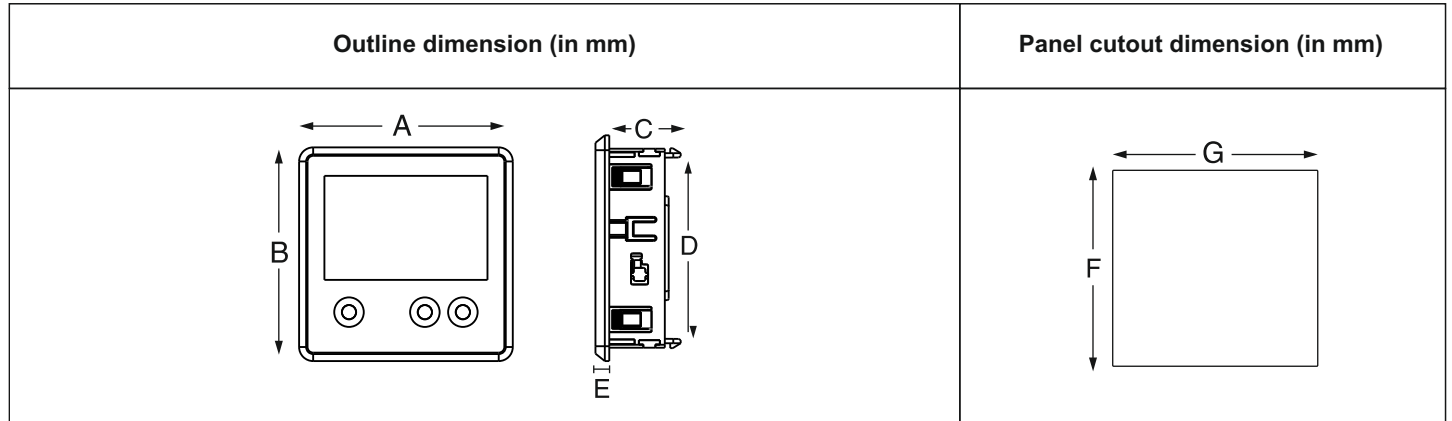

MODELS	DIM	A	B	C	D	E	F	G
TC612		76	76	44	67	4.5	69	69

C) WIRING GUIDELINES

⚠ WARNING

1. To prevent the risk of electric shock power supply to the equipment must be kept OFF while doing the wiring arrangement. Do not touch the terminals while power is being supplied.
2. To eliminate electromagnetic interference use short wire with adequate ratings; twists of the same in equal size shall be made. For the input and output signal lines, be sure to use shielded wires and keep them away from each other.
3. Cable used for connection to power source, must have a cross section of 1mm² or greater. These wires shall have insulation capacity made of at least 1.5kV.
4. When extending the thermocouple lead wires, always use thermocouple compensation wires for wiring. For the RTD type, use a wiring material with a small lead resistance (50 max per line) and no resistance differentials among three wires.
5. A better anti-noise effect can be expected by using standard power supply cable for the instruments.

MAINTENANCE

1. The equipment should be cleaned regularly to avoid blockage of ventilating parts.
2. Clean the equipment with a clean soft cloth. Do not use Isopropyl alcohol or any other cleaning agent.

TERMINAL CONNECTIONS

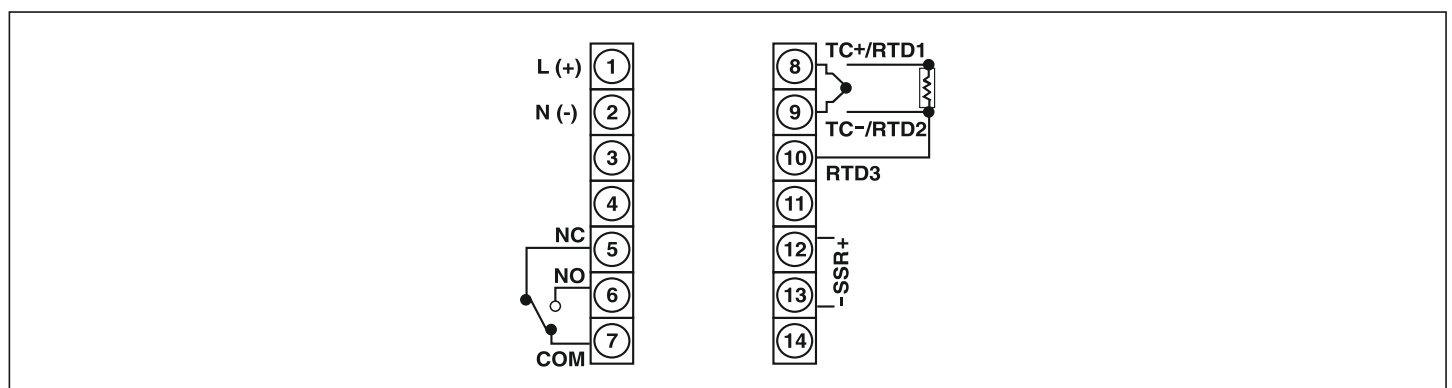

Use only the correct thermocouple wire or compensating cable from the probe to instrument terminals avoiding joints in the cable if possible. Failure to use the correct wire type will lead to inaccurate readings. Ensure that the input sensor connected at the terminals and the input type set in the temperature controller configuration are the same.

D) PROGRAMMING

LEVEL 1 - PRESS KEY FOR 3 SECONDS

DISPLAY (For 1sec)	DESCRIPTION	DEFAULT VALUE	RANGE	DISPLAY CONDITION
INP	Input type (refer table 1)	J	J, K, T, R, S, RTD	—
CNP	Compensation cable connected	YES	YES / NO	—
UNT	Temperature unit	°C	°C/°F	—
SP.L	Set point low limit	-199	Min range of sensor selected to SP.H	—
SP.H	Set point high limit	150	SP.L to Max range of sensor selected	—
FTC	Filter time constant (refer user guide)	1.0	0.2 to 10.0 sec	—
ACT	Control action	RE	RE/FD	—
CNT	Control logic	ONF	ONF / PID	—
ARW	Anti reset windup %	25	1 to 100%	For CNT=PID
RSF	Factory default (reset all)	NO	NO / YES	—

LEVEL 2 - PRESS KEY FOR 3 SECONDS

DISPLAY (For 1sec)	DESCRIPTION	DEFAULT VALUE	RANGE	DISPLAY CONDITION
TUN	Tune (refer user guide)	ST	ST / AT / OFF	For CNT=PID
P	Proportional band	10	1 to 400°	For CNT=PID
I	Integral time	20	0.0 to 99.9 min	For CNT=PID
D	Derivative time	30	0 to 999 sec	For CNT=PID
CY.M	Cycle time mode	AUT	AUT/US.F	For CNT=PID
CY.T	Cycle time	19.0	0.1 to 99.9 sec	For CNT=PID
HYS	Hysteresis	1.0	0.1 to 99.9°	For CNT=ONF
M.R	Manual reset (refer user guide)	0.0	-19.9 to 19.9°	For CNT=PID & I-0
DB	Display bias (refer user guide)	0.0	-19.9 to 19.9°	—

PROTECTION LEVEL - PRESS + KEYS FOR 3 SECONDS

DISPLAY (For 1sec)	DESCRIPTION	DEFAULT VALUE	RANGE	DISPLAY CONDITION
SP	Lock setpoint	UNK	UNK/LCK	—
L01	Lock level 1	UNK	UNK/LCK	—
L02	Lock level 2	UNK	UNK/LCK	—

NOTE:

1. Locking parameters (LV1 or LV2 or SP) will not permit change in the value of respective level parameters.
2. Continuous operation of + / keys for SP or other parameters makes update speed faster in 3 stages after 3 seconds.
3. Compensation parameter applicable only for thermocouple type sensor.

Programming Setpoint (Online):	Default: 50
To view setpoint: Press the key. To increase / decrease setpoint: Press + / keys	Range: SP.L to SP.H

**INPUT RANGES (Table 1)
FOR RTD**

Input	Unit	Ranges
PT100	°C	-150 to 850
	°F	-199 to 999

FOR THERMOCOUPLE

Input	Unit	Ranges
J	°C	-199 to 750
	°F	-199 to 999
K	°C	-199 to 999
	°F	-199 to 999
T	°C	-199 to 400
	°F	-199 to 750
R & S	°C	0 to 999
	°F	32 to 999

ERROR DISPLAY (Table 2)

When an error has occurred, the display indicates error codes as given below.

Error	Meaning	Control Output Status
S.bP	Sensor break / Over range condition	OFF
S.PE	Sensor reverse / Under range condition	OFF

E) USER GUIDE

1. Display bias:

This function is used to adjust the PV value in cases where it is necessary for PV value to agree with another recorder or indicator, or when the sensor cannot be mounted in correct location.

2. Filter time constant:

The input filter is used to filter out quick changes that occur to the process variable in a dynamic or quick responding application which causes erratic control. The digital filter also aids in controlling processes where the electrical noise affects the input signal. Larger the value of FTC entered, greater the filter added and the slower the controller reacts to the process and vice versa.

3. Auto tuning:

The Auto-tuning function automatically computes and sets the proportional band (P), integral time (I), Derivative time (D), ARW% and cycle time (CY.T) as per process characteristics.

- Decimal point of LSD flashes at faster speed while auto-tuning is being performed.
- At the completion of Auto-tuning, the decimal point stops blinking.

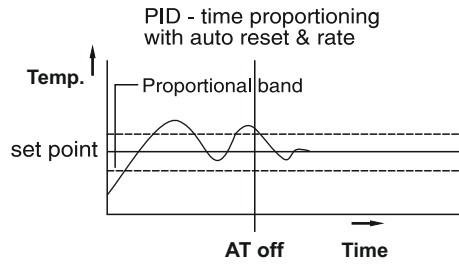

- If the power goes OFF before auto-tuning is completed, auto-tuning will be restarted next at power ON.
- If auto-tuning is not completed after 3-4 cycles, the auto-tuning is suspected to fail. In this case, check the wiring & parameters such as the control action, input type, etc.
- Carry out the auto-tuning again, if there is a change in set point or process parameters.

4. ON/OFF control action (for reverse mode):

The relay is 'ON' up to the set temperature and cuts 'OFF' above the set temperature. As the temperature of the system drops, the relay is switched 'ON' at a temperature slightly lower than the set point. temperature slightly lower than the set point.

HYSTERESIS:

The difference between the temperature at which relay switches 'ON' and at which the relay switches 'OFF' is the hysteresis or dead band.

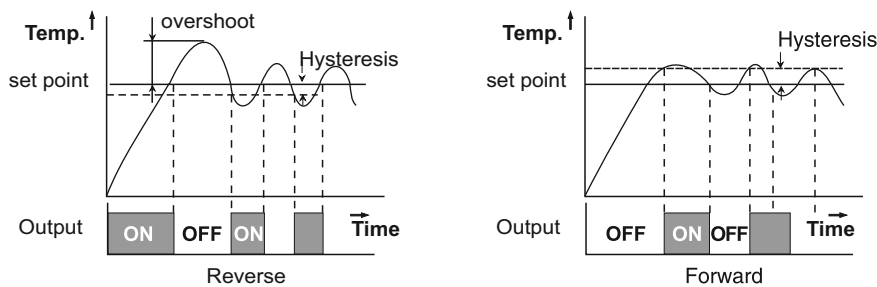

5. Manual reset (for PID control & I=0):

After some time the process temperature settles at some point and there is a difference between the set temperature & the controlled temperature. This difference can be removed by setting the manual reset value equal & opposite to the offset.

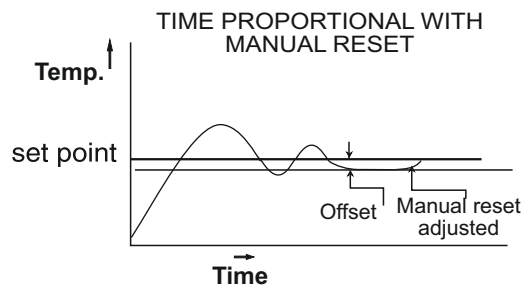

6. Self Tune (ST):

It is used where modification of PID parameters is required repeatedly due to frequent change in process condition eg. Set point.

- Tune LED blinks at slower rate when Self-Tuning is in progress.
- At the completion of self-tuning, Tune LED stop blinking.
- Self-tuning is initiated under the following conditions:
 - 1) When set point is altered.
 - 2) When tune mode is altered. (TUNE=ST)
- ST will start only if PV < 50% of set point.
- ST will work only when ACT=RE.

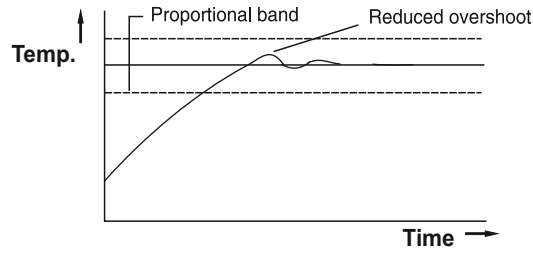

7. Thermocouple compensation:

COMP=YES

Configure Yes if compensating cable is connected as thermocouple extension. Yes should also be configured in the case if the sensor is directly connected to the terminal without extension.

COMP=NO

Configure No if non-compensating cable is connected as thermocouple extension.

F) CALIBRATION CERTIFICATE

Model No: TC612
Claimed accuracy: For TC inputs 0.25% of FS ± 1 °C For R & S inputs: 0.5% of F.S ± 2 °C (30 min of warm up time for TC input) For RTD inputs: 0.1% of FS ± 1 °C
Standard used for calibration of product is traceable to NABL

The calibration of this unit has been verified at the following values:

SENSOR SELECTION	VERIFICATION VALUE (°C)
K	25.0
	475.0
	975.0
RTD	0.0
	323.5
	800.0

Note: The verification values are approximate values with + 5 °C range.

The thermocouple/RTD curves are linearised in this microprocessor based product, and hence the values interpolated between the readings shown above are also equally accurate, at every point in the curve.

Unit is accepted as accuracy is within the specified limit of claimed accuracy and certificate is valid upto one year from the date of issue.

Etsilon

Factory Address : EL-27/1, Electronic Zone, TTC Industrial Area, MIDC, Mahape, Navi Mumbai - 400710, India.

Website : www.etsilon.com | **Customer Care No.** 7304413724 | **Email :** support@etsilon.com

For Service : Tel. No. : 9136977317 | **Email :** service@etsilon.com