



Ferramenta per Mobili · Made in Italy

INDICE

CRICCHETTI E CHIUSURE PER MOBILI	2
---	----------

Catch for Furniture · Made in Italy

CERNIERE PROFILATE IN OTTONE	6
---	----------

Profiled Brass Hinges · Made in Italy

FERRAMENTA	16
-------------------------	-----------

Ironmongery · Accessories for Furniture · Made in Italy

MANIGLIE	21
-----------------------	-----------

Furniture Handles · Made in Italy

POMOLI	142
---------------------	------------

Furniture Knobs · Made in Italy

ARTICOLI TECNICI	173
-------------------------------	------------

Technical Items · Made in Italy



FINITURE

Finishing

Le finiture si riferiscono alle seguenti categorie: **Cricchetti e chiusure per mobili** · **Cerniere profilate in ottone** · **Ferramenta**

Finishes apply to: *Catches for Furniture* · *Profiled Brass Hinges* · *Ironmongery*

<p>1 Satinato <i>Satin brass</i></p> <p>3 Nichelato satinato <i>Nikel satin</i></p> <p>5 Nichelato brillantato <i>Bright nikel</i></p> <p>7 Cromato <i>Chrome</i></p> <p>9 Brillantato <i>Bright</i></p> <p>11 Ottonato verniciato <i>Brassed lacquered</i></p> <p>13 Nichelato - Plastica marrone <i>Nikel - Brown plastic</i></p> <p>15 Zincato nero - Plastica nera <i>Zinc black - Black plastic</i></p> <p>17 Nichelato <i>Nikel</i></p>	<p>2 Lucido <i>Polished</i></p> <p>4 Nichelato lucido <i>Polished nikel</i></p> <p>6 Bronzato verniciato <i>Bronze lacquered</i></p> <p>8 Smerigliato <i>Brushed</i></p> <p>10 Zincato <i>Zinc plated</i></p> <p>12 Nichelato - Plastica bianca <i>Nikel - White plastic</i></p> <p>14 Nichelato - Plastica nera <i>Nikel - Black plastic</i></p> <p>16 Bronzato verniciato <i>Bronze lacquered</i></p> <p>18 Cromato <i>Chrome</i></p>
---	---

CRICCHETTI E CHIUSURE PER MOBILI

Catch for Furniture · Made in Italy

FALCHIT



ART. 188 INOX — Mini Latch in acciaio inox AISI 304

ART. 188 INOX — Mini Latch · Stainless Steel AISI 304

MATERIALE	FINITURA	CONF.
Acciaio INOX AISI 304	INOX naturale	50 – 1000 pz

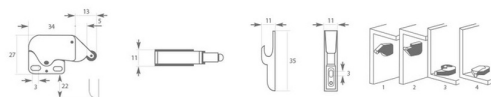

ART. 188 — Mini Latch

ART. 188 — Mini Latch · Push to open / close

MATERIALE	FINITURA	CONF.
Ferro e Acciaio	11-12-13-14-15	50 – 1000 pz

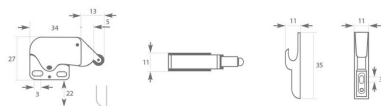



ART. 188 — Mini Latch All Metal

ART. 188 — Mini Latch All Metal · Push to open / close

MATERIALE	FINITURA	CONF.
Ferro e Acciaio	11-12-13-14-15	50 – 1000 pz

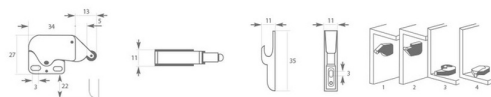

ART. 188 — Fermo Mini Latch

ART. 188 — Counterpiece Mini Latch · Push to open / close

MATERIALE	FINITURA	CONF.
Zama	10	50 – 400 pz

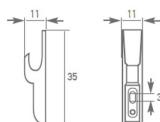



ART. 180 — Chiusura a scatto con fermo di nylon

ART. 180 — Push-to-open catch · nylon strike

MATERIALE	FINITURA	CONF.
Ferro	10 · 11 · 16	50 – 200 pz

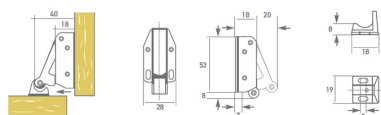

ART. 314 EASY-ON — Cerniera a doppia spinta senza incasso

ART. 314 EASY-ON — No mortise hinge double acting full concealed

MISURA	FINITURA	CONF.
Standard	10	20 pz

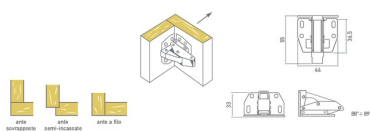

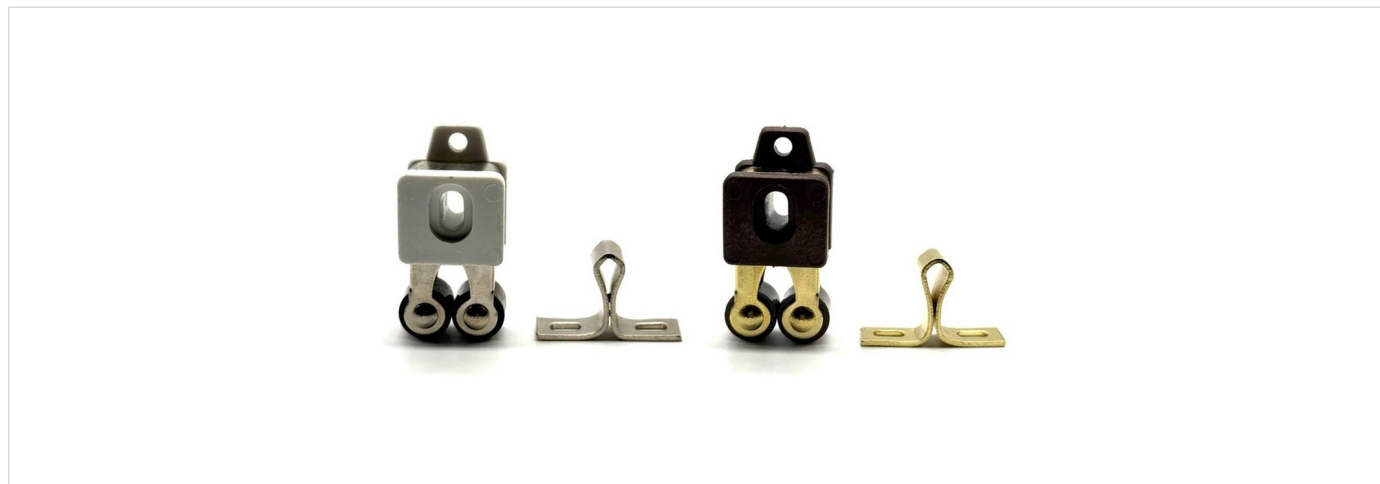

ART. 190 — Cricchetto con fermo di nylon

ART. 190 — Catch noiseless · Strike nylon

MATERIALE	FINITURA	CONF.
Acciaio temperato	16 · 17	100 pz

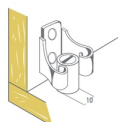

ART. 195 — Cricchetto silenzioso a due rulli

ART. 195 — Double roller catch

MATERIALE	FINITURA	CONF.
Acciaio	11 · 17	100 pz

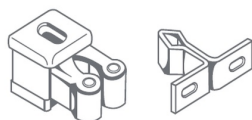

CERNIERE PROFILATE IN OTTONE

Profiled Brass Hinges · Made in Italy

FALCHIT

CERNIERE PROFILATE IN OTTONE

Profiled Brass Hinges · Made in Italy

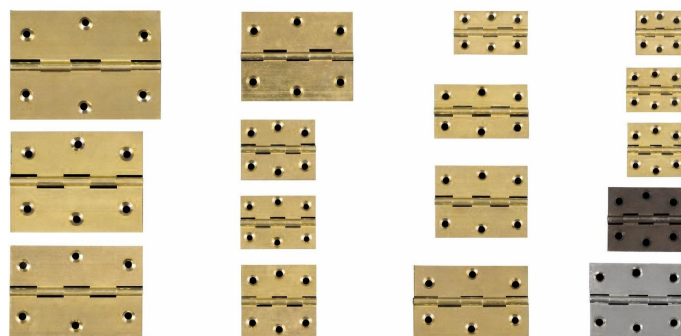

ART. 2000 - Cerniera diritta brillantata

ART. 2000 — Cerniera diritta brillantata

ART. 2000 — Plain bright hinge

MISURA (HxL)	SPESSORE	NODO	FINITURA	CONF.
25x25 mm	1,5/1,2	4 mm	5 · 6 · 9	24 pz
30x25 mm	1,5/1,2	4 mm	5 · 6 · 9	24 pz
40x30 mm	1,5/1,2	4 mm	5 · 6 · 9	24 pz
50x40 mm	1,5/1,2	4 mm	5 · 6 · 9	24 pz
60x40 mm	1,8/1,4	4,5 mm	5 · 6 · 9	24 pz
70x55 mm	2/1,5	5 mm	5 · 6 · 9	24 pz
80x60 mm	2/1,5	5 mm	5 · 6 · 9	24 pz

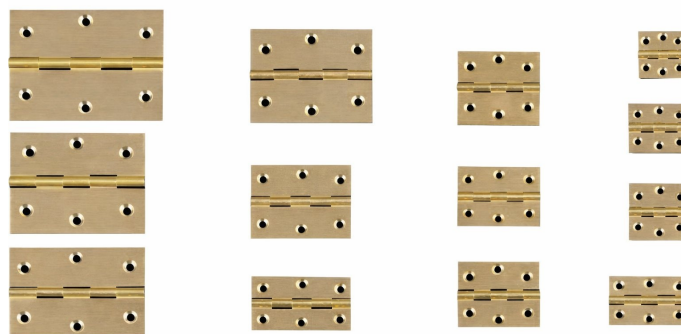

ART. 300 L - Cerniera 300L diritta smerigliata

ART. 300L — Cerniera diritta smerigliata

ART. 300L — Plain brushed hinge

MISURA (HxL)	SPESSORE	NODO	FINITURA	CONF.
25x25 mm	1,5/1,2	4 mm	3 · 6 · 7 · 8	24 pz
30x25 mm	1,5/1,2	4 mm	3 · 6 · 7 · 8	24 pz
40x30 mm	1,5/1,2	4 mm	3 · 6 · 7 · 8	24 pz
50x40 mm	1,5/1,2	4 mm	3 · 6 · 7 · 8	24 pz
60x40 mm	1,8/1,4	4,5 mm	3 · 6 · 7 · 8	24 pz
70x55 mm	2/1,5	5 mm	3 · 6 · 7 · 8	24 pz
80x60 mm	2/1,5	5 mm	3 · 6 · 7 · 8	24 pz



CERNIERE PROFILATE IN OTTONE

Profiled Brass Hinges · Made in Italy



ART. 303S - Cerniera a biscotto

ART. 303 — Cerniera per tavoli a biscotto

ART. 303 — Table Hinge · Plain swaged

MISURA (HxL)	SPESSORE	NODO	FINITURA	CONF.
30x80 mm	2 mm	6 mm	1-2-3-4-5-6-9	24 – 50 pz

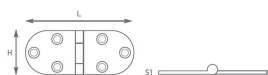

ART. 303 - Cerniera per tavoli a biscotto

ART. 303S — Cerniera a biscotto (perno in ottone)

ART. 303S — Table Hinge · Brass pin

MISURA (HxL)	SPESSORE	NODO	FINITURA	CONF.
20x63 mm	2 mm	6 mm	1-2-3-4-6	24 – 50 pz

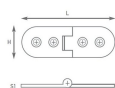



ART. 304 (30x54) - Cerniera a biscotto

ART. 304 — Cerniera a biscotto

ART. 304 — Table Hinge · Plain swaged

MISURA (HxL)	SPESSORE	FINITURA	CONF.
30x54 mm	2 mm	1-2-3-4-6-7-8	24-500 pz
30x65 mm	2 mm	1-2-3-4-6-7-8	24-500 pz
30x72 mm	2 mm	1-2-3-4-6-7-8	24-500 pz
30x80 mm	2 mm	1-2-3-4-6-7-8	24-500 pz



ART. 304 (30x54) — Cerniera a biscotto piatta

ART. 304 (30x54) — Table Hinge · Plain swaged

MISURA (HxL)	SPESSORE	FINITURA	CONF.
30x54 mm	2 mm	1-2-3-4-6-7-8	24-500 pz

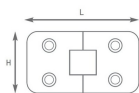



ART. 301 - Curva smerigliata - ART. 2001 - Curva brillantata

ART. 301 / 2001 — Curva smerigliata / brillantata

ART. 301 — Curva brushed · ART. 2001 — Curva bright

MISURA (HxL)	SPESSORE	NODO	FINITURA	CONF.
40x40 mm	1,8/1,4	4,5 mm	301: 3-6-7-8 / 2001: 5-6-9	24 pz
50x40 mm	1,8/1,4	4,5 mm	301: 3-6-7-8 / 2001: 5-6-9	24 pz
60x50 mm	2/1,5	5 mm	301: 3-6-7-8 / 2001: 5-6-9	24 pz



ART. 305 - Curva D-smerigliata - ART. 2002 - Curva D-brillantata

ART. 305 / 2002 — Curva D smerigliata / brillantata

ART. 305 — Curva D-brushed · ART. 2002 — Curva D-bright

MISURA (HxL)	SPESSORE	NODO	FINITURA	CONF.
40x40 mm	1,8/1,4	4,5 mm	305: 3-6-7-8 / 2002: 5-6-9	24 pz
50x40 mm	1,8/1,4	4,5 mm	305: 3-6-7-8 / 2002: 5-6-9	24 pz
60x50 mm	2/1,5	5 mm	305: 3-6-7-8 / 2002: 5-6-9	24 pz



CERNIERE PROFILATE IN OTTONE

Profiled Brass Hinges · Made in Italy



ART. 313 — Cerniera a molla (angoli arrotondati su richiesta)

ART. 313 — Self supporting spring hinge

MISURA (HxL)	SPESSORE	FINITURA	CONF.
38x63 mm	2,2 / 2,4 mm	1 - 6	50 pz



ART. 322 - Cerniera a sfilare con angoli arrotondati

ART. 322 — Cerniera a sfilare con angoli arrotondati

ART. 322 — Lift off hinge with round corners

MISURA (HxL)	SPESSORE	NODO	FINITURA	CONF.
40x40 mm	2 mm	8 mm	1-2-3-4-6	20 pz
50x40 mm	2 mm	8 mm	1-2-3-4-6	20 pz
60x40 mm	2 mm	8 mm	1-2-3-4-6	20 pz

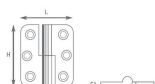

CERNIERE PROFILATE IN OTTONE

Profiled Brass Hinges · Made in Italy



ART. 318/20 — Cerniera ad angolo a sfilare per ante sovrapposte

ART. 318/20 — Angle hinge for edge fixing to door and frame

MISURA (HxL)	NODO	FINITURA	CONF.
50x20-21 mm	8 mm	1-2-3-4-6-7	20 pz

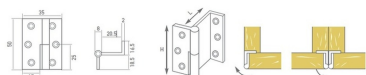

ART. 187 - perno in ottone per piani ribaltabili

ART. 187 — Perno in ottone per piani ribaltabili

ART. 187 — Brass card table hinge (side fixing rule joint)

MISURA (HxL)	NODO	FINITURA	CONF.
15x132 mm	—	2 · 5	20 pz

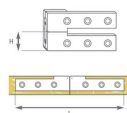



ART. 321 - Cerniera con curva regolabile, basetta tonda \varnothing 30mm
 ART. 321/2R - Cerniera con curva a due regolazioni, basetta tonda \varnothing 30mm

ART. 320 — Cerniere regolabili in ottone

ART. 320 — Curva adjustable hinge

MISURA (HxL)	NODO	FINITURA	CONF.
40x40 mm	—	8	24 pz

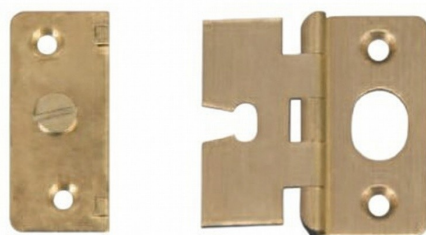
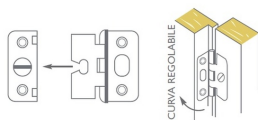

ART. 321 / 321-2R — Cerniera con curva regolabile \varnothing 30 mm

ART. 321 — Adjustable hinge · round plate \varnothing 30mm

ARTICOLO	MISURA (HxL)	FINITURA	CONF.
ART. 321	40x40 mm	8	24 pz
ART. 321/2R	40x40 mm	1-3-5-6-9	50 pz

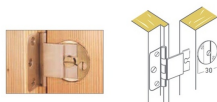

CERNIERE PROFILATE IN OTTONE

Profiled Brass Hinges · Made in Italy



ART. 1000 — Cerniera a vista per ante a filo

ART. 1000 — Special hinge full surface no mortise for insert doors

MISURA (HxL)	NODO	FINITURA	CONF.
28x40 mm	—	1 · 3 · 6	40 pz

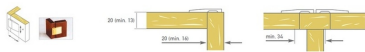

ART. 1000 - Cerniera a vista per ante a filo

ART. 1001 — Cerniera a vista per cristalli

ART. 1001 — Glass door hinge

MISURA (HxL)	NODO	FINITURA	CONF.
28x40 mm	—	1 · 3 · 6	40 pz

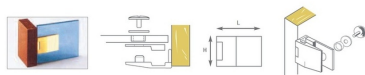



ART. 315/20 — ART. 315/16 — Cerniera semplice

ART. 315/20 — ART. 315/16 — One leaf hinge

ARTICOLO	MISURA (HxL)	FINITURA	CONF.
ART. 315/20	40x20 mm	1-2-3-4-6-7	20 pz
ART. 315/16	40x16 mm	1-2-3-4-6-7	20 pz



ART. 315/20 — Cerniera doppia

ART. 315/20 — Two leaves hinge

MISURA (HxL)	NODO	FINITURA	CONF.
40x40 mm	—	1-2-3-4-6-7	20 pz

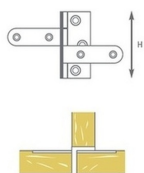

FERRAMENTA

Ironmongery · Accessories for Furniture · Made in Italy

FALCHIT



ART. 308 — Catenaccio in ottone profilato con fermo

ART. 308 — Profiled brass bolt with strike

MISURA	FINITURA	CONF.
mm 50	2 · 4	20 pz
mm 60	2 · 4	20 pz
mm 70	2 · 4	20 pz
mm 80	2 · 4	20 pz
mm 90	2 · 4	20 pz
mm 100	2 · 4	20 pz

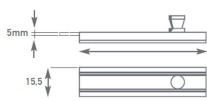

ART. 310 — Catenaccio in ottone automatico con fermo

ART. 310 — Self closing bolt solid brass with strike

MISURA (HxL)	FINITURA	CONF.
27x70 mm	2 · 4	20 pz

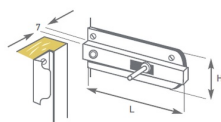



ART. 169 — Asta snodata curva in ottone

ART. 169 — Sliding brass arm (curved)

MISURA	FINITURA	CONF.
cm 12	5 - 9	20 pz
cm 18	5 - 9	20 pz

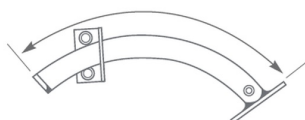

ART. 175 - Asta snodata diritta in ottone

ART. 175 — Asta snodata diritta in ottone

ART. 175 — Lid brass stay with retainer

MISURA	FINITURA	CONF.
cm 12	5 - 9	20 pz
cm 15	5 - 9	20 pz
cm 20	5 - 9	20 pz
cm 25	5 - 9	20 pz
cm 30	5 - 9	20 pz
cm 40	5 - 9	20 pz

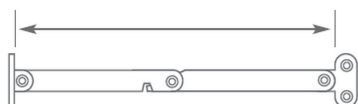

MANIGLIE

Handles · Made in Italy

FALCHIT



ART. 1911

ART. 1911 · Made in Italy

L (mm)	C (mm)	H (mm)	Ø (mm)	materiale	codice
138	128	30	125	zama	1911.00
237	224	30	200	zama	1911.05

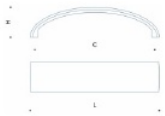

ART. 1932

ART. 1932 · Made in Italy

L (mm)	C (mm)	H (mm)	Ø (mm)	materiale	codice
288	256	28	150	zama	1932.07
233	192	28	127	zama	1932.04
105	64	28	80	zama	1932.02

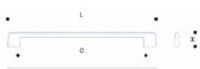



ART. 1933

ART. 1933 · Made in Italy

L (mm)	C (mm)	H (mm)	Ø (mm)	materiale	codice
337,5	320	30	156	zama	1933.08
210	192	28.5	115	zama	1933.04
113.5	96	26.5	76	zama	1933.02



ART. 1939

ART. 1939 · Made in Italy

L (mm)	C (mm)	H (mm)	Ø (mm)	materiale	codice
120	96	25,5	117	zama	1939.02

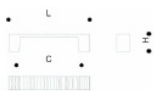



ART. 1924

ART. 1924 · Made in Italy

L (mm)	C (mm)	H (mm)	Ø (mm)	materiale	codice
139	128	32,5	150	zama	1924.00

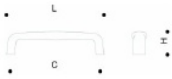

ART. 1872

ART. 1872 · Made in Italy

L (mm)	C (mm)	H (mm)	Ø (mm)	materiale	codice
178	160	25	105	zama	1872.03
274	256	27	144	zama	1872.06

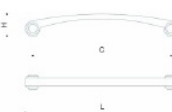



ART. 1822

ART. 1822 · Made in Italy

L (mm)	C (mm)	H (mm)	Ø (mm)	materiale	codice
139	96	26	70	zama	1822.02

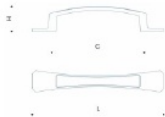

ART. 1821

ART. 1821 · Made in Italy

L (mm)	C (mm)	H (mm)	Ø (mm)	materiale	codice
147	128	31	85	zama	1821.00

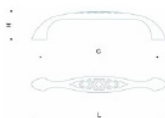



ART. 1802

ART. 1802 · Made in Italy

L (mm)	C (mm)	H (mm)	Ø (mm)	materiale	codice
140	32	26	93	zama	1802.11

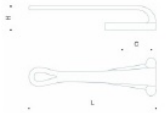

ART. 1785

ART. 1785 · Made in Italy

L (mm)	C (mm)	H (mm)	Ø (mm)	materiale	codice
149	128	30,5	129	zama	1785.00





ART. 1765

ART. 1765 · Made in Italy

L (mm)	C (mm)	H (mm)	Ø (mm)	materiale	codice
165	128	26	108	zama	1765.00

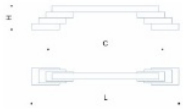

ART. 1754

ART. 1754 · Made in Italy

L (mm)	C (mm)	H (mm)	Ø (mm)	materiale	codice
111	96	25,5	50	zama	1754.02

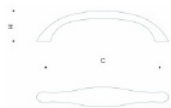



ART. 1737

ART. 1737 · Made in Italy

L (mm)	C (mm)	H (mm)	Ø (mm)	materiale	codice
185	160	24	—	zama	1737.03



ART. 1692

ART. 1692 · Made in Italy

L (mm)	C (mm)	H (mm)	Ø (mm)	materiale	codice
142,5	128	31	163	zama	1692.00

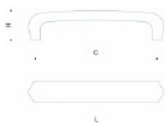



ART. 1687

ART. 1687 · Made in Italy

L (mm)	C (mm)	H (mm)	Ø (mm)	materiale	codice
162	128	30	10	legno	1687.00

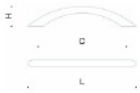

ART. 1681

ART. 1681 · Made in Italy

L (mm)	C (mm)	H (mm)	Ø (mm)	materiale	codice
160	128	31	230	zama	1681.00

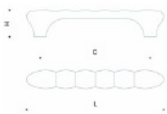



ART. 1674

ART. 1674 · Made in Italy

L (mm)	C (mm)	H (mm)	Ø (mm)	materiale	codice
86	64	20	45	zama	1674.01

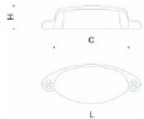

ART. 1673

ART. 1673 · Made in Italy

L (mm)	C (mm)	H (mm)	Ø (mm)	materiale	codice
127	96	23,5	50	zama	1673.02





ART. 1669

ART. 1669 · Made in Italy

L (mm)	C (mm)	H (mm)	Ø (mm)	materiale	codice
138	128	28	67	zama	1669.00

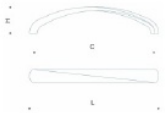

ART. 1662

ART. 1662 · Made in Italy

L (mm)	C (mm)	H (mm)	Ø (mm)	materiale	codice
147	96	27	60	zama	1662.02

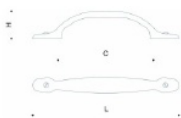



ART. 1653

ART. 1653 · Made in Italy

L (mm)	C (mm)	H (mm)	Ø (mm)	materiale	codice
163	128	30	30	zama	1653.00

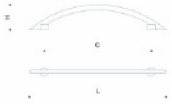

ART. 1650

ART. 1650 · Made in Italy

L (mm)	C (mm)	H (mm)	Ø (mm)	materiale	codice
105	96	35	35	zama	1650.02





ART. 1646

ART. 1646 · Made in Italy

L (mm)	C (mm)	H (mm)	Ø (mm)	materiale	codice
146	128	24	65	zama	1646.00



ART. 1642

ART. 1642 · Made in Italy

L (mm)	C (mm)	H (mm)	Ø (mm)	materiale	codice
97	64	20	70	zama	1642.01





ART. 1633

ART. 1633 · Made in Italy

L (mm)	C (mm)	H (mm)	Ø (mm)	materiale	codice
97	64	20	70	zama	1633.01

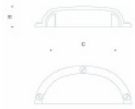

ART. 1617

ART. 1617 · Made in Italy

L (mm)	C (mm)	H (mm)	Ø (mm)	materiale	codice
106	96	23	35	zama	1617.02





ART. 1605

ART. 1605 · Made in Italy

L (mm)	C (mm)	H (mm)	Ø (mm)	materiale	codice
85	64	20,5	60	zama	1605.01



ART. 1566

ART. 1566 · Made in Italy

L (mm)	C (mm)	H (mm)	Ø (mm)	materiale	codice
138	96	27,5	85	zama	1566.02
168	128	27,5	105	zama	1566.00

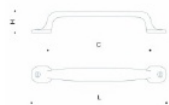



ART. 1946

ART. 1946 · Made in Italy

L (mm)	C (mm)	H (mm)	Ø (mm)	materiale	codice
204	160	32	110	zama	1946.03
358	320	32	155	zama	1946.08



ART. 1945

ART. 1945 · Made in Italy

L (mm)	C (mm)	H (mm)	Ø (mm)	materiale	codice
172	160	30.5	127	zama	1945.03
332	320	30.5	230	zama	1945.08

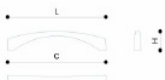



ART. 1944

ART. 1944 · Made in Italy

L (mm)	C (mm)	H (mm)	Ø (mm)	materiale	codice
168	160	36	152	zama	1944.03
328	320	36	275	zama	1944.08

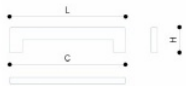

ART. 1948

ART. 1948 · Made in Italy

L (mm)	C (mm)	H (mm)	Ø (mm)	materiale	codice
170	160	22.6	165	zama	1948.03





ART. 1943

ART. 1943 · Made in Italy

L (mm)	C (mm)	H (mm)	Ø (mm)	materiale	codice
197	160	29	170	zama	1943.03

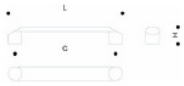

ART. 1940

ART. 1940 · Made in Italy

L (mm)	C (mm)	H (mm)	Ø (mm)	materiale	codice
169,3	160	22,5	180	zama	1940.03

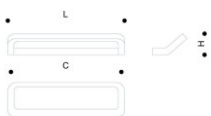



ART. 1937

ART. 1937 · Made in Italy

L (mm)	C (mm)	H (mm)	Ø (mm)	materiale	codice
—	—	—	—	—	—

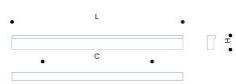

ART. 1934

ART. 1934 · Made in Italy

L (mm)	C (mm)	H (mm)	Ø (mm)	materiale	codice
246	192	—	95	zama	1934.04





ART. 1931

ART. 1931 · Made in Italy

L (mm)	C (mm)	H (mm)	Ø (mm)	materiale	codice
176	160	23,8	200	zama	1931.03



ART. 1929

ART. 1929 · Made in Italy

L (mm)	C (mm)	H (mm)	Ø (mm)	materiale	codice
359	288	26	200	zama	1929.07
239	160	26	115	zama	1929.05



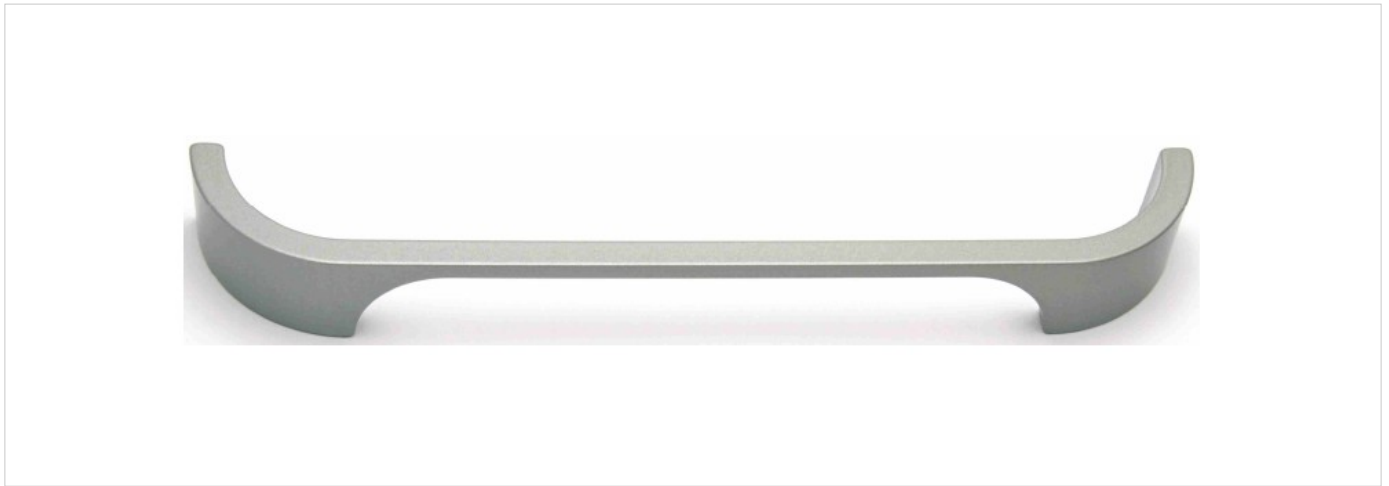

ART. 1928

ART. 1928 · Made in Italy

L (mm)	C (mm)	H (mm)	Ø (mm)	materiale	codice
218,4	160	24	152	zama	1928.03

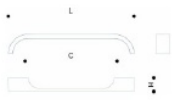

ART. 1926

ART. 1926 · Made in Italy

L (mm)	C (mm)	H (mm)	Ø (mm)	materiale	codice
176,6	160	20	210	zama	1926.03



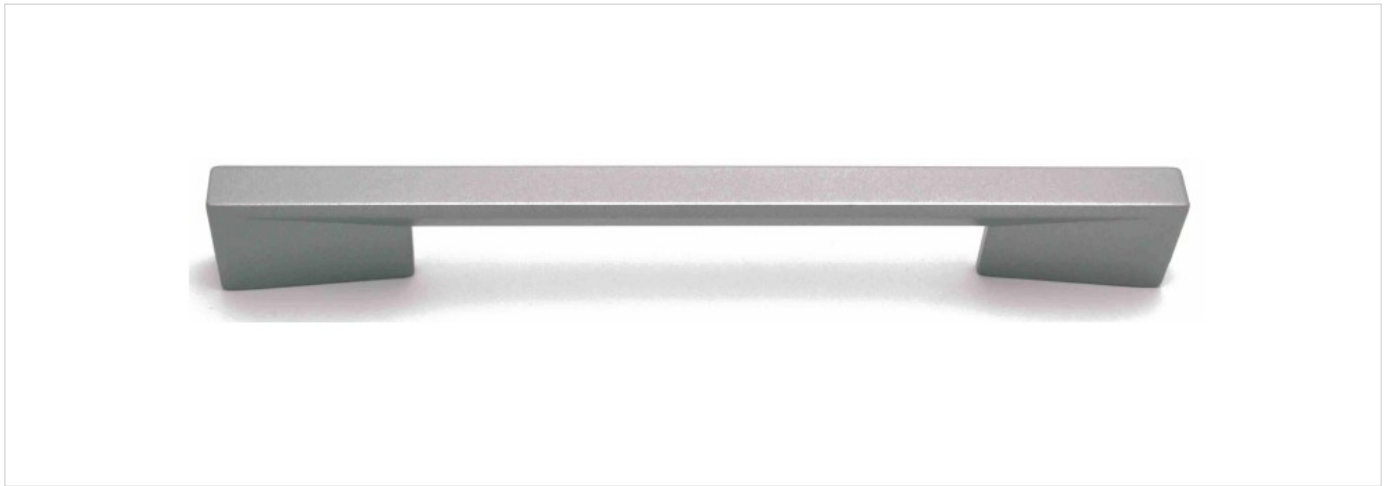

ART. 1923

ART. 1923 · Made in Italy

L (mm)	C (mm)	H (mm)	Ø (mm)	materiale	codice
210	—	29	200	zama	1923.04



ART. 1922

ART. 1922 · Made in Italy

L (mm)	C (mm)	H (mm)	Ø (mm)	materiale	codice
185	128	26,5	145	zama	1922.00





ART. 1920

ART. 1920 · Made in Italy

L (mm)	C (mm)	H (mm)	Ø (mm)	materiale	codice
56	32	38	68	zama	1920.11

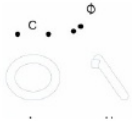

ART. 1919

ART. 1919 · Made in Italy

L (mm)	C (mm)	H (mm)	Ø (mm)	materiale	codice
182	128	32	168	zama	1919.00

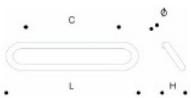



ART. 1918

ART. 1918 · Made in Italy

L (mm)	C (mm)	H (mm)	Ø (mm)	materiale	codice
196	160	26	122	zama	1918.03
228	192	26	130	zama	1918.04
356	320	26	180	zama	1918.08

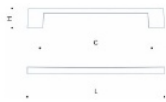

ART. 1916

ART. 1916 · Made in Italy

L (mm)	C (mm)	H (mm)	Ø (mm)	materiale	codice
146	64	30	150	zama	1916.146





ART. 1912

ART. 1912 · Made in Italy

L (mm)	C (mm)	H (mm)	Ø (mm)	materiale	codice
202	192	17	65	zama	1912.04

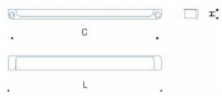

ART. 1910

ART. 1910 · Made in Italy

L (mm)	C (mm)	H (mm)	Ø (mm)	materiale	codice
80	32	17,5	80	zama	1910.11

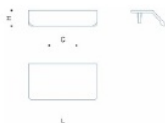



ART. 1909

ART. 1909 · Made in Italy

L (mm)	C (mm)	H (mm)	Ø (mm)	materiale	codice
72	64	25	120	zama	1909.01
200	192	25	200	zama	1909.04



ART. 1908

ART. 1908 · Made in Italy

L (mm)	C (mm)	H (mm)	Ø (mm)	materiale	codice
60	45	45	150	zama	1908.45

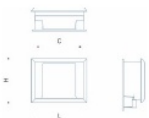



ART. 1907

ART. 1907 · Made in Italy

L (mm)	C (mm)	H (mm)	Ø (mm)	materiale	codice
120	105	45	240	zama	1907.105



ART. 1906

ART. 1906 · Made in Italy

L (mm)	C (mm)	H (mm)	Ø (mm)	materiale	codice
207	192	23	—	legno	1906.04

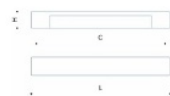



ART. 1905

ART. 1905 · Made in Italy

L (mm)	C (mm)	H (mm)	Ø (mm)	materiale	codice
70	32	26,5	175	zama	1905-01



ART. 1902

ART. 1902 · Made in Italy

L (mm)	C (mm)	H (mm)	Ø (mm)	materiale	codice
203	160	27	80	zama+PA	1902.03





ART. 1900

ART. 1900 · Made in Italy

L (mm)	C (mm)	H (mm)	Ø (mm)	materiale	codice
70	16	25,5	105	zama	1900.92



ART. 1884

ART. 1884 · Made in Italy

L (mm)	C (mm)	H (mm)	Ø (mm)	materiale	codice
220	160	36	120	zama	1884.03
L	C	H	peso	materiale	codice

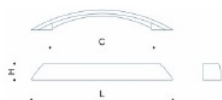



ART. 1882

ART. 1882 · Made in Italy

L (mm)	C (mm)	H (mm)	Ø (mm)	materiale	codice
204	160	24	120	zama	1882.03

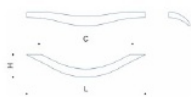

ART. 1881

ART. 1881 · Made in Italy

L (mm)	C (mm)	H (mm)	Ø (mm)	materiale	codice
182	160	31	120	zama	1881.03

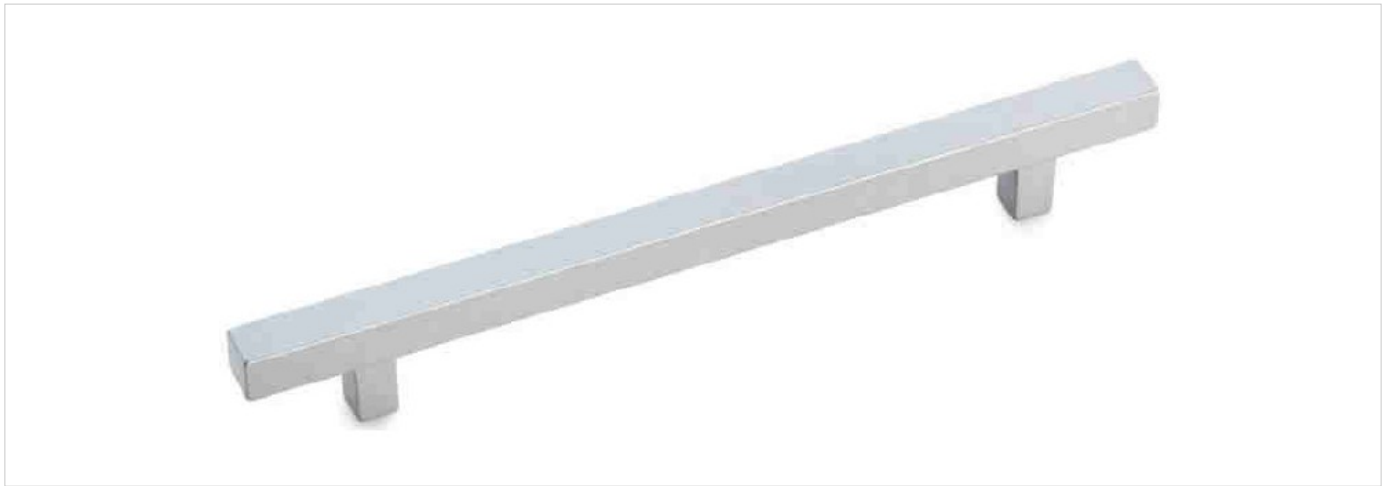

**ART. 1880***ART. 1880 · Made in Italy*

L (mm)	C (mm)	H (mm)	Ø (mm)	materiale	codice
182	160	33	190	zama	1880.03

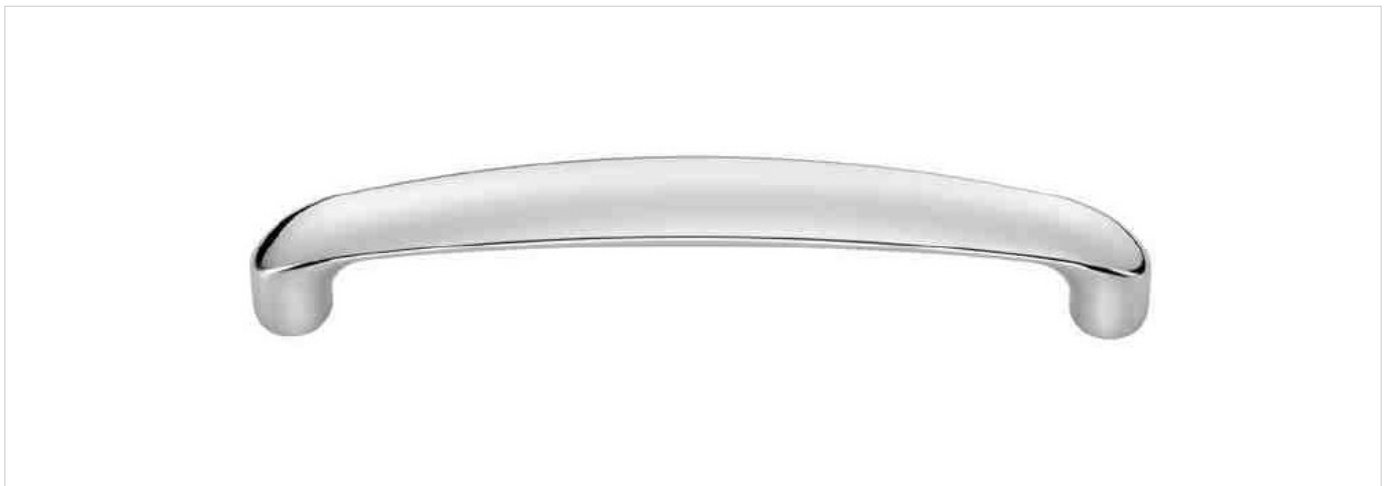
**ART. 1876***ART. 1876 · Made in Italy*

L (mm)	C (mm)	H (mm)	Ø (mm)	materiale	codice
182	160	33	190	zama	1876.03





ART. 1874

ART. 1874 · Made in Italy

L (mm)	C (mm)	H (mm)	Ø (mm)	materiale	codice
141	64	24,5	75	zama	1874.01

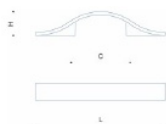

ART. 1873

ART. 1873 · Made in Italy

L (mm)	C (mm)	H (mm)	Ø (mm)	materiale	codice
141	128	33	115	zama	1873.00

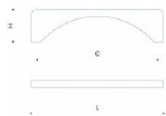



ART. 1870

ART. 1870 · Made in Italy

L (mm)	C (mm)	H (mm)	Ø (mm)	materiale	codice
130	64	8	45	zama	1870.01

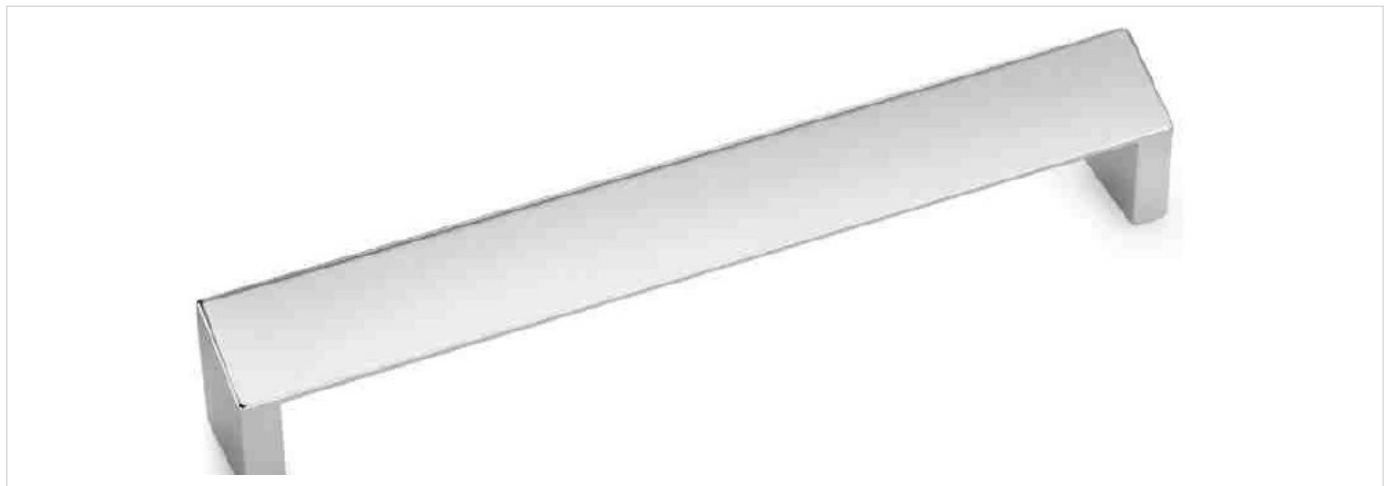

ART. 1868

ART. 1868 · Made in Italy

L (mm)	C (mm)	H (mm)	Ø (mm)	materiale	codice
233	224	28	380	zama	1868.05

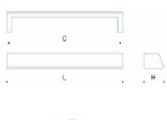



ART. 1867

ART. 1867 · Made in Italy

L (mm)	C (mm)	H (mm)	Ø (mm)	materiale	codice
140	128	22	145	zama	1867.00

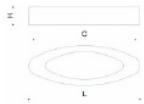

ART. 1866

ART. 1866 · Made in Italy

L (mm)	C (mm)	H (mm)	Ø (mm)	materiale	codice
225	160	33	240	zama	1866.03
320	256	33	270	zama	1866.06

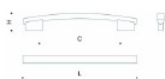



ART. 1864

ART. 1864 · Made in Italy

L (mm)	C (mm)	H (mm)	Ø (mm)	materiale	codice
90	64	17	65	zama	1864.01



ART. 1862

ART. 1862 · Made in Italy

L (mm)	C (mm)	H (mm)	Ø (mm)	materiale	codice
208	160	25	280	zama	1862.03





ART. 1859

ART. 1859 · Made in Italy

L (mm)	C (mm)	H (mm)	Ø (mm)	materiale	codice
70	32	20	100	zama	1859.11

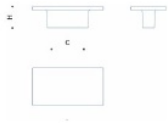

ART. 1858

ART. 1858 · Made in Italy

L (mm)	C (mm)	H (mm)	Ø (mm)	materiale	codice
78	32	26	230	zama	1858.11

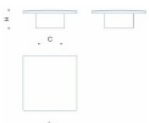



ART. 1857

ART. 1857 · Made in Italy

L (mm)	C (mm)	H (mm)	Ø (mm)	materiale	codice
146	128	32	135	zama	1857.00

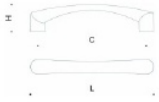

ART. 1856

ART. 1856 · Made in Italy

L (mm)	C (mm)	H (mm)	Ø (mm)	materiale	codice
173	160	33	245	zama	1856.03

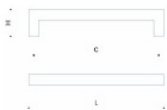



ART. 1855

ART. 1855 · Made in Italy

L (mm)	C (mm)	H (mm)	Ø (mm)	materiale	codice
182	128	24	150	zama	1855.00



ART. 1854

ART. 1854 · Made in Italy

L (mm)	C (mm)	H (mm)	Ø (mm)	materiale	codice
230	192	33	260	zama	1854.04





ART. 1853

ART. 1853 · Made in Italy

L (mm)	C (mm)	H (mm)	Ø (mm)	materiale	codice
205	192	38	240	zama	1853.04

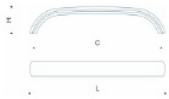

ART. 1852

ART. 1852 · Made in Italy

L (mm)	C (mm)	H (mm)	Ø (mm)	materiale	codice
208	192	31	150	zama	1852.04





ART. 1847

ART. 1847 · Made in Italy

L (mm)	C (mm)	H (mm)	Ø (mm)	materiale	codice
229	64	25	105	zama	1847.01

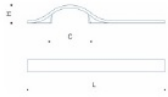

ART. 1845

ART. 1845 · Made in Italy

L (mm)	C (mm)	H (mm)	Ø (mm)	materiale	codice
70	32	20	155	zama	1845.11

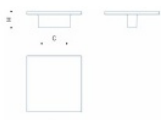



ART. 1843

ART. 1843 · Made in Italy

L (mm)	C (mm)	H (mm)	Ø (mm)	materiale	codice
165	64	20	200	zama	1843.01



ART. 1839

ART. 1839 · Made in Italy

L (mm)	C (mm)	H (mm)	Ø (mm)	materiale	codice
262	256	60	350	zama	1839.06





ART. 1837

ART. 1837 · Made in Italy

L (mm)	C (mm)	H (mm)	Ø (mm)	materiale	codice
135,5	128	29	235	zama	1837.00

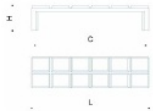

ART. 1836

ART. 1836 · Made in Italy

L (mm)	C (mm)	H (mm)	Ø (mm)	materiale	codice
134,5	160	27	140	zama	1836.03

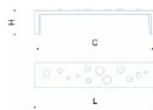



ART. 1831

ART. 1831 · Made in Italy

L (mm)	C (mm)	H (mm)	Ø (mm)	materiale	codice
117	96	28	65	zama	1831.02

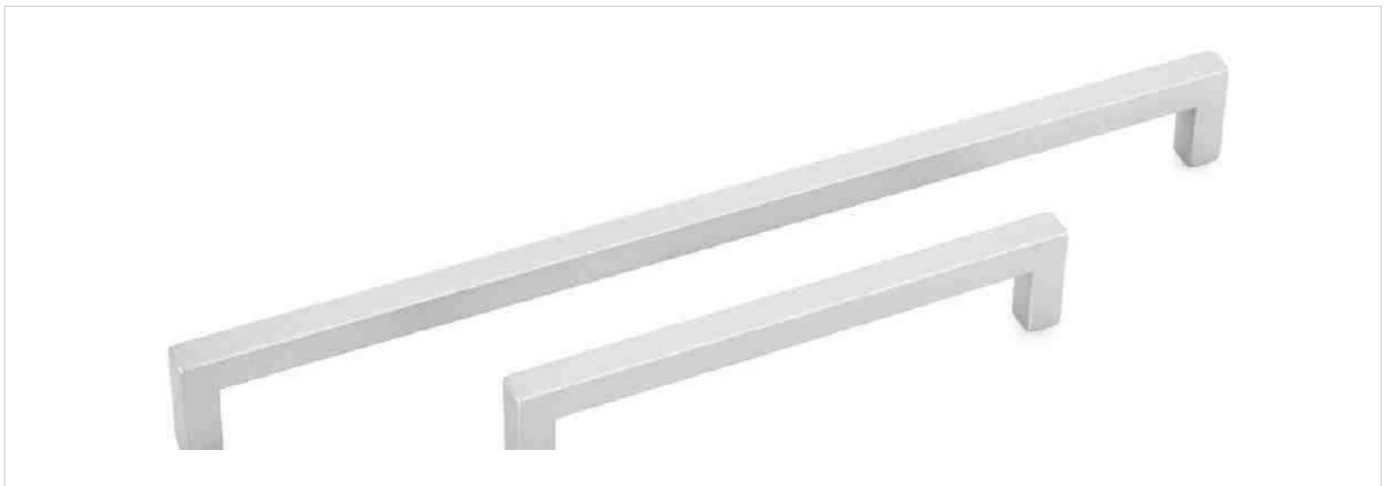
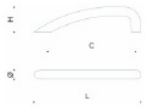

ART. 1827

ART. 1827 · Made in Italy

L (mm)	C (mm)	H (mm)	Ø (mm)	materiale	codice
171	160	35	180	zama	1827.03
331	320	35	315	zama	1827.08





ART. 1824

ART. 1824 · Made in Italy

L (mm)	C (mm)	H (mm)	Ø (mm)	materiale	codice
210	160	32	187	zama	1824.03

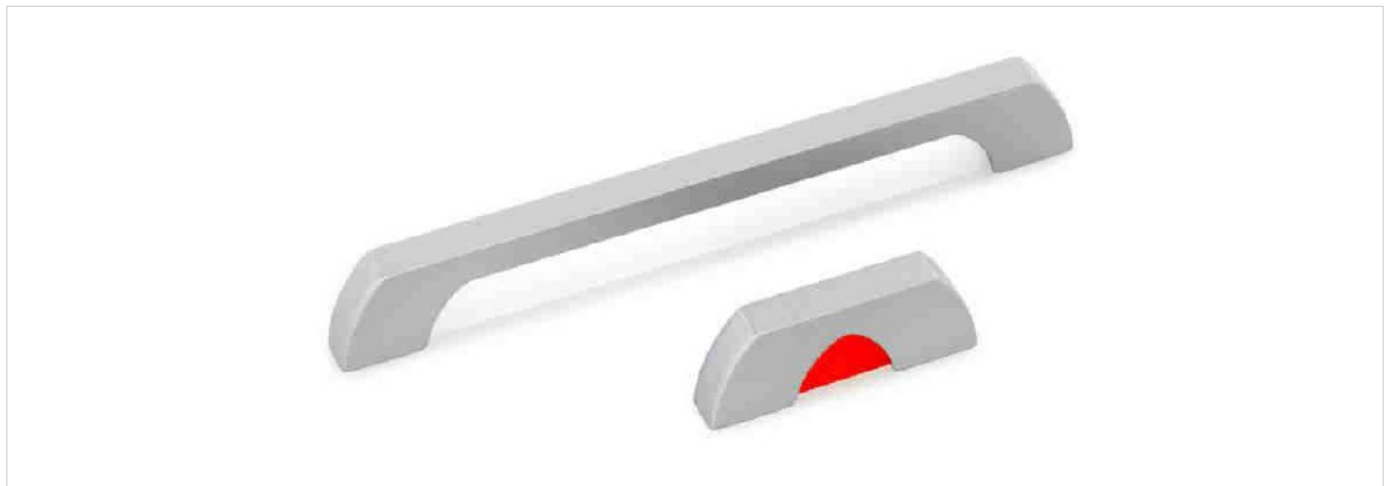

ART. 1820

ART. 1820 · Made in Italy

L (mm)	C (mm)	H (mm)	Ø (mm)	materiale	codice
150	128	22	90	zama+PMMA	1820.00
54	32	22	45	zama+PMMA	1820.11





ART. 1819

ART. 1819 · Made in Italy

L (mm)	C (mm)	H (mm)	Ø (mm)	materiale	codice
160	128	26	230	zama	1819.00

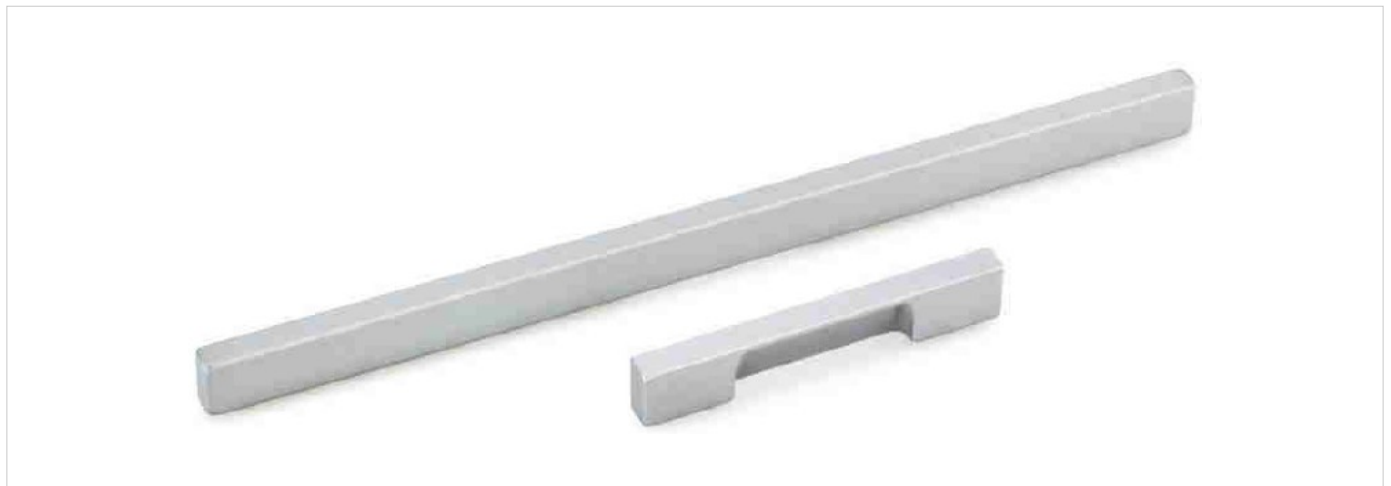
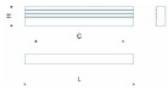

ART. 1815

ART. 1815 · Made in Italy

L (mm)	C (mm)	H (mm)	Ø (mm)	materiale	codice
100	64	17	80	zama	1815.01
278	160	17	250	zama	1815.03
50	32	17	40	zama	1815.11

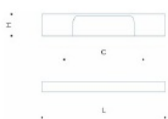



ART. 1812

ART. 1812 · Made in Italy

L (mm)	C (mm)	H (mm)	Ø (mm)	materiale	codice
126	96	22	105	zama	1812.02



ART. 1800

ART. 1800 · Made in Italy

L (mm)	C (mm)	H (mm)	Ø (mm)	materiale	codice
136	128	19,5	127	zama	1800.00
168	160	19,5	140	zama	1800.03





moderne

ART. 1799

ART. 1799 · Made in Italy

L (mm)	C (mm)	H (mm)	Ø (mm)	materiale	codice
181	160	14,5	325	zama+ferro	1799.03



ART. 1798

ART. 1798 · Made in Italy

L (mm)	C (mm)	H (mm)	Ø (mm)	materiale	codice
210	32	32	215	zama	1798.11

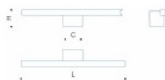



ART. 1796

ART. 1796 · Made in Italy

L (mm)	C (mm)	H (mm)	Ø (mm)	materiale	codice
168	160	36	166	zama	1796.03



ART. 1794

ART. 1794 · Made in Italy

L (mm)	C (mm)	H (mm)	Ø (mm)	materiale	codice
142	128	24	47	zama	1794.00





ART. 1791

ART. 1791 · Made in Italy

L (mm)	C (mm)	H (mm)	Ø (mm)	materiale	codice
142	128	24	140	zama	1791.00
108	96	24	112	zama	1791.02



ART. 1790

ART. 1790 · Made in Italy

L (mm)	C (mm)	H (mm)	Ø (mm)	materiale	codice
140	128	27	155	zama	1790.00



1789

L	C	H	Ø	peso	materiale	codice
165	128	25,5	123		zama	1789.00

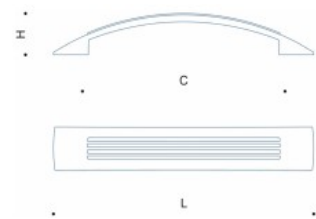

ART. 1789

ART. 1789 · Made in Italy

L (mm)	C (mm)	H (mm)	Ø (mm)	materiale	codice
165	128	25,5	123	zama	1789.00

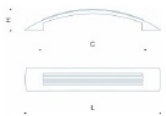

ART. 1788

ART. 1788 · Made in Italy

L (mm)	C (mm)	H (mm)	Ø (mm)	materiale	codice
136	128	22,5	107	zama	1788.00





ART. 1784

ART. 1784 · Made in Italy

L (mm)	C (mm)	H (mm)	Ø (mm)	materiale	codice
170	96	18	140	zama	1784.02



ART. 1783

ART. 1783 · Made in Italy

L (mm)	C (mm)	H (mm)	Ø (mm)	materiale	codice
170	160	27	116	zama	1783.03
253	224	27	165	zama	1783.05
300	288	27	203	zama	1783.07

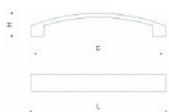



ART. 1780

ART. 1780 · Made in Italy

L (mm)	C (mm)	H (mm)	Ø (mm)	materiale	codice
206	128	26,5	206	zama	1780.00
97	64	26,5	150	zama	1780.01
220	160	26,5	220	zama	1780.03
225	192	26,5	230	zama	1780.04



ART. 1779

ART. 1779 · Made in Italy

L (mm)	C (mm)	H (mm)	Ø (mm)	materiale	codice
152	128	26	36	zama	1779.00

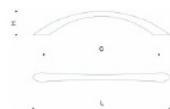



ART. 1778

ART. 1778 · Made in Italy

L (mm)	C (mm)	H (mm)	Ø (mm)	materiale	codice
80	64	26	95	zama	1778.01

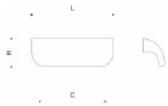

ART. 1776

ART. 1776 · Made in Italy

L (mm)	C (mm)	H (mm)	Ø (mm)	materiale	codice
160	128	22	83	zama	1776.00

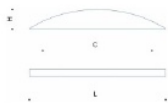



ART. 1775

ART. 1775 · Made in Italy

L (mm)	C (mm)	H (mm)	Ø (mm)	materiale	codice
220	160	30	173	zama	1775.03



ART. 1772

ART. 1772 · Made in Italy

L (mm)	C (mm)	H (mm)	Ø (mm)	materiale	codice
200	160	29	175	zama	1772.03

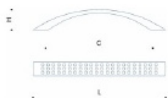



ART. 1771

ART. 1771 · Made in Italy

L (mm)	C (mm)	H (mm)	Ø (mm)	materiale	codice
60	32	30	59	ferro	1771.11



ART. 1770

ART. 1770 · Made in Italy

L (mm)	C (mm)	H (mm)	Ø (mm)	materiale	codice
160	96	24	121	zama	1770.02

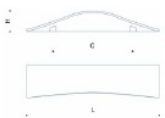



ART. 1769

ART. 1769 · Made in Italy

L (mm)	C (mm)	H (mm)	Ø (mm)	materiale	codice
145	128	33,8	90	zama+legno	1769.00
177	160	33,8	100	zama+legno	1769.03

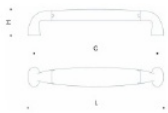

ART. 1768

ART. 1768 · Made in Italy

L (mm)	C (mm)	H (mm)	Ø (mm)	materiale	codice
234	224	36	160	ferro	1768.05



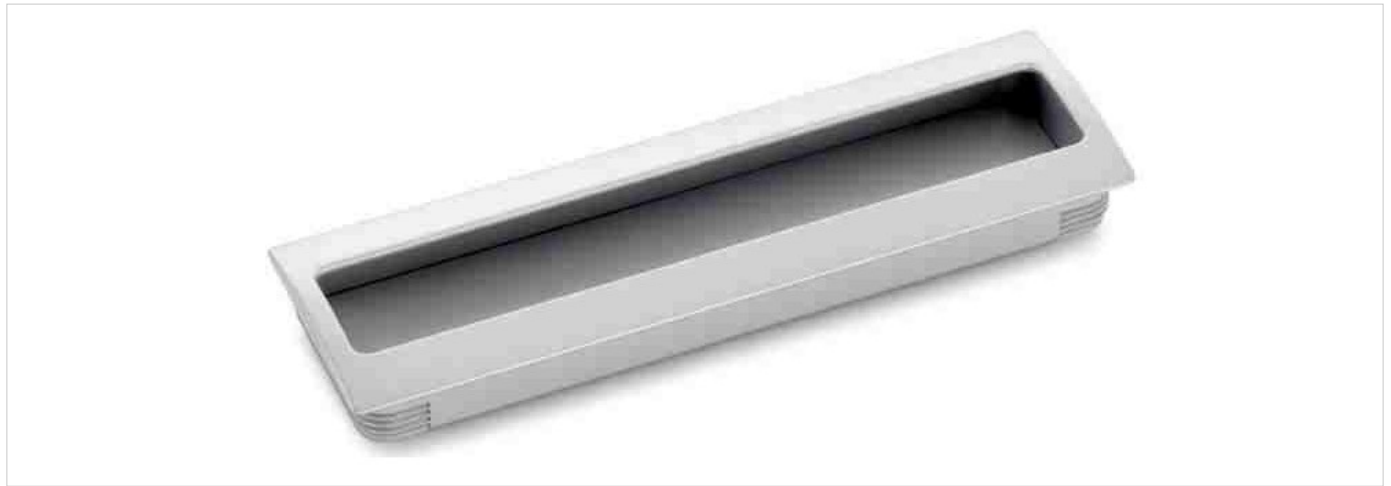

ART. 1767

ART. 1767 · Made in Italy

L (mm)	C (mm)	H (mm)	Ø (mm)	materiale	codice
180	160	14.5	255	zama+ferro	1767.03



ART. 1766

ART. 1766 · Made in Italy

L (mm)	C (mm)	H (mm)	Ø (mm)	materiale	codice
150	128	34	222	zama	1766.00
127	96	34	200	zama	1766.02
183	160	34	252	zama	1766.03
206	192	34	260	zama	1766.04
557	544	34	600	zama	1766.16





ART. 1763

ART. 1763 · Made in Italy

L (mm)	C (mm)	H (mm)	Ø (mm)	materiale	codice
60	32	20	51	zama	1763.11



ART. 1761

ART. 1761 · Made in Italy

L (mm)	C (mm)	H (mm)	Ø (mm)	materiale	codice
—	—	—	—	—	—

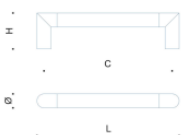

MANIGLIE

Handles · Made in Italy



ART. 1760

ART. 1760 · Made in Italy

L (mm)	C (mm)	H (mm)	Ø (mm)	materiale	codice
186	160	35	158	zama	1760.03

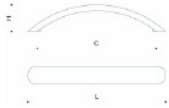

ART. 1758

ART. 1758 · Made in Italy

L (mm)	C (mm)	H (mm)	Ø (mm)	materiale	codice
155	128	29	120	zama	1758.00
185	160	29	130	zama	1758.03

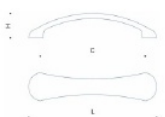



ART. 1757

ART. 1757 · Made in Italy

L (mm)	C (mm)	H (mm)	Ø (mm)	materiale	codice
170	128	28	122	zama	1757.00
138	96	28	120	zama	1757.02
203	160	28	150	zama	1757.03
362	352	28	205	zama	1757.09

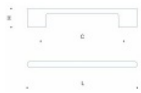

ART. 1755

ART. 1755 · Made in Italy

L (mm)	C (mm)	H (mm)	Ø (mm)	materiale	codice
145	128	32	129	zama	1755.00
265	224	32	239	zama	1755.05





ART. 1752

ART. 1752 · Made in Italy

L (mm)	C (mm)	H (mm)	Ø (mm)	materiale	codice
164	128	28	52	zama	1752.00

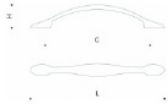

ART. 1751

ART. 1751 · Made in Italy

L (mm)	C (mm)	H (mm)	Ø (mm)	materiale	codice
152	128	29	100	zama	1751.00

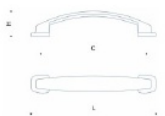

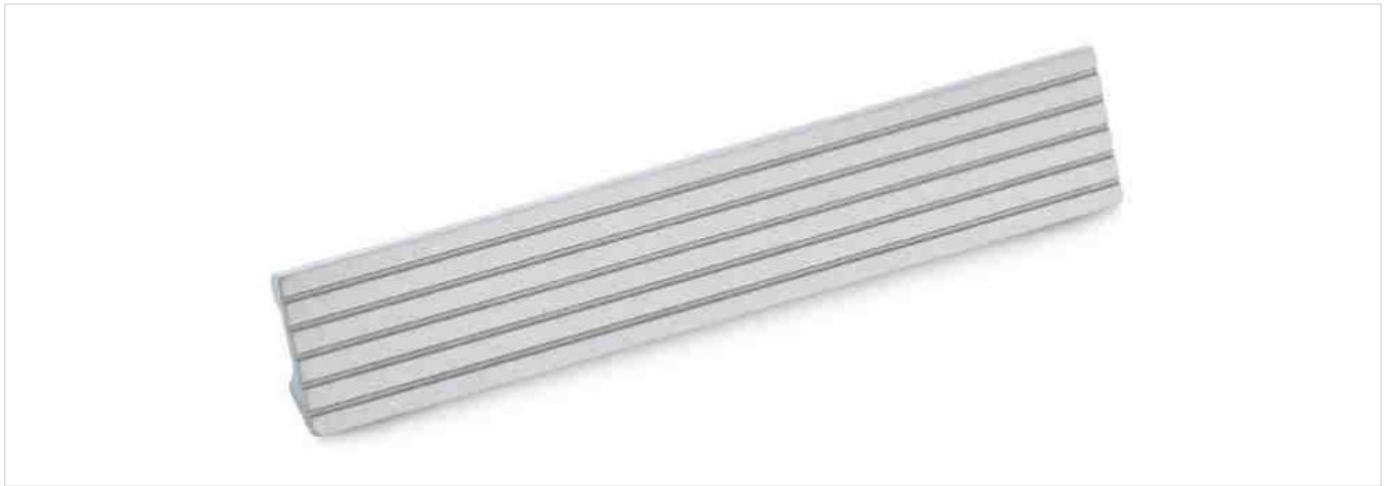

ART. 1743

ART. 1743 · Made in Italy

L (mm)	C (mm)	H (mm)	Ø (mm)	materiale	codice
185	160	30,7	165	zama	1743.03



ART. 1741

ART. 1741 · Made in Italy

L (mm)	C (mm)	H (mm)	Ø (mm)	materiale	codice
137	128	21	74	zama	1741.00





ART. 1736

ART. 1736 · Made in Italy

L (mm)	C (mm)	H (mm)	Ø (mm)	materiale	codice
180	—	24	235	zama	1736.03

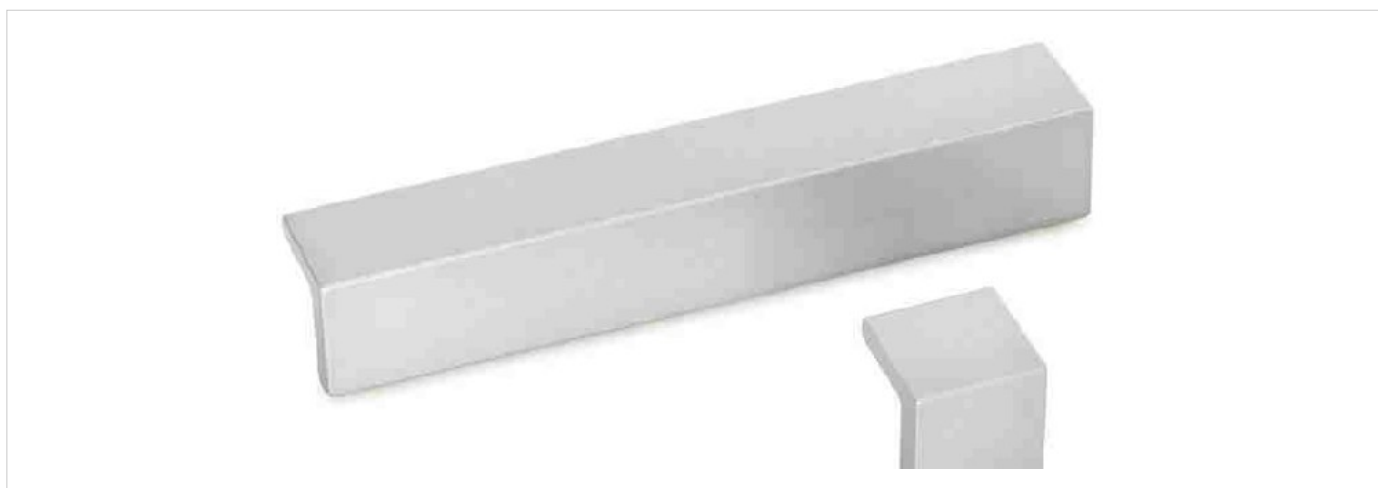

ART. 1735

ART. 1735 · Made in Italy

L (mm)	C (mm)	H (mm)	Ø (mm)	materiale	codice
180	160	30	196	zama	1735.03
30	16	30	47	zama	1735.92





ART. 1731

ART. 1731 · Made in Italy

L (mm)	C (mm)	H (mm)	Ø (mm)	materiale	codice
173	160	32	310	zama	1731.03



ART. 1729

ART. 1729 · Made in Italy

L (mm)	C (mm)	H (mm)	Ø (mm)	materiale	codice
172	160	32	175	—	1729.03

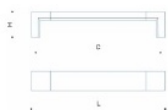



ART. 1726

ART. 1726 · Made in Italy

L (mm)	C (mm)	H (mm)	Ø (mm)	materiale	codice
105	96	35	61	zama	1726.02



ART. 1725

ART. 1725 · Made in Italy

L (mm)	C (mm)	H (mm)	Ø (mm)	materiale	codice
138	128	30	105	zama+PMMA	1725.00

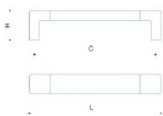



ART. 1724

ART. 1724 · Made in Italy

L (mm)	C (mm)	H (mm)	Ø (mm)	materiale	codice
96	64	22	29	zama	1724.01

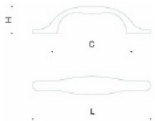

ART. 1723

ART. 1723 · Made in Italy

L (mm)	C (mm)	H (mm)	Ø (mm)	materiale	codice
149	128	20,3	159	zama	1723.00





ART. 1722

ART. 1722 · Made in Italy

L (mm)	C (mm)	H (mm)	Ø (mm)	materiale	codice
137	128	30	205	zama	1722.00



ART. 1721

ART. 1721 · Made in Italy

L (mm)	C (mm)	H (mm)	Ø (mm)	materiale	codice
140	128	32	115	zama+PMMA	1721.00
170	160	32	100	zama+PMMA	1721.03

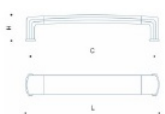



ART. 1720

ART. 1720 · Made in Italy

L (mm)	C (mm)	H (mm)	Ø (mm)	materiale	codice
225	96	29	111	zama	1720.02

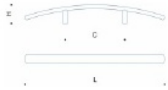

ART. 1718

ART. 1718 · Made in Italy

L (mm)	C (mm)	H (mm)	Ø (mm)	materiale	codice
213	128	26	161	zama	1718.00
245	160	26	194	zama	1718.03

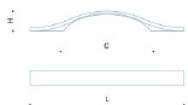



ART. 1716

ART. 1716 · Made in Italy

L (mm)	C (mm)	H (mm)	Ø (mm)	materiale	codice
40	32	20	20	zama	1716.11



ART. 1715

ART. 1715 · Made in Italy

L (mm)	C (mm)	H (mm)	Ø (mm)	materiale	codice
230	192	30,5	138	zama	1715.04





ART. 1712

ART. 1712 · Made in Italy

L (mm)	C (mm)	H (mm)	Ø (mm)	materiale	codice
174	160	36	212	zama	1712.03

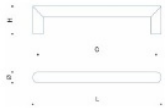

ART. 1711

ART. 1711 · Made in Italy

L (mm)	C (mm)	H (mm)	Ø (mm)	materiale	codice
130	96	29,5	141	zama	1711.02
260	224	31	228	zama	1711.05

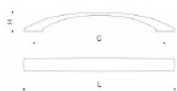



ART. 1705

ART. 1705 · Made in Italy

L (mm)	C (mm)	H (mm)	Ø (mm)	materiale	codice
78,5	64	26	40	zama	1705.01

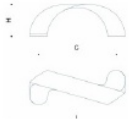

ART. 1704

ART. 1704 · Made in Italy

L (mm)	C (mm)	H (mm)	Ø (mm)	materiale	codice
—	—	—	—	—	—





ART. 1703

ART. 1703 · Made in Italy

L (mm)	C (mm)	H (mm)	Ø (mm)	materiale	codice
—	—	—	—	—	—



ART. 1702

ART. 1702 · Made in Italy

L (mm)	C (mm)	H (mm)	Ø (mm)	materiale	codice
138	96	24,5	140	zama	1702.02

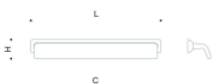



ART. 1701

ART. 1701 · Made in Italy

L (mm)	C (mm)	H (mm)	Ø (mm)	materiale	codice
230	192	30,5	160	zama	1701.04

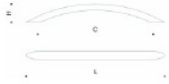

ART. 1699

ART. 1699 · Made in Italy

L (mm)	C (mm)	H (mm)	Ø (mm)	materiale	codice
—	—	—	—	—	—





ART. 1696

ART. 1696 · Made in Italy

L (mm)	C (mm)	H (mm)	Ø (mm)	materiale	codice
50	32	17	40	zama	1696.11



ART. 1695

ART. 1695 · Made in Italy

L (mm)	C (mm)	H (mm)	Ø (mm)	materiale	codice
—	—	—	—	—	—





ART. 1691

ART. 1691 · Made in Italy

L (mm)	C (mm)	H (mm)	Ø (mm)	materiale	codice
146	128	30	125	zama	1691.00



ART. 1685

ART. 1685 · Made in Italy

L (mm)	C (mm)	H (mm)	Ø (mm)	materiale	codice
232	224	60	124	ferro	1685.05
264	256	60	145	ferro	1685.05





ART. 1682

ART. 1682 · Made in Italy

L (mm)	C (mm)	H (mm)	Ø (mm)	materiale	codice
154	128	34	145	zama	1682.00

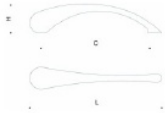

ART. 1680

ART. 1680 · Made in Italy

L (mm)	C (mm)	H (mm)	Ø (mm)	materiale	codice
128	96	30	95	zama	1680.02

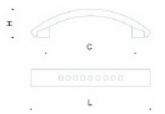



ART. 1677

ART. 1677 · Made in Italy

L (mm)	C (mm)	H (mm)	Ø (mm)	materiale	codice
167	160	25	215	zama	1677.03

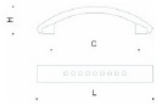

ART. 1675

ART. 1675 · Made in Italy

L (mm)	C (mm)	H (mm)	Ø (mm)	materiale	codice
153	128	27,5	75	zama	1675.00
120	96	25	55	zama	1675.02

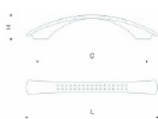



ART. 1672

ART. 1672 · Made in Italy

L (mm)	C (mm)	H (mm)	Ø (mm)	materiale	codice
152	128	25	40	zama	1672.00

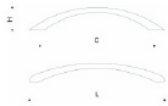

ART. 1670

ART. 1670 · Made in Italy

L (mm)	C (mm)	H (mm)	Ø (mm)	materiale	codice
224	160	30	180	zama	1670.03





ART. 1666

ART. 1666 · Made in Italy

L (mm)	C (mm)	H (mm)	Ø (mm)	materiale	codice
185	128	30	75	zama	1666.00

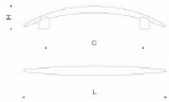

ART. 1665

ART. 1665 · Made in Italy

L (mm)	C (mm)	H (mm)	Ø (mm)	materiale	codice
200	128	30	109	zama	1665.00





ART. 1659

ART. 1659 · Made in Italy

L (mm)	C (mm)	H (mm)	Ø (mm)	materiale	codice
109	96	30,5	65	zama	1659.02

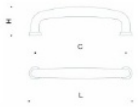

ART. 1658

ART. 1658 · Made in Italy

L (mm)	C (mm)	H (mm)	Ø (mm)	materiale	codice
135	128	28	85	zama	1658.00
167	160	28	100	zama	1658.03

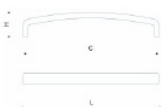



ART. 1657

ART. 1657 · Made in Italy

L (mm)	C (mm)	H (mm)	Ø (mm)	materiale	codice
164	128	27	130	zama	1657.00

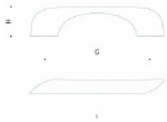

ART. 1656

ART. 1656 · Made in Italy

L (mm)	C (mm)	H (mm)	Ø (mm)	materiale	codice
136	128	26,5	55	zama	1656.00





ART. 1654

ART. 1654 · Made in Italy

L (mm)	C (mm)	H (mm)	Ø (mm)	materiale	codice
280	32	32	255	zama	1654.11

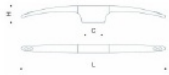

ART. 1649

ART. 1649 · Made in Italy

L (mm)	C (mm)	H (mm)	Ø (mm)	materiale	codice
82	64	24,5	30	zama	1649.01





ART. 1647

ART. 1647 · Made in Italy

L (mm)	C (mm)	H (mm)	Ø (mm)	materiale	codice
196	160	29,5	105	zama	1647.03

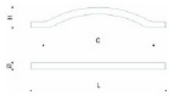

ART. 1645

ART. 1645 · Made in Italy

L (mm)	C (mm)	H (mm)	Ø (mm)	materiale	codice
148,5	128	30,5	115	zama+legno	1645.00
148,5	128	30,5	50	zama+legno	1645.00
116	96	30,5	48	zama+legno	1645.01

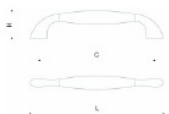

MANIGLIE

Handles · Made in Italy



ART. 1644

ART. 1644 · Made in Italy

L (mm)	C (mm)	H (mm)	Ø (mm)	materiale	codice
124	96	33	65	zama	1644.02

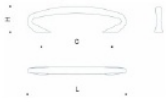

ART. 1640

ART. 1640 · Made in Italy

L (mm)	C (mm)	H (mm)	Ø (mm)	materiale	codice
164	128	25	70	zama	1640.00





ART. 1636

ART. 1636 · Made in Italy

L (mm)	C (mm)	H (mm)	Ø (mm)	materiale	codice
80	64	21	100	zama	1636.01
110	96	29	125	zama	1636.02

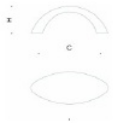

ART. 1635

ART. 1635 · Made in Italy

L (mm)	C (mm)	H (mm)	Ø (mm)	materiale	codice
50	16	18,5	65	zama	1635.92





ART. 1632

ART. 1632 · Made in Italy

L (mm)	C (mm)	H (mm)	Ø (mm)	materiale	codice
135	128	30	75	zama	1632.00

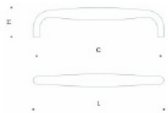

ART. 1628

ART. 1628 · Made in Italy

L (mm)	C (mm)	H (mm)	Ø (mm)	materiale	codice
170	128	30	100	zama	1628.00
202	160	30	75	zama	1628.03

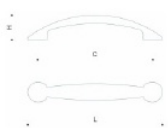



ART. 1627

ART. 1627 · Made in Italy

L (mm)	C (mm)	H (mm)	Ø (mm)	materiale	codice
168	128	30	155	zama	1627.00

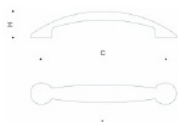

ART. 1626

ART. 1626 · Made in Italy

L (mm)	C (mm)	H (mm)	Ø (mm)	materiale	codice
224	192	35	280	zama	1626.04

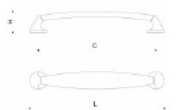



ART. 1625

ART. 1625 · Made in Italy

L (mm)	C (mm)	H (mm)	Ø (mm)	materiale	codice
98	64	23	45	zama	1625.01
129	96	26	50	zama	1625.02

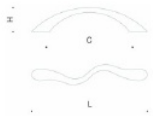

ART. 1622

ART. 1622 · Made in Italy

L (mm)	C (mm)	H (mm)	Ø (mm)	materiale	codice
148	128	30	135	zama	1622.00

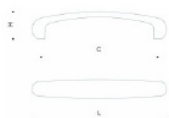



ART. 1614

ART. 1614 · Made in Italy

L (mm)	C (mm)	H (mm)	Ø (mm)	materiale	codice
204	192	35	170	zama	1614.04
364	352	35	285	zama	1614.09



ART. 1613

ART. 1613 · Made in Italy

L (mm)	C (mm)	H (mm)	Ø (mm)	materiale	codice
190	128	33,2	190	zama	1613.00

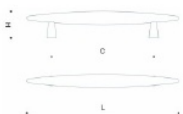



ART. 1612

ART. 1612 · Made in Italy

L (mm)	C (mm)	H (mm)	Ø (mm)	materiale	codice
126	96	30	120	zama	1612.02
196	160	30	120	zama	1612.03

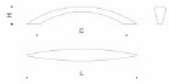

ART. 1610

ART. 1610 · Made in Italy

L (mm)	C (mm)	H (mm)	Ø (mm)	materiale	codice
190	128	28,7	95	zama	1610.01
117	64	27,5	45	zama	1610.01

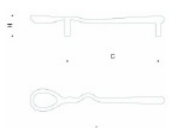



ART. 1609

ART. 1609 · Made in Italy

L (mm)	C (mm)	H (mm)	Ø (mm)	materiale	codice
118	96	28,5	40	zama	1609.02

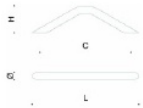

ART. 1607

ART. 1607 · Made in Italy

L (mm)	C (mm)	H (mm)	Ø (mm)	materiale	codice
162	128	28,5	70	zama	1607.00
125	96	27,6	42	zama	1607.02

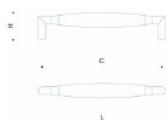



ART. 1604

ART. 1604 · Made in Italy

L (mm)	C (mm)	H (mm)	Ø (mm)	materiale	codice
43	32	29,7	25	zama	1604.11



ART. 1603

ART. 1603 · Made in Italy

L (mm)	C (mm)	H (mm)	Ø (mm)	materiale	codice
74	64	30	30	zama	1603.01

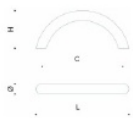



ART. 1574

ART. 1574 · Made in Italy

L (mm)	C (mm)	H (mm)	Ø (mm)	materiale	codice
104	96	25,8	50	ferro	1574.02

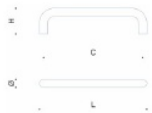

ART. 1573

ART. 1573 · Made in Italy

L (mm)	C (mm)	H (mm)	Ø (mm)	materiale	codice
163	128	30,8	85	zama	1573.00
127	96	30,2	70	zama	1573.02
270	224	31,7	140	zama	1573.05

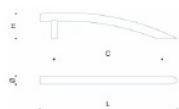



ART. 1569

ART. 1569 · Made in Italy

L (mm)	C (mm)	H (mm)	Ø (mm)	materiale	codice
164	128	26	95	zama	1569.00

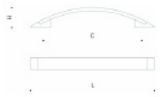

ART. 1568

ART. 1568 · Made in Italy

L (mm)	C (mm)	H (mm)	Ø (mm)	materiale	codice
172	128	19,5	60	zama	1568.00
172	96	19,5	60	zama	1568.02

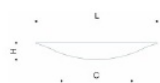



ART. 1567

ART. 1567 · Made in Italy

L (mm)	C (mm)	H (mm)	Ø (mm)	materiale	codice
172	128	27,5	50	zama	1567.00



ART. 1563

ART. 1563 · Made in Italy

L (mm)	C (mm)	H (mm)	Ø (mm)	materiale	codice
77	64	26	40	zama	1563.01
108	96	31	40	zama	1563.02

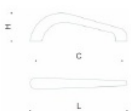

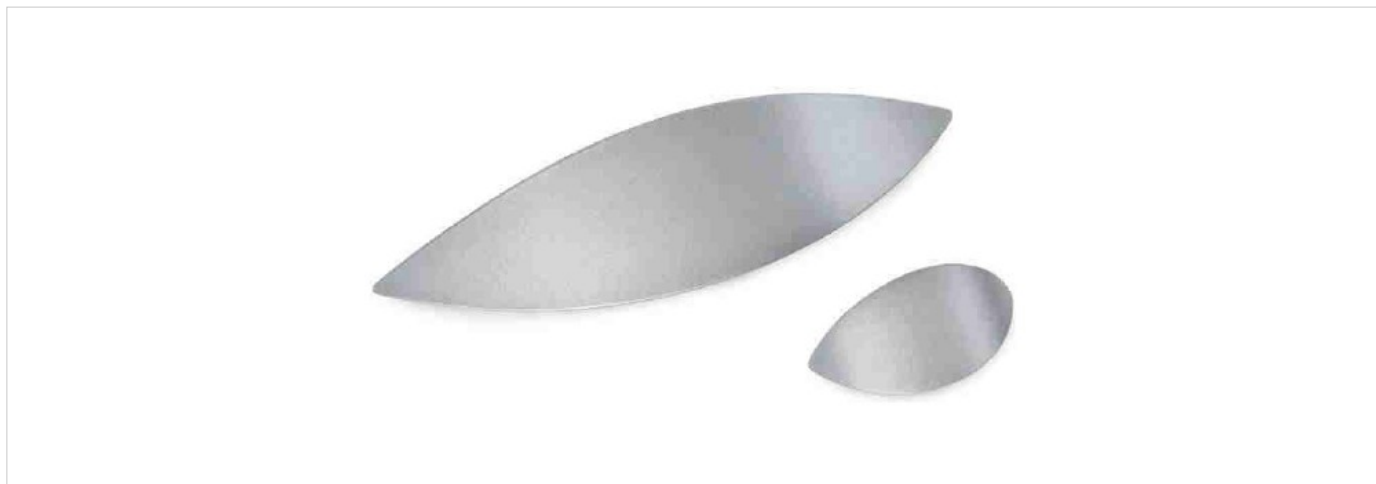

ART. 1562

ART. 1562 · Made in Italy

L (mm)	C (mm)	H (mm)	Ø (mm)	materiale	codice
137	96	27	50	zama	1562.02
51	32	18	15	zama	1562.11

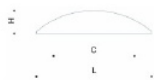

ART. 1558

ART. 1558 · Made in Italy

L (mm)	C (mm)	H (mm)	Ø (mm)	materiale	codice
458	448	36	290	ferro	1558.13





ART. 1541

ART. 1541 · Made in Italy

L (mm)	C (mm)	H (mm)	Ø (mm)	materiale	codice
151	128	30	75	zama	1541.00
269	224	30	125	zama	1541.05
334	288	30	160	zama	1541.07



ART. 1540

ART. 1540 · Made in Italy

L (mm)	C (mm)	H (mm)	Ø (mm)	materiale	codice
200	192	30	90	ferro	1540.04
232	224	30	100	ferro	1540.05





ART. 1530

ART. 1530 · Made in Italy

L (mm)	C (mm)	H (mm)	Ø (mm)	materiale	codice
—	—	—	—	—	—

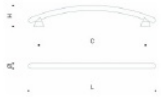

ART. 1528

ART. 1528 · Made in Italy

L (mm)	C (mm)	H (mm)	Ø (mm)	materiale	codice
152	128	27	30	zama	1528.00

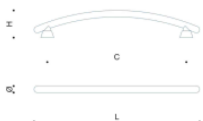



ART. 1524

ART. 1524 · Made in Italy

L (mm)	C (mm)	H (mm)	Ø (mm)	materiale	codice
72	64	26,5	40	zama	1524.01



ART. 1522

ART. 1522 · Made in Italy

L (mm)	C (mm)	H (mm)	Ø (mm)	materiale	codice
158	128	29	45	zama	1522.00
80	64	24,5	30	zama	1522.01
125	96	26,5	40	zama	1522.02

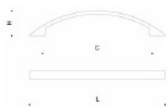



ART. 1517

ART. 1517 · Made in Italy

L (mm)	C (mm)	H (mm)	Ø (mm)	materiale	codice
79	64	23	30	zama	1517.01

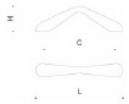

ART. 1512

ART. 1512 · Made in Italy

L (mm)	C (mm)	H (mm)	Ø (mm)	materiale	codice
—	—	—	—	—	—





ART. 1503

ART. 1503 · Made in Italy

L (mm)	C (mm)	H (mm)	Ø (mm)	materiale	codice
108	96	25	30	zama	1503.02



ART. 1501

ART. 1501 · Made in Italy

L (mm)	C (mm)	H (mm)	Ø (mm)	materiale	codice
145	128	24	45	zama	1501.00



MANIGLIE MODULARI

Modular Handles · Made in Italy

FALCHIT



ART. 1951

ART. 1951 · Made in Italy

L (mm)	C (mm)	H (mm)	Ø (mm)	materiale	codice
—	—	42	18	ferro	1951



ART. 1942

ART. 1942 · Made in Italy

L (mm)	C (mm)	H (mm)	Ø (mm)	materiale	codice
—	—	28	—	alluminio	1942



**ART. 1938***ART. 1938 - Made in Italy*

L (mm)	C (mm)	H (mm)	Ø (mm)	materiale	codice
—	—	23	—	alluminio	1938

**ART. 1935***ART. 1935 - Made in Italy*

L (mm)	C (mm)	H (mm)	Ø (mm)	materiale	codice
—	—	20	—	alluminio	1935.150



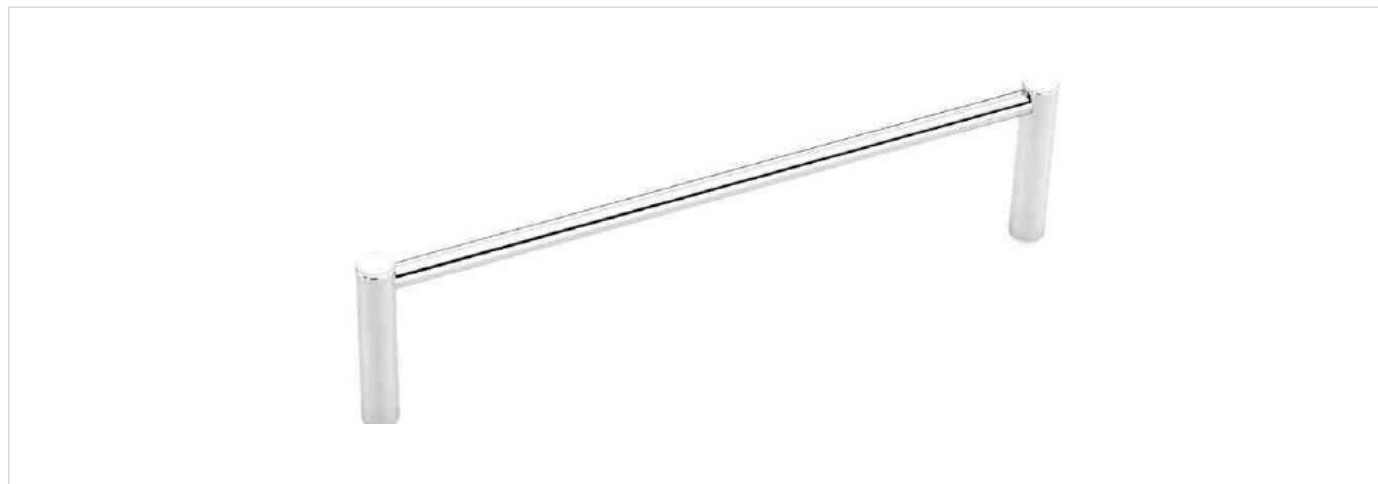

ART. 1915

ART. 1915 - Made in Italy

L (mm)	C (mm)	H (mm)	Ø (mm)	materiale	codice
—	—	60	8	acciaio+ferro	1915



ART. 1914

ART. 1914 - Made in Italy

L (mm)	C (mm)	H (mm)	Ø (mm)	materiale	codice
—	—	32	12	acciaio inox	1914



MANIGLIE MODULARI

Modular Handles - Made in Italy



ART. 1913

ART. 1913 - Made in Italy

L (mm)	C (mm)	H (mm)	Ø (mm)	materiale	codice
—	—	—	—	zama+inox+PA	—



ART. 1875

ART. 1875 - Made in Italy

L (mm)	C (mm)	H (mm)	Ø (mm)	materiale	codice
—	—	18	—	alluminio	1875





ART. 1851

ART. 1851 - Made in Italy

L (mm)	C (mm)	H (mm)	Ø (mm)	materiale	codice
—	—	—	—	alluminio	1851

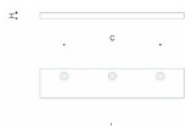

ART. 1849

ART. 1849 - Made in Italy

L (mm)	C (mm)	H (mm)	Ø (mm)	materiale	codice
—	—	15	—	alluminio+PE	1849





ART. 1848

ART. 1848 - Made in Italy

L (mm)	C (mm)	H (mm)	Ø (mm)	materiale	codice
—	—	30	—	alluminio	1848



ART. 1842

ART. 1842 - Made in Italy

L (mm)	C (mm)	H (mm)	Ø (mm)	materiale	codice
—	—	25	—	alluminio	1842



**ART. 1834**

ART. 1834 - Made in Italy

L (mm)	C (mm)	H (mm)	Ø (mm)	materiale	codice
—	—	34	14	zama+alluminio	1834

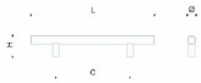
**ART. 1833**

ART. 1833 - Made in Italy

L (mm)	C (mm)	H (mm)	Ø (mm)	materiale	codice
—	—	20	—	alluminio	1833





ART. 1829

ART. 1829 - Made in Italy

L (mm)	C (mm)	H (mm)	Ø (mm)	materiale	codice
—	—	23	—	alluminio	1829



ART. 1826

ART. 1826 - Made in Italy

L (mm)	C (mm)	H (mm)	Ø (mm)	materiale	codice
—	—	33	12	zama+ferro	1826





ART. 1825

ART. 1825 - Made in Italy

L (mm)	C (mm)	H (mm)	Ø (mm)	materiale	codice
—	—	32	12	zama+alluminio	1825



ART. 1814

ART. 1814 - Made in Italy

L (mm)	C (mm)	H (mm)	Ø (mm)	materiale	codice
—	—	18	—	alluminio	1814





ART. 1809

ART. 1809 - Made in Italy

L (mm)	C (mm)	H (mm)	Ø (mm)	materiale	codice
—	—	36	15	zama+ferro	1809



ART. 1808

ART. 1808 - Made in Italy

L (mm)	C (mm)	H (mm)	Ø (mm)	materiale	codice
—	—	36	15	zama+acciaio	1808





ART. 1807C

ART. 1807C - Made in Italy

L (mm)	C (mm)	H (mm)	Ø (mm)	materiale	codice
—	—	58	12	zama+ferro	1807C



ART. 1807

ART. 1807 - Made in Italy

L (mm)	C (mm)	H (mm)	Ø (mm)	materiale	codice
—	—	58	12	zama+ferro	1807



**ART. 1801***ART. 1801 - Made in Italy*

L (mm)	C (mm)	H (mm)	Ø (mm)	materiale	codice
—	—	57	—	zama+alluminio	1801

**ART. 1781***ART. 1781 - Made in Italy*

L (mm)	C (mm)	H (mm)	Ø (mm)	materiale	codice
—	—	32	12	acciaio inox	1781



**ART. 1777**

ART. 1777 · Made in Italy

L (mm)	C (mm)	H (mm)	Ø (mm)	materiale	codice
—	—	34	14	zama+ferro	1777

**ART. 1764**

ART. 1764 · Made in Italy

L (mm)	C (mm)	H (mm)	Ø (mm)	materiale	codice
—	—	35	—	alluminio	1764



**ART. 1759**

ART. 1759 - Made in Italy

L (mm)	C (mm)	H (mm)	Ø (mm)	materiale	codice
—	—	29	12	zama+ferro	1759

**ART. 1717**

ART. 1717 - Made in Italy

L (mm)	C (mm)	H (mm)	Ø (mm)	materiale	codice
—	—	42	12	zama+ferro	1717





ART. 1684

ART. 1684 · Made in Italy

L (mm)	C (mm)	H (mm)	Ø (mm)	materiale	codice
—	—	30	12	zama+ferro	1684

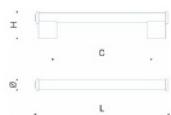

ART. 1655

ART. 1655 · Made in Italy

L (mm)	C (mm)	H (mm)	Ø (mm)	materiale	codice
—	—	32	12	zama+ferro	1655





ART. 1639

ART. 1639 - Made in Italy

L (mm)	C (mm)	H (mm)	Ø (mm)	materiale	codice
—	—	28	10	zama+ferro	1639



ART. 1629

ART. 1629 - Made in Italy

L (mm)	C (mm)	H (mm)	Ø (mm)	materiale	codice
—	—	25	10	zama+ferro	1629

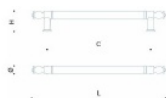



ART. 1577

ART. 1577 - Made in Italy

L (mm)	C (mm)	H (mm)	Ø (mm)	materiale	codice
196	128	32	12	zama+ferro	1577.00



ART. 1575C

ART. 1575C - Made in Italy

L (mm)	C (mm)	H (mm)	Ø (mm)	materiale	codice
443	320	32	12	zama+ferro	1575C





ART. 1535

ART. 1535 - Made in Italy

L (mm)	C (mm)	H (mm)	Ø (mm)	materiale	codice
—	—	30	14	zama+ferro	1535

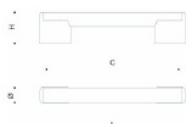

ART. 1521

ART. 1521 - Made in Italy

L (mm)	C (mm)	H (mm)	Ø (mm)	materiale	codice
—	—	32	12	zama+ferro	1521



MANIGLIE MODULARI

Modular Handles - Made in Italy



ART. 1516

ART. 1516 - Made in Italy

L (mm)	C (mm)	H (mm)	Ø (mm)	materiale	codice
—	—	30	12	zama+ferro	1516



POMOLI

Knobs · Made in Italy

FALCHIT

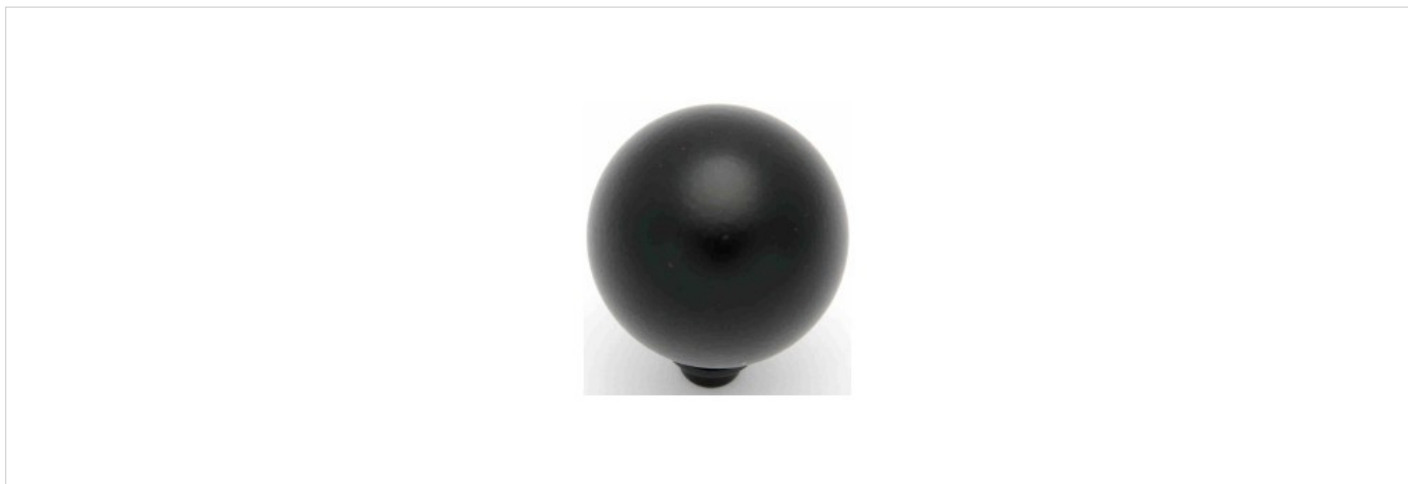

ART. 1936

ART. 1936 · Made in Italy

L (mm)	C (mm)	H (mm)	Ø (mm)	materiale	codice
54,5	39	66	—	ferro	1936

• Ø • • H •



ART. 1921

ART. 1921 · Made in Italy

L (mm)	C (mm)	H (mm)	Ø (mm)	materiale	codice
26	34,5	66	—	zama	1921

• Ø • • H •





ART. 1917

ART. 1917 · Made in Italy

L (mm)	C (mm)	H (mm)	Ø (mm)	materiale	codice
60	16	30	35	zama	1917



ART. 1878

ART. 1878 · Made in Italy

L (mm)	C (mm)	H (mm)	Ø (mm)	materiale	codice
30	34,5	13	—	legno	1878





ART. 1869

ART. 1869 · Made in Italy

L (mm)	C (mm)	H (mm)	Ø (mm)	materiale	codice
28,8	23	27	—	zama	1869



ART. 1860

ART. 1860 · Made in Italy

L (mm)	C (mm)	H (mm)	Ø (mm)	materiale	codice
28	35	25	—	zama+legno	1860





ART. 1844

ART. 1844 · Made in Italy

L (mm)	C (mm)	H (mm)	Ø (mm)	materiale	codice
26	38	—	—	legno	1844



ART. 1841

ART. 1841 · Made in Italy

L (mm)	C (mm)	H (mm)	Ø (mm)	materiale	codice
27	18	18	—	zama	1841





ART. 1840

ART. 1840 · Made in Italy

L (mm)	C (mm)	H (mm)	Ø (mm)	materiale	codice
26	32	40	—	zama	1840



ART. 1838

ART. 1838 · Made in Italy

L (mm)	C (mm)	H (mm)	Ø (mm)	materiale	codice
24,5	15	22	—	zama	1883





ART. 1823

ART. 1823 · Made in Italy

L (mm)	C (mm)	H (mm)	Ø (mm)	materiale	codice
29	34	80	—	zama	1823



ART. 1817

ART. 1817 · Made in Italy

L (mm)	C (mm)	H (mm)	Ø (mm)	materiale	codice
64	40	—	—	zama	1818





ART. 1816

ART. 1816 · Made in Italy

L (mm)	C (mm)	H (mm)	Ø (mm)	materiale	codice
8	17	8	—	zama	1816



ART. 1813

ART. 1813 · Made in Italy

L (mm)	C (mm)	H (mm)	Ø (mm)	materiale	codice
44	23	40	—	zama	1813





ART. 1806

ART. 1806 · Made in Italy

L (mm)	C (mm)	H (mm)	Ø (mm)	materiale	codice
27,5	44	90	—	zama	1806



ART. 1792

ART. 1792 · Made in Italy

L (mm)	C (mm)	H (mm)	Ø (mm)	materiale	codice
33	28	25	—	zama+legno	1792





ART. 1787

ART. 1787 · Made in Italy

L (mm)	C (mm)	H (mm)	Ø (mm)	materiale	codice
32,5	38	105	—	zama+ottone	1787



ART. 1786

ART. 1786 · Made in Italy

L (mm)	C (mm)	H (mm)	Ø (mm)	materiale	codice
50	32	30,5	115	zama	1786

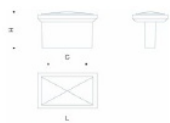



ART. 1756

ART. 1756 · Made in Italy

L (mm)	C (mm)	H (mm)	Ø (mm)	materiale	codice
29	19	40	—	zama	1756



ART. 1753

ART. 1753 · Made in Italy

L (mm)	C (mm)	H (mm)	Ø (mm)	materiale	codice
22,5	28	52	—	zama	1753



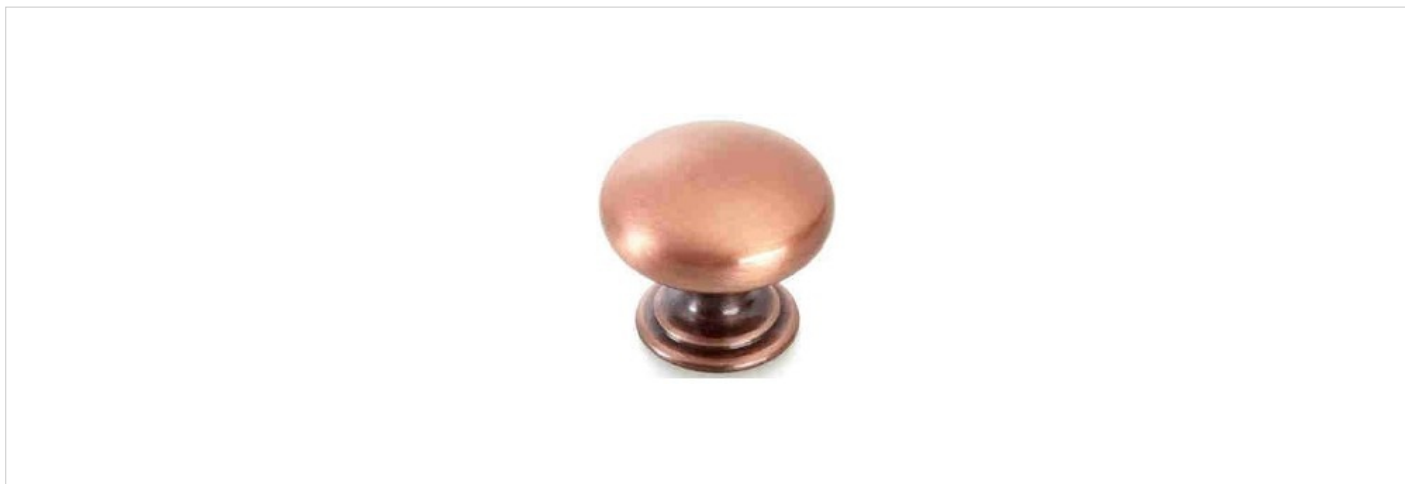

ART. 1742

ART. 1742 · Made in Italy

L (mm)	C (mm)	H (mm)	Ø (mm)	materiale	codice
24	10	10	—	ottone+PMMA	1742



ART. 1740

ART. 1740 · Made in Italy

L (mm)	C (mm)	H (mm)	Ø (mm)	materiale	codice
28	33	75	—	zama	1740





ART. 1739

ART. 1739 · Made in Italy

L (mm)	C (mm)	H (mm)	Ø (mm)	materiale	codice
22,5	28,5	45	—	zama	1739



ART. 1738

ART. 1738 · Made in Italy

L (mm)	C (mm)	H (mm)	Ø (mm)	materiale	codice
72	34	75	—	zama	1738





ART. 1733

ART. 1733 · Made in Italy

L (mm)	C (mm)	H (mm)	Ø (mm)	materiale	codice
25	29	4	—	zama	1733



ART. 1730

ART. 1730 · Made in Italy

L (mm)	C (mm)	H (mm)	Ø (mm)	materiale	codice
27	27	20	—	ottone+PMMA	1730





ART. 1719

ART. 1719 · Made in Italy

L (mm)	C (mm)	H (mm)	Ø (mm)	materiale	codice
22	23	58	—	zama	1719



ART. 1714

ART. 1714 · Made in Italy

L (mm)	C (mm)	H (mm)	Ø (mm)	materiale	codice
40	30	42	—	zama	1714





ART. 1710

ART. 1710 · Made in Italy

L (mm)	C (mm)	H (mm)	Ø (mm)	materiale	codice
27	19	15	—	ottone+PMMA	1710

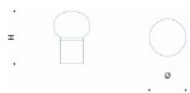

ART. 1700

ART. 1700 · Made in Italy

L (mm)	C (mm)	H (mm)	Ø (mm)	materiale	codice
15,5	29	5	—	ottone+PMMA	1700

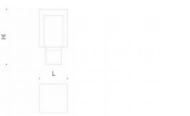

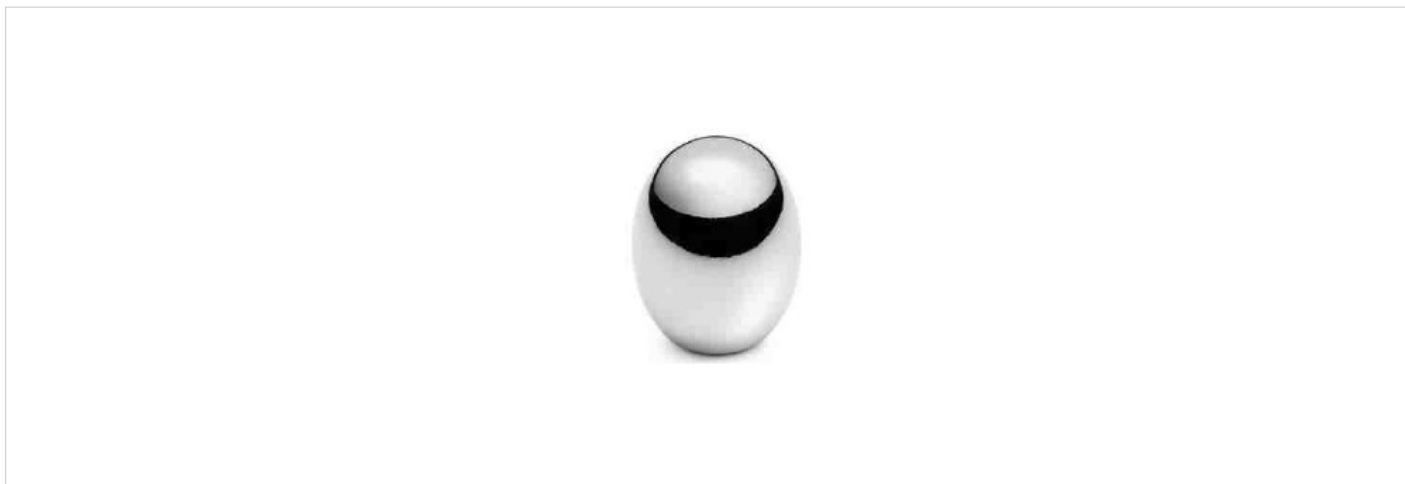

ART. 1694

ART. 1694 · Made in Italy

L (mm)	C (mm)	H (mm)	Ø (mm)	materiale	codice
53	17	20	—	zama	1694



ART. 1693

ART. 1693 · Made in Italy

L (mm)	C (mm)	H (mm)	Ø (mm)	materiale	codice
30,8	24,4	65	—	zama	1693





ART. 1689

ART. 1689 · Made in Italy

L (mm)	C (mm)	H (mm)	Ø (mm)	materiale	codice
28,5	17	30	—	zama	1689



ART. 1688

ART. 1688 · Made in Italy

L (mm)	C (mm)	H (mm)	Ø (mm)	materiale	codice
25,5	32	7	—	legno	1688





ART. 1676

ART. 1676 · Made in Italy

L (mm)	C (mm)	H (mm)	Ø (mm)	materiale	codice
24,5	28	45	—	zama	1676



ART. 1663

ART. 1663 · Made in Italy

L (mm)	C (mm)	H (mm)	Ø (mm)	materiale	codice
29	34	15	—	legno	1663





ART. 1660

ART. 1660 · Made in Italy

L (mm)	C (mm)	H (mm)	Ø (mm)	materiale	codice
23	35	45	—	zama	1660



ART. 1648

ART. 1648 · Made in Italy

L (mm)	C (mm)	H (mm)	Ø (mm)	materiale	codice
22	22	10	—	ottone+PMMA	1648





ART. 1643

ART. 1643 · Made in Italy

L (mm)	C (mm)	H (mm)	Ø (mm)	materiale	codice
45,5	32	21,3	45	zama	1643



ART. 1641

ART. 1641 · Made in Italy

L (mm)	C (mm)	H (mm)	Ø (mm)	materiale	codice
21,4	28	40	—	zama	1641





ART. 1638

ART. 1638 · Made in Italy

L (mm)	C (mm)	H (mm)	Ø (mm)	materiale	codice
33,5	34	25	—	zama+legno	1638



ART. 1637

ART. 1637 · Made in Italy

L (mm)	C (mm)	H (mm)	Ø (mm)	materiale	codice
24,6	29	75	—	zama+ferro	1637





ART. 1624

ART. 1624 · Made in Italy

L (mm)	C (mm)	H (mm)	Ø (mm)	materiale	codice
21,7	37	40	—	zama	1624



ART. 1623

ART. 1623 · Made in Italy

L (mm)	C (mm)	H (mm)	Ø (mm)	materiale	codice
24,7	33	45	—	zama	1623





ART. 1619

ART. 1619 · Made in Italy

L (mm)	C (mm)	H (mm)	Ø (mm)	materiale	codice
27,5	26	65	—	zama	1619



ART. 1618

ART. 1618 · Made in Italy

L (mm)	C (mm)	H (mm)	Ø (mm)	materiale	codice
10,5	35	10	—	zama	1618





ART. 1611

ART. 1611 · Made in Italy

L (mm)	C (mm)	H (mm)	Ø (mm)	materiale	codice
2	30,5	22	91	zama	1611



ART. 1601

ART. 1601 · Made in Italy

L (mm)	C (mm)	H (mm)	Ø (mm)	materiale	codice
30,5	45	110	—	zama	1601

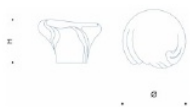



ART. 1581

ART. 1581 · Made in Italy

L (mm)	C (mm)	H (mm)	Ø (mm)	materiale	codice
30	34,5	120	—	zama	1581C



ART. 1572

ART. 1572 · Made in Italy

L (mm)	C (mm)	H (mm)	Ø (mm)	materiale	codice
22	35	—	—	zama	1572





ART. 1564

ART. 1564 · Made in Italy

L (mm)	C (mm)	H (mm)	Ø (mm)	materiale	codice
30	34	80	—	zama+ottone	1564



ART. 1560

ART. 1560 · Made in Italy

L (mm)	C (mm)	H (mm)	Ø (mm)	materiale	codice
24,5	27	25	—	zama	1560





ART. 1551

ART. 1551 · Made in Italy

L (mm)	C (mm)	H (mm)	Ø (mm)	materiale	codice
48	32	22	35	zama	1551



ART. 1544

ART. 1544 · Made in Italy

L (mm)	C (mm)	H (mm)	Ø (mm)	materiale	codice
30	2	70	—	zama+ottone	1544





ART. 1534

ART. 1534 · Made in Italy

L (mm)	C (mm)	H (mm)	Ø (mm)	materiale	codice
25	18	35	—	zama	1534



ART. 1525

ART. 1525 · Made in Italy

L (mm)	C (mm)	H (mm)	Ø (mm)	materiale	codice
27,5	34	45	—	zama+PMMA	1525





ART. 1523

ART. 1523 · Made in Italy

L (mm)	C (mm)	H (mm)	Ø (mm)	materiale	codice
24	31,5	70	—	zama	1523



ART. 1514

ART. 1514 · Made in Italy

L (mm)	C (mm)	H (mm)	Ø (mm)	materiale	codice
25,5	25	25	—	zama+PMMA	1514





ART. 1508

ART. 1508 · Made in Italy

L (mm)	C (mm)	H (mm)	Ø (mm)	materiale	codice
27,5	21,5	21	92	zama	1508



ART. 1507

ART. 1507 · Made in Italy

L (mm)	C (mm)	H (mm)	Ø (mm)	materiale	codice
25,5	25,5	27	90	zama	1507



ARTICOLI TECNICI

Technical Articles · Made in Italy

FALCHIT

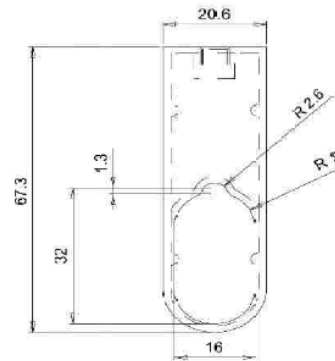
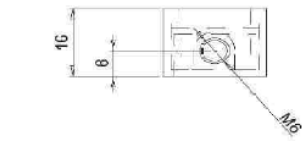
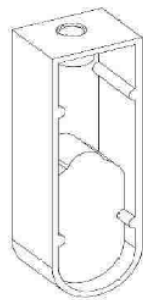
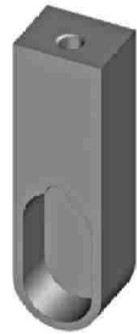

ART. 1230.00

Materiale: Zama

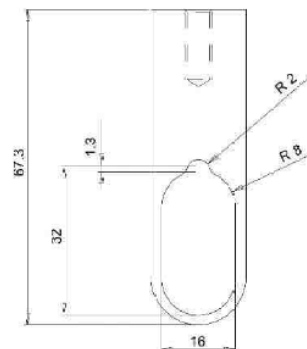
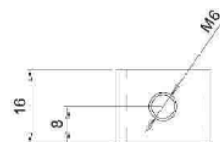
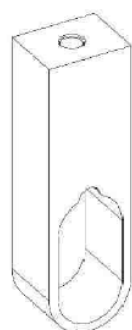

ART. 1231.00

Materiale: Zama

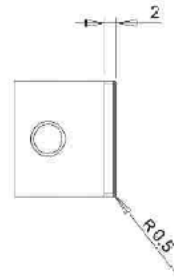
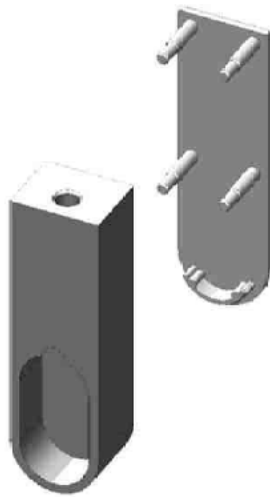

ART. tapx1230

Materiale: ABS

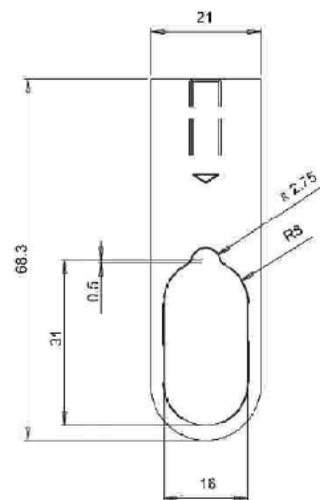
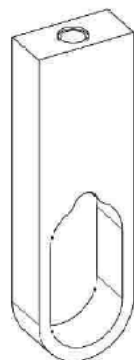
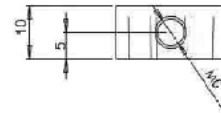

ART. 1231.01

Materiale: Zama

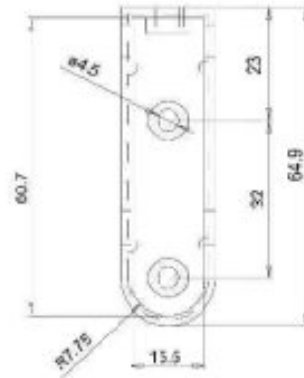
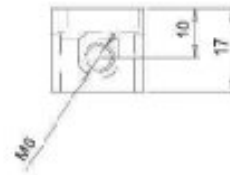

ART. 1417.00

Materiale: Zama

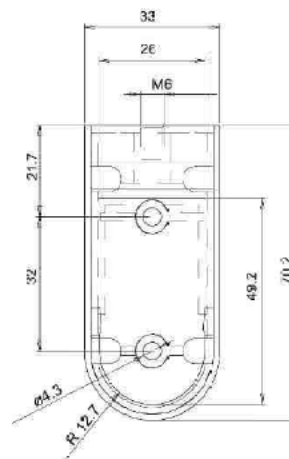
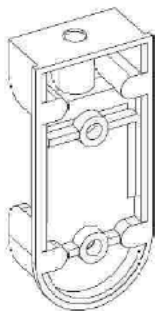
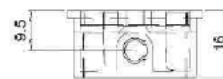
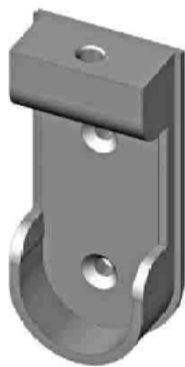

ART. 1431.00

Materiale: Zama

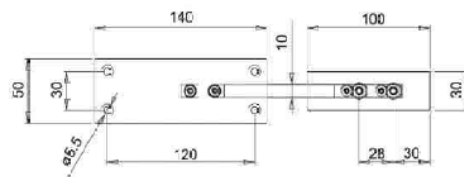
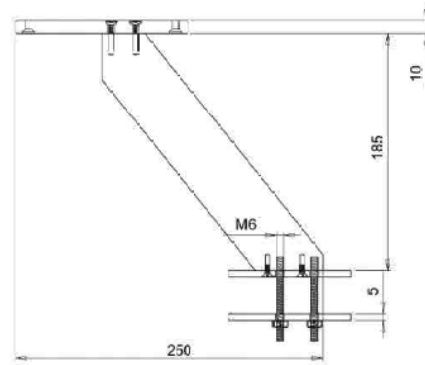

ART. 1221.00

Materiale: Alluminio / ferro

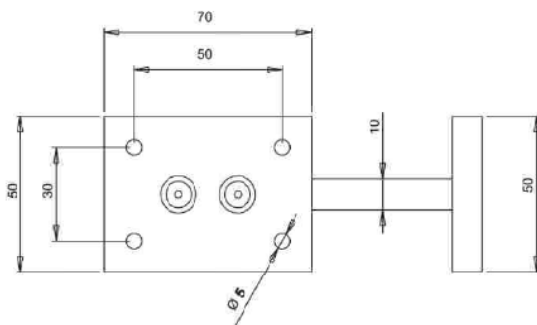
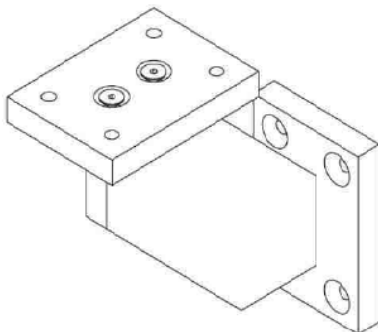
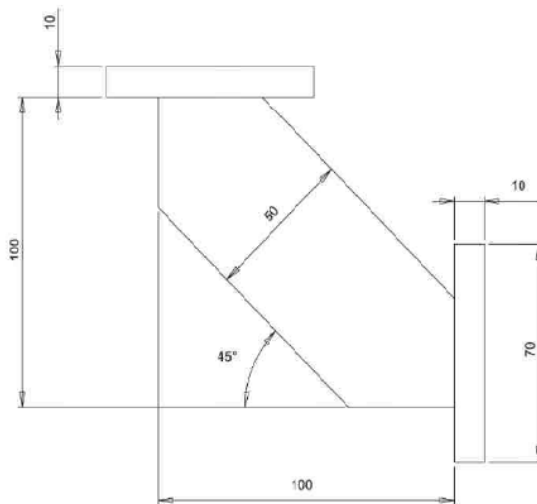
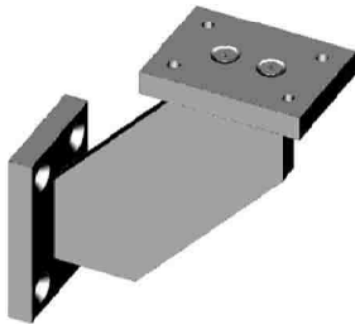

ART. 1281.00

Materiale: Alluminio / ferro

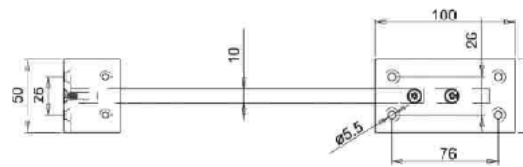
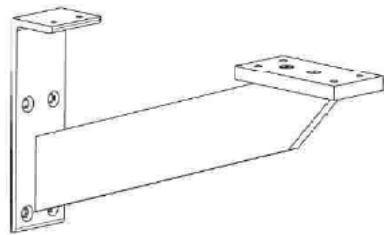
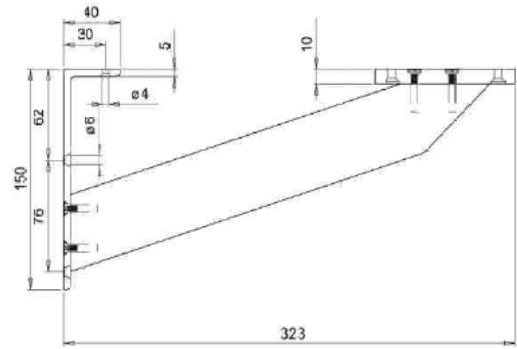
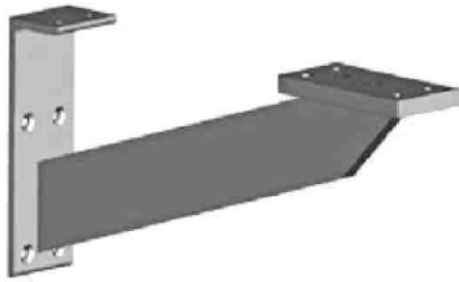

ART. 1222.00

Materiale: Alluminio / ferro

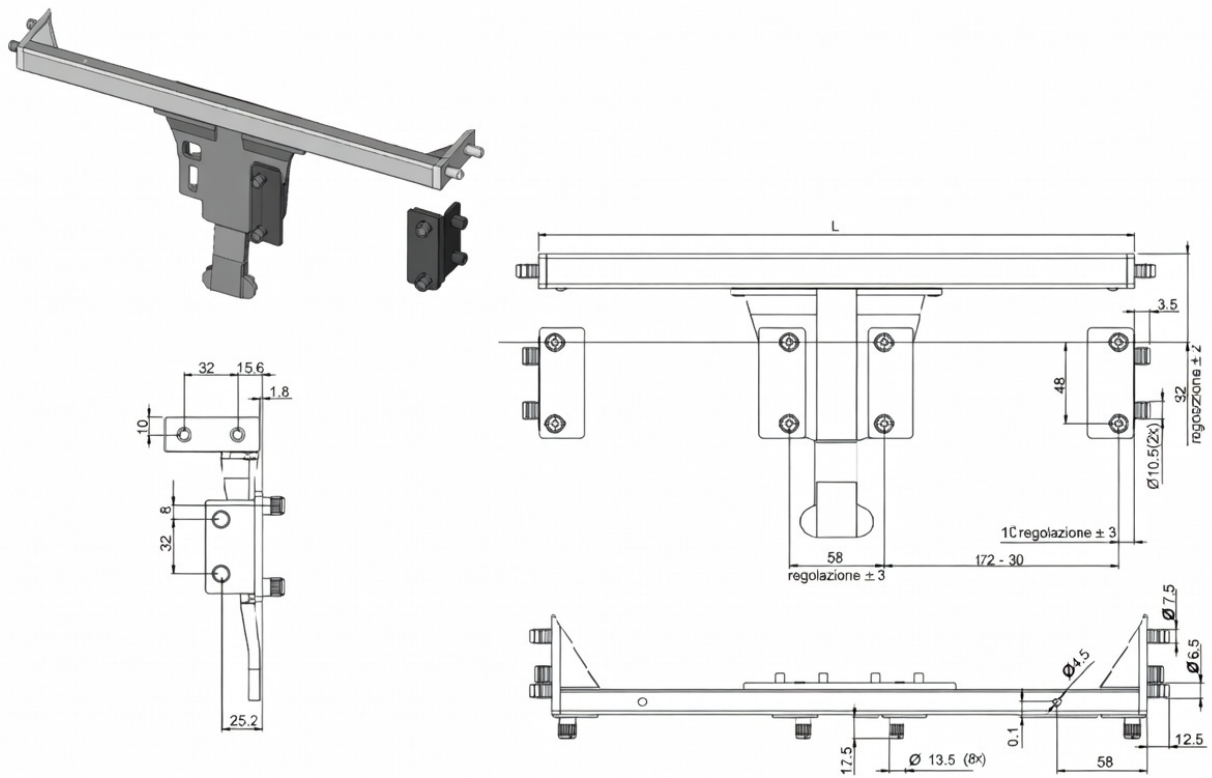

ART. 1468

Materiale: Ferro / PA

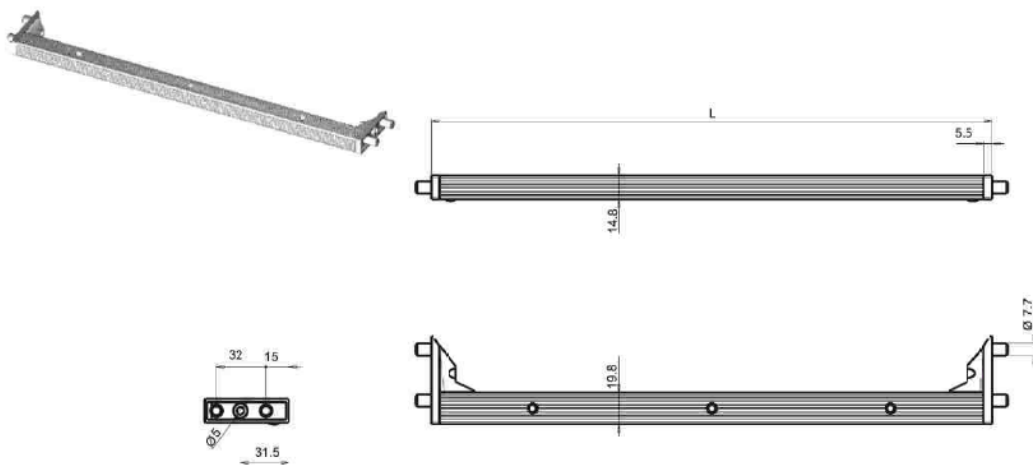

ART. 1477

Materiale: Alluminio / PA

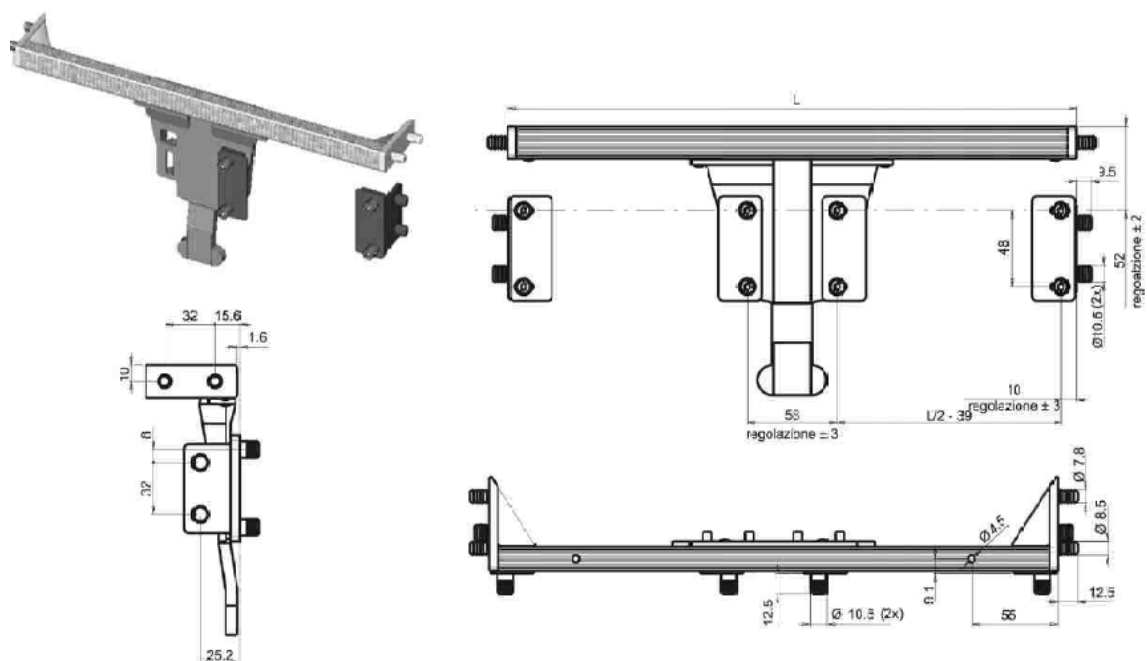

ART. 1476

Materiale: Alluminio / PA

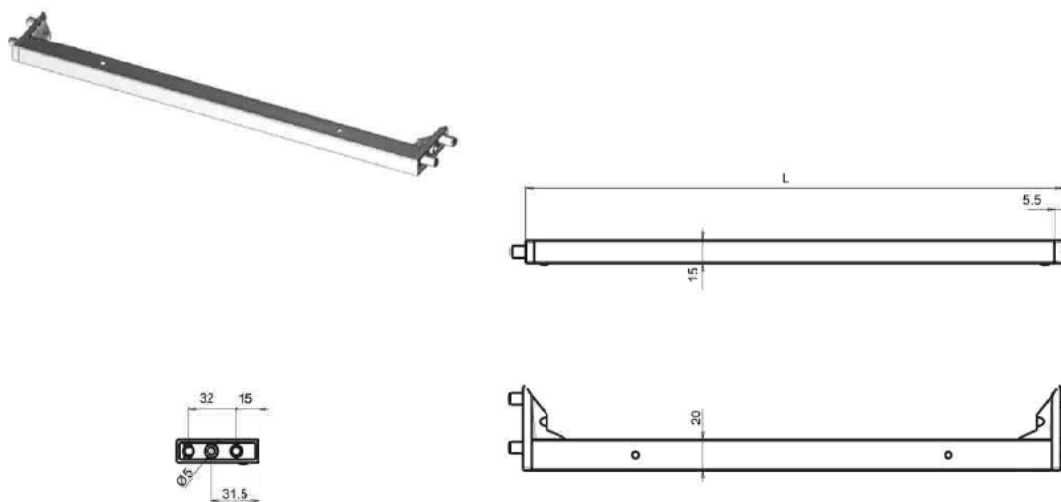

ART. 1480

Materiale: Ferro / PS

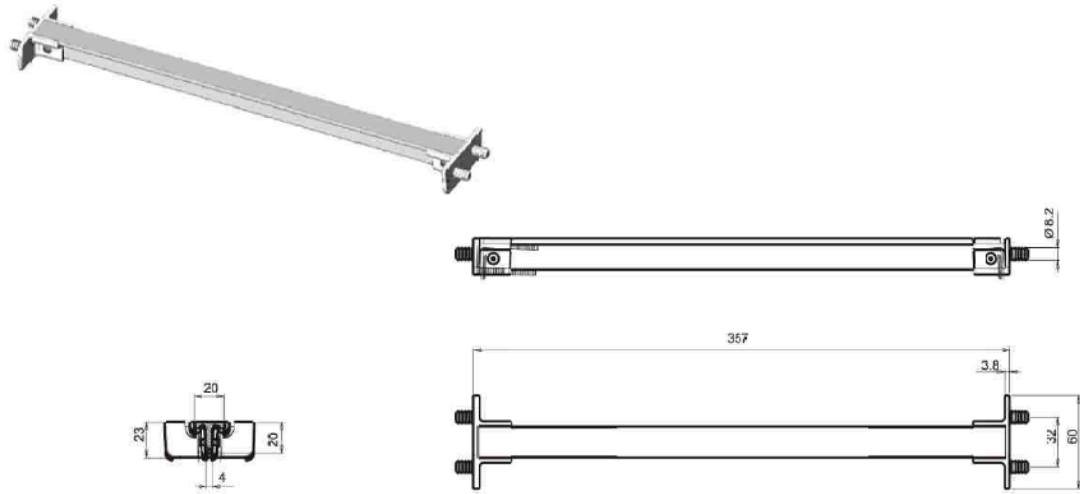

ART. 1489

Materiale: Ferro / PS

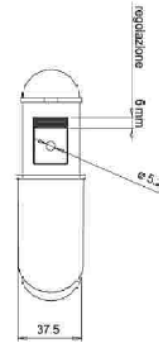
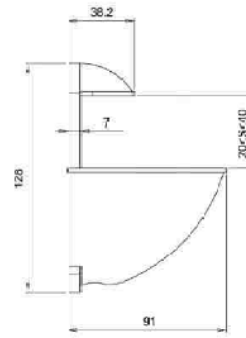
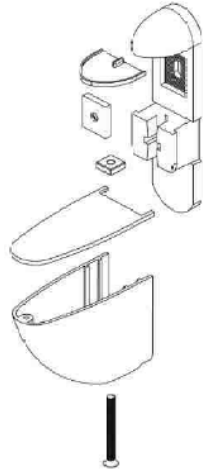

ART. 1204.00

Materiale: Zama / PE / ferro

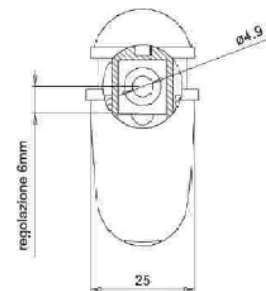
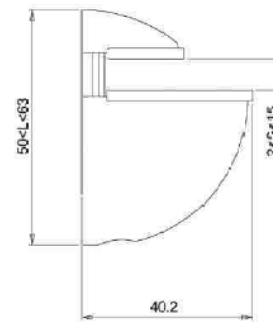
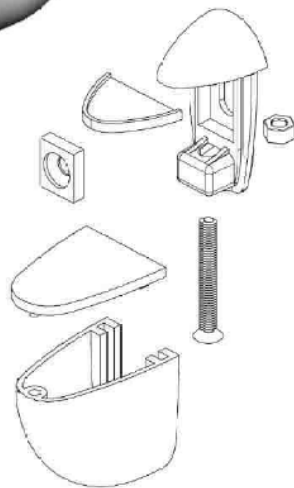

ART. 1218.00

Materiale: Zama / PE / ferro

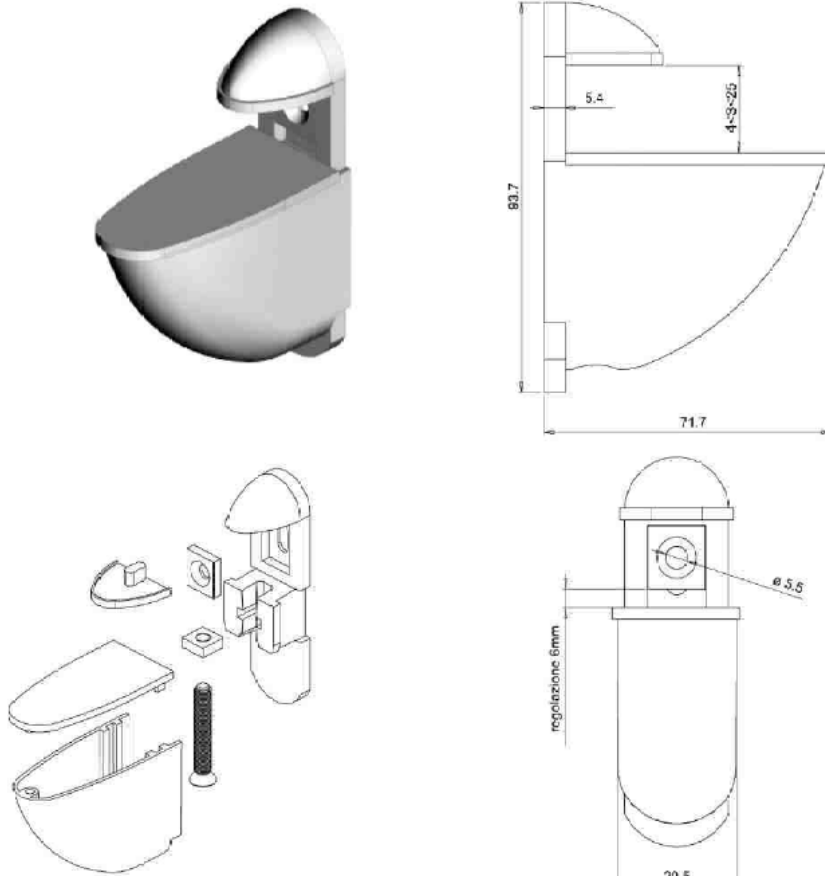

ART. 1205.00

Materiale: Zama / PE / ferro

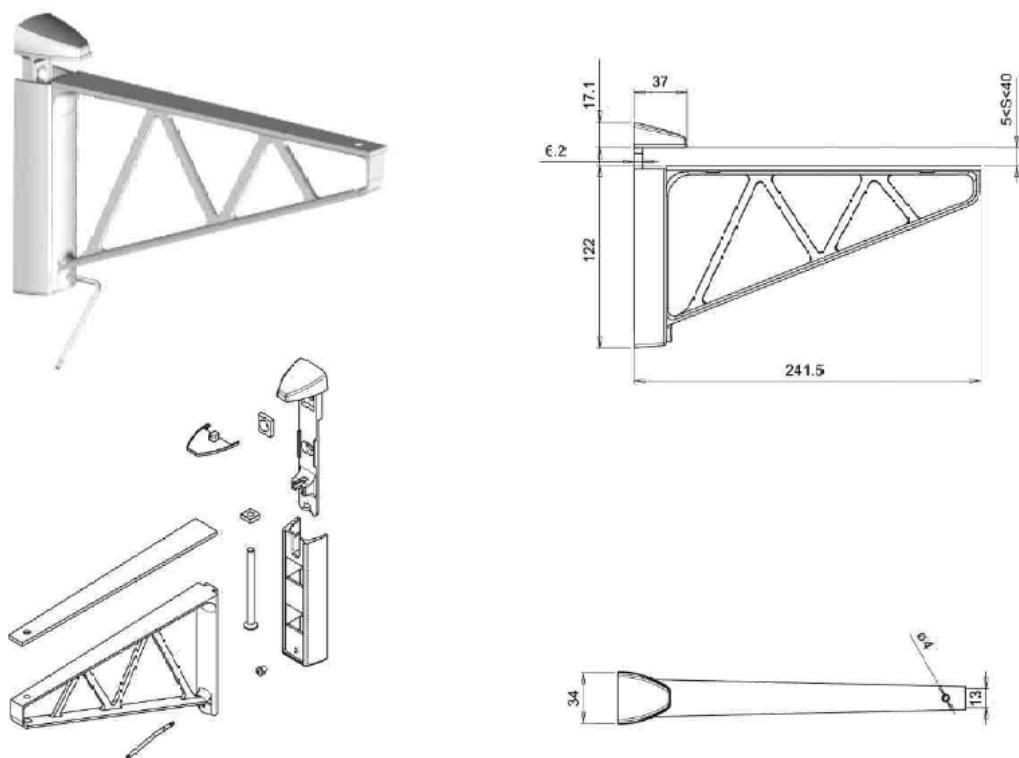

ART. 1235.01

Materiale: Zama / PE / ferro

CERNIERE PER TAVOLI E CRISTALLI

Table and Glass Hinges · Made in Italy

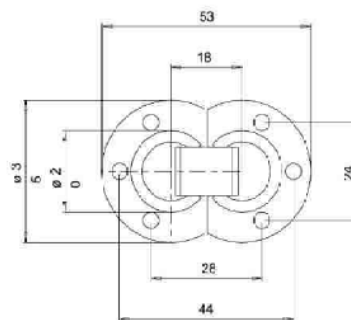
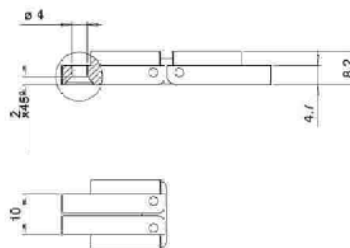

ART. 0510.00

Materiale: Zama / ferro

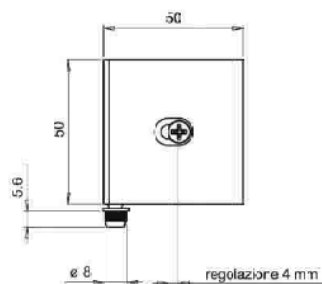
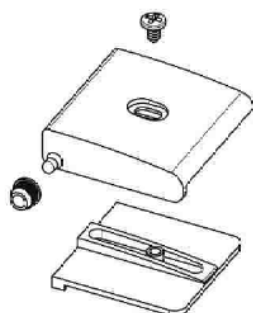
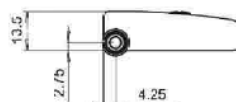

ART. 1374.00

Materiale: Zama / PA / ferro

CERNIERE PER TAVOLI E CRISTALLI

Table and Glass Hinges · Made in Italy

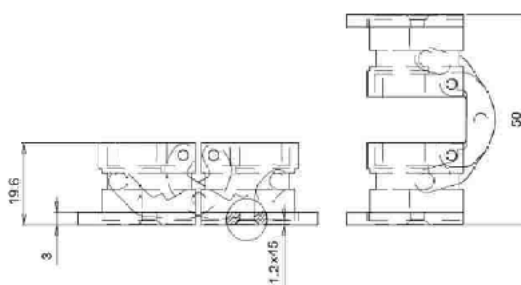
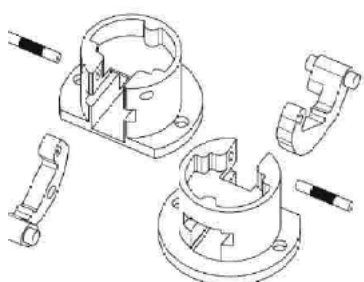
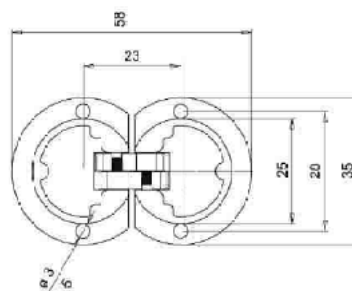

ART. 0511.00

Materiale: Zama / ferro

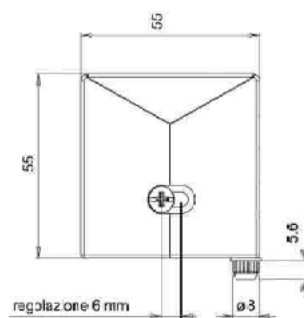
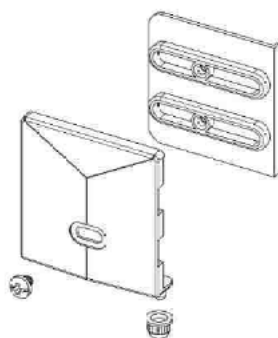
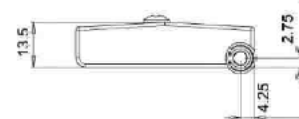

ART. 1382.00

Materiale: Zama / PA / ferro

CERNIERA PER CRISTALLI

Glass Hinges · Made in Italy

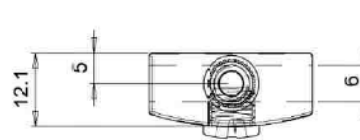
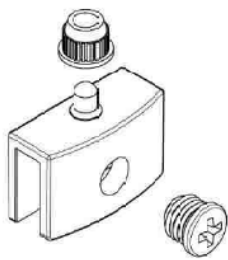
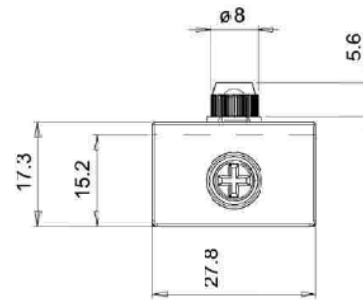

ART. 1448.00

Materiale: Zama / PA / ferro

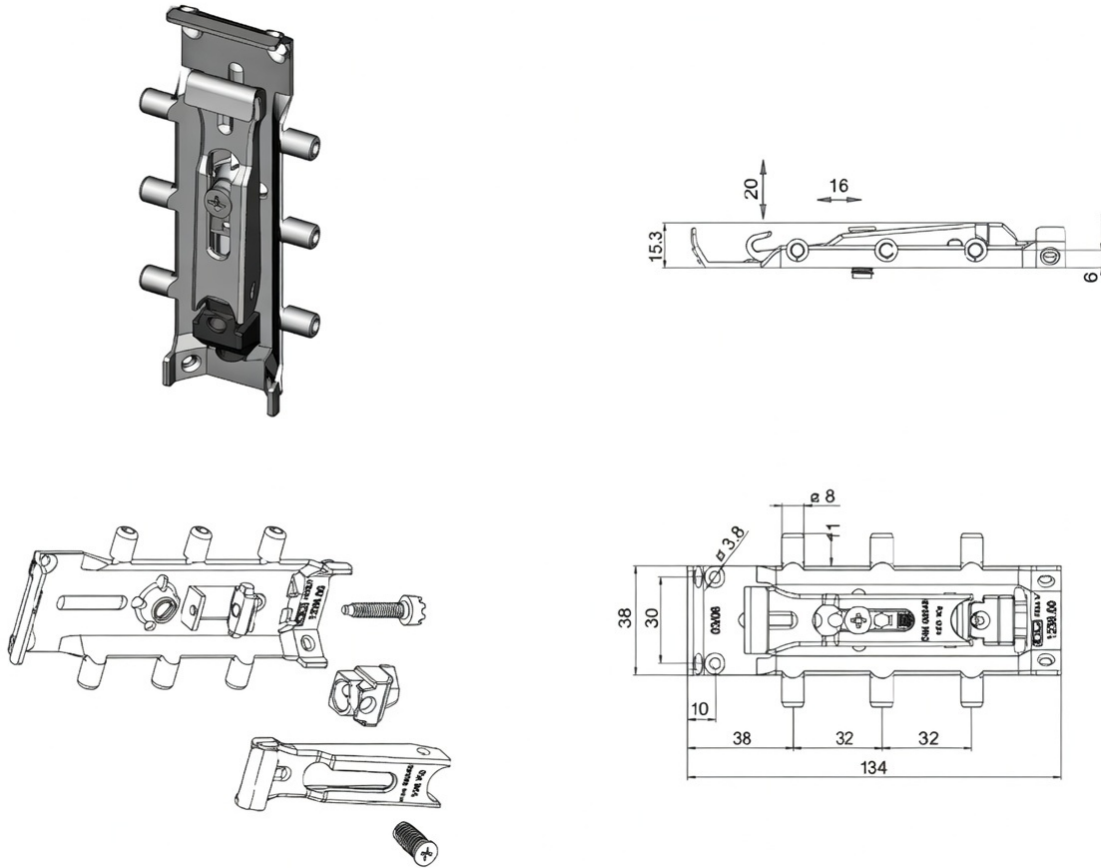

ART. 1239

Materiale: PA / Zama / ferro

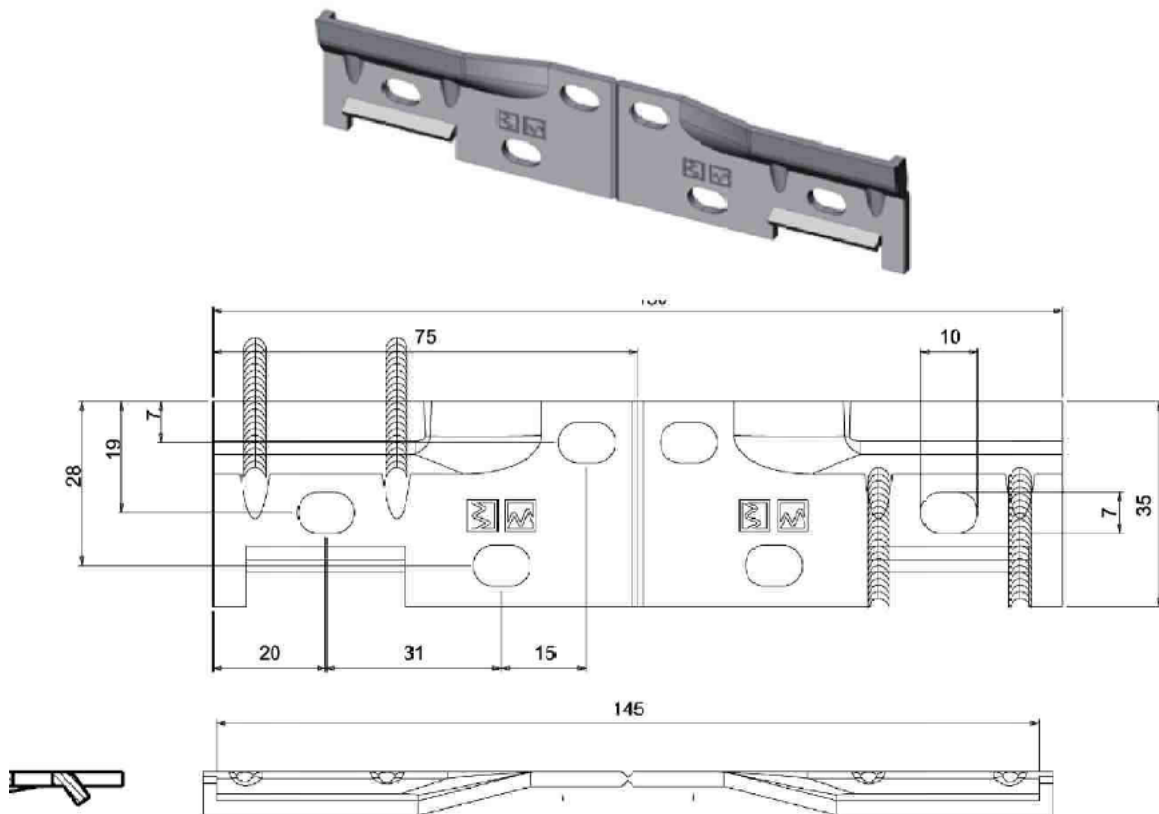

ART. 1260

Materiale: Ferro

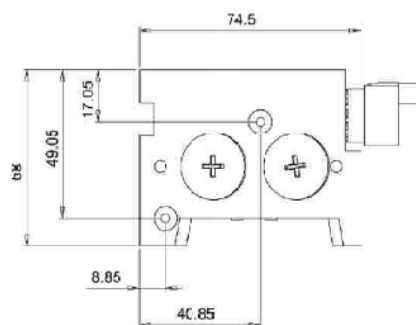
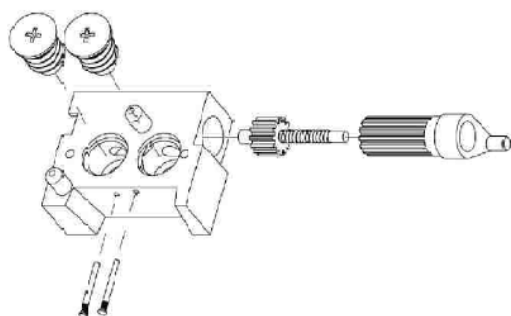
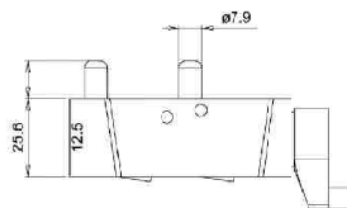

ART. 1359

Materiale: PA / Zama / ferro

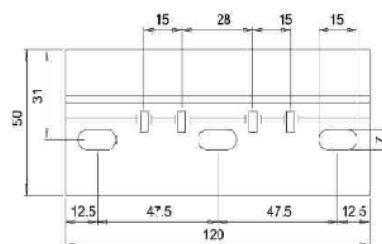
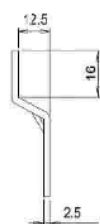
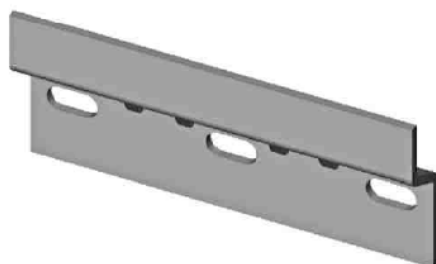

ART. 1350.03

Materiale: Ferro

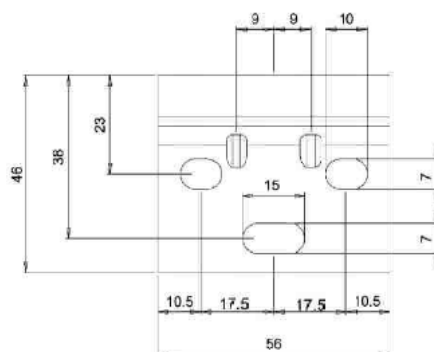
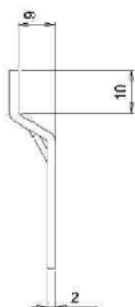
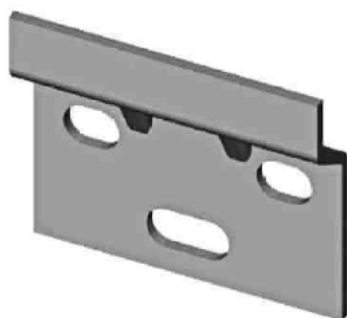

ART. 1350.00

Materiale: Ferro

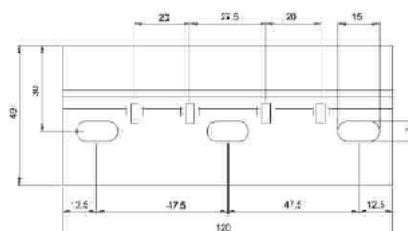
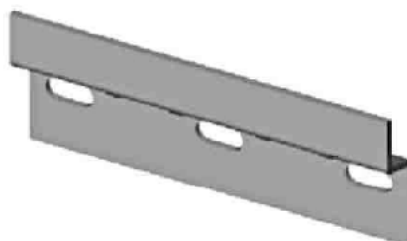

ART. 1350.02

Materiale: Ferro

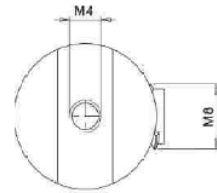
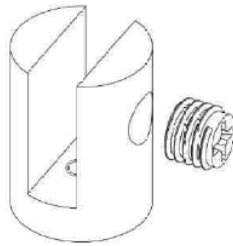
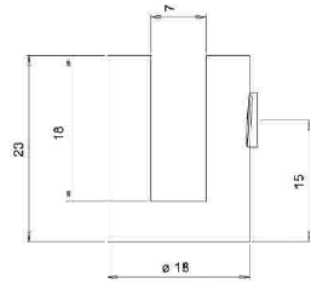

ART. 1438.00

Materiale: Zama

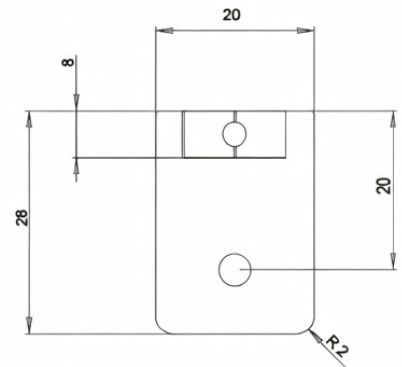
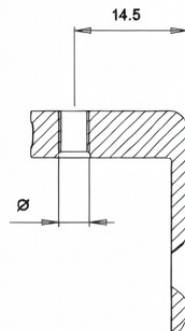
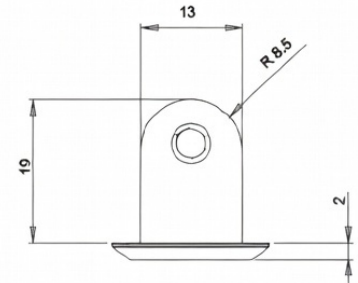

	Ø
1472.00	4.5
1472.01	M4

ART. 1472.00

Materiale: Zama

DISTANZIALI PER GUIDE

Guide Spacers · Made in Italy

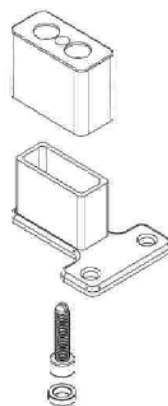
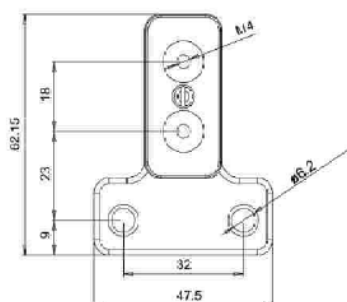
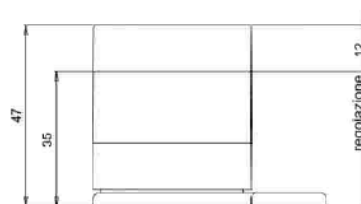

ART. 1413A.11

Materiale: Zama / Ferro / PA

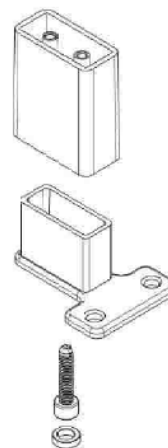
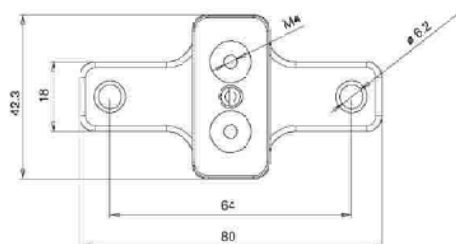
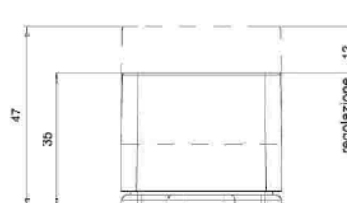
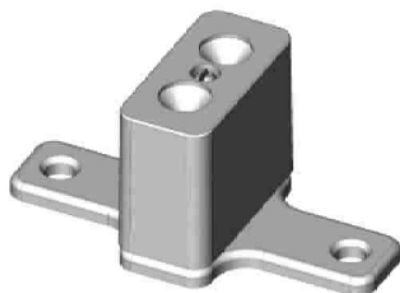

ART. 1414A.01

Materiale: Zama / Ferro / PA

DISTANZIALI PER GUIDE

Guide Spacers - Made in Italy

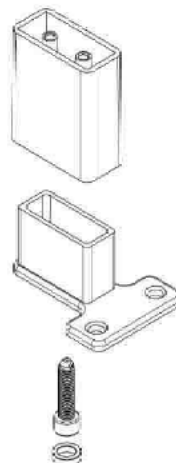
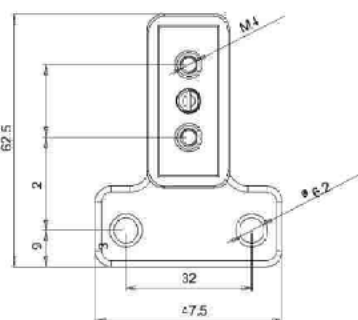
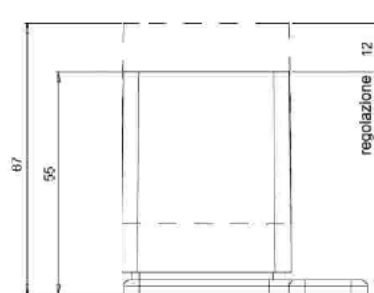

ART. 1413B.11

Materiale: Zama / Ferro / PA

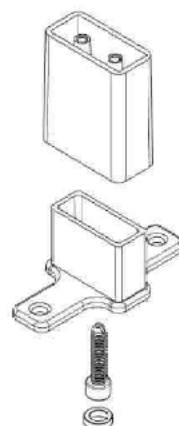
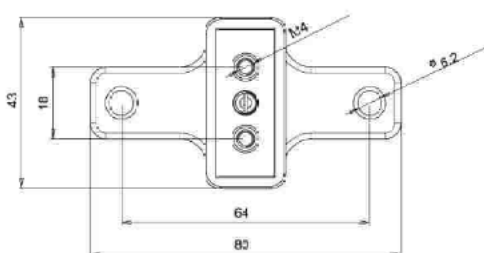
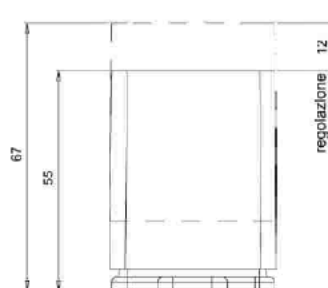
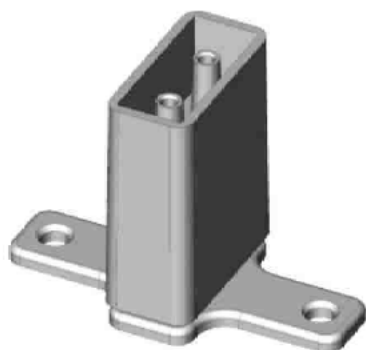

ART. 1414B.01

Materiale: Zama / Ferro / PA

DISTANZIALI PER GUIDE

Guide Spacers - Made in Italy

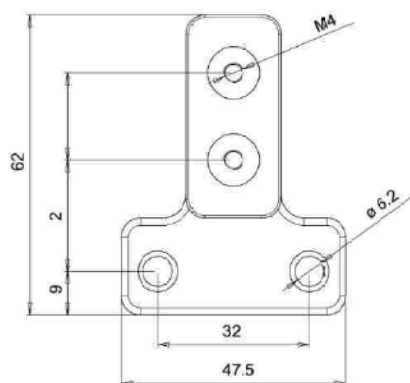
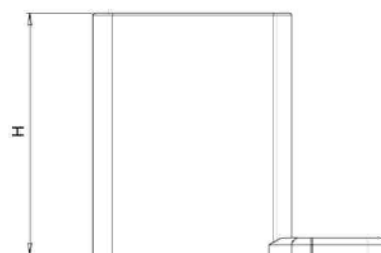
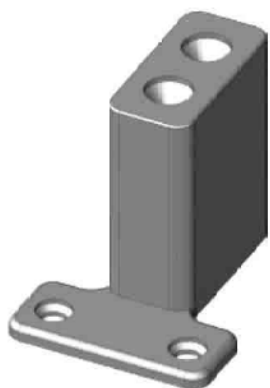

articolo	H
1415.00	28
1415.01	38
1415.02	50
1415.03	7
1415.04	60
1415.05	40.5

ART. 1415

Materiale: Zama / Ferro / PA

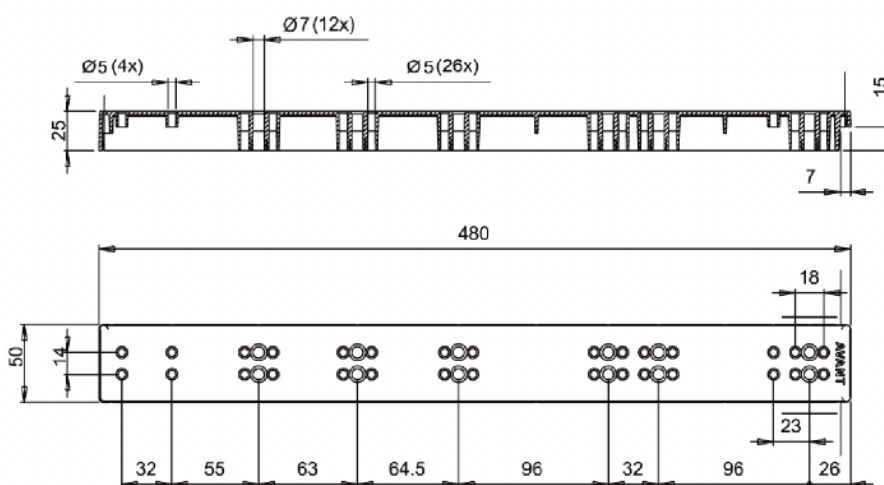
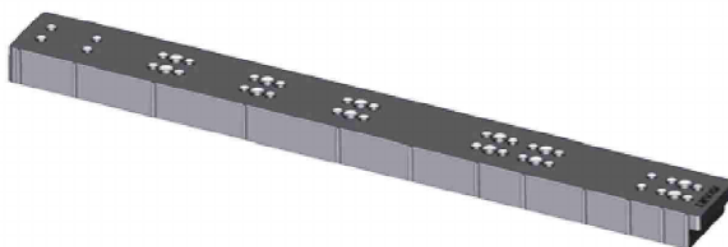

ART. 1481.00

Materiale: Zama / PS

DISTANZIALI PER GUIDE

Guide Spacers - Made in Italy

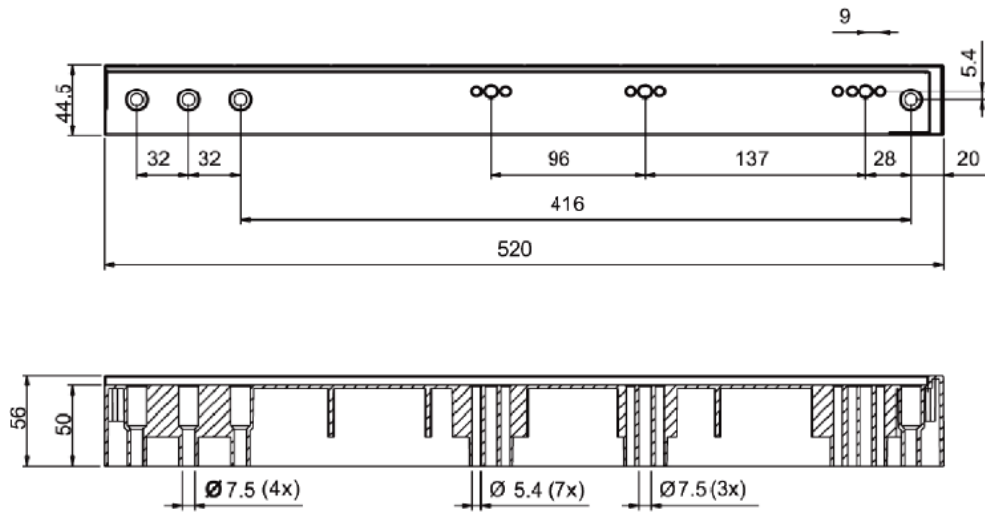
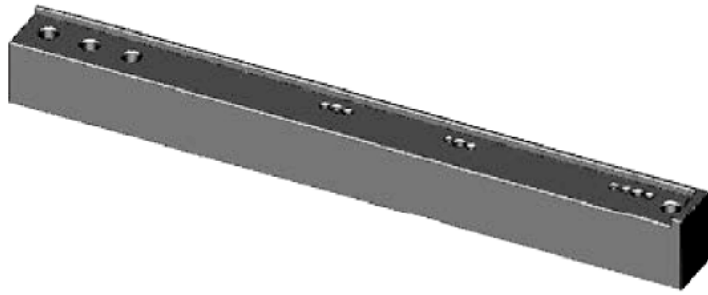

ART. 1469.00

Materiale: ABS

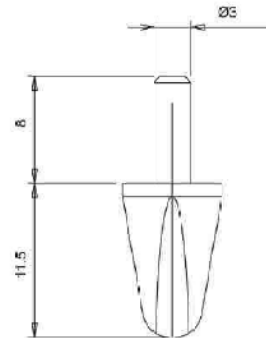
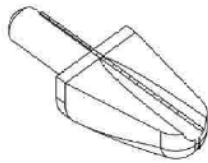
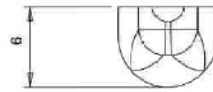

ART. 1257.00

Materiale: Zama

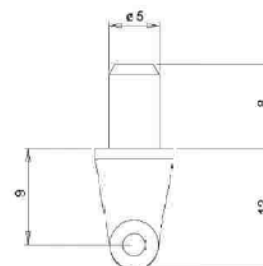
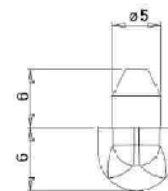

ART. 1395.00

Materiale: Zama

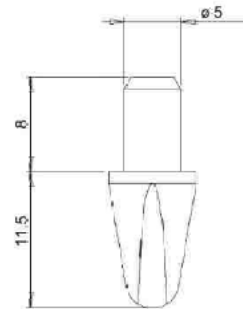

ART. 1393.00

Materiale: Zama

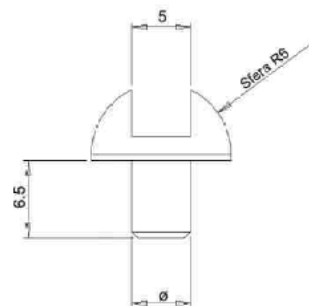

articolo	\varnothing
1399.00	5
1399.01	6

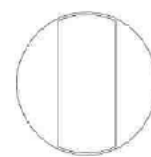

ART. 1399

Materiale: PMMA

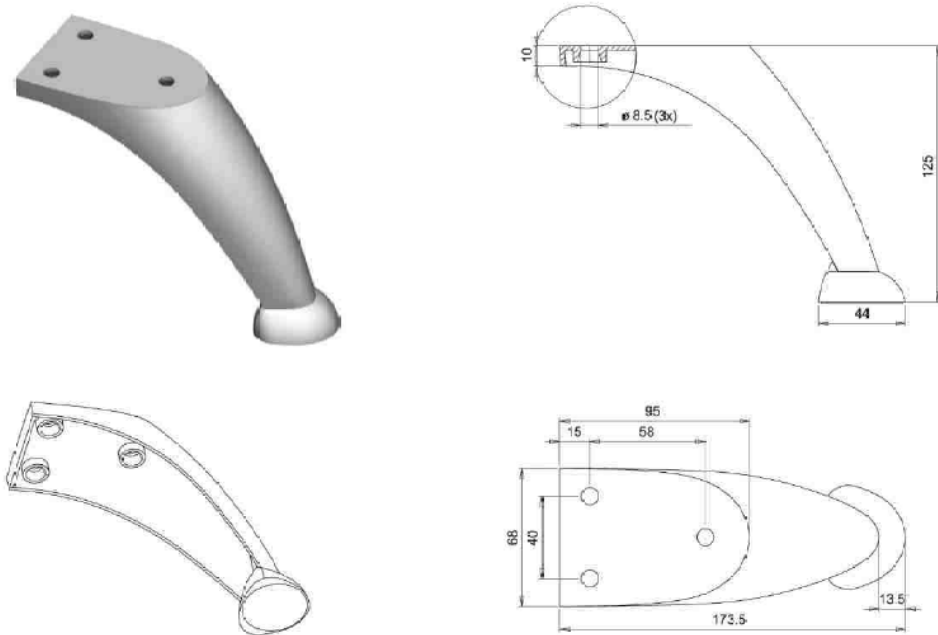

ART. 1207

Materiale: Zama

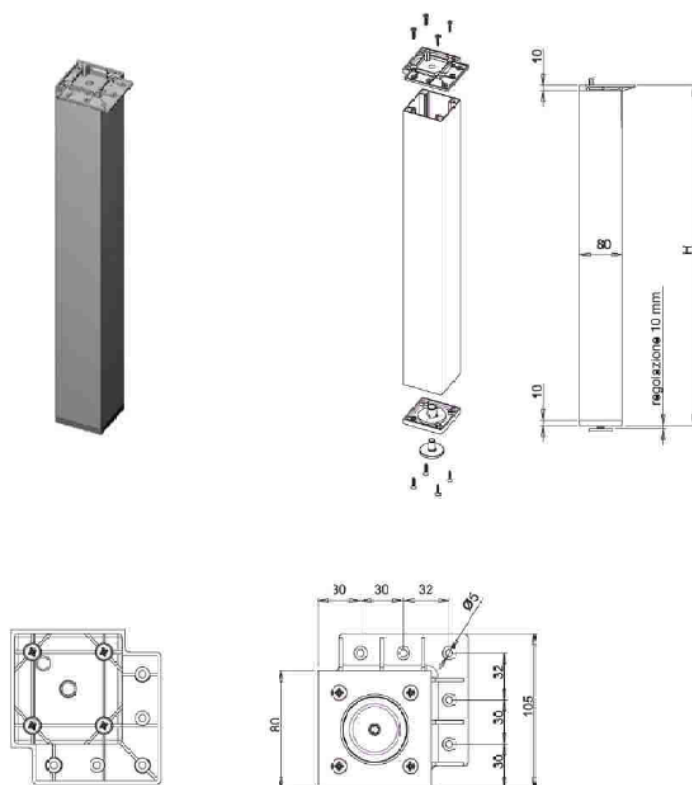

ART. 1245

Materiale: Zama / Alluminio / ferro

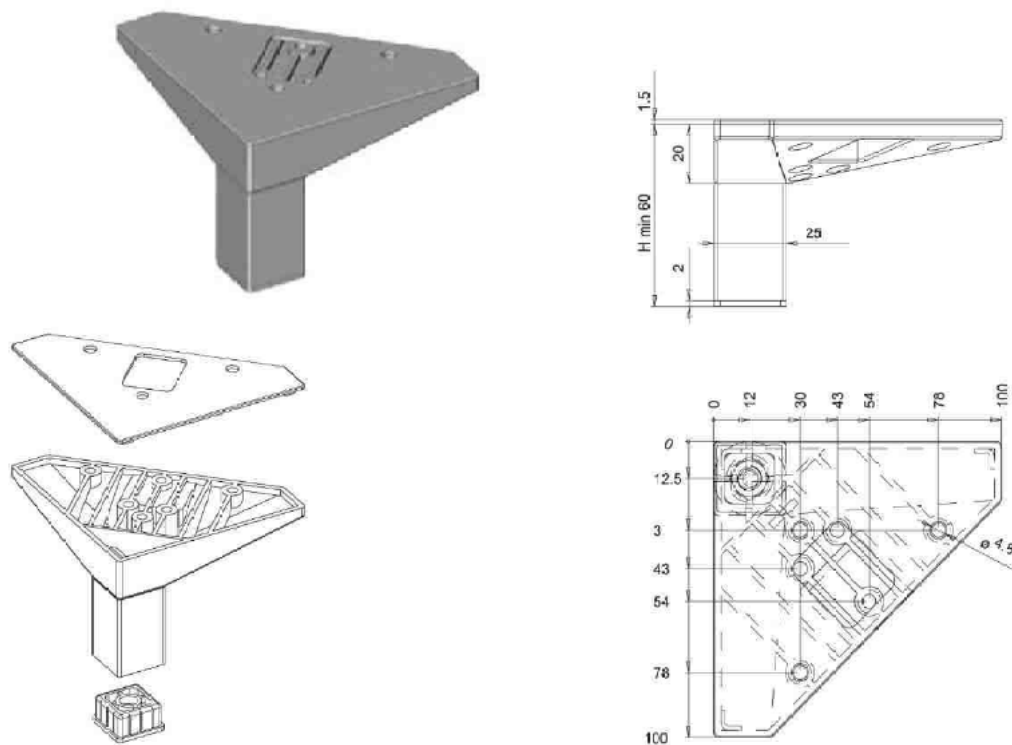

ART. 1240.00

Materiale: Ferro / ABS

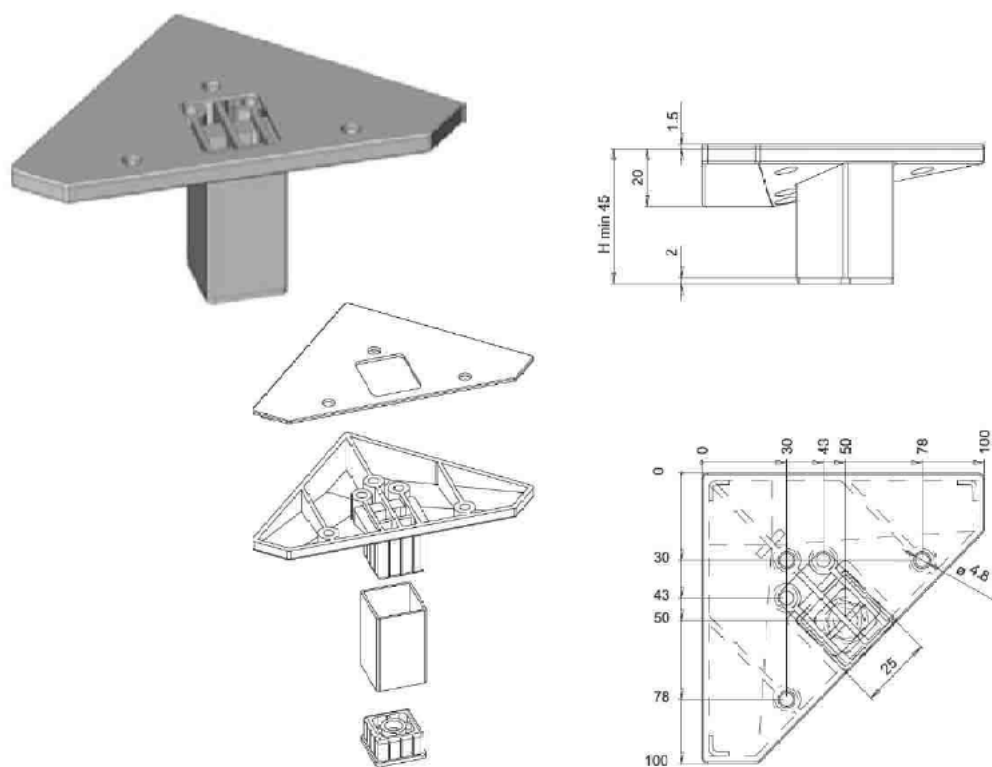

ART. 1252

Materiale: Ferro / ABS

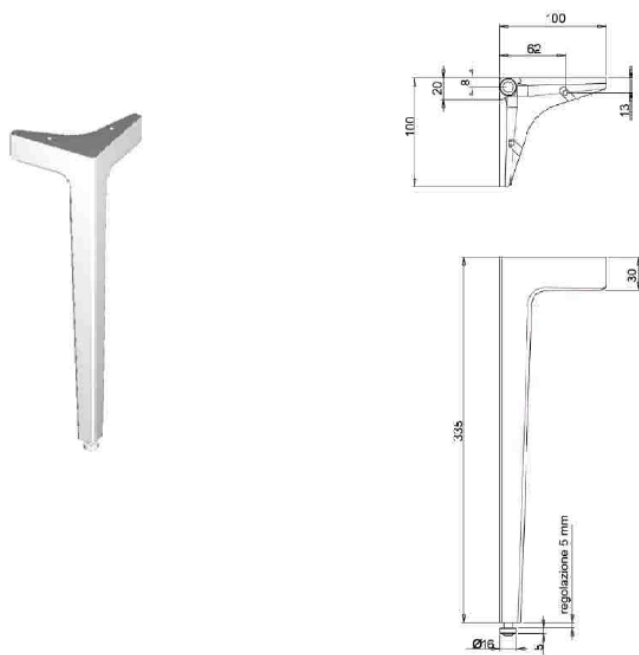

ART. 1458.00

Materiale: Zama / ferro

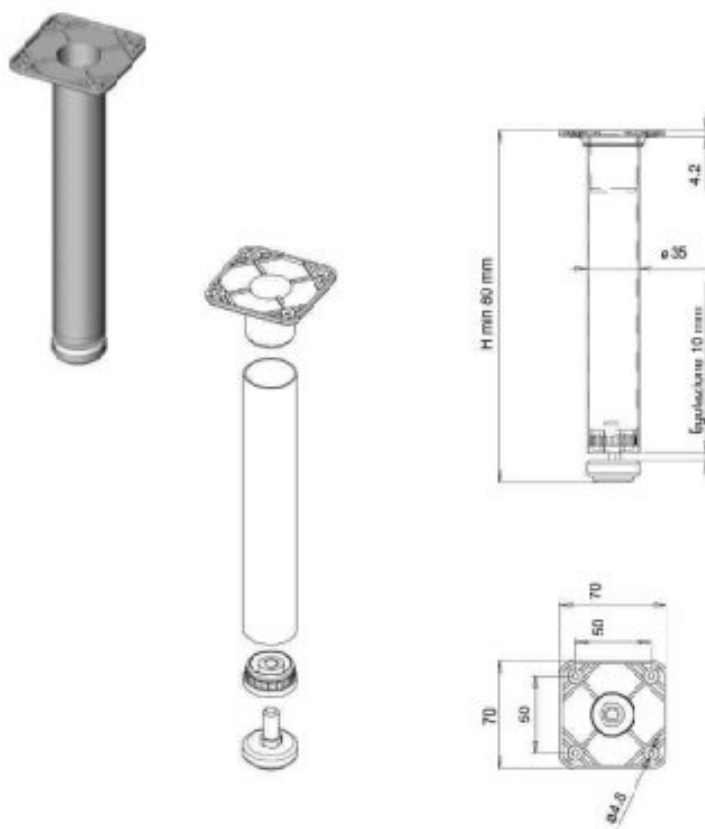

ART. 1576

Materiale: Ferro / Zama / PA

PIEDINI E GAMBE

Feet and Legs - Made in Italy

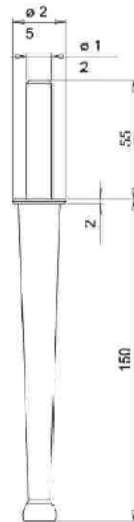

ART. 1465.00

Materiale: Zama / ferro

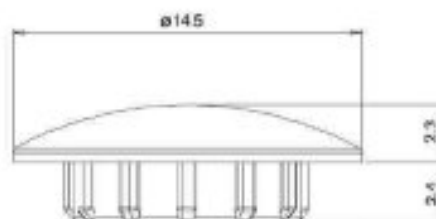
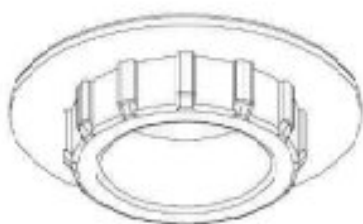
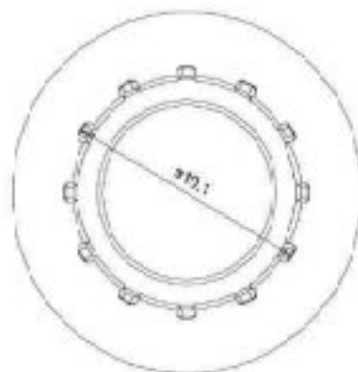

ART. 1244.00

Materiale: PA

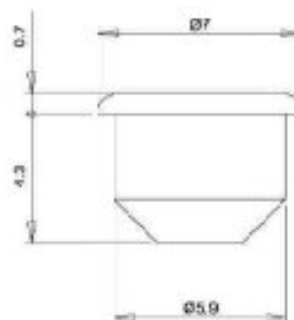

ART. 1297.00

Materiale: PA

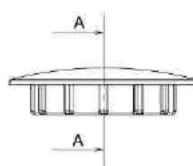
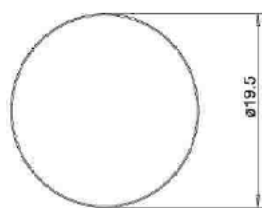
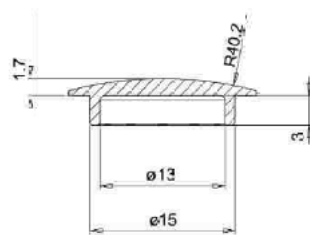

ART. 1261.00

Materiale: PA

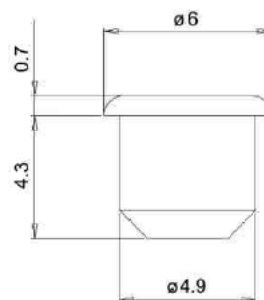
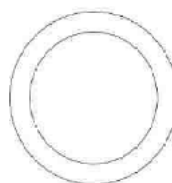

ART. 1301.00

Materiale: PA

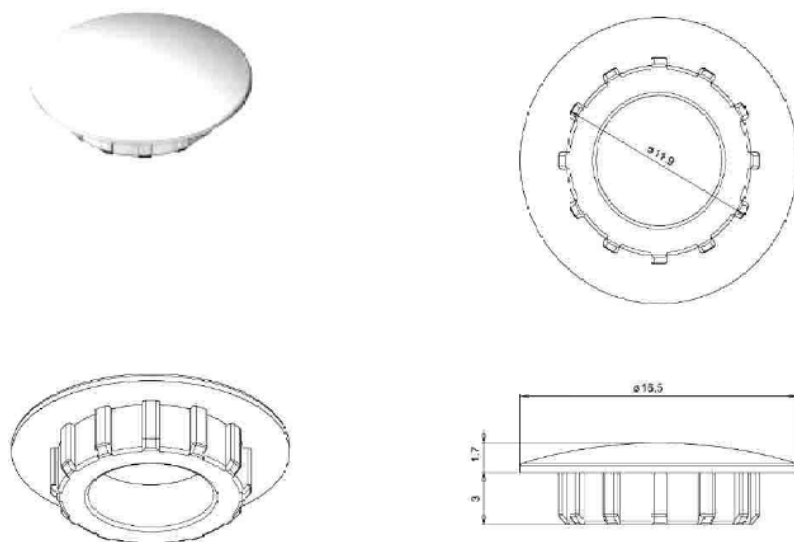

ART. 1302.00

Materiale: PA

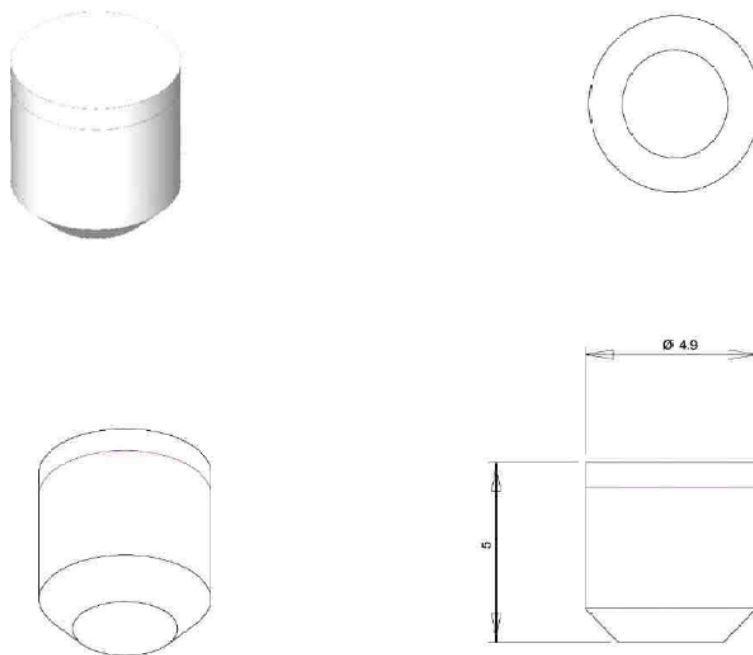

ART. 1492.00

Materiale: PA

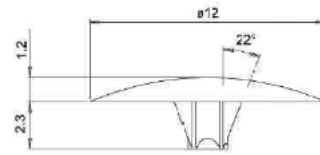
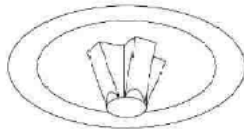
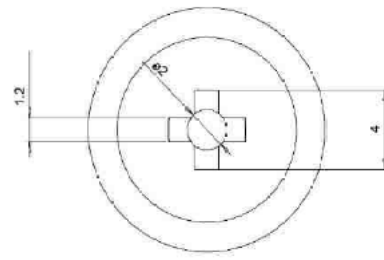
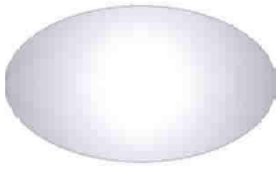

ART. 1304.00

Materiale: PA

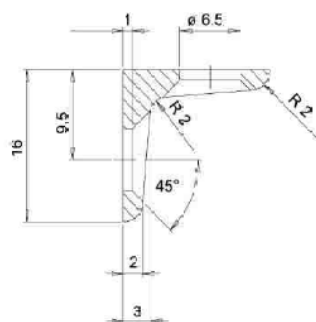
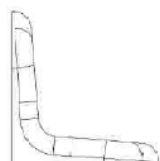
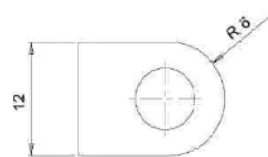

ART. 1368.00

Materiale: Zama

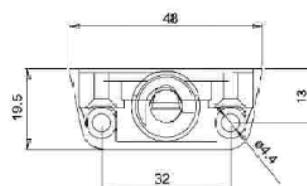
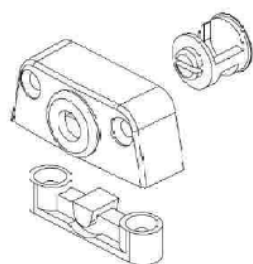
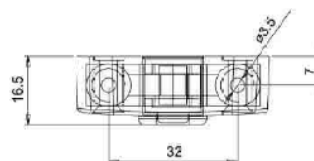
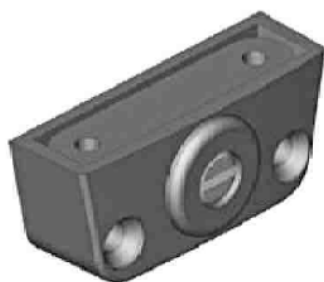

ART. 1416.01

Materiale: PA / Zama

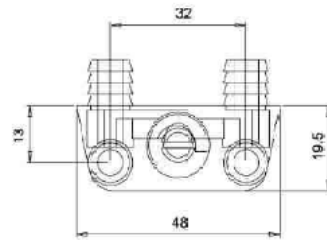
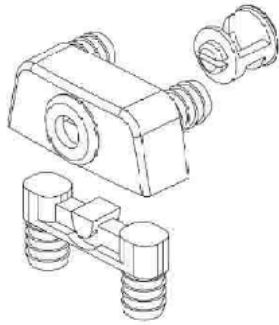
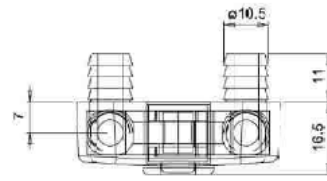

ART. 1416.00

Materiale: PA / Zama

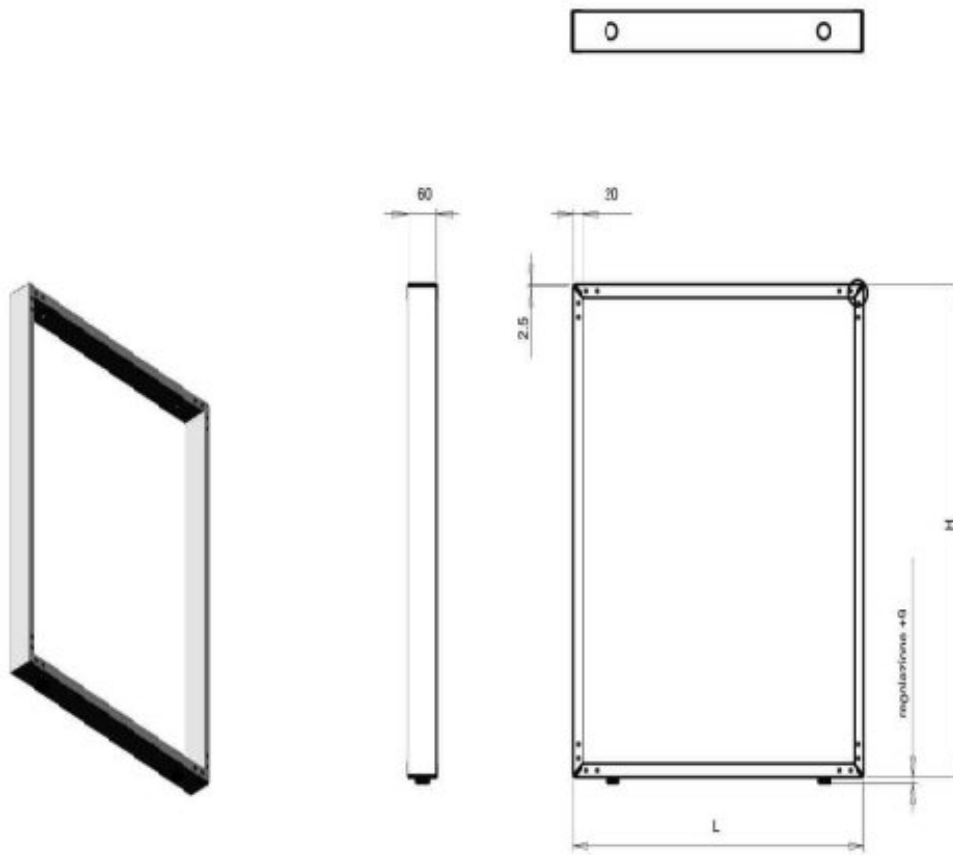

ART. 5001

Materiale: Alluminio / Zama / Ferro / PA



Rpg con spina						
articolo	A	B	D	C	E	F
1405.00	Ø9	Ø19	7	7	33	20
1405.01	Ø9	Ø24	7	9,5	33	30

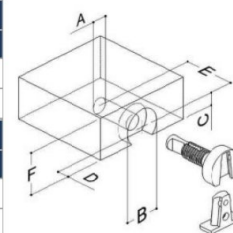

Rpg con cuneo						
articolo	A	B	D	C	E	F
1406.00	Ø9	Ø19	7	7	33	20
1406.01	Ø9	Ø21	7	7,5	31	25
1406.02	Ø9	Ø24	7	9,5	33	30



Squadrette con perno									
articolo	F	Ø perno			Rpg abbinabile				
		3	4	5	1405.00	1405.01	1406.00	1406.01	1406.02
1401.04	20		•		•				
1401.05	20			•	•				
1402.03	25	•						•	
1402.04	25		•					•	
1402.05	25			•				•	
1403.04	30		•			•			•
1403.05	30		•						•



Squadrette con foro									
articolo	F	Ø foro				Rpg abbinabile			
		M4	4	5	6	1405.00	1405.01	1406.00	1406.01
1401.00	20			•		•			
1401.01	20			•		•		•	
1401.02	20				•	•			
1402.00	25		•						•
1402.01	25			•					•
1402.02	25				•				•
1402.06	25	•							•
1408.00	25			•					•
1408.01	25			•					•
1407.01	25		•						•
1407.02	25			•					•

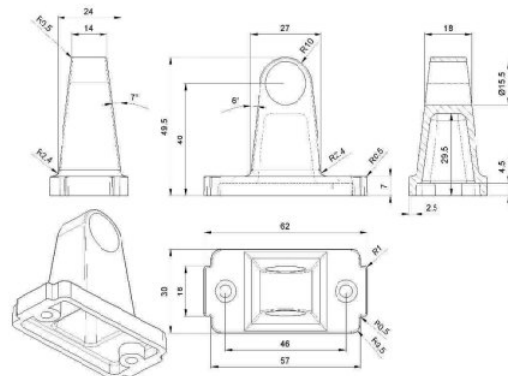
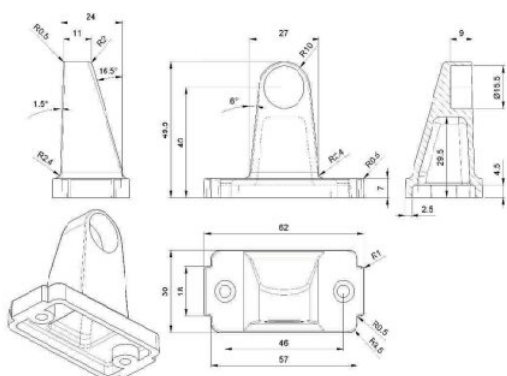
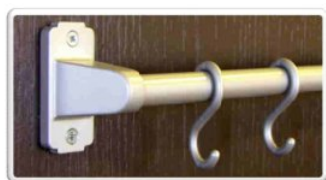

ART. 3012

Materiale: Zama / ferro

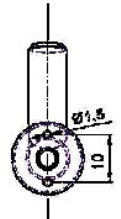
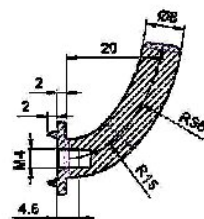
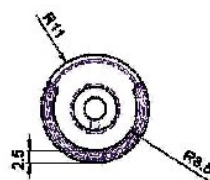
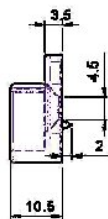
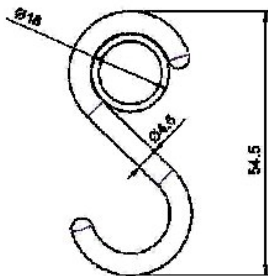

ART. 3009

Materiale: Zama / ferro

© Falchit - Tutti i diritti riservati

All rights reserved

Le immagini e i dati tecnici contenuti in questo catalogo sono forniti a titolo indicativo. Falchit si riserva il diritto di apportare modifiche a prodotti, misure e finiture senza preavviso.

The images and technical data contained in this catalogue are provided for indicative purposes only. Falchit reserves the right to modify products, dimensions and finishes without prior notice.

La riproduzione totale o parziale di questo catalogo, in qualsiasi forma, è vietata senza autorizzazione scritta.

Total or partial reproduction of this catalogue in any form is prohibited without written authorisation.

