



---

Ferramenta per Mobili · Made in Italy · Dal 1914

# INDICE

---

**CRICCHETTI E CHIUSURE PER MOBILI ..... 2**

*Catch for Furniture · Made in Italy*

---

**CERNIERE PROFILATE IN OTTONE ..... 6**

*Profiled Brass Hinges · Made in Italy*

---

**FERRAMENTA ..... 16**

*Ironmongery · Accessories for Furniture · Made in Italy*

---

**MANIGLIE ..... 21**

*Furniture Handles · Made in Italy*

---

**POMOLI ..... 142**

*Furniture Knobs · Made in Italy*

---

**ARTICOLI TECNICI ..... 173**

*Technical Items · Made in Italy*

---



# FINITURE

## Finishing

Le finiture si riferiscono alle seguenti categorie: **Cricchetti e chiusure per mobili** · **Cerniere profilate in ottone** · **Ferramenta**

Finishes apply to: *Catches for Furniture* · *Profiled Brass Hinges* · *Ironmongery*

<p><b>1</b> <b>Satinato</b> <i>Satin brass</i></p> <p><b>3</b> <b>Nichelato satinato</b> <i>Nikel satin</i></p> <p><b>5</b> <b>Nichelato brillantato</b> <i>Bright nikel</i></p> <p><b>7</b> <b>Cromato</b> <i>Chrome</i></p> <p><b>9</b> <b>Brillantato</b> <i>Bright</i></p> <p><b>11</b> <b>Ottonato verniciato</b> <i>Brassed lacquered</i></p> <p><b>13</b> <b>Nichelato - Plastica marrone</b> <i>Nikel - Brown plastic</i></p> <p><b>15</b> <b>Zincato nero - Plastica nera</b> <i>Zinc black - Black plastic</i></p> <p><b>17</b> <b>Nichelato</b> <i>Nikel</i></p>	<p><b>2</b> <b>Lucido</b> <i>Polished</i></p> <p><b>4</b> <b>Nichelato lucido</b> <i>Polished nikel</i></p> <p><b>6</b> <b>Bronzato verniciato</b> <i>Bronze lacquered</i></p> <p><b>8</b> <b>Smerigliato</b> <i>Brushed</i></p> <p><b>10</b> <b>Zincato</b> <i>Zinc plated</i></p> <p><b>12</b> <b>Nichelato - Plastica bianca</b> <i>Nikel - White plastic</i></p> <p><b>14</b> <b>Nichelato - Plastica nera</b> <i>Nikel - Black plastic</i></p> <p><b>16</b> <b>Bronzato verniciato</b> <i>Bronze lacquered</i></p> <p><b>18</b> <b>Cromato</b> <i>Chrome</i></p>
---	---

---

# CRICCHETTI E CHIUSURE PER MOBILI

Catch for Furniture · Made in Italy

---

BORSANI



**ART. 188 INOX — Mini Latch in acciaio inox AISI 304**

*ART. 188 INOX — Mini Latch · Stainless Steel AISI 304*

MATERIALE	FINITURA	CONF.
Acciaio INOX AISI 304	INOX naturale	50 – 1000 pz

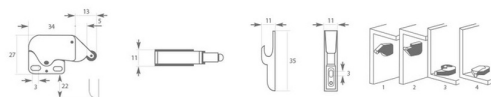

**ART. 188 — Mini Latch**

*ART. 188 — Mini Latch · Push to open / close*

MATERIALE	FINITURA	CONF.
Ferro e Acciaio	11-12-13-14-15	50 – 1000 pz





**ART. 188 — Mini Latch All Metal**

*ART. 188 — Mini Latch All Metal · Push to open / close*

MATERIALE	FINITURA	CONF.
Ferro e Acciaio	11-12-13-14-15	50 – 1000 pz

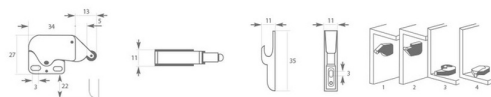

**ART. 188 — Fermo Mini Latch**

*ART. 188 — Counterpiece Mini Latch · Push to open / close*

MATERIALE	FINITURA	CONF.
Zama	10	50 – 400 pz

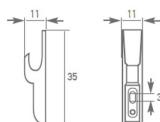



**ART. 180 — Chiusura a scatto con fermo di nylon**

*ART. 180 — Push-to-open catch · nylon strike*

MATERIALE	FINITURA	CONF.
Ferro	10 · 11 · 16	50 – 200 pz

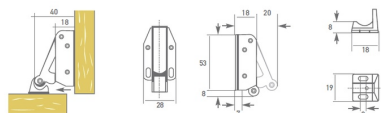

**ART. 314 EASY-ON — Cerniera a doppia spinta senza incasso**

*ART. 314 EASY-ON — No mortise hinge double acting full concealed*

MISURA	FINITURA	CONF.
Standard	10	20 pz

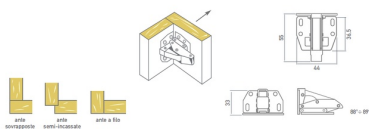

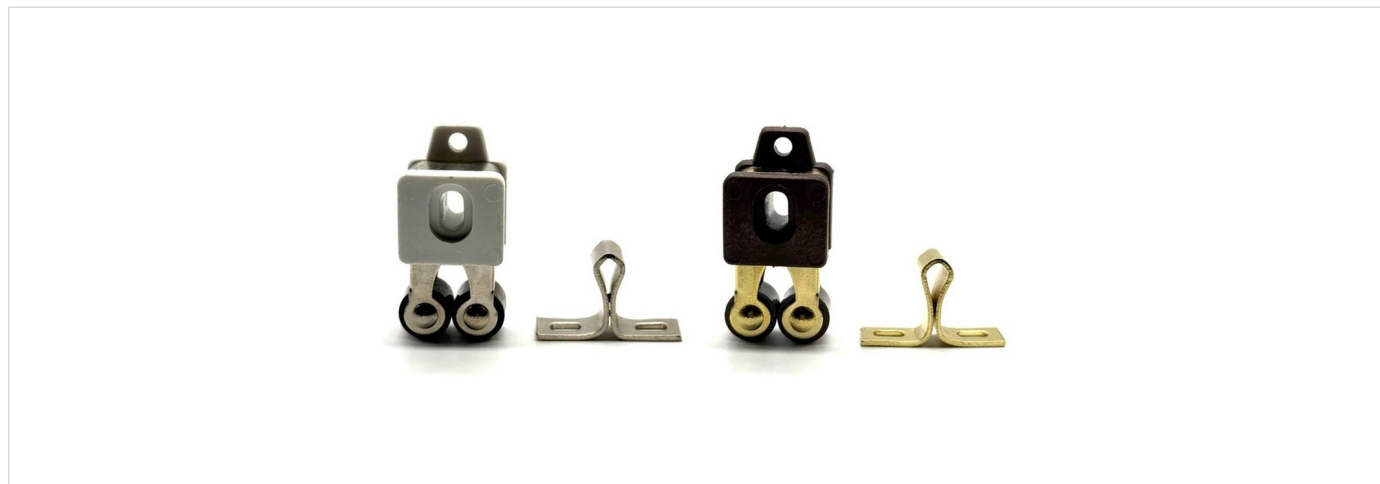

**ART. 190 — Cricchetto con fermo di nylon**

*ART. 190 — Catch noiseless · Strike nylon*

MATERIALE	FINITURA	CONF.
Acciaio temperato	16 · 17	100 pz



**ART. 195 — Cricchetto silenzioso a due rulli**

*ART. 195 — Double roller catch*

MATERIALE	FINITURA	CONF.
Acciaio	11 · 17	100 pz

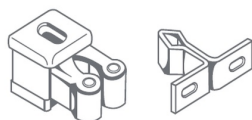

---

# CERNIERE PROFILATE IN OTTONE

Profiled Brass Hinges · Made in Italy

---

BORSANI

# CERNIERE PROFILATE IN OTTONE

Profiled Brass Hinges · Made in Italy

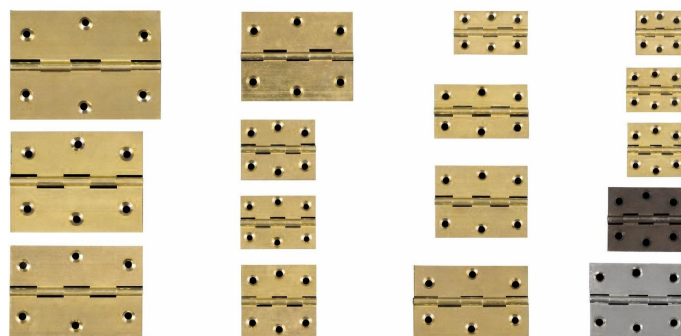

ART. 2000 - Cerniera diritta brillantata

## ART. 2000 — Cerniera diritta brillantata

ART. 2000 — Plain bright hinge

MISURA (HxL)	SPESSORE	NODO	FINITURA	CONF.
25x25 mm	1,5/1,2	4 mm	5 · 6 · 9	24 pz
30x25 mm	1,5/1,2	4 mm	5 · 6 · 9	24 pz
40x30 mm	1,5/1,2	4 mm	5 · 6 · 9	24 pz
50x40 mm	1,5/1,2	4 mm	5 · 6 · 9	24 pz
60x40 mm	1,8/1,4	4,5 mm	5 · 6 · 9	24 pz
70x55 mm	2/1,5	5 mm	5 · 6 · 9	24 pz
80x60 mm	2/1,5	5 mm	5 · 6 · 9	24 pz

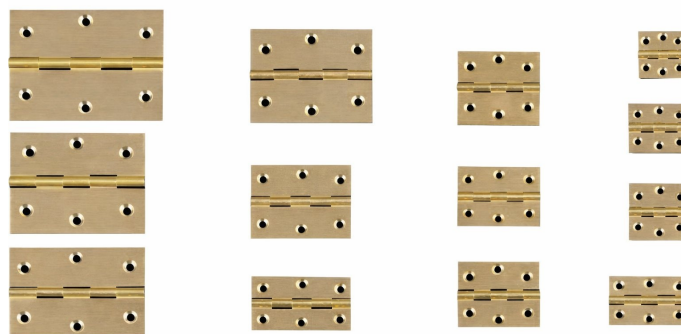

ART. 300 L - Cerniera 300L diritta smerigliata

## ART. 300L — Cerniera diritta smerigliata

ART. 300L — Plain brushed hinge

MISURA (HxL)	SPESSORE	NODO	FINITURA	CONF.
25x25 mm	1,5/1,2	4 mm	3 · 6 · 7 · 8	24 pz
30x25 mm	1,5/1,2	4 mm	3 · 6 · 7 · 8	24 pz
40x30 mm	1,5/1,2	4 mm	3 · 6 · 7 · 8	24 pz
50x40 mm	1,5/1,2	4 mm	3 · 6 · 7 · 8	24 pz
60x40 mm	1,8/1,4	4,5 mm	3 · 6 · 7 · 8	24 pz
70x55 mm	2/1,5	5 mm	3 · 6 · 7 · 8	24 pz
80x60 mm	2/1,5	5 mm	3 · 6 · 7 · 8	24 pz



## CERNIERE PROFILATE IN OTTONE

Profiled Brass Hinges · Made in Italy



ART. 303S - Cerniera a biscotto

### ART. 303 — Cerniera per tavoli a biscotto

ART. 303 — Table Hinge · Plain swaged

MISURA (HxL)	SPESSORE	NODO	FINITURA	CONF.
30x80 mm	2 mm	6 mm	1-2-3-4-5-6-9	24 – 50 pz

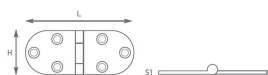

ART. 303 - Cerniera per tavoli a biscotto

### ART. 303S — Cerniera a biscotto (perno in ottone)

ART. 303S — Table Hinge · Brass pin

MISURA (HxL)	SPESSORE	NODO	FINITURA	CONF.
20x63 mm	2 mm	6 mm	1-2-3-4-6	24 – 50 pz

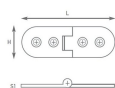



ART. 304 (30x54) - Cerniera a biscotto

## ART. 304 — Cerniera a biscotto

ART. 304 — Table Hinge · Plain swaged

MISURA (HxL)	SPESSORE	FINITURA	CONF.
30x54 mm	2 mm	1-2-3-4-6-7-8	24-500 pz
30x65 mm	2 mm	1-2-3-4-6-7-8	24-500 pz
30x72 mm	2 mm	1-2-3-4-6-7-8	24-500 pz
30x80 mm	2 mm	1-2-3-4-6-7-8	24-500 pz



## ART. 304 (30x54) — Cerniera a biscotto piatta

ART. 304 (30x54) — Table Hinge · Plain swaged

MISURA (HxL)	SPESSORE	FINITURA	CONF.
30x54 mm	2 mm	1-2-3-4-6-7-8	24-500 pz

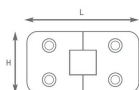



ART. 301 - Curva smerigliata - ART. 2001 - Curva brillantata

## ART. 301 / 2001 — Curva smerigliata / brillantata

ART. 301 — Curva brushed · ART. 2001 — Curva bright

MISURA (HxL)	SPESSORE	NODO	FINITURA	CONF.
40x40 mm	1,8/1,4	4,5 mm	301: 3-6-7-8 / 2001: 5-6-9	24 pz
50x40 mm	1,8/1,4	4,5 mm	301: 3-6-7-8 / 2001: 5-6-9	24 pz
60x50 mm	2/1,5	5 mm	301: 3-6-7-8 / 2001: 5-6-9	24 pz



ART. 305 - Curva D-smerigliata - ART. 2002 - Curva D-brillantata

## ART. 305 / 2002 — Curva D smerigliata / brillantata

ART. 305 — Curva D-brushed · ART. 2002 — Curva D-bright

MISURA (HxL)	SPESSORE	NODO	FINITURA	CONF.
40x40 mm	1,8/1,4	4,5 mm	305: 3-6-7-8 / 2002: 5-6-9	24 pz
50x40 mm	1,8/1,4	4,5 mm	305: 3-6-7-8 / 2002: 5-6-9	24 pz
60x50 mm	2/1,5	5 mm	305: 3-6-7-8 / 2002: 5-6-9	24 pz





## ART. 313 — Cerniera a molla (angoli arrotondati su richiesta)

ART. 313 — Self supporting spring hinge

MISURA (HxL)	SPESSORE	FINITURA	CONF.
38x63 mm	2,2 / 2,4 mm	1 - 6	50 pz



ART. 322 - Cerniera a sfilare con angoli arrotondati

## ART. 322 — Cerniera a sfilare con angoli arrotondati

ART. 322 — Lift off hinge with round corners

MISURA (HxL)	SPESSORE	NODO	FINITURA	CONF.
40x40 mm	2 mm	8 mm	1-2-3-4-6	20 pz
50x40 mm	2 mm	8 mm	1-2-3-4-6	20 pz
60x40 mm	2 mm	8 mm	1-2-3-4-6	20 pz

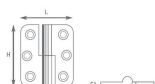

## CERNIERE PROFILATE IN OTTONE

Profiled Brass Hinges · Made in Italy



### ART. 318/20 — Cerniera ad angolo a sfilare per ante sovrapposte

ART. 318/20 — Angle hinge for edge fixing to door and frame

MISURA (HxL)	NODO	FINITURA	CONF.
50x20-21 mm	8 mm	1-2-3-4-6-7	20 pz

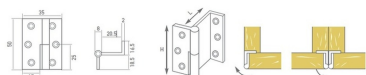

ART. 187 - perno in ottone per piani ribaltabili

### ART. 187 — Perno in ottone per piani ribaltabili

ART. 187 — Brass card table hinge (side fixing rule joint)

MISURA (HxL)	NODO	FINITURA	CONF.
15x132 mm	—	2 · 5	20 pz

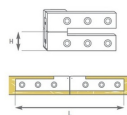

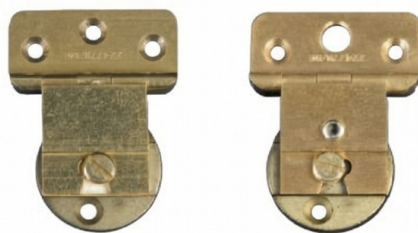

ART. 321 - Cerniera con curva regolabile, basetta tonda  $\varnothing$  30mm  
 ART. 321/2R - Cerniera con curva a due regolazioni, basetta tonda  $\varnothing$  30mm

## ART. 320 — Cerniere regolabili in ottone

ART. 320 — Curva adjustable hinge

MISURA (HxL)	NODO	FINITURA	CONF.
40x40 mm	—	8	24 pz

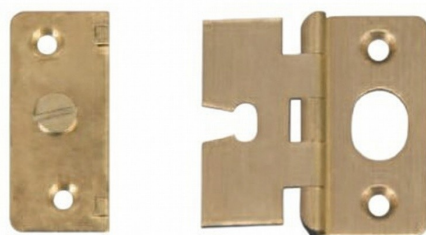
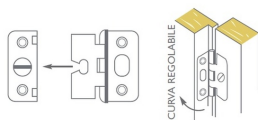

## ART. 321 / 321-2R — Cerniera con curva regolabile $\varnothing$ 30 mm

ART. 321 — Adjustable hinge · round plate  $\varnothing$  30mm

ARTICOLO	MISURA (HxL)	FINITURA	CONF.
ART. 321	40x40 mm	8	24 pz
ART. 321/2R	40x40 mm	1-3-5-6-9	50 pz

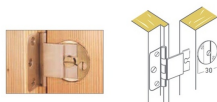

## CERNIERE PROFILATE IN OTTONE

Profiled Brass Hinges · Made in Italy



### ART. 1000 — Cerniera a vista per ante a filo

ART. 1000 — Special hinge full surface no mortise for insert doors

MISURA (HxL)	NODO	FINITURA	CONF.
28x40 mm	—	1 · 3 · 6	40 pz



ART. 1000 - Cerniera a vista per ante a filo

### ART. 1001 — Cerniera a vista per cristalli

ART. 1001 — Glass door hinge

MISURA (HxL)	NODO	FINITURA	CONF.
28x40 mm	—	1 · 3 · 6	40 pz

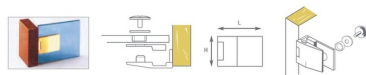

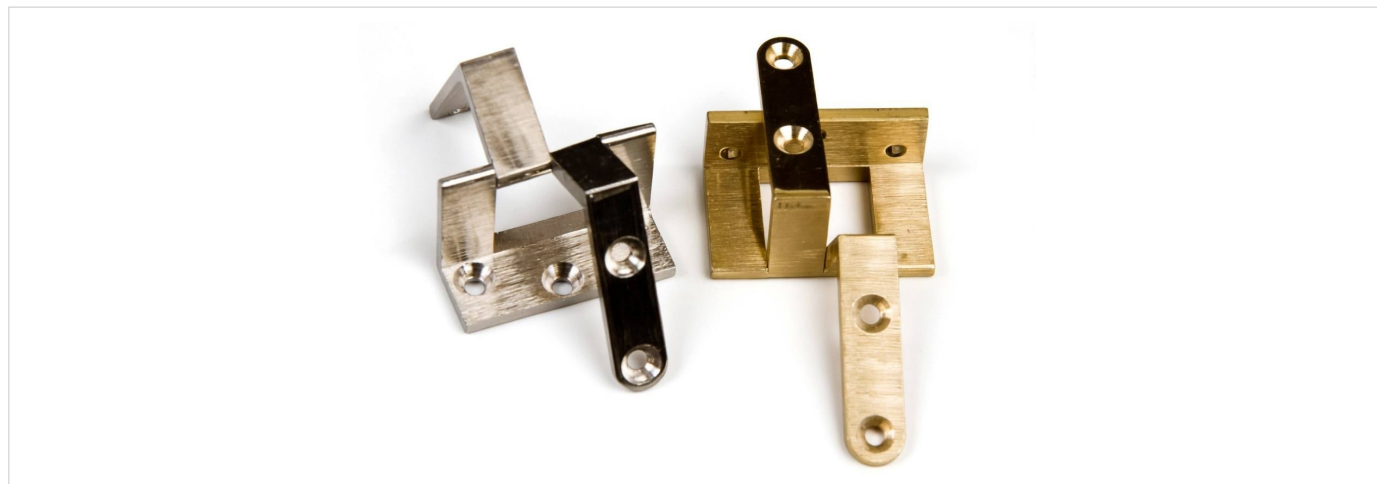

## ART. 315/20 — ART. 315/16 — Cerniera semplice

ART. 315/20 — ART. 315/16 — One leaf hinge

ARTICOLO	MISURA (HxL)	FINITURA	CONF.
ART. 315/20	40x20 mm	1-2-3-4-6-7	20 pz
ART. 315/16	40x16 mm	1-2-3-4-6-7	20 pz



## ART. 315/20 — Cerniera doppia

ART. 315/20 — Two leaves hinge

MISURA (HxL)	NODO	FINITURA	CONF.
40x40 mm	—	1-2-3-4-6-7	20 pz

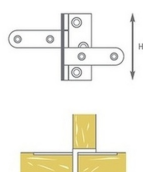

---

# FERRAMENTA

Ironmongery · Accessories for Furniture · Made in Italy

---

BORSANI



**ART. 308 — Catenaccio in ottone profilato con fermo**

*ART. 308 — Profiled brass bolt with strike*

MISURA	FINITURA	CONF.
mm 50	2 · 4	20 pz
mm 60	2 · 4	20 pz
mm 70	2 · 4	20 pz
mm 80	2 · 4	20 pz
mm 90	2 · 4	20 pz
mm 100	2 · 4	20 pz

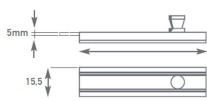

**ART. 310 — Catenaccio in ottone automatico con fermo**

*ART. 310 — Self closing bolt solid brass with strike*

MISURA (HxL)	FINITURA	CONF.
27x70 mm	2 · 4	20 pz

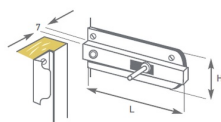



**ART. 169 — Asta snodata curva in ottone**

*ART. 169 — Sliding brass arm (curved)*

MISURA	FINITURA	CONF.
cm 12	5 - 9	20 pz
cm 18	5 - 9	20 pz

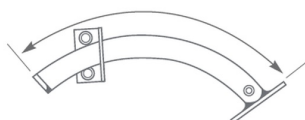

**ART. 175 - Asta snodata diritta in ottone**

**ART. 175 — Asta snodata diritta in ottone**

*ART. 175 — Lid brass stay with retainer*

MISURA	FINITURA	CONF.
cm 12	5 - 9	20 pz
cm 15	5 - 9	20 pz
cm 20	5 - 9	20 pz
cm 25	5 - 9	20 pz
cm 30	5 - 9	20 pz
cm 40	5 - 9	20 pz

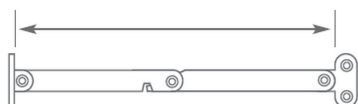

---

# MANIGLIE

Handles · Made in Italy

---

BORSANI



**ART. 1911**

ART. 1911 · Made in Italy

L (mm)	C (mm)	H (mm)	Ø (mm)	materiale	codice
138	128	30	125	zama	1911.00
237	224	30	200	zama	1911.05

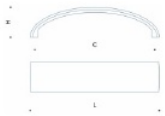

**ART. 1932**

ART. 1932 · Made in Italy

L (mm)	C (mm)	H (mm)	Ø (mm)	materiale	codice
288	256	28	150	zama	1932.07
233	192	28	127	zama	1932.04
105	64	28	80	zama	1932.02

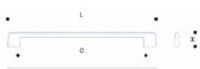



**ART. 1933**

*ART. 1933 · Made in Italy*

L (mm)	C (mm)	H (mm)	Ø (mm)	materiale	codice
337,5	320	30	156	zama	1933.08
210	192	28.5	115	zama	1933.04
113.5	96	26.5	76	zama	1933.02



**ART. 1939**

*ART. 1939 · Made in Italy*

L (mm)	C (mm)	H (mm)	Ø (mm)	materiale	codice
120	96	25,5	117	zama	1939.02

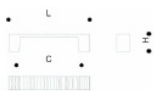



**ART. 1924**

*ART. 1924 · Made in Italy*

L (mm)	C (mm)	H (mm)	Ø (mm)	materiale	codice
139	128	32,5	150	zama	1924.00

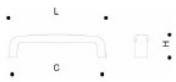

**ART. 1872**

*ART. 1872 · Made in Italy*

L (mm)	C (mm)	H (mm)	Ø (mm)	materiale	codice
178	160	25	105	zama	1872.03
274	256	27	144	zama	1872.06

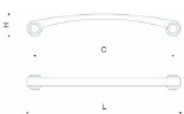



**ART. 1822**

*ART. 1822 · Made in Italy*

L (mm)	C (mm)	H (mm)	Ø (mm)	materiale	codice
139	96	26	70	zama	1822.02

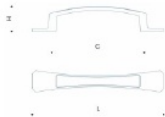

**ART. 1821**

*ART. 1821 · Made in Italy*

L (mm)	C (mm)	H (mm)	Ø (mm)	materiale	codice
147	128	31	85	zama	1821.00

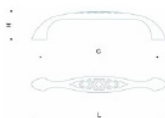



**ART. 1802**

*ART. 1802 · Made in Italy*

L (mm)	C (mm)	H (mm)	Ø (mm)	materiale	codice
140	32	26	93	zama	1802.11

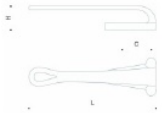

**ART. 1785**

*ART. 1785 · Made in Italy*

L (mm)	C (mm)	H (mm)	Ø (mm)	materiale	codice
149	128	30,5	129	zama	1785.00





**ART. 1765**

*ART. 1765 · Made in Italy*

L (mm)	C (mm)	H (mm)	Ø (mm)	materiale	codice
165	128	26	108	zama	1765.00

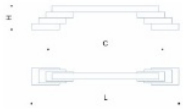

**ART. 1754**

*ART. 1754 · Made in Italy*

L (mm)	C (mm)	H (mm)	Ø (mm)	materiale	codice
111	96	25,5	50	zama	1754.02

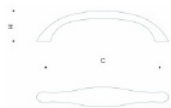



**ART. 1737**

*ART. 1737 · Made in Italy*

L (mm)	C (mm)	H (mm)	Ø (mm)	materiale	codice
185	160	24	—	zama	1737.03



**ART. 1692**

*ART. 1692 · Made in Italy*

L (mm)	C (mm)	H (mm)	Ø (mm)	materiale	codice
142,5	128	31	163	zama	1692.00

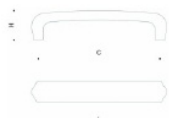



**ART. 1687**

*ART. 1687 · Made in Italy*

L (mm)	C (mm)	H (mm)	Ø (mm)	materiale	codice
162	128	30	10	legno	1687.00

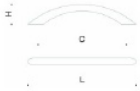

**ART. 1681**

*ART. 1681 · Made in Italy*

L (mm)	C (mm)	H (mm)	Ø (mm)	materiale	codice
160	128	31	230	zama	1681.00

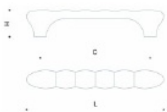

**ART. 1674***ART. 1674 · Made in Italy*

L (mm)	C (mm)	H (mm)	Ø (mm)	materiale	codice
86	64	20	45	zama	1674.01

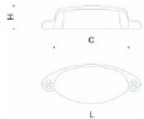
**ART. 1673***ART. 1673 · Made in Italy*

L (mm)	C (mm)	H (mm)	Ø (mm)	materiale	codice
127	96	23,5	50	zama	1673.02





**ART. 1669**

*ART. 1669 · Made in Italy*

L (mm)	C (mm)	H (mm)	Ø (mm)	materiale	codice
138	128	28	67	zama	1669.00

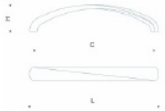

**ART. 1662**

*ART. 1662 · Made in Italy*

L (mm)	C (mm)	H (mm)	Ø (mm)	materiale	codice
147	96	27	60	zama	1662.02

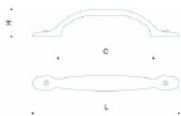



**ART. 1653**

*ART. 1653 · Made in Italy*

L (mm)	C (mm)	H (mm)	Ø (mm)	materiale	codice
163	128	30	30	zama	1653.00

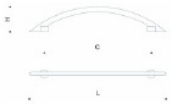

**ART. 1650**

*ART. 1650 · Made in Italy*

L (mm)	C (mm)	H (mm)	Ø (mm)	materiale	codice
105	96	35	35	zama	1650.02





**ART. 1646**

*ART. 1646 · Made in Italy*

L (mm)	C (mm)	H (mm)	Ø (mm)	materiale	codice
146	128	24	65	zama	1646.00



**ART. 1642**

*ART. 1642 · Made in Italy*

L (mm)	C (mm)	H (mm)	Ø (mm)	materiale	codice
97	64	20	70	zama	1642.01



**ART. 1633***ART. 1633 · Made in Italy*

L (mm)	C (mm)	H (mm)	Ø (mm)	materiale	codice
97	64	20	70	zama	1633.01

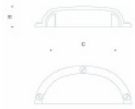
**ART. 1617***ART. 1617 · Made in Italy*

L (mm)	C (mm)	H (mm)	Ø (mm)	materiale	codice
106	96	23	35	zama	1617.02





**ART. 1605**

*ART. 1605 · Made in Italy*

L (mm)	C (mm)	H (mm)	Ø (mm)	materiale	codice
85	64	20,5	60	zama	1605.01



**ART. 1566**

*ART. 1566 · Made in Italy*

L (mm)	C (mm)	H (mm)	Ø (mm)	materiale	codice
138	96	27,5	85	zama	1566.02
168	128	27,5	105	zama	1566.00

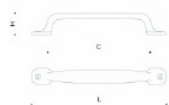



**ART. 1946**

ART. 1946 · Made in Italy

L (mm)	C (mm)	H (mm)	Ø (mm)	materiale	codice
204	160	32	110	zama	1946.03
358	320	32	155	zama	1946.08



**ART. 1945**

ART. 1945 · Made in Italy

L (mm)	C (mm)	H (mm)	Ø (mm)	materiale	codice
172	160	30.5	127	zama	1945.03
332	320	30.5	230	zama	1945.08

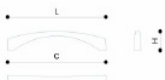



**ART. 1944**

*ART. 1944 · Made in Italy*

L (mm)	C (mm)	H (mm)	Ø (mm)	materiale	codice
168	160	36	152	zama	1944.03
328	320	36	275	zama	1944.08

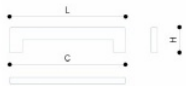

**ART. 1948**

*ART. 1948 · Made in Italy*

L (mm)	C (mm)	H (mm)	Ø (mm)	materiale	codice
170	160	22.6	165	zama	1948.03





**ART. 1943**

*ART. 1943 · Made in Italy*

L (mm)	C (mm)	H (mm)	Ø (mm)	materiale	codice
197	160	29	170	zama	1943.03

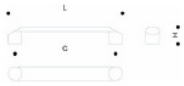

**ART. 1940**

*ART. 1940 · Made in Italy*

L (mm)	C (mm)	H (mm)	Ø (mm)	materiale	codice
169,3	160	22,5	180	zama	1940.03

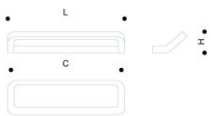



**ART. 1937**

*ART. 1937 · Made in Italy*

L (mm)	C (mm)	H (mm)	Ø (mm)	materiale	codice
—	—	—	—	—	—

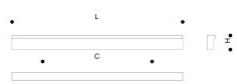

**ART. 1934**

*ART. 1934 · Made in Italy*

L (mm)	C (mm)	H (mm)	Ø (mm)	materiale	codice
246	192	—	95	zama	1934.04





**ART. 1931**

ART. 1931 · Made in Italy

L (mm)	C (mm)	H (mm)	Ø (mm)	materiale	codice
176	160	23,8	200	zama	1931.03



**ART. 1929**

ART. 1929 · Made in Italy

L (mm)	C (mm)	H (mm)	Ø (mm)	materiale	codice
359	288	26	200	zama	1929.07
239	160	26	115	zama	1929.05



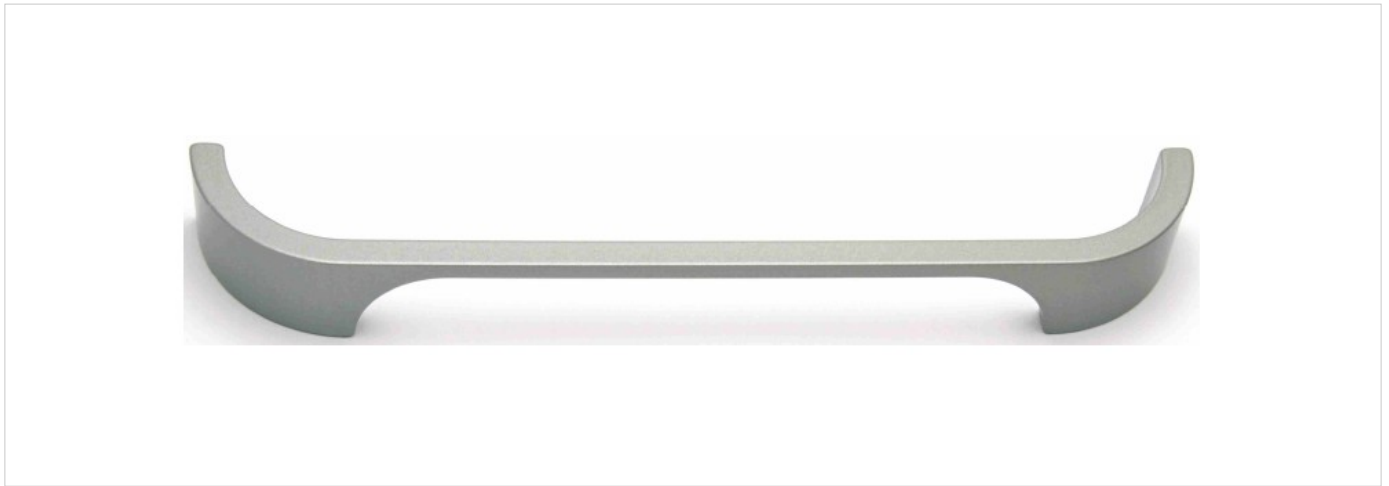

**ART. 1928**

*ART. 1928 · Made in Italy*

L (mm)	C (mm)	H (mm)	Ø (mm)	materiale	codice
218,4	160	24	152	zama	1928.03

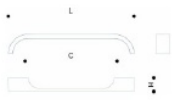

**ART. 1926**

*ART. 1926 · Made in Italy*

L (mm)	C (mm)	H (mm)	Ø (mm)	materiale	codice
176,6	160	20	210	zama	1926.03



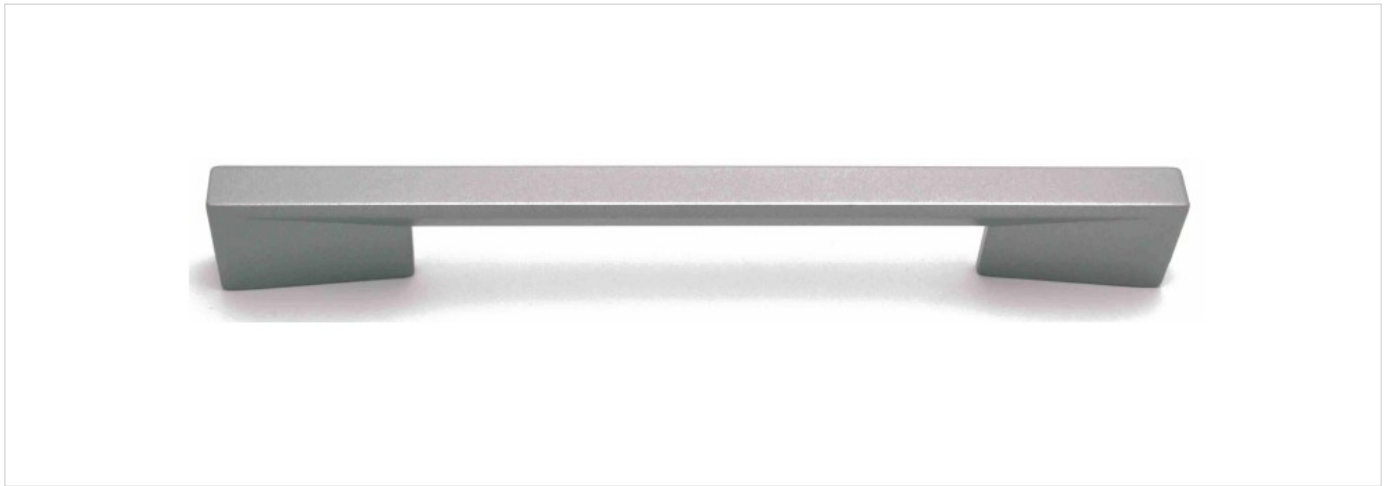

**ART. 1923**

*ART. 1923 · Made in Italy*

L (mm)	C (mm)	H (mm)	Ø (mm)	materiale	codice
210	—	29	200	zama	1923.04



**ART. 1922**

*ART. 1922 · Made in Italy*

L (mm)	C (mm)	H (mm)	Ø (mm)	materiale	codice
185	128	26,5	145	zama	1922.00





**ART. 1920**

*ART. 1920 · Made in Italy*

L (mm)	C (mm)	H (mm)	Ø (mm)	materiale	codice
56	32	38	68	zama	1920.11

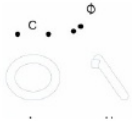

**ART. 1919**

*ART. 1919 · Made in Italy*

L (mm)	C (mm)	H (mm)	Ø (mm)	materiale	codice
182	128	32	168	zama	1919.00

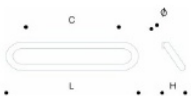



**ART. 1918**

ART. 1918 · Made in Italy

L (mm)	C (mm)	H (mm)	Ø (mm)	materiale	codice
196	160	26	122	zama	1918.03
228	192	26	130	zama	1918.04
356	320	26	180	zama	1918.08

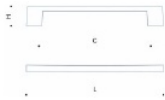

**ART. 1916**

ART. 1916 · Made in Italy

L (mm)	C (mm)	H (mm)	Ø (mm)	materiale	codice
146	64	30	150	zama	1916.146





**ART. 1912**

*ART. 1912 · Made in Italy*

L (mm)	C (mm)	H (mm)	Ø (mm)	materiale	codice
202	192	17	65	zama	1912.04

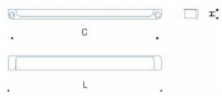

**ART. 1910**

*ART. 1910 · Made in Italy*

L (mm)	C (mm)	H (mm)	Ø (mm)	materiale	codice
80	32	17,5	80	zama	1910.11

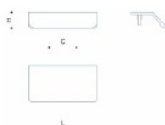



**ART. 1909**

*ART. 1909 · Made in Italy*

L (mm)	C (mm)	H (mm)	Ø (mm)	materiale	codice
72	64	25	120	zama	1909.01
200	192	25	200	zama	1909.04



**ART. 1908**

*ART. 1908 · Made in Italy*

L (mm)	C (mm)	H (mm)	Ø (mm)	materiale	codice
60	45	45	150	zama	1908.45

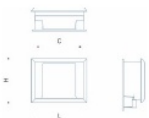



**ART. 1907**

*ART. 1907 · Made in Italy*

L (mm)	C (mm)	H (mm)	Ø (mm)	materiale	codice
120	105	45	240	zama	1907.105



**ART. 1906**

*ART. 1906 · Made in Italy*

L (mm)	C (mm)	H (mm)	Ø (mm)	materiale	codice
207	192	23	—	legno	1906.04





**ART. 1905**

*ART. 1905 · Made in Italy*

L (mm)	C (mm)	H (mm)	Ø (mm)	materiale	codice
70	32	26,5	175	zama	1905-01



**ART. 1902**

*ART. 1902 · Made in Italy*

L (mm)	C (mm)	H (mm)	Ø (mm)	materiale	codice
203	160	27	80	zama+PA	1902.03

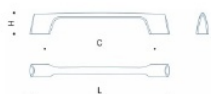



**ART. 1900**

*ART. 1900 · Made in Italy*

L (mm)	C (mm)	H (mm)	Ø (mm)	materiale	codice
70	16	25,5	105	zama	1900.92



**ART. 1884**

*ART. 1884 · Made in Italy*

L (mm)	C (mm)	H (mm)	Ø (mm)	materiale	codice
220	160	36	120	zama	1884.03
L	C	H	peso	materiale	codice

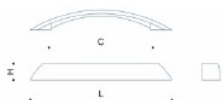



**ART. 1882**

*ART. 1882 · Made in Italy*

L (mm)	C (mm)	H (mm)	Ø (mm)	materiale	codice
204	160	24	120	zama	1882.03

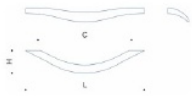

**ART. 1881**

*ART. 1881 · Made in Italy*

L (mm)	C (mm)	H (mm)	Ø (mm)	materiale	codice
182	160	31	120	zama	1881.03



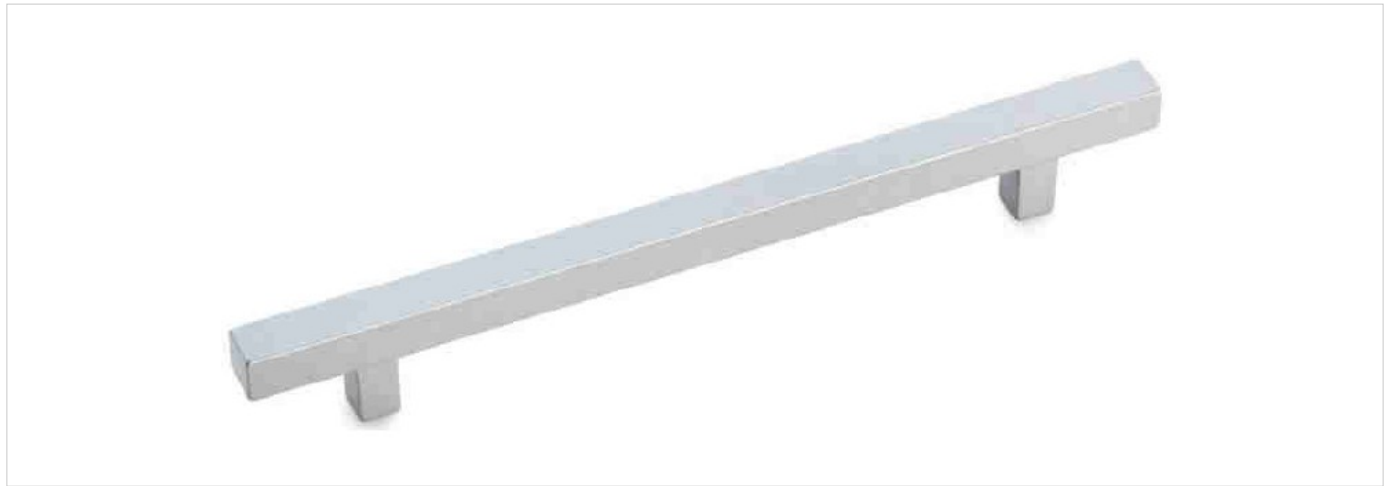

**ART. 1880**

*ART. 1880 · Made in Italy*

L (mm)	C (mm)	H (mm)	Ø (mm)	materiale	codice
182	160	33	190	zama	1880.03

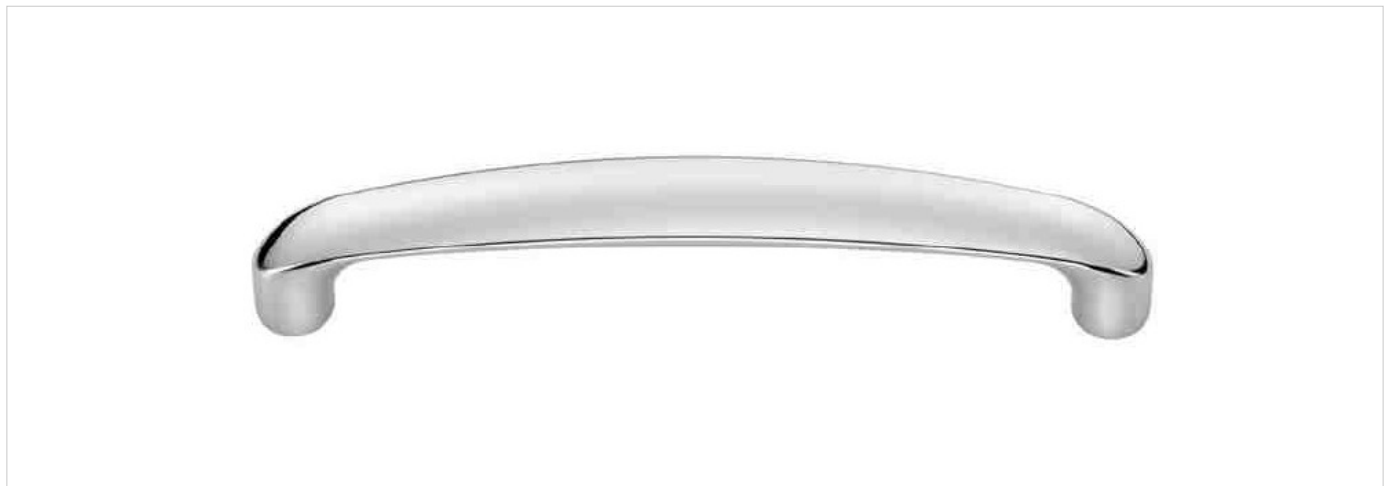

**ART. 1876**

*ART. 1876 · Made in Italy*

L (mm)	C (mm)	H (mm)	Ø (mm)	materiale	codice
182	160	33	190	zama	1876.03





**ART. 1874**

*ART. 1874 · Made in Italy*

L (mm)	C (mm)	H (mm)	Ø (mm)	materiale	codice
141	64	24,5	75	zama	1874.01

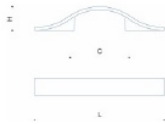

**ART. 1873**

*ART. 1873 · Made in Italy*

L (mm)	C (mm)	H (mm)	Ø (mm)	materiale	codice
141	128	33	115	zama	1873.00

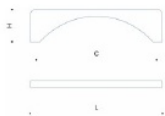



**ART. 1870**

*ART. 1870 · Made in Italy*

L (mm)	C (mm)	H (mm)	Ø (mm)	materiale	codice
130	64	8	45	zama	1870.01

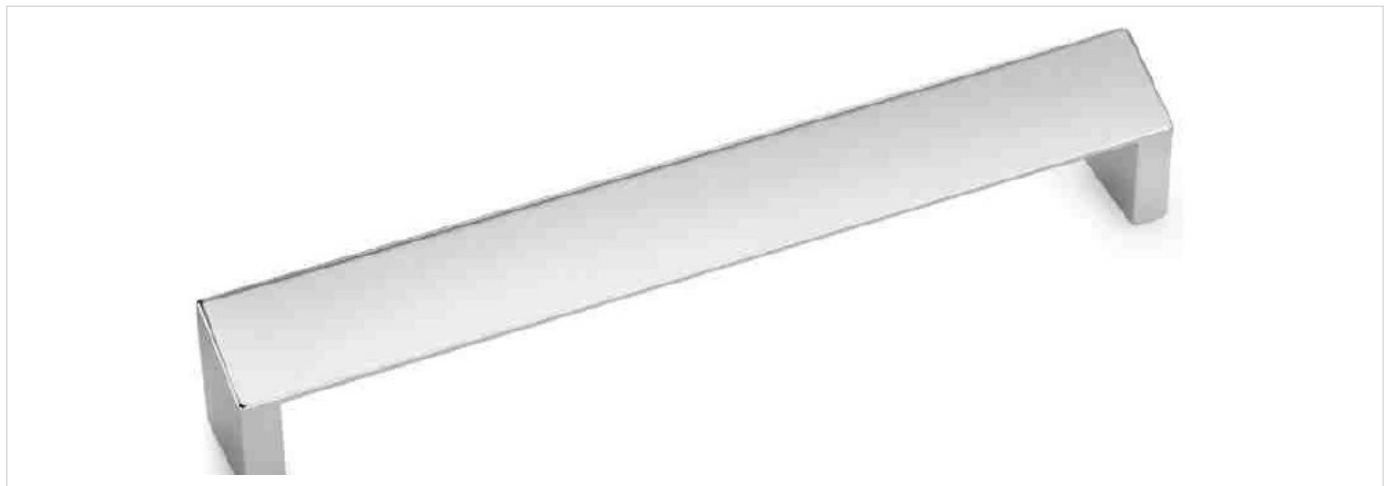

**ART. 1868**

*ART. 1868 · Made in Italy*

L (mm)	C (mm)	H (mm)	Ø (mm)	materiale	codice
233	224	28	380	zama	1868.05





**ART. 1867**

*ART. 1867 · Made in Italy*

L (mm)	C (mm)	H (mm)	Ø (mm)	materiale	codice
140	128	22	145	zama	1867.00

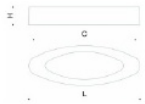

**ART. 1866**

*ART. 1866 · Made in Italy*

L (mm)	C (mm)	H (mm)	Ø (mm)	materiale	codice
225	160	33	240	zama	1866.03
320	256	33	270	zama	1866.06

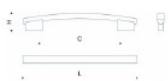



**ART. 1864**

*ART. 1864 · Made in Italy*

L (mm)	C (mm)	H (mm)	Ø (mm)	materiale	codice
90	64	17	65	zama	1864.01



**ART. 1862**

*ART. 1862 · Made in Italy*

L (mm)	C (mm)	H (mm)	Ø (mm)	materiale	codice
208	160	25	280	zama	1862.03





**ART. 1859**

*ART. 1859 · Made in Italy*

L (mm)	C (mm)	H (mm)	Ø (mm)	materiale	codice
70	32	20	100	zama	1859.11

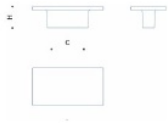

**ART. 1858**

*ART. 1858 · Made in Italy*

L (mm)	C (mm)	H (mm)	Ø (mm)	materiale	codice
78	32	26	230	zama	1858.11

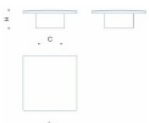



**ART. 1857**

*ART. 1857 · Made in Italy*

L (mm)	C (mm)	H (mm)	Ø (mm)	materiale	codice
146	128	32	135	zama	1857.00

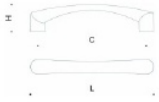

**ART. 1856**

*ART. 1856 · Made in Italy*

L (mm)	C (mm)	H (mm)	Ø (mm)	materiale	codice
173	160	33	245	zama	1856.03

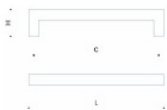



**ART. 1855**

*ART. 1855 · Made in Italy*

L (mm)	C (mm)	H (mm)	Ø (mm)	materiale	codice
182	128	24	150	zama	1855.00



**ART. 1854**

*ART. 1854 · Made in Italy*

L (mm)	C (mm)	H (mm)	Ø (mm)	materiale	codice
230	192	33	260	zama	1854.04





**ART. 1853**

*ART. 1853 · Made in Italy*

L (mm)	C (mm)	H (mm)	Ø (mm)	materiale	codice
205	192	38	240	zama	1853.04

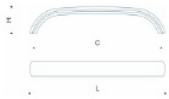

**ART. 1852**

*ART. 1852 · Made in Italy*

L (mm)	C (mm)	H (mm)	Ø (mm)	materiale	codice
208	192	31	150	zama	1852.04





**ART. 1847**

*ART. 1847 · Made in Italy*

L (mm)	C (mm)	H (mm)	Ø (mm)	materiale	codice
229	64	25	105	zama	1847.01

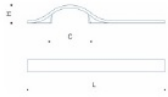

**ART. 1845**

*ART. 1845 · Made in Italy*

L (mm)	C (mm)	H (mm)	Ø (mm)	materiale	codice
70	32	20	155	zama	1845.11

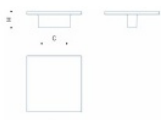



**ART. 1843**

*ART. 1843 · Made in Italy*

L (mm)	C (mm)	H (mm)	Ø (mm)	materiale	codice
165	64	20	200	zama	1843.01



**ART. 1839**

*ART. 1839 · Made in Italy*

L (mm)	C (mm)	H (mm)	Ø (mm)	materiale	codice
262	256	60	350	zama	1839.06





**ART. 1837**

*ART. 1837 · Made in Italy*

L (mm)	C (mm)	H (mm)	Ø (mm)	materiale	codice
135,5	128	29	235	zama	1837.00

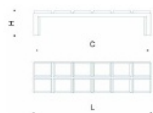

**ART. 1836**

*ART. 1836 · Made in Italy*

L (mm)	C (mm)	H (mm)	Ø (mm)	materiale	codice
134,5	160	27	140	zama	1836.03

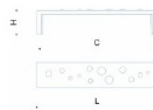



**ART. 1831**

*ART. 1831 · Made in Italy*

L (mm)	C (mm)	H (mm)	Ø (mm)	materiale	codice
117	96	28	65	zama	1831.02

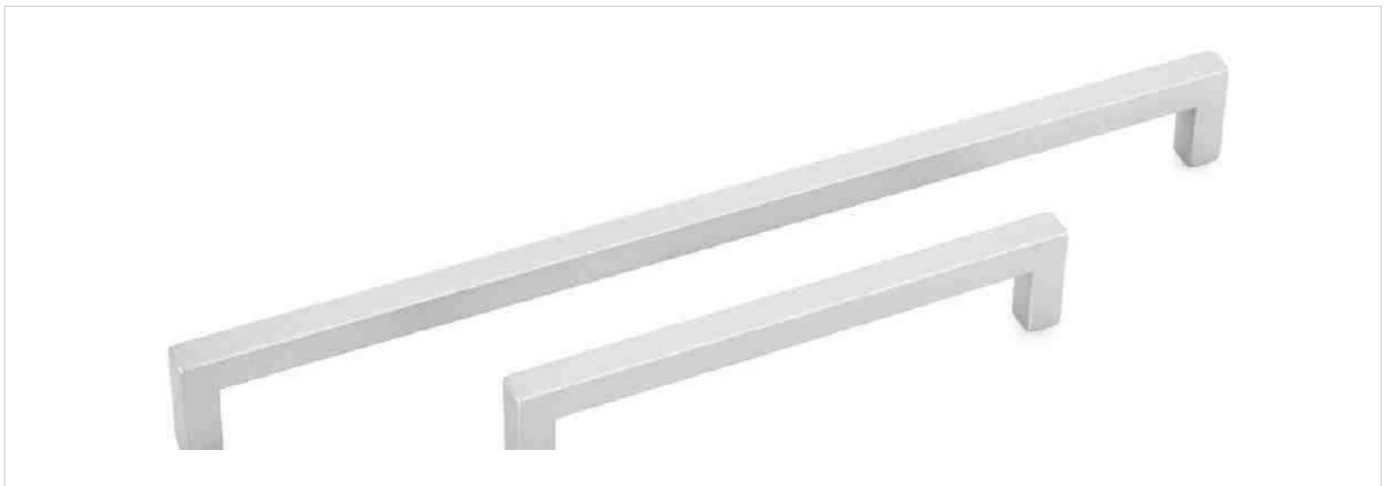
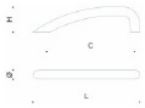

**ART. 1827**

*ART. 1827 · Made in Italy*

L (mm)	C (mm)	H (mm)	Ø (mm)	materiale	codice
171	160	35	180	zama	1827.03
331	320	35	315	zama	1827.08

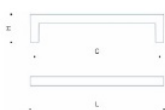



**ART. 1824**

*ART. 1824 · Made in Italy*

L (mm)	C (mm)	H (mm)	Ø (mm)	materiale	codice
210	160	32	187	zama	1824.03

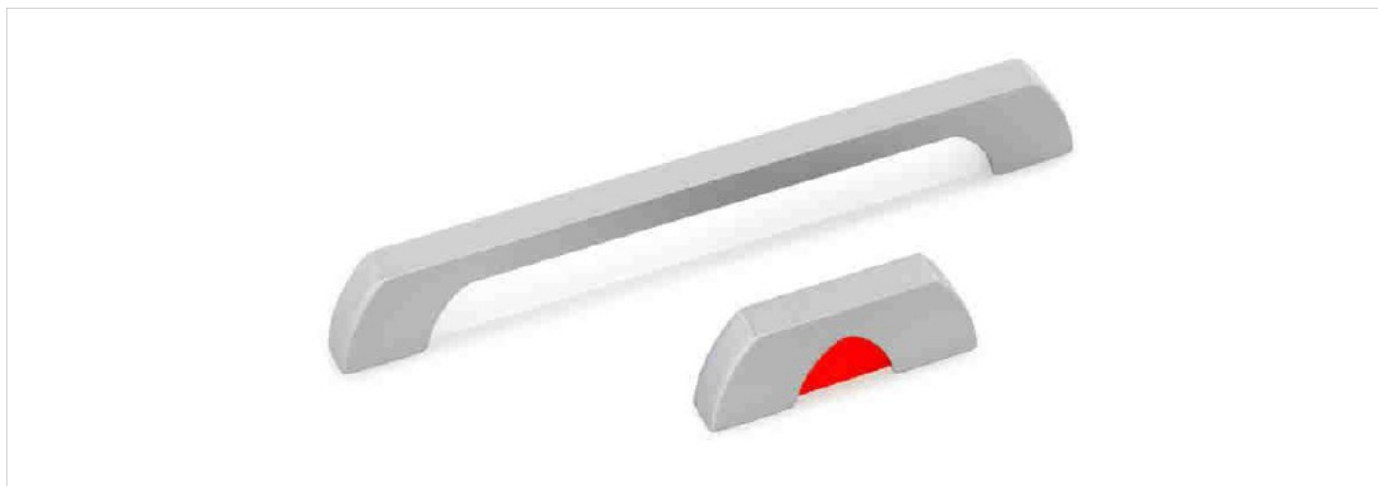

**ART. 1820**

*ART. 1820 · Made in Italy*

L (mm)	C (mm)	H (mm)	Ø (mm)	materiale	codice
150	128	22	90	zama+PMMA	1820.00
54	32	22	45	zama+PMMA	1820.11





**ART. 1819**

*ART. 1819 · Made in Italy*

L (mm)	C (mm)	H (mm)	Ø (mm)	materiale	codice
160	128	26	230	zama	1819.00

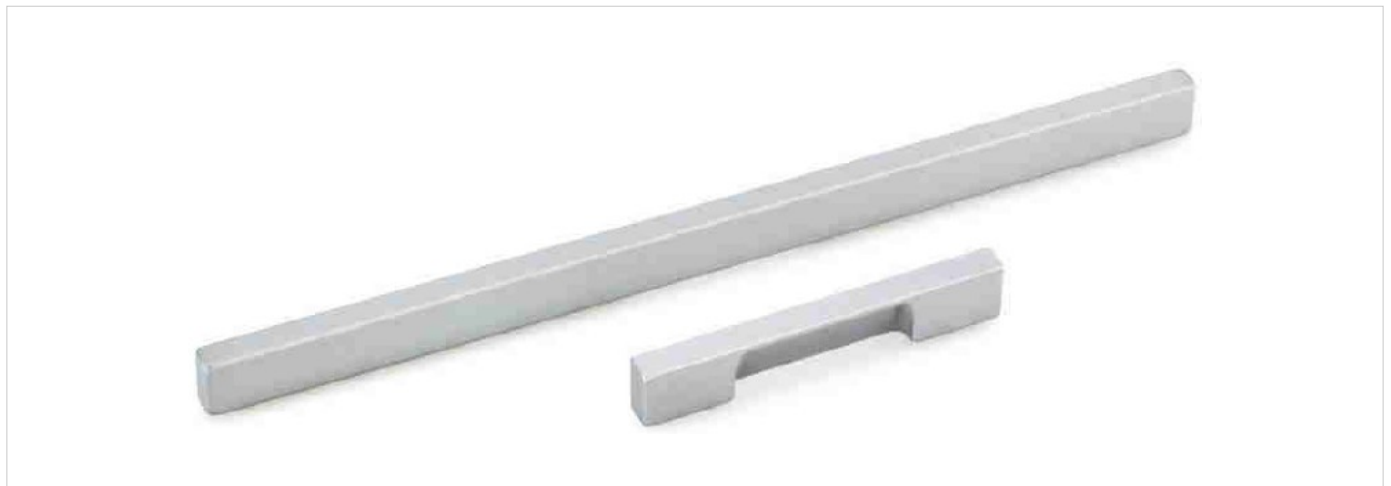
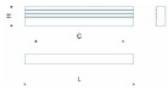

**ART. 1815**

*ART. 1815 · Made in Italy*

L (mm)	C (mm)	H (mm)	Ø (mm)	materiale	codice
100	64	17	80	zama	1815.01
278	160	17	250	zama	1815.03
50	32	17	40	zama	1815.11

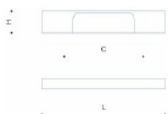



**ART. 1812**

*ART. 1812 · Made in Italy*

L (mm)	C (mm)	H (mm)	Ø (mm)	materiale	codice
126	96	22	105	zama	1812.02

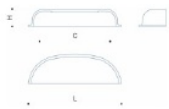

**ART. 1800**

*ART. 1800 · Made in Italy*

L (mm)	C (mm)	H (mm)	Ø (mm)	materiale	codice
136	128	19,5	127	zama	1800.00
168	160	19,5	140	zama	1800.03





moderne

**ART. 1799**

ART. 1799 · Made in Italy

L (mm)	C (mm)	H (mm)	Ø (mm)	materiale	codice
181	160	14,5	325	zama+ferro	1799.03



**ART. 1798**

ART. 1798 · Made in Italy

L (mm)	C (mm)	H (mm)	Ø (mm)	materiale	codice
210	32	32	215	zama	1798.11

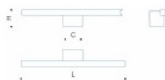



**ART. 1796**

*ART. 1796 · Made in Italy*

L (mm)	C (mm)	H (mm)	Ø (mm)	materiale	codice
168	160	36	166	zama	1796.03



**ART. 1794**

*ART. 1794 · Made in Italy*

L (mm)	C (mm)	H (mm)	Ø (mm)	materiale	codice
142	128	24	47	zama	1794.00

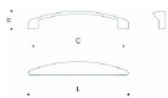



**ART. 1791**

*ART. 1791 · Made in Italy*

L (mm)	C (mm)	H (mm)	Ø (mm)	materiale	codice
142	128	24	140	zama	1791.00
108	96	24	112	zama	1791.02



**ART. 1790**

*ART. 1790 · Made in Italy*

L (mm)	C (mm)	H (mm)	Ø (mm)	materiale	codice
140	128	27	155	zama	1790.00



**1789**

L	C	H	Ø	peso	materiale	codice
165	128	25,5	123		zama	1789.00

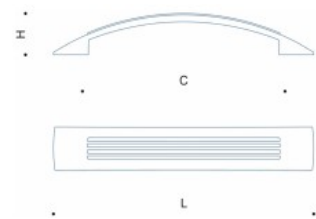

**ART. 1789**

*ART. 1789 · Made in Italy*

L (mm)	C (mm)	H (mm)	Ø (mm)	materiale	codice
165	128	25,5	123	zama	1789.00

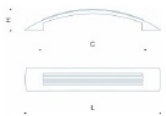

**ART. 1788**

*ART. 1788 · Made in Italy*

L (mm)	C (mm)	H (mm)	Ø (mm)	materiale	codice
136	128	22,5	107	zama	1788.00





**ART. 1784**

ART. 1784 · Made in Italy

L (mm)	C (mm)	H (mm)	Ø (mm)	materiale	codice
170	96	18	140	zama	1784.02



**ART. 1783**

ART. 1783 · Made in Italy

L (mm)	C (mm)	H (mm)	Ø (mm)	materiale	codice
170	160	27	116	zama	1783.03
253	224	27	165	zama	1783.05
300	288	27	203	zama	1783.07

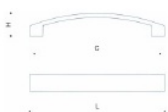



**ART. 1780**

ART. 1780 · Made in Italy

L (mm)	C (mm)	H (mm)	Ø (mm)	materiale	codice
206	128	26,5	206	zama	1780.00
97	64	26,5	150	zama	1780.01
220	160	26,5	220	zama	1780.03
225	192	26,5	230	zama	1780.04



**ART. 1779**

ART. 1779 · Made in Italy

L (mm)	C (mm)	H (mm)	Ø (mm)	materiale	codice
152	128	26	36	zama	1779.00

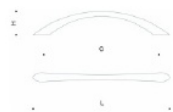



**ART. 1778**

*ART. 1778 · Made in Italy*

L (mm)	C (mm)	H (mm)	Ø (mm)	materiale	codice
80	64	26	95	zama	1778.01



**ART. 1776**

*ART. 1776 · Made in Italy*

L (mm)	C (mm)	H (mm)	Ø (mm)	materiale	codice
160	128	22	83	zama	1776.00

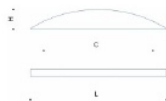



**ART. 1775**

ART. 1775 · Made in Italy

L (mm)	C (mm)	H (mm)	Ø (mm)	materiale	codice
220	160	30	173	zama	1775.03



**ART. 1772**

ART. 1772 · Made in Italy

L (mm)	C (mm)	H (mm)	Ø (mm)	materiale	codice
200	160	29	175	zama	1772.03

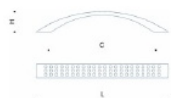



**ART. 1771**

*ART. 1771 · Made in Italy*

L (mm)	C (mm)	H (mm)	Ø (mm)	materiale	codice
60	32	30	59	ferro	1771.11



**ART. 1770**

*ART. 1770 · Made in Italy*

L (mm)	C (mm)	H (mm)	Ø (mm)	materiale	codice
160	96	24	121	zama	1770.02

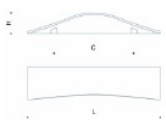



**ART. 1769**

*ART. 1769 · Made in Italy*

L (mm)	C (mm)	H (mm)	Ø (mm)	materiale	codice
145	128	33,8	90	zama+legno	1769.00
177	160	33,8	100	zama+legno	1769.03

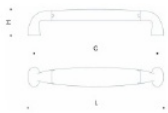

**ART. 1768**

*ART. 1768 · Made in Italy*

L (mm)	C (mm)	H (mm)	Ø (mm)	materiale	codice
234	224	36	160	ferro	1768.05



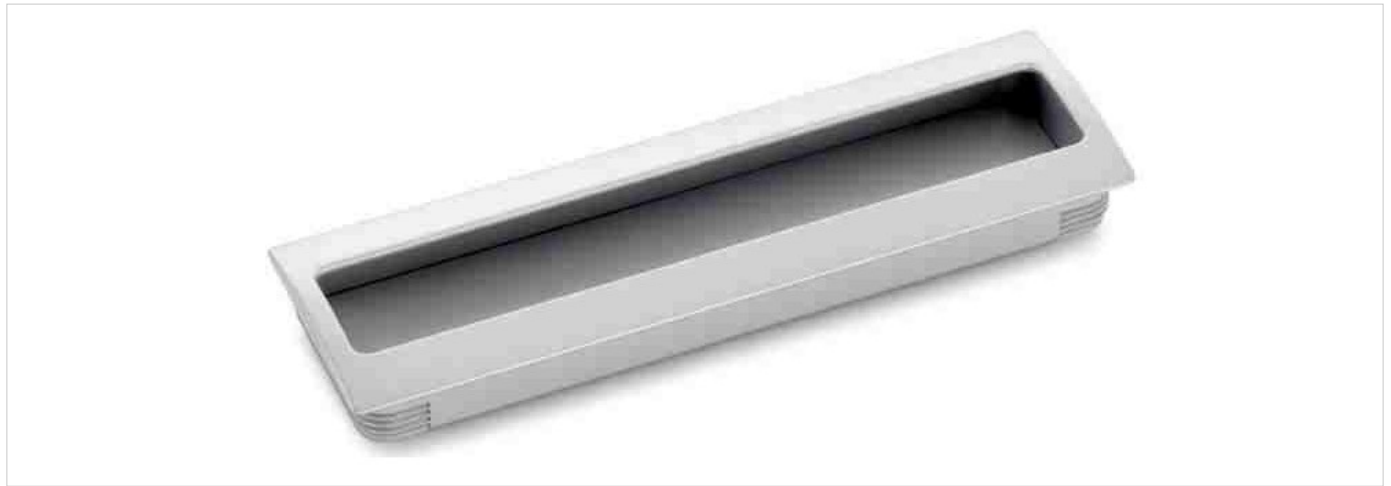

**ART. 1767**

*ART. 1767 · Made in Italy*

L (mm)	C (mm)	H (mm)	Ø (mm)	materiale	codice
180	160	14.5	255	zama+ferro	1767.03



**ART. 1766**

*ART. 1766 · Made in Italy*

L (mm)	C (mm)	H (mm)	Ø (mm)	materiale	codice
150	128	34	222	zama	1766.00
127	96	34	200	zama	1766.02
183	160	34	252	zama	1766.03
206	192	34	260	zama	1766.04
557	544	34	600	zama	1766.16





**ART. 1763**

*ART. 1763 · Made in Italy*

L (mm)	C (mm)	H (mm)	Ø (mm)	materiale	codice
60	32	20	51	zama	1763.11



**ART. 1761**

*ART. 1761 · Made in Italy*

L (mm)	C (mm)	H (mm)	Ø (mm)	materiale	codice
—	—	—	—	—	—

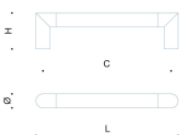



**ART. 1760**

ART. 1760 · Made in Italy

L (mm)	C (mm)	H (mm)	Ø (mm)	materiale	codice
186	160	35	158	zama	1760.03

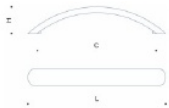

**ART. 1758**

ART. 1758 · Made in Italy

L (mm)	C (mm)	H (mm)	Ø (mm)	materiale	codice
155	128	29	120	zama	1758.00
185	160	29	130	zama	1758.03

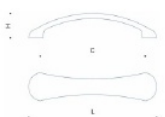



**ART. 1757**

ART. 1757 · Made in Italy

L (mm)	C (mm)	H (mm)	Ø (mm)	materiale	codice
170	128	28	122	zama	1757.00
138	96	28	120	zama	1757.02
203	160	28	150	zama	1757.03
362	352	28	205	zama	1757.09

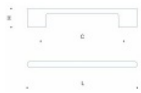

**ART. 1755**

ART. 1755 · Made in Italy

L (mm)	C (mm)	H (mm)	Ø (mm)	materiale	codice
145	128	32	129	zama	1755.00
265	224	32	239	zama	1755.05





**ART. 1752**

*ART. 1752 · Made in Italy*

L (mm)	C (mm)	H (mm)	Ø (mm)	materiale	codice
164	128	28	52	zama	1752.00

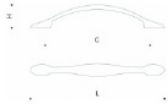

**ART. 1751**

*ART. 1751 · Made in Italy*

L (mm)	C (mm)	H (mm)	Ø (mm)	materiale	codice
152	128	29	100	zama	1751.00



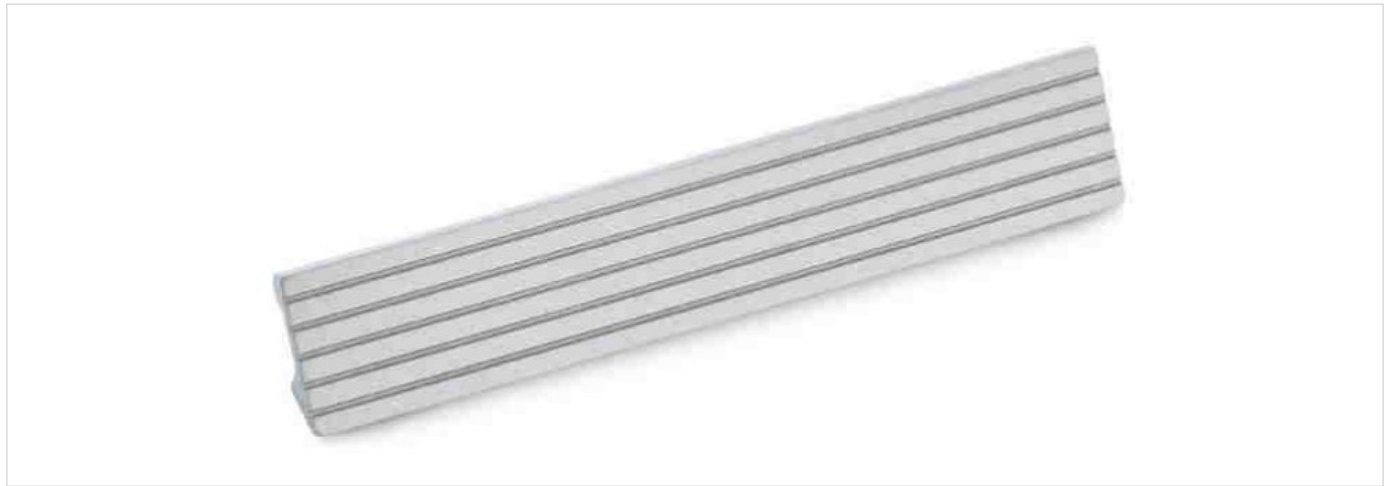

**ART. 1743**

*ART. 1743 · Made in Italy*

L (mm)	C (mm)	H (mm)	Ø (mm)	materiale	codice
185	160	30,7	165	zama	1743.03



**ART. 1741**

*ART. 1741 · Made in Italy*

L (mm)	C (mm)	H (mm)	Ø (mm)	materiale	codice
137	128	21	74	zama	1741.00





**ART. 1736**

ART. 1736 · Made in Italy

L (mm)	C (mm)	H (mm)	Ø (mm)	materiale	codice
180	—	24	235	zama	1736.03

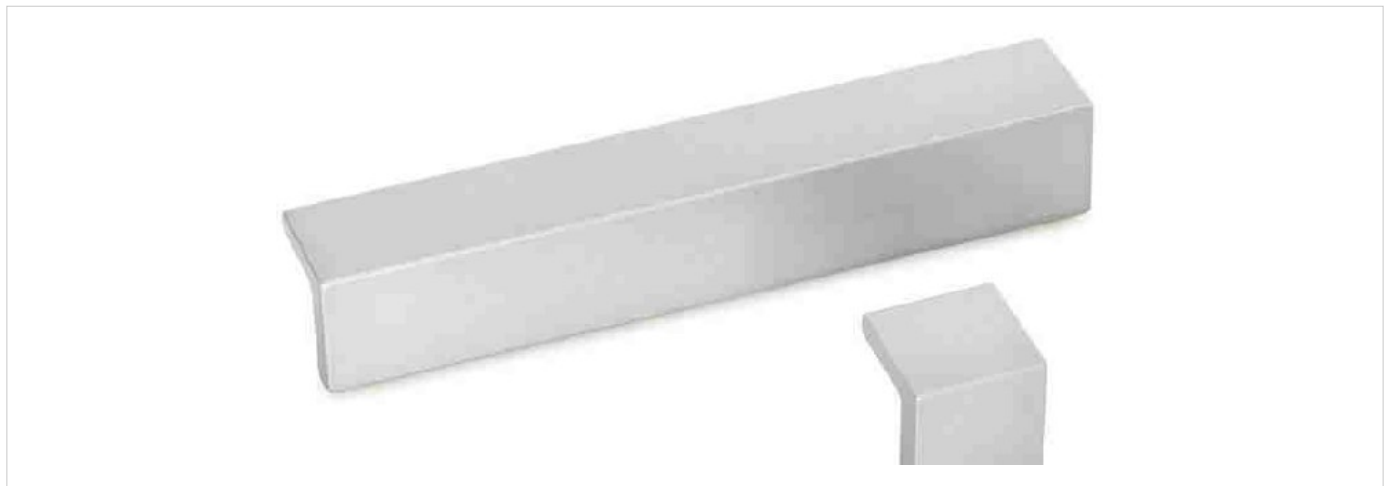

**ART. 1735**

ART. 1735 · Made in Italy

L (mm)	C (mm)	H (mm)	Ø (mm)	materiale	codice
180	160	30	196	zama	1735.03
30	16	30	47	zama	1735.92





**ART. 1731**

ART. 1731 · Made in Italy

L (mm)	C (mm)	H (mm)	Ø (mm)	materiale	codice
173	160	32	310	zama	1731.03



**ART. 1729**

ART. 1729 · Made in Italy

L (mm)	C (mm)	H (mm)	Ø (mm)	materiale	codice
172	160	32	175	—	1729.03

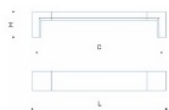



**ART. 1726**

*ART. 1726 · Made in Italy*

L (mm)	C (mm)	H (mm)	Ø (mm)	materiale	codice
105	96	35	61	zama	1726.02



**ART. 1725**

*ART. 1725 · Made in Italy*

L (mm)	C (mm)	H (mm)	Ø (mm)	materiale	codice
138	128	30	105	zama+PMMA	1725.00

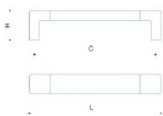



**ART. 1724**

*ART. 1724 · Made in Italy*

L (mm)	C (mm)	H (mm)	Ø (mm)	materiale	codice
96	64	22	29	zama	1724.01

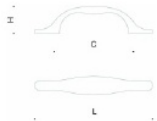

**ART. 1723**

*ART. 1723 · Made in Italy*

L (mm)	C (mm)	H (mm)	Ø (mm)	materiale	codice
149	128	20,3	159	zama	1723.00





**ART. 1722**

*ART. 1722 · Made in Italy*

L (mm)	C (mm)	H (mm)	Ø (mm)	materiale	codice
137	128	30	205	zama	1722.00



**ART. 1721**

*ART. 1721 · Made in Italy*

L (mm)	C (mm)	H (mm)	Ø (mm)	materiale	codice
140	128	32	115	zama+PMMA	1721.00
170	160	32	100	zama+PMMA	1721.03

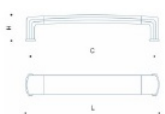



**ART. 1720**

*ART. 1720 · Made in Italy*

L (mm)	C (mm)	H (mm)	Ø (mm)	materiale	codice
225	96	29	111	zama	1720.02

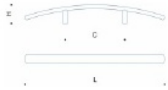

**ART. 1718**

*ART. 1718 · Made in Italy*

L (mm)	C (mm)	H (mm)	Ø (mm)	materiale	codice
213	128	26	161	zama	1718.00
245	160	26	194	zama	1718.03





**ART. 1716**

*ART. 1716 · Made in Italy*

L (mm)	C (mm)	H (mm)	Ø (mm)	materiale	codice
40	32	20	20	zama	1716.11



**ART. 1715**

*ART. 1715 · Made in Italy*

L (mm)	C (mm)	H (mm)	Ø (mm)	materiale	codice
230	192	30,5	138	zama	1715.04





**ART. 1712**

*ART. 1712 · Made in Italy*

L (mm)	C (mm)	H (mm)	Ø (mm)	materiale	codice
174	160	36	212	zama	1712.03

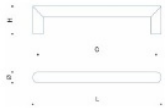

**ART. 1711**

*ART. 1711 · Made in Italy*

L (mm)	C (mm)	H (mm)	Ø (mm)	materiale	codice
130	96	29,5	141	zama	1711.02
260	224	31	228	zama	1711.05

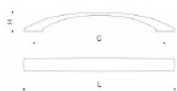



**ART. 1705**

*ART. 1705 · Made in Italy*

L (mm)	C (mm)	H (mm)	Ø (mm)	materiale	codice
78,5	64	26	40	zama	1705.01

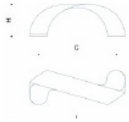

**ART. 1704**

*ART. 1704 · Made in Italy*

L (mm)	C (mm)	H (mm)	Ø (mm)	materiale	codice
—	—	—	—	—	—

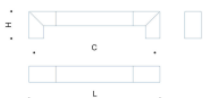



**ART. 1703**

ART. 1703 · Made in Italy

L (mm)	C (mm)	H (mm)	Ø (mm)	materiale	codice
—	—	—	—	—	—



**ART. 1702**

ART. 1702 · Made in Italy

L (mm)	C (mm)	H (mm)	Ø (mm)	materiale	codice
138	96	24,5	140	zama	1702.02

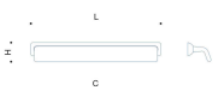



**ART. 1701**

*ART. 1701 · Made in Italy*

L (mm)	C (mm)	H (mm)	Ø (mm)	materiale	codice
230	192	30,5	160	zama	1701.04



**ART. 1699**

*ART. 1699 · Made in Italy*

L (mm)	C (mm)	H (mm)	Ø (mm)	materiale	codice
—	—	—	—	—	—





**ART. 1696**

*ART. 1696 · Made in Italy*

L (mm)	C (mm)	H (mm)	Ø (mm)	materiale	codice
50	32	17	40	zama	1696.11



**ART. 1695**

*ART. 1695 · Made in Italy*

L (mm)	C (mm)	H (mm)	Ø (mm)	materiale	codice
—	—	—	—	—	—





**ART. 1691**

*ART. 1691 · Made in Italy*

L (mm)	C (mm)	H (mm)	Ø (mm)	materiale	codice
146	128	30	125	zama	1691.00



**ART. 1685**

*ART. 1685 · Made in Italy*

L (mm)	C (mm)	H (mm)	Ø (mm)	materiale	codice
232	224	60	124	ferro	1685.05
264	256	60	145	ferro	1685.05





**ART. 1682**

*ART. 1682 · Made in Italy*

L (mm)	C (mm)	H (mm)	Ø (mm)	materiale	codice
154	128	34	145	zama	1682.00

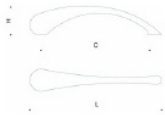

**ART. 1680**

*ART. 1680 · Made in Italy*

L (mm)	C (mm)	H (mm)	Ø (mm)	materiale	codice
128	96	30	95	zama	1680.02

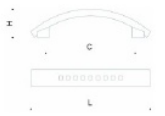



**ART. 1677**

ART. 1677 · Made in Italy

L (mm)	C (mm)	H (mm)	Ø (mm)	materiale	codice
167	160	25	215	zama	1677.03

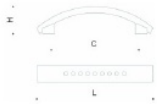

**ART. 1675**

ART. 1675 · Made in Italy

L (mm)	C (mm)	H (mm)	Ø (mm)	materiale	codice
153	128	27,5	75	zama	1675.00
120	96	25	55	zama	1675.02

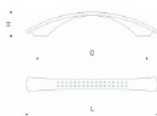



**ART. 1672**

*ART. 1672 · Made in Italy*

L (mm)	C (mm)	H (mm)	Ø (mm)	materiale	codice
152	128	25	40	zama	1672.00

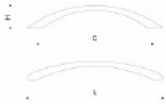

**ART. 1670**

*ART. 1670 · Made in Italy*

L (mm)	C (mm)	H (mm)	Ø (mm)	materiale	codice
224	160	30	180	zama	1670.03





**ART. 1666**

*ART. 1666 · Made in Italy*

L (mm)	C (mm)	H (mm)	Ø (mm)	materiale	codice
185	128	30	75	zama	1666.00

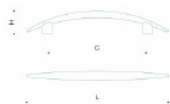

**ART. 1665**

*ART. 1665 · Made in Italy*

L (mm)	C (mm)	H (mm)	Ø (mm)	materiale	codice
200	128	30	109	zama	1665.00





**ART. 1659**

*ART. 1659 · Made in Italy*

L (mm)	C (mm)	H (mm)	Ø (mm)	materiale	codice
109	96	30,5	65	zama	1659.02

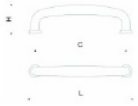

**ART. 1658**

*ART. 1658 · Made in Italy*

L (mm)	C (mm)	H (mm)	Ø (mm)	materiale	codice
135	128	28	85	zama	1658.00
167	160	28	100	zama	1658.03

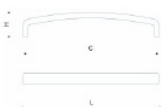

**ART. 1657***ART. 1657 · Made in Italy*

L (mm)	C (mm)	H (mm)	Ø (mm)	materiale	codice
164	128	27	130	zama	1657.00

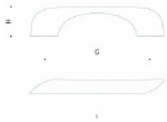
**ART. 1656***ART. 1656 · Made in Italy*

L (mm)	C (mm)	H (mm)	Ø (mm)	materiale	codice
136	128	26,5	55	zama	1656.00





**ART. 1654**

*ART. 1654 · Made in Italy*

L (mm)	C (mm)	H (mm)	Ø (mm)	materiale	codice
280	32	32	255	zama	1654.11

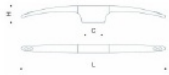

**ART. 1649**

*ART. 1649 · Made in Italy*

L (mm)	C (mm)	H (mm)	Ø (mm)	materiale	codice
82	64	24,5	30	zama	1649.01





**ART. 1647**

ART. 1647 · Made in Italy

L (mm)	C (mm)	H (mm)	Ø (mm)	materiale	codice
196	160	29,5	105	zama	1647.03

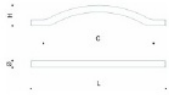

**ART. 1645**

ART. 1645 · Made in Italy

L (mm)	C (mm)	H (mm)	Ø (mm)	materiale	codice
148,5	128	30,5	115	zama+legno	1645.00
148,5	128	30,5	50	zama+legno	1645.00
116	96	30,5	48	zama+legno	1645.01

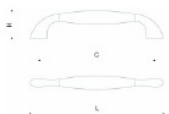



**ART. 1644**

*ART. 1644 · Made in Italy*

L (mm)	C (mm)	H (mm)	Ø (mm)	materiale	codice
124	96	33	65	zama	1644.02

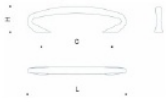

**ART. 1640**

*ART. 1640 · Made in Italy*

L (mm)	C (mm)	H (mm)	Ø (mm)	materiale	codice
164	128	25	70	zama	1640.00





**ART. 1636**

*ART. 1636 · Made in Italy*

L (mm)	C (mm)	H (mm)	Ø (mm)	materiale	codice
80	64	21	100	zama	1636.01
110	96	29	125	zama	1636.02

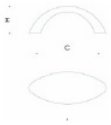

**ART. 1635**

*ART. 1635 · Made in Italy*

L (mm)	C (mm)	H (mm)	Ø (mm)	materiale	codice
50	16	18,5	65	zama	1635.92





**ART. 1632**

*ART. 1632 · Made in Italy*

L (mm)	C (mm)	H (mm)	Ø (mm)	materiale	codice
135	128	30	75	zama	1632.00

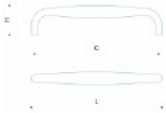

**ART. 1628**

*ART. 1628 · Made in Italy*

L (mm)	C (mm)	H (mm)	Ø (mm)	materiale	codice
170	128	30	100	zama	1628.00
202	160	30	75	zama	1628.03

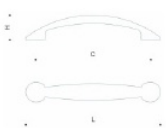



**ART. 1627**

*ART. 1627 · Made in Italy*

L (mm)	C (mm)	H (mm)	Ø (mm)	materiale	codice
168	128	30	155	zama	1627.00

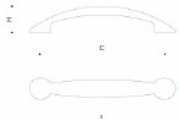

**ART. 1626**

*ART. 1626 · Made in Italy*

L (mm)	C (mm)	H (mm)	Ø (mm)	materiale	codice
224	192	35	280	zama	1626.04

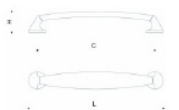



**ART. 1625**

*ART. 1625 · Made in Italy*

L (mm)	C (mm)	H (mm)	Ø (mm)	materiale	codice
98	64	23	45	zama	1625.01
129	96	26	50	zama	1625.02

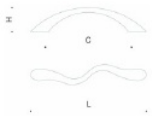

**ART. 1622**

*ART. 1622 · Made in Italy*

L (mm)	C (mm)	H (mm)	Ø (mm)	materiale	codice
148	128	30	135	zama	1622.00

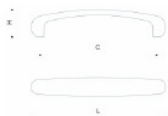



**ART. 1614**

*ART. 1614 · Made in Italy*

L (mm)	C (mm)	H (mm)	Ø (mm)	materiale	codice
204	192	35	170	zama	1614.04
364	352	35	285	zama	1614.09



**ART. 1613**

*ART. 1613 · Made in Italy*

L (mm)	C (mm)	H (mm)	Ø (mm)	materiale	codice
190	128	33,2	190	zama	1613.00

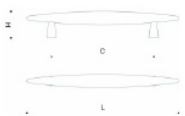



**ART. 1612**

*ART. 1612 · Made in Italy*

L (mm)	C (mm)	H (mm)	Ø (mm)	materiale	codice
126	96	30	120	zama	1612.02
196	160	30	120	zama	1612.03

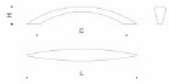

**ART. 1610**

*ART. 1610 · Made in Italy*

L (mm)	C (mm)	H (mm)	Ø (mm)	materiale	codice
190	128	28,7	95	zama	1610.01
117	64	27,5	45	zama	1610.01

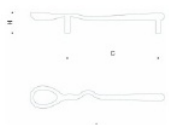



**ART. 1609**

*ART. 1609 · Made in Italy*

L (mm)	C (mm)	H (mm)	Ø (mm)	materiale	codice
118	96	28,5	40	zama	1609.02

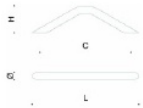

**ART. 1607**

*ART. 1607 · Made in Italy*

L (mm)	C (mm)	H (mm)	Ø (mm)	materiale	codice
162	128	28,5	70	zama	1607.00
125	96	27,6	42	zama	1607.02

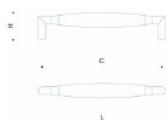



**ART. 1604**

*ART. 1604 · Made in Italy*

L (mm)	C (mm)	H (mm)	Ø (mm)	materiale	codice
43	32	29,7	25	zama	1604.11



**ART. 1603**

*ART. 1603 · Made in Italy*

L (mm)	C (mm)	H (mm)	Ø (mm)	materiale	codice
74	64	30	30	zama	1603.01

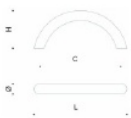



**ART. 1574**

ART. 1574 · Made in Italy

L (mm)	C (mm)	H (mm)	Ø (mm)	materiale	codice
104	96	25,8	50	ferro	1574.02

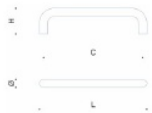

**ART. 1573**

ART. 1573 · Made in Italy

L (mm)	C (mm)	H (mm)	Ø (mm)	materiale	codice
163	128	30,8	85	zama	1573.00
127	96	30,2	70	zama	1573.02
270	224	31,7	140	zama	1573.05

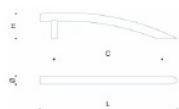



**ART. 1569**

*ART. 1569 · Made in Italy*

L (mm)	C (mm)	H (mm)	Ø (mm)	materiale	codice
164	128	26	95	zama	1569.00

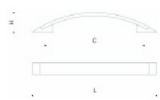

**ART. 1568**

*ART. 1568 · Made in Italy*

L (mm)	C (mm)	H (mm)	Ø (mm)	materiale	codice
172	128	19,5	60	zama	1568.00
172	96	19,5	60	zama	1568.02





**ART. 1567**

ART. 1567 · Made in Italy

L (mm)	C (mm)	H (mm)	Ø (mm)	materiale	codice
172	128	27,5	50	zama	1567.00



**ART. 1563**

ART. 1563 · Made in Italy

L (mm)	C (mm)	H (mm)	Ø (mm)	materiale	codice
77	64	26	40	zama	1563.01
108	96	31	40	zama	1563.02

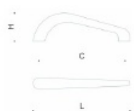

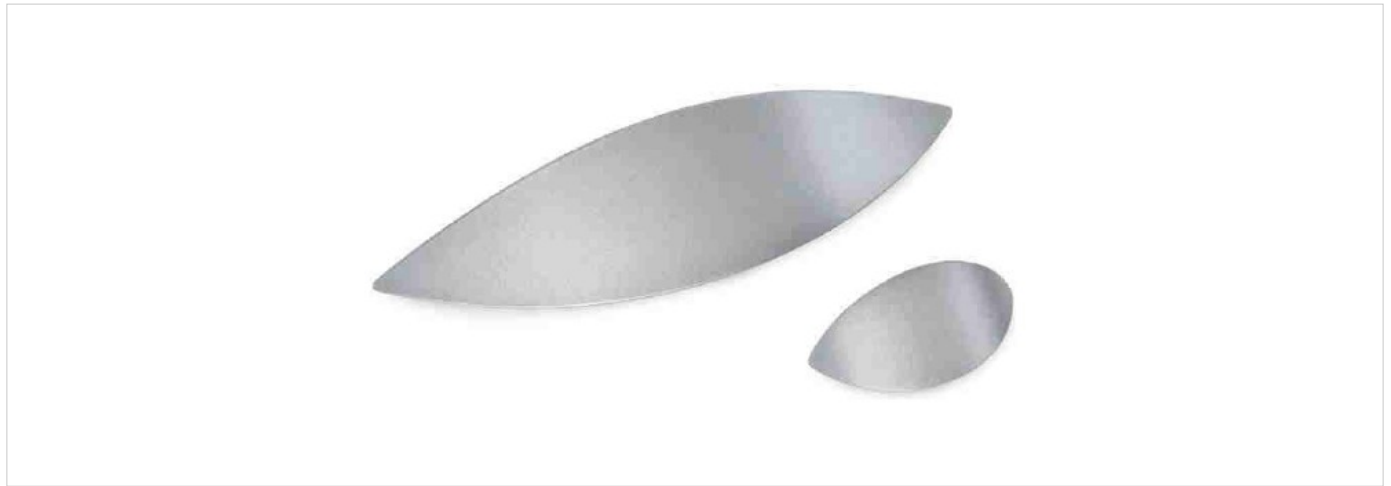

**ART. 1562**

*ART. 1562 · Made in Italy*

L (mm)	C (mm)	H (mm)	Ø (mm)	materiale	codice
137	96	27	50	zama	1562.02
51	32	18	15	zama	1562.11



**ART. 1558**

*ART. 1558 · Made in Italy*

L (mm)	C (mm)	H (mm)	Ø (mm)	materiale	codice
458	448	36	290	ferro	1558.13





**ART. 1541**

ART. 1541 · Made in Italy

L (mm)	C (mm)	H (mm)	Ø (mm)	materiale	codice
151	128	30	75	zama	1541.00
269	224	30	125	zama	1541.05
334	288	30	160	zama	1541.07



**ART. 1540**

ART. 1540 · Made in Italy

L (mm)	C (mm)	H (mm)	Ø (mm)	materiale	codice
200	192	30	90	ferro	1540.04
232	224	30	100	ferro	1540.05





**ART. 1530**

*ART. 1530 · Made in Italy*

L (mm)	C (mm)	H (mm)	Ø (mm)	materiale	codice
—	—	—	—	—	—

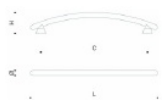

**ART. 1528**

*ART. 1528 · Made in Italy*

L (mm)	C (mm)	H (mm)	Ø (mm)	materiale	codice
152	128	27	30	zama	1528.00

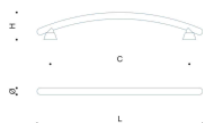



**ART. 1524**

*ART. 1524 · Made in Italy*

L (mm)	C (mm)	H (mm)	Ø (mm)	materiale	codice
72	64	26,5	40	zama	1524.01



**ART. 1522**

*ART. 1522 · Made in Italy*

L (mm)	C (mm)	H (mm)	Ø (mm)	materiale	codice
158	128	29	45	zama	1522.00
80	64	24,5	30	zama	1522.01
125	96	26,5	40	zama	1522.02

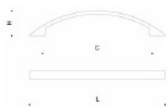



**ART. 1517**

*ART. 1517 · Made in Italy*

L (mm)	C (mm)	H (mm)	Ø (mm)	materiale	codice
79	64	23	30	zama	1517.01

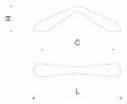

**ART. 1512**

*ART. 1512 · Made in Italy*

L (mm)	C (mm)	H (mm)	Ø (mm)	materiale	codice
—	—	—	—	—	—





**ART. 1503**

*ART. 1503 · Made in Italy*

L (mm)	C (mm)	H (mm)	Ø (mm)	materiale	codice
108	96	25	30	zama	1503.02



**ART. 1501**

*ART. 1501 · Made in Italy*

L (mm)	C (mm)	H (mm)	Ø (mm)	materiale	codice
145	128	24	45	zama	1501.00

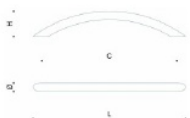

---

# MANIGLIE MODULARI

Modular Handles · Made in Italy

---

BORSANI



**ART. 1951**

*ART. 1951 · Made in Italy*

L (mm)	C (mm)	H (mm)	Ø (mm)	materiale	codice
—	—	42	18	ferro	1951



**ART. 1942**

*ART. 1942 · Made in Italy*

L (mm)	C (mm)	H (mm)	Ø (mm)	materiale	codice
—	—	28	—	alluminio	1942





**ART. 1938**

*ART. 1938 · Made in Italy*

L (mm)	C (mm)	H (mm)	Ø (mm)	materiale	codice
—	—	23	—	alluminio	1938

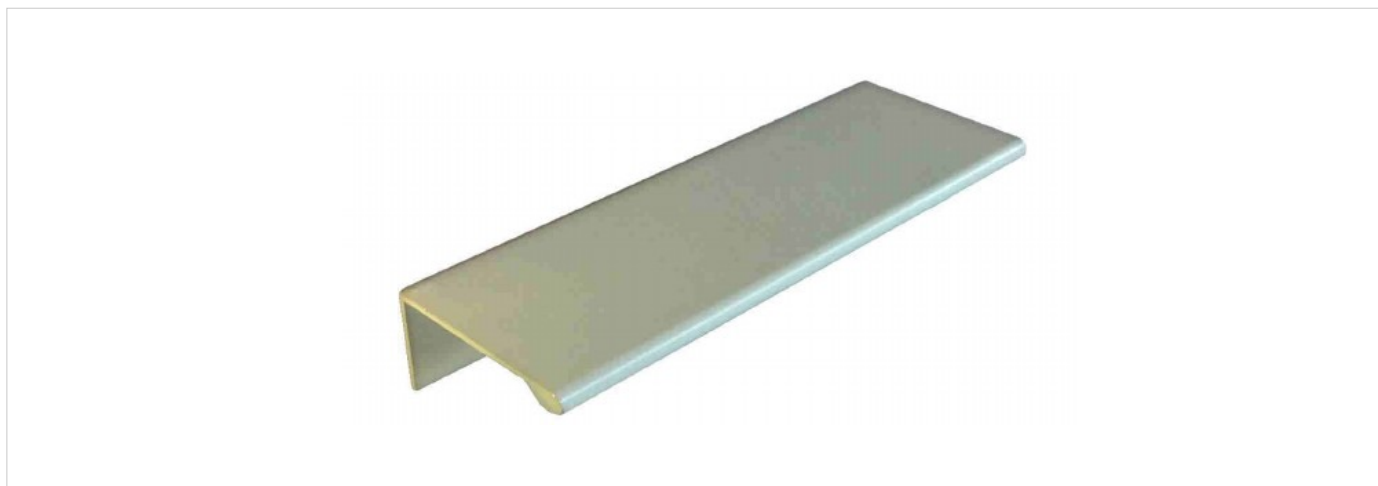

**ART. 1935**

*ART. 1935 · Made in Italy*

L (mm)	C (mm)	H (mm)	Ø (mm)	materiale	codice
—	—	20	—	alluminio	1935.150

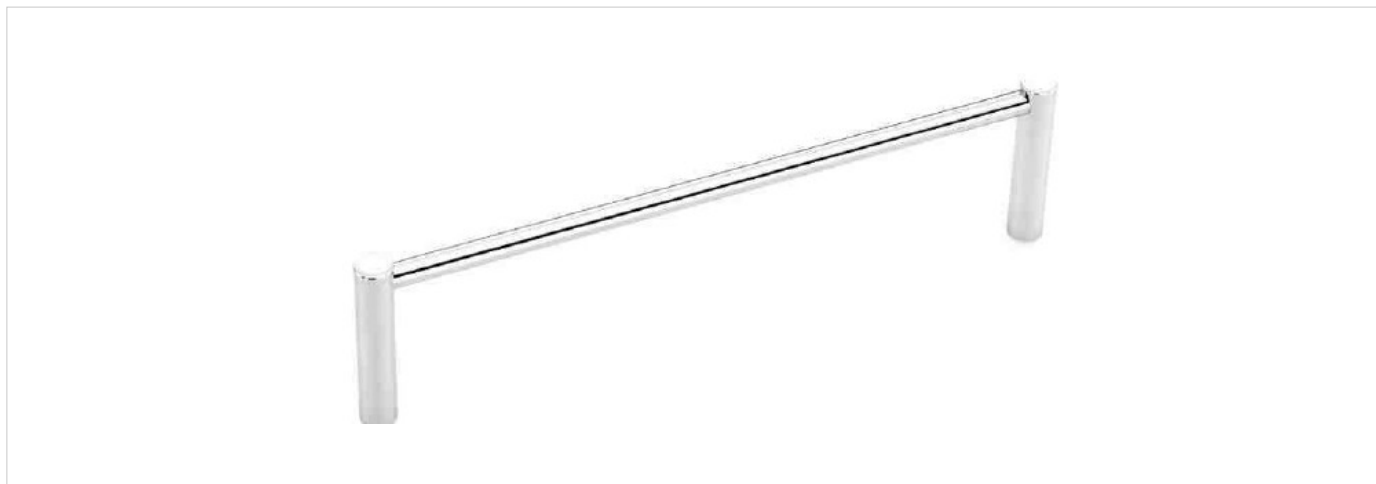

**ART. 1915**

ART. 1915 - Made in Italy

L (mm)	C (mm)	H (mm)	Ø (mm)	materiale	codice
—	—	60	8	acciaio+ferro	1915

**ART. 1914**

ART. 1914 - Made in Italy

L (mm)	C (mm)	H (mm)	Ø (mm)	materiale	codice
—	—	32	12	acciaio inox	1914



## MANIGLIE MODULARI

Modular Handles - Made in Italy



### ART. 1913

ART. 1913 - Made in Italy

L (mm)	C (mm)	H (mm)	Ø (mm)	materiale	codice
—	—	—	—	zama+inox+PA	—



### ART. 1875

ART. 1875 - Made in Italy

L (mm)	C (mm)	H (mm)	Ø (mm)	materiale	codice
—	—	18	—	alluminio	1875

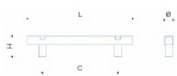

**ART. 1851**

ART. 1851 - Made in Italy

L (mm)	C (mm)	H (mm)	Ø (mm)	materiale	codice
—	—	—	—	alluminio	1851

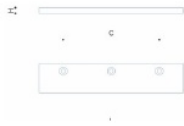
**ART. 1849**

ART. 1849 - Made in Italy

L (mm)	C (mm)	H (mm)	Ø (mm)	materiale	codice
—	—	15	—	alluminio+PE	1849



**ART. 1848**

ART. 1848 - Made in Italy

L (mm)	C (mm)	H (mm)	Ø (mm)	materiale	codice
—	—	30	—	alluminio	1848

**ART. 1842**

ART. 1842 - Made in Italy

L (mm)	C (mm)	H (mm)	Ø (mm)	materiale	codice
—	—	25	—	alluminio	1842



**ART. 1834***ART. 1834 - Made in Italy*

L (mm)	C (mm)	H (mm)	Ø (mm)	materiale	codice
—	—	34	14	zama+alluminio	1834

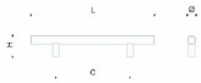
**ART. 1833***ART. 1833 - Made in Italy*

L (mm)	C (mm)	H (mm)	Ø (mm)	materiale	codice
—	—	20	—	alluminio	1833

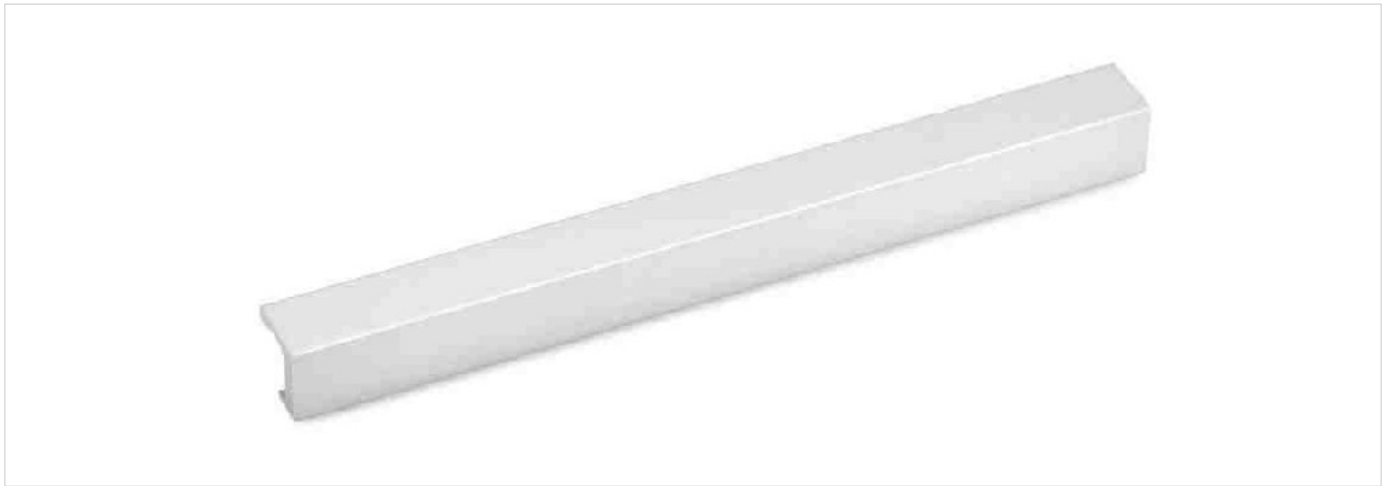

**ART. 1829**

ART. 1829 - Made in Italy

L (mm)	C (mm)	H (mm)	Ø (mm)	materiale	codice
—	—	23	—	alluminio	1829

**ART. 1826**

ART. 1826 - Made in Italy

L (mm)	C (mm)	H (mm)	Ø (mm)	materiale	codice
—	—	33	12	zama+ferro	1826



**ART. 1825***ART. 1825 - Made in Italy*

L (mm)	C (mm)	H (mm)	Ø (mm)	materiale	codice
—	—	32	12	zama+alluminio	1825

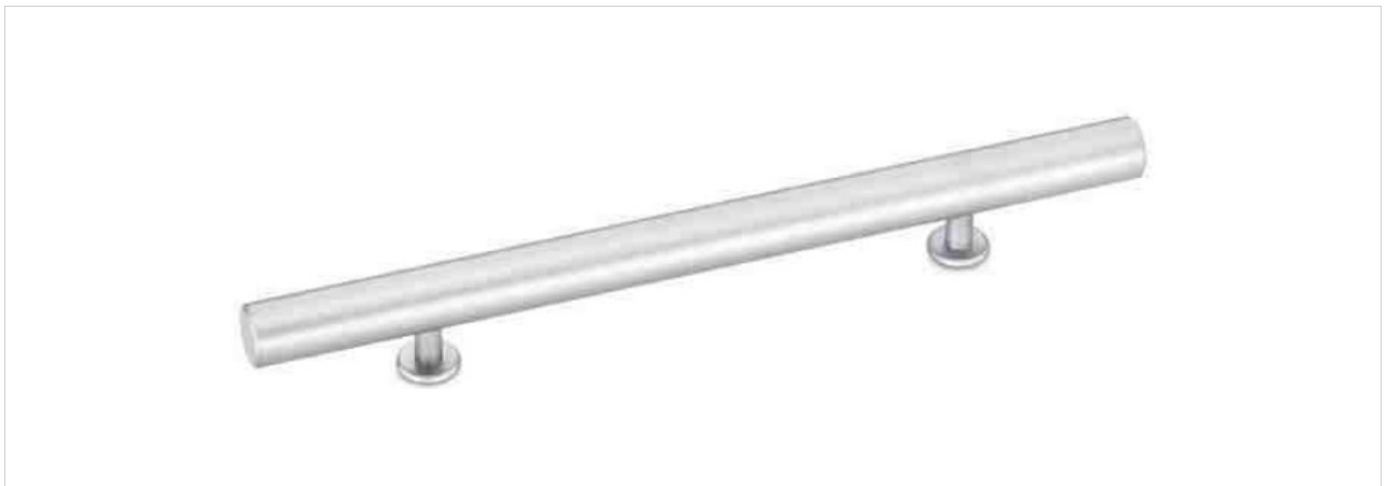
**ART. 1814***ART. 1814 - Made in Italy*

L (mm)	C (mm)	H (mm)	Ø (mm)	materiale	codice
—	—	18	—	alluminio	1814





**ART. 1809**

*ART. 1809 - Made in Italy*

L (mm)	C (mm)	H (mm)	Ø (mm)	materiale	codice
—	—	36	15	zama+ferro	1809



**ART. 1808**

*ART. 1808 - Made in Italy*

L (mm)	C (mm)	H (mm)	Ø (mm)	materiale	codice
—	—	36	15	zama+acciaio	1808

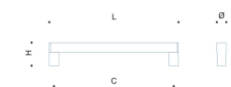

**ART. 1807C***ART. 1807C - Made in Italy*

L (mm)	C (mm)	H (mm)	Ø (mm)	materiale	codice
—	—	58	12	zama+ferro	1807C

**ART. 1807***ART. 1807 - Made in Italy*

L (mm)	C (mm)	H (mm)	Ø (mm)	materiale	codice
—	—	58	12	zama+ferro	1807



**ART. 1801***ART. 1801 - Made in Italy*

L (mm)	C (mm)	H (mm)	Ø (mm)	materiale	codice
—	—	57	—	zama+alluminio	1801

**ART. 1781***ART. 1781 - Made in Italy*

L (mm)	C (mm)	H (mm)	Ø (mm)	materiale	codice
—	—	32	12	acciaio inox	1781



**ART. 1777**

ART. 1777 · Made in Italy

L (mm)	C (mm)	H (mm)	Ø (mm)	materiale	codice
—	—	34	14	zama+ferro	1777

**ART. 1764**

ART. 1764 · Made in Italy

L (mm)	C (mm)	H (mm)	Ø (mm)	materiale	codice
—	—	35	—	alluminio	1764





**ART. 1759**

*ART. 1759 - Made in Italy*

L (mm)	C (mm)	H (mm)	Ø (mm)	materiale	codice
—	—	29	12	zama+ferro	1759



**ART. 1717**

*ART. 1717 - Made in Italy*

L (mm)	C (mm)	H (mm)	Ø (mm)	materiale	codice
—	—	42	12	zama+ferro	1717





**ART. 1684**

*ART. 1684 · Made in Italy*

L (mm)	C (mm)	H (mm)	Ø (mm)	materiale	codice
—	—	30	12	zama+ferro	1684

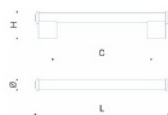

**ART. 1655**

*ART. 1655 · Made in Italy*

L (mm)	C (mm)	H (mm)	Ø (mm)	materiale	codice
—	—	32	12	zama+ferro	1655





**ART. 1639**

*ART. 1639 - Made in Italy*

L (mm)	C (mm)	H (mm)	Ø (mm)	materiale	codice
—	—	28	10	zama+ferro	1639

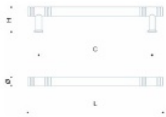

**ART. 1629**

*ART. 1629 - Made in Italy*

L (mm)	C (mm)	H (mm)	Ø (mm)	materiale	codice
—	—	25	10	zama+ferro	1629

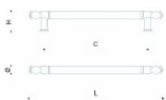

**ART. 1577***ART. 1577 - Made in Italy*

L (mm)	C (mm)	H (mm)	Ø (mm)	materiale	codice
196	128	32	12	zama+ferro	1577.00

**ART. 1575C***ART. 1575C - Made in Italy*

L (mm)	C (mm)	H (mm)	Ø (mm)	materiale	codice
443	320	32	12	zama+ferro	1575C





**ART. 1535**

*ART. 1535 - Made in Italy*

L (mm)	C (mm)	H (mm)	Ø (mm)	materiale	codice
—	—	30	14	zama+ferro	1535

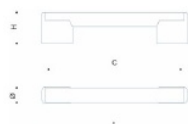

**ART. 1521**

*ART. 1521 - Made in Italy*

L (mm)	C (mm)	H (mm)	Ø (mm)	materiale	codice
—	—	32	12	zama+ferro	1521



## MANIGLIE MODULARI

Modular Handles · Made in Italy



### ART. 1516

ART. 1516 · Made in Italy

L (mm)	C (mm)	H (mm)	Ø (mm)	materiale	codice
—	—	30	12	zama+ferro	1516



---

# POMOLI

Knobs · Made in Italy

---

BORSANI

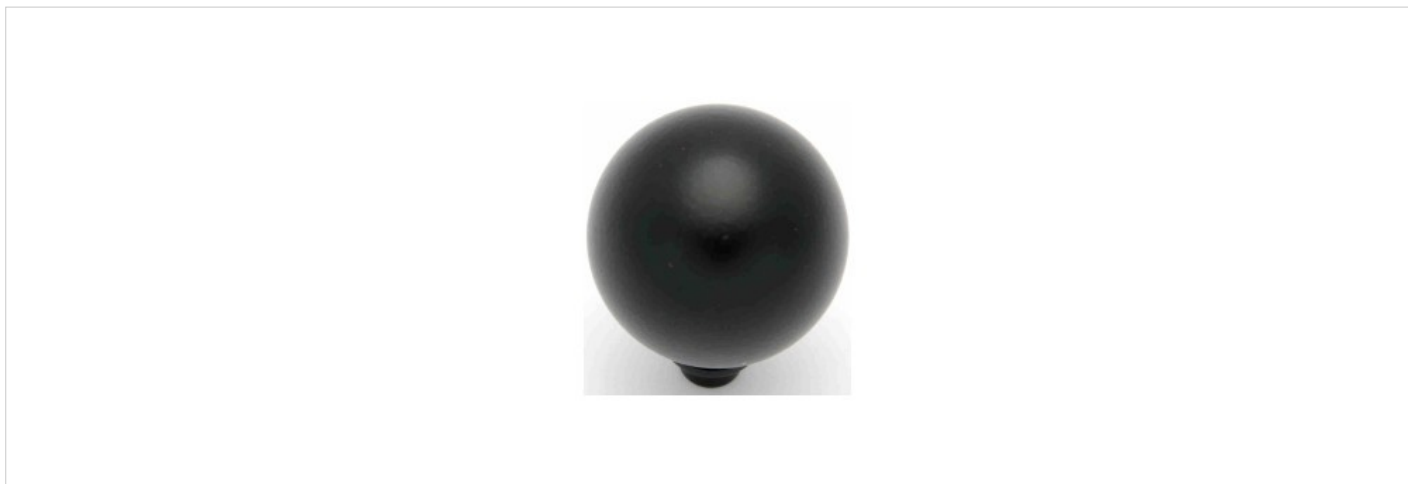

**ART. 1936**

*ART. 1936 · Made in Italy*

L (mm)	C (mm)	H (mm)	Ø (mm)	materiale	codice
54,5	39	66	—	ferro	1936

• Ø • • H •



**ART. 1921**

*ART. 1921 · Made in Italy*

L (mm)	C (mm)	H (mm)	Ø (mm)	materiale	codice
26	34,5	66	—	zama	1921

• Ø • • H •





**ART. 1917**

ART. 1917 · Made in Italy

L (mm)	C (mm)	H (mm)	Ø (mm)	materiale	codice
60	16	30	35	zama	1917



**ART. 1878**

ART. 1878 · Made in Italy

L (mm)	C (mm)	H (mm)	Ø (mm)	materiale	codice
30	34,5	13	—	legno	1878





**ART. 1869**

ART. 1869 · Made in Italy

L (mm)	C (mm)	H (mm)	Ø (mm)	materiale	codice
28,8	23	27	—	zama	1869



**ART. 1860**

ART. 1860 · Made in Italy

L (mm)	C (mm)	H (mm)	Ø (mm)	materiale	codice
28	35	25	—	zama+legno	1860





**ART. 1844**

*ART. 1844 · Made in Italy*

L (mm)	C (mm)	H (mm)	Ø (mm)	materiale	codice
26	38	—	—	legno	1844



**ART. 1841**

*ART. 1841 · Made in Italy*

L (mm)	C (mm)	H (mm)	Ø (mm)	materiale	codice
27	18	18	—	zama	1841





**ART. 1840**

*ART. 1840 · Made in Italy*

L (mm)	C (mm)	H (mm)	Ø (mm)	materiale	codice
26	32	40	—	zama	1840



**ART. 1838**

*ART. 1838 · Made in Italy*

L (mm)	C (mm)	H (mm)	Ø (mm)	materiale	codice
24,5	15	22	—	zama	1883





**ART. 1823**

*ART. 1823 · Made in Italy*

L (mm)	C (mm)	H (mm)	Ø (mm)	materiale	codice
29	34	80	—	zama	1823



**ART. 1817**

*ART. 1817 · Made in Italy*

L (mm)	C (mm)	H (mm)	Ø (mm)	materiale	codice
64	40	—	—	zama	1818





**ART. 1816**

*ART. 1816 · Made in Italy*

L (mm)	C (mm)	H (mm)	Ø (mm)	materiale	codice
8	17	8	—	zama	1816



**ART. 1813**

*ART. 1813 · Made in Italy*

L (mm)	C (mm)	H (mm)	Ø (mm)	materiale	codice
44	23	40	—	zama	1813





**ART. 1806**

ART. 1806 · Made in Italy

L (mm)	C (mm)	H (mm)	Ø (mm)	materiale	codice
27,5	44	90	—	zama	1806



**ART. 1792**

ART. 1792 · Made in Italy

L (mm)	C (mm)	H (mm)	Ø (mm)	materiale	codice
33	28	25	—	zama+legno	1792





**ART. 1787**

ART. 1787 · Made in Italy

L (mm)	C (mm)	H (mm)	Ø (mm)	materiale	codice
32,5	38	105	—	zama+ottone	1787



**ART. 1786**

ART. 1786 · Made in Italy

L (mm)	C (mm)	H (mm)	Ø (mm)	materiale	codice
50	32	30,5	115	zama	1786

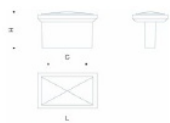



**ART. 1756**

*ART. 1756 · Made in Italy*

L (mm)	C (mm)	H (mm)	Ø (mm)	materiale	codice
29	19	40	—	zama	1756



**ART. 1753**

*ART. 1753 · Made in Italy*

L (mm)	C (mm)	H (mm)	Ø (mm)	materiale	codice
22,5	28	52	—	zama	1753



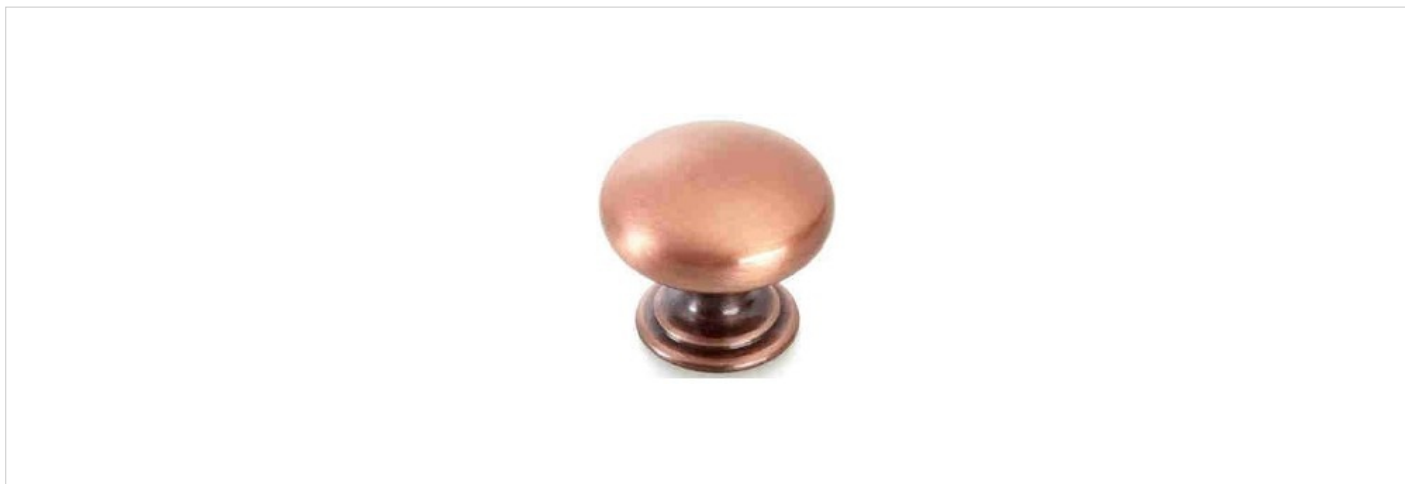

**ART. 1742**

*ART. 1742 · Made in Italy*

L (mm)	C (mm)	H (mm)	Ø (mm)	materiale	codice
24	10	10	—	ottone+PMMA	1742



**ART. 1740**

*ART. 1740 · Made in Italy*

L (mm)	C (mm)	H (mm)	Ø (mm)	materiale	codice
28	33	75	—	zama	1740





**ART. 1739**

ART. 1739 · Made in Italy

L (mm)	C (mm)	H (mm)	Ø (mm)	materiale	codice
22,5	28,5	45	—	zama	1739



**ART. 1738**

ART. 1738 · Made in Italy

L (mm)	C (mm)	H (mm)	Ø (mm)	materiale	codice
72	34	75	—	zama	1738





**ART. 1733**

*ART. 1733 · Made in Italy*

L (mm)	C (mm)	H (mm)	Ø (mm)	materiale	codice
25	29	4	—	zama	1733



**ART. 1730**

*ART. 1730 · Made in Italy*

L (mm)	C (mm)	H (mm)	Ø (mm)	materiale	codice
27	27	20	—	ottone+PMMA	1730





**ART. 1719**

*ART. 1719 · Made in Italy*

L (mm)	C (mm)	H (mm)	Ø (mm)	materiale	codice
22	23	58	—	zama	1719



**ART. 1714**

*ART. 1714 · Made in Italy*

L (mm)	C (mm)	H (mm)	Ø (mm)	materiale	codice
40	30	42	—	zama	1714





**ART. 1710**

*ART. 1710 · Made in Italy*

L (mm)	C (mm)	H (mm)	Ø (mm)	materiale	codice
27	19	15	—	ottone+PMMA	1710

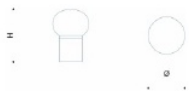

**ART. 1700**

*ART. 1700 · Made in Italy*

L (mm)	C (mm)	H (mm)	Ø (mm)	materiale	codice
15,5	29	5	—	ottone+PMMA	1700

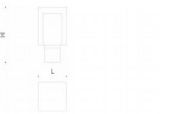

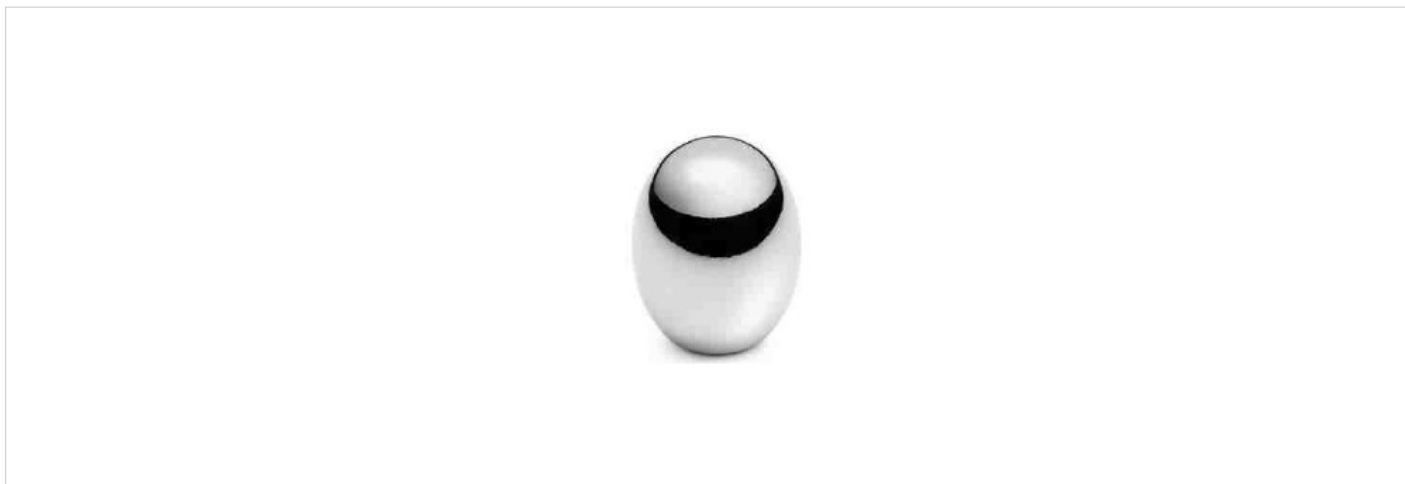

**ART. 1694**

*ART. 1694 · Made in Italy*

L (mm)	C (mm)	H (mm)	Ø (mm)	materiale	codice
53	17	20	—	zama	1694



**ART. 1693**

*ART. 1693 · Made in Italy*

L (mm)	C (mm)	H (mm)	Ø (mm)	materiale	codice
30,8	24,4	65	—	zama	1693





**ART. 1689**

*ART. 1689 · Made in Italy*

L (mm)	C (mm)	H (mm)	Ø (mm)	materiale	codice
28,5	17	30	—	zama	1689



**ART. 1688**

*ART. 1688 · Made in Italy*

L (mm)	C (mm)	H (mm)	Ø (mm)	materiale	codice
25,5	32	7	—	legno	1688





**ART. 1676**

*ART. 1676 · Made in Italy*

L (mm)	C (mm)	H (mm)	Ø (mm)	materiale	codice
24,5	28	45	—	zama	1676



**ART. 1663**

*ART. 1663 · Made in Italy*

L (mm)	C (mm)	H (mm)	Ø (mm)	materiale	codice
29	34	15	—	legno	1663





**ART. 1660**

*ART. 1660 · Made in Italy*

L (mm)	C (mm)	H (mm)	Ø (mm)	materiale	codice
23	35	45	—	zama	1660



**ART. 1648**

*ART. 1648 · Made in Italy*

L (mm)	C (mm)	H (mm)	Ø (mm)	materiale	codice
22	22	10	—	ottone+PMMA	1648





**ART. 1643**

ART. 1643 · Made in Italy

L (mm)	C (mm)	H (mm)	Ø (mm)	materiale	codice
45,5	32	21,3	45	zama	1643



**ART. 1641**

ART. 1641 · Made in Italy

L (mm)	C (mm)	H (mm)	Ø (mm)	materiale	codice
21,4	28	40	—	zama	1641





**ART. 1638**

ART. 1638 · Made in Italy

L (mm)	C (mm)	H (mm)	Ø (mm)	materiale	codice
33,5	34	25	—	zama+legno	1638



**ART. 1637**

ART. 1637 · Made in Italy

L (mm)	C (mm)	H (mm)	Ø (mm)	materiale	codice
24,6	29	75	—	zama+ferro	1637





**ART. 1624**

ART. 1624 · Made in Italy

L (mm)	C (mm)	H (mm)	Ø (mm)	materiale	codice
21,7	37	40	—	zama	1624



**ART. 1623**

ART. 1623 · Made in Italy

L (mm)	C (mm)	H (mm)	Ø (mm)	materiale	codice
24,7	33	45	—	zama	1623





**ART. 1619**

*ART. 1619 · Made in Italy*

L (mm)	C (mm)	H (mm)	Ø (mm)	materiale	codice
27,5	26	65	—	zama	1619



**ART. 1618**

*ART. 1618 · Made in Italy*

L (mm)	C (mm)	H (mm)	Ø (mm)	materiale	codice
10,5	35	10	—	zama	1618





**ART. 1611**

*ART. 1611 · Made in Italy*

L (mm)	C (mm)	H (mm)	Ø (mm)	materiale	codice
2	30,5	22	91	zama	1611



**ART. 1601**

*ART. 1601 · Made in Italy*

L (mm)	C (mm)	H (mm)	Ø (mm)	materiale	codice
30,5	45	110	—	zama	1601

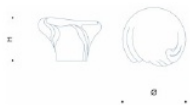



**ART. 1581**

ART. 1581 · Made in Italy

L (mm)	C (mm)	H (mm)	Ø (mm)	materiale	codice
30	34,5	120	—	zama	1581C



**ART. 1572**

ART. 1572 · Made in Italy

L (mm)	C (mm)	H (mm)	Ø (mm)	materiale	codice
22	35	—	—	zama	1572





**ART. 1564**

*ART. 1564 · Made in Italy*

L (mm)	C (mm)	H (mm)	Ø (mm)	materiale	codice
30	34	80	—	zama+ottone	1564



**ART. 1560**

*ART. 1560 · Made in Italy*

L (mm)	C (mm)	H (mm)	Ø (mm)	materiale	codice
24,5	27	25	—	zama	1560





**ART. 1551**

ART. 1551 · Made in Italy

L (mm)	C (mm)	H (mm)	Ø (mm)	materiale	codice
48	32	22	35	zama	1551

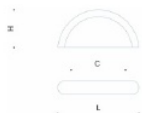

**ART. 1544**

ART. 1544 · Made in Italy

L (mm)	C (mm)	H (mm)	Ø (mm)	materiale	codice
30	2	70	—	zama+ottone	1544





**ART. 1534**

ART. 1534 · Made in Italy

L (mm)	C (mm)	H (mm)	Ø (mm)	materiale	codice
25	18	35	—	zama	1534

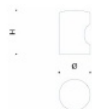

**ART. 1525**

ART. 1525 · Made in Italy

L (mm)	C (mm)	H (mm)	Ø (mm)	materiale	codice
27,5	34	45	—	zama+PMMA	1525





**ART. 1523**

*ART. 1523 · Made in Italy*

L (mm)	C (mm)	H (mm)	Ø (mm)	materiale	codice
24	31,5	70	—	zama	1523



**ART. 1514**

*ART. 1514 · Made in Italy*

L (mm)	C (mm)	H (mm)	Ø (mm)	materiale	codice
25,5	25	25	—	zama+PMMA	1514





**ART. 1508**

*ART. 1508 · Made in Italy*

L (mm)	C (mm)	H (mm)	Ø (mm)	materiale	codice
27,5	21,5	21	92	zama	1508



**ART. 1507**

*ART. 1507 · Made in Italy*

L (mm)	C (mm)	H (mm)	Ø (mm)	materiale	codice
25,5	25,5	27	90	zama	1507



---

# ARTICOLI TECNICI

Technical Articles · Made in Italy

---

BORSANI

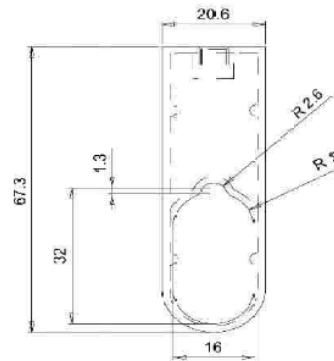
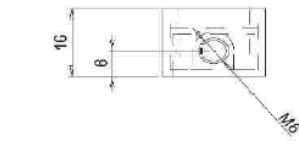
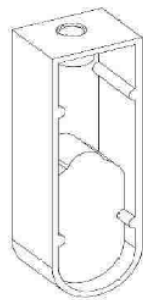
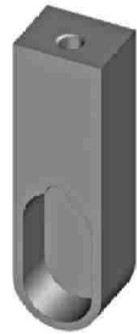

**ART. 1230.00**

Materiale: Zama

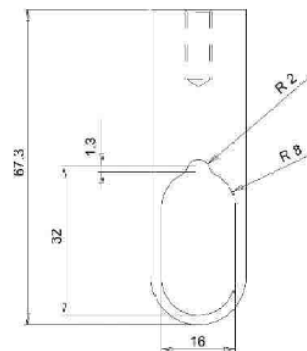
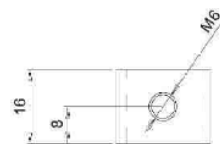
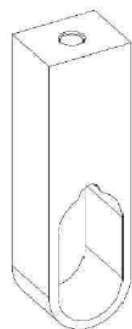

**ART. 1231.00**

Materiale: Zama

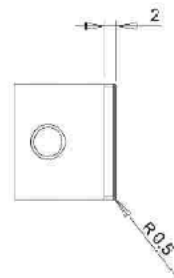
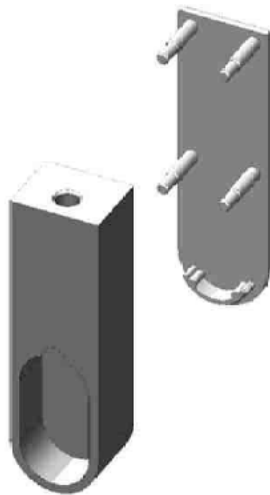

**ART. tapx1230**

Materiale: ABS

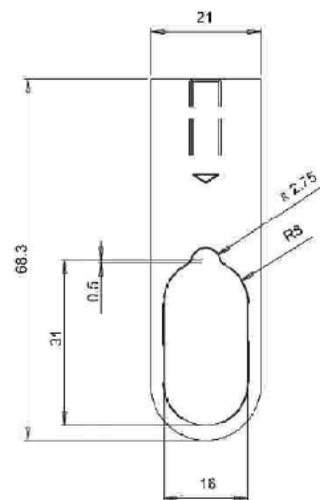
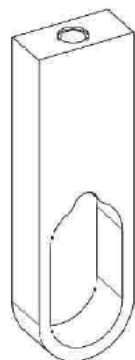
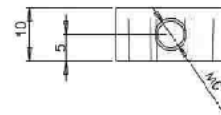

**ART. 1231.01**

Materiale: Zama

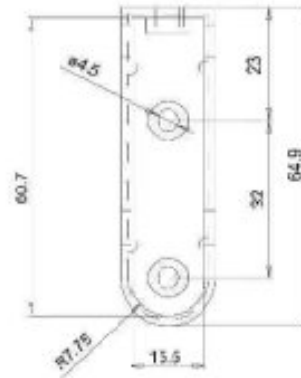
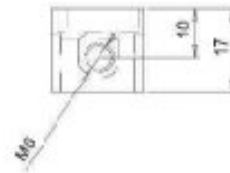
**ART. 1417.00**

Materiale: Zama

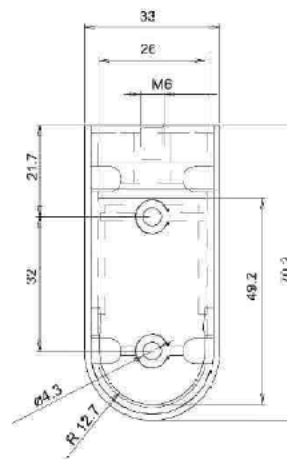
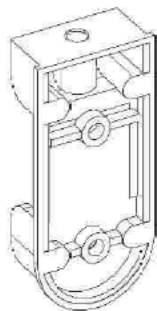
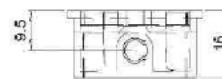
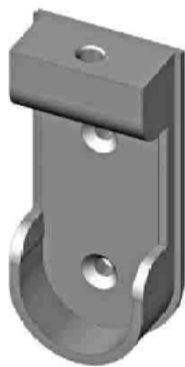
**ART. 1431.00**

Materiale: Zama

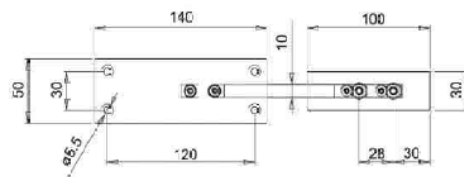
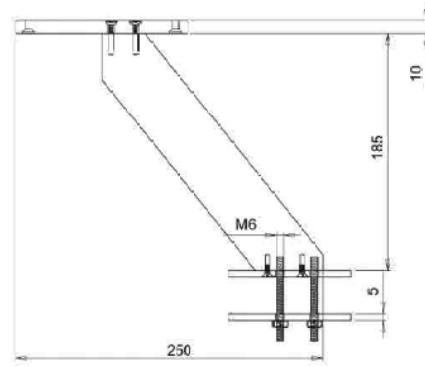

**ART. 1221.00**

Materiale: Alluminio / ferro

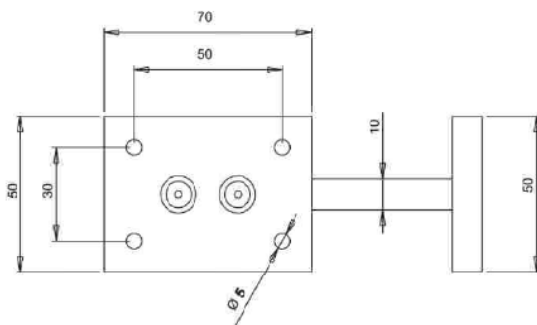
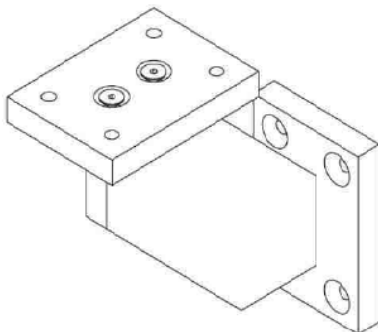
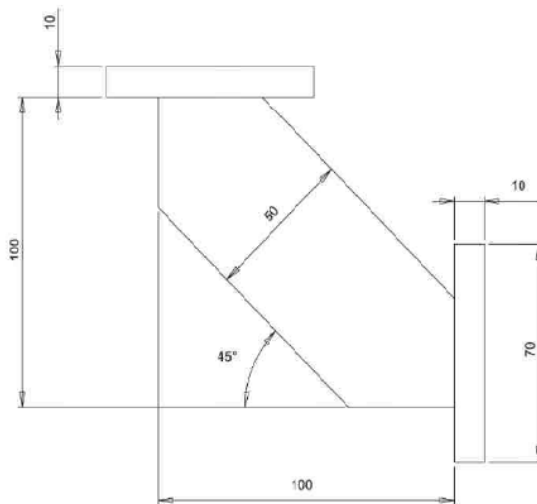
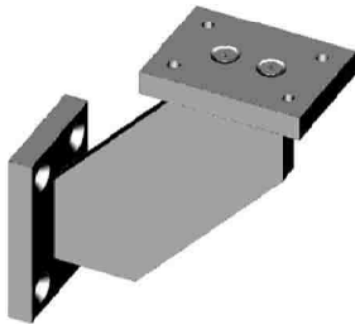

**ART. 1281.00**

Materiale: Alluminio / ferro

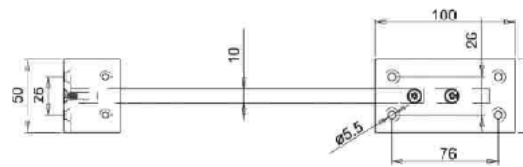
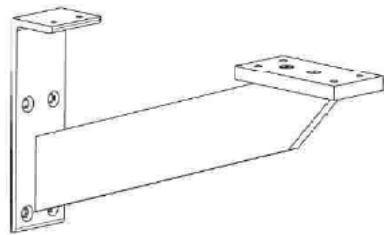
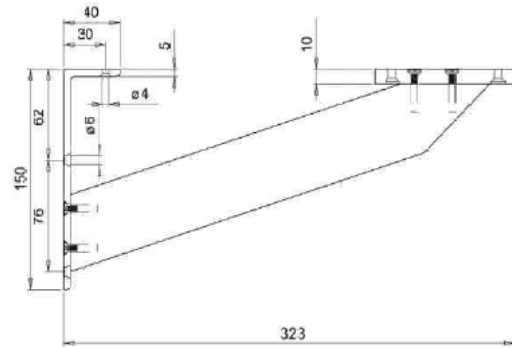
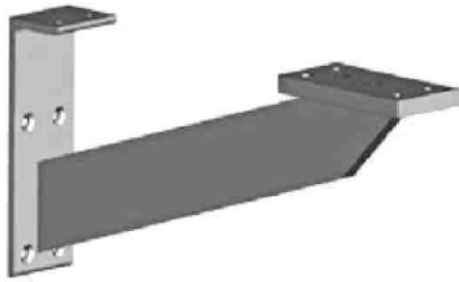

**ART. 1222.00**

Materiale: Alluminio / ferro

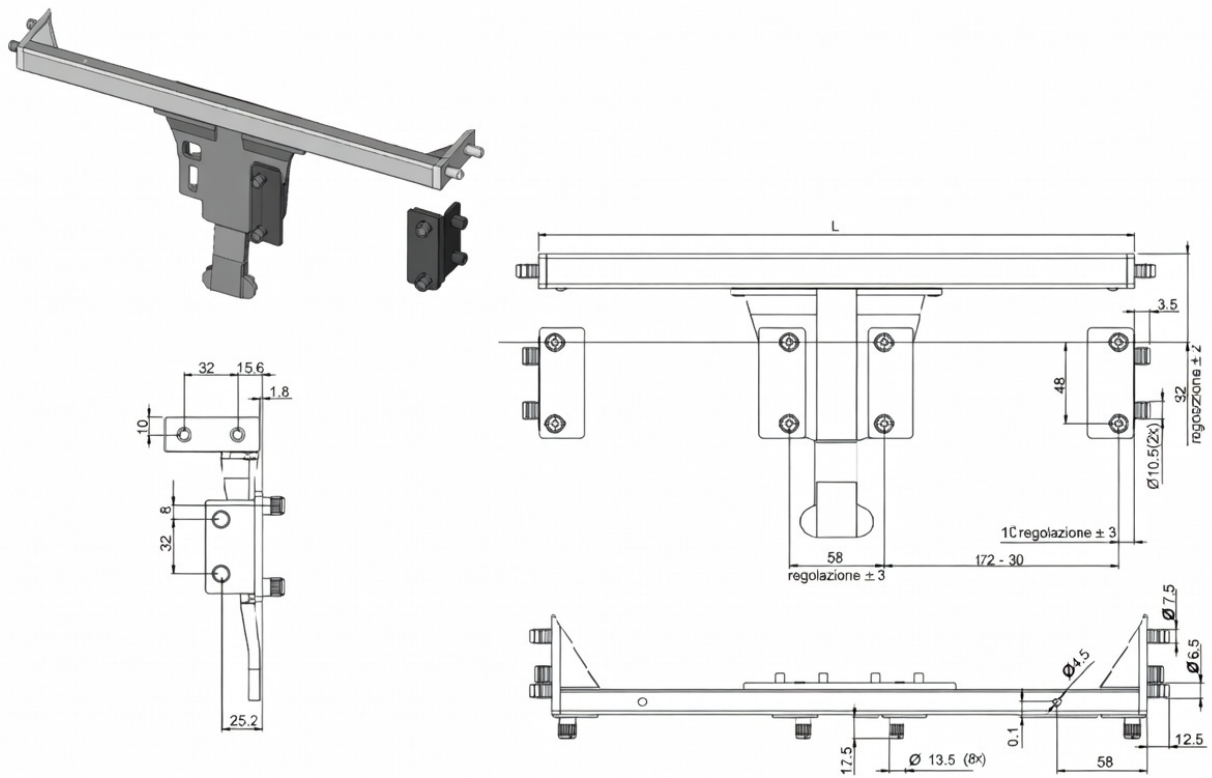

**ART. 1468**

Materiale: Ferro / PA

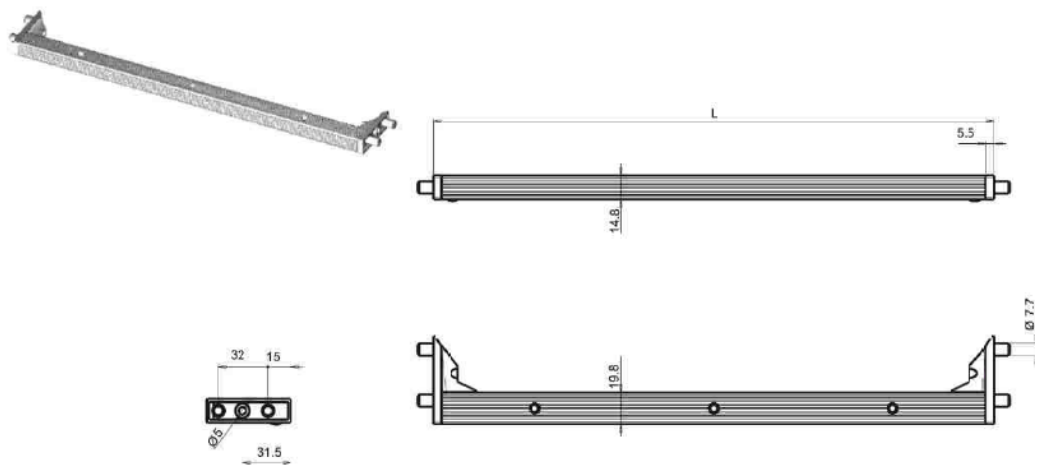

**ART. 1477**

Materiale: Alluminio / PA

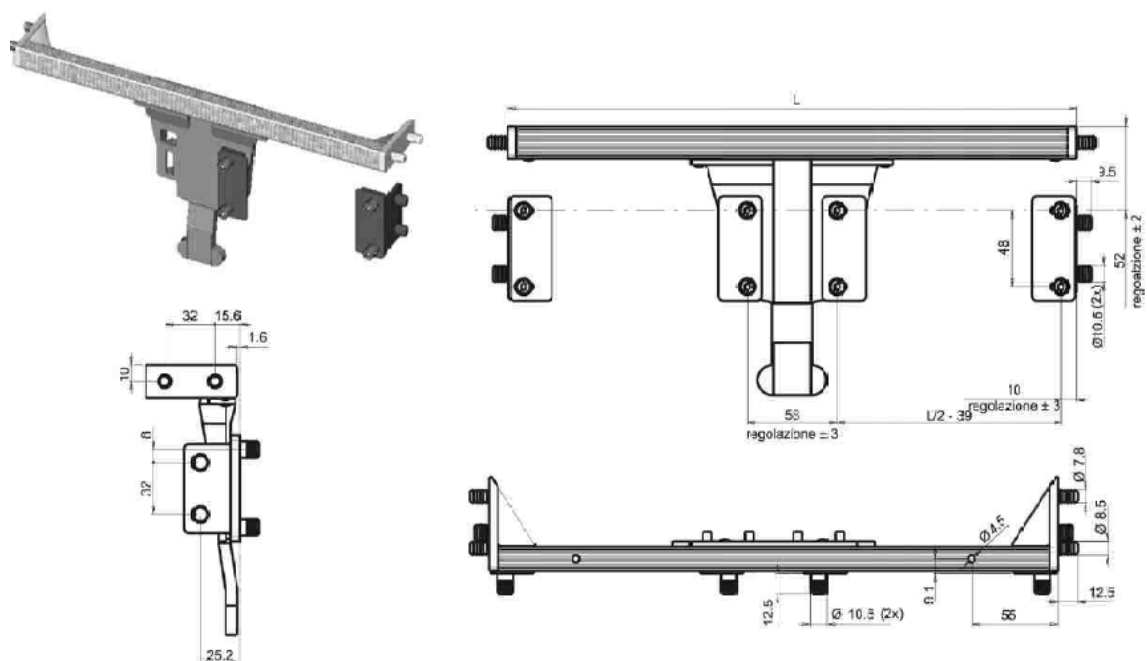

**ART. 1476**

Materiale: Alluminio / PA

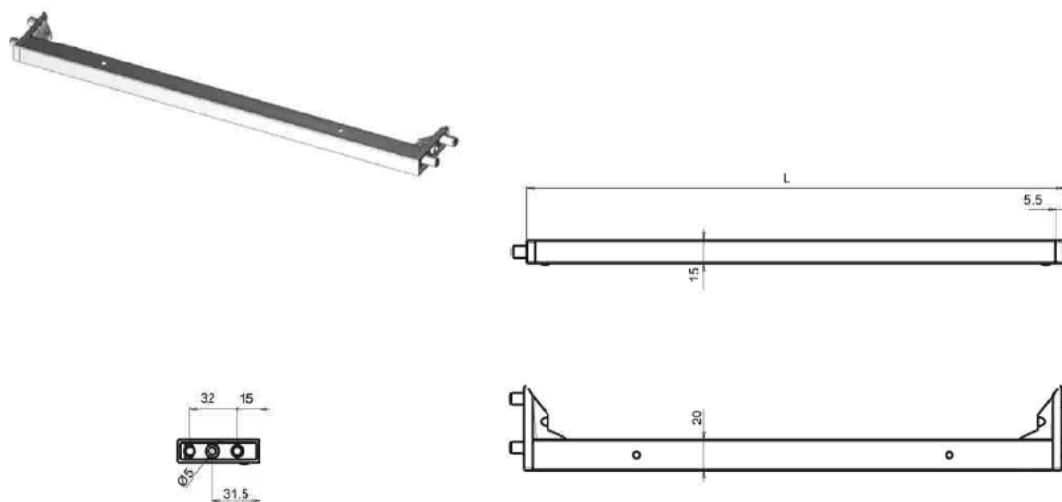

**ART. 1480**

Materiale: Ferro / PS

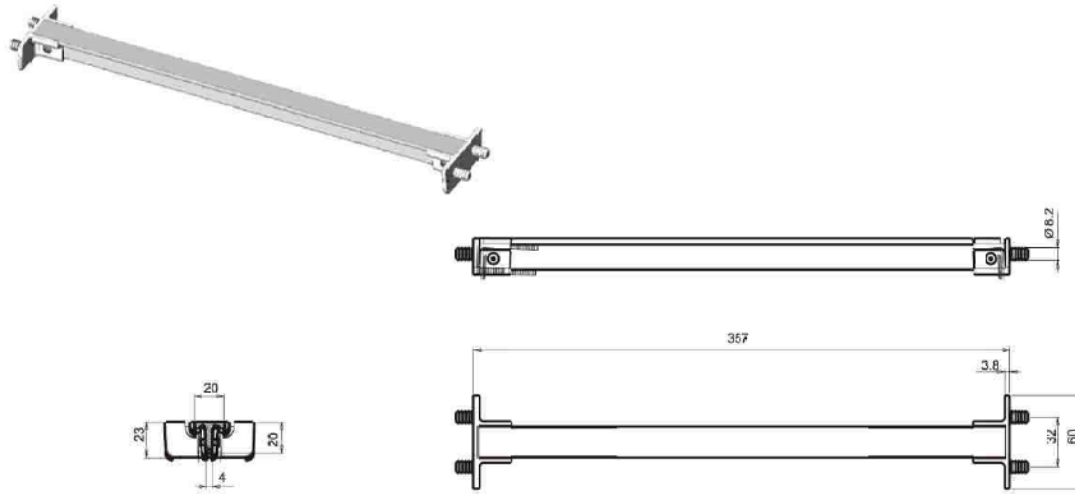

**ART. 1489**

Materiale: Ferro / PS

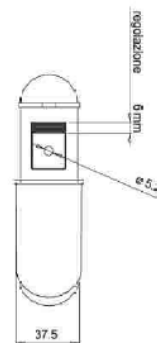
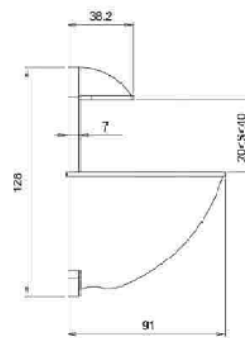
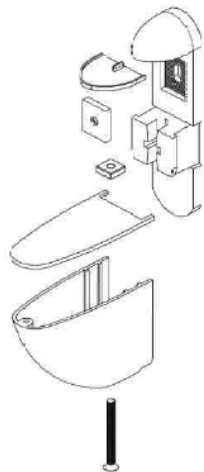

**ART. 1204.00**

Materiale: Zama / PE / ferro

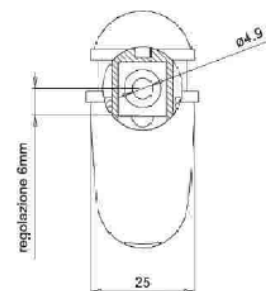
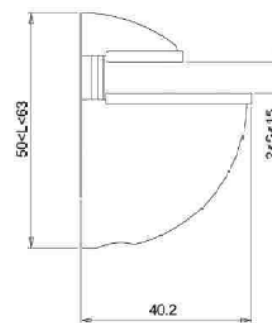
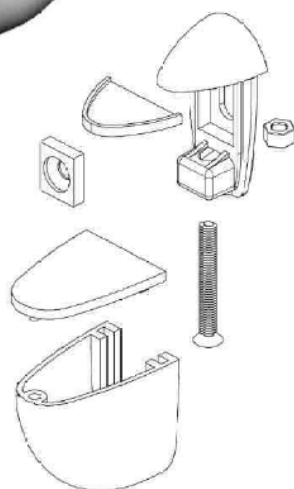

**ART. 1218.00**

Materiale: Zama / PE / ferro

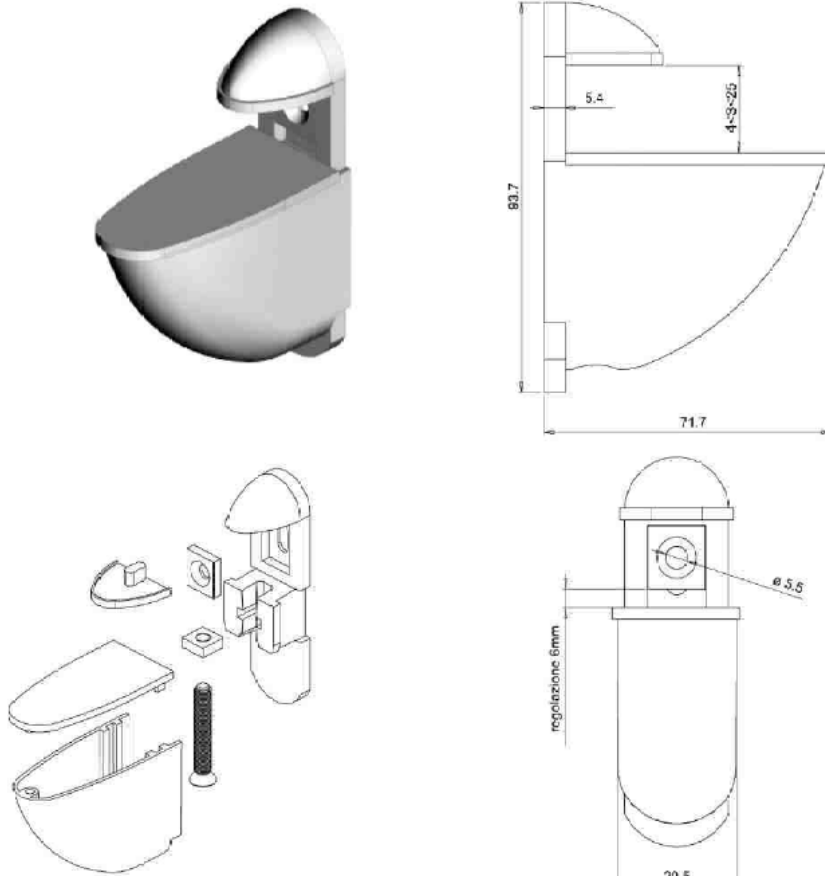

**ART. 1205.00**

Materiale: Zama / PE / ferro

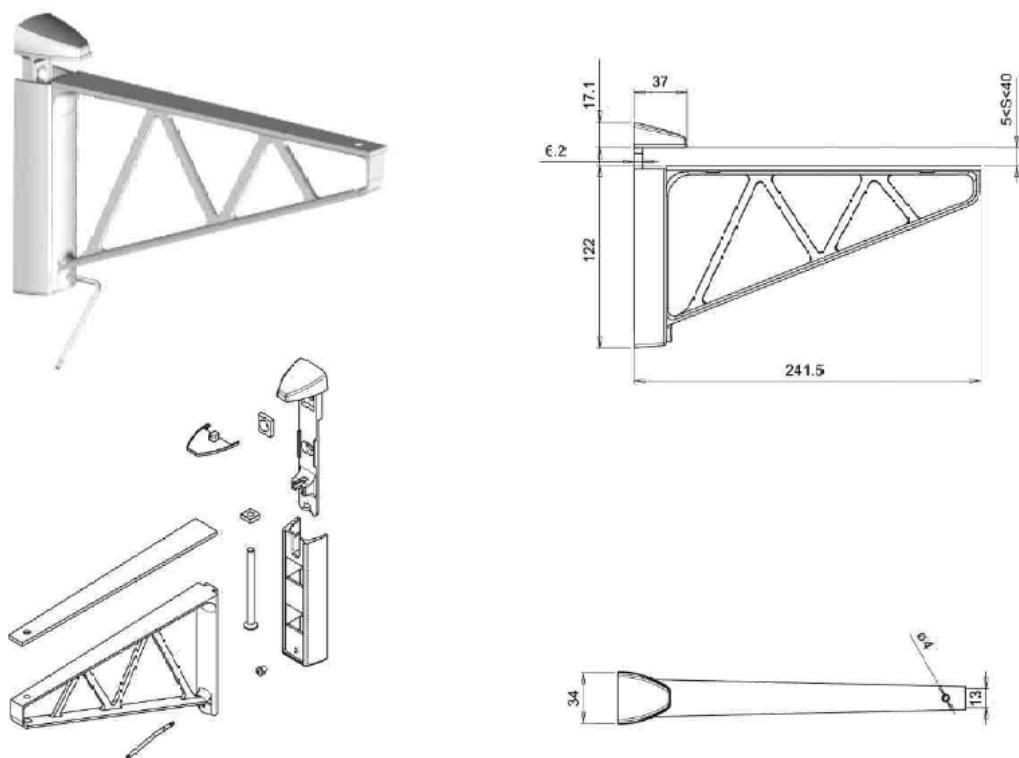

**ART. 1235.01**

Materiale: Zama / PE / ferro

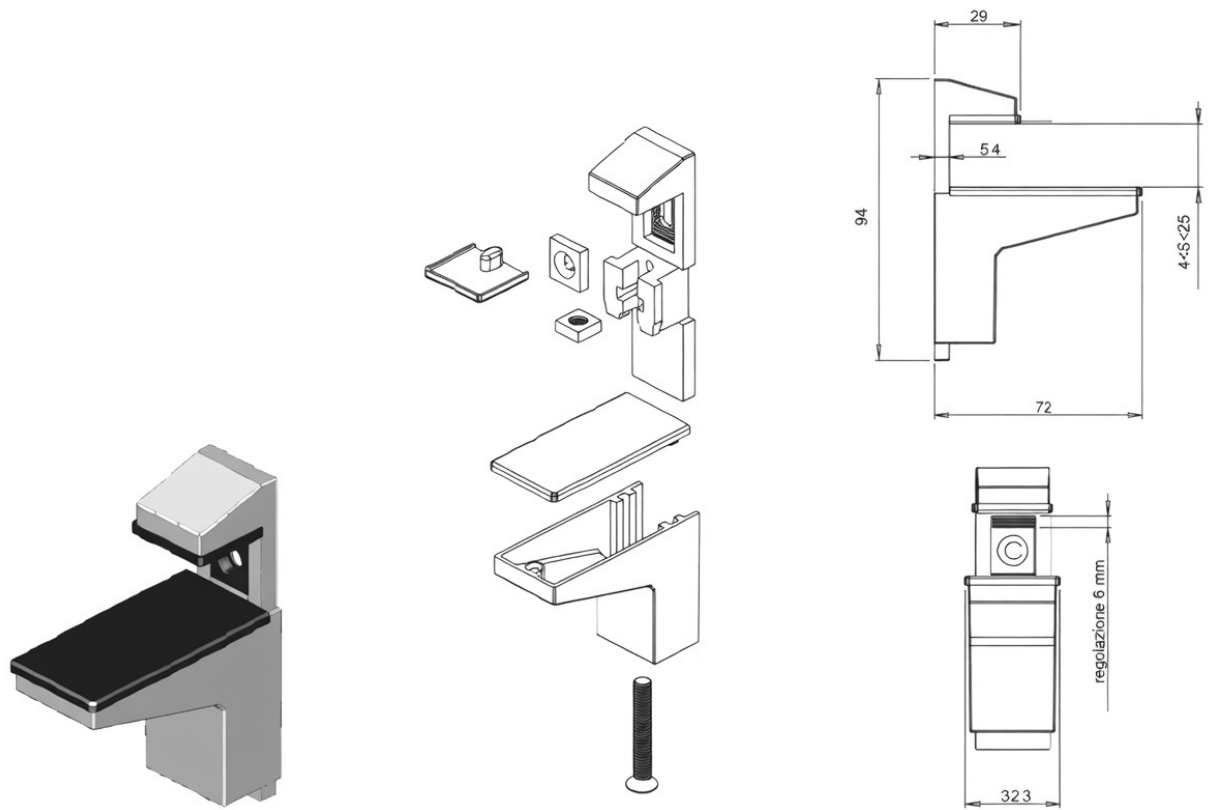

**ART. 3003.00**

Materiale: Zama / PE / ferro

# CERNIERE PER TAVOLI E CRISTALLI

Table and Glass Hinges · Made in Italy

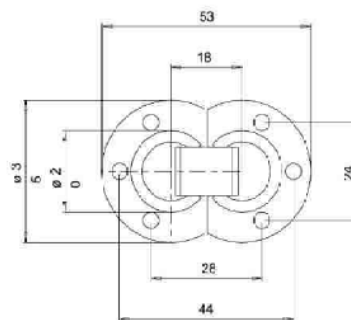
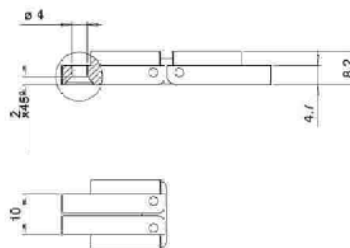

## ART. 0510.00

Materiale: Zama / ferro

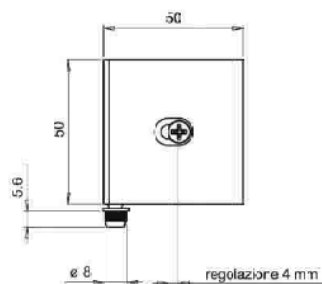
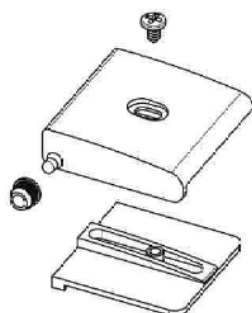
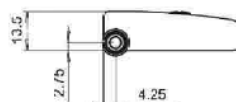

## ART. 1374.00

Materiale: Zama / PA / ferro

# CERNIERE PER TAVOLI E CRISTALLI

Table and Glass Hinges · Made in Italy

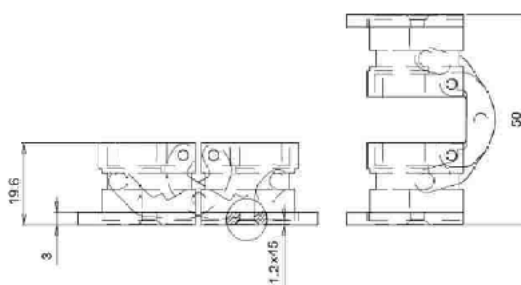
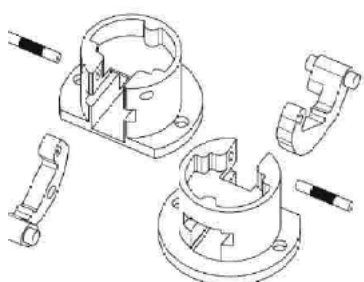
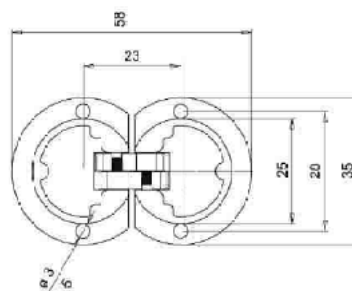

## ART. 0511.00

Materiale: Zama / ferro

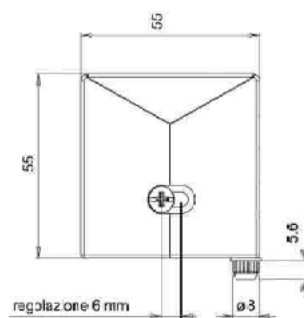
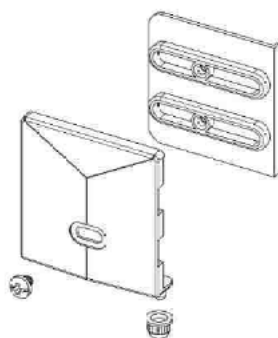
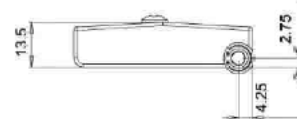

## ART. 1382.00

Materiale: Zama / PA / ferro

# CERNIERA PER CRISTALLI

Glass Hinges · Made in Italy

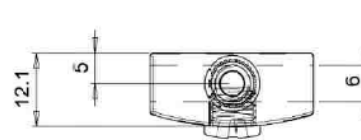
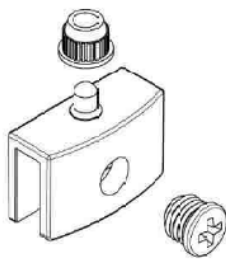
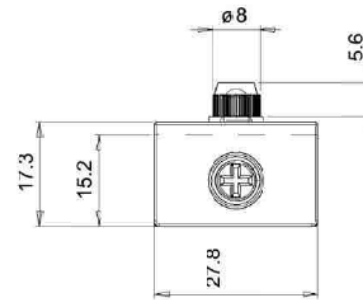

## ART. 1448.00

Materiale: Zama / PA / ferro

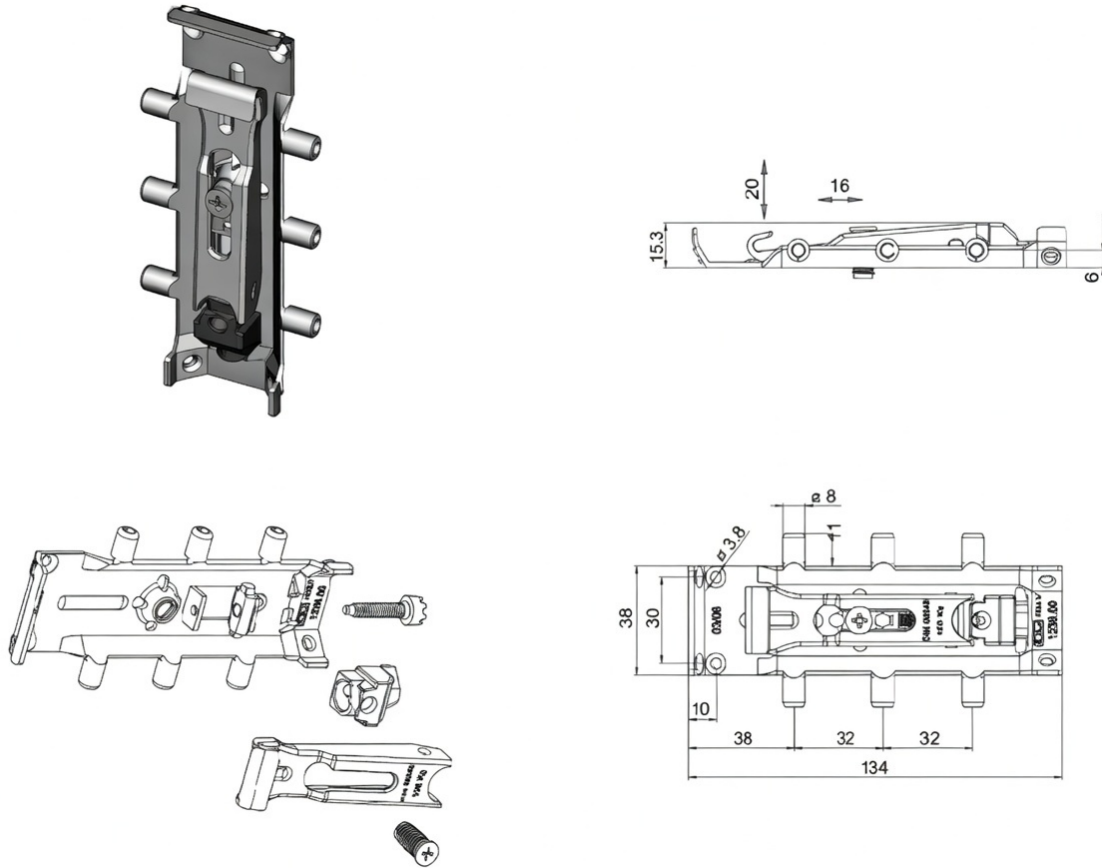

**ART. 1239**

Materiale: PA / Zama / ferro

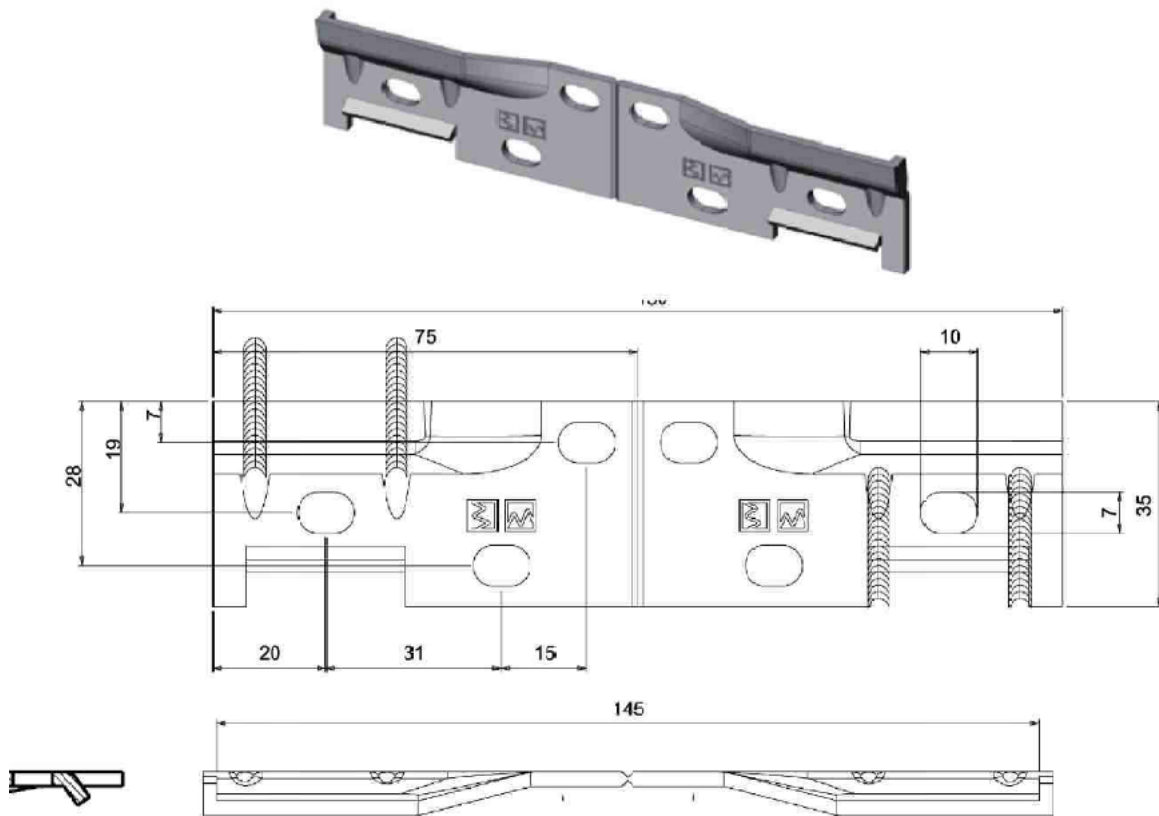

**ART. 1260**

Materiale: Ferro

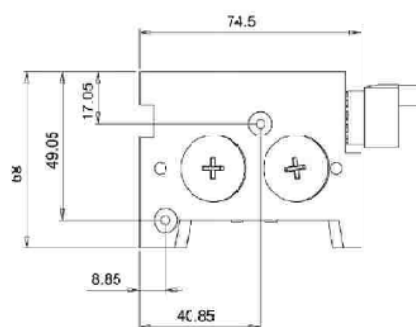
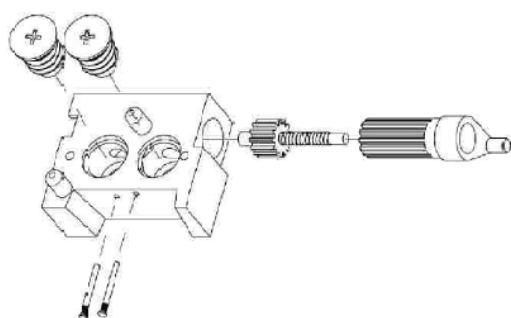
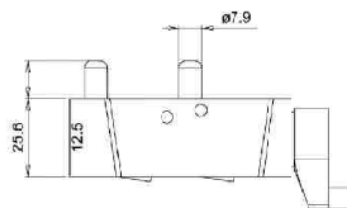

**ART. 1359**

Materiale: PA / Zama / ferro

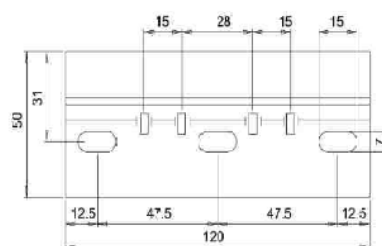
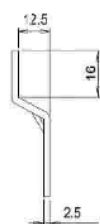
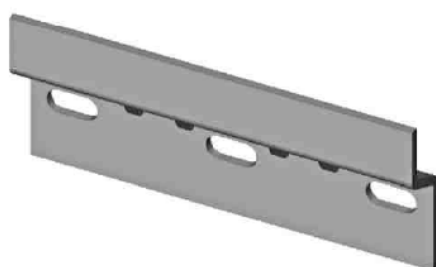

**ART. 1350.03**

Materiale: Ferro

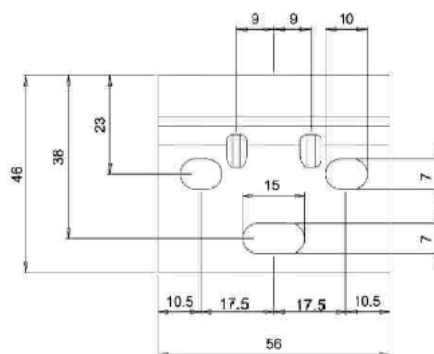
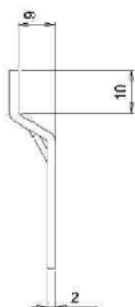
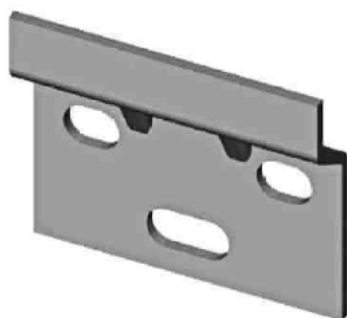

**ART. 1350.00**

Materiale: Ferro

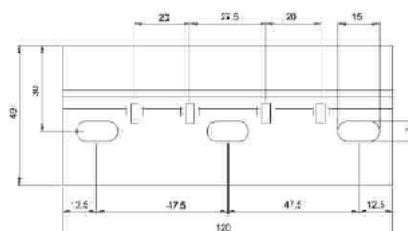
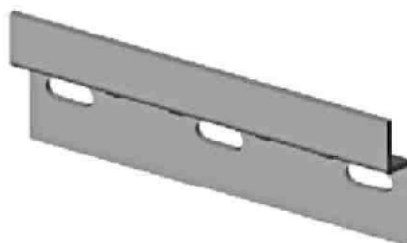

**ART. 1350.02**

Materiale: Ferro

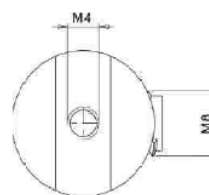
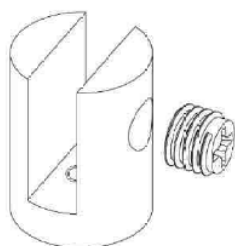
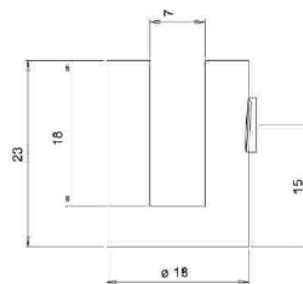

**ART. 1438.00**

Materiale: Zama

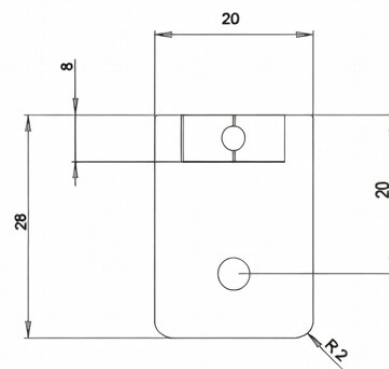
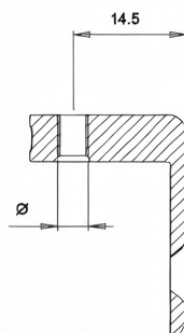
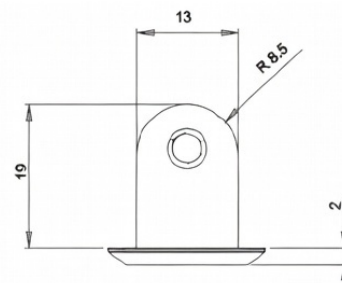

	Ø
1472.00	4.5
1472.01	M4

**ART. 1472.00**

Materiale: Zama

## DISTANZIALI PER GUIDE

Guide Spacers · Made in Italy

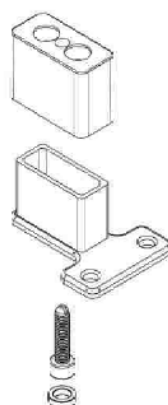
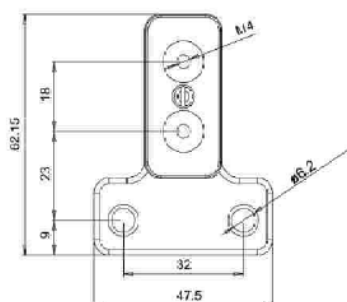
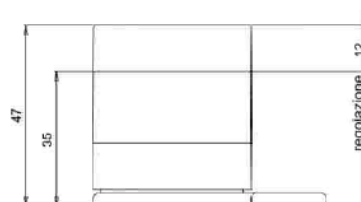

### ART. 1413A.11

Materiale: Zama / Ferro / PA

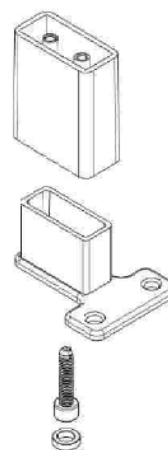
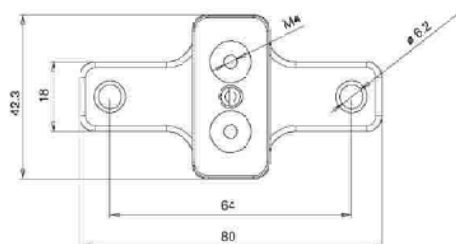
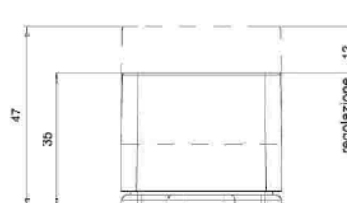
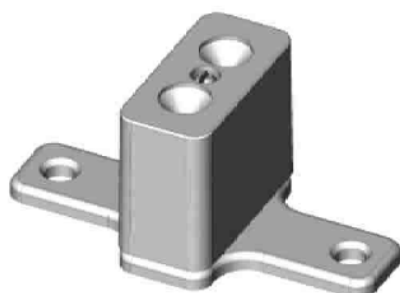

### ART. 1414A.01

Materiale: Zama / Ferro / PA

## DISTANZIALI PER GUIDE

Guide Spacers · Made in Italy

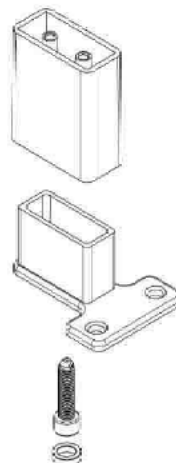
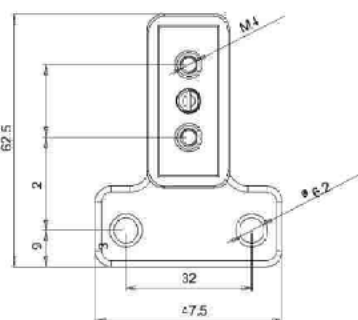
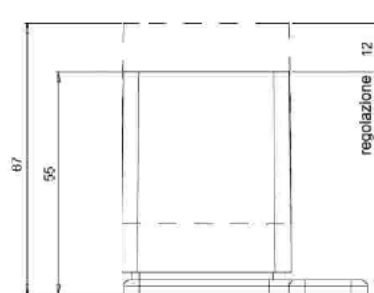

### ART. 1413B.11

Materiale: Zama / Ferro / PA

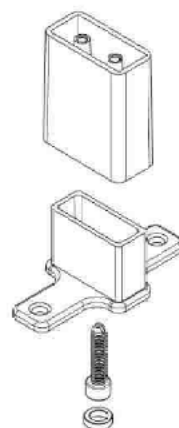
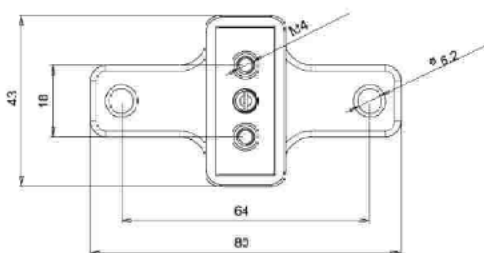
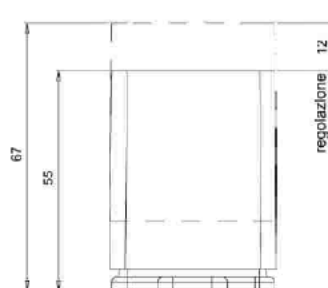
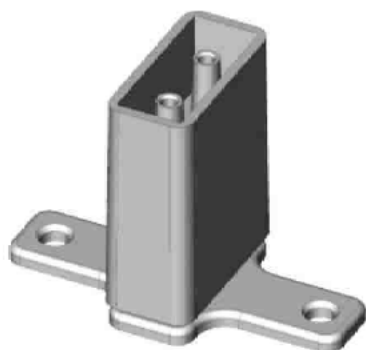

### ART. 1414B.01

Materiale: Zama / Ferro / PA

## DISTANZIALI PER GUIDE

Guide Spacers - Made in Italy

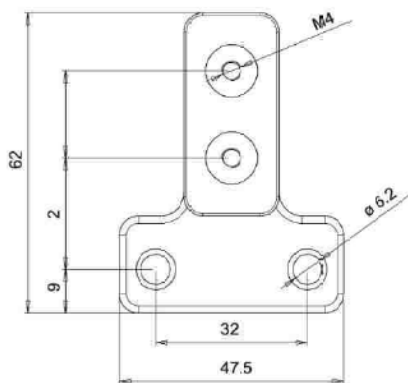
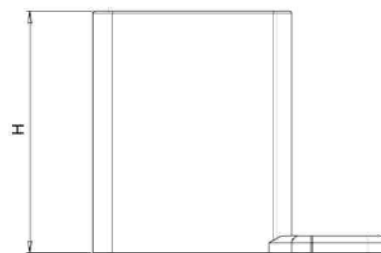
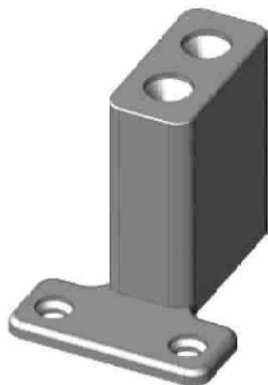

articolo	H
1415.00	28
1415.01	38
1415.02	50
1415.03	7
1415.04	60
1415.05	40.5

### ART. 1415

Materiale: Zama / Ferro / PA

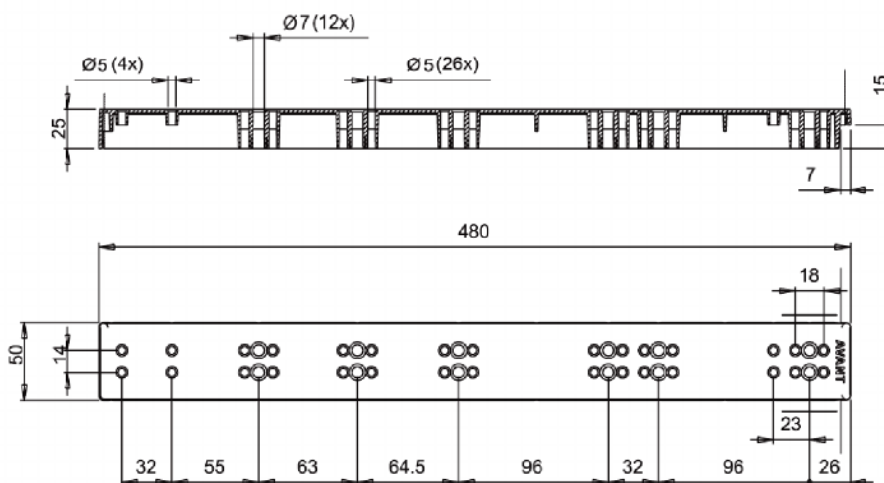
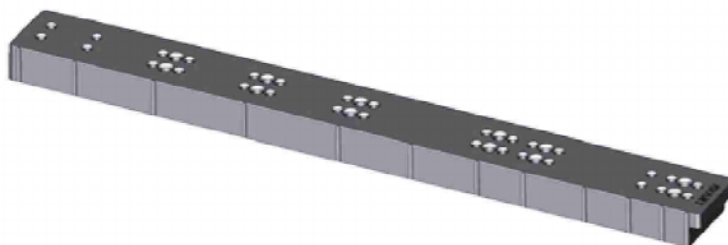

### ART. 1481.00

Materiale: Zama / PS

## DISTANZIALI PER GUIDE

Guide Spacers - Made in Italy

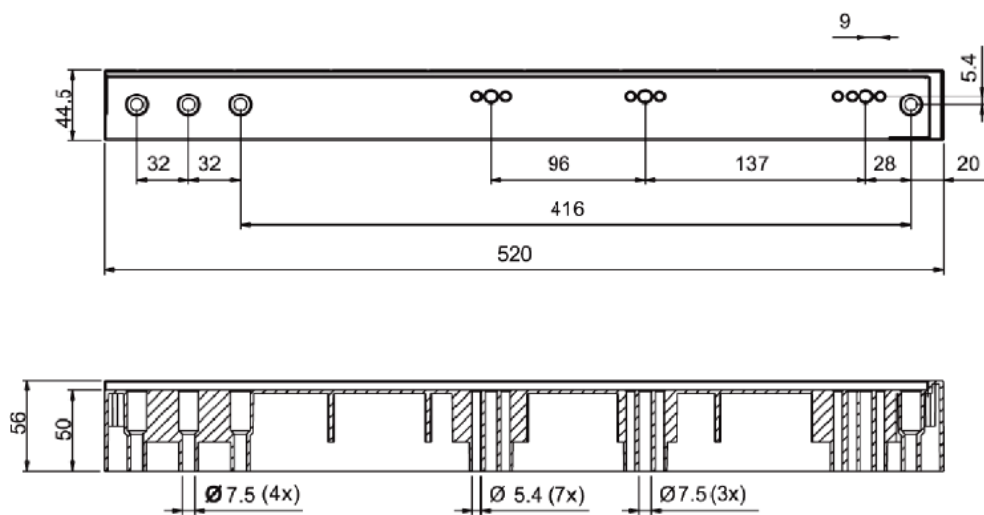
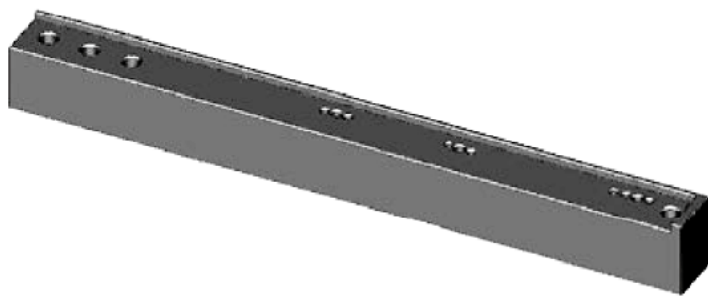

### ART. 1469.00

Materiale: ABS

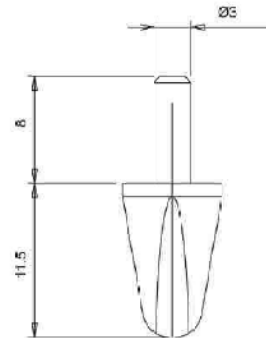
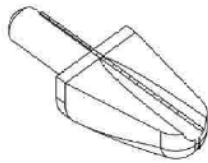
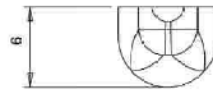

---

**ART. 1257.00**

Materiale: Zama

---

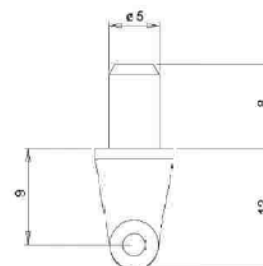
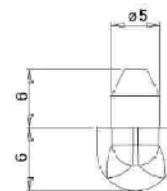

---

**ART. 1395.00**

Materiale: Zama

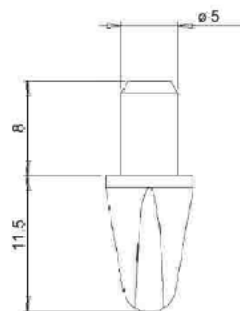

**ART. 1393.00**

Materiale: Zama

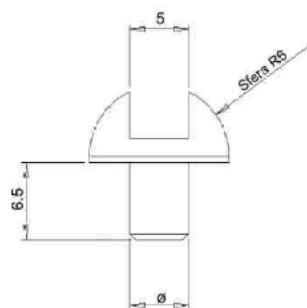

articolo	ø
1399.00	5
1399.01	6

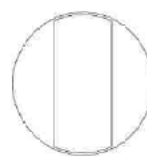

**ART. 1399**

Materiale: PMMA

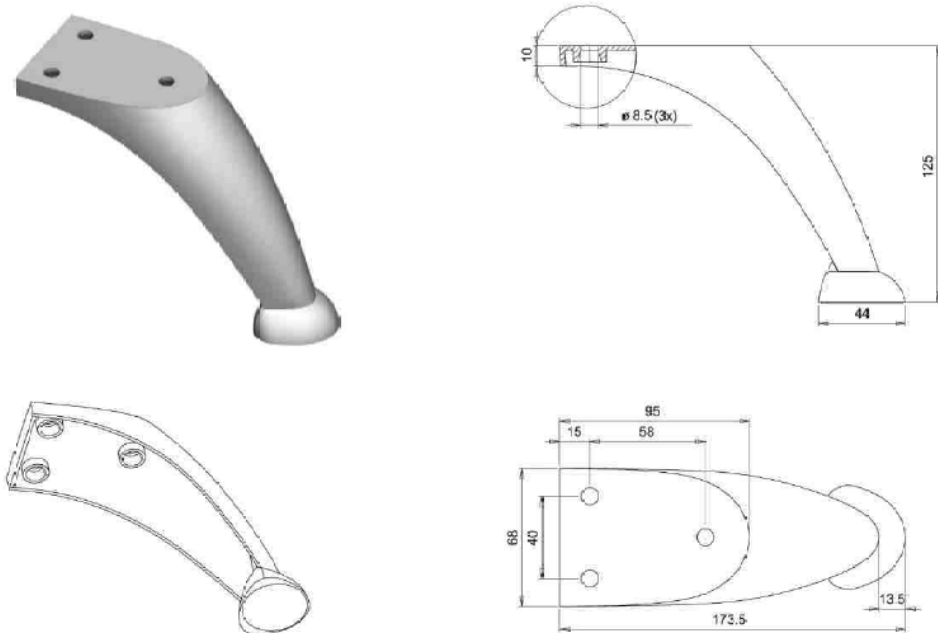

**ART. 1207**

Materiale: Zama

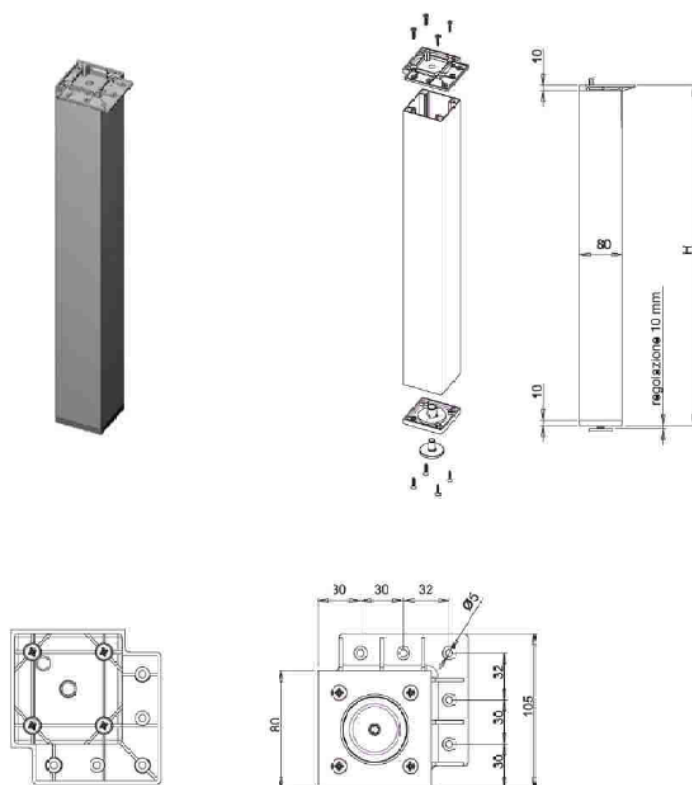

**ART. 1245**

Materiale: Zama / Alluminio / ferro

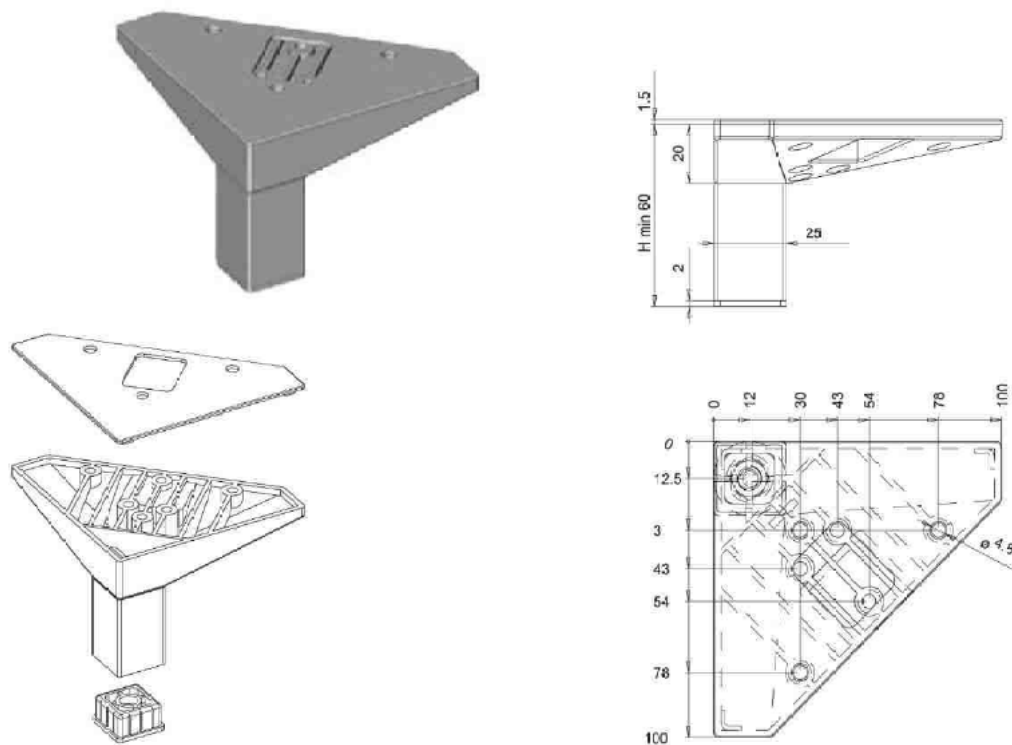

**ART. 1240.00**

Materiale: Ferro / ABS

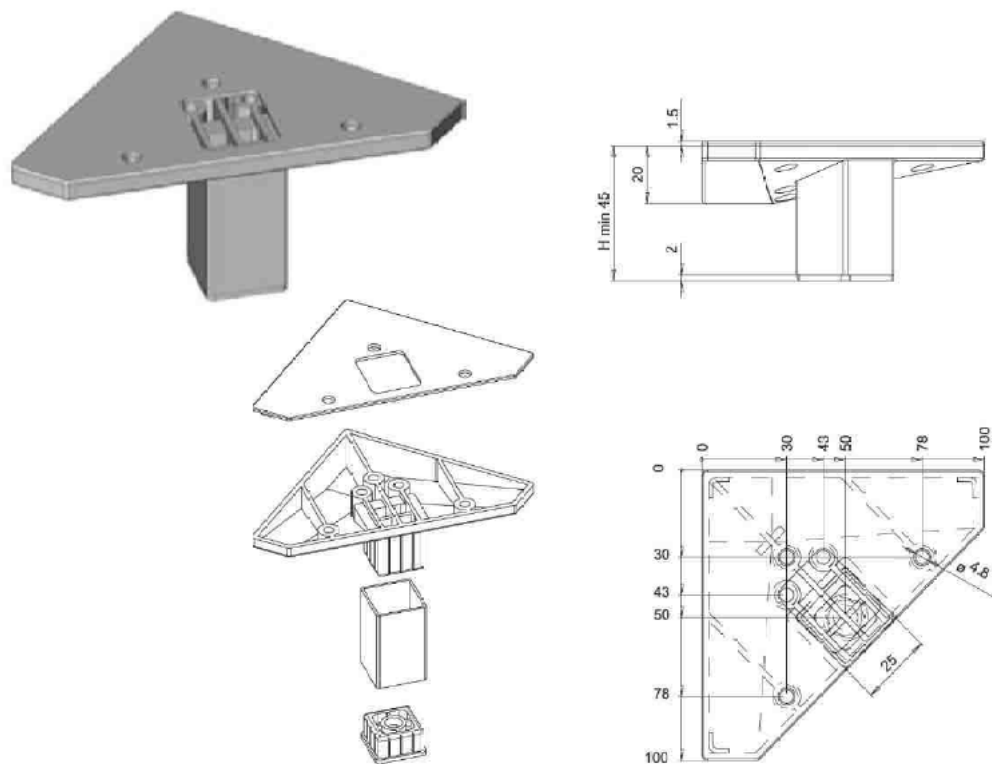

**ART. 1252**

Materiale: Ferro / ABS

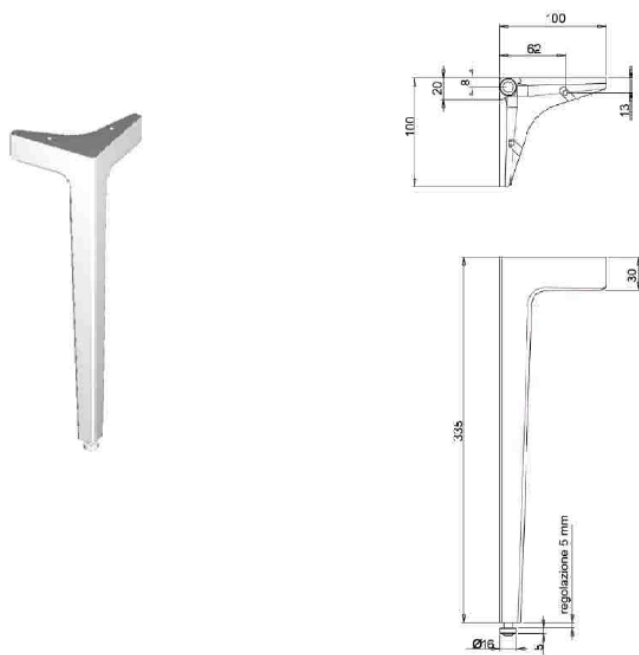

**ART. 1458.00**

Materiale: Zama / ferro

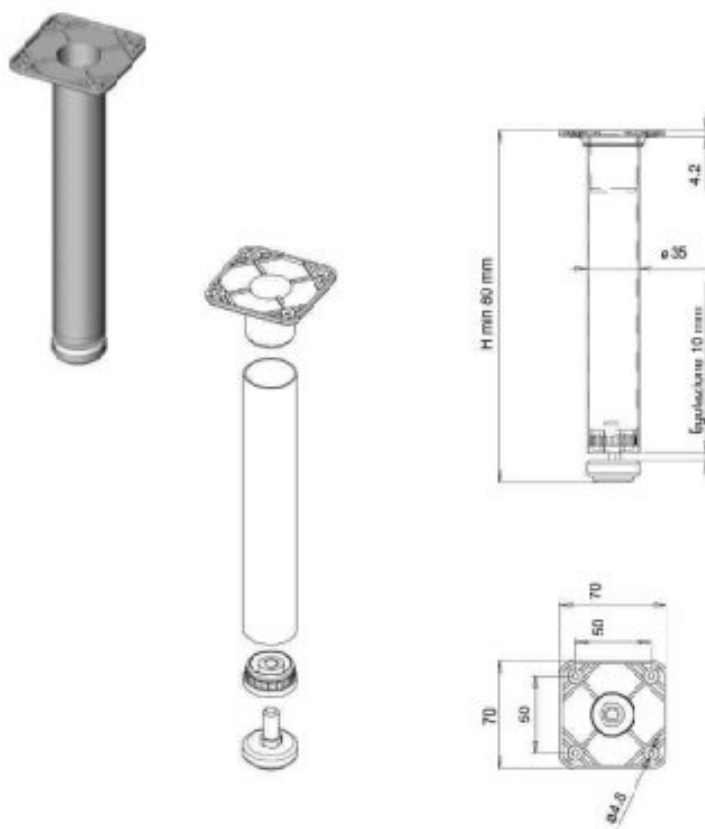

**ART. 1576**

Materiale: Ferro / Zama / PA

## PIEDINI E GAMBE

Feet and Legs · Made in Italy

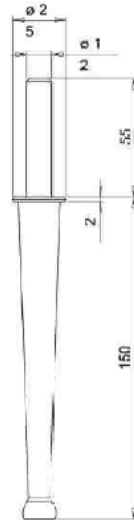

---

### ART. 1465.00

Materiale: Zama / ferro

---

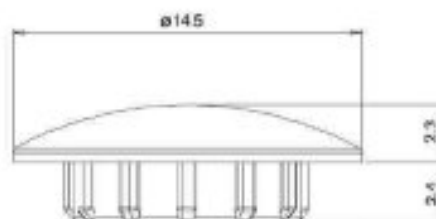
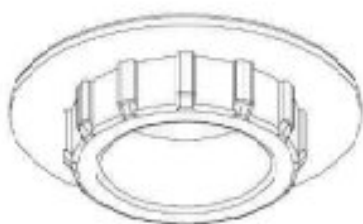
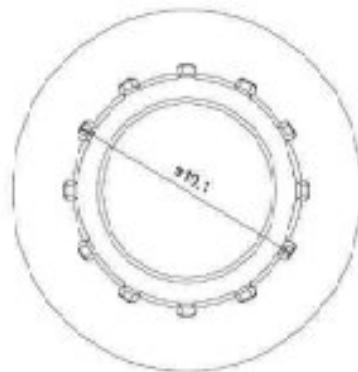

**ART. 1244.00**

Materiale: PA

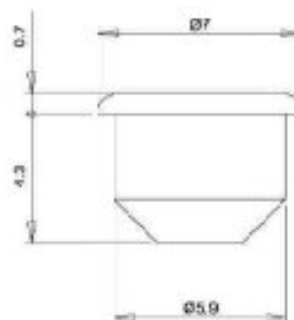

**ART. 1297.00**

Materiale: PA

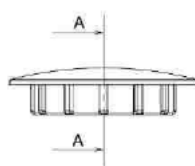
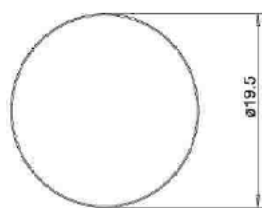
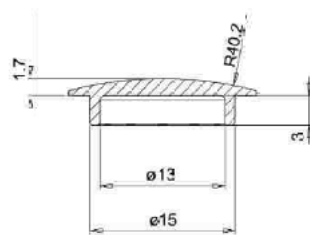

---

**ART. 1261.00**

Materiale: PA

---

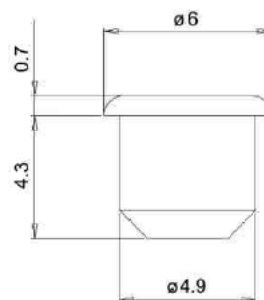
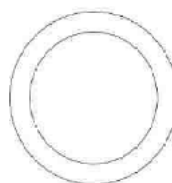

---

**ART. 1301.00**

Materiale: PA

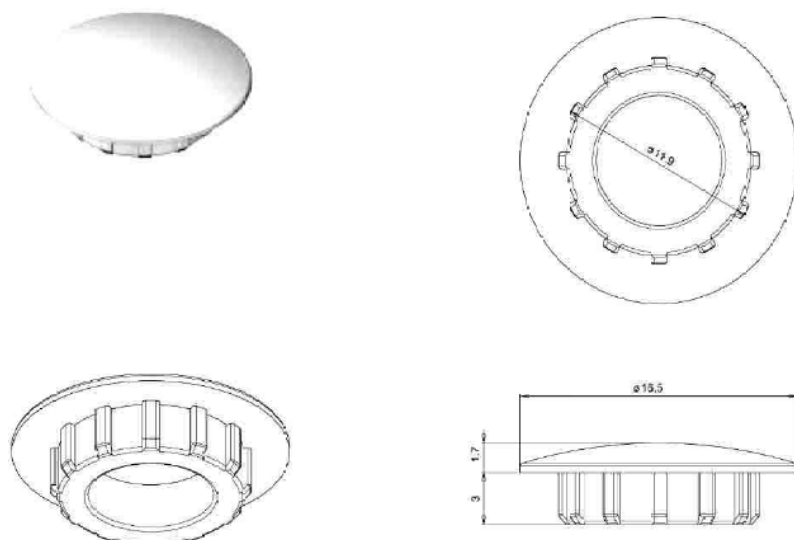

**ART. 1302.00**

Materiale: PA

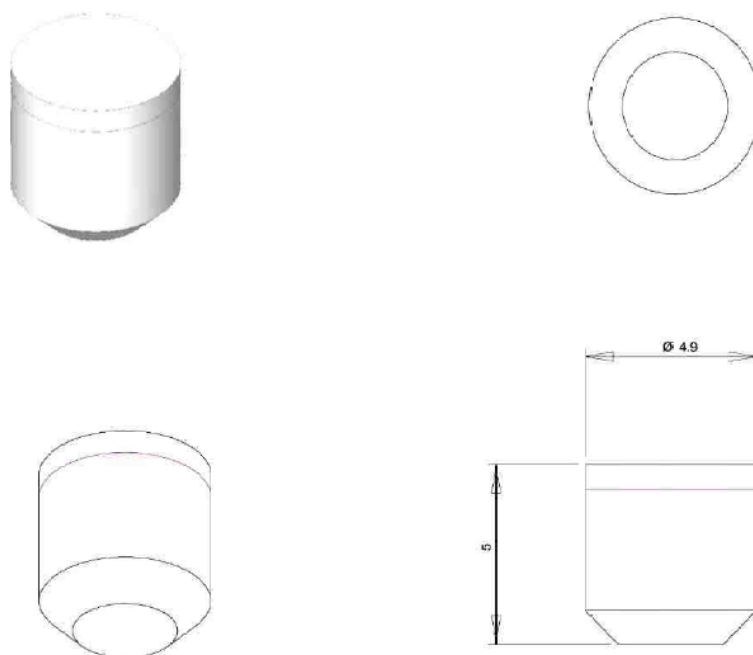

**ART. 1492.00**

Materiale: PA

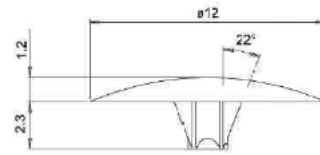
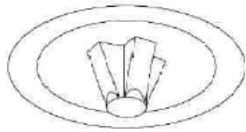
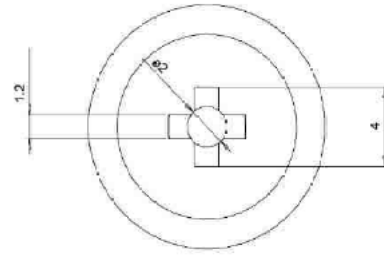
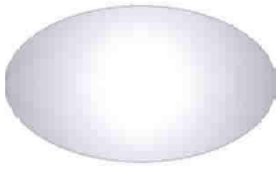

---

**ART. 1304.00**

Materiale: PA

---

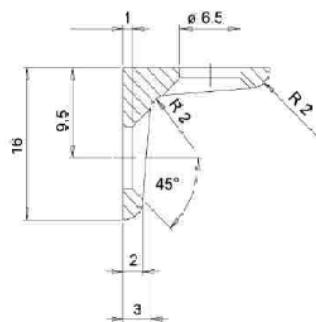
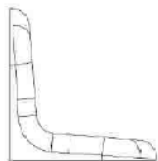
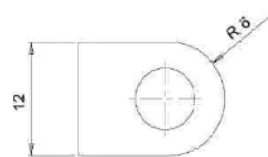

**ART. 1368.00**

Materiale: Zama

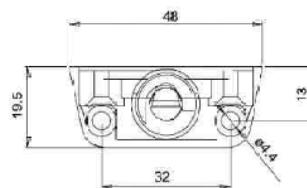
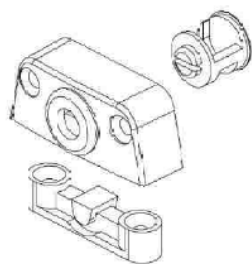
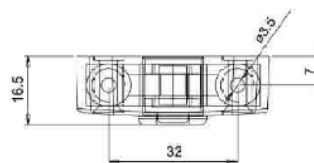
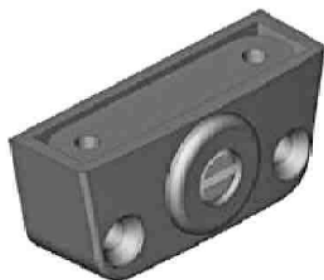

**ART. 1416.01**

Materiale: PA / Zama

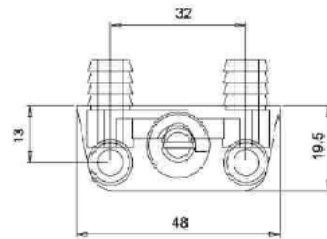
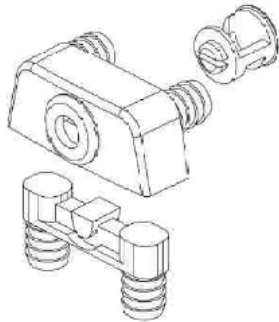
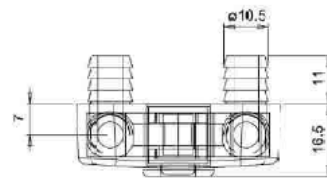
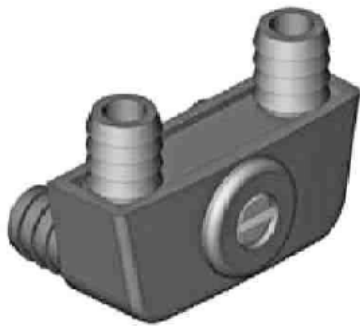

---

**ART. 1416.00**

Materiale: PA / Zama

---

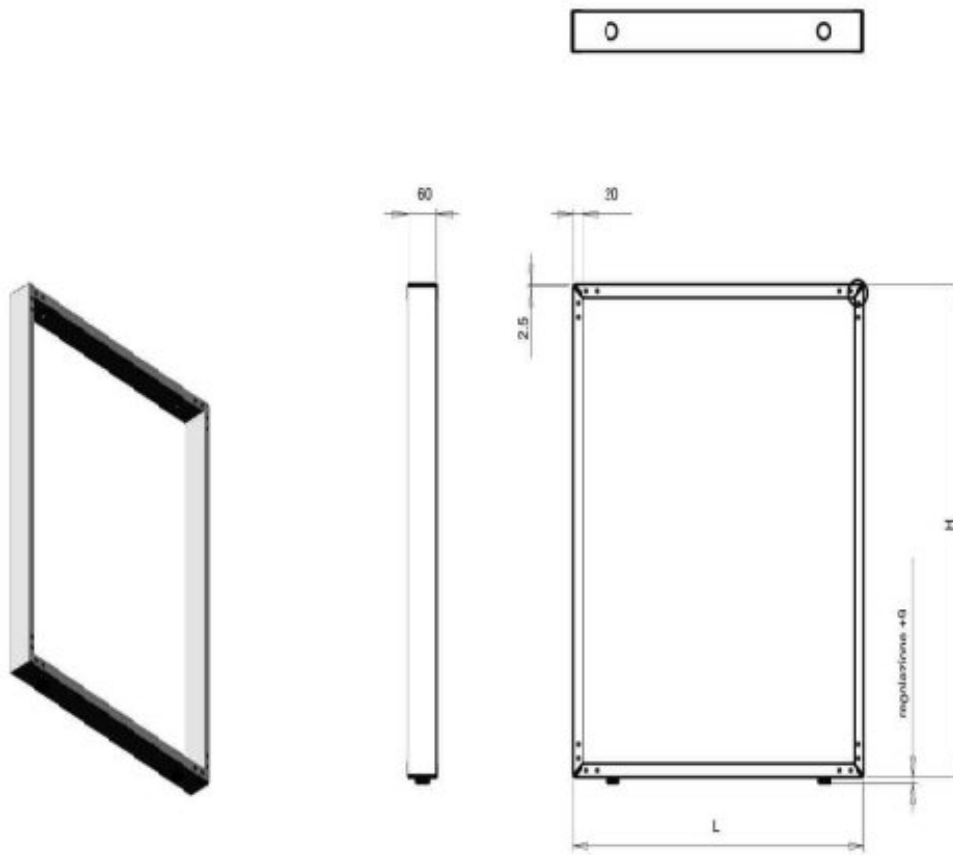

**ART. 5001**

Materiale: Alluminio / Zama / Ferro / PA

	Rpg con spina						
	articolo	A	B	D	C	E	F
	1405.00	Ø9	Ø19	7	7	33	20
1405.01	Ø9	Ø24	7	9,5	33	30	

  

	Rpg con cuneo						
	articolo	A	B	D	C	E	F
	1406.00	Ø9	Ø19	7	7	33	20
1406.01	Ø9	Ø21	7	7,5	31	25	
1406.02	Ø9	Ø24	7	9,5	33	30	

  

	Squadrette con perno									
	articolo	F	Ø perno			Rpg abbinabile				
			3	4	5	1405.00	1405.01	1406.00	1406.01	1406.02
1401.04	20		•		•					
1401.05	20			•	•					
1402.03	25	•						•		
1402.04	25		•					•		
1402.05	25			•				•		
1403.04	30		•			•				•
1403.05	30		•							•

	Squadrette con foro									
	articolo	F	Ø foro				Rpg abbinabile			
			M4	4	5	6	1405.00	1405.01	1406.00	1406.01
1401.00	20			•		•				
1401.01	20			•		•		•		
1401.02	20				•	•				
1402.00	25		•							•
1402.01	25			•						•
1402.02	25				•					•
1402.06	25	•								•
1408.00	25			•						•
1408.01	25			•						•
1407.01	25		•							•
1407.02	25			•						•



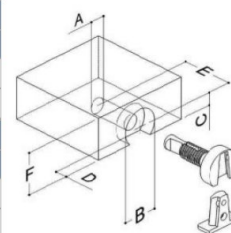

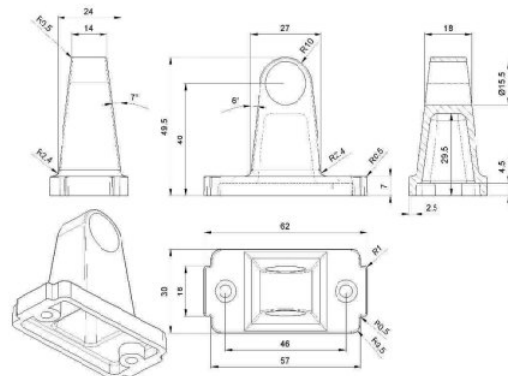
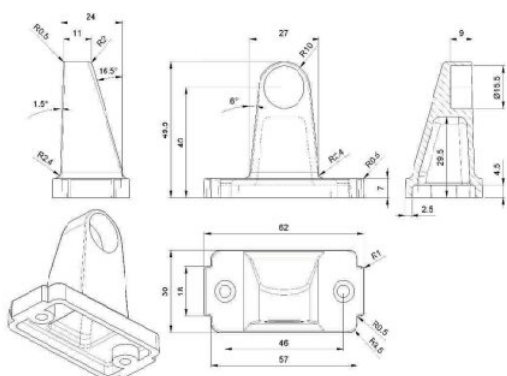
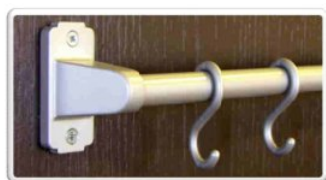
## ART. 3012

Materiale: Zama / ferro

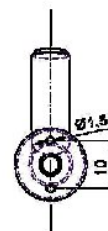
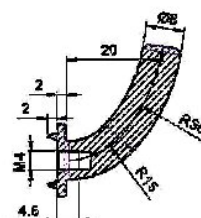
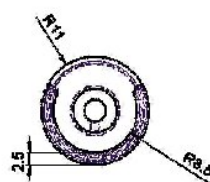
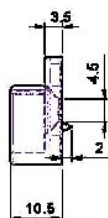
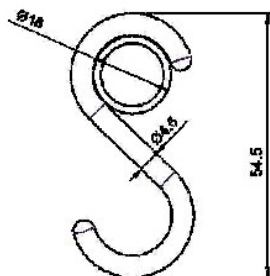

**ART. 3009**

Materiale: Zama / ferro

**© Borsani — Tutti i diritti riservati**

*All rights reserved*

---

Le immagini e i dati tecnici contenuti in questo catalogo sono forniti a titolo indicativo. Borsani si riserva il diritto di apportare modifiche a prodotti, misure e finiture senza preavviso.

*The images and technical data contained in this catalogue are provided for indicative purposes only. Borsani reserves the right to modify products, dimensions and finishes without prior notice.*

---

La riproduzione totale o parziale di questo catalogo, in qualsiasi forma, è vietata senza autorizzazione scritta.

*Total or partial reproduction of this catalogue in any form is prohibited without written authorisation.*

