

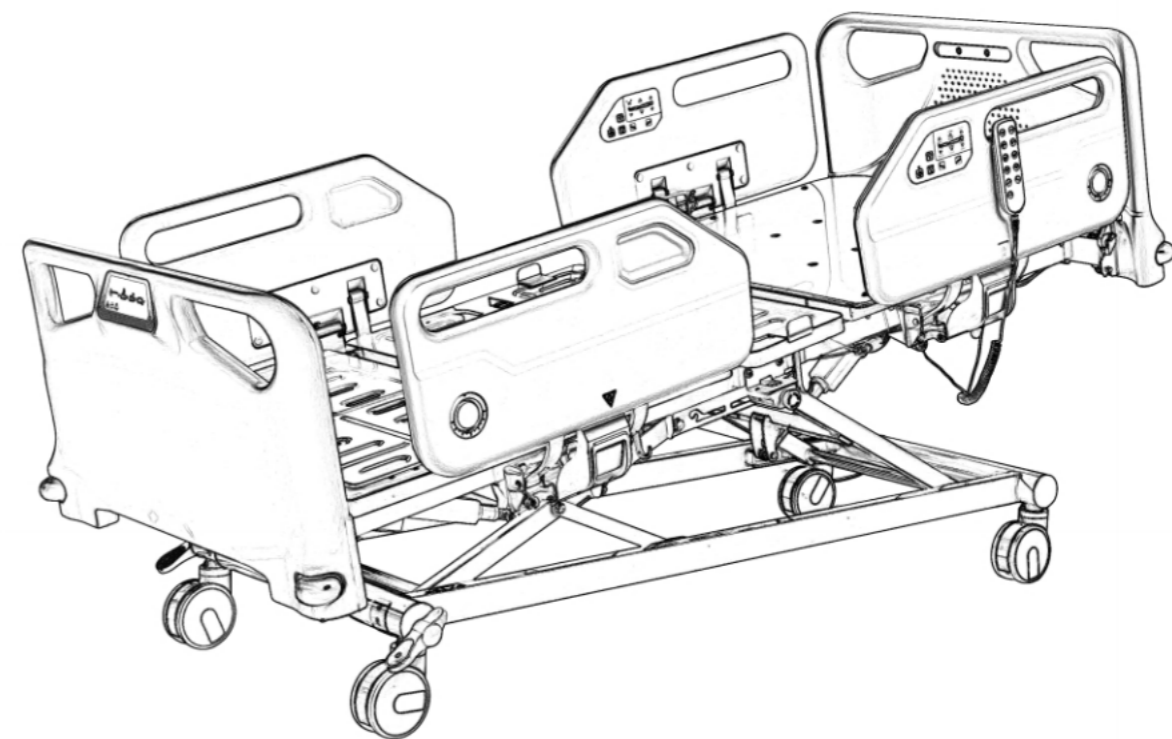

HEFEI MEDICOOOL MEDICAL EQUIPMENT CO., LTD
Address: 3 Floor, Building C1, Hefei Qidi Science and
Technolog City, Hefei, Anhui, China.
Tel:+86 188 5608 8032
Email: info@medicoolmedical.com



HEFEI MEDICOOOL MEDICAL EQUIPMENT CO., LTD

HOSPITAL BED

BT612 Series



8 Function Electric Hospital Bed 八功能电动病床

BT612EPZ-8L

Features(特点):

- Weighing System (称重)
- Lateral Function (翻身)



Backrest adjustment: 0-70°±5° Footrest adjustment: 0-35°±5° Height adjustment: 530-930±10mm Reverse & Trendelenburg: 14°±1° Sit position Lateral tilt left/right: 0-17°
背部调节: 0-70°±5° 腿部调节: 0-35°±5° 整体升降: 530-930±10mm 前后倾斜: 14°±1° 背腿联动 左右倾斜: 0-17°

Size (尺寸)
2140×1000×530-930±10mm

Mattress platform (床面尺寸)
1940×840mm

Safe working load (安全承重)
180KGS/400LBS

Functions (功能):

- Sit position (背腿联动)
- Digital nursing control panel (护士操作台)
- Weighing system (称重功能)
- Electric/Manual CPR (电动/手动一键复位)
- Backrest X-RAY translucent function (背部透X光功能)
- Night light (床底灯)
- Patient control panel (护栏按键)
- Steering wheel (定向轮)

Accessories (标配):

Bed frame (床体)	1set	6" double side central-brake castors (6寸中控轮)	4pcs
Motor system (电机系统)	1set	Mattress retainer (床垫挡板)	6pcs
Back-up battery (蓄电池)	1pc	Drainage hooks (引流挂勾)	4pcs
IV pole (输液杆)	1pc	IV pole holders (输液杆支撑孔)	4pcs
ABS head and foot board with bumper wheels (ABS床头尾板带防撞轮)	1pair	PP side rails with angle indicator (PP护栏, 带角度仪)	4pcs

Optional Accessories (选配):

Pedal control (脚踏控制器) Mattress (床垫) Overbed table (床边桌) Bedside table (床头柜)

6 Function Electric Hospital Bed 六功能电动病床

BT612EPZ-6L

Features(特点):

- Weighing System (称重)



Backrest adjustment: 0-70°±5° Footrest adjustment: 0-35°±5° Height adjustment: 530-930±10mm Reverse & Trendelenburg: 14°±1° Sit position
背部调节: 0-70°±5° 腿部调节: 0-35°±5° 整体升降: 530-930±10mm 前后倾斜: 14°±1° 背腿联动

Size (尺寸)
2140×1000×530-930±10mm

Mattress platform (床面尺寸)
1940×840mm

Safe working load (安全承重)
180KGS/400LBS

Functions (功能):

- Sit position (背腿联动)
- Digital nursing control panel (护士操作台)
- Weighing system (称重功能)
- Electric/Manual CPR (电动/手动一键复位)
- Backrest X-RAY translucent function (背部透X光功能)
- Night light (床底灯)
- Patient control panel (护栏按键)
- Steering wheel (定向轮)

Accessories (标配):

Bed frame (床体)	1set	6" double side central-brake castors (6寸中控轮)	4pcs
Motor system (电机系统)	1set	Mattress retainer (床垫挡板)	6pcs
Back-up battery (蓄电池)	1pc	Drainage hooks (引流挂勾)	4pcs
IV pole (输液杆)	1pc	IV pole holders (输液杆支撑孔)	4pcs
ABS head and foot board with bumper wheels (ABS床头尾板带防撞轮)	1pair	PP side rails with angle indicator (PP护栏, 带角度仪)	4pcs

Optional Accessories (选配):

Pedal control (脚踏控制器) Mattress (床垫) Overbed table (床边桌) Bedside table (床头柜)

5 Function Electric Hospital Bed 五功能电动病床

BT612EPZ-5B

Features(特点):
• Weight Capacity 250kgs (承重)



Backrest adjustment: 0-70°±5° Footrest adjustment: 0-35°±5° Height adjustment: 430-750±10mm Reverse & Trendelenburg: 14°±1° Sit position
背部调节: 0-70°±5° 腿部调节: 0-35°±5° 整体升降: 430-750±10mm 前后倾斜: 14°±1° 背腿联动

| Size (尺寸)
2140×1000×430-750±10mm

| Mattress platform (床面尺寸)
1940×840mm

| Safe working load (安全承重)
250KGS/550LBS

Functions (功能):

- Sit position (背腿联动)
- Electric CPR (电动一键复位)
- Patient control panel (护栏按键)

Accessories (标配):

Bed frame (床体)	1set	5" double side central-brake castors (5寸中控轮)	4pcs
Motor system (电机系统)	1set	Mattress retainer (床垫挡板)	6pcs
Back-up battery (蓄电池)	1pc	Drainage hooks (引流挂勾)	4pcs
IV pole (输液杆)	1pc	IV pole holders (输液杆支撑孔)	4pcs
ABS head and foot board with bumper wheels (ABS床头尾板带防撞轮)	1pair	PP side rails with angle indicator (PP护栏,带角度仪)	4pcs

Optional Accessories (选配):

- Pedal control (脚踏控制器)
- Manual CPR (手动一键复位)
- Backrest X-RAY translucent function (背部透X光功能)
- Weighing system (称重功能)
- Night light(床底灯)
- Mattress (床垫)
- Overbed table (床边桌)
- Bedside table (床头柜)

5 Function Electric Hospital Bed 五功能电动病床

BT612EPZ-5C

Features(特点):
• Weight Capacity 250kgs (承重)



Backrest adjustment: 0-70°±5° Footrest adjustment: 0-35°±5° Height adjustment: 430-750±10mm Reverse & Trendelenburg: 14°±1° Sit position
背部调节: 0-70°±5° 腿部调节: 0-35°±5° 整体升降: 430-750±10mm 前后倾斜: 14°±1° 背腿联动

| Size (尺寸)
2140×1000×430-750±10mm

| Mattress platform (床面尺寸)
1940×840mm

| Safe working load (安全承重)
250KGS/550LBS

Functions (功能):

- Sit position (背腿联动)
- Electric CPR (电动一键复位)

Accessories (标配):

Bed frame (床体)	1set	5" double side central-brake castors (5寸中控轮)	4pcs
Motor system (电机系统)	1set	Mattress retainer (床垫挡板)	6pcs
Remote controller (手柄控制器)	1set	Drainage hooks (引流挂勾)	4pcs
IV pole (输液杆)	1pc	IV pole holders (输液杆支撑孔)	4pcs
ABS head and foot board with bumper wheels (ABS床头尾板带防撞轮)	1pair	PP side rails with angle indicator (PP护栏,带角度仪)	4pcs

Optional Accessories (选配):

- Pedal control (脚踏控制器)
- Manual CPR (手动一键复位)
- Mattress (床垫)
- Patient control panel (护栏按键)
- Weighing system (称重功能)
- Overbed table (床边桌)
- Backrest X-RAY translucent function (背部透X光功能)
- Night light (床底灯)
- Bedside table (床头柜)

Product Technical Parameters Output Table

612系列病床配置

√Available 有 ×Not available 无 ○Optional 可选配

Icon	Specs	Model	BT612EPZ-8L	BT612EPZ-6L	BT612EPZ-5B	BT612EPZ-5C
	Product Name		Five-function electric hospital bed	Five-function electric hospital bed	Five-function electric hospital bed	Five-function electric hospital bed
Product Specs	Product Dimension (L*W*H)		214*100*53-93±1cm	214*100*53-93±1cm	214*100*43-75±1cm	214*100*43-75±1cm
	Bed Surface Dimensions		194*84cm	194*84cm	194*84cm	194*84cm
Safe Load Capacity	Dynamic load capacity(KG)		180KG/400LB	180KG/400LB	250KG/400LB	250KG/400LB
	Static load capacity(KG)		360KG/800LB	360KG/800LB	500KG/1100LB	500KG/1100LB
Basic Functions	Drive type		Electric	Electric	Electric	Electric
	Backrest adjustment		0-70° ±5°	0-70° ±5°	0-70° ±5°	0-70° ±5°
	Legrest adjustment		0-35° ±5°	0-35° ±5°	0-35° ±5°	0-35° ±5°
	Overall height adjustment		45-85±1cm	45-85±1cm	43-75±1cm	43-75±1cm
	Trendelenburg		14° ±1°	14° ±1°	14° ±1°	14° ±1°
	Reverse Trendelenburg		14° ±1°	14° ±1°	14° ±1°	14° ±1°
Additional Functions & Accessories	Backrest support mechanism		Multi-link	Multi-link	Multi-link	Multi-link
	Backrest pressure relief		√	√	√	√
	Sit position		√	√	√	√
	Lifting mechanism		Vertical lifting (without movement)	Vertical lifting (without movement)	Triangular support type(without movement)	Triangular support type(without movement)
	Bed board		Stamped bed board	Stamped bed board	Stamped bed board	Stamped bed board
	Side rails		PP side rails	PP side rails	PP side rails	PP side rails
	Caster wheels		6" castors	6" castors	5" castors	5" castors
	Swivel casters		√	√	√	√
	Motorized fifth wheel		○	○	○	○
	Anti-collision wheels		√	√	√	√
	Backrest angle indicator		√	√	√	√
	Overall tilt angle indicator		√	√	√	√
	Lateral tilt angle indicator		√	√	×	×
	Headboard extension		○	○	○	○
	Footboard extension		√	√	○	○
	Foot-end linen holder		○	○	○	○
	Mattress retention bar		√ 6pcs	√ 6pcs	√ 6pcs	√ 6pcs
	Drainage hook		√ 4pcs	√ 4pcs	√ 4pcs	√ 4pcs
	IV pole socket		√ 4pcs	√ 4pcs	√ 4pcs	√ 4pcs
	Backrest X-ray		√	√	○	○
Manual CPR		√	√	○	○	
Cable management panel		√	√	√	√	
Electric CPR		√	√	√	√	
Manual emergency stop		○	○	○	○	
Under-bed lighting		√	√	○	○	
Foot pedal control		○	○	○	○	
Handheld remote control		√	√	○	√	
Control panel mechanical lock		Electronic lock	Electronic lock	○	○	
Side rail button control		√	√	√	○	
Nurse control panel		√	√	○	×	
Rechargeable battery		√	√	√	○	
Weight measurement		√	√	○	○	
Turning assist function		√	×	×	×	
Bed exit alarm		○	○	×	×	
Accessories	IV Pole		√ Two hook	√ Two hook	√ Two hook	√ Two hook
	Mattress		○	○	○	○
	Overbed Table		○	○	○	○
	Dining Table		○	○	○	○
	Bedside Cabinet		○	○	○	○
Packing & Color	Storage Rack		×	×	○	○
	Packing Size (L*W*H)		230*110*54CM /1PC	230*110*54CM /1PC	220*100*46CM /1PC	220*100*46CM /1PC
	Optional Color		BLUE	BLUE	BLUE	BLUE

HOSPITAL BED

BT611 Series



5 Function Electric Hospital Bed 五功能电动病床

BT611EPZ-5B



Backrest adjustment: 0-70°±5° Footrest adjustment: 0-35°±5° Height adjustment: 430-750±10mm
背部调节: 0-70°±5° 腿部调节: 0-35°±5° 整体升降: 430-750±10mm

Reverse & Trendelenburg: 14°±1° Sit position
前后倾斜: 14°±1° 背腿联动

| Size (尺寸)
2140×1000×430-750±10mm

| Mattress platform (床面尺寸)
1940×840mm

| Safe working load (安全承重)
180KGS/400LBS

Functions (功能):

- Sit position (背腿联动)
- Electric CPR (电动一键复位)
- Patient control panel (护栏按键)

Accessories (标配):

Bed frame (床体)	1set	5" double side central-brake castors (5寸中控轮)	4pcs
Motor system (电机系统)	1set	Mattress retainer (床垫挡板)	6pcs
Back-up battery (蓄电池)	1pc	Drainage hooks (引流挂勾)	4pcs
IV pole (输液杆)	1pc	IV pole holders (输液杆支撑孔)	4pcs
ABS head and foot board with bumper wheels (ABS床头尾板带防撞轮)	1pair	PP side rails with angle indicator (PP护栏, 带角度仪)	4pcs

Optional Accessories (选配):

Pedal control (脚踏控制器) Manual CPR (手动一键复位) Backrest X-RAY translucent function (背部透X光功能)
Night light (床底灯) Mattress (床垫) Overbed table (床边桌) Bedside table (床头柜)

5 Function Electric Hospital Bed 五功能电动病床

BT611EPZ-5C



Backrest adjustment: 0-70°±5° Footrest adjustment: 0-35°±5° Height adjustment: 430-750±10mm
背部调节: 0-70°±5° 腿部调节: 0-35°±5° 整体升降: 430-750±10mm

Reverse & Trendelenburg: 14°±1° Sit position
前后倾斜: 14°±1° 背腿联动

| Size (尺寸)
2140×1000×430-750±10mm

| Mattress platform (床面尺寸)
1940×840mm

| Safe working load (安全承重)
180KGS/400LBS

Functions (功能):

- Sit position (背腿联动)
- Electric CPR (电动一键复位)

Accessories (标配):

Bed frame (床体)	1set	5" double side central-brake castors (5寸中控轮)	4pcs
Motor system (电机系统)	1set	Mattress retainer (床垫挡板)	6pcs
Remote controller (手柄控制器)	1set	Drainage hooks (引流挂勾)	4pcs
IV pole (输液杆)	1pc	IV pole holders (输液杆支撑孔)	4pcs
ABS head and foot board with bumper wheels (ABS床头尾板带防撞轮)	1pair	PP side rails with angle indicator (PP护栏, 带角度仪)	4pcs

Optional Accessories (选配):

Patient control panel (护栏按键) Manual CPR (手动一键复位) Backrest X-RAY translucent function (背部透X光功能)
Mattress (床垫) Overbed table (床边桌) Bedside table (床头柜)

3 Function Electric Hospital Bed 三功能电动病床

BT611EPZ-3C



Backrest adjustment: 0-70°±5° 背部调节: 0-70°±5°
 Footrest adjustment: 0-35°±5° 腿部调节: 0-35°±5°
 Height adjustment: 430-750±10mm 整体升降: 430-750±10mm
 Sit position 背腿联动

Size (尺寸)
2140×1000×430-750±10mm

Mattress platform (床面尺寸)
1940×840mm

Safe working load (安全承重)
180KGS/400LBS

Functions (功能):

• Sit position (背腿联动)



Optional Accessories (选配):

Patient control panel (护栏按键)
Overbed table (床边桌)

Electric CPR/Manual CPR (电动手动一键复位)
Bedside table (床头柜)

Mattress (床垫)

3 Function Electric Hospital Bed 三功能电动病床

BT611EWB-3C



Backrest adjustment: 0-70°±5° 背部调节: 0-70°±5°
 Footrest adjustment: 0-35°±5° 腿部调节: 0-35°±5°
 Height adjustment: 300-730±10mm 整体升降: 300-730±10mm
 Sit position 背腿联动

Size (尺寸)
2140×980×300-730±10mm

Mattress platform (床面尺寸)
1940×840mm

Safe working load (安全承重)
180KGS/400LBS

Functions (功能):

• Sit position (背腿联动)



Optional Accessories (选配):

Electric CPR (电动一键复位)

Mattress (床垫)

Overbed table (床边桌)

Bedside table (床头柜)

2 Function Electric Hospital Bed 两功能电动病床

BT611EPB-2C



Backrest adjustment: 0-70°±5° 背部调节: 0-70°±5°
 Footrest adjustment: 0-35°±5° 腿部调节: 0-35°±5°

Size (尺寸)
2140×980×500±10mm

Mattress platform (床面尺寸)
1940×840mm

Safe working load (安全承重)
180KGS/400LBS

Accessories (标配):

Bed frame (床体)	1set	5" silent castor, all with brake (5寸带刹静音轮)	4pcs
Motor system (电机系统)	1set	Mattress retainer (床垫挡板)	6pcs
Remote controller (手柄控制器)	1set	Drainage hooks (引流挂勾)	4pcs
IV pole (输液杆)	1pc	IV pole holders (输液杆支撑孔)	4pcs
ABS head and foot board with bumper wheels (ABS床头尾板带防撞轮)	1pair	PP side rails (PP护栏)	2pcs

Optional Accessories (选配):

Emergency stop function (急停开关)

Mattress (床垫)

Overbed table (床边桌)

Bedside table (床头柜)

3 Function Manual Hospital Bed 三功能手动病床



Backrest adjustment: 0-70°±5° Footrest adjustment: 0~35°±5° Height adjustment: 430~750±10mm
背部调节: 0-70°±5° 腿部调节: 0~35°±5° 整体升降: 430~750±10mm

BT611MWZ-3

| Size (尺寸)
2140×1000×430-750±10mm

| Mattress platform (床面尺寸)
1940×840mm

| Safe working load (安全承重)
180KGS/400LBS



Optional Accessories (选配):

Mattress (床垫) Overbed table (床边桌) Bedside table (床头柜)

3 Function Manual Hospital Bed 三功能手动病床



Backrest adjustment: 0-70°±5° Footrest adjustment: 0~35°±5° Height adjustment: 430~750±10mm
背部调节: 0-70°±5° 腿部调节: 0~35°±5° 整体升降: 430~750±10mm

BT611MPZ-3

| Size (尺寸)
2140×1000×430-750±10mm

| Mattress platform (床面尺寸)
1940×840mm

| Safe working load (安全承重)
180KGS/400LBS



Optional Accessories (选配):

Mattress (床垫) Overbed table (床边桌) Bedside table (床头柜)

2 Function Manual Hospital Bed 两功能手动病床



Backrest adjustment: 0-70°±5° Footrest adjustment: 0~35°±5°
背部调节: 0-70°±5° 腿部调节: 0~35°±5°

BT611MWZ-2

| Size (尺寸)
2140×1000×500±10mm

| Mattress platform (床面尺寸)
1940×840mm

| Safe working load (安全承重)
180KGS/400LBS



Optional Accessories (选配):

Mattress (床垫) Overbed table (床边桌) Bedside table (床头柜)

2 Function Manual Hospital Bed 两功能手动病床



Backrest adjustment: 0-70°±5° Footrest adjustment: 0~35°±5°
背部调节: 0-70°±5° 腿部调节: 0~35°±5°

BT611MWB-2

| Size (尺寸)
2140×1000×500±10mm

| Mattress platform (床面尺寸)
1940×840mm

| Safe working load (安全承重)
180KGS/400LBS



Optional Accessories (选配):

Mattress (床垫) Overbed table (床边桌) Bedside table (床头柜)

Orthopedic Manual Bed 骨科手动病床



Backrest adjustment: 0-70°±5°
背部调节: 0-70°±5°



Footrest adjustment: 0-35°±5°
腿部调节: 0-35°±5°

BT611MWB-8



Size (尺寸)
2240×1000×500±10mm

Mattress platform (床面尺寸)
1940×840mm

Safe working load (安全承重)
180KGS/400LBS

Accessories (标配):

Bed frame (床体)	1set	5" silent castor, all with brake (5寸带刹静音轮)	4pcs
L side rails (弯管护栏)	1pair	Mattress retainer (床垫挡板)	6pcs
Cank system	3sets	Drainage hooks (引流挂勾)	4pcs
ABS head and foot board with bumper wheels (ABS床头尾板带防撞轮)	1pair	Aluminum traction frame (铝合金牵引架)	1set

Optional Accessories (选配):

Mattress (床垫) Overbed table (床边桌) Bedside table (床头柜)

Product Technical Parameters Output Table

611系列病床配置

✓Available 有 ×Not available 无 ○Optional 可选配

Icon	Specs	Model	BT611EPZ-5B	BT611EPZ-5C	BT611EPZ-3C	BT611EWB-3C	T611EPB-2C
	Product Name		Five-function electric hospital bed	Five-function electric hospital bed	Three-function electric hospital bed	Three-function electric hospital bed (Ultra-low)	Two-function electric hospital bed
	Product Dimension (L*W*H)		214*100*43-75±1cm	214*100*43-75±1cm	214*100*43-75±1cm	214*98*30-73±1cm	214*98*50±1cm
	Bed Surface Dimensions		194*84cm	194*84cm	194*84cm	194*84cm	194*84cm
Safe Load Capacity	Dynamic load capacity(KG)		180KG/400LB	180KG/400LB	180KG/400LB	180KG/400LB	180KG/400LB
	Static load capacity(KG)		360KG/800LB	360KG/800LB	360KG/800LB	360KG/800LB	360KG/800LB
Basic Functions	Drive type		Electric	Electric	Electric	Electric	Electric
	Backrest adjustment		0-70° ± 5°	0-70° ± 5°	0-70° ± 5°	0-70° ± 5°	0-70° ± 5°
	legrest adjustment		0-35° ± 5°	0-35° ± 5°	0-35° ± 5°	0-35° ± 5°	0-35° ± 5°
	Overall height adjustment		43-75±1cm	43-75±1cm	43-75±1cm	30-73±1cm	50cm
	Trendelenburg		14° ± 1°	14° ± 1°	0°	0°	0°
	Reverse Trendelenburg		14° ± 1°	14° ± 1°	0°	0°	0°
	Backrest support mechanism		multi-link	multi-link	Straight support	Straight support	Straight support
Additional Functions & Accessories	Backrest pressure relief		✓	✓	×	×	×
	Sit position		✓	✓	✓	✓	✓
	Lifting mechanism		Triangular support type(non-movable)	Triangular support type(non-movable)	Lever type (movable)	Cross type (non-movable)	×
	Bed board		Stamped bed board	Stamped bed board	Stamped bed board	Stamped bed board	Stamped bed board
	Side rails		PP small side rail	PP small side rail	PP small side rail	6 bars aluminum foldable curved side rail (side hole)	PP side rail
	Caster wheels		5" castors(central brake)	5" castors(central brake)	5" castors(central brake)	5" castors	5" castors
	Swivel casters		×	×	×	×	×
	Motorized fifth wheel		×	×	×	×	×
	Anti-collision wheels		✓	✓	✓	✓	✓
	Backrest angle indicator		✓	✓	✓	×	×
	Overall tilt angle indicator		✓	✓	✓	×	×
	Lateral tilt angle indicator		×	×	×	×	×
	Headboard extension		×	×	×	×	×
	Footboard extension		○	×	×	×	×
	Foot-end linen holder		○	×	×	×	×
Mattress retention bar		✓ 6pcs	✓ 6pcs	✓ 6pcs	✓ 6pcs	✓ 6pcs	
Drainage hook		✓ 4pcs	✓ 4pcs	✓ 4pcs	✓ 4pcs	✓ 4pcs	
IV pole socket		✓ 4pcs	✓ 4pcs	✓ 4pcs	✓ 4pcs	✓ 4pcs	
Backrest X-ray		○	○	×	×	×	
Manual CPR		○	○	×	×	×	
Cable management panel		✓	✓	✓	✓	✓	
Electric CPR		✓	○	○	○	×	
Manual emergency stop		○	○	○	○	○	
Under-bed lighting		○	×	×	×	×	
Foot pedal control		○	×	×	×	×	
Handheld remote control		○	✓	✓	✓	✓	
Control panel mechanical lock		○	○	○	○	○	
Side rail button control		✓	○	○	×	×	
Nurse control panel		○	○	×	×	×	
Rechargeable battery		✓	○	○	○	○	
Weight measurement		×	×	×	×	×	
Turning assist function		×	×	×	×	×	
Bed exit alarm		×	×	×	×	×	
Accessories	Iv Pole		✓ Two hook	✓ Two hook	✓ Two hook	✓ Two hook	✓ Two hook
	Mattress		○	○	○	○	○
	Overbed Table		○	○	○	○	○
	Dining Table		○	○	○	○	○
Packing & Color	Bedside Cabinet		○	○	○	○	○
	Storage Rack		○	○	○	○	○
Packing & Color	Packing Size (L*W*H)		220*100*46CM /1PC	220*100*46CM /1PC	220*100*46CM /1PC	210*98*300CM/1PC	210*98*20CM/1PC
	Optional Color		BLUE	BLUE	BLUE	BLUE	BLUE

Product Technical Parameters Output Table

611系列病床配置

√ Available 有 × Not available 无 ○ Optional 可选配

Icon	Specs	Model	BT611MPB-3	BT611MWZ-3	BT611MWZ-2	BT611MWB-2	BT611MWB-8
	Product Name		Three-function manual hospital bed	Three-function manual hospital bed	Two-function manual hospital bed	Two-function manual hospital bed	Orthopedic manual hospital bed
Product Specs	Product Dimension (L*W*H)		214*100*43-75 ± 1cm	214*100*43-75 ± 1cm	214*100*50 ± 1cm	214*100*50 ± 1cm	2240*100*50 ± 1cm
	Bed Surface Dimensions		194*84cm	194*84cm	194*84cm	194*84cm	194*84cm
Safe Load Capacity	Dynamic load capacity(KG)		180KG/400LB	180KG/400LB	180KG/400LB	180KG/400LB	180KG/400LB
	Static load capacity(KG)		360KG/800LB	360KG/800LB	360KG/800LB	360KG/800LB	360KG/800LB
Basic Functions	Drive type		Manual (rocker)	Manual (rocker)	Manual (rocker)	Manual (rocker)	Manual (rocker)
	Backrest adjustment		0-70° ± 5°	0-70° ± 5°	0-70° ± 5°	0-70° ± 5°	0-70° ± 5°
	legrest adjustment		0-35° ± 5°	0-35° ± 5°	0-35° ± 5°	0-35° ± 5°	0-35° ± 5°
	Overall height adjustment		44-75 ± 1cm	43-75 ± 1cm	×	×	×
	Trendelenburg		0°	0°	0°	0°	0°
	Reverse Trendelenburg		0°	0°	0°	0°	0°
Additional Functions & Accessories	Backrest support mechanism		Double support	Double support	Double support	Double support	Double support
	Backrest pressure relief		×	×	×	×	×
	Sit position		×	×	×	×	×
	Lifting mechanism		Lever type (movable)	Lever type (movable)	×	×	×
	Bed board		Stamped bed board	Stamped bed board	Stamped bed board	Stamped bed board	Stamped bed board
	Side rails		PP small side rail	6 bars aluminum foldable curved side rail (side hole)	6 bars aluminum foldable curved side rail (side hole)	6 bars aluminum foldable curved side rail (side hole)	6 bars aluminum foldable curved side rail (side hole)
	Caster wheels		5" castors	5" castors	5" castors	5" castors	5" castors
	Swivel casters		×	×	×	×	×
	Motorized fifth wheel		×	×	×	×	×
	Anti-collision wheels		√	√	√	√	√
	Backrest angle indicator		√	×	×	×	×
	Overall tilt angle indicator		√	×	×	×	×
	Lateral tilt angle indicator		×	×	×	×	×
	Headboard extension		×	×	×	×	×
	Footboard extension		×	×	×	×	×
	Foot-end linen holder		×	×	×	×	×
	Mattress retention bar		√ 6pcs	√ 6pcs	√ 6pcs	√ 6pcs	√ 6pcs
	Drainage hook		√ 4pcs	√ 4pcs	√ 4pcs	√ 4pcs	√ 4pcs
	TV pole socket		√ 4pcs	√ 4pcs	√ 4pcs	√ 4pcs	√ 4pcs
	Backrest X-ray		×	×	×	×	×
Manual CPR		×	×	×	×	×	
Cable management panel		×	×	×	×	×	
Electric CPR		×	×	×	×	×	
Manual emergency stop		×	×	×	×	×	
Under-bed lighting		×	×	×	×	×	
Foot pedal control		×	×	×	×	×	
Handheld remote control		×	×	×	×	×	
Control panel mechanical lock		×	×	×	×	×	
Side rail button control		×	×	×	×	×	
Nurse control panel		×	×	×	×	×	
Rechargeable battery		×	×	×	×	×	
Weight measurement		×	×	×	×	×	
Turning assist function		×	×	×	×	×	
Bed exit alarm		×	×	×	×	×	
Accessories	Iv Pole		√ Two hook	√ Two hook	√ Two hook	√ Two hook	√ Two hook
	Mattress		○	○	○	○	○
	Overbed Table		○	○	○	○	○
	Dining Table		○	○	○	○	○
	Bedside Cabinet		○	○	○	○	○
Packing & Color	Storage Rack		○	○	○	○	○
	Packing Size (L*W*H)		220*100*46CM /1PC	220*100*46CM /1PC	210*98*20CM /1PC	210*98*20CM /1PC	210*98*20CM /1PC
	Optional Color		BLUE	BLUE	BLUE	BLUE	BLUE

HOSPITAL BED

BT60 Series



3 Function Electric Hospital Bed 三功能电动病床

BT603EP

| Size (尺寸)
2130×1000×430-750±10mm

| Mattress platform (床面尺寸)
1940×840mm

| Safe working load (安全承重)
180KGS/400LBS

Functions (功能):

- Sit position (背腿联动)



Backrest adjustment: 0-75°±5° Footrest adjustment: 0-35°±5° Height adjustment: 430-750±10mm Sit position
背部调节: 0-75°±5° 腿部调节: 0-35°±5° 整体升降: 430-750±10mm 背腿联动

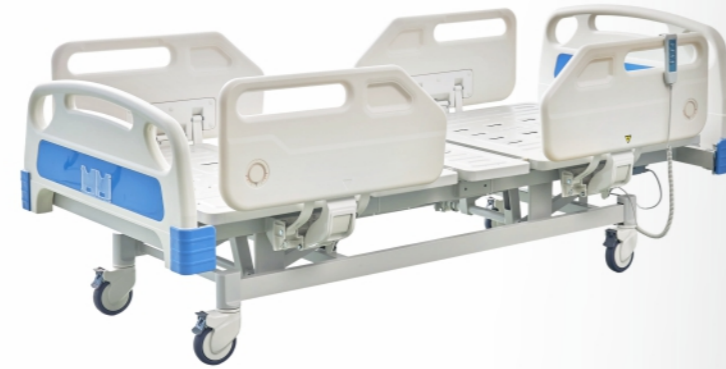

3 Function Electric Hospital Bed 三功能电动病床

BT603E

| Size (尺寸)
2130×970×430-750±10mm

| Mattress platform (床面尺寸)
1940×840mm

| Safe working load (安全承重)
180KGS/400LBS

Functions (功能):

- Sit position (背腿联动)



Backrest adjustment: 0-75°±5° Footrest adjustment: 0-35°±5° Height adjustment: 430-750±10mm Sit position
背部调节: 0-75°±5° 腿部调节: 0-35°±5° 整体升降: 430-750±10mm 背腿联动



Backrest adjustment: 0-75°±5° Footrest adjustment: 0-35°±5° Height adjustment: 260-680±10mm Sit position
背部调节: 0-75°±5° 腿部调节: 0-35°±5° 整体升降: 260-680±10mm 背腿联动

3 Function Electric Hospital Bed 三功能电动病床

BT603ECD

Features(特点):

- Ultra Low (超低)

| Size (尺寸)
2130×970×260-680±10mm

| Mattress platform (床面尺寸)
1940×840mm

| Safe working load (安全承重)
180KGS/400LBS

Functions (功能):

- Sit position (背腿联动)



Backrest adjustment: 0-75°±5° Footrest adjustment: 0-35°±5° Height adjustment: 430-750±10mm
背部调节: 0-75°±5° 腿部调节: 0-35°±5° 整体升降: 430-750±10mm

3 Function Manual Hospital Bed 三功能手动病床

BT603M

| Size (尺寸)
2130×970×430-750±10mm

| Mattress platform (床面尺寸)
1940×840mm

| Safe working load (安全承重)
180KGS/400LBS



3 Function Electric Hospital Bed 三功能电动病床

BT603ME

Features(特点):

- Semi-electric (手动一体)

| Size (尺寸)
2130×970×430-750±10mm

| Mattress platform (床面尺寸)
1940×840mm

| Safe working load (安全承重)
180KGS/400LBS

Functions (功能):

- Sit position (背腿联动)



Backrest adjustment: 0-75°±5° Footrest adjustment: 0-35°±5° Height adjustment: 430-750±10mm Sit position
背部调节: 0-75°±5° 腿部调节: 0-35°±5° 整体升降: 430-750±10mm 背腿联动



2 Function Manual Hospital Bed 两功能手动病床

BT602M

| Size (尺寸)
2130×970×500±10mm

| Mattress platform (床面尺寸)
1940×840mm

| Safe working load (安全承重)
180KGS/400LBS



Backrest adjustment: 0-75°±5° Footrest adjustment: 0-35°±5°
背部调节: 0-75°±5° 腿部调节: 0-35°±5°



Product Technical Parameters Output Table

60系列病床配置

√Available 有 ×Not available 无 ⊙Optional 可选配

Icon	Specs	Model	BT603EP	BT603ECD(260)	BT603E	BT603M	BT602M
	Product Name		Three-function electric hospital bed	Three-function electric hospital bed (Ultra-low)	Three-function electric hospital bed	Three-function manual hospital bed	Two-function manual hospital bed
Product Specs	Product Dimension (L*W*H)		213*100*43-75±1cm	213*97*26-68±1cm	213*97*43-75±1cm	213*97*43-75±1cm	213*97*50±1cm
	Bed Surface Dimensions		194*84cm	194*84cm	194*84cm	194*84cm	194*84cm
Safe Load Capacity	Dynamic load capacity(KG)		180KG/400LB	180KG/400LB	180KG/400LB	180KG/400LB	180KG/400LB
	Static load capacity(KG)		360KG/800LB	360KG/800LB	360KG/800LB	360KG/800LB	360KG/800LB
Basic Functions	Drive type		Electric	Electric	Electric	Manual (rocker)	Manual (rocker)
	Backrest adjustment		0-70° ±5°	0-70° ±5°	0-70° ±5°	0-70° ±5°	0-70° ±5°
	Legrest adjustment		0-35° ±5°	0-35° ±5°	0-35° ±5°	0-35° ±5°	0-35° ±5°
	Overall height adjustment		43-75±1cm	26-68±1cm	43-75±1cm	43-75±1cm	×
	Trendelenburg		0°	0°	0°	0°	0°
	Reverse Trendelenburg		0°	0°	0°	0°	0°
	Backrest support mechanism		Straight support	Straight support	Straight support	Single support	Single support
	Backrest pressure relief		×	×	×	×	×
	Leg rest pressure relief		×	×	×	×	×
	Sit position		√	√	√	×	×
Additional Functions & Accessories	Lifting mechanism		Lever type (movable)	Lever type (movable)	Lever type (movable)	Lever type (movable)	×
	Bed board		Stamped bed board	Stamped bed board	Stamped bed board	Stamped bed board	Stamped bed board
	Side rails		PP Small side rail	6 bars aluminum foldable curved side rail (side hole)	6 bars aluminum foldable curved side rail (side hole)	6 bars aluminum foldable curved side rail (side hole)	6 bars aluminum foldable curved side rail (side hole)
	Caster wheels		5" castors	5" castors	5" castors	5" castors	5" castors
	Swivel casters		×	×	×	×	×
	Motorized fifth wheel		×	×	×	×	×
	Anti-collision wheels		⊙	⊙	⊙	⊙	⊙
	Backrest angle indicator		√	×	×	×	×
	Overall tilt angle indicator		√	×	×	×	×
	Lateral tilt angle indicator		×	×	×	×	×
Accessories	Headboard extension		×	×	×	×	×
	Footboard extension		×	×	×	×	×
	Foot-end linen holder		×	×	×	×	×
	Mattress retention bar		⊙	⊙	⊙	⊙	⊙
	Drainage hook		√ 4pcs	√ 4pcs	√ 4pcs	√ 4pcs	√ 4pcs
	IV pole socket		√ 4pcs	√ 4pcs	√ 4pcs	√ 4pcs	√ 4pcs
	Backrest X-ray		×	×	×	×	×
	Full-bed X-ray		×	×	×	×	×
	Manual CPR		×	×	×	×	×
	Cable management panel		√	√	√	×	×
Electric CPR		×	×	×	×	×	
Manual emergency stop		×	×	×	×	×	
Electric emergency stop		×	×	×	×	×	
Under-bed lighting		×	×	×	×	×	
Foot pedal control		×	×	×	×	×	
Handheld remote control		√	√	√	×	×	
Control panel mechanical lock		×	×	×	×	×	
Side rail button control		×	×	×	×	×	
Nurse control panel		×	×	×	×	×	
Rechargeable battery		⊙	⊙	⊙	×	×	
Weight measurement		×	×	×	×	×	
Turning assist function		×	×	×	×	×	
Bed exit alarm		×	×	×	×	×	
Packing & Color	Iv Pole		√ Two hook	√ Two hook	√ Two hook	√ Two hook	√ Two hook
	Mattress		⊙	⊙	⊙	⊙	⊙
	Overbed Table		⊙	⊙	⊙	⊙	⊙
	Dining Table		⊙	⊙	⊙	⊙	⊙
	Bedside Cabinet		⊙	⊙	⊙	⊙	⊙
Storage Rack		⊙	⊙	⊙	⊙	⊙	
Packing Size (L*W*H)		220*96*31CM/1PC	204*96*26CM/1PC	204*96*31CM/1PC	204*96*31CM/1PCS	210*96*26CM/2PCS	
Optional Color		BLUE/Wood Grain Color	BLUE/Wood Grain Color	BLUE/Wood Grain Color	BLUE/Wood Grain Color	BLUE/Wood Grain Color	

Electric Examination Couch 电动检查床

BT644A

Size (尺寸)
1900×650×380-850mm



Electric Examination Couch 电动检查床

BT644A-B

Size (尺寸)
1900×650×380-850mm

Massage Table 按摩床

BT644A-C

Size (尺寸)
1850×600×620-830mm



Electric Pediatric Bed 电动儿童床

BT625E-A

| Size (尺寸)
1840×980×600-960±10mm

| Mattress platform (床面尺寸)
1600×750mm

| Safe working load (安全承重)
170KGS

Functions (功能):

• Electric/Manual CPR (电动/手动一键复位)



Backrest adjustment: 0-70°±5° Footrest adjustment: 0~40°±5° Height adjustment: 600-960±10mm Reverse & Trendelenburg: 0-14°±2°
背部调节: 0-70°±5° 腿部调节: 0~40°±5° 整体升降: 600-960±10mm 前后倾斜: 0-14°±2°

Hospital Children Bed 儿童床

BT626

| Size (尺寸)
1880×900×585±10mm

| Mattress platform (床面尺寸)
1770×720mm

Functions (功能):

• Aluminum side rail, height adjusted
(铝合金护栏, 高度可调): 80mm/310mm/500mm
• Side rail size (护栏尺寸): 1770mm×570mm



Backrest adjustment: 0-75°±5° Footrest adjustment: 0~40°±5°
背部调节: 0-75°±5° 腿部调节: 0~40°±5°

Hospital Baby Bassinet 婴儿床

BT649

| Size (尺寸)
845×510×780-980±10mm

| Function (功能)
The height can be adjusted by gas spring
高度可通过气弹簧调节

| Material (材质)
Aluminum alloy column, Acrylic baby basin
纯铝合金立柱, 透明高强度婴儿盘

| Castor (脚轮)
100MM luxury silent castor, two with brake
100MM豪华静音轮双刹, 带独立刹车

| Color option (可选颜色)
Green, Pink, Blue
绿色, 粉色, 蓝色



Hospital Baby Bassinet 婴儿床

BT650A

| Size (尺寸)
810×460×950±10mm

| Function (功能)
The height can be adjusted by gas spring
高度可通过气弹簧调节

| Material (材质)
Steel electrostatic spraying, Acrylic baby basin
钢塑静电喷涂, 透明高强度婴儿盘

| Castor (脚轮)
3" luxury silent castor, two with brake
3寸豪华静音轮双刹, 带独立刹车



Electric Gynecology Delivery Table 电动妇产床

BT665E

Size (尺寸)
1900×600×750-900mm



Hydraulic Gynecology Delivery Table 液压妇产床

BT665M

Size (尺寸)
1880×600×750-990mm

Electric Delivery Table 电动妇产床

BT666E-B

Size (尺寸)
1350×650×570-870mm



Multi-function Electric Delivery Bed 多功能电动妇产床

BT666EPZ-A



Size (尺寸)
2000×980×650-920mm

Functions (功能) :

- Backrest adjustment: 0~75° ± 5°
背部调节: 0~75° ± 5°
- Trendelenburg: 0~12° ± 1°
向后倾斜: 0~12° ± 1°
- Central-brake function
中控刹车功能
- Hi-Low adjustment: 650-920mm
高度调节: 650-920mm
- X-ray translucent function
透X光功能
- Reverse: 0~14° ± 1°
向前倾斜: 0~14° ± 1°
- Angle display function
显示角度功能

Accessories (标配) :

ABS head & foot board (1套床头尾板)	1 set	3 sections mattress (1张3折床垫)	1pc
Bumper wheels (2个防撞轮)	2pcs	Stainless steel dirty tray (1个不锈钢污物盆)	1pc
PP side rails (1副PP护栏)	1pair	Taiwan motor (1套台湾电机)	1 set
Angle indicator (2个角度显示仪)	2pcs	5" central-brake castors (4个5英寸中控轮)	4pcs
Knee crutches (1副脚托)	1 pair	Central-brake pedal (2个中控刹车脚踏)	2pcs
Hand grip (1副抓手)	1 pair		

Electric Operation Table 电动手术床

BT667E-A



| Size (尺寸)
2125×550×630-980mm

| Safe working load (安全承重)
250KGS

Functions (功能) :

- Reverse trendelenburg: $\geq 20^\circ$
前后倾斜: $\geq 20^\circ$
- Trendelenburg: $\geq 15^\circ$
后倾: $\geq 15^\circ$
- Lateral tilt left/right: $\geq 15^\circ$
左右倾斜: $\geq 15^\circ$
- Two control systems
双控系统
- Head plate up/down: $45^\circ / -90^\circ$
头部升降: $45^\circ / -90^\circ$
- Leg plate up/down/outwards: $15^\circ / 90^\circ / 90^\circ$
腿板上折/下折/外展: $15^\circ / 90^\circ / 90^\circ$
- Kidney bridge elevation: 120mm
腰桥调节: 120mm
- Table top can be rotated 180°
台面180° 旋转
- Back plate up/down: $80^\circ / -35^\circ$
背部升降: $80^\circ / -35^\circ$
- Tabletop longitude shifting: 0-320mm
向前平移: 0-320mm
- Flex and reflex: $90^\circ / -200^\circ$
正反V: $90^\circ / -200^\circ$

Accessories (标配) :

Main Bed (床架)	1pc	Arm support (手托)	2pcs
Mattress (床垫)	1set	Body support (支身架)	2pcs
Anesthesia screen frame (麻醉屏支架)	1pc	Leg support (脚拖)	2pcs
Shoulder support (肩架)	2pcs	Hand controller (遥控器)	1pc



Electric Operation Table 电动手术床

BT667E-B

| Size (尺寸)
2100×500×750-1000mm

| Safe working load (安全承重)
135KGS

Functions (功能) :

- Reverse trendelenburg: $\geq 20^\circ$
前后倾斜: $\geq 20^\circ$
- Trendelenburg: $\geq 15^\circ$
后倾: $\geq 15^\circ$
- Lateral tilt left/right: $\geq 15^\circ$
左右倾斜: $\geq 15^\circ$
- Head plate up/down: $45^\circ / -90^\circ$
头部升降: $45^\circ / -90^\circ$
- Back plate up/down: $60^\circ / -30^\circ$
背部升降: $60^\circ / -30^\circ$
- Kidney bridge elevation: 100mm
腰桥调节: 100mm
- Leg section opened: $15^\circ / 90^\circ / 90^\circ$
腿板上折/下折/外展: $15^\circ / 90^\circ / 90^\circ$
- Tabletop longitude shifting: 250mm
向前平移: 250mm

Accessories (标配) :

Main Bed (床架)	1pc	Arm support (手托)	2pcs
Mattress (床垫)	1set	Body support (支身架)	2pcs
Head section (头枕)	1pc	Leg support (脚拖)	2pcs
Anesthesia screen frame (麻醉屏支架)	1pc	Hand controller (遥控器)	1pc
Shoulder support (护肩)	2pcs		

Electric Operation Table 电动手术床

BT667E-C



Size (尺寸)
2000×500×750-1000mm

Safe working load (安全承重)
135KGS

Functions (功能) :

- Reverse trendelenburg: $\geq 25^\circ$
前后倾斜: $\geq 25^\circ$
- Head plate up/down: $45^\circ / -90^\circ$
头部升降: $45^\circ / -90^\circ$
- Back plate up/down: $80^\circ / -35^\circ$
背部升降: $70^\circ / -35^\circ$
- Trendelenburg: $\geq 15^\circ$
后倾: $\geq 15^\circ$
- Leg section opened: $15^\circ / 90^\circ / 90^\circ$
腿板上折/下折/外展: $15^\circ / 90^\circ / 90^\circ$
- Tabletop longitude shifting: 350mm
向前平移: 350mm
- Lateral tilt left/right: $\geq 20^\circ$
左右倾斜: $\geq 20^\circ$
- Kidney bridge elevation: 100mm
腰桥调节: 100mm

Accessories (标配) :

Main Bed (床架)	1pc	Arm support (手托)	2pcs
Mattress (床垫)	1set	Body support (支身架)	2pcs
Head section (头枕)	1pc	Leg support (脚拖)	2pcs
Anesthesia screen frame (麻醉屏支架)	1pc	Hand controller (遥控器)	1pc
Shoulder support (护肩)	2pcs		

Operation Table Accessories 手术床配件

BT667-PJ98

Functions (功能) :

- Orthopaedics Traction Frame
骨科牵引架
- Traction shoes translation distance: 200mm
牵引鞋平移距离: 200mm
- Leg support frame translation distance: 550mm
腿部支撑架平移距离: 550mm
- Traction frame translation distance: 600mm
牵引架平移距离: 600mm
- Height: 650-870mm
高度: 650-870mm
- Base support frame outwards: 60°
底座支撑架向外: 60°
- Length: 1400mm
长度: 1400mm

Accessories (标配) :

Leg support (腿托)	2 pcs	Traction shoes (牵引鞋)	2pcs
Hip board (髋板)	1pc		

BT667-PJ01

Functions (功能) :

- Width of the inserted rod: 190-590 mm
宽度: 190-590 mm
- Height adjustment: 350mm
高度调节: 350mm
- Longitudinal shift: 350mm
纵向偏移: 350mm
- Lateral shift: 400mm
横向偏移: 400mm
- Swing angle: 75°
摆动角度: 75°



Surgical Lights 手术灯

BT681E-700/500

Optional Camera 可选摄像头



- Built in camera or external camera system
3arms built in camera include in general:
- 1. Built in camera: 10x HIKVISION brand
 - 2. SDI monitor hang on 3rd arm: 21.5" normal monitor or medical grade monitor or monitor (display& record together) for options
 - 3. SDI recorder (SDI splitter)



500 light head



500 light head 2



700 light head real lighting picture

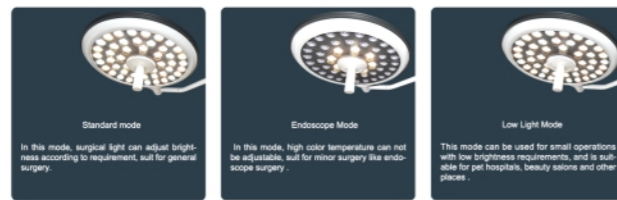

3pcs lighting mode

Characteristics	700 dome	500 dome
Field diameter 灯头直径(mm)	180-260	180-280
Brightness Dimming Level 亮度调光等级	1%-100%	1%-100%
Work Range 工作范围	70-140cm	70-140cm
Illumination Depth 20% Ec(mm) 光照深度	>600	>800
Illumination Depth 60% Ec(mm) 光照深度	452	616
CRI Ra (%) 显色指数	>95	>85
Illumination (lux) Adjustment 照度调节	40000-160000	40000-120000
Color Temperature (K) Adjustment 色温调节	4000-5000	4000-5000
Lamp power 灯泡功率	70VA	65VA
Voltage 电压	AC 100V-240V	AC 100V-240V

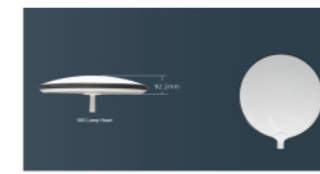

500 light head thickness reference picture

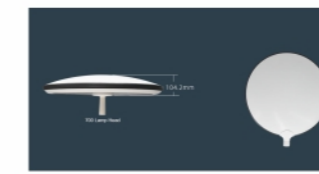

700 light head size reference picture

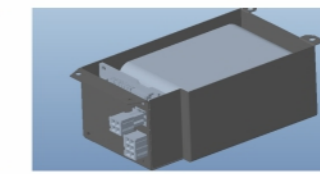

Back up battery 3d picture

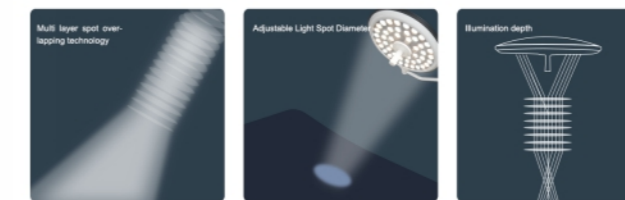

Adjustable Uniform Light Field

Characteristics	700 dome	500 dome
Frequency 频率	50/60Hz	50/60Hz
LED Quantity LED 数量	80	48
Light head thickness(mm) ±5 灯头厚度	104	92
LED Brand 品牌	Osram	Osram
LED Lifespan (hours) 寿命 (小时)	>50000	>50000
Radiation energy 辐射能量	<588w/m2	<441w/m2
Ee/Ec [mW/(m2.lx)]	<4mW/(m2.lx)	<3mW/(m2.lx)
Working conditions 工作条件	5°C ~40°C, 700hPa-1060hPa, 10%- 80% RH	
Install Height(2.5m can be customized)安装高度 (可定制 2.5m)	2.75-3m	2.75-3m
Optional Control Panel 可选控制面板	Touch control	

Surgical Lights 手术灯

BT681E-700

Optional Camera
可选摄像头



Built in camera or external camera system 3arms built in camera include in general:

1. Built in camera: 10x HIKVISION brand
2. SDI monitor hang on 3rd arm: 21.5" normal monitor or medical grade monitor or monitor (display& record together) for options
3. SDI recorder (SDI splitter to connect from camera to Monitor and recorder)



Characteristics	700 dome	Characteristics	700 dome
Field diameter(mm) 灯头直径	120-260	LED Quantity 数量	80
Brightness Dimming Level 亮度调光等级	1%-100%	Light head thickness(mm) ±5 灯头厚度	104
D50 / D10	0.51	LED Brand 品牌	Osram
Illumination Depth 20%(mm) 照明深度	≥600	LED Lifespan (hours) 寿命(小时)	≥50000
CRI (%) Ra 显色指数	≥95	Working conditions 工作条件	5°C ~ 40°C, 700hPa-1060hPa, 10%- 80% RH
Illumination (lux) 100stages Adjustment 照度调节	40000-160000	Light head thickness(mm) ±5 灯头厚度	104
Color Temperature (K) Adjustment 色温调节	4000-5000	Radiation energy 辐射能量	<588w/m2
Lamp power 灯泡功率	70VA	Ee/Ec [mW/(m2.lx)]	<4mW/(m2.lx)
Voltage电压	AC 100V-240V	Install Height(2.5m can be customized) 安装高度(可定制2.5m)	2.75-3.1m
Frequency频率	50/60Hz	Optional Controller 可选控制器	4.3" touch controller, 2.4" touch controller

Surgical Lights 手术灯

BT681E-500



Characteristics	500 dome	Characteristics	500 dome
Field diameter(mm)照明直径	180-280	LED Quantity 数量	48
Brightness Dimming Level 亮度调光等级	1%-100%	LED Brand 品牌	Germany Osram
Light field diameter D10(mm)	192	LED Lifespan (hours)寿命(小时)	≥50000
D50 / D10	70-140cm	Working conditions 工作条件	5°C ~ 40°C, 700hPa-1060hPa, 10%- 80% RH
Illumination Depth 20%(mm) 光照深度	≥800	Light head thickness(mm) ±5 灯头厚度	92
Illumination Depth 60%(mm) 光照深度	616	Radiation energy 辐射能量	<441w/m2
CRI (%) Ra 显色指数	≥95	Ee/Ec [mW/(m2.lx)]	<3mW/(m2.lx)
Illumination (lux) 100stages Adjustment 照度调节	40000-120000	Install Height(2.5m can be customized) 安装高度(可定制 2.5m)	2.75-3.1m
Color Temperature (K) Adjustment 色温调节	4000-5000	Optional Controller 控制器 (选配)	4.3" touch controller, 2.4" touch controller
Lamp power 灯泡功率	65VA	Optional Battery 电池 (选配)	Yes, As back up usage
Voltage 电压	AC 100V-240V	Install method 安装方式	Ceiling or Wall Mounted Optional
Frequency频率	50/60Hz		

Mobile LED Surgical Light 移动手术灯

BT681E-500Y

Optional
可选

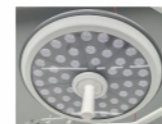

Back Up Built-in battery:

1. rechargeable
2. continuous operation
3. charge level indicator charging yellow; full charge: green color. When the lamp is open, if the battery is exhausted, it will be fully charged automatically.
4. Usage time over 3hours at max brightness 120000lux



500 light head thickness
reference picture

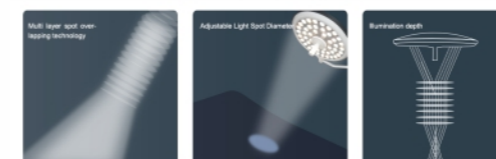

Adjustable Uniform Light Field

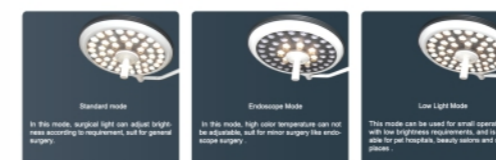

3pcs lighting mode

Characteristics	500 dome
Voltage 电压	AC100-240V, 50/60Hz
Apparent Power 功率	70VA
Illumination(adjustment) 照度	40000lux-120000lux (100stages)
Color Temperature 色温	4000K-5000K (adjustable)
Field Diameter 照明直径	120-280mm (adjustable)
Lighting Depth (L1+L2) 照明深度	≥800mm
LED Quantity 数量	48pcs
LED Brand 品牌	Germany Osram
CRI Ra 显色指数	≥95
LED Bulb max. Power 灯泡最大功率	Rated power 3W, actual power<1W
Light head thickness 灯头厚度	92mm approx.
Light head diameter 灯头直径	500mm

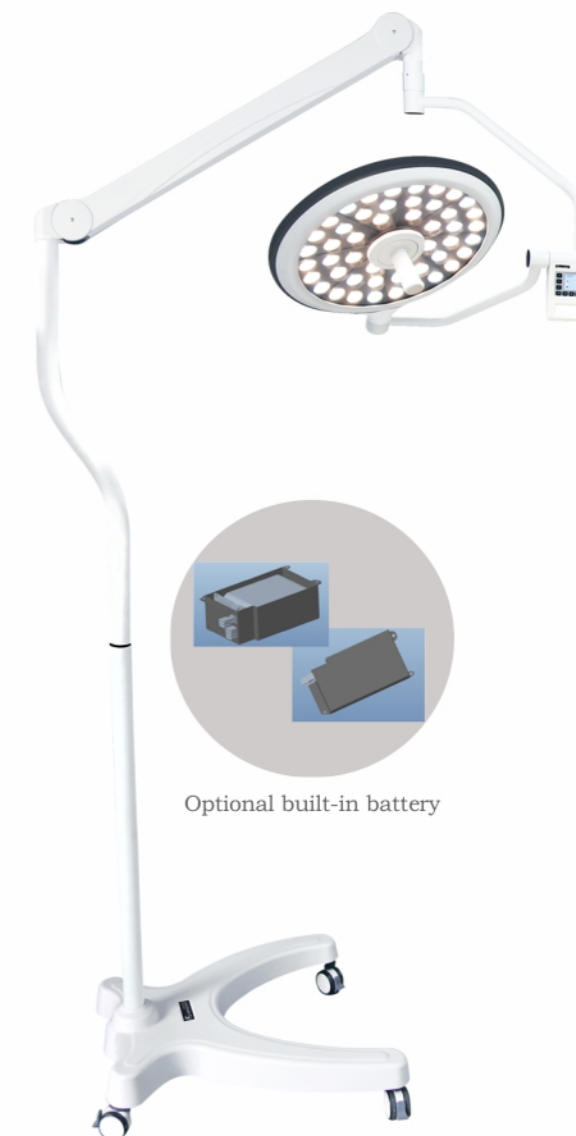

Optional built-in battery

OPERATION LIGHT



Examination Lamp 检查灯

BT310A

| Size (尺寸)
500×500×1900mm



X-ray Film Viewer 观片灯

BT345-1

| Size (尺寸)
476×500×25mm



X-ray Film Viewer 检查灯

BT345-2

| Size (尺寸)
836×500×25mm

Recliner Chair 老年躺椅

BT682A

| Size (尺寸)
1100×770×1800mm
| Table size (餐桌尺寸)
480×260mm
| Safe working load (安全承重)
120KGS/260LBS



Functions (功能) :

* Recliner includes user friendly features,such as adjustment angle of gas spring, two side convenient overlap tray and foot-rest which fold completely under chair.Allowing users to rise to a standing position more easily.Easy to macuver,it features four casters,two of which can be lock for security. 面料为优质环保皮革, 钢管喷塑, 气动调节角度, 两侧塑料餐桌, 5寸脚轮, 头枕可以调节角度, 侧板整体注塑成型易于安装清洗。

Electric Dialysis chair 电动透析椅

BT682B

| Size (尺寸)
1900×880×600mm
| Safe working load (安全承重)
200KGS/440LBS
| Material (材质)
Painted Steel PVC Leather皮革



Functions (功能) :

* The fabric is pressed PVC artificial leather the chair includes user friendly features,such as adjustment angle of electric ,CPR function , headrest,foot step,Trendelenburg Position. 面料为优质环保皮革, 钢管喷塑, 电动调节角度, 后倾调节, CPR功能, 4寸脚轮, 带脚踏、头枕、输液架, 豪华舒适。

| Accessories (配件)
Adjusted dinner table, I.V pole ,headrest and footrest
可调餐桌, 输液杆, 枕头, 脚踏

Blood Drawing Chair 采血椅

BT680-B

| Size (尺寸) | Size (open)
680×650×950mm 680×650×950mm
| Material (材质)
Painted Steel, PVC Leather 钢管喷塑+PVC
| Color option (可选颜色)
Blue/black 蓝色, 黑色



Functions (功能) :

* The chair armrest can adjust height and turnover 扶手高度调节, 可以翻转。

Bedside Cabinet 床头柜

BT159

| Size (尺寸) 480×480×760mm | Material(材质) ABS 全新ABS



Bedside Cabinet 床头柜

BT159B

| Size (尺寸) 480×480×880mm | Material(材质) Recycled ABS 部分ABS新料



Bedside Cabinet 床头柜

BT162

| Size (尺寸) 460×470×760mm | Material(材质) ABS plastic+steel ABS塑料+钢制喷塑



Bedside Cabinet 床头柜

BT162C

| Size (尺寸) 460×480×760mm



MEDICAL TROLLEY

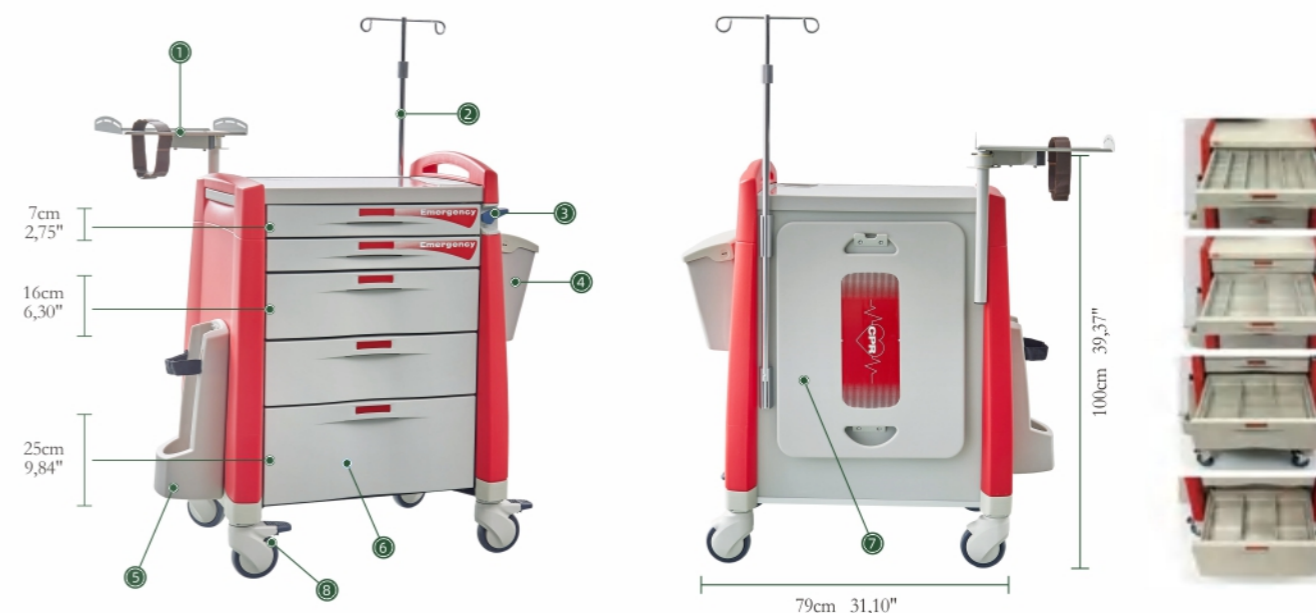

- ① Defibrillator shelf w. multi position 380×340mm
除颤器架子 380mm×340mm
- ② I.V.pole fully adjustable
I.V.可调式输液支架
- ③ Keyless lock plastic seal
密封手柄
- ④ waste bin with lid
垃圾桶
- ⑤ Oxygen tank holder(max.5 it)
氧气瓶底座
- ⑥ Drawer-vertical divider and Horizontal sub-dividers with telescopic slides rail
抽屉式垂直分隔器和带伸缩滑轨的水平分隔器
- ⑦ Cardiac board 475×595×8,5mm
心肺复苏板475×595×8.5mm
- ⑧ Casters; 2 pcs with lock
2pcs without lock 5inch5
英寸脚轮 (2个带锁,2个不带锁)

Emergency Cart 急救推车

BT168AM-100



Size (尺寸)
790×610×1000mm

Max load(最大承重)
100kgs

Material(材质)
ABS+Aluminum frame+ TPR castor

Accessories (标配) :

90° rotatable defibrillator shelf 可90° 旋转除颤仪支架	Break-away with disposable lock*10 一次性锁*10条
Waste bin with lid 带盖垃圾桶	Divider, small*30 抽屉小间隔板*30
Oxygen tank 5L holder 容量为5L氧气瓶架	Divider,medium*15 抽屉中间隔板*15
CPR board 心肺复苏版	Divider,large*10 抽屉大间隔板*10
Height adjustable IV pole 可调节输液杆	Horizontal sub-dividers,small*8 抽屉矮间隔板*8
Surface panel protective cover 面板胶片	Horizontal sub-dividers,large*6 抽屉高间隔板*6
5 inch casters*4 (double brakes) 5寸脚轮*4 (双刹)	

Medication Cart 送药推车

BT168BM-100



Size (尺寸)
790×610×1000mm

Max load(最大承重)
100kgs

Material(材质)
ABS+Aluminum frame+ TPR castor

Accessories (标配) :

Waste bin with lid 带盖垃圾桶	Divider,medium*15 抽屉中间隔板*15
Surface panel protective cover 面板胶片	Divider,large*10 抽屉大间隔板*10
5 inch casters*4 (double brakes) 5寸脚轮*4 (双刹)	Horizontal sub-dividers,small*8 抽屉矮间隔板*8
Break-away with disposable lock*10 一次性锁*10条	Horizontal sub-dividers,large*6 抽屉高间隔板*6
Divider, small*30 抽屉小间隔板*30	

Anesthesia Cart 麻醉推车

BT168FM-100



Size (尺寸)
790×610×1000mm

Max load(最大承重)
100kgs

Material(材质)
ABS+Aluminum frame+ TPR castor

Accessories (标配) :

Anesthesia stand with box 麻醉斗	Divider, small*30 抽屉小间隔板*30
Waste bin with lid 带盖垃圾桶	Divider, medium*15 抽屉中间隔板*15
Surface panel protective cover 面板胶片	Divider, large*10 抽屉大间隔板*10
5 inch casters*4 (double brakes) 5寸脚轮*4 (双刹)	Horizontal sub-dividers, small*8 抽屉矮间隔板*8
Break-away with disposable lock*10 一次性锁*10条	Horizontal sub-dividers, large*6 抽屉高间隔板*6

► The size of the drawer complies with international standards, and the large drawer can meet the storage of large medical equipment with a height of 250MM; the large, medium and small drawers can be adjusted independently according to the needs of the department (see pages 10-11 for details); the internal partition of the drawer is a modular design, and the user can The classification and storage of medicines and articles of different specifications can be freely adjusted according to the use, and the separator is designed for visualization, which is convenient for quick viewing.



► Four 5-inch double-bearing casters (dual-steering casters are more labor-saving during the pushing process, and two with brake wheels are on the front of the cart for easy operation); installation and maintenance are convenient, and there is no need to remove other accessories when replacing the casters in the future.



► The side and back of the cart are designed with side pull writing board, oxygen tank holder, waste bin with lid, sharps box, glove box, tissue box, hand sanitizer holder, tool hook, CPR board, adjustable aluminum alloy infusion pole, expansion fixing plate, anesthesia box, adjustable support arm, etc. (some are optional accessories, see the cart parameter page and optional list for details).

► The left and right side panels are double-layered, with accessory nut mounting positions on the inner side, and users can open holes to install accessories according to configuration requirements.



Color Available

CART Colours



- 90cm / 36"
- 100cm / 40"
- 110cm / 43"



- 90cm / 36"
- 100cm / 40"
- 110cm / 43"



- 90cm / 36"
- 100cm / 40"
- 110cm / 43"

- Regular product
- Unconventional products (quantity is required, price and delivery time are subject to change)

Lock System Options

(Safety management of drawer locks is managed hierarchically according to departments and needs, and can be selected according to the level)



► Break-away with disposable number lock

Anyone who can access the trolley can unlock it at any time. After unlocking, the numbering bar is disconnected and cannot be reused. After unlocking, you should check and replenish the first aid supplies in the car and re-lock it to prepare for the next emergency (suitable for Emergency Cart is used to store first aid medicine and equipment, mainly used in emergency areas, ICU wards, etc.)



► Key Lock

Those who have a special unlock key can unlock the lock, and the user manages it according to the user. If the key is lost, the administrator can quickly replace the lock core and issue a new unlock key with the management key (suitable for the storage of common medicines and equipment in medicine cart, the main application in outpatient areas, pharmacies, inpatient floors, etc.).



► Digital lock

Three groups of passwords can be set, and those who know the unlocking password can unlock the lock, and the password can be modified and deleted. When the password is forgotten or the battery is low, the general mechanical lock can be used to unlock, and the user can manage according to the user (suitable for medicine cart, anesthesia cart. Store controlled drugs and equipment, mainly used in pharmacies, operating rooms, etc.)

Drawer Size Available

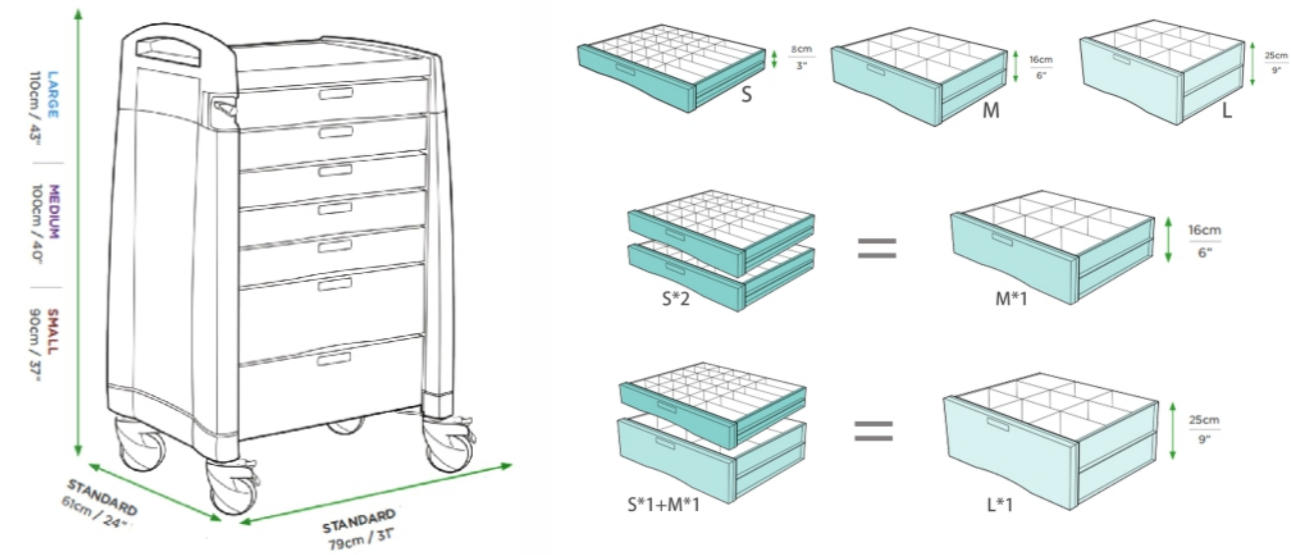

Drawer Match

Drawer description: small drawer=1, medium drawer=2, large drawer=3

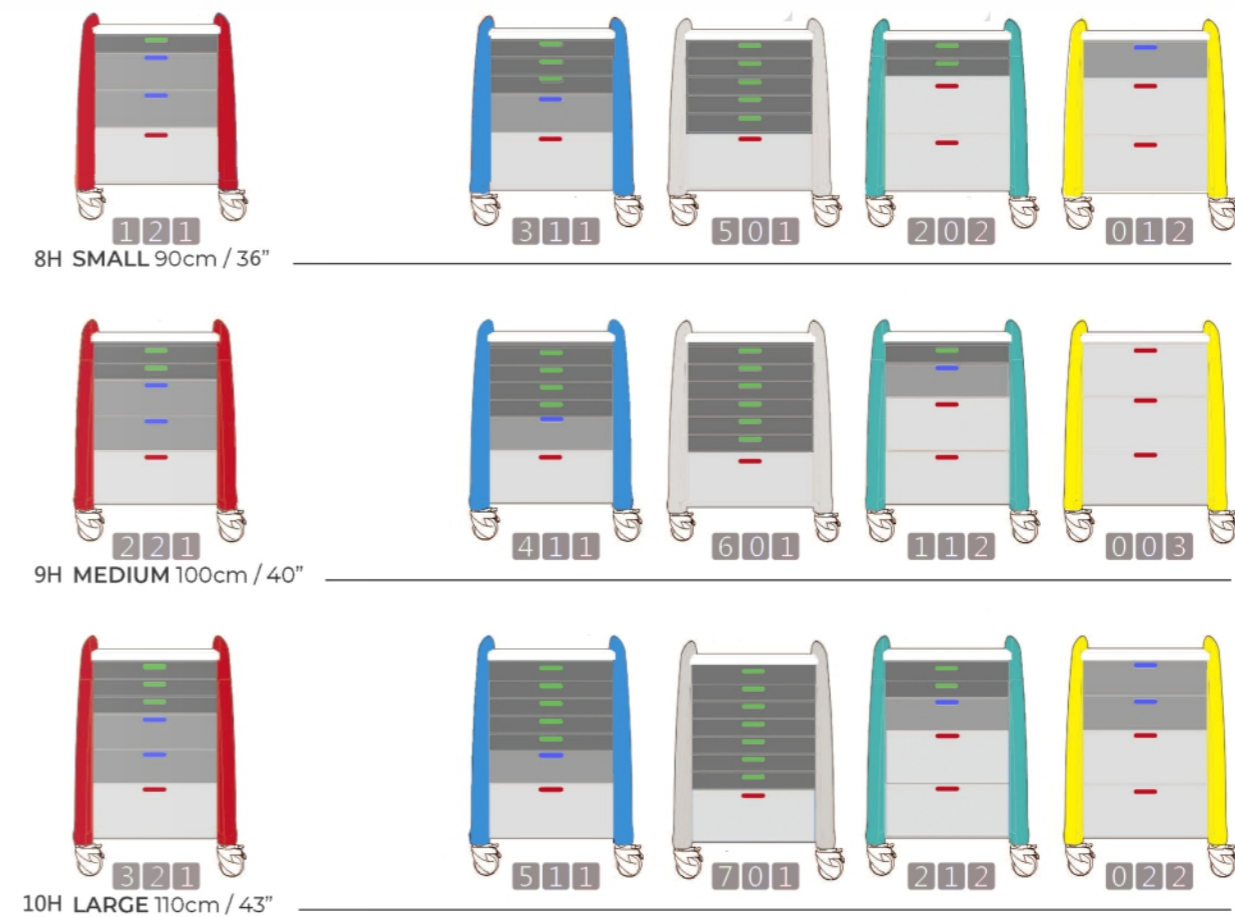

Optional List



C192
Oxygen Tank Holder



PJZC-95
Defibrillator Shelf



PJZC-96
IV Pole



C191
CPR Board



MQZC-0016
Anesthesia Frame



C244/C245
Anesthesia (L/4 cells)
Anesthesia (M/5 cells)



C210
Waste Bin With Lid



PJZC-97
Adjustable Support Arm



C216SC
Sharp Box Cabinet



C253-1
Glove Holder -
Direct Mount



C253-2
Glove Holder



C216SB
4.6L Disposable
Sharps Container



PJZC-98
Sharp Box

Accessories



C187-1
Low Drawer Bucket



C188-1
Drawer Bucket



C187-2
Low DrawerFront Panel



C188-2
Medium DrawerFront Panel



C188-3
Tall DrawerFront Panel



C205-1
Horizontal Sub-
Dividers, Small



C204-1
Horizontal sub-
Dividers, Large



C205-3
Drawer Dividers, small

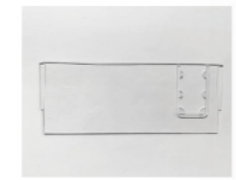

C205-2
Drawer Dividers, Medium

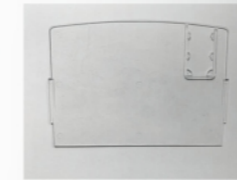

C204-2
Drawer Dividers, large



BT30A-5
5 Inch Caster



BT30A-5
5 Inch Caster
With Brakes



C184
Right Side Panel



C185
Left Side Panel



C243-100
Back Board

ABS Emergency Trolley ABS急救推车

BT170A

Size (尺寸)
760×480×920mm



ABS Drug Trolley ABS送药车

BT170B

Size (尺寸)
760×480×920mm



ABS Treatment Trolley ABS治疗推车

BT170C

Size (尺寸)
760×480×920mm



ABS Anesthesia Trolley ABS麻醉推车

BT170D

Size (尺寸)
760×480×920mm



ABS Treatment Trolley ABS治疗推车

BT170H

Size (尺寸)
760×480×920mm



ABS Treatment Trolley ABS治疗推车

BT170K

Size (尺寸)
760×480×920mm



Emergency Trolley 急救推车

BT180A

| Size (尺寸)
850×520×950mm



Medicine Trolley 送药推车

BT180B

| Size (尺寸)
850×520×950mm



Medicine Trolley 送药推车

BT180H

| Size (尺寸)
850×520×950mm



Medical record Trolley 病历推车

BT198-25

| Size (尺寸)
450×410×990mm



Medical Record Trolley 病历推车

BT198-50

| Size (尺寸)
750×410×990mm



Manual Up/Down Emergency Stretcher 手动急救担架车

BT201



| Size (尺寸)
2050×710×570-860mm

Functions (功能) :

- Backrest adjustment: 0~65° ± 5°
背部调节: 0~65° ± 5°
- Hi-Low adjustment: 570-860mm
高度调节: 570-860mm
- Steering wheels function
定向功能
- Central-brake function
中控制车功能

Accessories (标配) :

6" central-brake castors (6英寸(150mm)中控制车)	4pcs	PP side rails (1副PP 护栏)	1pair
Steering wheel (1个定向轮)	1pc	Oxygen cylinder holder (1个氧气瓶支架)	1pc
Central-brake pedals (2个中控制脚踏)	2pcs	I.V rod holder (2个输液杆支撑孔)	2pcs
Pedal for steering wheels (1个定向轮脚踏)	1pc	Safety belts (2个安全带)	2pcs
Stainless steel crank (1个不锈钢摇手柄)	1pc		

Manual Up/Down Transfer Stretcher

BT201C 转移担架车

| Size (尺寸)
1930×645×510-850mm



Hydraulic Up/Down Transfer Stretcher

BT202A 液压转移担架车

| Size (尺寸)
2070×750×625-850mm



Hydraulic Up/Down Transfer Stretcher

BT202C 液压转移担架车

| Size (尺寸)
1880×620×560-890mm



Ambulance Stretcher 救护车担架车

BT203A



| Size (尺寸)
190×58×91.5mm

| Max load(最大承重)
160kgs

| Folding Size (折叠后尺寸)
201×58×22.5mm

Detailed Product Description (产品详细说明) :

Made with solid aluminum alloy, make the stretcher firm and durable.
采用坚固的铝合金制成, 使担架坚固耐用。

Adjustable backrest and footrest moved by a gas spring which allows to fix in any position.
可调节的靠背和脚踏板由气弹簧移动, 可固定任何位置

Plastic wedges protect the legs from hurting
塑料楔子保护腿部免受伤害

Full sets of front and back lock mechanism, with 2 safety
全套前后锁止机构, 带2个安全装置

straps, mattress, pillow and I.V. pole.
安全带、床垫、枕头、输液杆

Aluminum Ambulance Stretcher 救护车担架车

BT204

| Size (尺寸)
1960×550×920mm



Aluminum Emerg Stretcher 急救担架车

BT210

| Size (尺寸)
1900×550×540-880mm



Aluminum Ambulance Stretcher 救护车担架车

BT205

| Size (尺寸)
1960×550×860mm



Stainless Steel Emergency Stretcher 急救担架车

BT211

| Size (尺寸)
1900×650×700mm



Stair Stretcher 楼梯担架

BT206-B

| Size (尺寸)
900×510×910mm



Folding Stretcher 折叠担架

BT251

| Size (尺寸)
2080×550×130mm



Folding Stretcher 折叠担架

BT252

| Size (尺寸)
2200×550×150mm



Scoop Stretcher 铲式担架

BT253

| Size (尺寸)
2100×440×60mm



Rolling Splints 夹板

BT255

| Size (尺寸)
120×45mm, 460×110mm
760×110mm, 920×110mm



Mattress 床垫

BT301A

| Size (尺寸)
1950×840×140mm

| Material (材质)
High density sponge+Nylon fabric

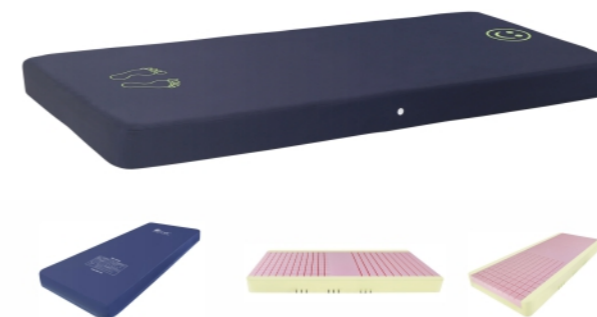

Mattress 床垫

BT301B

| Size (尺寸)
1950×840×120mm

| Material (材质)
High density sponge+Nylon fabric

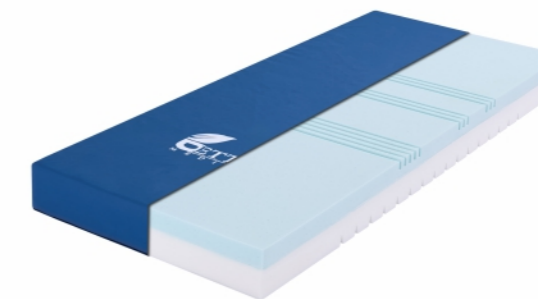

Mattress 床垫

BT303C

| Size (尺寸)
1950×840×100mm

| Material (材质)
High density sponge+PU cover



Mattress 床垫

BT302D

| Size (尺寸)
2050×900×120mm

| Material (材质)
TPR/PVC



Mattress 床垫

BT303

| Size (尺寸)
1950×840×80mm

| Material(材质)
Oxford fabric+High density sponge+Coconut fibre



Mattress 床垫

BT304A

| Size (尺寸)
1950×840×50mm

| Material(材质)
POE



Turning Mattress

BT304 翻身床垫

| Size (尺寸)
2000×900×210mm

| Material(材质)
TPU/PVC



Air Mattress 充气床垫

BT305L/BT305X

| Size (尺寸)
1950×840×100mm



Air Mattress 充气床垫

BT306L/BT306X

| Size (尺寸)
1950×840×70mm



I.V Stand

BT311L 输液杆

| Size (尺寸)
640×640×1330-2250mm



I.V Stand

BT311B 输液杆

| Size (尺寸)
640×640×1330-2250mm



I.V Stand

BT311C 输液杆

| Size (尺寸)
640×640×1330-2250mm

I.V STAND

I.V Stand

BT311T 输液杆

Size (尺寸)
500×500×1460-2400mm



Specification:

- Size: 500×500×1460-2400mm,
- Pipe diameter: 19+25mm

Standard Accessories:

- 5pcs 3" TPR castors two with brake
- 1 set stainless steel hooks
- 1pc plate with handle

Optional:

- Infusion pump holder, oxygen cylinder holder

Others:

- Height adjustable
- Castor on base

Material:

- #304 stainless steel + steel base
- Stainless steel pipe, Steel epoxy base
- stainless steel hooks

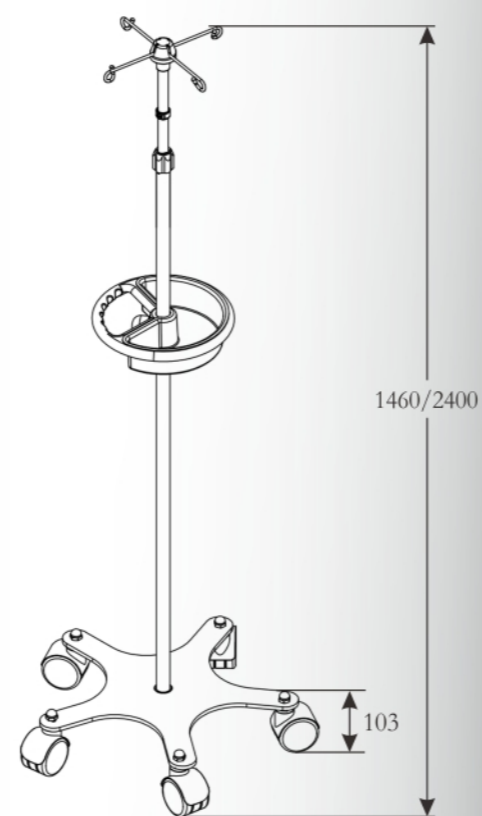

Instrument Trolley 器械车

BT121

Size (尺寸)
(L) 1120×580×980mm
(M) 900×540×850mm
(S) 680×510×800mm



Dirty Linen Trolley 污物车

BT130A

Size (尺寸)
550×550×900mm



Instrument Cabinet 器械柜

BT154

Size (尺寸)
900×400×1750mm



Instrument Cabinet 器械柜

BT155

Size (尺寸)
900×400×1750mm



Instrument Cabinet 器械柜

BT156

Size (尺寸)
1500×1500×900/1980mm



Wash-hand Stand 洗手池

BT157

Size (尺寸)
1600×660×900mm



Wash-hand Stand 洗手盆

BT317-1

| Size (尺寸)
400×350×750mm



Wash-hand Stand 洗手盆

BT317-2

| Size (尺寸)
800×350×750mm



Mayo Table 手术托盆

BT318

| Size (尺寸)
600×500×800-1120mm



Mayo Table 手术托盆

BT318A

| Size (尺寸)
600×500×800-1120mm



Mayo Table 手术托盆

BT318B

| Size (尺寸)
600×500×800-1120mm



Doctor Stool 凳子

BT319A

| Size (尺寸)
Ø360×450-580mm



Doctor Stool 凳子

BT319C

| Size (尺寸)
Ø360×450-580mm



ABS Dinning Table ABS餐板

BT343

| Size (尺寸)
(870-1050)×310×20mm



ABS Dinning Table ABS餐板

BT343C

| Size (尺寸)
1030×350×50mm



3-foldings Ward Screen 三折屏风

BT340-3

| Size (尺寸)
(600×3)×430×1800mm



4-foldings Ward Screen 四折屏风

BT340-4

| Size (尺寸)
(600×4)×430×1800mm



OVER BED TABLE



Over Bed Table 床边桌 BT647A

| Size (尺寸)
900×400×740-1050mm
| Material(材质)
MDF top board+aluminum+epoxy coated steel
Height adjustment by gas spring



Over Bed Table 床边桌 BT647C

| Size (尺寸)
760×385×740-1050mm
| Material(材质)
MDF top board+epoxy coated steel+PP
Height adjustment by gas spring



Over Bed Table 床边桌 BT647D

| Size (尺寸)
760×385×530-830mm
| Material(材质)
MDF top board+epoxy coated steel+PP
Height adjustment by manual knob



Over Bed Table 床边桌 BT647F

| Size (尺寸)
760×385×530-830mm
| Material(材质)
MDF top board+epoxy coated steel+PP
Height adjustment by manual knob



Over Bed Table 床边桌 BT647K

| Size (尺寸)
600×400×735-935mm
| Material(材质)
MDF top board+epoxy coated steel+PP
Height adjustment by manual knob



Over Bed Table 床边桌 BT647R

| Size (尺寸)
900×400×740-1050mm
| Material(材质)
Material:ABS top board+Aluminum+epoxy coated steel Height adjustment by gas spring



Manual Shower Bed 手动洗澡床

BT612A

| Size (尺寸)
2000×770×520~700mm



Patient Lifting Frame 移位机

BT260A-270

| Size (尺寸)
1240×650×800-1800mm

| Material(材质)
Aluminum alloy

| Capacity weight(承重)
270kgs



Hydraulic Shower Bed 液压洗澡床

BT612B

| Size (尺寸)
2000×770×600-900mm



Patient Lifting Frame 移位机

BT260B-150

| Size (尺寸)
1190×590×720-1730mm

| Material(材质)
Steel electrostatic spraying

| Capacity weight(承重)
150kgs

Electric Shower Bed 电动洗澡床

BT612C

| Size (尺寸)
2000×770×600-900mm



Patient Lifting Frame 移位机

BT260C-150

| Size (尺寸)
1180×710×720-1610mm

| Material(材质)
Aluminum alloy

| Capacity weight(承重)
150kgs





Desk 适老化桌子

T10A

| Size (尺寸)
1000×860×750mm



Desk 适老化桌子

T10B

| Size (尺寸)
1600×830×750mm



Desk 适老化桌子

T10C

| Size (尺寸)
1400×760×750mm



Chair 适老化椅子

11A

| Size (尺寸)
460×480×880mm



Chair 适老化椅子

11B

| Size (尺寸)
460×480×820mm



Lift Recliners

T20A 起身沙发

| 4 Motor, safe working load of 170kgs

| Selective Color

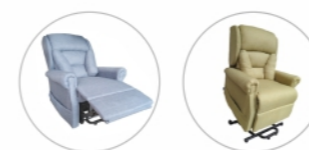

Lift Recliners

T20B 起身沙发

| 4 Motor, safe working load of 170kgs

| Selective Color



Luxurious Accompanier's Chair

BT687-A 豪华陪护椅

| 850×860×450mm (靠背高: 900mm)
展开: 2000×860×640mm

| 沙发式外观设计, 面料为环保型PVC压延仿皮, 实木扶手, 框架为部分钢架结构, 隐藏储物盒, 隐藏式静音脚轮, 椅子内部有伸缩弹簧, 收放自如。
Description: sofa style appearance design, the fabric is pressed PVC artificial leather, wooden armrest, the frame is partial steel structure, hidden storage, hidden mute casters, extension spring inside, easy to close and open.



Bedside Table 适老化桌子

T30A

Size (尺寸)
505×455×655mm



Bedside Table 适老化桌子

T30B

Size (尺寸)
505×455×655mm



Closet 衣柜

T31A

Size (尺寸)
800×500×2000mm

HOME CARE BED

BT630 Series



5 Function Electric Homecare Bed

BT630E-5A 五功能电动养老护理床

Size (尺寸)
L2119×W1020×H120-760mm

Mattress platform (床面尺寸)
1940×840mm

Safe working load (安全承重)
180KGS/400LBS



Backrest adjustment: 0~60°
背部调节: 0~60°



Footrest adjustment: 0~40°
腿部调节: 0~40°



Height adjustment: 120-760mm
整体升降: 120-760mm



Reverse & Trendelenburg 0-20°
前后倾斜: 0-20°

特点:

- Ultra-low 120mm (超低120mm)
- Bed Extension (床尾延长) 2120-2320mm
- Wooden bedboard and footboard (实木床头/床尾板)
- Various guardrails available (适用多种护栏)

5 Function Electric Homecare Bed

BT630E-5B 五功能电动养老护理床

Size (尺寸)
L2119×W1020×H70-470mm

Mattress platform (床面尺寸)
1940×840mm

Safe working load (安全承重)
180KGS/400LBS



Backrest adjustment: 0~60°
背部调节: 0~60°



Footrest adjustment: 0~40°
腿部调节: 0~40°



Height adjustment: 70-470mm
整体升降: 70-470mm



Reverse & Trendelenburg 0-20°
前后倾斜: 0-20°

特点:

- Ultra-low 70mm (超低70mm)
- Wooden bedboard and footboard (实木床头/床尾板)
- Various guardrails available (适用多种护栏)
- Knock-down packing, small package (可拆卸, 包装体积小)

5 Function Electric Homecare Bed

BT630E-5C 五功能电动养老护理床

Size (尺寸)
L2119×W1020×H400-800mm

Mattress platform (床面尺寸)
1940×840mm

Safe working load (安全承重)
180KGS/400LBS



3 Function Electric Homecare Bed

BT630E-3A 三功能电动养老护理床

Size (尺寸)
L2119×W1020×H230-760mm

Mattress platform (床面尺寸)
1940×840mm

Safe working load (安全承重)
180KGS/400LBS

2 Function Electric Homecare Bed

BT630E-2A 两功能电动养老护理床

Size (尺寸)
L2119×W1020×H400/450/550mm

Mattress platform (床面尺寸)
1940×840mm

Safe working load (安全承重)
180KGS/400LBS



HOME CARE BED

BT633 Series



2 Function Electric Homecare Bed

BT633E-2B 两功能电动家居床

Product size (尺寸):
Single:910×2030mm King single:1070×2030mm

- Features (特点):
- Head and foot control
 - Wireless remote
 - 2pcs German okin motors
 - 1pc foot stopper
 - 4pcs fixed legs in 25CM
 - Head and foot vibration massage
 - Child lock/Memory programmable/Zero gravity /TV/Lounge/Anti-snore/Torch light
 - One button flat preset function
 - Under-bed lighting



2 Function Electric Homecare Bed

BT633E-2C 两功能电动家居床

Product size (尺寸):
Single:910×2030mm King single:1070×2030mm Queen:1530×2030mm

- Features (特点):
- Independent Back&leg Elevations, Flat,Zero Gravity and memory positions setting
 - Wireless Remote with Illuminated buttons
 - Two Okin Motors+vibration massage+ bluetooth app control
 - Folded Metal Frame
 - Removable Legs
 - LED light under bed
 - Anti-slip fabric in middle

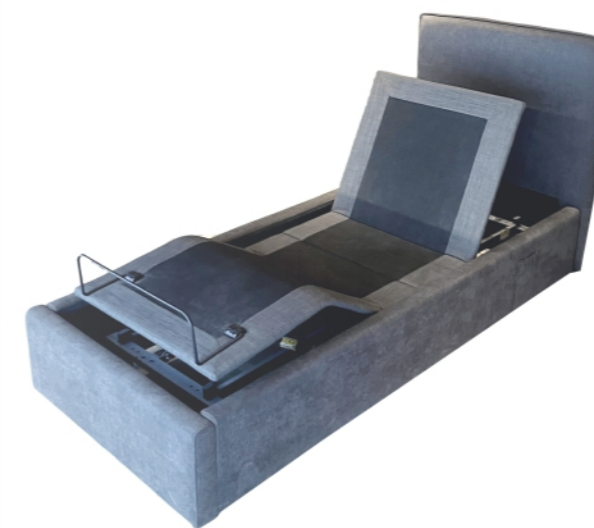

5 Function Electric Homecare Bed

BT633E-5A 五功能电动家居床

Product size (尺寸):
Single:910×2030mm King single:1070×2030mm

- Features (特点):
- Hi low function
 - Head and foot up and down
 - Trendelenburg and Reverse Trendelenburg
 - Child lock/Memory programmable/Zero Gravity/One button flat preset
 - Wireless remote
 - 1pc foot stopper
 - 8pcs castors with brake
 - 4pcs german okin motors
 - Head and foot massage
 - Under-bed lighting

