

PANELES DECORATIVOS



Contamos con servicio personalizado de corte en Plasma CNC, especializados en el diseño y fabricación de celosías para la elaboración de:

- **Puertas**
- **Portones**
- **Protecciones**
- **Barandales**
- **Fachadas**
- **Muros divisorios**
- **Plafones**
- **Rejas**
- **Elementos decorativos**
- **Elementos artísticos**
- **Números exteriores**
- **Logotipos y anuncios**





PUERTAS



PERGOLAS



FACHADAS



BALCONES



BARANDALES



NÚMEROS



PROTECCIONES



DECORACIONES



DIVISIONES



TECHADOS



PORTONES

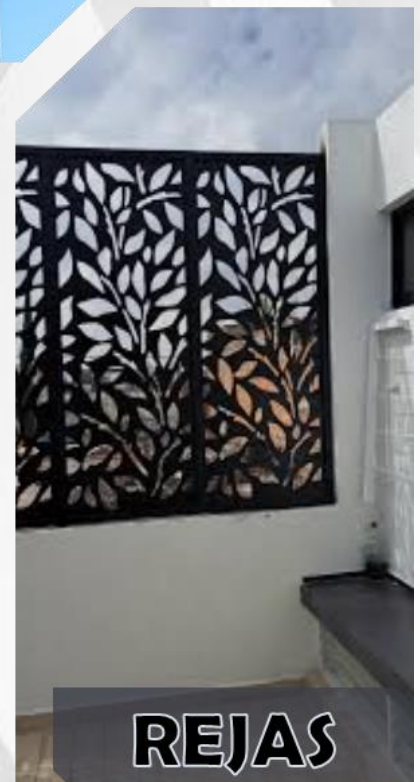

REJAS



FACHADAS



PUERTAS

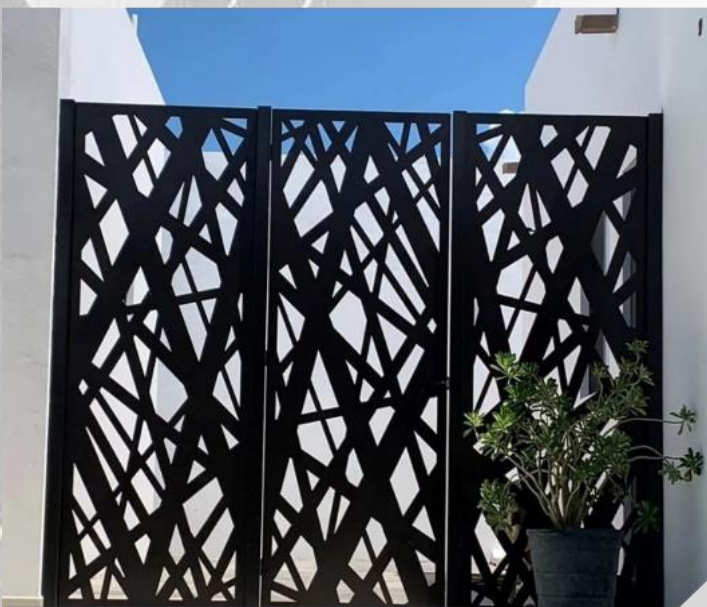

DIVISIONES

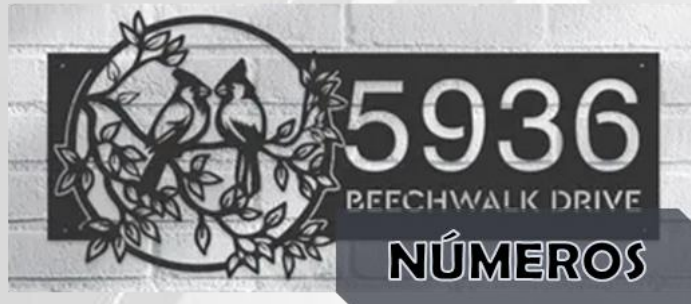

NÚMEROS

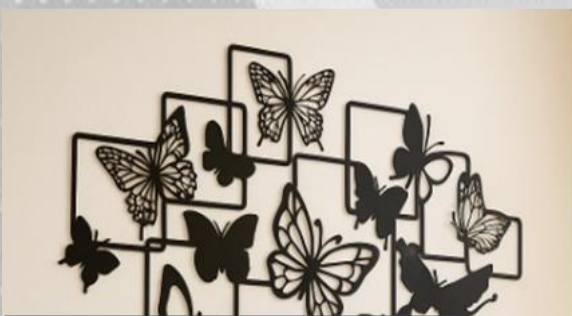

DECORACIONES



ANUNCIOS

- +52 443 115 6240
- Morelia, Michoacán
- practitools.mx@gmail.com
- Practitools Mx

ABSTRACTO

XST01-C

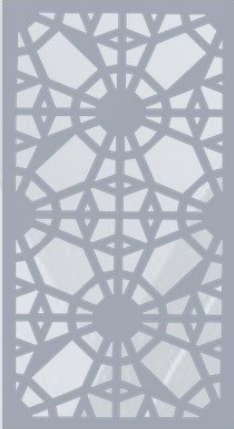

XST02-C



XST03-C

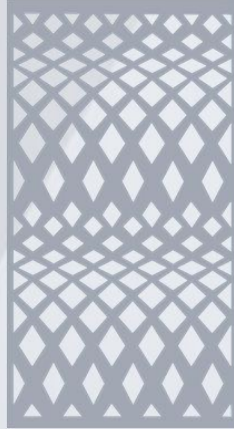

XST04-C



XST05-C

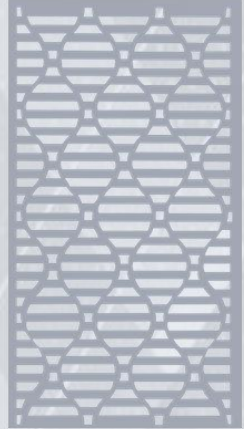

XST06-C



XST07-C



XST08-C



XST09-C



XST10-C



XST11-C

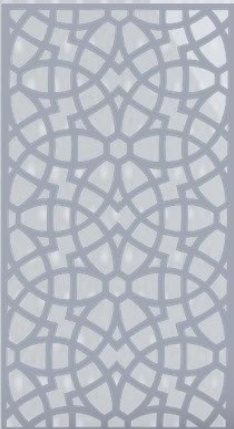

XST12-C

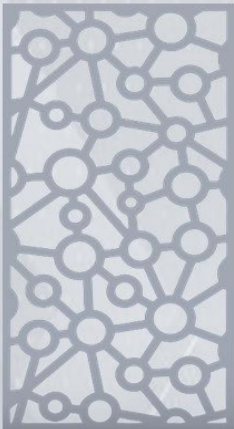

XST13-C



XST14-C

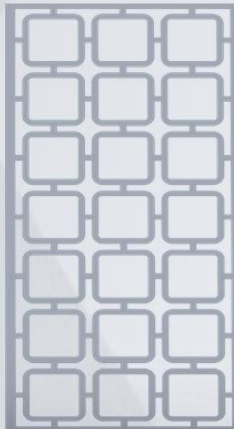

XST15-C



ANIMALES

XST01-A



XST02-A



XST03-A



XST04-A



XST05-A



XST06-A



XST07-A



XST08-A



XST09-A



XST10-A



XST11-A



XST12-A



XST13-A



XST14-A



XST15-A

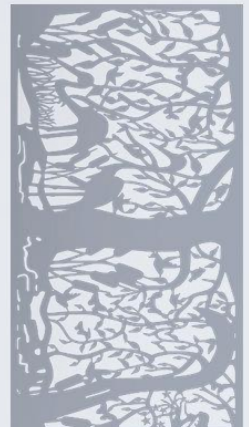

ARBÓREOS

XST01-T



XST02-T



XST03-T



XST04-T



XST05-T



XST06-T



XST07-T



XST08-T



XST09-T



XST10-T



XST11-T



XST12-T



XST13-T



XST14-T



FLORALES

XST01-F



XST02-F



XST03-F



XST04-F



XST05-F



XST06-F

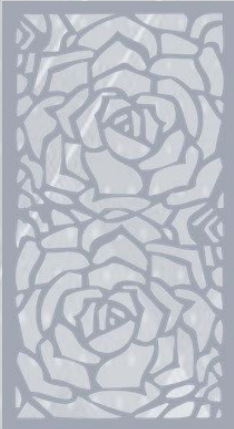

XST07-F



XST08-F



XST09-F



XST10-F



XST11-F



XST12-F

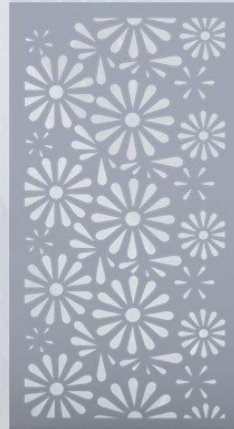

XST13-F



XST14-F



XST15-F



GEOMÉTRICOS

XST01-G

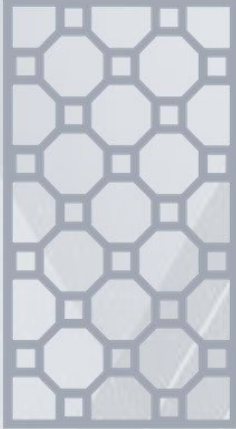

XST02-G

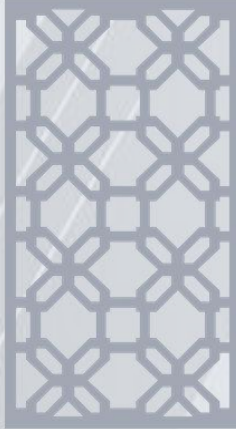

XST03-G

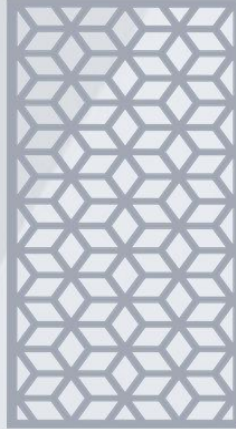

XST04-G

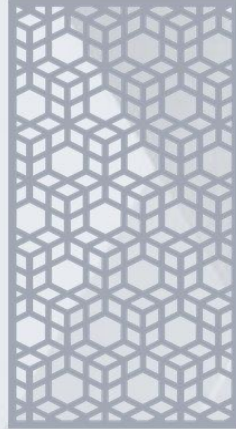

XST05-G

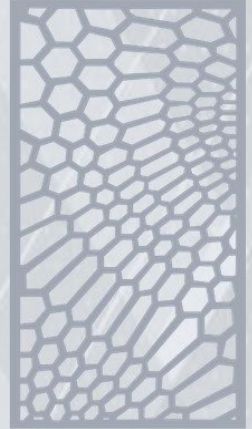

XST06-G

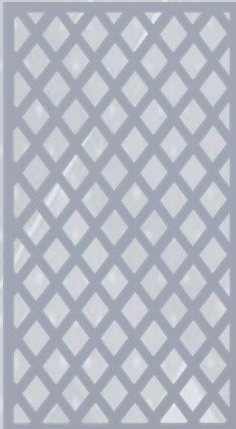

XST07-G



XST08-G

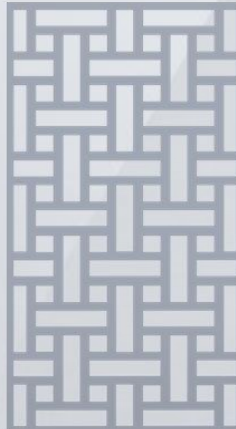

XST09-G

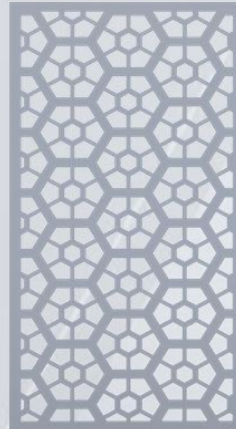

XST10-G

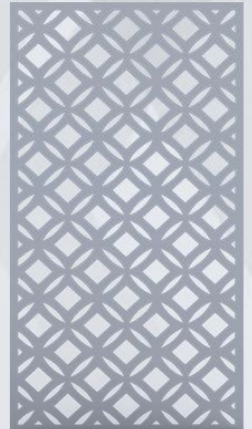

XST11-G

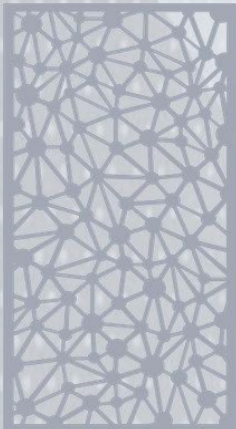

XST12-G

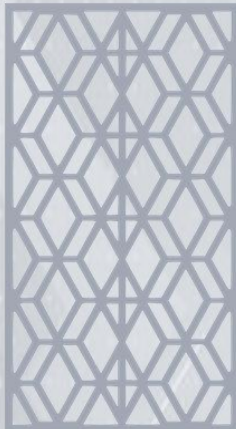

XST13-G

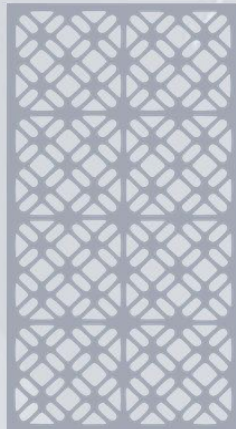

XST14-G

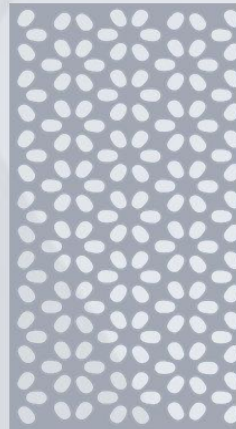

XST15-G

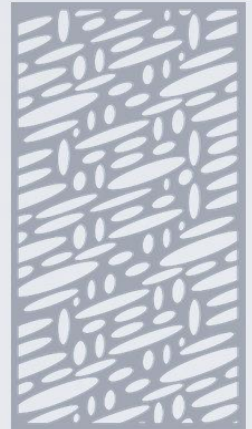

HOJAS

XST01-H



XST02-H



XST03-H



XST04-H



XST05-H

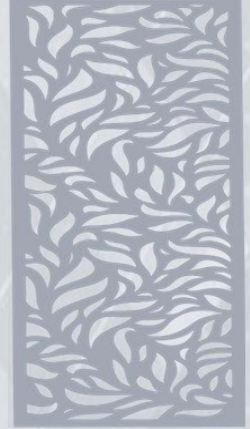

XST06-H



XST07-H



XST08-H



XST09-H



XST10-H



XST11-H



XST12-H



XST13-H



XST14-H



XST15-H



LÍNEAS

XST01-L



XST02-L



XST03-L



XST04-L



XST05-L

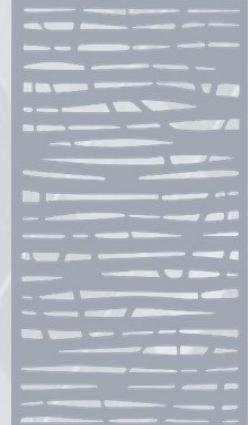

XST06-L



XST07-L



XST08-L



XST09-L



XST10-L

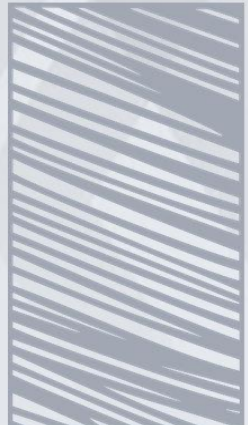

XST11-L



XST12-L



XST13-L

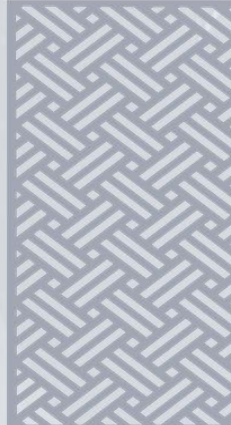

XST14-L



XST15-L

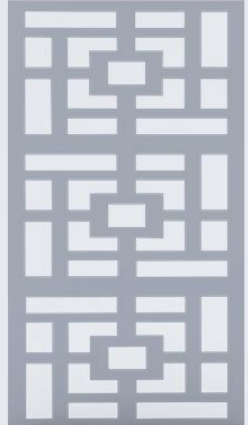

VORONOI

XST01-0



XST02-0



XST03-0

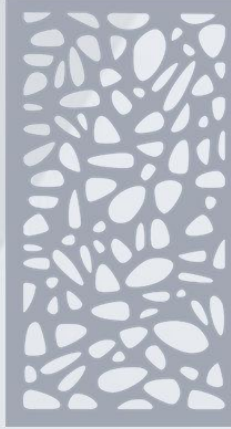

XST04-0



XST05-0



XST06-0



XST07-0

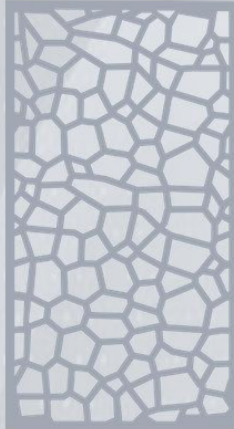

XST08-0



XST09-0



XST10-0

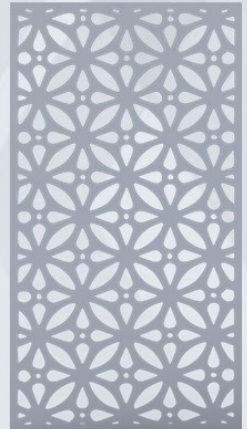

XST11-0

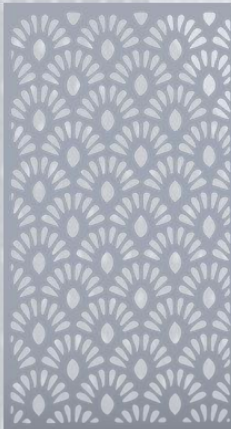

XST12-0

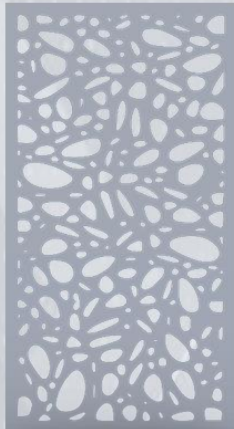

XST13-0



XST14-0



XST15-0



VINTAGE

XST01-V



XST02-V



XST03-V

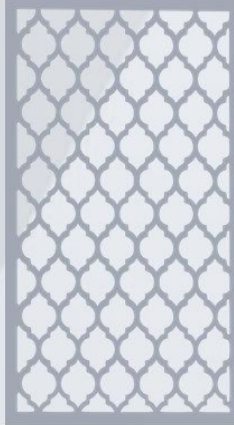

XST04-V



XST05-V



XST06-V



XST07-V



XST08-V



XST09-V



XST10-V



XST11-V



XST12-V



XST13-V



XST14-V



XST15-V



DIMENSIONES DE LOS PANELES

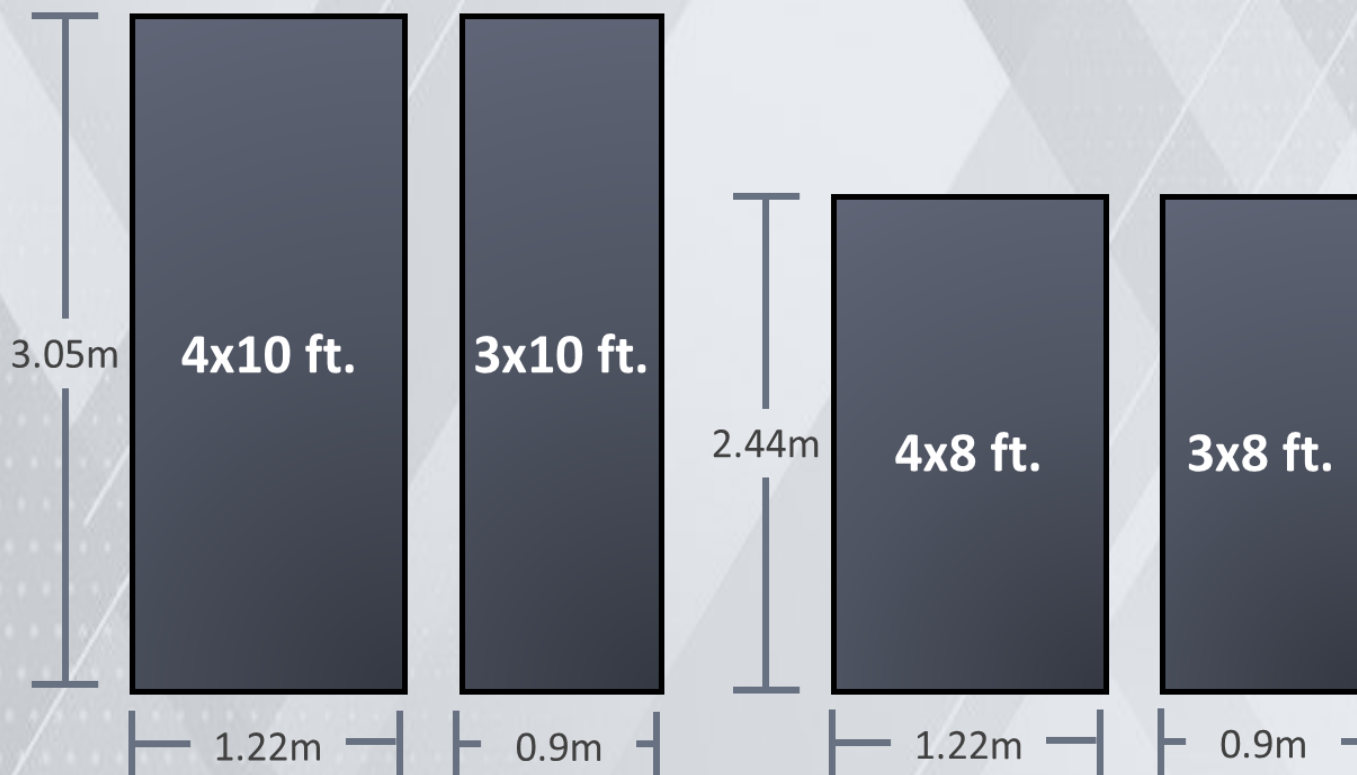

Materiales:

- Acero al Carbón
- Acero Inoxidable

Calibres sugeridos:

- Calibre 12 (2.66mm de espesor)
- Calibre 14 (1.90mm de espesor)

Es responsabilidad del cliente contemplar el calibre correcto para su proyecto. Cualquier orientación, estamos a sus ordenes.



Diseño y Fabricación de Equipos CNC

CONTACTO

¿Necesita algún presupuesto? ¿Necesita más información de nuestros productos o servicios? No dude en ponerse en contacto con nosotros, con gusto le atenderemos y resolveremos todas sus dudas.

Estamos para atenderle en:



+52 443 115 6240



practitools@gmail.com



Angola 175-C, Col. Lomas de Vista
Bella, Morelia, Mich. C.P. 58098



 +52 443 115 6240

 Morelia, Michoacán

 practitools.mx@gmail.com

 Practitools Mx