



Products and Services Portfolio

Abrasion Core Systems 2026

About Us

Our journey began with a simple goal — to provide practical engineering support that truly helps industrial operations perform better. Starting from modest beginnings, we built our business by focusing on reliability, responsiveness, and solving real problems on site rather than offering generic solutions.

Today, we support operations with engineered equipment, asset protection solutions, and technical services designed to improve uptime, extend asset life, and deliver measurable value throughout the plant lifecycle.

Our Mission

To be a global leader in innovative mining equipment and asset protection solutions, recognized for engineering excellence, sustainability, and our commitment to enhancing operational performance in the world's most demanding mining environments.

Our Vision

Through continuous innovation, technical expertise, and strong partnerships with our clients. We strive to reduce downtime, improve safety, and support sustainable mining operations worldwide.

Our Values

Customer Focus – Solutions that meet your needs

Quality Assurance – Built to perform reliably

Reputation through Performance – Results that speak for us

Client Partnership – Collaborating for long-term success

Continuous Improvement – Always refining, always better

Value Creation – Maximizing impact and efficiency

Continuous Integration – Extending products for one-stop solutions



Our Capabilities

Engineering and Design:

3D Design, Design for Manufacturing Drawings, 3D Scan Overlay Back Modelling.

Process Equipment Supply:

Industrial equipment sourcing, site-ready solutions, specification compliance, lifecycle support.

Asset Protection Reliability Engineering:

Asset integrity management, reliability-driven design, risk mitigation strategies, lifecycle value enhancement

Materials Expertise:

Ceramics, hardened alloys, rubber and polymers, materials engineered for harsh environments

OEM Equipment Solutions:

OEM-standard solutions, engineered compatibility, quality-controlled supply, lifecycle-focused support

ENGINEERING SERVICES



Engineering and Design Support

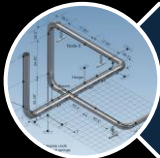

Pipeline Layout and Design Support

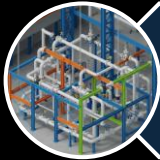

Hydraulic Modelling Support



Design for Manufacturing

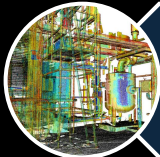

3D Scan Overlay Design Solutions



Asset Protection and Material Selection

Engineering and Design Support

As a trusted global engineering partner, we provide end-to-end support for industrial operations, delivering engineered solutions that enhance reliability, optimize performance, and extend asset life. From design and material selection to failure analysis and asset protection, our expertise spans the full lifecycle of critical equipment.

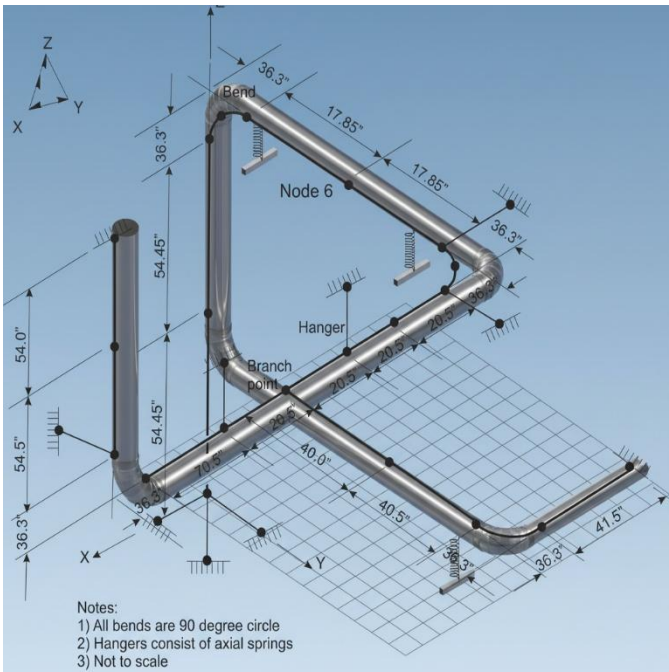

Pipeline Layout and Design Support

We assist with routing strategies, layout optimization, and design reviews to ensure slurry, water, and process pipelines operate safely and perform under real site conditions.

- Technical input during project design and execution stages.
- Pipeline routing guidance for new plants and system upgrades.
- Integration support with pumps, valves, and plant equipment.
- Review and recommendations of existing pipeline layouts

Hydraulic Modelling Support

Our Hydraulic Modelling Support services provide accurate analysis and simulation of fluid and slurry systems to ensure efficient, reliable, and safe operation.

Our Hydraulic Modelling Support services include:

- Flow rate and velocity analysis for slurry and fluid systems
- Pressure loss calculations and system head assessments
- Pump selection review
- Pipeline sizing
- Integration analysis with existing plant infrastructure

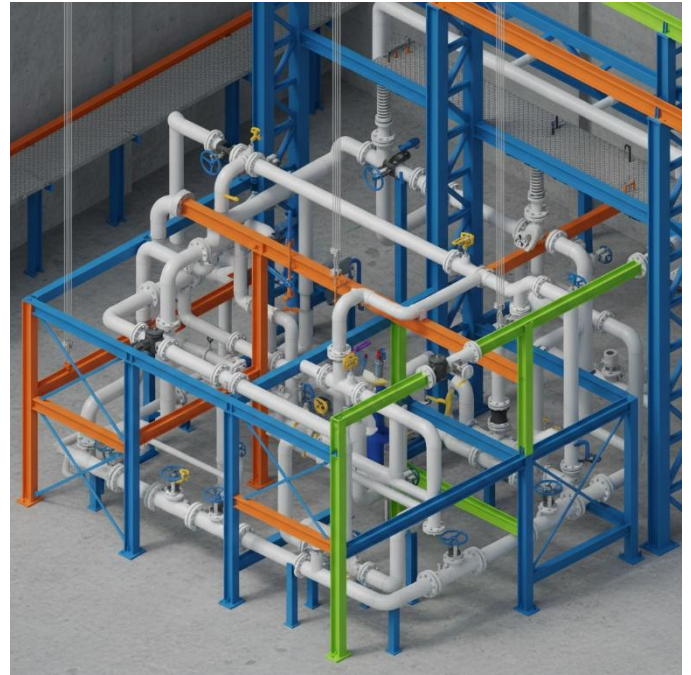

Design for Manufacturing

We provide Design for Manufacturing (DFM) services tailored to mining, bulk handling, and heavy industrial operations.

We generate workshop-ready design for manufacturing drawings for:

- SMP Steel Fabrication - Pipeline systems, transfer chutes, hoppers, structural access systems, and other SMP equipment)
- Wear-resistant linings design - General arrangement drawing, liners configuration, assembly proof design.
- Conversion of line isometric drawing to DFM drawings.
- Custom retrofit part design and detailing.

3D Scan Overlay Engineering Design Solutions

We develop detailed 3D models and overlays new equipment and systems onto existing layouts, ensuring seamless integration and clash-free designs.

Using advanced 3D point cloud scans, CAD modelling, and design review techniques, we capture precise dimensions, geometries, and material properties.

Our 3D point cloud engineering design services include:

1. Feasibility studies
2. Brownfield design solutions
3. Brownfield design for manufacturing drawings
4. Upgrade and retrofit solutions.

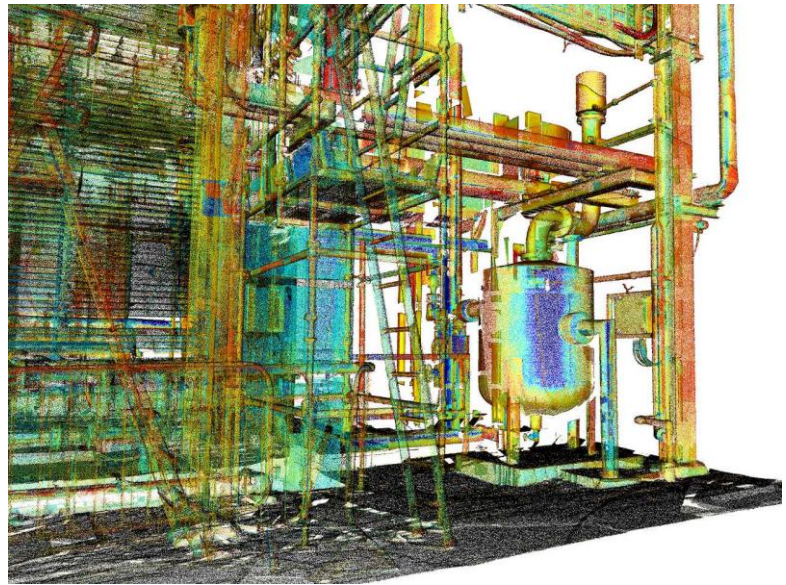

Asset Protection and Material Selection

Our Asset Protection & Material Selection services help industrial operations reduce wear, control corrosion, and extend the service life of critical equipment.

Our Asset Protection and Material Selection services include:

- Assessment of operating conditions and wear/corrosion risks
- Evaluation of abrasion, impact, and corrosion resistance requirements
- Selection of suitable materials: ceramics, hardened alloys, rubber, polymers
- Design of protective linings and coatings

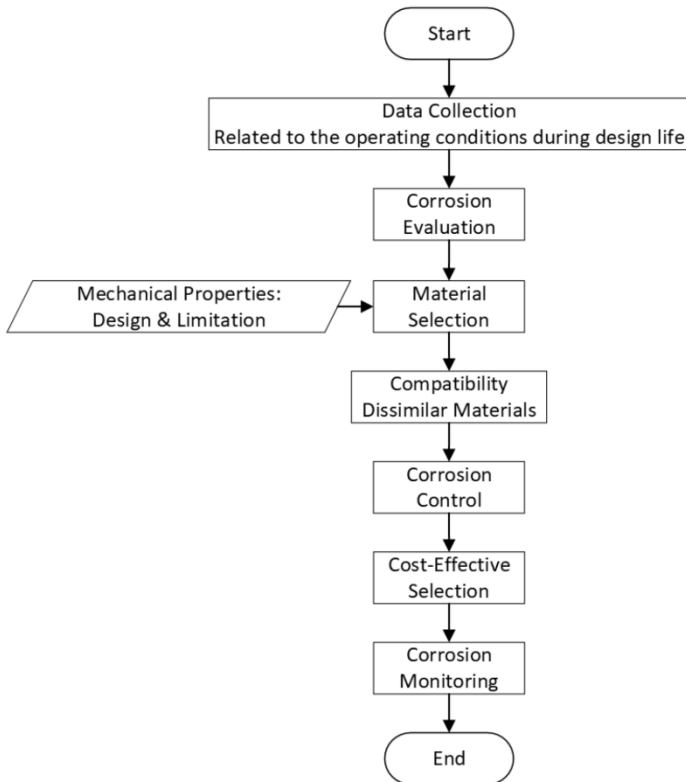

INDUSTRIAL EQUIPMENT



Industrial Valves



Crusher Parts and Liner



Pump Parts and Liners



Gearbox and Drive Trains

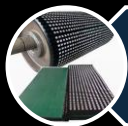

Conveyor Parts and Solutions

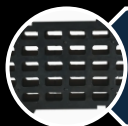

Vibrating Screen Panels



Orifice Plates and Chokes



Hydro Cyclone Parts and Liners



Industrial Spray Nozzles

Industrial Valves

We supply high-performance industrial valves engineered to deliver safe, efficient, and long-lasting flow control across mining, processing, water, energy, and heavy industry.

We provide a comprehensive selection of valves to suit isolation, regulation, and protection duties:

- Ball valves
- Knife gate valves
- Gate valves
- Globe valves
- Butterfly valves
- Plug valves
- Pinch Valves
- KDV Valves



Crusher Parts and Liner

We supply high-quality crusher wear parts designed to deliver durability, consistent performance, and long service life in demanding crushing applications.

Our range includes:

- Jaw plates, cheek plates, and side liners for jaw crushers
- Mantles, concaves, bowl liners, feed cones, and protection parts
- Blow bars, impact plates, curtain liners, and apron liners for impact crushers
- Hammers, breaker plates, grates, and rotor protection liners for hammer crushers
- Frame liners, chute liners, wear plates, feed liners, and discharge liners
- OEM-compatible replacement parts for major crusher brands



Pump Parts and Liners

Our Pump Parts are designed to handle abrasive slurries, corrosive liquids, and high-pressure systems, helping minimize downtime and maintain continuous operation.

Our range of pumps and pump parts include:

- OEM Pump Replacement Solutions.
- Pump Parts (Casings, Impellers, Volutes, Throat Bush, Shafts, Bearing Housing, Gland Packing, and Others).
- Pump Liners - Rubber, Polyurethane, Cast High Chrome.
- Ceramic Pump Liners - Impellers, Throat bush, and Volutes

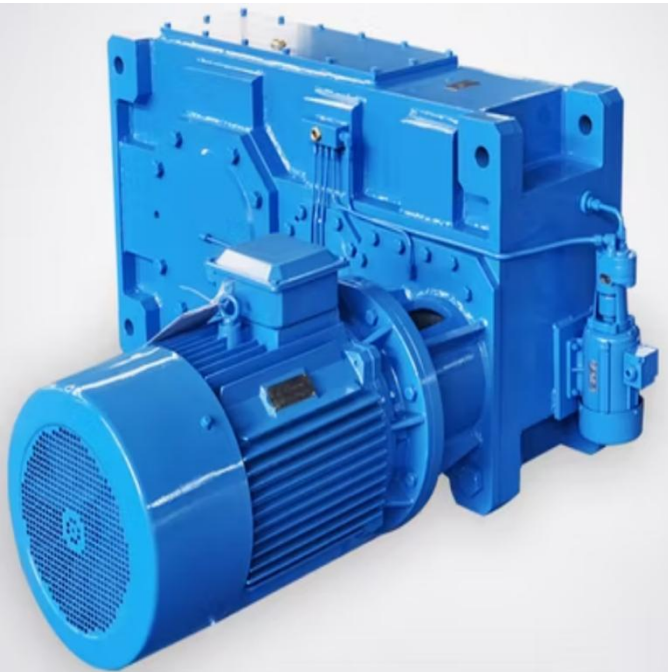

Gearbox and Drive Trains

We supply reliable gearboxes and drive train components designed to support efficient power transmission in demanding industrial applications.

Below are the main applications of gearboxes and drive trains:

- Belt conveyor drive systems
- Bucket elevators
- Crushers
- Apron feeders
- Vibrating screens
- Agitators and mixers

Conveyor Parts and Solutions

We supply durable conveyor parts and engineered solutions designed to improve reliability, reduce wear, and support efficient bulk material handling operations.

Typical Conveyor Components Include:

- Conveyor rollers and idlers
- Conveyor impact bed assembly.
- Impact beds and impact bars
- Loading and discharge chute wear liners.
- Conveyor pulleys and lagging
- Transfer chute components
- Polyurethane and rubber liners



Screening Panels

We supply high-performance vibrating screen panels engineered to withstand abrasive materials, high-impact loads, and demanding processing environments.

Our screening panel material solutions include:

- Natural Rubber Wear Panels.
- Polyurethane Panels.
- Hardened Steel Panels

Orifice Plates and Chokes

We supply precision-engineered orifice plates and choke components designed for accurate flow control, pressure reduction, and process measurement in demanding industrial environments.

Size Range: Any DN Size/Custom Size.

Thickness Range: Up to 100mm thickness.

Our screening panel material solutions include:

- Natural Rubber Wear Panels.
- Polyurethane Panels.
- Hardened Steel Panels

Manufactured from high-performance alloys, our components deliver reliable performance under high pressure, abrasive flow, and corrosive conditions.



Hydro Cyclone Parts and Liners

We supply high-quality hydro cyclone parts and liners designed for durability, efficiency, and performance in mineral processing and slurry handling applications.

Our range includes:

- Hydro cyclone OEM Replacement Parts.
- Hydro Cyclone Feed Chamber Liner (Rubber, Polyurethane)
- Hydro Cyclone Cover Plate Liner (Rubber, Polyurethane)
- Hydro cyclone Spigot Liners. (Ceramic, Polyurethane, Rubber)
- Vortex finders (Ceramic, Polyurethane, Rubber, High Chrome Cast Steel)
- Hydro Cyclone Cone Liners. (Ceramic, Polyurethane, Rubber)
- Hydro Cyclone Overflow Pipes (UHMWPE).
- Feed spools. (Ceramic, Rubber)
- Complete Cyclone Assemblies.
- Cyclone Launder Fabrication.

Industrial Spray Nozzles

We supply industrial spray nozzles designed to deliver precise, efficient, and reliable fluid distribution across a wide range of industrial applications.

- Full Cone Nozzles
- Hollow Cone Nozzles
- Flat Fan Nozzles
- Spiral Nozzles
- Mist Nozzles
- Fogging Nozzles
- Airless Atomizing Nozzles
- Spray Lance Assembly
- Spray Bars.



ASSET PROTECTION SERVICES



Ceramic Lined Spools



Rubber Lined Spools

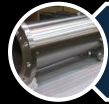

Specialty Alloy Spools



Ceramic Mine Hose



Abrasion Resistant Valves



Corrosion Resistant Valves



Impact and Wear Liners



Ceramic Spray Nozzles



Ceramic Orifice Plates and Chokes



Ceramic Agitator Impeller



Chromium Carbide Overlay Steelwork

Ceramic Lined Spools

Our ceramic lined spools are engineered for maximum wear resistance in abrasive slurry and bulk material handling systems.

Our ceramic lining options include:

- Siliconized Silicon Carbide (SiSiC) Monolithic Lining.
- Alumina Tiling.

We supply ceramic lined spools which include:

- Straight Spools
- Tee Spools
- Elbow Spools (Short Radius, Long Radius, 3D, and 5D).
- Lobster back Spools
- Concentric Reducer Spools
- Eccentric Reducer Spools

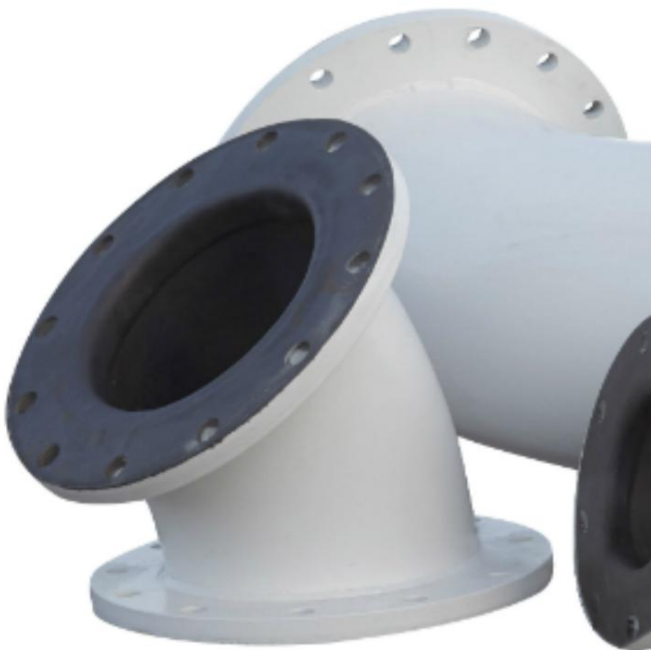

Rubber Lined Spools

We supply rubber lined spools designed to protect pipelines from abrasion, corrosion, and impact in harsh slurry and bulk material handling environments.

Our line of rubber lining products include:

- Cold bonded rubber lined spools
- Hot vulcanized rubber lined spools

Specialty Alloy Spools

We supply special alloy spools designed for extreme wear, corrosion, and high-temperature conditions in demanding industrial and mining operations.

Our range includes spools fabricated from high-performance alloys such:

- Duplex and Super Duplex Steel Spools
- Inconel Spools
- Incoloy Spools
- Monel Spools
- Hastelloy Spools
- Other Nickel Based Alloys.

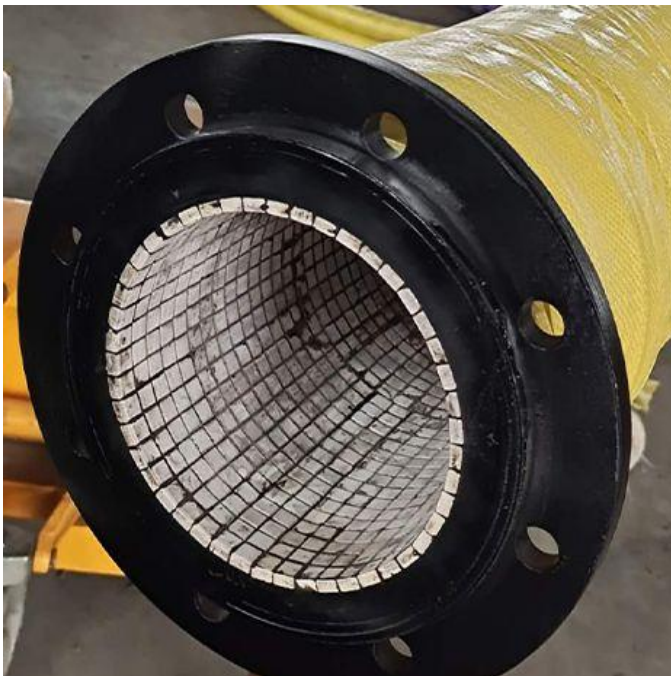

Ceramic Mine Hose

We supply ceramic mine hose designed for long service life in abrasive slurry transport and demanding mining applications.

Combining flexible hose construction with wear-resistant ceramic lining, these hoses provide superior protection against abrasion, impact, and corrosion.

Abrasion Resistant Valves

We supply abrasion resistant valves engineered to perform reliably in slurry, bulk material, and high-wear industrial applications.

Our range of abrasion resistant valves include:

- Tungsten Carbide Overlay.
- Chromium Carbide Overlay.
- Alumina Lined Valves.
- Zirconia Lined Valves.
- Ni Hard Coated.
- Hardened Steel Valves
- Others.

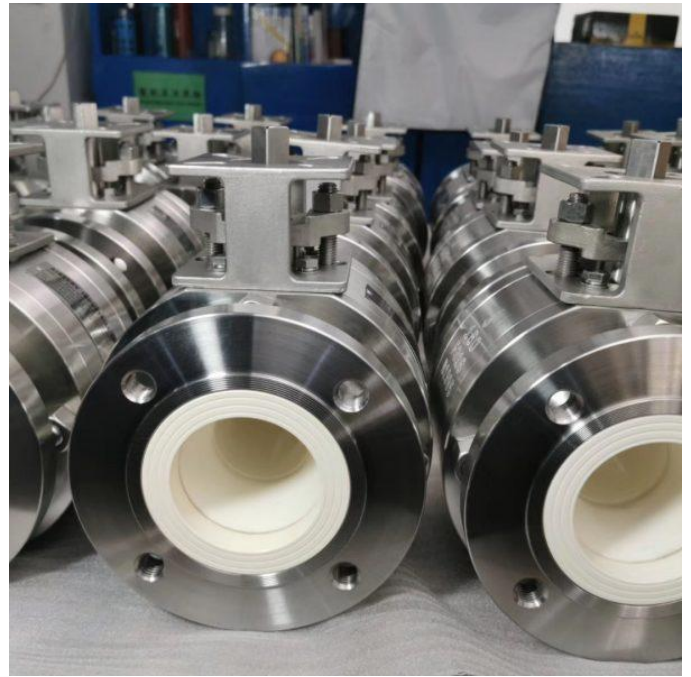

Corrosion Resistant Valves

We supply corrosion resistant valves designed to provide reliable isolation and flow control in aggressive chemical, saline, and process environments.

Our range of abrasion resistant valves include:

- PFA (Perfluoroalkoxy) Lined Valves.
- FEP (Fluorinated Ethylene Propylene) Lined Valves.
- PTFE (Polytetrafluoroethylene) Lined Valves.
- Special Metal Alloys Nickel Material Valves (Inconel, Incoloy, Hastelloy, Monel, and others)
- Ceramic Lined Valves
- Soft Seated Ball Valves - PTFE, UHMWPE, Devlon, RPTFE, TFE, CPTFE, PEEK, and Others.

Impact and Wear Liners

We supply impact and wear liners designed to protect plant equipment and structures from abrasion and impact

Our liners are used in chutes, hoppers, bins, transfer points, crushers, screens, and material handling systems

Our range of Impact and Wear Liners include:

- Impact Resistant Tough Steel Liner Options.
- Tungsten Carbide Overlay Steel Liners.
- Chromium Carbide Overlay Steel Liners.
- Steel-Backed Rubber Liners.
- Steel-Backed Alumina Tiled Liners.
- Steel-Backed Rubber-ZTA Brick Liners.
- Rubber-Alumina Tiled Liners.



Abrasion Resistant Ceramic Spray Nozzles

We supply ceramic spray nozzles designed for long service life in abrasive, high-wear, and corrosive industrial environments.

Manufactured from advanced ceramic materials, these nozzles provide superior resistance to erosion, chemical attack, and high-temperature conditions.

We provide ceramic spray solutions in a range of materials which are:

- Zirconia.
- Alumina.
- Silicon Carbide.

Ceramic Orifice Plates and Chokes

We supply ceramic spray nozzles designed for long service life in abrasive, high-wear, and corrosive industrial environments.

Manufactured from advanced ceramic materials, these nozzles provide superior resistance to erosion, chemical attack, and high-temperature conditions.

We provide ceramic spray solutions in a range of materials which are:

- Silicon Carbide
- Alumina
- Zirconia
- Zirconia Toughened Alumina

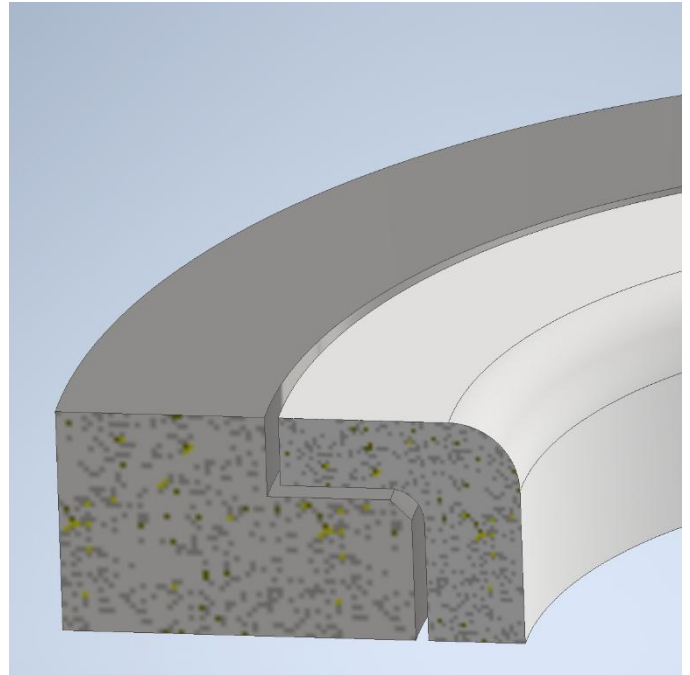

Ceramic Agitator Impeller

We supply silicon carbide (SiC) agitator impellers designed for superior performance in abrasive, corrosive, and high-wear mixing applications.

Silicon carbide impellers are ideal for slurry mixing, chemical processing, mineral processing tanks, and other equipment where conventional metal impellers would rapidly erode or corrode.

Our impellers can be supplied in various sizes, blade configurations, and mounting designs to suit new installations or replacement requirements.

Chromium Carbide Overlay Steelwork

By integrating wear-resistant overlay technology with practical engineering support, we help reduce downtime, lower maintenance costs, and protect critical plant infrastructure in mining and heavy industry operations.

Chromium carbide overlay steel work applications include both mining and mineral processing equipment e.g. dozer blades liner, truck beds liners, overlay chutes, overlay pipelines, hoppers, and many more.



Legal Notice

Copyright © Abrasion Core Systems

This product portfolio has been prepared for informational and general reference purposes only. The information, technical data, product descriptions, specifications, drawings, diagrams, and illustrations contained herein are believed to be accurate at the time of publication. However, they are provided without any representation or warranty, express or implied, regarding their completeness, accuracy, reliability, or suitability for any specific application or operating condition.

All products, services, and solutions described in this document are subject to ongoing development, design improvement, and modification. As part of our commitment to continuous improvement, the company reserves the right to alter product designs, materials, specifications, dimensions, and performance characteristics without prior notice. The company shall not be obligated to update previously distributed copies of this document to reflect such modifications.

The images, diagrams, renderings, and visual representations included in this portfolio are intended for illustrative purposes only and may not necessarily reflect the exact configuration, dimensions, or appearance of the final product supplied. Actual products may vary depending on application requirements, engineering specifications, and manufacturing processes.

Any references to third-party products, equipment, systems, or original equipment manufacturers (OEMs) are provided solely for identification, compatibility, or application reference purposes. Such references do not imply any formal association, endorsement, or affiliation with the respective manufacturers unless expressly stated. All trademarks, trade names, product names, and brand names mentioned within this document remain the property of their respective owners.

The selection, specification, installation, operation, and maintenance of the products described in this portfolio must be carried out by suitably qualified technical personnel and must take into consideration the specific operating conditions, process requirements, and safety standards applicable to each installation. Customers and end users are responsible for ensuring that products are properly selected and applied for their intended purpose.

To the fullest extent permitted by applicable law, the company shall not be held liable for any direct, indirect, incidental, consequential, or special damages, including but not limited to loss of production, operational downtime, equipment damage, or financial losses arising from the use of, reliance upon, or inability to use the information contained in this portfolio.

All intellectual property contained within this document, including but not limited to text, technical descriptions, product data, graphics, layouts, and design elements, is protected by applicable copyright and intellectual property laws. No part of this publication may be reproduced, stored in a retrieval system, transmitted, distributed, or used in any form or by any means, whether electronic, mechanical, photocopying, recording, or otherwise, without prior written permission from the company.

For the most current product information, technical specifications, engineering guidance, or application-specific recommendations, customers are encouraged to contact the company directly or consult with our technical specialists.

Terms of Trade

All products and solutions are supplied subject to the company's standard terms and conditions of sale which will be provided on the request for quotation. It can also be found on the company's website.