



HIRA®

Product Catalogue 2026

Volume 1

HIRA® is the registered trademark of Gulmohar Enterprises

About Us



Founded in 1989, HIRA has evolved into a well-established and trusted name within the Indian hardware industry, known for its specialized expertise in manufacturing toggle latches, chest handles, and trunk fittings. Over the years, the brand has moved beyond simply supplying components—it has positioned itself as a solutions-driven manufacturer that understands the practical demands of industries where reliability, durability, and precision are not optional, but essential.

HIRA's core strength lies in its product philosophy. Every latch, handle, and fitting is designed with a clear purpose: to perform consistently under real-world conditions. Whether used in packaging systems, storage trunks, industrial enclosures, transport equipment, or fabricated metal structures, HIRA products are built to ensure secure fastening, ease of operation, and long-term usability. The brand focuses on engineering products that can withstand frequent use, load stress, and environmental factors, making them suitable for both light-duty and heavy-duty applications.

What distinguishes HIRA in a competitive market is its deep understanding of how hardware functions in actual industry settings. Instead of focusing on superficial features, the brand emphasizes structural strength, accurate fitting, and dependable locking mechanisms. This practical, performance-oriented approach has enabled HIRA to serve a wide range of industries including logistics, manufacturing, furniture production, electrical panel manufacturing, and custom fabrication sectors.

The versatility of HIRA's product range further strengthens its position. The brand offers a broad selection of standard designs while also maintaining the capability to adapt products based on specific industrial requirements. This flexibility ensures that clients are not limited to off-the-shelf solutions but can access hardware that aligns precisely with their operational needs. As a result, HIRA has become a preferred choice for wholesalers, OEMs, and manufacturers who require consistency across bulk orders without compromising on functionality.

Another defining aspect of HIRA is its commitment to consistency over time. In industries where

Head Office

Gulmohar Enterprises

429, Shahzada Bagh Industrial Area I,
Inderlok, New Delhi, Delhi - 110035

Phone - 9891008850, 9810000902(whatsapp)

Email - gulmohar429@gmail.com

Manufacturing Unit

Dilli Metals

BN-113, UPSIDC Industrial Area Phase - III,
Masuri-Gulawati Road, Dist. Hapur,
Uttar Pradesh - 245101

Distributor

Hira Traders

1977, Bazaar Lal Quan, Chawri Bazaar,
New Delhi, Delhi - 110035

Phone - 9891249229

Email - hiratrunk@gmail.com

Index



Product Name	Page
<p data-bbox="140 499 343 533">Toggle Latches</p> 	5 - 16
<p data-bbox="140 824 544 857">Stainless Steel Toggle Latches</p> 	18 - 22
<p data-bbox="140 1149 336 1182">Chest Handles</p> 	24 - 28
<p data-bbox="140 1473 363 1507">Hasp and Staple</p> 	30
<p data-bbox="140 1798 331 1832">Other Fittings</p> 	32

HIRA[®]



**Toggle
Latches**

Toggle Latches



Modal No. - TC10L

Modal No. - TC12BWL

Modal No. - TC12BW

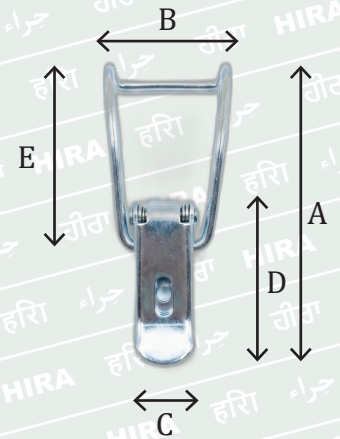
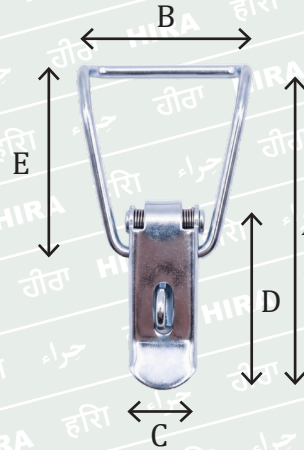
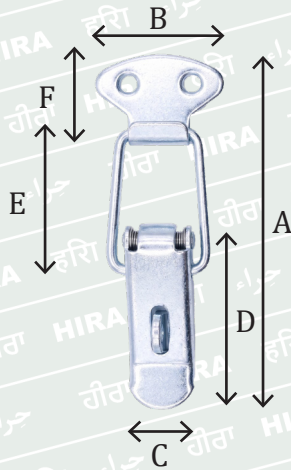
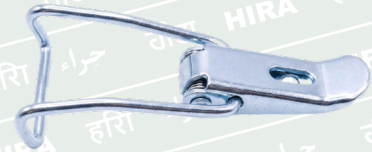

Modal	TC10L	TC12BWL	TC12BW
Generic Name	Toggle latch No. 10 (Lock)	Toggle latch No. 12 (Bend Wire with Lock)	Toggle latch No. 12 (Bend Wire without Lock)
length A	75 mm	68 mm	65 mm
Length B	27 mm	37 mm	27 mm
Length C	14 mm	14 mm	14 mm
Length D	37 mm	37 mm	37 mm
Length E	34 mm	42 mm	43 mm
Length F	20 mm	-	-
Material	Mild Steel	Mild Steel	Mild Steel
Finish	Zinc	Zinc	Zinc
Thickness	0.9 mm	0.9 mm	0.9 mm
Wire Thickness	2.2 mm	2.2 mm	2.2 mm
Weight	14 g	13 g	13 g
Spring	No	No	No

Toggle Latches



Modal No. - TC13

Modal No. - TC13LW

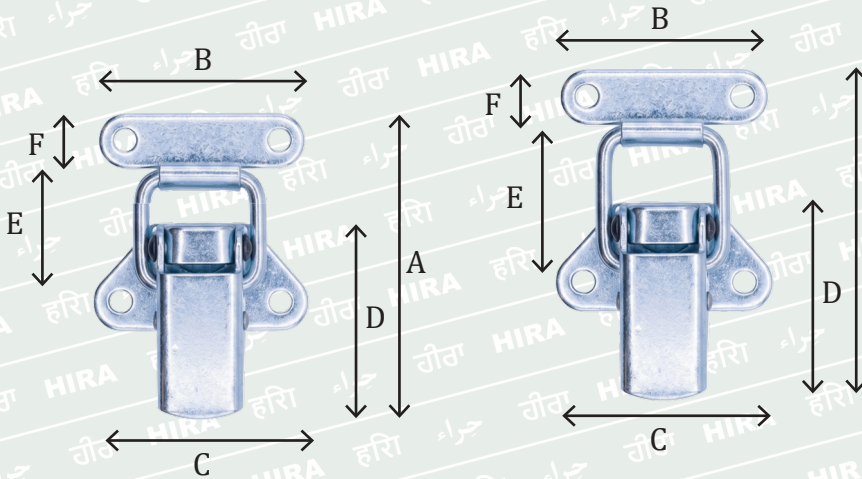
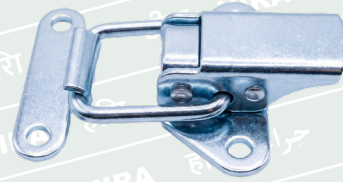
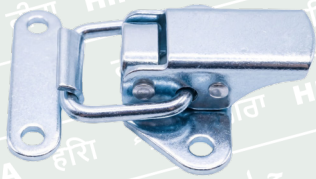

Modal	TC13	TC13LW
Generic Name	Toggle latch No. 13	Toggle latch No. 13 (Long Wire)
length A	54 mm	58 mm
Length B	37 mm	37 mm
Length C	42 mm	42 mm
Length D	32 mm	32 mm
Length E	23 mm	29 mm
Length F	9 mm	9 mm
Material	Mild Steel	Mild Steel
Finish	Zinc	Zinc
Thickness	1.15 mm	1.15 mm
Wire Thickness	3 mm	3 mm
Weight	23 g	24 g
Spring	No	No

Toggle Latches



Modal No. - TC15

Modal No. - TC17

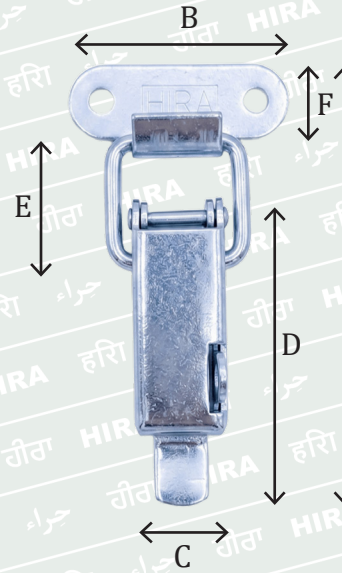
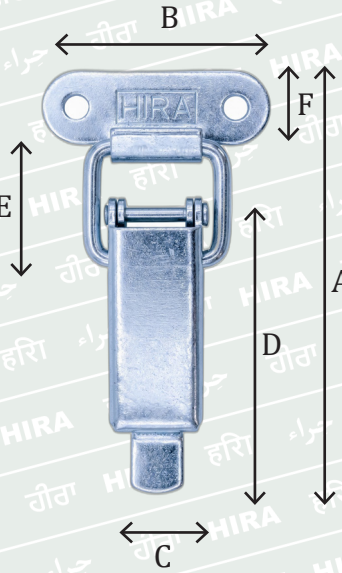
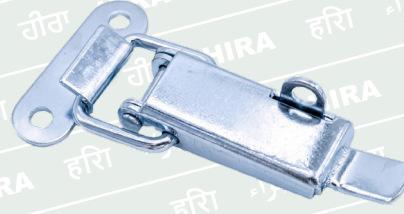
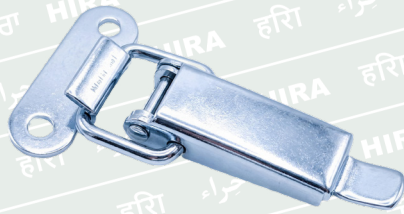

Modal	TC15	TC17
Generic Name	Toggle latch No. 15	Toggle latch No. 17
length A	85 mm	85 mm
Length B	46 mm	46 mm
Length C	19 mm	19 mm
Length D	29 mm	29 mm
Length E	16 mm	16 mm
Length F	60 mm	60 mm
Material	Mild Steel	Mild Steel
Finish	Zinc	Zinc
Thickness	1.5 mm	1.5 mm
Wire Thickness	3.5 mm	3.5 mm
Weight	45 g	45 g
Spring	No	No
Lock	No	Yes

Toggle Latches



Modal No. - TC21LW

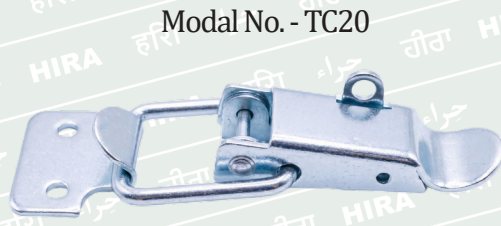

Modal No. - TC20



Modal No. - TC21

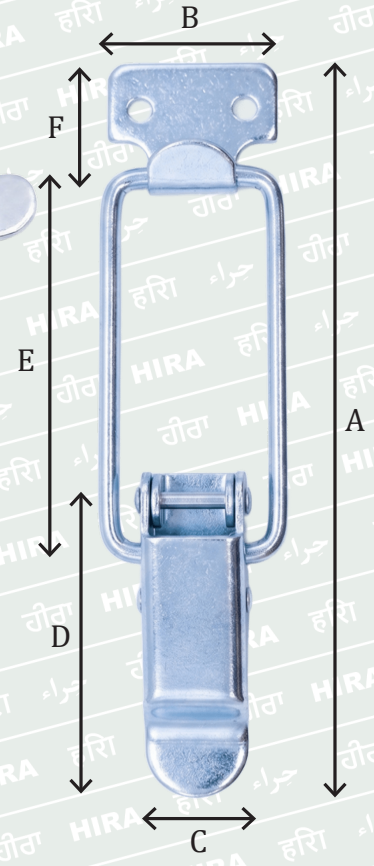
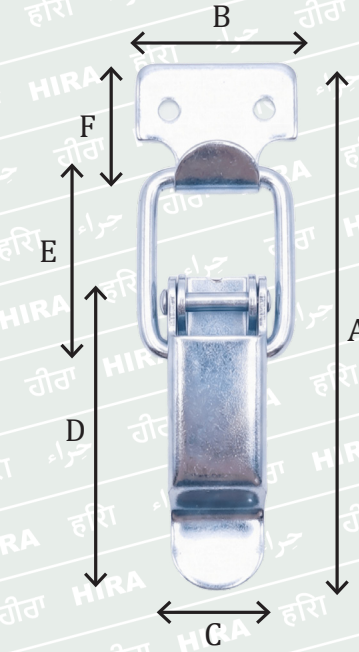
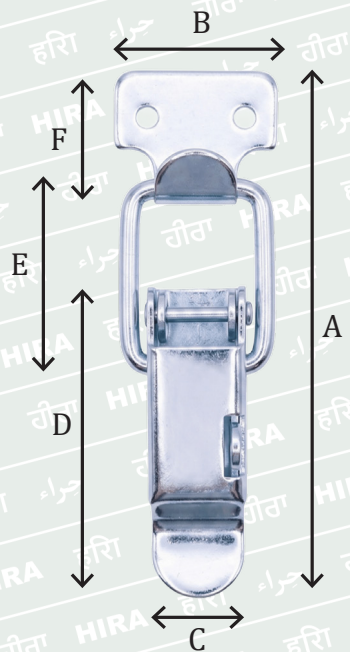

Modal	TC20	TC21	TC21LW
Generic Name	Toggle latch No. 20	Toggle latch No. 21	Toggle latch No. 21 (Long Wire)
length A	110 mm	110 mm	150 mm
Length B	34 mm	34 mm	34 mm
Length C	20 mm	20 mm	20 mm
Length D	64 mm	64 mm	64 mm
Length E	42 mm	42 mm	80 mm
Length F	28 mm	28 mm	28 mm
Material	Mild Steel	Mild Steel	Mild Steel
Finish	Zinc	Zinc	Zinc
Thickness	1.5 mm	1.5 mm	1.5 mm
Wire Thickness	4 mm	4 mm	4 mm
Weight	62 g	62 g	70 g
Spring	No	No	No
Lock	Yes	No	No

Toggle Latches



Modal No. - TC23BW

Modal No. - TC24

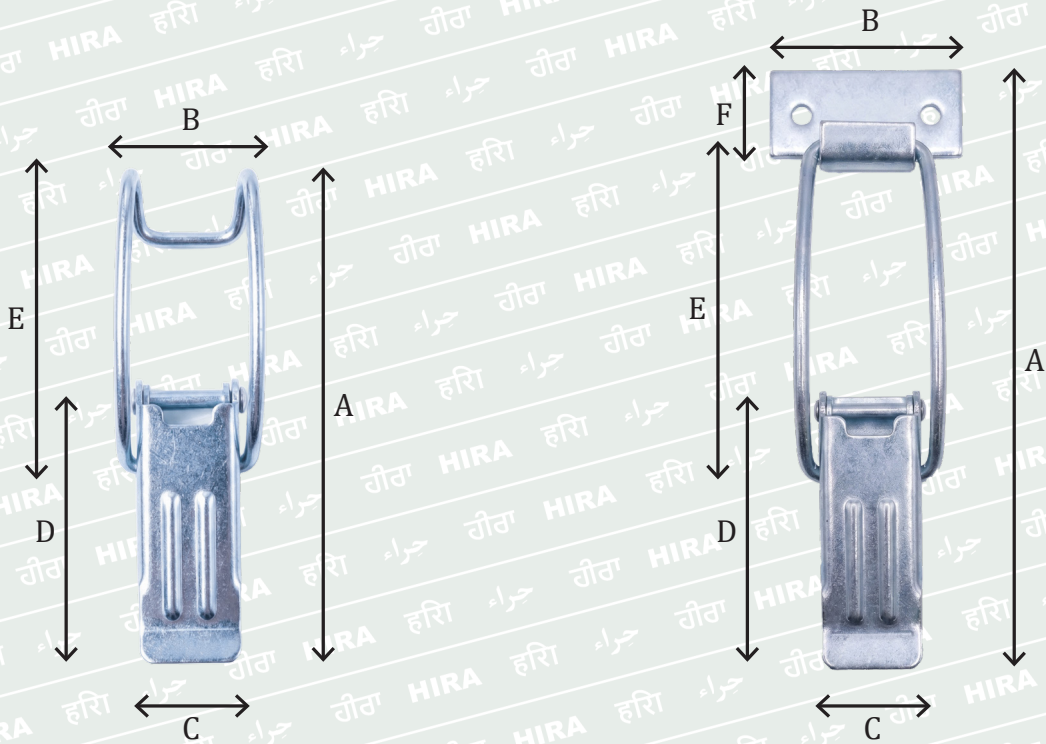
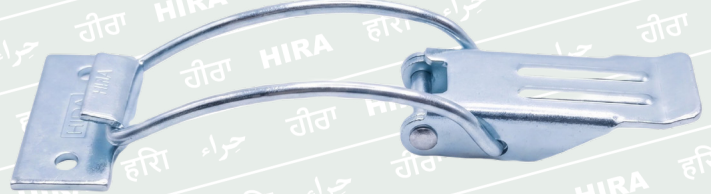
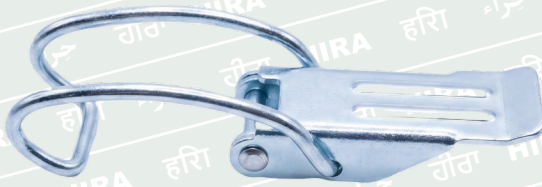

Modal	TC23BW	TC24
Generic Name	Toggle latch No. 23 (Bend Wire)	Toggle latch No. 24
length A	115 mm	150 mm
Length B	35 mm	48 mm
Length C	25 mm	25 mm
Length D	69 mm	69 mm
Length E	70 mm	90 mm
Length F	-	22 mm
Material	Mild Steel	Mild Steel
Finish	Zinc	Zinc
Thickness	1.5 mm	1.5 mm
Wire Thickness	3.5 mm	3.5 mm
Weight	60 g	82 g
Spring	No	No
Lock	No	No

Toggle Latches



Modal No. - TC25

Modal No. - TC25S

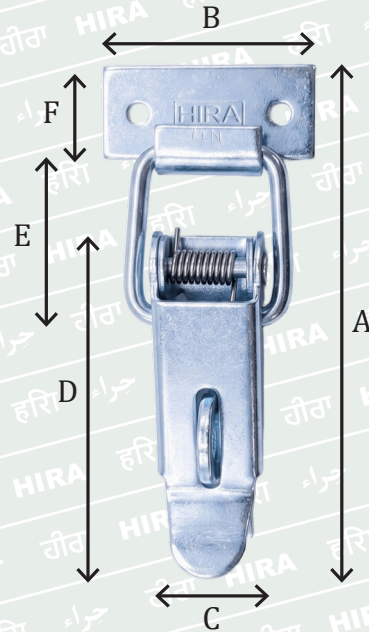
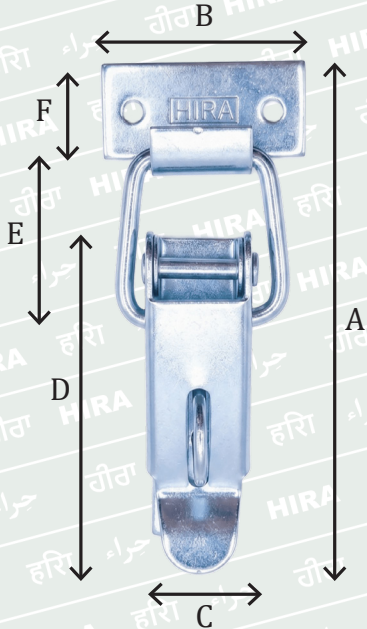
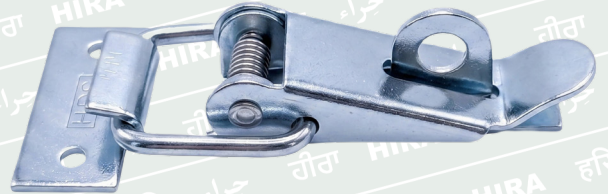

Modal	TC25	TC25S
Generic Name	Toggle latch No. 25	Toggle latch No. 25 (With Spring)
length A	120 mm	120 mm
Length B	48 mm	48 mm
Length C	25 mm	25 mm
Length D	80 mm	80 mm
Length E	43 mm	43 mm
Length F	22 mm	22 mm
Material	Mild Steel	Mild Steel
Finish	Zinc	Zinc
Thickness	1.5 mm	1.5 mm
Wire Thickness	4.5 mm	4.5 mm
Weight	93 g	96 g
Spring	No	Yes
Lock	Yes	Yes

Toggle Latches



Modal No. - TC28

Modal No. - TC30

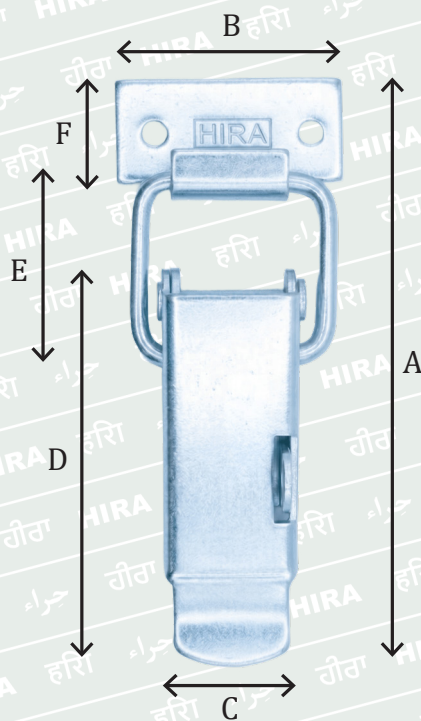
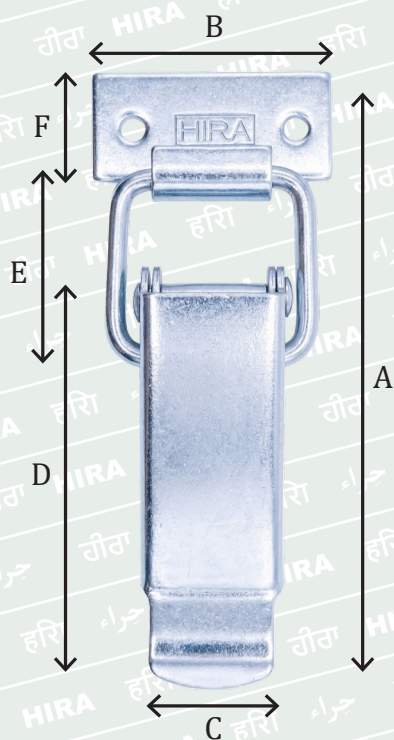
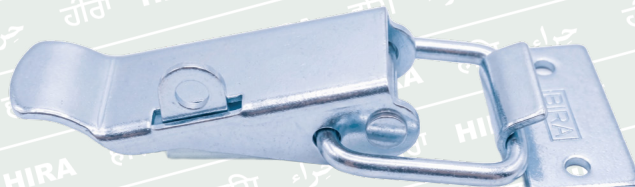

Modal	TC28	TC30
Generic Name	Toggle latch No. 28	Toggle latch No. 30
length A	125 mm	125 mm
Length B	48 mm	48 mm
Length C	28 mm	28 mm
Length D	83 mm	83 mm
Length E	43 mm	43 mm
Length F	22 mm	22 mm
Material	Mild Steel	Mild Steel
Finish	Zinc	Zinc
Thickness	1.5 mm	1.5 mm
Wire Thickness	4.5 mm	4.5 mm
Weight	100 g	100 g
Spring	No	No
Lock	No	Yes

Toggle Latches



Modal No. - TC60

Modal No. - TC40

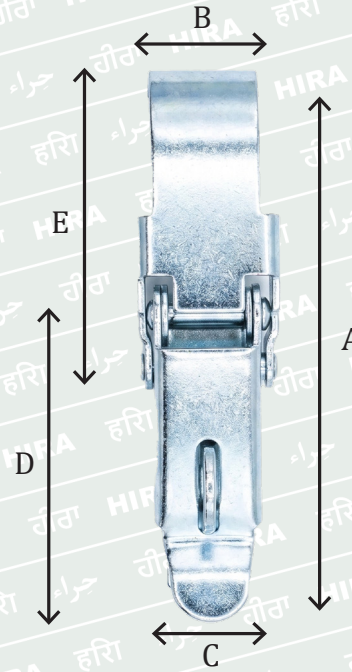
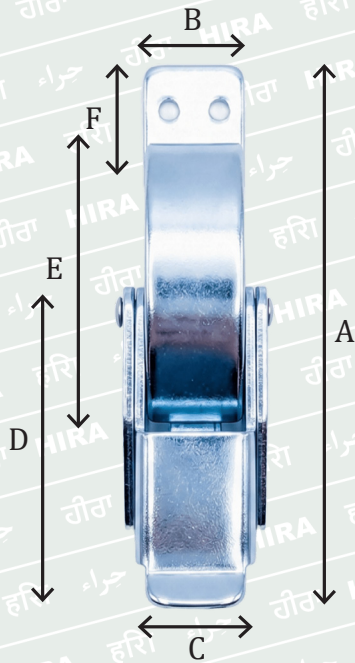

Modal	TC60	TC40
Generic Name	Toggle latch No. 60	Toggle latch No. 40
length A	90 mm	130 mm
Length B	15 mm	25 mm
Length C	23 mm	25 mm
Length D	50 mm	80 mm
Length E	46 mm	77 mm
Length F	21 mm	
Material	Mild Steel	Mild Steel
Finish	Zinc	Zinc
Thickness	1.5 mm	1.5 mm
Weight	60 g	90 g
Spring	No	No
Lock	No	Yes

Toggle Latches



Modal No. - TC50

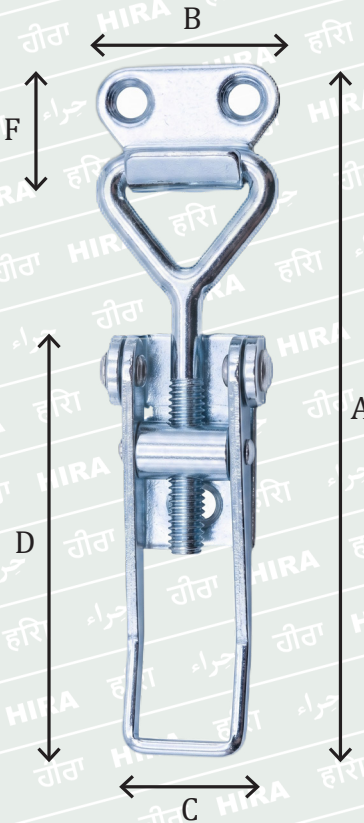
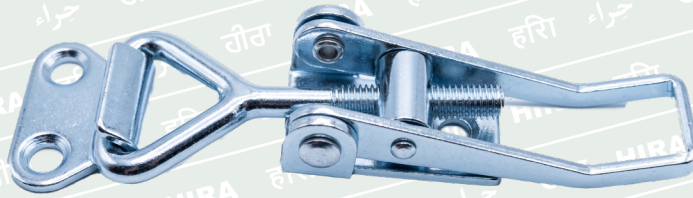

Modal	TC50
Generic Name	Toggle latch No. 50 (Adjustable)
length A	91 mm to 105 mm
Length B	25 mm
Length C	15 mm
Length D	56 mm
Length F	20 mm
Material	Mild Steel
Finish	Zinc
Thickness	1.5 mm
Weight	38 g
Spring	No
Lock	No

Toggle Latches



Modal No. - TC90

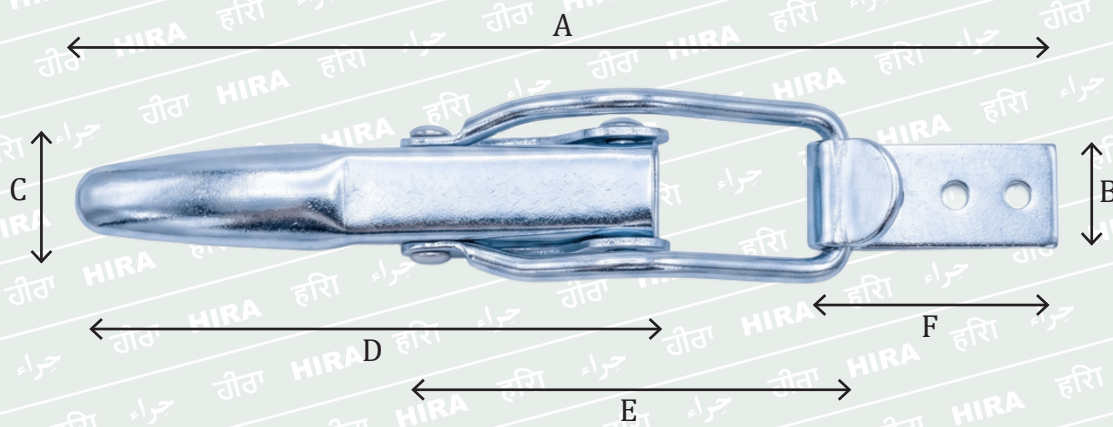

Modal	TC90
Generic Name	Toggle latch No. 90
length A	200 mm
Length B	20 mm
Length C	18 mm
Length D	120 mm
Length E	95 mm
Length F	50 mm
Material	Mild Steel
Finish	Zinc
Thickness	1.15/2 mm
Wire Thickness	5.2 mm
Weight	170 g
Spring	Yes
Lock	No

Toggle Latches



Modal No. - TC91

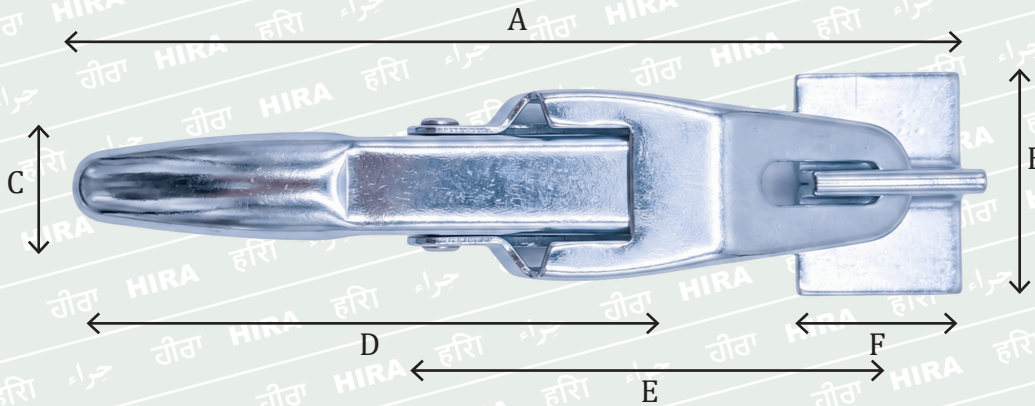

Modal	TC91
Generic Name	Toggle latch No. 91
length A	165 mm
Length B	38 mm
Length C	18 mm
Length D	120 mm
Length E	93 mm
Length F	28 mm
Material	Mild Steel
Finish	Zinc
Thickness	1.15/2 mm
Weight	165 g
Spring	Yes
Lock	No

Toggle Latches



Modal No. - TC92

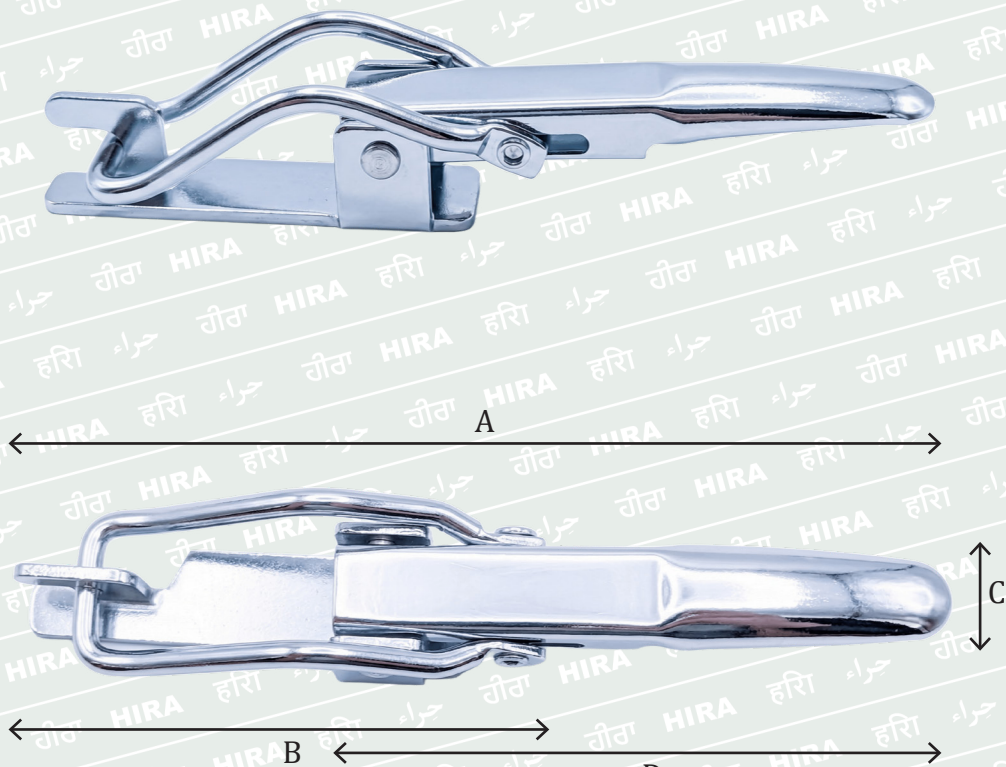

Modal	TC92
Generic Name	Toggle latch No. 92
length A	190 mm
Length B	91 mm
Length C	25 mm
Length D	120 mm
Material	Mild Steel
Finish	Zinc
Thickness	1.15/3 mm
Wire Thickness	5.2 mm
Weight	160 g
Spring	Yes
Lock	No

HIRA[®]



**Stainless Steel
Toggle Latches**



Stainless Steel Toggle Latches



Modal No. - TC10SS

Modal No. - TC10SSLW

Modal No. - TC12SSBW

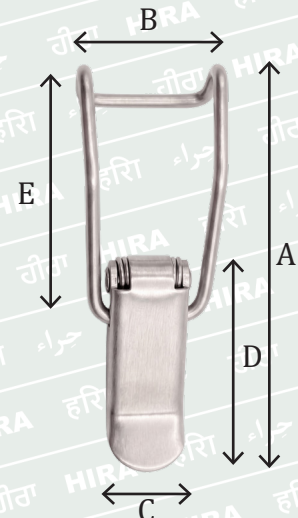
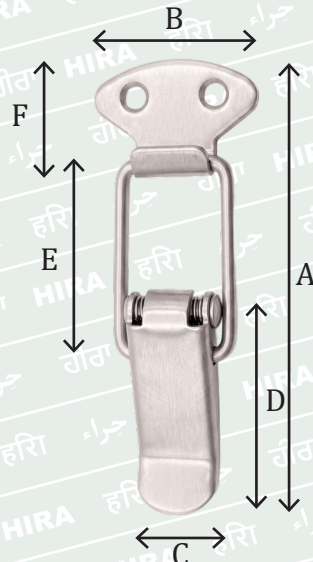
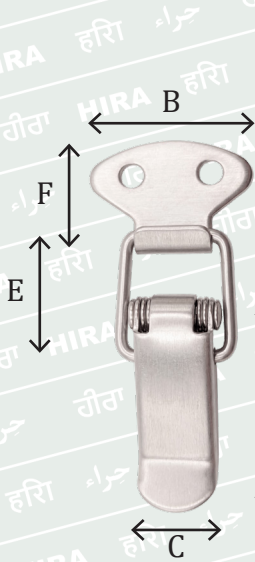
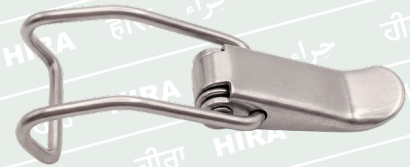
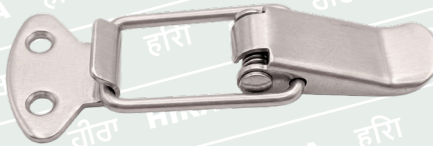

Modal	TC10SS	TC10SSLW	TC12SSBW
Generic Name	Toggle latch No. 10 SS	Toggle latch No. 10 SS (Long Wire)	Toggle latch No. 12 SS (Bend Wire)
length A	64 mm	75 mm	65 mm
Length B	27 mm	27 mm	28 mm
Length C	14 mm	14 mm	14 mm
Length D	37 mm	37 mm	36 mm
Length E	24 mm	35 mm	40 mm
Length F	20 mm	20 mm	-
Material	Stainless Steel Grade - 304	Stainless Steel Grade - 304	Stainless Steel Grade - 304
Thickness	0.9 mm	0.9 mm	0.9 mm
Wire Thickness	2.2 mm	2.2 mm	2.2 mm
Weight	15 g	15 g	13 g
Spring	Yes	Yes	Yes
Lock	No	No	No

Stainless Steel Toggle Latches



Modal No. - TC13SS

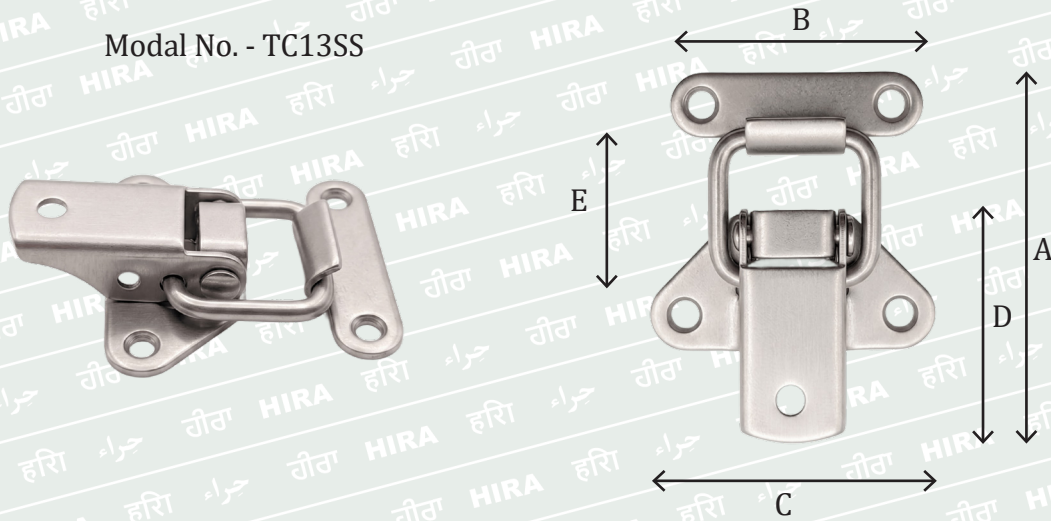

Modal	TC13SS
Generic Name	Toggle latch No. 13 SS
length A	55 mm
Length B	37 mm
Length C	42 mm
Length D	33 mm
Length E	24 mm
Length F	9 mm
Material	Stainless Steel Grade - 304
Thickness	1 mm
Wire Thickness	3 mm
Weight	21 g
Spring	No
Lock	No

Stainless Steel Toggle Latches



Modal No. - TC19SS

Modal No. - TC19SSL

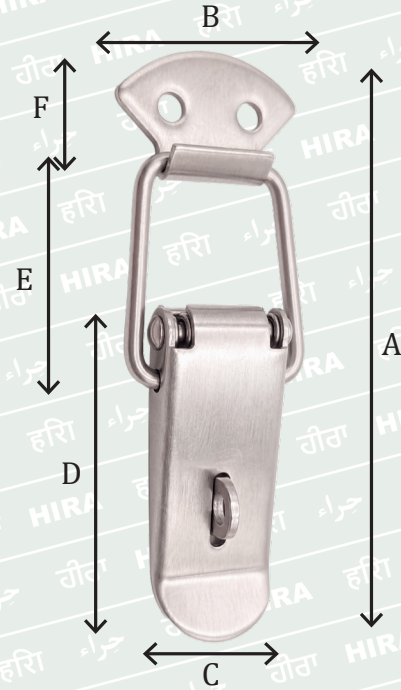
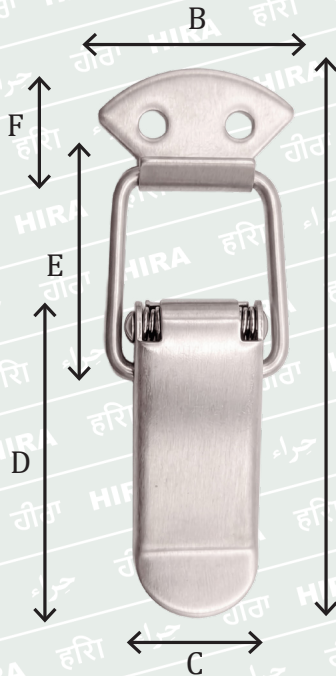

Modal	TC19SS	TC19SSL
Generic Name	Toggle latch No. 19 SS	Toggle latch No. 19 SS (Lock)
length A	93 mm	93 mm
Length B	32 mm	32 mm
Length C	22 mm	22 mm
Length D	55 mm	55 mm
Length E	36 mm	36 mm
Length F	20 mm	20 mm
Material	Stainless Steel Grade - 304	Stainless Steel Grade - 304
Thickness	1.15 mm	1.15 mm
Wire Thickness	3 mm	3 mm
Weight	35 g	35 g
Spring	Yes	Yes
Lock	No	Yes

Stainless Steel Toggle Latches



Modal No. - TC90SS

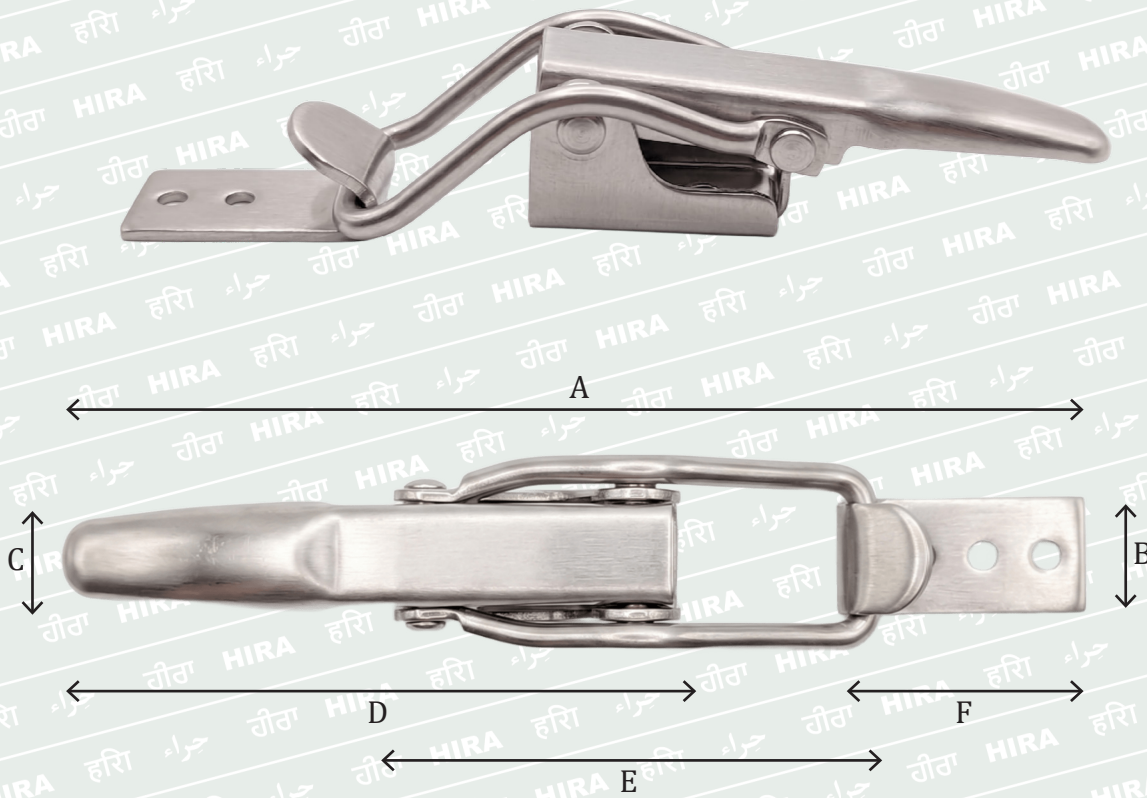

Modal	TC90SS
Generic Name	Toggle latch No. 90 SS
length A	200 mm
Length B	20 mm
Length C	18 mm
Length D	120 mm
Length E	95 mm
Length F	50 mm
Material	Stainless Steel Grade - 304
Thickness	1.15/2 mm
Wire Thickness	5.2 mm
Weight	170 g
Spring	YES
Lock	No

Stainless Steel Toggle Latches



Modal No. - TC92SS

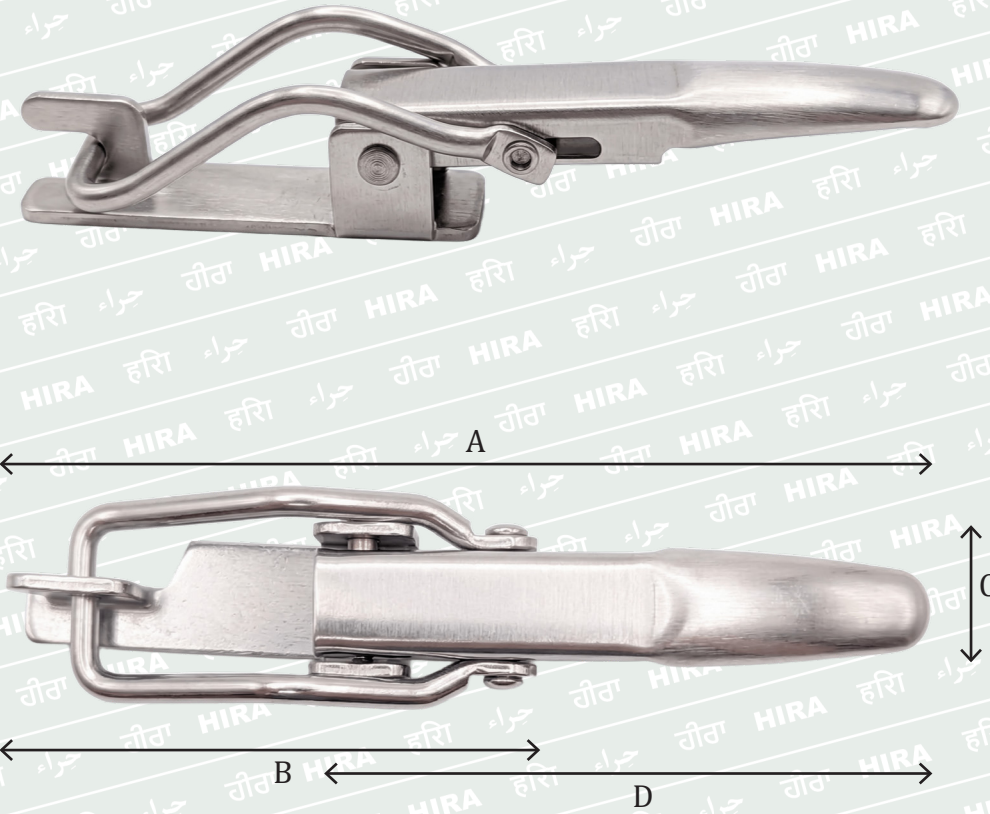

Modal	TC92SS
Generic Name	Toggle latch No. 92 SS
length A	190 mm
Length B	91 mm
Length C	25 mm
Length D	120 mm
Material	Stainless Steel Grade - 304
Thickness	1.15/3 mm
Wire Thickness	5.2 mm
Weight	162 g
Spring	YES
Lock	No

HIRA



Handles

Fix Chest Handle

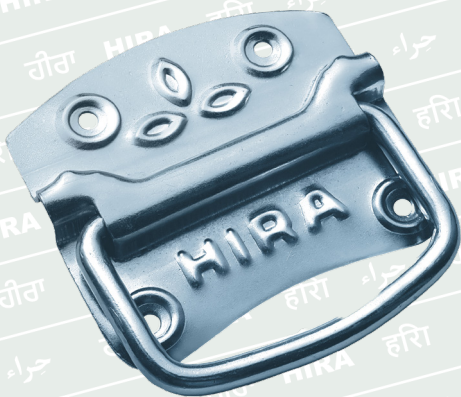
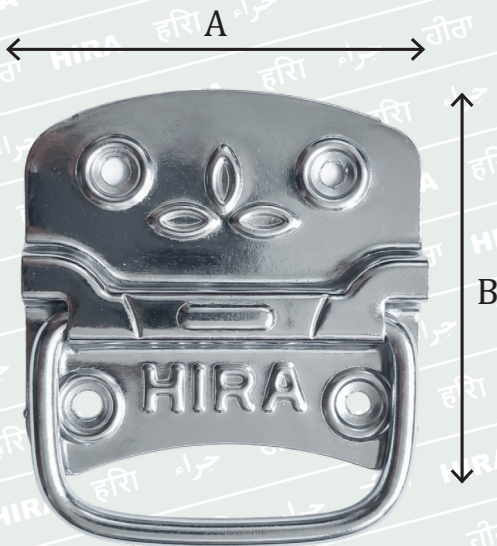

Model Name - 4" Fix Jumbu

Model Name - 3" Fix Hira

Model	4FXCHJ	4FXCHB	4FXCHH	3FXCHJ	3FXCHH
Generic Name	4" Fix Jumbu	4" Fix Bold	4" Fix Hira	3" Fix Jumbu	3" Fix Hira
length A	93 mm	90 mm	90 mm		80 mm
Length B	84 mm	79 mm	72 mm		66 mm
Material	Mild Steel	Mild Steel	Mild Steel	Mild Steel	Mild Steel
Finish	Zinc	Zinc	Zinc	Zinc	Zinc
Thickness	1.15 mm	0.9 mm	0.6 mm		0.6 mm
Wire Thickness	7.3 mm	6.2 mm	6.2 mm		4 mm
Weight	134 g	95 g	80 g		40 g

Folding Chest Handle

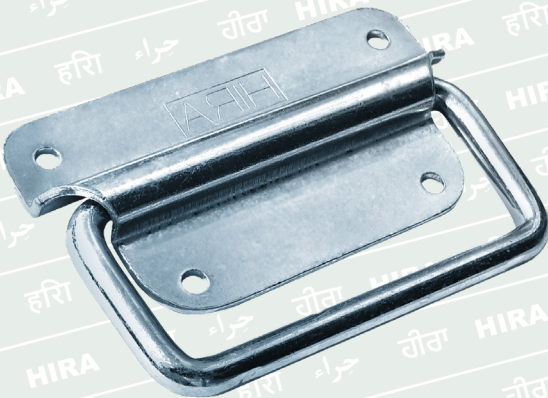

Model Name - Jumbu Folding



Model Name - No. 5 Folding

Modal	FLJ	FL3H	FL3	FL5
Generic Name	Jumbu Folding	No. 3 Heavy Folding	No. 3 Folding	No. 5 Folding
length A	108 mm	90 mm	90 mm	90 mm
Length B	53 mm	56 mm	56 mm	56 mm
Material	Mild Steel	Mild Steel	Mild Steel	Mild Steel
Finish	Zinc	Zinc	Zinc	Zinc
Thickness	2 mm	0.9 mm	0.6 mm	0.6 mm
Wire Thickness	7.3 mm	6.2 mm	6.2 mm	5.2 mm
Weight	158 g	78 g	65 g	52 g

Wire Handle

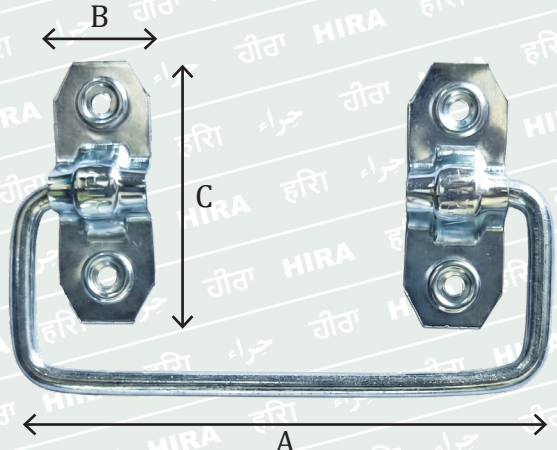

Model Name - No. 5 Wire Handle

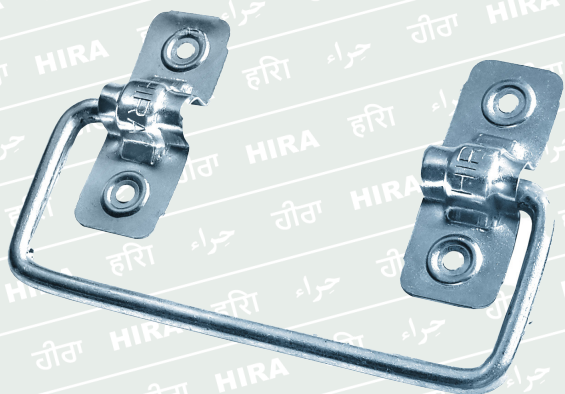

Model Name - No. 3 Wire Handle

Modal	WH3	WH5
Generic Name	No. 3 Handle	No. 5 Handle
length A	110 mm	110 mm
Length B	20 mm	20 mm
Length C	53 mm	53 mm
Material	Mild Steel	Mild Steel
Finish	Zinc	Zinc
Thickness	0.6 mm	0.6 mm
Wire Thickness	6.2 mm	5.2 mm
Weight	60 g	45 g

Spring Folding Handle

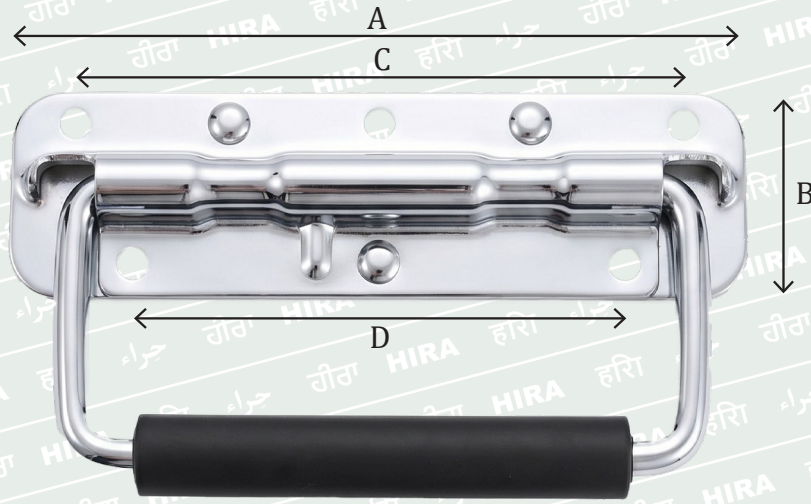

Model No. - SH140



Model No. - SH110

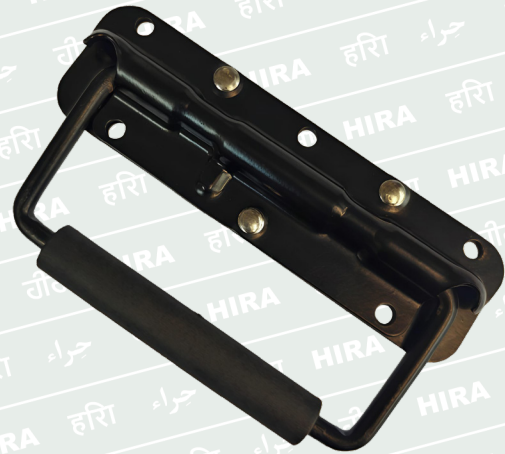

Model No. - SH140B

Modal	SH140	SH140B	SH110
Generic Name	140 mm Spring Handle	140 mm Spring Handle	110 mm Spring Handle
length A	140 mm	140 mm	110 mm
Length B	40 mm	40 mm	40 mm
Length C	115 mm	115 mm	85 mm
Length D	85 mm	92 mm	62 mm
Material	Mild Steel	Mild Steel	Mild Steel
Finish	Chrome Plated	Powder Coated (Black)	Chrome Plated
Thickness	0.9 mm	1.15 mm	0.8 mm
Wire Thickness	6.8 mm	6 mm	6 mm
Weight	185 mm	185 g	120 g

Plate Handle

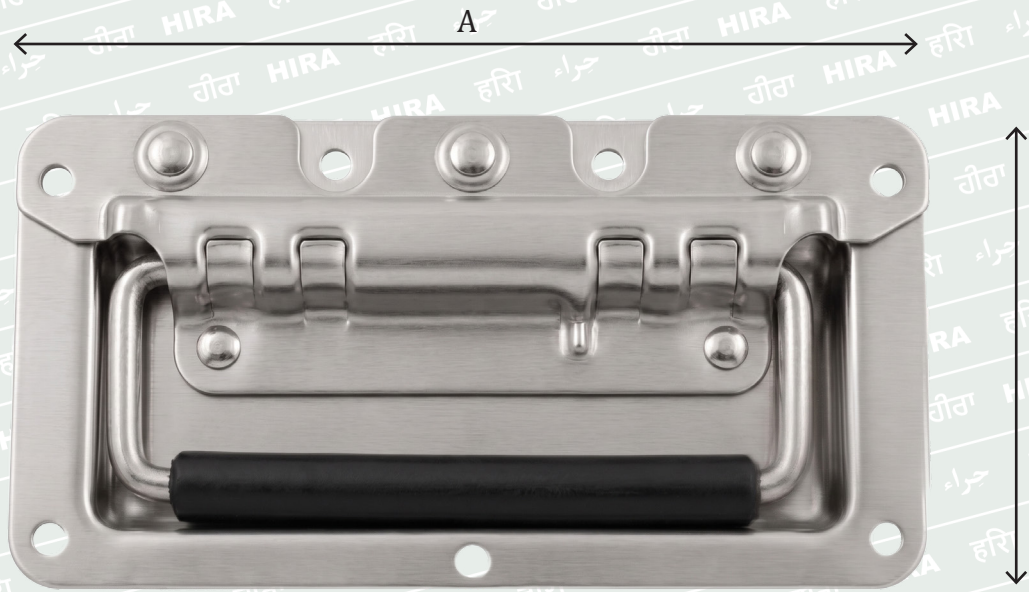

Model No. - SSPH

Modal	SSPH
Generic Name	SS Plate Handle
length A	155 mm
Length B	82 mm
Material	SS 304
Thickness	1.2 mm
Wire Thickness	5.5 mm
Weight	265 g



HIRA[®]



**Hasp and
Staple**

Hasp and Staple

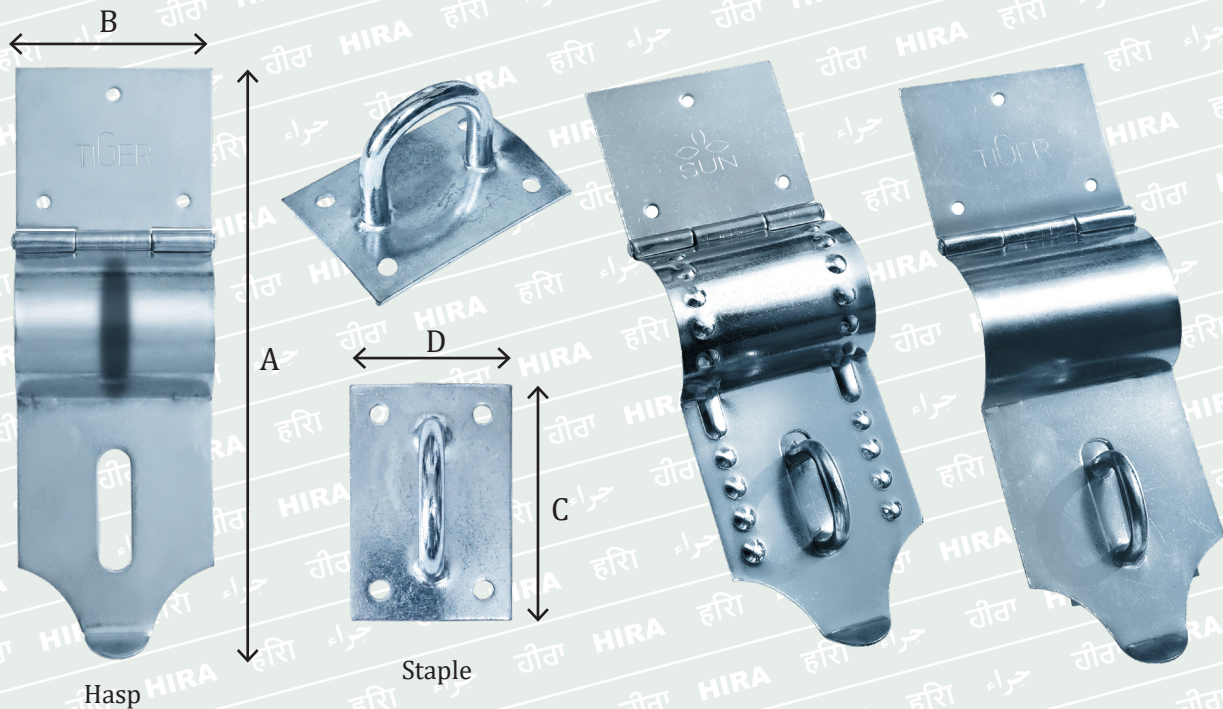

Size	Brand	Hasp			Staple				Weight
		A	B	Thickness	C	D	Thickness	Wire Thickness	
2.5"	Jumbu	175 mm	62 mm	2 mm	50 mm	41 mm	1.15 mm	6.2 mm	228 g
	Bold	175 mm	62 mm	1.5 mm	54 mm	40 mm	0.9 mm	6.2 mm	178 g
	Hira	178 mm	62 mm	1.15 mm	54 mm	40 mm	0.9 mm	6.2 mm	146 g
	Sun*	180 mm	62 mm	0.9 mm	50 mm	35 mm	0.9 mm	5.2 mm	120 g
	Tiger	180 mm	62 mm	0.9 mm	50 mm	35 mm	0.9 mm	5.2 mm	120 g
2"	Bold	180 mm	50 mm	1.5 mm	54 mm	40 mm	0.9 mm	6.2 mm	153 g
	Hira	178 mm	50 mm	1.15 mm	54 mm	40 mm	0.9 mm	6.2 mm	125 g
	Sun*	180 mm	50 mm	0.9 mm	50 mm	40 mm	0.9 mm	5.2 mm	98 g
	Tiger	180 mm	50 mm	0.9 mm	50 mm	40 mm	0.9 mm	5.2 mm	98 g
1.75"	Hira	170 mm	45 mm	0.9 mm	50 mm	40 mm	0.9 mm	5.2 mm	87 g
1.5"	Bold	145 mm	36 mm	1.15 mm	40 mm	29 mm	0.9 mm	4 mm	69 g
	Hira*	145 mm	36 mm	0.9 mm	40 mm	29 mm	0.9 mm	4 mm	57 g
1.25"	Hira*	125 mm	32 mm	0.9 mm	40 mm	29 mm	0.9 mm	4 mm	48 g



Other Fittings



Other Fittings



Koni



Kamani



D-Ring

Modal	KONI	KAMANI	DRING
Generic Name	Koni	Kamani	D-Ring
length A	52 mm	55 mm	25 mm
Length B	11 mm	12 mm	20 mm
Material	Mild Steel	Mild Steel	SS 304
Finish	Zinc	Zinc	
Thickness	0.8 mm	0.9 mm	0.6 mm
Wire Thickness	-	-	3.5 mm
Weight	6 mm	4 g	8 g

Terms & Conditions



- By accessing this website and purchasing products from HIRA (operated under Gulmohar Enterprises, Delhi, India), the user agrees to comply with these terms.
- The catalogue and its content are intended for lawful commercial use only; any unauthorized use, reproduction, or distribution is strictly prohibited.
- All product details, including toggle latches, chest handles, and hardware fittings, are provided as accurately as possible; however, slight variations in size, finish, or appearance may occur due to manufacturing processes.
- Product images are for representation purposes only and may differ slightly from the actual product.
- All prices are listed in INR (₹) and are subject to change without prior notice.
- Orders are confirmed only after acceptance by HIRA and receipt of full or agreed payment. HIRA reserves the right to refuse or cancel any order due to product unavailability, pricing errors, or suspected fraudulent activity.
- Delivery timelines are indicative and may vary depending on location and logistics; HIRA is not responsible for delays caused by third-party courier services.
- Risk of loss or damage to products transfers to the buyer upon dispatch unless otherwise agreed.
- Returns or replacements are accepted only in cases of manufacturing defects or incorrect product delivery, and must be reported within the specified time period after delivery.
- Returned products must be unused and in original packaging; custom or bulk orders may not be eligible for return.
- Any applicable warranty covers manufacturing defects only and does not include damage caused by misuse, improper installation, or normal wear and tear.
- All intellectual property, including the HIRA name, logo, designs, and website content, remains the exclusive property of HIRA and cannot be used without permission.
- HIRA shall not be liable for any indirect, incidental, or consequential damages, including loss of business, profits, or data; liability, if any, shall not exceed the value of the purchased product.
- Separate terms may apply for bulk or B2B transactions and may override these general terms.
- These terms are governed by the laws of India, and any disputes shall fall under the jurisdiction of courts in Delhi.
- HIRA reserves the right to update or modify these terms at any time without prior notice; continued use of the website constitutes acceptance of the revised terms.

For any queries or concerns, users may contact HIRA through the official contact details provided.

For more details:

Gulmohar Enterprises

429, Shahzada Bagh Industrial Area
Inderlok, New Delhi, Delhi - 110035

Contact No. 9891008850, 9810000902(Whatsapp)

Hira Traders

1977, Bazaar Lal Quan, Chawri Bazaar
Delhi - 110006

Contact No. 9891249229

Email. info@hirafittings.com,

Website. hirafittings.com