



# THE LONG LASTING TOOLS



+919872800711  
+919988300711



pinnacleexport@gmail.com  
sales.pinextools@gmail.com  
info@pinextools.com



Pinnacle Exports Private Limited  
Street No. 09, V & Po, Randhawa Masanda  
Jalandhar – 144004 Punjab, India



[www.pinextools.com](http://www.pinextools.com)

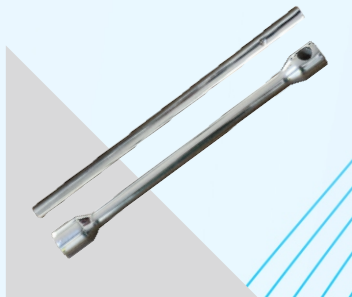
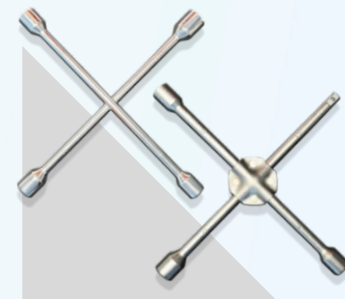

## COMPANY PROFILE

Pinnacle Exports Private Limited is a Government of India-recognized, ISO certified manufacturer & exporter of Automotive Tools, Wrenches, Hand Tools, Spanners and other Industrial Supplies. Established since 1996, our company has managed to acquire immense success under the directorship of Mr. Madhu Sudan Arora (M.D.). Based at a prime location of Punjab, India, we started as an Automotive Tools manufacturer and supplier only. Since the Beginning, our aim was to provide quality solutions for various industrial requirements so the company leaped into manufacturing extensive range of Hand Tools shortly after its establishment.

Our company is currently offering a wide range of tools inclusive of Two-Way Wheel Nut Wrench, Cross Wheel Nut Wrench, Spanners, Angle Sockets Wrench, Forged Spindle, Socket Accessories such as L-Handles, Extension Bar Set, Sliding T-Bars and more. Procuring the highest-grade raw material from trusted vendors, our team of expert's precision design all our products using state of the art equipment and machinery. We follow a quality-focused approach in our practices to notch up the strength, durability, workability, corrosion resistance and robustness of our products at every work station, prior to their delivery.

Packaging, bar-coding & printing is also done as per client's requirements. We have satisfied numerous clients whom we aim to retain with us for longer business terms.

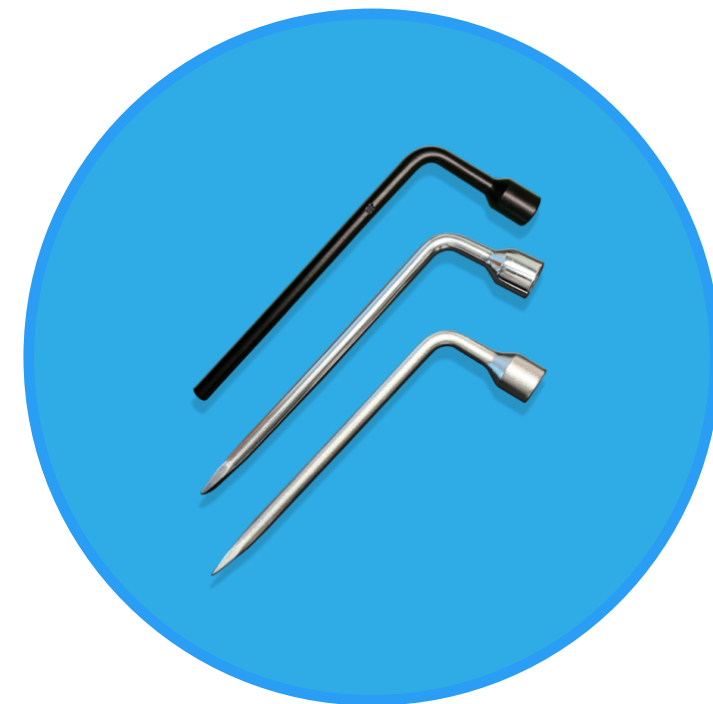

## ANGLED SOCKET WRENCH (BOLT HOLE)

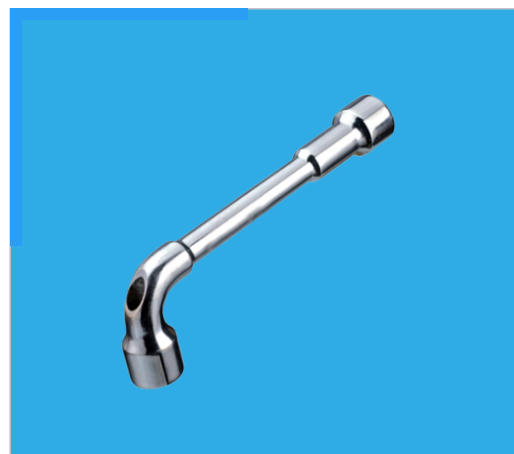

### ISO 691

Hot Forged from Chrome-Vanadium Steel (31 Cr V3), Fully hardened up to HRC 38-42, Angled Wrenches are available in Matt Chrome Plated and Mirror Polish Chrome Plated.

Angled Socket Wrenches are also manufactured in EN 8D grade Carbon Steel. 6 point x 6 point socket with hole to accommodate long, protruding stud bolts.

Size (mm)	Length (mm)	Weight (gm)
6x6	105	65
7x7	110	70
8x8	115	80
9x9	120	85
10x10	130	100
11x11	136	115
12x12	145	150
13x13	152	175
14x14	160	200
15x15	170	230
16x16	178	285
17x17	187	315
18x18	195	365
19x19	205	430
20x20	212	450
21x21	220	490
22x22	230	530
23x23	240	625
24x24	250	660
25x25	260	780
26x26	270	800
27x27	280	950
28x28	290	950
29x29	300	1000
30x30	310	1300
32x32	330	1385
33x33	340	1480
36x36	370	1700
38x38	390	2080

## ANGLED SOCKET WRENCH MILLED HEAD



### DIN ISO 1711-1

Induction Hot Forged from Chrome-Vanadium Steel (31Cr V3), Fully Hardened and Tempered up to HRC 38-42, Milled Head Socket Wrenches are available in Matt Chrome Plated and Mirror Polished Chrome Plated. Socket Wrenches are also manufactured in EN 8D grade carbon steel.

6 point x 12 point socket, 30 increments

Size (mm)	Length (mm)	Weight (gm)
6x6	105	65
7x7	110	70
8x8	115	80
9x9	120	85
10x10	130	100
11x11	136	115
12x12	145	150
13x13	152	175
14x14	160	200
15x15	170	230
16x16	178	285
17x17	187	315
18x18	195	365
19x19	205	430
20x20	212	450
21x21	220	490
22x22	230	530
23x23	240	625
24x24	250	660
25x25	260	780
26x26	270	800
27x27	280	950
28x28	290	950
29x29	300	1000
30x30	310	1300
32x32	330	1385
33x33	340	1480
36x36	370	1700
38x38	390	2080

## FOUR WAY WHEEL NUT WRENCH



### DIN 3119

Induction hot forged from Chrome Vanadium steel (31Cr V3); Fully hardened and tempered up to HRC 38-42. Available in Ni-Cr plated, Matt Chrome plated, Zinc plated and Powder Coated. Lug Nut Wrenches are also available in EN 8D grade carbon steel with Sockets Hardened and Tempered.

Electro Welded for strong joint, Four-way wheel nut wrench is also manufactured with Re-inforced plate for extra strength. Also manufactured with 1/2" square drive and 3/4" square drive sizes, which can fit any socket thus catering to every wheel nut in the market.

Size	Diameter (mm)	Length (inch)	Weight (gm)
17x19x21x22	14	14	1030
17x19x21x23	14	14	1030
17x19x21x1/2" sq	14	14	1020
17x19x22x13/16"	14	14	1030
11/16x3/4x13/16x7/8"	14	14	1030
17x19x21x23	16	14/15	1250/1350
17x19x22x1/2" sq	16	14/15	1250/1300
7/8x15/16x1x1.1/16"	19	25	3000
24x27x32x33	19	25	3100
24x27x32x3/4" sq	22	25	4150

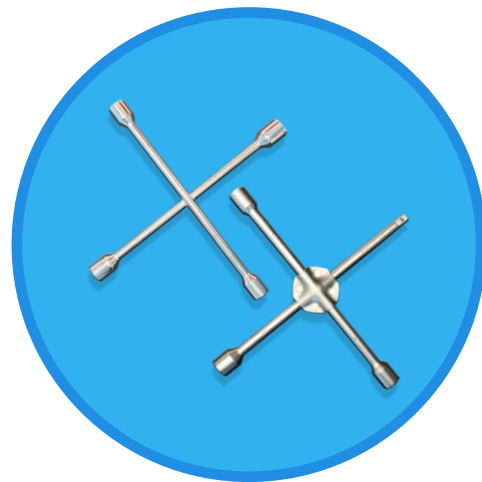

## L SPANNER



Hot forged from EN 8D grade carbon steel, Available in Ni-Cr Plated, Matt Chrome Plated, Satin Finish, Zinc Plated and Powder coated.

L Wrench is also manufactured with Chisel/Tyre Lever on one side. Available in Induction hardened sockets or fully hardened and tempered. Any Specific size may also be manufactured as per customer requirement.

Size (mm)	Diameter (mm)	Length (mm)	Weight (gm)
17	14/16	350	450/550
19	14/16	350	450/550
21	14/16	350	450/550
23	14/16	350	450/550
24	16	350	550
27	16	400	650

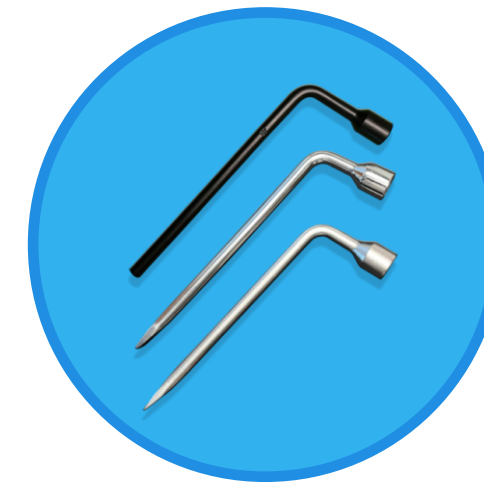

## L SPANNER DOUBLE SOCKET



Hot forged from Chrome Vanadium steel (31Cr V3), These spanners have Tapered sockets on both ends making them useful in narrow space. Available in Polished Chrome Plated or Matt Chrome Plated and Yellow Nickel also.

Full hardened and tempered up to 38-42 HRC. Also available in EN 8D grade carbon steel. Also manufactured in SAE sizes.

Size (mm)	Socket Diameter (mm)	Length (mm)	Height (mm)	Weight (gm)
8 x 8	12.5	210	70	175
9 x 9	15.3	210	70	175
10 x 10	15.3	220	80	200
11 x 11	16.3	220	80	200
12 x 12	18.5	220	80	270
13 x 13	19.5	220	80	280
14 x 14	19.5	220	80	280
15 x 15	22	230	90	410
16 x 16	22	230	90	410
17 x 17	25	230	90	420
18 x 18	25	240	100	480
19 x 19	27	250	100	490

## SOLID TUBULAR WRENCH



### DIN 896 FORM A

Hot Forged from Chrome Vanadium Steel (31Cr V3), Shank profiled for Hexagon Shape, Full hard and tempered up to 38-42 HRC, Head Polished Matt Chrome Plated.

Hexagon shank comes with holes for using both spanner or tommy bar. Hollow centre to accommodate nuts fitted with long stud bolts.

Size (mm)	D 1	D 2	Length (mm)	Weight (gm)
6*7	11	12	105	49
8*9	13	14	110	58
10*11	15.5	16.5	130	90
12*13	17	18	140	125
14*15	20.5	21.5	150	155
16*17	23	24	160	225
18*19	26	27	165	300
20*22	28	30	175	410
22*24	30	32.5	185	450
21*23	29	31	185	450
24*26	32.5	36.5	195	530
24*27	32.5	36.5	195	530
25*28	34	37	205	540
27*29	36	39	205	540
27*30	36	42	205	620
30*32	42	44.5	210	870

## T HANDLE WRENCH



Hot Forged from EN 8D grade carbon steel, Duly Hardened and Tempered. Available In Ni-Cr plated and Zinc Plated. Tommy Bars have ball catchers on both ends providing maximum leverage.

Size (mm)	Socket Diameter (mm)	Length (mm)	Height (mm)	Weight (gm)
8 x 8	12.5	210	70	175
9 x 9	15.3	210	70	175
10 x 10	15.3	220	80	200
11 x 11	16.3	220	80	200
12 x 12	18.5	220	80	270
13 x 13	19.5	220	80	280
14 x 14	19.5	220	80	280
15 x 15	22	230	90	410
16 x 16	22	230	90	410
17 x 17	25	230	90	420
18 x 18	25	240	100	480
19 x 19	27	250	100	490

## TUBULAR BOX WRENCH



**DIN 896 form B**  
**ISO 2236**

Manufactured from ERW Tube, Case hardened, Available in Ni-Cr Plated or Zinc Plated. Hexagon openings with Flared end.

Size	Length (mm)	Weight (gm)
6*7	110	40
8*9	110	47
8*10	110	50
10*11	120	80
10*12	120	80
12*13	140	100
14*15	140	105
16*17	150	125
17*19	160	185
18*19	160	185
20*22	170	225
21*23	170	225
24*27	190	340
25*28	190	340
30*32	210	400

## TWO WAY WHEEL NUT WRENCH



### Torque as per DIN 899

Hot Forged from Chrome Vanadium steel (31Cr V3), Fully Hardened and Tempered. Surface Finishing available are Ni-Cr plated, Matt Chrome plated, Zinc plated, Powder Coated and Phosphate Coated.

Also manufactured from EN 8D grade carbon steel, Socket Hardened and Tempered.

To order: With or without Tommy bar

Standard Size: Diameter 26mm, Length 400mm

Size	Size (SAE)	Weight (gm)
19 x 22	-	2100
22 x 24	-	2100
24 x 26	-	2100
24 x 27	15/16 x 1.1/16	2150
27 x 27	1.1/16 x 1.1/16	2150
27 x 30	1.1/16 x 1.3/16	2150
27 x 32	1.1/16 x 1.1/4	2200
27 x 33	1.1/16 x 1.5/16	2200
30 x 30	1.3/16 x 1.3/16	2200
30 x 32	1.3/16 x 1.1/4	2200
30 x 33	1.3/16 x 1.5/16	2200
32 x 32	1.1/4 x 1.1/4	2200
32 x 33	1.1/4 x 1.5/16	2200
33 x 33	1.5/16 x 1.5/16	2200
17 sq x 35 hex	-	2200
19 sq x 41 hex	-	2250
20 sq x 38 hex	-	2250
21 sq x 38 hex	-	2250
21 sq x 41 hex	-	2250

## TYRE LEVER



Hot Forged from selected Carbon steel, Precision Hardened and Tempered, Available in Zinc Plated and Chrome Plated.

Size	SAE	Metric
	12	300
	18	450
	24	600
	30	750

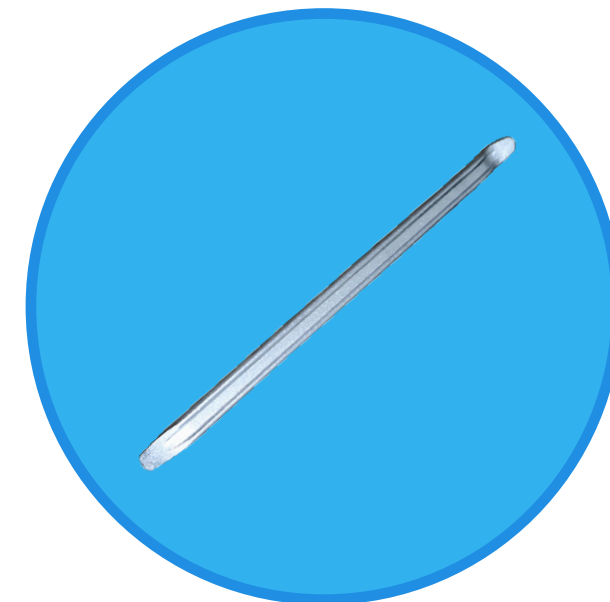

## COMBINATION SPANNER



### DIN 3113A

Drop forged from Chrome Vanadium steel (31Cr V3), Fully Hardened and Tempered, Available in Mirror Polished Chrome Plated and Satin Finish.

Size		Length (mm)	Weight (gm)
Metric	SAE		
6	1/4	100	18
7	-	110	22
8	5/6	120	26
9	-	130	30
10	3/8	140	42
11	7/16	150	52
12	-	160	60
13	1/2	170	72
14	9/16	180	86
15	-	190	92
16	5/8	200	109
17	11/16	210	132
18	-	220	152
19	3/4	230	160
20	-	240	182
21	13/16	250	192
22	7/8	260	210
23	-	270	250
24	15/16	280	260
25	1	290	300
26	-	300	320
27	1.1/16	310	390
28	1.1/8	320	435
29	-	330	435
30	-	340	460
32	1.1/4	360	560

## COMBINATION SPANNER

Sets	Size (mm)	Length (mm)	
Set of 5	8,10,12,14,17	346	-
Set of 6	8,10,12,13,14,17	418	-
Set of 8	8,9,10,11,13,14,17,19	600	-
Set of 12	6-14,17,19,22	910	-
Set of 25	6-28,30,32	4612	-
Set of 26	6-30,32	5047	-



## DOUBLE OPEN END SPANNER



### DIN 3110

Drop forged from Chrome Vanadium steel (31Cr V3), Fully Hardened and Tempered, Available in Mirror Polished Chrome Plated and Satin Finish.

Size	Length (mm)	Weight (gm)
6×7	122	24
8×9	140	32
10×11	155	55
12×13	171	76
14×15	190	112
16×17	204	130
18×19	220	165
20×22	235	210
21×23	248	240
24×26	267	315
24×27	267	315
25×28	280	360
30×32	301	485

Sets	Size (mm)	Weight (gm)
Set of 6	6×7, 8×9, 10×11, 12×13, 14×15, 16×17	429
Set of 8	6×7, 8×9, 10×11, 12×13, 14×15, 16×17, 18×19, 20×22	804
Set of 12	6×7, 8×9, 10×11, 12×13, 14×15, 16×17, 18×19, 20×22, 21×23, 24×27, 25×28, 30×32	2204

## DOUBLE RING SPANNER



### DIN 838

Ring Spanner Elliptical Pattern. Drop forged from Chrome Vanadium steel (31Cr V3). Hardened and Tempered. Available in Chrome Plated Mirror Finish and Satin Finish

Size	Length (mm)	Weight (gm)
6×7	183	50
8×9	192	70
10×11	202	92
12×13	217	125
14×15	233	150
16×17	251	170
18×19	268	210
20×22	296	305
21×23	322	325
24×27	330	395
25×28	345	425
30×32	370	560

Sets	Size (mm)	Weight (gm)
Set of 6	6 x 7, 8 x 9, 10 x 11, 12 x 13, 14 x 15, 16 x 17	655
Set of 8	6 x 7, 8 x 9, 10 x 11, 12 x 13, 14 x 15, 16 x 17, 18 x 19, 20 x 22	1170
Set of 12	6 x 7, 8 x 9, 10 x 11, 12 x 13, 14 x 15, 16 x 17, 18 x 19, 20 x 22, 21 x 23, 24 x 27, 25 x 28, 30 x 32	2875
-	-	-

## SOCKET



### 3/4" Drive

Hot forged from Chrome Vanadium Alloy Steel (31 Cr V3), Fully Hardened and Tempered, Mirror Polish Chrome Plated finish. Manufactured in both 6-point and 12-point sockets. Available in all Metric sizes.

Size (mm)	D1 (mm)	D2 (mm)	Length (mm)
17	26	32.7	51
19	30	32.7	51
21	32	32.7	51
22	33	35.7	51
23	34	35.7	51
24	35	35.7	51
26	36	36	52
27	38	36	52
28	39	36	52
29	40	38	52
30	42	38	54
32	44	38	56
33	46	39	56
34	47	42	57
35	48	42	58
36	50	42	58
38	52	45	60
41	56	45	64
42	57	45	64
46	62	48	68
48	64	48	70
50	68	48	72

## EXTENSION BARS



### EXTENSION BARS

Hot forged from Chrome Vanadium Steel (31Cr V3), Full Hard and Tempered up to 38-42 HRC. Also manufactured with Flange drive socket design, providing optimum torque and greater service life of nuts and bolts.

Available in Mirror Polished Chrome Plated and Matt Chrome Plated. Manufactured in different lengths for accessing nuts fitted in tight spaces.

Drive Size	Length (mm)	Weight (gm)
1/2"	75	120
1/2"	125	200
1/2"	200	320
1/2"	250	400
1/2"	300	480
1/2"	400	640
3/4"	200	600
3/4"	400	1250
1"	300	1350

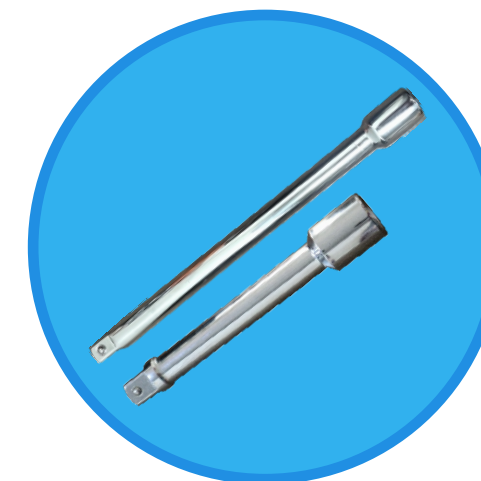

## EXTENSION BARS EXTRA LONG



Hot forged from Chrome Vanadium Steel (31Cr V3), Full Hard and Tempered up to 38-42 HRC. Available in Ni-Cr Plated. Also manufactured with Flange drive socket design, providing optimum torque and greater service life of nuts and bolts. Manufactured with Knurled Shank, can reach inaccessible nuts with great ease.

Size (mm)	Length	Weight (gm)
3/8"	450mm / 18"	460
3/8"	600mm / 24"	620
3/8"	750mm / 30"	780
1/2"	450mm / 18"	720
1/2"	600mm / 24"	960
1/2"	750mm / 30"	1200



## L HANDLE



Manufactured from Chrome Vanadium Steel (31Cr V3), Fully hardened and tempered up to 38-42 HRC. These Wrenches come with either 1/2" square drive on both sides or 3/4" drive which fit all the socket sizes.

Available in Mirror Polished Chrome Plated, Satin Finish. Also available in EN 8D grade Carbon steel.

Drive Size (mm)	Diameter (mm)	Length (mm)	Bend (mm)	Weight (gm)
1/2"	16	250	50	450
1/2"	16	250	100	550
1/2"	16	300	100	600
1/2"	18	300	50	650
1/2"	19	450	100	1150
3/4"	22	450	100	1650
3/4"	26	400	100	2000
1"	26	400	100	2200

Any specific size can also be manufactured as per customer's specification.



## SLIDING T BAR



Manufactured from Chrome vanadium Steel (31Cr V3), Fully hardened and tempered up to 38-42 HRC. Available in Ni-Cr plated. The sliding bars have ball catchers on both ends preventing sockets to fall out while providing maximum leverage.

Drive Size	Bar Diameter (mm)	Length (mm)	Weight (gm)
1/2"	16	300	425
3/4"	20	500	1500



## CERTIFICATE

*Certificate of Registration*

This is to Certify that  
Quality Management System of

**M/S PINNACLE EXPORTS PVT. LTD.**  
STREET NO. 09, VILLAGE RANDHAWA MASANDA,  
JALANDHAR -144004, PUNJAB, INDIA.

has been assessed and found to conform to the requirements of  
**ISO 9001:2015**  
for the following scope :

MANUFACTURERS AND EXPORTERS OF DROP FORGED HIGH PRESSURE STEEL PIPE  
FITTINGS, SS FITTINGS, SPANNERS, WRENCHES, HAND TOOLS AND HOT FORGED  
COMPONENTS.

Certificate No : 23EQL087  
Initial Registration Date : 09/06/2023 Issuance Date : 09/06/2023  
Date of Expiry : 08/06/2026  
1st Surve. Due : 09/05/2024 2nd Surve. Due : 09/05/2025

**Director**

**Magnitude Management Services Pvt. Ltd.**  
Third Floor, A-60, Sector-2, Noida, Gautam Budh Nagar, U.P.-201301, India  
e-mail: [info@mmscertification.com](mailto:info@mmscertification.com), website: [www.mmscertification.com](http://www.mmscertification.com)

\* Subject to Successful Surveillance Audit and case surveillance audit is not allowed to be conducted, this certificate shall be suspended/withdrawn.  
Certificate Verification: Please Re-check the validity of certificate at <http://www.mmscertification.com> or [www.mmscertification.com](https://www.mmscertification.com) at Active Clients.  
Certificate is the property of Magnitude Management Services Pvt. Ltd. and shall be returned immediately when demanded.



- Due to continuous development work, design and specifications are subject to alteration without notice.
- Weights and dimensions given in this Catalogue are for guideline only. There may be a little variation in actual weights and dimensions.